



AMERICAN FORGE & FOUNDRY™



**Professional Products.
Professional Results.**



AMERICAN FORGE & FOUNDRY™

PROFESSIONAL PRODUCTS. PROFESSIONAL RESULTS.

Established in 1963 American Forge & Foundry has built a long standing tradition of providing quality products, same day shipping, exceptional service, and value.

Available through our network of distributor partners AFF products can be found in the heavy duty market, automotive and tire repair shops, military sectors, agriculture, and other demanding industries. We are proud to be continually expanding our product portfolio to meet and exceed the demands of the professional end user.

From our extensive inventory of parts to the hundreds of service depots available nationwide our experienced team is committed to ensuring that the AFF brand stands for durability, safety, and customer care. The AFF Total Value Commitment is the foundation of our past and our future.

Thank you again for your business and as always...work safe!

American Forge & Foundry has made every effort to provide accurate and up-to-date features, specifications and photos of our products for your information. American Forge & Foundry reserves the right to make changes in design, appearance and construction of any and all products listed herein without incurring any obligation in making such changes in products previously sold or transferred. We reserve the right to discontinue the availability of any products at such time we deem necessary.



Category	Product Example	Pages	Category	Product Example	Pages
Floor Jacks		4-9	Wheel Dollies		31
Axle Jacks		10-11	Safety Stands		32-34
Bottle Jacks		12-13	Material Handling		35-37
Long Chassis Jacks		14-15	Air Tools		38-43
Transmission Jacks		16-19	Hand Tools and Accessories		44-51
Specialty Jacks		20-23	Shop Presses		52-55
Air Lifts		24-25	Shop Equipment		56-61
Power Rams		26-27	Lubrication		62-72
Engine Cranes and Stands		28-30	Merchandising		73-84

American Forge & Foundry's line of Floor Jacks are heavy duty and designed to meet the demanding needs of the professional service technician. Features include heavy gauge steel, double pumper technology for maximum speed, universal joint technology, UV powder coat paint, and an overload valve for added safety. Each conform to current PALD standards. See if you agree that these are the strongest and most durable floor jacks in the industry.

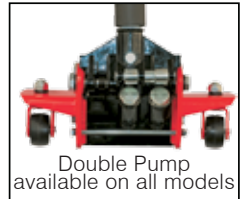

2 TON LOW PROFILE FLOOR JACK

MODEL 200T

- Super low pickup height of 2-3/4" offers ideal access to custom vehicles
- Twin hydraulic system maximizes speed and provides additional strength
- Universal joint technology and precision release valve offers a more controlled release
- Tough UV powder coated frame for greater protection and durability
- Pinned steel saddle with rubber pad for added vehicle protection
- One piece foam covered 50" handle.
- Constructed with safety valve to prevent overloading

MODEL	CAPACITY (Tons)	LOW HEIGHT	HIGH HEIGHT	CHASSIS LENGTH	OVERALL WIDTH (front)	OVERALL WIDTH (rear)	SHIP WEIGHT
200T	2	2.75"	20"	27"	11.75"	15"	99 lbs



2 TON LOW PROFILE FLOOR JACK - 2 PC HANDLE

MODEL 202T

- Super low pickup height of 2-3/4" offers ideal access to custom vehicles
- Twin hydraulic system maximizes speed and provides additional strength
- Universal joint technology and precision release valve offers a more controlled release
- Tough UV powder coated frame for greater protection and durability
- Pinned steel saddle with rubber pad for added vehicle protection
- Two piece foam covered 50" handle for easy portability and storage
- Constructed with safety valve to prevent overloading



NEW PRODUCT!

MODEL	CAPACITY (Tons)	LOW HEIGHT	HIGH HEIGHT	CHASSIS LENGTH	OVERALL WIDTH (front)	OVERALL WIDTH (rear)	SHIP WEIGHT
202T	2	2.75"	20"	27"	11.75"	15"	99 lbs



2.5 TON PROFESSIONAL HEAVY DUTY FLOOR JACK

MODEL 320SS

- Twin hydraulic system maximizes speed and provides additional strength
- Universal joint technology and precision release valve offers a more controlled release
- Tough UV powder coated frame for greater protection and durability
- Pinned steel saddle with rubber pad for added vehicle protection
- One piece foam covered 50" handle
- Features safety valve to prevent overloading

NEW PRODUCT!

MODEL	CAPACITY (Tons)	LOW HEIGHT	HIGH HEIGHT	CHASSIS LENGTH	OVERALL WIDTH (front)	OVERALL WIDTH (rear)	SHIP WEIGHT
320SS	2.5	5"	21"	28.5"	9"	13.5"	101 lbs



2.5 TON PROFESSIONAL HEAVY DUTY FLOOR JACK - 2 PC HANDLE

MODEL 322SS

- Twin hydraulic system maximizes speed and provides additional strength
- Universal joint technology and precision release valve offers a more controlled release
- Tough UV powder coated frame for greater protection and durability
- Pinned steel saddle with rubber pad for added vehicle protection
- Two piece foam covered 50" handle for easy portability and storage
- Features safety valve to prevent overloading



NEW PRODUCT!

MODEL	CAPACITY (Tons)	LOW HEIGHT	HIGH HEIGHT	CHASSIS LENGTH	OVERALL WIDTH (front)	OVERALL WIDTH (rear)	SHIP WEIGHT
322SS	2.5	5"	21"	28.5"	9"	13.5"	106 lbs

3 TON PROFESSIONAL HEAVY DUTY FLOOR JACK

MODEL 300T

- Low pick up height of 3.75"
- Twin hydraulic system maximizes speed and provides additional strength
- Universal joint technology and precision release valve offers a more controlled release
- Tough UV powder coated frame for greater protection and durability
- Pinned steel saddle with rubber pad for added vehicle protection
- One piece foam covered 50" handle
- Plungers use a U Cup design for more efficient seal
- Constructed with safety valve to prevent overloading



MODEL	CAPACITY (Tons)	LOW HEIGHT	HIGH HEIGHT	CHASSIS LENGTH	OVERALL WIDTH (front)	OVERALL WIDTH (rear)	SHIP WEIGHT
300T	3	3.75"	21.5"	30.75"	11.38"	14.5"	104 lbs

3 TON PROFESSIONAL HEAVY DUTY FLOOR JACK - 2 PC HANDLE

MODEL 302T

- Low pick up height of 3.75"
- Twin hydraulic system maximizes speed and provides additional strength
- Universal joint technology and precision release valve offers a more controlled release
- Tough UV powder coated frame for greater protection and durability
- Pinned steel saddle with rubber pad for added vehicle protection
- Two piece foam covered 50" handle for easy portability and storage
- Plungers use a U Cup design for more efficient seal
- Constructed with safety valve to prevent overloading



NEW PRODUCT!

MODEL	CAPACITY (Tons)	LOW HEIGHT	HIGH HEIGHT	CHASSIS LENGTH	OVERALL WIDTH (front)	OVERALL WIDTH (rear)	SHIP WEIGHT
302T	3	3.75"	21.5"	30.75"	11.38"	14.5"	109 lbs

3.5 TON PROFESSIONAL HEAVY DUTY FLOOR JACK

MODEL 350SS

- Twin hydraulic system maximizes speed and provides additional strength
- Universal joint technology and precision release valve offers a more controlled release
- Tough UV powder coated frame for greater protection and durability
- Pinned steel saddle with rubber pad for added vehicle protection
- Rear mounted 2.75" swivel casters for ease of maneuverability
- One piece foam covered 50" handle
- Features safety valve to prevent overloading



MODEL	CAPACITY (Tons)	LOW HEIGHT	HIGH HEIGHT	CHASSIS LENGTH	OVERALL WIDTH (front)	OVERALL WIDTH (rear)	SHIP WEIGHT
350SS	3-1/2	4"	19.5"	29"	11.25"	15"	119 lbs

3.5 TON PROFESSIONAL HEAVY DUTY FLOOR JACK - 2 PC HANDLE

MODEL 352SS

- Twin hydraulic system maximizes speed and provides additional strength
- Universal joint technology and precision release valve offers a more controlled release
- Tough UV powder coated frame for greater protection and durability
- Pinned steel saddle with rubber pad for added vehicle protection
- Rear mounted 2.75" swivel casters for ease of maneuverability
- Two piece foam covered 50" handle for easy portability and storage
- Features safety valve to prevent overloading



MODEL	CAPACITY (Tons)	LOW HEIGHT	HIGH HEIGHT	CHASSIS LENGTH	OVERALL WIDTH (front)	OVERALL WIDTH (rear)	SHIP WEIGHT
352SS	3-1/2	4"	19.5"	29"	11.25"	15"	124 lbs

NEW PRODUCT!



1.5 TON WRECKER SERVICE JACK

MODEL 206

- Lightweight anodized aluminum frame
- Polished plunger pistons provide a smooth surface for longer seal life
- Wiper seals prevent dirt from entering hydraulic system
- Twin hydraulic system for faster and easier lifts
- Additional machining to ensure the tightest tolerances
- Front roller and a single side handle for easy portability
- Padded 2 pc handle



MODEL	CAPACITY (Tons)	LOW HEIGHT	HIGH HEIGHT	CHASSIS LENGTH	OVERALL WIDTH (front)	OVERALL WIDTH (rear)	SHIP WEIGHT
206	1.5	3.25"	15"	20"	6"	10"	30 lbs

2 TON WRECKER SERVICE JACK

MODEL 208

- Lightweight anodized aluminum frame
- Polished plunger pistons provide a smooth surface for longer seal life
- Wiper seals prevent dirt from entering hydraulic system
- Twin hydraulic system for faster and easier lifts
- Additional machining to ensure the tightest tolerances
- Two side handles for easy portability
- Padded 2 pc handle



MODEL	CAPACITY (Tons)	LOW HEIGHT	HIGH HEIGHT	CHASSIS LENGTH	OVERALL WIDTH (front)	OVERALL WIDTH (rear)	SHIP WEIGHT
208	2	3.5"	18.5"	24.5"	10.75"	11.5"	47 lbs

3 TON WRECKER SERVICE JACK

MODEL 210

- Lightweight anodized aluminum frame
- Polished plunger pistons provide a smooth surface for longer seal life
- Wiper seals prevent dirt from entering hydraulic system
- Twin hydraulic system for faster and easier lifts
- Additional machining to ensure the tightest tolerances
- Two side handles for easy portability
- Padded 2 pc handle



MODEL	CAPACITY (Tons)	LOW HEIGHT	HIGH HEIGHT	CHASSIS LENGTH	OVERALL WIDTH (front)	OVERALL WIDTH (rear)	SHIP WEIGHT
210	3	3.75"	19.5"	26"	11.5"	13.5"	58 lbs

Floor Jack Accessories

750 LB. CAPACITY TRANSMISSION ADAPTER HEAD

MODEL 3165

Converts any AFF or Viking floor jack to remove and install automobile transmissions, transfer cases and differentials.

- Saddle is 19.5" wide
- 30° front tilt and 15° back tilt.
- Ship weight 28 lbs.



CROSSBEAM ADAPTER

MODEL 3167

Use any AFF or Viking floor jacks with a 1/1-8" diameter saddle stud to lift the entire front or rear of a vehicle.

- 4,400 lb. capacity
- Two telescopic 4.75" x 4.75" rubber saddle pads for added vehicle protection easily adjust to a maximum 38" width
- Ship weight 31 lbs.



Adapters work on all AFF jacks except 300T

FLOOR JACK HANDLE

MODEL 390

- Protects vehicle from dings and scrapes
- Made of solvent resistant high impact plastic
- Air filled end cap provides additional protection
- Inexpensive insurance for car finishes.
- Works on many other shop tools such as bead breakers and press handles
- Ship weight 1lb.



Floor Jack Replacement Parts

REPLACEMENT SADDLE PAD

MODEL 200TK42

- Fits Models 200T & 202T
- Saddle diameter 5-3/8"
- Ship weight 1 lb



REPLACEMENT SADDLE PAD

MODEL 350GTK41

- Fits all AFF Model 350 series floor jacks
- Saddle diameter 5-1/2"
- Ship weight 1 lb



REPLACEMENT FOAM HANDLE COVER

MODEL 350GTK23

- Fits all AFF Model 350 series floor jacks
- Ship weight 7 lbs

REPLACEMENT FOAM HANDLE COVER

MODEL 200TK40

- Fits all AFF Model 200T Floor Jack
- Ship weight 7 lbs

ONE PIECE HANDLE

MODEL 350SSK24

- Fits Models 200T, 300T, and 350SS
- Ship weight 8 lbs

TWO PIECE HANDLE

MODEL 352SSK24

- Fits Models 202T, 302T, and 352SS
- Ship weight 8 lbs



American Forge & Foundry's Axle Jacks are engineered to withstand the extreme conditions of all heavy duty applications including roadside service, fleet maintenance, agriculture, military sectors, and much more.

22 TON SINGLE STAGE AIR/HYDRAULIC AXLE JACK

MODEL 565E (2 pc. handle) MODEL 565E1 (1 pc. handle)

- Pump, ram, and cylinders are precision machined and inspected to ensure long service life and superior performance
- Corrosion resistant aluminum and nylon composite air motor
- Unique motor design advances ram to load faster for quick and more efficient operation
- Air assisted lowering and dual return springs provide controlled and easy descent
- Large 7-3/4" rear wheels for easy positioning and smooth motion
- Includes 3 heat treated extensions (3/4", 2-3/4", and 4") for a wide range of lifting options
- Safety overload system prevents jack from being used beyond its rated capacity
- Operates at 90-180 PSI



3 pc. adapter kit included as standard accessory

ONE-PIECE "T" HANDLE

MODEL 565E-HANDLE

This kit is for those who want to replace the 2-piece handle on their 565E 22-ton axle jack
Ship weight 14 lbs.

MODEL	CAPACITY (Tons)	RAM LIFT	LOW HEIGHT	HIGH HEIGHT	REACH	WIDTH	SHIP WEIGHT
565E	22	4.75"	8.75"	21.5"	61"	13"	107 lbs
565E1	22	4.75"	8.75"	21.5"	61"	13"	107 lbs

35 TON AIR/HYDRAULIC AXLE JACK

MODEL 535A

- Ideal for lifting trucks, buses, trailers, and other heavy duty equipment
- Can be operated with air (90-180 PSI) or manually
- Heat treated pistons for maximum strength
- Heavy duty steel saddle for secure lifts
- 55" length for easy access to hard to reach lift points
- Convenient carrying handle for easier transportation
- Safety overload system prevents jack from being used beyond its rated capacity



MODEL	CAPACITY (Tons)	RAM LIFT	LOW HEIGHT	HIGH HEIGHT	REACH	WIDTH	SHIP WEIGHT
535A	35	5.75"	11"	21.25"	55"	9"	101 lbs



35 TON SINGLE STAGE AIR/HYDRAULIC AXLE JACK

MODEL 536

- Pump, ram, and cylinders are precision machined and inspected to ensure long service life and superior performance
- Corrosion resistant aluminum and nylon composite air motor
- Unique motor design advances ram to load faster for quick and more efficient operation
- Air assisted lowering and dual return springs provide controlled and easy descent
- Large 8-5/8" rear wheels for easy positioning and smooth motion
- Includes 3 heat treated extensions (3/4", 2-3/4", and 4") for a wide range of lifting options
- Safety overload system prevents jack from being used beyond its rated capacity
- Includes 2 pc handle
- Operates at 90-180 PSI



MODEL	CAPACITY (Tons)	RAM LIFT	LOW HEIGHT	HIGH HEIGHT	REACH	WIDTH	SHIP WEIGHT
536	35	4.5"	10.625"	23"	58"	12.5"	110 lbs

50 TON SINGLE STAGE AIR/HYDRAULIC AXLE JACK

MODEL 551

- Pump, ram, and cylinders are precision machined and inspected to ensure long service life and superior performance
- Corrosion resistant aluminum and nylon composite air motor
- Unique motor design advances ram to load faster for quick and more efficient operation
- Air assisted lowering and dual return springs provide controlled and easy descent
- Large 8-5/8" rear wheels for easy positioning and smooth motion
- Includes 3 heat treated extensions (3/4", 2-3/4", and 4") for a wide range of lifting options
- Safety overload system prevents jack from being used beyond its rated capacity
- Includes 1 pc handle
- Operates at 90-180 PSI



MODEL	CAPACITY (Tons)	RAM LIFT	LOW HEIGHT	HIGH HEIGHT	REACH	WIDTH	SHIP WEIGHT
551	50	5.75"	12.375"	26.5"	65"	14.5"	158 lbs



American Forge & Foundry's Super Duty Air/Hydraulic Bottle Jacks include some of the most advanced features available today and offer ideal solutions for real world applications. Each is constructed with a welded tank and frame for superior strength and durability while the thick steel base provides the most stable lifting platform even on the poorest of surfaces. The specially designed air motor is tested under the most stringent guidelines to ensure long shop life and consistent operation.

1-1/8" Base Thickness



12 TON CAPACITY SUPER DUTY AIR/HYDRAULIC BOTTLE JACK

MODEL 5612SD

- Welded tank and frame for superior strength
- Thick base design provides the most stable lifting platform
- Dual return springs help provide controlled and easy descent
- Shielded release screw prevents accidental lowering
- Specially engineered air motor for consistent and reliable operation

NEW PRODUCT!

Low Ht: 9.92"
 High Ht: 18.98"
 Lift: 5.91"
 Base: 8.27"x5.31"
 Air Pressure: 110-120 PSI
 Air Inlet Fitting: 1/4" NPT
 Ship Wt: 35 lbs.



20 TON CAPACITY SUPER DUTY AIR/HYDRAULIC BOTTLE JACK

MODEL 5620SD

- Welded tank and frame for superior strength
- Thick base design provides the most stable lifting platform
- Dual return springs help provide controlled and easy descent
- Shielded release screw prevents accidental lowering
- Specially engineered air motor for consistent and reliable operation

Low Ht: 10.37"
 High Ht: 20.63"
 Lift: 6.38"
 Base: 5.75"x9.00"
 Air Pressure: 110-120 PSI
 Air Inlet Fitting: 1/4" NPT
 Ship Wt: 45 lbs.



20 TON CAPACITY SUPER DUTY LOW PROFILE AIR/HYDRAULIC BOTTLE JACK

MODEL 5621SD

- Welded tank and frame for superior strength
- Thick base design provides the most stable lifting platform
- Dual return springs help provide controlled and easy descent
- Shielded release screw prevents accidental lowering
- Specially engineered air motor for consistent and reliable operation

Low Ht: 7.01"
 High Ht: 12.76"
 Lift: 3.35"
 Base: 5.70"x8.27"
 Air Pressure: 110-120 PSI
 Air Inlet Fitting: 1/4" NPT
 Ship Wt: 36 lbs.



NEW PRODUCT!

30 TON CAPACITY SUPER DUTY AIR/HYDRAULIC BOTTLE JACK

MODEL 5630SD

- Welded tank and frame for superior strength
- Thick base design provides the most stable lifting platform
- Dual return springs help provide controlled and easy descent
- Shielded release screw prevents accidental lowering
- Specially engineered air motor for consistent and reliable operation

Low Ht: 10.94"
 High Ht: 20.59"
 Lift: 5.91"
 Base: 9.65"x7.09"
 Air Pressure: 110-120 PSI
 Air Inlet Fitting: 1/4" NPT
 Ship Wt: 65 lbs.



NEW PRODUCT!



MODEL 5512B



Capacity: 12 Tons
Low Ht: 10.25"
High Ht: 19.75"
Lift: 6.75"
Screw Ext: 3"
Base: 8.5" x 5"
Ship Wt: 30 lbs.

Air/Hydraulic

MODEL 5520B



Capacity: 20 Tons
Low Ht: 10.5"
High Ht: 20"
Lift: 6.25"
Screw Ext: 3.25"
Base: 9.5" x 6.5"
Ship Wt: 38 lbs.

Air/Hydraulic

MODEL 3502



Capacity: 2 Tons
Low Ht: 6-1/4"
High Ht: 12-3/4"
Lift: 4"
Screw Ext: 2-1/2"
Base: 3-3/4" x 3-3/4"
Qty per Case: 6
Case Wt: 36 lbs.

MODEL 3504



Capacity: 4 Tons
Low Ht: 6-1/2"
High Ht: 13-1/4"
Lift: 4-1/4"
Screw Ext: 2-1/2"
Base: 4-1/2" x 4"
Qty per Case: 6
Case Wt: 52 lbs.

MODEL 3506



Capacity: 6 Tons
Low Ht: 8"
High Ht: 16"
Lift: 5-1/4"
Screw Ext: 2-3/4"
Base: 4-1/2" x 4-3/4"
Qty per Case: 4
Case Wt: 44 lbs.

MODEL 3506C
Model 3506 with blow
molded carrying case

MODEL 3508



Capacity: 8 Tons
Low Ht: 7-3/4"
High Ht: 15-1/2"
Lift: 5"
Screw Ext: 2-3/4"
Base: 4-3/4" x 5"
Qty per Case: 4
Case Wt: 52 lbs.

MODEL 3512



Capacity: 12 Tons
Low Ht: 8-1/2"
High Ht: 17"
Lift: 5-3/4"
Screw Ext: 2-3/4"
Base: 5-1/2" x 5-1/4"
Qty per Case: 4
Case Wt: 68 lbs.

MODEL 3514



Capacity: 12 Tons
Low Ht: 7"
High Ht: 13"
Lift: 4"
Screw Ext: 2"
Base: 5-1/2" x 5-1/4"
Qty per Case: 4
Case Wt: 60 lbs.

MODEL 3520



Capacity: 20 Tons
Low Ht: 9-5/8"
High Ht: 18-1/4"
Lift: 6-3/8"
Screw Ext: 2-1/4"
Base: 6-3/4" x 6-1/4"
Qty per Case: 2
Case Wt: 54 lbs.

MODEL 3522



Capacity: 20 Tons
Low Ht: 7-3/4"
High Ht: 14-1/4"
Lift: 4-1/4"
Screw Ext: 2-1/4"
Base: 6-3/4" x 6-1/4"
Qty per Case: 2
Case Wt: 50 lbs.

MODEL 3530



Capacity: 30 Tons
Low Ht: 11"
High Ht: 18-5/8"
Lift: 7-5/8"
Screw Ext: --
Base: 7" x 7"
Qty per Case: 2
Case Wt: 88 lbs.

MODEL 3550



Capacity: 50 Tons
Low Ht: 12"
High Ht: 19"
Lift: 7"
Screw Ext: --
Base: 8-1/2" x 7"
Qty per Case: 1
Case Wt: 73 lbs.



American Forge & Foundry's Long Chassis Service Jacks are designed for heavy lift applications where added reach and access is also necessary. Applications include bus and truck fleets, agriculture, industrial, military bases, and job sites. All air assisted service jacks can be operated manually when shop air is not available.

5 TON CAPACITY HEAVY DUTY MANUAL HYDRAULIC LONG CHASSIS JACK

MODEL 3120

- Heavy duty pumps, rams, and cylinders are precision machined and inspected to ensure long service life and superior performance
- Super long 56" body for easier lifting of vehicles with long overhangs
- Foot operated pump for quick lifting efficiency
- Handle mounted locking control lever has 3 positions for better versatility in under car positioning
- Automatic overload safety valves for added safety



Manual Hydraulic

MODEL	CAPACITY (Tons)	LOW HEIGHT	HIGH HEIGHT	CHASSIS LENGTH	OVERALL WIDTH (front)	OVERALL WIDTH (rear)	SHIP WEIGHT
3120	5	6"	22.5"	56"	11.5"	15"	254 lbs

5 TON CAPACITY HEAVY DUTY AIR/HYDRAULIC LONG CHASSIS JACK

MODEL 3125

- Operates at 115-200 PSI / 7.8 cubic feet per minute
- Heavy duty pumps, rams, and cylinders are precision machined and inspected to ensure long service life and superior performance
- Super long 56" body for easier lifting of vehicles with long overhangs
- Foot operated pump for quick lifting efficiency
- Handle mounted locking control lever has 3 positions for better versatility in under car positioning
- Automatic overload safety valves for added safety



Air/Hydraulic

MODEL	CAPACITY (Tons)	LOW HEIGHT	HIGH HEIGHT	CHASSIS LENGTH	OVERALL WIDTH (front)	OVERALL WIDTH (rear)	SHIP WEIGHT
3125	5	6"	22.5"	56"	11.5"	15"	273 lbs

10 TON CAPACITY HEAVY DUTY MANUAL HYDRAULIC LONG CHASSIS JACK

MODEL 3130

- Heavy duty pumps, rams, and cylinders are precision machined and inspected to ensure long service life and superior performance
- Super long 61" body for easier lifting of vehicles with long overhangs
- Foot operated pump for quick lifting efficiency
- Handle mounted locking control lever has 3 positions for better versatility in under car positioning
- Automatic overload safety valves for added safety



Manual Hydraulic

MODEL	CAPACITY (Tons)	LOW HEIGHT	HIGH HEIGHT	CHASSIS LENGTH	OVERALL WIDTH (front)	OVERALL WIDTH (rear)	SHIP WEIGHT
3130	10	7"	23"	61"	13"	18"	366 lbs



**10 TON CAPACITY HEAVY DUTY
AIR/HYDRAULIC LONG CHASSIS JACK**

MODEL 3135

- Operates at 115-200 PSI / 7.8 cubic feet per minute
- Heavy duty pumps, rams, and cylinders are precision machined and inspected to ensure long service life and superior performance
- Super long 61" body for easier lifting of vehicles with long overhangs
- Foot operated pump for quick lifting efficiency
- Handle mounted locking control lever has 3 positions for better versatility in under car positioning
- Automatic overload safety valves for added safety



Air/Hydraulic

MODEL	CAPACITY (Tons)	LOW HEIGHT	HIGH HEIGHT	CHASSIS LENGTH	OVERALL WIDTH (front)	OVERALL WIDTH (rear)	SHIP WEIGHT
3135	10	7"	23"	61"	13"	18"	387 lbs

**20 TON CAPACITY HEAVY DUTY
MANUAL HYDRAULIC LONG CHASSIS JACK**

MODEL 3220

- Heavy duty pumps, rams, and cylinders are precision machined and inspected to ensure long service life and superior performance
- Super long 66" body for easier lifting of vehicles with long overhangs
- Foot operated pump for quick lifting efficiency
- Handle mounted locking control lever has 3 positions for better versatility in under car positioning
- Automatic overload safety valves for added safety

NEW PRODUCT!



Manual Hydraulic

MODEL	CAPACITY (Tons)	LOW HEIGHT	HIGH HEIGHT	LENGTH	FRONT WIDTH	REAR WIDTH	SHIP WEIGHT
3220	20	7.50"	26.37"	66.00"	13.80"	19.70"	530 lbs

**20 TON CAPACITY HEAVY DUTY
AIR/HYDRAULIC LONG CHASSIS JACK**

MODEL 3225

- Uses 2.25 cubic ft / min of compressed air at 100 PSI
- Heavy duty pumps, rams, and cylinders are precision machined and inspected to ensure long service life and superior performance
- Super long 66" body for easier lifting of vehicles with long overhangs
- Foot operated pump for quick lifting efficiency
- Handle mounted locking control lever has 3 positions for better versatility in under car positioning
- Automatic overload safety valves for added safety

NEW PRODUCT!



Air/Hydraulic

MODEL	CAPACITY (Tons)	LOW HEIGHT	HIGH HEIGHT	LENGTH	FRONT WIDTH	REAR WIDTH	SHIP WEIGHT
3225	20	7.50"	26.37"	66.00"	13.80"	19.70"	562 lbs



American Forge & Foundry's Transmission Jacks provide service technicians the capability for solo installation of transmissions, differentials, or transfer cases. Capacities range between 700 lbs and 2200 lbs for applications from light duty cars to mid-size trucks.

1/2 TON-1100 LB CAPACITY AIR/HYDRAULIC TELESCOPIC TRANSMISSION JACK

MODEL 3190SS

- "Rapid Rise" combines air operated 1st stage for maximum speed with a hydraulic 2nd stage for accurate and final positioning
- Extra wide base provide easier and more efficient under hoist positioning
- Constructed with four "fast-ratcheting" head brackets to easily secure transmission pan flanges
- Includes heavy duty nylon strap for secure load anchoring
- Large crank handles for precise head adjustments
- Large 360° swivel casters for smooth transportation
- Safety overload system prevents jack from being used beyond its rated capacity



2 Stage Air Assist

MODEL	CAPACITY (LBS)	RAM STAGES	LOW HEIGHT	HIGH HEIGHT	FRONT TILT	REAR TILT	SIDE TILT	HEAD WIDTH	HEAD LENGTH	BASE WIDTH	SHIP WEIGHT
3190SS	1100	2	34"	72.75"	50°	20°	10°	8.5-19.5"	8.5-19.5"	41"X41"	220 lbs

1/2 TON-1100 LB CAPACITY AIR/HYDRAULIC TELESCOPIC TRANSMISSION JACK

MODEL 3192B

- Designed to be used with air or manual foot pump
- Universal head provides forward, back, and side tilt
- Fully adjustable universal saddle with spring loaded corner brackets allow easy positioning
- 90-120 PSI air pressure required. 7.875 cu/ft/min air consumption
- May be used to remove and install fuel tanks when combined with Model 3198 Fuel Tank Adapter (sold separately)
- Large 360° swivel casters for smooth transportation
- Safety overload system prevents jack from being used beyond its rated capacity



2 Stage Air Assist

MODEL	CAPACITY (LBS)	RAM STAGES	LOW HEIGHT	HIGH HEIGHT	FRONT TILT	REAR TILT	SIDE TILT	HEAD WIDTH	HEAD LENGTH	BASE WIDTH	SHIP WEIGHT
3192B	1100	2	38"	73.5"	42°	46°	2°	7-22"	9-20"	38"x 38"	218 lbs

1/2 TON-1100 LB CAPACITY TELESCOPIC TRANSMISSION JACK

MODEL 3190B

- Universal head provides forward, back, and side tilt
- Fully adjustable saddle with spring loaded corner brackets allow easy positioning
- May be used to remove and install fuel tanks when combined with Model 3198 Fuel Tank Adapter (sold separately)
- Large 360° swivel casters for smooth transportation
- Safety overload system prevents jack from being used beyond its rated capacity



2 Stage Manual

MODEL	CAPACITY (LBS)	RAM STAGES	LOW HEIGHT	HIGH HEIGHT	FRONT TILT	REAR TILT	SIDE TILT	HEAD WIDTH	HEAD LENGTH	BASE WIDTH	SHIP WEIGHT
3190B	1100	2	38"	73.5"	42°	46°	12°	7"-22"	9"-20"	38"X38"	203 lbs



1 TON-2200 LB CAPACITY TELESCOPIC TRANSMISSION JACK

MODEL 2195B

- Universal head provides forward, back, and side tilt
- Adjustable saddle with corner brackets and safety chain
- May be used to remove and install fuel tanks when combined with Model 3198 Fuel Tank Adapter (sold separately)
- Large 360° swivel casters for smooth transportation
- Safety overload system prevents jack from being used beyond its rated capacity



2 Stage Manual

MODEL	CAPACITY (LBS)	RAM STAGES	LOW HEIGHT	HIGH HEIGHT	FRONT TILT	REAR TILT	SIDE TILT	HEAD WIDTH	HEAD LENGTH	BASE WIDTH	SHIP WEIGHT
2195B	2200	2	38"	73.5"	30°	15°	12°	10"-14"	14"-18"	44"X44"	237 lbs

700 LB. CAPACITY TELESCOPIC TRANSMISSION JACK

MODEL 2145

- Economical single stage ram design
- Adjustable saddle
- Large 360° swivel casters for smooth transportation
- Safety overload system prevents jack from being used beyond its rated capacity



Single Stage Manual

MODEL	CAPACITY (LBS)	RAM STAGES	LOW HEIGHT	HIGH HEIGHT	FRONT TILT	REAR TILT	SIDE TILT	HEAD WIDTH	HEAD LENGTH	BASE WIDTH	SHIP WEIGHT
2145	700	1	53"	73"	12°	12°	NA	10"-14"	10"-14"	39"x 39"	95 lbs

1/2 TON-1100 LB CAPACITY TELESCOPIC TRANSMISSION JACK

MODEL 2158

- Universal head provides forward, back, and side tilt
- Extra wide base provide easier and more efficient under hoist positioning
- Foot operated pump frees both hands for easier alignment
- Convenient release knob for easy and controlled descent
- Safety overload system prevents jack from being used beyond its rated capacity



Single Stage Manual

MODEL	CAPACITY (LBS)	RAM STAGES	LOW HEIGHT	HIGH HEIGHT	FRONT TILT	REAR TILT	SIDE TILT	HEAD WIDTH	HEAD LENGTH	BASE WIDTH	SHIP WEIGHT
2158	1100	1	45"	71"	30°	15°	NA	8-14"	14"	23"x 23"	103 lbs



450 LB. CAPACITY TRANSMISSION JACK

MODEL 3160

- Adjustable head for easier positioning and alignment
- Nylon safety strap to secure load
- Requires 1/2" drive ratchet (not included)
- 450 lb. capacity
- Height: 7.25" - 22.5"
- Ship weight 43 lbs.



1/2 TON-1200 LB CAPACITY LOW PROFILE TRANSMISSION JACK

MODEL 3171

- Designed for light truck transmissions
- Fully adjustable universal saddle with corner brackets and safety chains
- Safety overload bypass to prevent hydraulic damage
- 24" handle pivots 360° around pump



MODEL	CAPACITY (LBS)	LOW HEIGHT	HIGH HEIGHT	FRONT TILT	REAR TILT	SIDE TILT	HEAD WIDTH	HEAD LENGTH	WIDTH	LENGTH	SHIP WEIGHT
3171	1200	6.875"	31.75"	15°	12°	15°	7"-13"	8"-11"	19.75"	38.25"	117 lbs

1 TON CAPACITY-2000 LB LOW PROFILE TRANSMISSION JACK

MODEL 3172

- Designed for light truck transmissions
- Fully adjustable universal saddle with corner brackets and safety chains
- Safety overload bypass to prevent hydraulic damage
- 24" handle pivots 360° around pump
- Four industrial grade 3" casters



MODEL	CAPACITY (LBS)	LOW HEIGHT	HIGH HEIGHT	FRONT TILT	REAR TILT	SIDE TILT	HEAD WIDTH	HEAD LENGTH	WIDTH	LENGTH	SHIP WEIGHT
3172	2000	5.875"	30.75"	15°	10°	15°	7"-16"	9"-14"	18.25"	36.75"	145 lbs

1 TON-2000 LB CAPACITY HEAVY DUTY TRANSMISSION JACK

MODEL 3178

- Adjustable width head plate and wedge shaped brackets allows for a wide range of mounting options
- 4-way tilting head allows easier removal and installation of transmissions
- Equipped with a 360° swivel handle for better use in confined areas
- Open leg design for added versatility
- Safety chain included
- Rugged heavy duty casters
- Safety overload system prevents jack from being used beyond its rated capacity



MODEL	CAPACITY (LBS)	LOW HEIGHT	HIGH HEIGHT	FRONT TILT	REAR TILT	SIDE TILT	HEAD WIDTH	HEAD LENGTH	WIDTH	LENGTH	SHIP WEIGHT
3178	2000	6.5"	31.5"	79°	9°	10-18°	18.25"	18.25"	28"	48"	335 lbs



2 TON-4400 LB CAPACITY HEAVY DUTY TRANSMISSION JACK

MODEL 3180

- The only Heavy Duty transmission jack with a rated capacity of over 2 tons
- 8.5" low height provide additional low profile solutions
- Fully adjustable saddle with maximum tilt for easier alignment
- Adjustable corner brackets provide extra versatility
- Extra-long 32" handle rotates 360° around pump
- Rugged industrial grade 4" casters for smooth transportation and easy mobility
- Convenient side tray to store small tools and parts
- Safety chain included
- Safety overload system prevents jack from being used beyond its rated capacity



MODEL	CAPACITY (LBS)	LOW HEIGHT	HIGH HEIGHT	FRONT TILT	REAR TILT	SIDE TILT	HEAD WIDTH	HEAD LENGTH	WIDTH	LENGTH	SHIP WEIGHT
3180	4400	8.5"	34"	15°	30°	12°	12"-18"	16"-20"	26"	43"	374 lbs

TRANSMISSION JACK ADAPTER SET

MODEL 3181

- Ideal for use with AFF's model 3180 Heavy Duty Transmission Jack
- Works with a wide variety of different truck transmissions including Eaton® and Fuller®
- Comes with 6 adapter bars (4 small, 2 large) 4 positioning screws, and 2 securing chains



FUEL TANK ADAPTER

MODEL 3198

Converts AFF Model 3190B, 3192A and 2195A transmission jacks to remove and install fuel tanks.

- 4" x 5.75" diameter saddles adjust from 19.75" to 31.75"
- Includes two safety straps and two grounding cables.
- 80 lb. capacity
- Ship weight 59 lbs



American Forge & Foundry features a wide range of specialty jacks for the trucking, agriculture, fleet, and military sectors. Each is designed for applications where extra capacity, added reach, or height may be required.

25/10 TON TWO STAGE AIR/HYDRAULIC AXLE JACK

MODEL 546SD

- Descent metering valve allows for a safe and controlled lowering of the load
- Extra-long 54" handle can be locked in 3 positions for easy placement in confined areas
- Single piece base construction provides superior strength for increased load stability
- Includes 1.75" and 3" extensions and saddle adapter
- Double polished chrome pistons provide tighter tolerances and greater hydraulic seal
- Safety overload system prevents jack from being used beyond its rated capacity



MODEL	CAPACITY (Tons)	RAM LIFT	LOW HEIGHT	HIGH HEIGHT	HIGH HEIGHT With Extensions	WORKING AIR PRESSURE	SHIP WEIGHT
546SD	25	3.82"	7.28"	11.10"	16.85"	116 to 174 PSI	128 lbs
	10	7.56"	7.28"	14.84"	20.59"		

30/15 TON TWO STAGE AIR/HYDRAULIC AXLE JACK

MODEL 545SD

- Lightweight design ideal for the Service Vehicle industry
- Ideal for drop axles and other low clearance applications
- Extra-long removable handle and rugged casters for easy positioning
- Descent metering valve allows for a safe and controlled lowering of the load
- Includes 1.75" and 3" extensions and saddle adapter
- Double polished chrome pistons provide tighter tolerances and greater hydraulic seal
- Safety overload system prevents jack from being used beyond its rated capacity



MODEL	CAPACITY (Tons)	RAM LIFT	LOW HEIGHT	HIGH HEIGHT	HIGH HEIGHT With Extensions	WORKING AIR PRESSURE	SHIP WEIGHT
546SD	30	2.91"	5.92"	8.82"	14.57"	116 to 145 PSI	77 lbs
	15	5.59"	5.92"	11.50"	17.25"		



50/25 TON TWO STAGE AIR/HYDRAULIC AXLE JACK

MODEL 547SD

- 50 ton stage built for the rigors of the Heavy Duty, Fleet, Agriculture, and Military sectors
- Extra-long 54" handle can be locked in 3 positions for easy placement in confined areas
- Single piece base construction provides superior strength for increased load stability
- Descent metering valve allows for a safe and controlled lowering of the load
- Includes 1.75" and 3" extensions and saddle adapter
- Double polished chrome pistons provide tighter tolerances and greater hydraulic seal
- Safety overload system prevents jack from being used beyond its rated capacity

MODEL	CAPACITY (Tons)	RAM LIFT	LOW HEIGHT	HIGH HEIGHT	HIGH HEIGHT With Extensions	WORKING AIR PRESSURE	SHIP WEIGHT
547SD	50	4.61"	8.46"	13.07"	18.82"	116 to 174 PSI	165 lbs
	25	9.09"	8.46"	17.56"	23.31"		



60/40/20 TON THREE STAGE AIR/HYDRAULIC AXLE JACK

MODEL 548SD

- 60 ton stage built for the rigors of the Heavy Duty, Fleet, Agriculture, and Military sectors
- Extra-long 54" handle can be locked in 3 positions for easy placement in confined areas
- Single piece base construction provides superior strength for increased load stability
- Descent metering valve allows for a safe and controlled lowering of the load
- Includes 1.75" and 3" extensions and saddle adapter
- Double polished chrome pistons provide tighter tolerances and greater hydraulic seal
- Safety overload system prevents jack from being used beyond its rated capacity

MODEL	CAPACITY (Tons)	RAM LIFT	LOW HEIGHT	HIGH HEIGHT	HIGH HEIGHT With Extensions	WORKING AIR PRESSURE	SHIP WEIGHT
548SD	60	3.03"	6.89"	9.92"	15.67"	116 to 174 PSI	165 lbs
	40	5.79"	6.89"	12.68"	18.43"		
	20	9.02"	6.89"	15.91"	21.66"		



80/50 TON TWO STAGE AIR/HYDRAULIC AXLE JACK

MODEL 549SD

- 80 ton stage built for the rigors of the Heavy Duty, Fleet, Agriculture, and Military sectors
- Extra-long 54" handle can be locked in 3 positions for easy placement in confined areas
- Single piece base construction provides superior strength for increased load stability
- Descent metering valve allows for a safe and controlled lowering of the load
- Includes 1.75" and 3" extensions and saddle adapter
- Double polished chrome pistons provide tighter tolerances and greater hydraulic seal
- Safety overload system prevents jack from being used beyond its rated capacity

MODEL	CAPACITY (Tons)	RAM LIFT	LOW HEIGHT	HIGH HEIGHT	HIGH HEIGHT With Extensions	WORKING AIR PRESSURE	SHIP WEIGHT
549SD	80	3.03"	9.06"	13.39"	19.14"	116 to 174 PSI	240 lbs
	50	5.79"	9.06"	17.32"	23.07"		



Specialty Jacks



1/4 TON-500 LB CLUTCH JACK - HEAVY DUTY

MODEL 3700

- Provides "one-man" operation for removal, installation, and transportation of heavy duty truck clutches
- Includes two splined alignment shafts (2" OD x 1.18" and 1.75" OD x .938 pilot)
- Unique pinned alignment shaft allows technician to remove jack to install clutch assembly without obstruction
- Clutch assemblies can be built on the vertical shaft and then positioned easily under the truck
- Patented clutch head assembly (US patents 5,251,875, and 5,033,717)

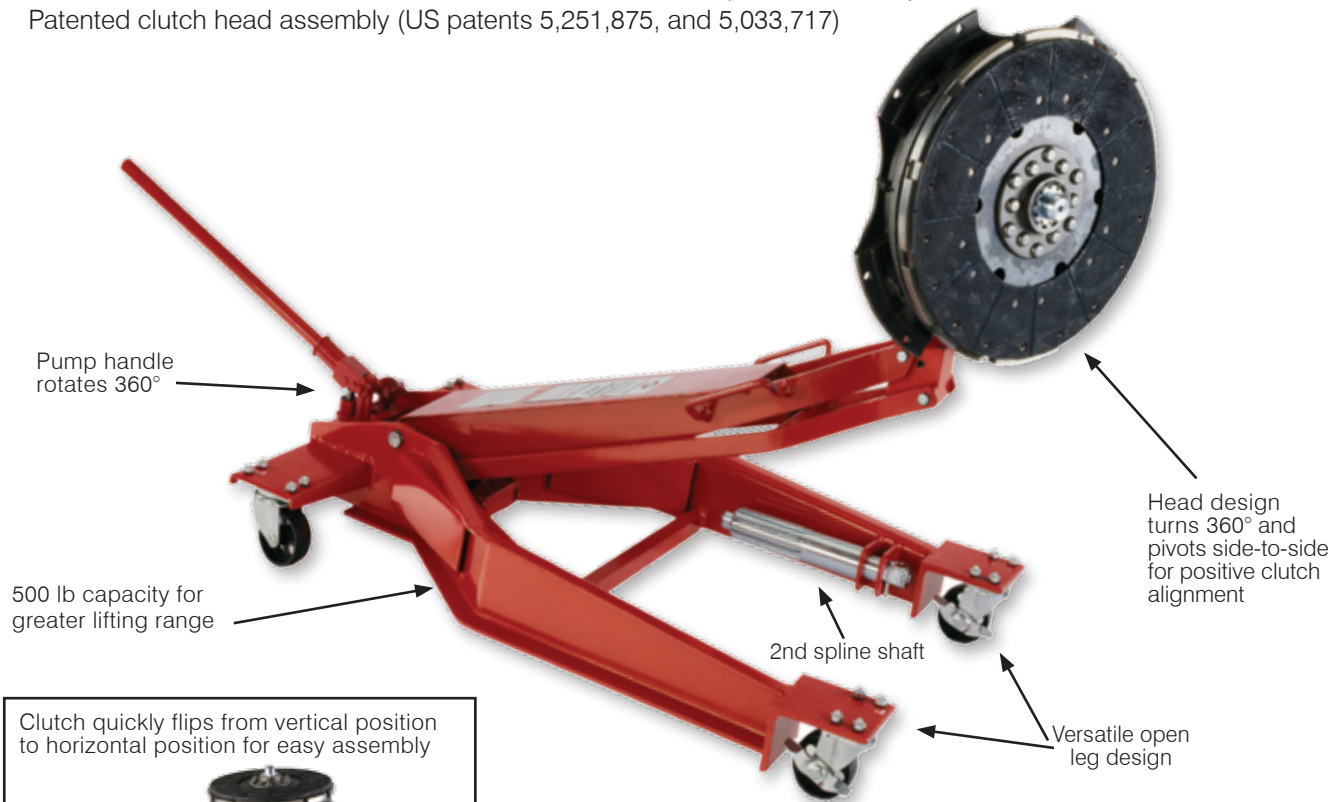

Clutch quickly flips from vertical position to horizontal position for easy assembly



MODEL	CAPACITY (Lbs)	LOW HEIGHT	HIGH HEIGHT	FRAME DIMENSIONS	SHIP WEIGHT
3700	500	13"	39"	36.5" x 22"	139 lbs

CLUTCH JACK ACCESSORIES

FLYWHEEL ADAPTER

MODEL 3751

Easily replaces the spline and bolts onto flat and pot-style truck flywheels used with 14" and 15.5" clutches for more efficient removal and installation.

- Ship weight 6 lbs.



SPLINED SHAFT

MODEL 3749

- 1.75" OD x 1.18" Pilot
- Ship weight 6 lbs.

MODEL 3752

- 1.75" OD x 0.983" Pilot
- Ship weight 6 lbs.

MODEL 3753

- 2" OD x 1.18" Pilot
- Ship weight 6 lbs.

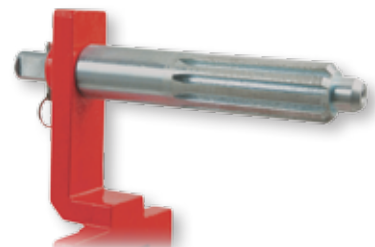

3 TON RATCHETING FARM JACK

MODEL 3040A

- 48" long
- 6,600 lb. total capacity
- 32" long handle with grip
- Steel forged base 5.75" x 6.75"
- 4" upper foot/4.5" lower foot
- Ship weight 34 lbs.



7 TON FORKLIFT JACK - HEAVY DUTY

MODEL 3917

- Scissors lift from 2.5" to 16.5" for universal coverage of most forklift models
- 14" reach in raised position
- Rugged casters make load alignment easier
- Chassis 26" long x 9" wide
- Safety valve provides critical overload protection

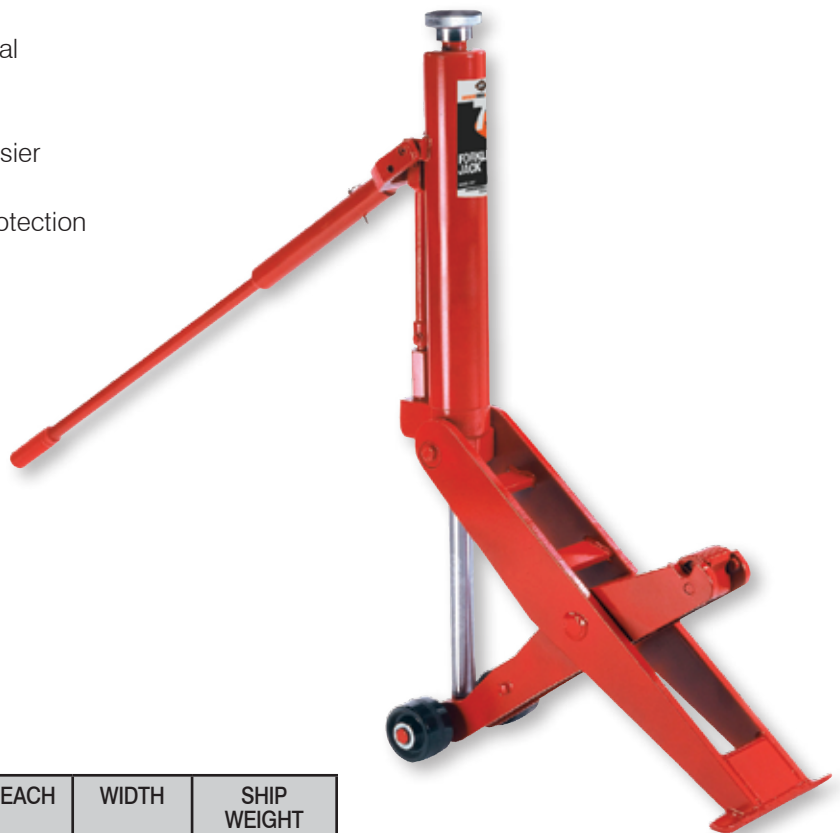

MODEL	CAPACITY (Tons)	LOW HEIGHT	HIGH HEIGHT	REACH	WIDTH	SHIP WEIGHT
3917	7	2.5"	16.5"	14"	9.875"	150 lbs

American Forge & Foundry Air Lifts are designed to quickly and efficiently lift large trucks, tractors, trailers, buses, and heavy construction equipment. All units are 100% air operated and include integrated locking mechanisms to hold the load. Safety stands are recommended to provide additional stability.

5-1/2 TON LOW PROFILE/LONG REACH AIR LIFT

MODEL 3596

- 48" forward reach provides necessary access to difficult lifting points
- Performs lift at the front axle, frame, or bumper
- 5-1/2 ton capacity performed at 160 PSI
- Steel saddles adjust between 23" and 45" widths to accommodate a variety of vehicle applications
- Includes 2 saddle sizes and drop axle adapter for extra versatility
- Three-way heavy duty air valve for precision lifting
- Automatic safety lock engages in five preset positions

Adapters Included



MODEL	CAPACITY (Tons)	LOW HEIGHT	HIGH HEIGHT	LENGTH	BASE WIDTH	OVERALL HEIGHT	SHIP WEIGHT
3596	5.5	6.5"	53.5"	77"	23"	70"	638 lbs

10 TON AIR LIFT JACK

MODEL 3400A

- 10 ton capacity achieved at 200-PSI
- Heavy duty air valve offers accurate lift control
- Removable "T" handle allows easy storage
- Extension tubes offer multiple lifting points and locking positions
- 12" lift travel



Support Pin



MODEL	CAPACITY (Tons)	LOW HEIGHT	HIGH HEIGHT	LENGTH	BASE WIDTH	OVERALL HEIGHT	SHIP WEIGHT
3400A	10	18"	52"	27"	12.75"	18.25"	172 lbs

10 TON AIR LIFT

MODEL 3598

- Constructed with an extra wide stance to lift the entire front or rear of large trucks, buses, and other heavy duty equipment
- 10 Ton capacity achieved at 200 PSI
- 4" x 6" steel saddles adjust between 36" and 50" widths
- Saddle arms reversible for low height loads
- Three-way air valve for high precision lifting and lowering control
- Automatic mechanical lock engages at five lift heights from 17.5" to 50"
- Two air control valve fittings: one for shop air supply and one for a Schrader valve
- Front swivel caster and two pneumatic rear tires for easy positioning
- 13" forward reach (distance from cylinder to saddles)



MODEL	CAPACITY (Tons)	LOW HEIGHT	HIGH HEIGHT	LENGTH	BASE WIDTH	OVERALL HEIGHT	SHIP WEIGHT
3598	10	12.5"	50"	39"	36"	67"	750 lbs



American Forge & Foundry's Power Ram Kits are used primarily in automotive repair and is an ideal solution for most collision work. Applications include spreading, pushing, and pressing body panels, bumper damage, and other Heavy Duty equipment repair.

4 TON POWER RAM KIT

MODEL 814C

- Great for bumper damage, body panel, and other automotive repairs
- Blow mold case for easy portability and storage
- Ship weight 43 lbs



10 TON POWER RAM KIT

MODEL 815C

- Extra capacity for Heavy Duty equipment work
- Additional wheels on case for easy portability and access
- Ship weight 83 lbs



814C and 815C include:

- Model 814-41 4 ton ram or Model 815-41 10 ton ram
- Model 814-11 spreader ram
- Model 814-40 4 ton or Model 815-40 10 ton hydraulic hand pump
- 5", 10", 21", and 24" extension tubes
- 3-1/4" extension tube (814C only)
- Rubber head

- Wedge head
- Spreader ram plunger toes
- Serrated saddle
- Rubber faced flat base
- 90° V-base
- Quick connector
- Model 814K42 72" hydraulic hose

20 TON POWER RAM KIT

MODEL 818SD

- Ideal for trucking, farming, and construction
- Comes with 2 metal carry boxes for added mobility and storage
- Ship weight 108 lbs



Each kit includes:

- 2-Speed Hydraulic Hand Pump
- 5' Hydraulic Hose
- 20 Ton Ram w/5" stroke
- Extension Tubes (27.5", 20", 10", 5")
- Lock Pin
- Male Connector (3)
- Threaded coupling (3)
- Plunger Base (2)
- Toe Lift
- "V" Head
- Wedge Head
- Serrated Saddle



20 TON HYDRAULIC RAM FOR 818SD

MODEL 818SD-41

- Threaded 20-ton ram with 5" stroke
- Direct replacement for ram in the 818SD kit
- Ship weight 30 lbs.

HYDRAULIC PUMP FOR 818SD KIT

MODEL 818SD-40

- 2-speed 10,000 psi pump with safety overload protection
- Same unit as pump included in the 818SD kit
- Ship weight 18 lbs.



American Forge & Foundry's Hand and Foot Pumps are designed for portability and ease of use. Constructed with industrial grade material each produces up to 10,000 PSI of high pressure and includes overload protection for added safety.

4 TON HAND PUMP

MODEL 814-40

- Develops up to 10,000 PSI pressure with overload protection
- 16 cu. in. oil capacity
- Exact replacement for hand pump in AFF Model 814 series 4-ton Body and Frame Repair Kits
- Works with 4KR22 hose
- Ship weight 11 lbs.



10 TON HAND PUMP

MODEL 815-40

- Develops up to 10,000 PSI pressure with overload protection
- 33 cu. in. oil capacity
- Exact replacement for hand pump in AFF Model 815 series 10-ton Body and Frame Repair Kits
- Works with 4KR22 hose
- Ship weight 15 lbs.



10 TON CAPACITY AIR/HYDRAULIC FOOT PUMP

MODEL 805

- Converts rams from manual to air/hydraulic operation
- Develops up to 10,000 PSI pressure with overload protection
- Will operate all AFF rams
- Operates at 90 to 120 PSI
- 19.95 oz. oil capacity
- 17-1/2" length
- Ship weight 12 lbs.



10 TON CAPACITY AIR/HYDRAULIC FOOT PUMP

MODEL 806

- Rugged lightweight aluminum reservoir
- Converts rams from manual to air/hydraulic operation
- Will operate all AFF rams including large diameter & multiple ram configurations
- Operates at 90 PSI and up
- Quick displacement of up to 54.08 oz. hydraulic fluid
- Develops up to 10,000 PSI pressure
- Ship weight 19 lbs.



PULL KIT WITH HOOKS

MODEL 804-09

- 10-ton Capacity
- 12" to 17" reach
- Ship Weight 11 lbs.



RAM HALF COUPLER

MODEL 4KR20

- 3/8" high flow coupler for quicker hydraulic system set-up.
- Develops 10,000 PSI capacity
- 1/4" NPT female connection
- For use with all AFF pumps and rams
- Ship weight 1 lb.



PUMP HOSE HALF COUPLER

MODEL 4KR21

- 3/8" hose
- Develops 10,000 PSI capacity
- 1/4" NPT female connection
- For use with all AFF pumps and rams
- Ship weight 1 lb.



COMPLETE RAM COUPLER

MODEL 4KR22

- Complete 3/8" quick coupler
- Develops 10,000 PSI capacity
- For use with all AFF pumps and rams
- Ship weight 1 lb.



American Forge & Foundry offers a wide assortment of Hydraulic Rams for use in high force applications including lifting, pulling, pushing, bending, and alignment. Universal design can be used with AFF and other body and frame repair kits. Available styles include: mini, snap style, screw, pull, wedge, and long configurations.



804-11 812-41 LRC3B 804-10 814-41 LRC8B 810-07B 810-41 810-45 815-41

MODEL	CAPACITY (Tons)	TYPE	STROKE	COMPRESSED LENGTH	EXTENDED LENGTH	SPRING RETURN	SHIP WEIGHT
804-11	1/2	Wedge	16.5"	1/2"	4"	NA	5 lbs
812-41	2	Mini	3"	4-3/4"	9-1/2"	No	2 lbs.
LRC3B	3	Long	20-3/4"	24-1/4"	45"	NA	25 lbs
804-10	4	Mini	5/8"	1-1/2"	2-1/4"	No	3 lbs
814-41	4	Snap Style	5"	11"	16"	Yes	4 lbs
LRC8B	8	Long	20-3/4"	24-1/4"	45"	NA	35 lbs
810-07B	10	Mini	2"	4-3/4"	6-3/4"	Yes	6 lbs
810-41	10	Screw	6"	15"	21"	Yes	10 lbs
810-45	10	Long	10"	15-3/4"	25-3/4"	Yes	13 lbs
815-41	10	Snap Style	6"	15"	21"	Yes	12 lbs.

Power Ram



American Forge & Foundry's Engine Cranes are designed for easy and efficient removal and transport of vehicle engines. Each feature four position telescopic booms, wide stable bases, forged steel hooks with safety latches, and heavy duty swivel casters. Stands are available to help position the engine for optimal work.

2 TON-4400 LB CAPACITY FOLDABLE ENGINE CRANE

MODEL 3582

- Folds up for easy storage (57"H x 12" W x 27" D)
- Boom extends from 40" to 63"
- 69" base length
- Ship weight 225



MODEL	CAPACITY (Lbs)	Boom (Lbs) Capacity				Maximum Horizontal Reach				Maximum Hook Height				SHIP WEIGHT
		1	2	3	4	1	2	3	4	1	2	3	4	
3582	4400	4400	3300	2200	1100	23"	31"	38"	45"	72.5"	77.5"	82"	87"	225 lbs

3 TON-6000 LB CAPACITY HEAVY-DUTY ENGINE CRANE

MODEL 3584

- Reinforced leg assemblies for added strength and durability
- 4 different boom settings: 3, 2, 1.5, and 1 Ton
- Rear of crane is 61.5" tall and 33" wide
- Distance between front of legs: retracted 23" / extended 28.5"
- Large 4.25" rear swivel casters and 6" fixed front wheels provide ease of mobility and positioning
- Constructed with built in safety overload to protect the unit from being used being its rated capacity
- Ship weight 355 lbs.



WORKING DIMENSIONS

Ton Setting	Max Ht.	Max Reach
3 Ton 6,000 lbs	87.0"	35"
2 Ton 4,000 lbs	91.5"	42"
1.5 Ton 3,000 lb	95.5"	50"
1 Ton 2,000 lbs	99.5"	61"

1/2 TON-1000 LB TRUCK MOUNTED CRANE

MODEL 3586B

- Rugged steel construction
- Boom working range: 28" to 42.5"
- Locking swivel base - 360 degree swivel
- Heavy duty chain with safety lock
- Hydraulic operation provides easy lifting to desired height
- Designed to be installed in truck beds or vans
- Includes mounting plate and chain with grab hook
- Lifting range 0-75"
- Ship weight 106 lbs.



Shown in DOWN position



700 LB. CAPACITY TRANSVERSE ENGINE SUPPORT WITH ADDED SUPPORT BAR

MODEL 584

- Three support points for added stability
- 700 lb. capacity
- 2 - 14" adjustable hook screws
- 2.125" x 38" braided steel cables
- Width expands from 34.5" to 61"
- Ship weight 27 lbs.

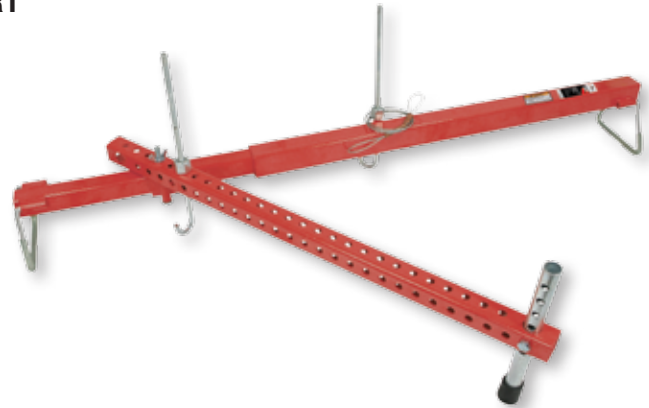

1/2 TON-1100LB CAPACITY ENGINE SUPPORT

MODEL 583

- Provides overhead engine support for removal of transaxle on FWD vehicles
- Ideal for four and six cylinder FWD vehicles
- Adjusts from 26.5" to 49.5" wide with 18.75" screw travel
- Ship weight 38 lbs.

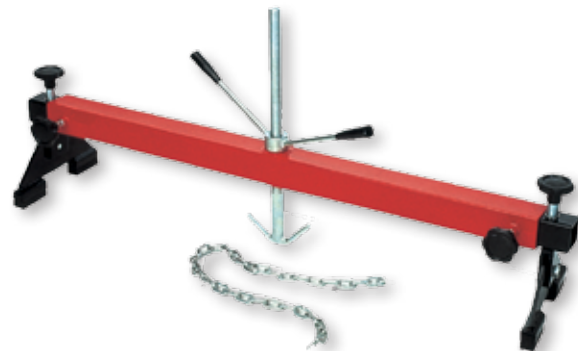

1 TON-2200 LB CAPACITY ENGINE TILTER

MODEL 582

- For use with AFF cranes to effectively change engine's center of gravity during installation or removal
- 23.5" wide support bracket
- Ship weight 19 lbs



1/2 TON-1000 LB. CAPACITY ENGINE STAND

MODEL 571B

- Wide 4 point "H" type base ensures good stability
- Adjustable brackets allow maximum flexibility – fits most small engines
- 360° rotating head enables engine to be placed in desired work position
- Full swivel casters
- Heavy duty welded steel base



MODEL	CAPACITY (Lbs)	LENGTH	FRONT WIDTH	REAR WIDTH	SHIP WEIGHT
571B	1000	36"	19.5"	33.25"	67 lbs

1250 LB. CAPACITY ENGINE STAND

MODEL 573B

- Extra wide 4-point "U" type base ensures maximum stability and performance
- Adjustable brackets allow maximum flexibility – fits most automobile and light truck engines
- 360° rotating head enables placement of engine in desired work position
- Full swivel casters
- Heavy duty welded steel base
- Includes convenient tray for storing tools and parts



MODEL	CAPACITY (Lbs)	LENGTH	FRONT WIDTH	REAR WIDTH	SHIP WEIGHT
537B	1250	34"	33"	33"	83 lbs



PORTABLE TRUCK WHEEL DOLLY

MODEL 3590A

- 300 lb capacity
- Ideal for road service applications
- Rugged tubular steel construction
- Handles wheels up to 24" diameter
- 8" rollers turn and pivot for accurate and efficient alignment of mounted truck tires with hub stubs
- Ship weight 18 lbs.



SUPER SINGLE TRUCK WHEEL DOLLY

MODEL 3591

- Easily handles newer design super wide tires
- 26" wide carriage handles tire diameter 36"-48"
- 450 lb capacity
- Heavy duty tubular steel construction
- Bent handle design improves leverage and greatly reduces user strain
- 14" rollers turn and pivot for accurate and efficient alignment of mounted truck tires with hub stubs
- Ship weight 25 lbs.

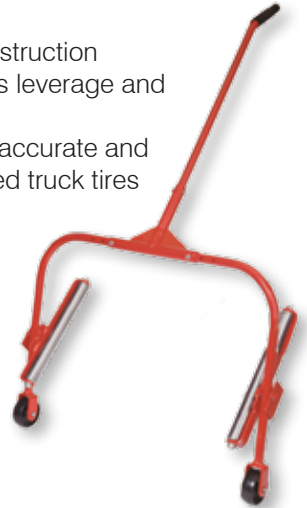

3/4 TON HEAVY-DUTY WHEEL DOLLY

MODEL 3577

- Lift arms adjust inward and outward to handle a variety of different wheel combinations
- Provides extra low access for easy placement of heavy wheel assemblies
- Full 7.75" ram lift
- Includes leveling screw for precise alignment
- Six foot safety chain provide added security during transport
- 3 extra-large swivel casters for added mobility



MODEL	LOW HEIGHT	HIGH HEIGHT	LENGTH	WIDTH	SHIP WEIGHT
3577	2.5"	10.25"	31"	43"	166 lbs

BRAKE DRUM HANDLER

MODEL 3595A

- Efficiently installs, removes, and transports 15" to 16.5" brake drums
- Adjustable brackets secure inboard and outboard drums with disc wheel hubs
- Height adjustable rotary handle
- Removable rotating handle
- Ship weight 55 lbs

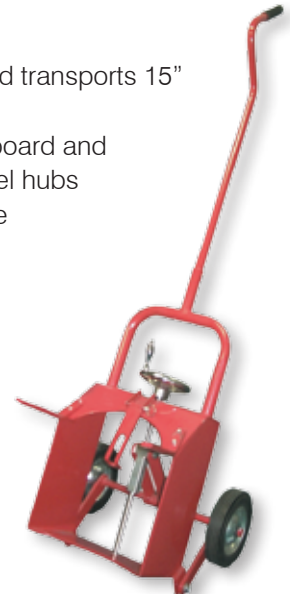

AUTOMOTIVE/LIGHT TRUCK WHEEL STEP

MODEL 3911A

- Wraps over tire to provide a nonslip step
- Adjusts to tire depth and height
- Ideal for loading roof racks, servicing trucks, etc
- Folds flat for easy storage
- 21" L x 7" W
- Capacity 300 lbs
- Ship weight 14 lbs



HEAVY DUTY TRUCK WHEEL STEP

MODEL 3912A

- Wraps over tire to provide a nonslip step
- Ideal for loading roof racks, servicing trucks, etc
- Fits truck tires up to 24.5" diameter
- 9" x 27" step with rugged nonslip thread
- Folds flat for easy storage
- Capacity 300 lbs
- Ship weight 17.5 lbs



American Forge & Foundry's Safety Stands provide a safe and secure method to hold a load in place to perform under vehicle maintenance. Both ratchet and pin style stands are constructed with heavy gauge steel and large support saddles for added strength and stability. Stands are intended for use in pairs and the maximum load capacity for a matched pair shall not exceed the capacity of the individual stand. All stands meet ANSI and PALD standards.

3 TON JACK STAND SET

MODEL 3303

- Notched saddles for use with unitized body vehicles
- Safety ratchet prevents lowering when saddle is loaded
- Welded feet for added stability even on rough terrain
- Adjusts from 11.75" to 17"
- 7"x7.5" base
- Ship weight 16 lbs per pair



6 TON JACK STAND SET

MODEL 3306

- Notched saddles for use with unitized body vehicles
- Safety ratchet prevents lowering when saddle is loaded
- Welded feet for added stability even on rough terrain
- Adjusts from 16" to 23.75"
- 9"x10.5" base
- Ship weight 30 lbs per pair



12 TON JACK STAND SET

MODEL 3312B

- Notched saddles for use with unitized body vehicles
- Safety ratchet prevents lowering when saddle is loaded
- Adjusts from 19.5" to 28"
- 11.625" x 13" base
- Ship weight 67 lbs per pair



5 TON CAPACITY FORKLIFT JACK STAND SET

MODEL 3305A

- Pin type posts adjust to four height positions from 13" to 17"
- Extra-large 2.75"x4" support saddles
- Heavy duty 9"x10" base secures load
- Ship weight 29 lbs per pair



10 TON CAPACITY TRUCK JACK STAND

MODEL 3309A

- Pin type post adjusts to seven height positions from 18.5" to 30"
- Extra-large 3.125"x5.875" support saddles and wide 17"x17" base
- Convenient carrying handle for easy portability
- Sold individually
- Ship weight 37 lbs



10 TON CAPACITY HEAVY DUTY TRUCK STAND

MODEL 3310A

- Pin type post adjusts to ten height positions from 28" to 47"
- Extra-large 3.125" x 5.875" support saddle and wide 16"x16" base
- Sold individually
- Ship weight 55 lbs

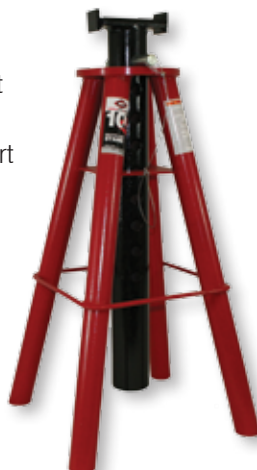

20 TON HEAVY DUTY JACK STAND

MODEL 3314

- Pin type post adjusts to four positions from 12" to 20"
- Extra-large 3"x5" saddle
- Stable 10" x 10" base
- Carrying handle for transport
- Sold individually
- Ship weight 50 lbs





**UNDER HOIST COMPONENT STAND
MODEL 3320A**

- Designed to support vehicle components
- Adjusts from 54.5" to 80.5"
- Includes foot operated pump for extra lift
- Bearing included for smooth operation
- 12" diameter base
- Ship weight 36 lbs

**2 TON HIGH LIFT UNDER HOIST
STABILIZING STAND**

MODEL 3315A

- Designed to support vehicle components only
- Ideal for exhaust and suspension work
- Adjusts from 55" to 85.5"
- Bearing included for smooth operation
- Easily disassembles for storage
- 24"x24"x24" base
- Ship weight 44 lbs



2 TON UNDER HOIST STABILIZING STAND

MODEL 3233A

- Designed to support vehicle components only
- Adjusts from 66.5" to 73"
- Includes adjusting screw for easier load positioning
- Bearing included for smooth operation
- 21"x21"x21" base
- Ship weight 26 lbs

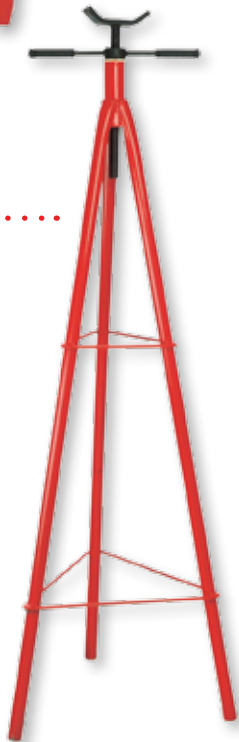

**50 TON TRAILER STABILIZING STAND
MODEL 3318**

- 100,000 lb static load capacity
- 45,000 lb lifting capacity
- Can be used to stabilize loaded and unloaded trailers when not connected to trucks
- Adjusts from 39" to 51"
- Pivoting and reversible ratchet head levels trailers on uneven ground
- Wide 14" diameter base for added stability
- Removable pipe handle
- Ship weight 157 lbs



Meets OSHA requirements for stabilizing loaded and unloaded trailer



7.5 TON FIXED HIGH TRUCK STAND
MODEL 3342SD

- Adjustable height range from 57" to 82"
- Twenty one 1" height adjustments with 4" fine adjustment by screw
- Spring loaded casters allow for ease of positioning and portability
- Non-skid rubber saddle pad for secure placement
- Spring loaded tower for easy height adjustment
- Ship weight 134 lbs



7.5 TON FIXED HIGH TRUCK STAND
MODEL 3344SD

- Adjustable height range from 36" to 54"
- Seventeen 1" height adjustments
- Non-skid rubble saddle for secure placement
- Spring loaded casters for ease of positioning and portability
- Ship weight 103 lb



.....
16.5 TON FIXED HIGH TRUCK STAND
MODEL 3340SD

- Adjustable height range from 57" to 82"
- Twenty one 1" height adjustments with 4" fine adjustment by screw
- Spring loaded casters allow for ease of positioning and portability
- Non-skid rubber saddle pad for secure placement
- Spring loaded tower for easy height adjustment
- Ship weight 324 lbs

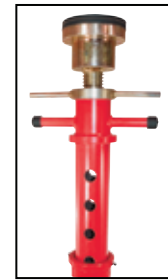

Adjustable Height

20 TON WIDE STANCE TRUCK RAMPS

MODEL 3420ASD

- Long retractable handle
- Wheels ease movement and stores easily out of the way
- Suitable for large truck tires up to 16" maximum width
- Comes with rubber nonskid pad to prevent slippage
- 20 ton capacity per pair
- Frame = 47" L x 18.25" W x 9.25" H
- Overall length = 51"
- Tread Width = 16"
- Ships one pair in wooden crate
- Ship weight 396 lbs. per pair

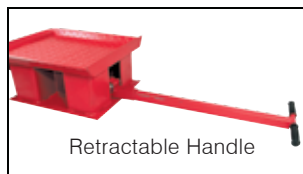

Retractable Handle

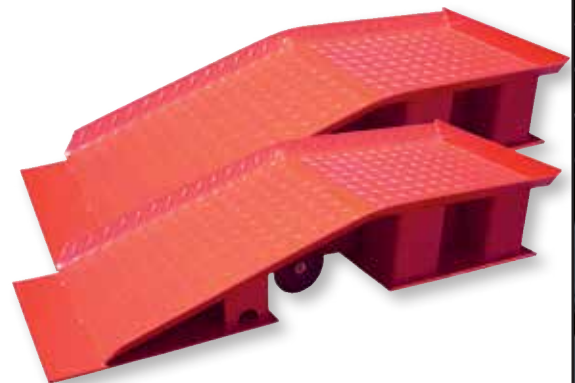

American Forge & Foundry's Material Handling include a wide selection of portable equipment to allow you to quickly and easily move a variety of drums and other shop supplies. Chain, Lever, and Cable hoists provide effortless lifting and lowering of heavy materials.

13.2 GALLON DRUM BAND DOLLY

MODEL 8625

- Designed to efficiently move 13.2-gallon drums and pails
- Adjustable band clamp holds load securely
- Four rubberized casters for directional stability
- Ship weight 8 lbs.



55 GALLON DRUM BAND DOLLY

MODEL 8655

- 660 lb capacity
- Moves 55 gallon steel, plastic, and fiber drums safely and easily
- Heavy duty all steel construction
- Constructed with four 3" swivel casters for easy transport
- 24.375" band diameter
- Ship weight 24 lbs



55 GALLON DRUM CRADLE

MODEL 8656

- 660 lb capacity
- Tip, drain, and store 55 gallon drums with ease (drum not included)
- Cradle supports drum 17" off floor
- Constructed with four wheels for easy positioning
- 34" L x 21" W x 17" H
- Ship weight 24 lbs



2 TON PALLET JACK

MODEL 3900A

- High tensile steel frame with 5,500 lb total capacity
- Quickly lifts from 3" to 7.75"
- Extra-large 27" x 48" platform
- Full 180° steering arc
- Durable polyurethane coated steel wheels and entry rollers
- Three position control lever automatically returns to neutral position
- Durable sealed pump with overload safety system
- Ship weight 228 lbs.

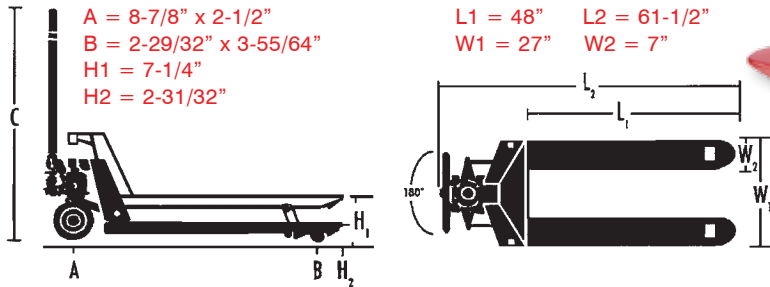

1/2 TON-1100 LB HEAVY DUTY HYDRAULIC TABLE CART

MODEL 3904

- 1100 lb total capacity
- Positions and raises work piece from 11" to 36"
- Extra-large 32" x 19.5" work area
- Foot operated pedal keeps your hands free
- Constructed with two wheel brakes for added safety
- Handle mounted pressure release
- Ship weight 195 lbs



POLYPROPYLENE DRUM DOLLY

MODEL 8654

- Designed for 30 and 50 gallon capacity drums
- 2 steps – 18.75" diameter and 23.25" diameter
- Constructed with 5 heavy duty casters with threaded inserts to prevent "tear out."
- 660 lb total capacity
- Ship weight 22 lbs



CHAIN HOISTS

- Factory tested to 150% of rated capacity
- Rugged triple spur gear
- Safety brake to prevent slippage
- Hardened steel alloy chain for safe, smooth operation
- Forged safety hooks included

MODEL 4001 1 TON 2,000 LB. CAPACITY CHAIN HOIST



MODEL 4002 2 TON 4,000 LB. CAPACITY CHAIN HOIST



MODEL 4003 3 TON 6,000 LB. CAPACITY CHAIN HOIST



MODEL 4005 5 TON 10,000 LB. CAPACITY CHAIN HOIST



MODEL	CAPACITY (lbs.)	LIFT (ft)	CHAIN DIAMETER	# of FALLS	# OF SAFETY HOOKS	SHIP WEIGHT
4001	2,000	8	1/4"	1	2	23 lbs.
4002	4,000	10	1/4"	1	2	30 lbs.
4003	6,000	10	3/8"	2	2	50 lbs.
4005	10,000	10	5/16"	2	2	91 lbs.

1-1/2 TON 3,000 LB. LEVER HOIST MODEL 4008

- Durable steel frame
- Lightweight and easy to use
- Guide slots to guard against jamming or slippage
- 1/4" link chain
- Includes two safety hooks
- Lift is 5 ft.
- 1 Fall
- Ship weight 25 lbs.



CABLE PULLER MODEL 30400

- 8,000 lb. capacity
- 3/16" cable diameter
- 5.5' cable length
- Ship weight 14 lbs.



CABLE PULLER MODEL 30200

- 4,000 lb. capacity
- 3/16" cable diameter
- 5' cable length
- Ship weight 7 lbs.

- Ideal for lifting, lowering, pulling, and stretching applications
- Hardened steel pivot points for extra strength
- Forged safety hooks included

American Forge & Foundry's Super Duty air tools include some of the most advanced options available to the professional end user today. Powerful torque ratings combined with lightweight design, low noise, and advanced ergonomics make these the tool of choice in many tire and industrial shops.

3/8" DRIVE AIR RATCHET

MODEL 7011

- Slim low profile ratchet head and long neck design permits better access in tight work areas
- Ergonomic handle with vibration absorbing cover for increased comfort and control
- Engineered with quiet noise reduction technology
- Variable speed control with fully recessed throttle for easy grip
- Handle exhaust is directed away from operator

7011 SPECIFICATIONS:

- Square Drive: 3/8"
- Max. Torque (ft/lbs) - Reverse: 50
- Working Torque (ft/lbs) - Reverse: 10-150
- Free Speed (RPM): 150
- Avg. Air Consumption (cfm): 4
- Overall Length: 10-1/4"
- Min. Hose Size: 3/8"
- Air Inlet (NPT): 1/4"
- Sound Pressure (dBA): 79
- Product Weight: 2.6 lbs

1/2" DRIVE AIR RATCHET

MODEL 7021

7021 SPECIFICATIONS:

- Square Drive: 1/2"
- Max. Torque (ft/lbs) - Reverse: 50
- Working Torque (ft/lbs) - Reverse: 10-150
- Free Speed (RPM): 150
- Avg. Air Consumption (cfm): 4
- Overall Length: 10-1/4"
- Min. Hose Size: 3/8"
- Air Inlet (NPT): 1/4"
- Sound Pressure (dBA): 79
- Product Weight: 2.6 lbs



SPECIFICATIONS

Item #	Square Drive	Anvil	Max Torque ft/lbs.	Working Torque	RPM	Air Consump.	Length	Min.Hose size	Air Inlet (NPT)	dBa	Item Wt. (lbs.)
7640	3/8"	-----	430	25-250	11000	4	6"	3/8"	1/4"	83	2.6
7667	1/2"	-----	820	50-580	7000	4	7-3/16"	3/8"	1/4"	83	4.0
7668	1/2"	2"	820	50-580	7000	4	9-1/4"	3/8"	1/4"	83	4.4
7675	3/4"	-----	1500	200-1200	5500	7	8-1/2"	1/2"	3/8"	90	7.5
7687	1"	6"	2200	400-1650	5000	10	20"	1/2"	1/2"	93	26.2
7688	1"	6"	1800	200-1500	6000	10	18-3/4"	1/2"	1/2"	96	15.9

3/8" AIR IMPACT WRENCH

MODEL 7640

- Composite motor housing provides lightweight design
- Engineered with quiet noise reduction technology
- Twin hammer mechanism provide a powerful yet smooth and balanced blow for reduced vibration
- One hand forward/reverse operation provides three forward and three reverse speeds
- Handle exhaust is directed away from the operator



1/2" AIR IMPACT WRENCH

MODEL 7667

- Composite motor housing provides lightweight design
- Engineered with quiet noise reduction technology
- Twin hammer mechanism provide a powerful yet smooth and balanced blow for reduced vibration
- One hand forward/reverse operation provides three forward and three reverse speeds
- Handle exhaust is directed away from the operator



1/2" AIR IMPACT WRENCH WITH 2" EXTENDED ANVIL

MODEL 7668

- Constructed with a 2" inch extended anvil for easy access to recessed lug nuts
- Engineered with quiet noise reduction technology
- Twin hammer mechanism provide a powerful yet smooth and balanced blow for reduced vibration
- One hand forward/reverse operation provides three forward and three reverse speeds
- Handle exhaust is directed away from the operator

SD SUPER DUTY



3/4" AIR IMPACT WRENCH

MODEL 7675

- Composite motor housing provides lightweight design
- Engineered with quiet noise reduction technology
- Twin hammer mechanism provide a powerful yet smooth and balanced blow for reduced vibration
- One hand forward/reverse operation provides three forward and three reverse speeds
- Handle exhaust is directed away from the operator

SD SUPER DUTY



1" D-HANDLE AIR IMPACT WRENCH

MODEL 7687

- 2,200 ft/lbs of unsurpassed nut busting torque
- Constructed with 6" extended anvil for easy access to recessed lug nuts
- Twin hammer mechanism provide a powerful yet smooth and balanced blow for reduced vibration
- Reinforced aluminum motor housing for added durability
- Angled "D" handle provides added ergonomics and stability
- Handle exhaust is directed away from the operator

SD SUPER DUTY



1" ULTRA-LIGHTWEIGHT AIR IMPACT WRENCH WITH 6" EXTENDED ANVIL

MODEL 7688

- Ultra-light 15.9 lb design is ideal for mobile applications
- Produces 1,800 ft/lbs max torque
- Constructed with 6" extended anvil for easy access to recessed lug nuts
- Twin hammer mechanism provide a powerful yet smooth and balanced blow for reduced vibration
- Angled "D" handle provides added ergonomics and stability
- Forward and reverse valve is equipped with three position throttle settings
- Air inlet screen for extended motor life

SD SUPER DUTY



3/8" DRIVE AIR RATCHET

MODEL 7010

- Ideal for exhaust system work, air conditioner, water and fuel pump, and general engine and body shop work
- Fast 150 RPM head and powerful torque output
- Ball type socket retainer allows for quick socket changes
- Durable aluminum housing
- Intake screen protects motor for extended shop life

1/2" DRIVE AIR RATCHET

MODEL 7020

SPECIFICATIONS:

- Max torque by hand (reverse): 70 ft-lbs
- Max torque by air (reverse): 50 ft-lbs
- Free Speed (RPM): 150
- Avg. Air Consumption (cfm): 4
- Overall length: 10-1/4"
- Min. Hose Size: 3/8"
- Air Inlet (NPT): 1/4"
- Product Weight: 2.46 lbs



3/8" REVERSIBLE DRILL

MODEL 7200

- Steel planetary gears for long service life
- Convenient one-hand forward/reverse switch
- 3/8" Jacobs Chuck

SPECIFICATIONS:

- Chuck Capacity: 3/8"
- Horsepower: .33
- Free Speed (RPM): 2,200
- Avg. Air Consumption (cfm): 4
- Overall Length: 6-3/4"
- Min. Hose Size: 3/8"
- Air Inlet (NPT): 1/4"
- Spindle Size: 3/8"-24
- Reversible: Yes
- Sound Pressure (dBA): 86,8
- Product Weight: 2.75 lbs



3/8" REVERSIBLE ANGLE HEAD DRILL - HEAVY DUTY

MODEL 7205

- Low profile 90 degree angle head for use in confined areas
- Rear exhaust, teasing throttle, and lube port on gear head
- 3/8" Jacobs Chuck

SPECIFICATIONS:

- Chuck Capacity: 3/8"
- Horsepower: .33
- Free Speed (RPM): 1,700
- Avg. Air Consumption (cfm): 4
- Overall Length: 8-1/4"
- Min. Hose Size: 3/8"
- Air Inlet (NPT): 1/4"
- Spindle Size: 3/8"-24
- Reversible: Yes
- Sound Pressure (dBA): 86
- Product Weight: 2.42 lbs



1/2" REVERSIBLE ANGLE HEAD DRILL - HEAVY DUTY

MODEL 7210

- Heavy duty motor provides exceptional power
- Side handle for maximum control and safety
- Convenient one-handed fwd/rev switch

SPECIFICATIONS:

- Chuck Capacity: 1/2"
- Horsepower: .4
- Free Speed (RPM): 800
- Overall Length: 9-1/2"
- Avg. Air Consumption (cfm): 4
- Overall length: 9-1/2"
- Min. Hose Size: 3/8"
- Air Inlet (NPT): 1/4"
- Spindle Size: 3/8"-24
- Reversible: Yes
- Sound Pressure (dBA): 83.3
- Product Weight: 4.8 lbs



1/2" AIR IMPACT WRENCH
MODEL 7660

- Aluminum hammer casing for greater durability and protection
- Convenient forward/reverse switch for quick directional changes
- Adjustable throttle settings for maximum control
- Hammer and anvil constructed of special tungsten and titanium alloy to provide greater service life

SPECIFICATIONS:

- 7660: Short Anvil
- 7665: 2" Extended Anvil
- Max. Torque (ft/lbs) - Reverse: 550
- Working Torque (ft/lbs) - Reverse: 25-550
- Free Speed (RPM): 7,000
- Avg. Air Consumption (cfm): 8
- Overall Length: 7"
- Min. Hose Size: 3/8"
- Air Inlet (NPT): 1/4"
- Sound Pressure (dBA): 90
- Product Weight: 5.5 lbs



3/4" AIR IMPACT WRENCH
MODEL 7670

- Aluminum hammer casing for greater durability and protection
- Convenient forward/reverse switch for quick directional changes
- Three forward and one reverse speed for maximum control
- Hammer and anvil constructed of special tungsten and titanium alloy to provide greater service life

SPECIFICATIONS:

- Square Drive: 3/4"
- Max. Torque (ft/lbs) - Reverse: 956
- Working Torque (ft/lbs) - Reverse: 360-390
- Free Speed (RPM): 5,000
- Avg. Air Consumption (cfm): 7
- Overall Length: 9-1/2"
- Min. Hose Size: 1/2"
- Air Inlet (NPT): 3/8"
- Sound Pressure (dBA): 92
- Product Weight: 10.25 lbs



1" D-HANDLE AIR IMPACT WRENCH
MODEL 7685

- Produces 1,912 ft-lbs of hard hitting torque
- Rocking dog hammer mechanism for power and durability
- 6" extended anvil for easier reach
- Three forward and three reverse speeds for maximum control
- Ideal for agricultural and general shop applications

SPECIFICATIONS:

- Square Drive: 1" with 6" extended anvil
- Max. Torque (ft/lbs) - Reverse: 1,912
- Working Torque (ft/lbs) - Reverse: 1,500-1,650
- Free Speed (RPM): 4,000
- Avg. Air Consumption (cfm): 10
- Overall Length: 21-1/4"
- Min. Hose Size: 1/2"
- Air Inlet (NPT): 1/2"
- Sound Pressure (dBA): 103
- Product Weight: 28.7 lbs



.3HP 1/4" MINI DIE GRINDER

MODEL 7150

- Long service life features: steel end plate inserts, brass collar, reinforced air inlet and cylinder made of higher quality steel
- Mini length housing and lever throttle control with roller
- Rear exhaust and built in air regulator

SPECIFICATIONS:

- Collet size: 1/4"
- Free Speed (RPM): 25,000
- Avg. Air Consumption (cfm): 4
- Overall Length: 6-3/16"
- Min. Hose Size: 3/8"
- Air Inlet (NPT): 1/4"
- Sound Pressure (dBA): 90
- Product Weight: .85 lbs



.3HP 1/4" MINI DIE GRINDER - 90° ANGLED HEAD

MODEL 7151

- Mini length housing with angled head Long service life features: steel end plate inserts, brass collar, reinforced air inlet and cylinder made of higher quality steel
- Lever throttle control with roller
- Rear exhaust and built in air regulator

SPECIFICATIONS:

- Collet size: 1/4"
- Free Speed (RPM): 18,000
- Avg. Air Consumption (cfm): 5
- Overall length: 5-3/16"
- Min. Hose Size: 3/8"
- Air Inlet (NPT): 1/4"
- Sound Pressure (dBA): 103
- Product Weight: 1.05 lbs



.6HP 1/4" HEAVY DUTY MINI DIE GRINDER

MODEL 7160

- Powerful .6HP motor
- Motor shaft features ball bearings front and back, and motor end plates are made from durable diecast aluminum
- Insulating vinyl cover wraps aluminum case for comfort
- Lever throttle control with roller tip
- Ideal for most heavy duty industrial applications

SPECIFICATIONS:

- Collet size: 1/4"
- Free Speed (RPM): 20,000
- Avg. Air Consumption (cfm): 4.5
- Overall length: 5-3/4"
- Min. Hose Size: 3/8"
- Air Inlet (NPT): 1/4"
- Sound Pressure (dBA): 95
- Product Weight: 1.35 lbs



.6HP 1/4" HEAVY DUTY MINI DIE GRINDER - 90° ANGLED HEAD

MODEL 7161

- Powerful .6HP motor with angled head for greater versatility
- Motor shaft features ball bearings front and back, and motor end plates are made from durable diecast aluminum
- Insulating vinyl cover wraps aluminum case for comfort. Lever throttle control with roller tip
- Ideal for most heavy duty industrial applications

SPECIFICATIONS:

- Collet size: 1/4"
- Free Speed (RPM): 14,500
- Avg. Air Consumption (cfm): 5
- Overall length: 7-1/2"
- Min. Hose Size: 3/8"
- Air Inlet (NPT): 1/4"
- Sound Pressure (dBA): 95
- Product Weight: 2 lbs



.6HP 1/4" HEAVY DUTY MINI DIE GRINDER - 6" EXTENDED

MODEL 7162

- Powerful .6HP motor with extended nose for greater reach
- Motor shaft features ball bearings front and back, and motor end plates are made from durable diecast aluminum
- Insulating vinyl cover wraps aluminum case for comfort
- Lever throttle control with roller tip
- Ideal for most heavy duty industrial applications

SPECIFICATIONS:

- Collet size: 1/4"
- Free Speed (RPM): 20,000
- Avg. Air Consumption (cfm): 4.5
- Overall length: 12"
- Min. Hose Size: 3/8"
- Air Inlet (NPT): 1/4"
- Sound Pressure (dBA): 93
- Product Weight: 2.72 lbs



4" ANGLE GRINDER

MODEL 7100

- Light weight and compact design with a heavy duty .8HP motor
- Durable aluminum housing with side handle for extra control
- Self-locking throttle lever prevents accidental start-ups
- Includes: wheel guard, wrenches, and grinding wheel

SPECIFICATIONS:

- Wheel Diameter: 4"
- Free Speed (RPM): 11,000
- Avg. Air Consumption (cfm): 6
- Overall length: 8.75"
- Min. Hose Size: 3/8"
- Air Inlet (NPT): 1/4"
- Sound Pressure (dBA): 91
- Product Weight: 4 lbs



American Forge & Foundry has a growing line of hand tools, torque tools, and accessories to serve the Automotive, Industrial, and MRO markets. Each tool is carefully designed and manufactured using superior materials and workmanship in order to ensure the highest productivity and performance standards.

Invincible Handle Hammers

- Spring steel rods encased in vulcanized rubber provide the ultimate striking tool handle
- Drop forged heads are induction hardened for superior durability
- Patented steel locking plate makes head separation impossible
- Handle absorbs impact and vibration reducing user fatigue
- Hi-visibility head provides instant identification on any job site
- Steel reinforced lanyard hole reduces change of slippage
- Copper head series resists sparking and minimizes damage to the work area

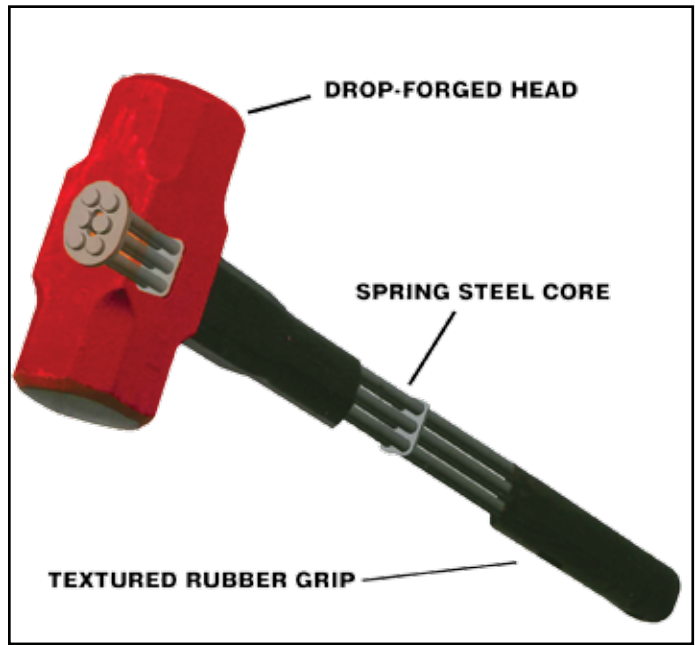

MODEL	TYPE	HEAD WEIGHT (lbs)	PRODUCT WEIGHT (lbs)	HANDLE LENGTH (inches)	SHIP WEIGHT (lbs)
50100	Club	2.50	3.85	12	4.00
50105	Club	4.00	5.25	12	5.25
50110	Club	4.00	5.75	16	5.75
50206	Sledge	6.00	8.70	16	9.00
50208	Sledge	8.00	10.00	16	10.20
50210	Sledge	8.00	11.10	24	11.50
50220	Sledge	8.00	12.00	30	12.20
50222	Sledge	8.00	13.00	36	13.20
50224	Sledge	12.00	17.50	36	18.00
50230	Sledge	14.00	18.50	30	18.20
50300	Ball Pein	2.50	2.90	16	2.90
50400	Cross Pein	3.50	5.10	16	5.10
50107	Copper Club	4.00	5.75	12	5.75
50217	Copper Sledge	8.00	11.50	24	11.50
50237	Copper Sledge	14.00	18.20	30	18.20



Heavy Duty Dead Blow Hammers

- Steel shot filled canister creates a “dead blow effect” to absorb the shock of impact.
- Hammer sustains impact, maximizes force, and eliminates rebound
- One-piece urethane construction will not spark, absorb liquid, or damage the work area
- Steel reinforced handle provides added strength and safety by eliminating breakage
- Reduces noise when striking metal objects such as slugging/striking wrenches
- Red color provides high visibility
- Ball Pein style ideal for punches and chisels as well as shaping and straightening unhardened metals



MODEL	TYPE	HEAD WEIGHT (lbs)	PRODUCT WEIGHT (lbs)	HANDLE LENGTH (inches)	SHIP WEIGHT (lbs)
50500	Standard Head	1.00	1.08	11.00	1.08
50501	Standard Head	1.50	1.64	12.00	1.64
50502	Standard Head	2.25	2.39	13.50	2.39
50503	Standard Head	3.00	3.20	16.75	3.20
50504	Standard Head	6.00	6.47	20.00	6.47
50505	Sledge Head	10.00	11.13	30.00	11.13
50506	Sledge Head	12.00	12.68	36.50	12.68
50601	Ball Pein	1.50	2.39	13.00	2.39

1/2" DRIVE 5 PC TORQUE LIMITING EXTENSION SET

MODEL 40012

- Prevents overtightening or uneven tightening of lug nuts
- Spring steel design stops turning once preset torque is reached
- Reduces risk of wheel and brake rotor damage
- Laser etched with size and torque rating for easy identification
- Includes carrying case for easy storage and organization
- Ship weight 3.25 lbs



INCLUDES:

MODEL	COLOR	FT/LB
40065	Yellow	65
40080	Blue	80
40100	Gray	100
40120	White	120
40140	Lt. Blue	140

1/2" DRIVE 10 PC METRIC/SAE MASTER TORQUE LIMITING SOCKET SET

MODEL 40200

- Prevents overtightening or uneven tightening of lug nuts
- Spring steel design stops turning once preset torque is reached
- Reduce risk of wheel and brake rotor damage
- Solid one piece construction
- Laser etched with size and torque rating for easy identification
- Includes carrying case for easy storage and organization
- Ship weight: 32 lbs



INCLUDES:

MODEL	COLOR	SIZE	FT/LB
40205	Green	17mm	55
40210	Red	17mm	80
40215	Yellow	19mm-3/4"	65
40220	Blue	19mm-3/4"	80
40225	Lt. Brown	21mm	80
40230	Brown	13/16"	100
40235	Gray	19mm-3/4"	100
40240	White	22mm-7/8"	120
40245	Turquoise	22mm-7/8"	140
40250	Lt. Green	24mm-15/16"	140

NEW PRODUCT!



3/4" DRIVE 4 PC TORQUE LIMITING SOCKET SET

MODEL 40300

- Prevents overtightening or uneven tightening of lug nuts
- Spring steel design stops turning once preset torque is reached
- Reduce risk of wheel and brake rotor damage
- Solid one piece construction
- Laser etched with size and torque rating for easy identification
- Includes carrying case for easy storage and organization
- Ship weight: 16.17 lbs



INCLUDES:

MODEL	COLOR	SIZE	FT/LB
40301	Red	1-1/4"	250
40302	Brown	33mm-1-5/16"	475
40303	Black	1-1/2"	475
40304	Yellow	13/16"	475

1" DRIVE 4 PC TORQUE LIMITING SOCKET SET

MODEL 40400

- Prevents overtightening or uneven tightening of lug nuts
- Spring steel design stops turning once preset torque is reached
- Reduce risk of wheel and brake rotor damage
- Solid one piece construction
- Laser etched with size and torque rating for easy identification
- Includes carrying case for easy storage and organization
- Ship weight: 18.37 lbs



INCLUDES:

MODEL	COLOR	SIZE	FT/LB
40401	Red	1-1/4"	250
40402	Brown	33mm-1-5/16"	475
40403	Black	1-1/2"	475
40404	Yellow	13/16"	475

1" DRIVE 33MM 550 FT/LB TORQUE LIMITING SOCKET

MODEL 40405

- Prevents overtightening or uneven tightening of lug nuts
- Spring steel design stops turning once preset torque is reached
- Reduce risk of wheel and brake rotor damage
- Solid one piece construction
- Laser etched with size and torque rating for easy identification
- Ship weight 4.50 lbs.

NEW PRODUCT!



MODEL	COLOR	SIZE	FT/LB
40405	Gray	33mm	550

Ratcheting Torque Wrenches

- Accurate in clockwise direction +/- 4% from 20% to 100% of full scale and includes certificate of calibration
- Conforms to the accuracy requirements of the American Standards Institute ASME B107.14-1194, BSEN 26789:1994, ISO 6789-1992, DIN 3122, and U.S. Government Specification GGG-W-00686C
- Perceptible jolt and audible click indicate desired torque setting has been reached
- Locking collar prevents accidental setting adjustment
- Pliable handle grip for superior comfort and oil resistance
- Rubber seal between the ratchet head and tube keeps lubrication in and contaminants out
- Includes protective blow mold case for easy storage

NEW PRODUCT!



1/4" DRIVE TORQUE WRENCH

MODEL 41050



Primary Scale Range	Secondary Scale Range	Tooth Count	Head Thickness	Head Width	Overall Length	Weight (lbs)
40-250 in/lbs	5-28Nm	24	0.44"	1.14"	13.75"	1.63

3/8" DRIVE TORQUE WRENCH

MODEL 41051



Primary Scale Range	Secondary Scale Range	Tooth Count	Head Thickness	Head Width	Overall Length	Weight (lbs)
15-80 ft/lbs	20-108Nm	24	0.58"	1.44"	15.25"	2.11

1/2" DRIVE TORQUE WRENCH

MODEL 41052



Primary Scale Range	Secondary Scale Range	Tooth Count	Head Thickness	Head Width	Overall Length	Weight (lbs)
30-150 ft/lbs	40-203Nm	24	0.64"	1.85"	21.00"	3.75

1/2" DRIVE TORQUE WRENCH

MODEL 41053



Primary Scale Range	Secondary Scale Range	Tooth Count	Head Thickness	Head Width	Overall Length	Weight (lbs)
50-250 ft/lbs	67-339Nm	24	0.76"	1.85"	25.50"	5.60

3/4" DRIVE TORQUE WRENCH

MODEL 41054



Primary Scale Range	Secondary Scale Range	Tooth Count	Head Thickness	Head Width	Overall Length	Weight (lbs)
100-600 ft/lbs	135-813Nm	24	1.04"	2.85"	43.00"	13.07

1" DRIVE TORQUE WRENCH

MODEL 41055



Primary Scale Range	Secondary Scale Range	Tooth Count	Head Thickness	Head Width	Overall Length	Weight (lbs)
100-700 ft/lbs	135-949Nm	24	1.04"	2.85"	48.00"	14.21

WHEEL BEARING LOCKNUT SOCKETS

- For use with a ratchet or breaker bar
- Fits hexagonal 6 point, hexagonal rounded 6 point, and octagonal 8 point
- Machine welded 3/4" drive plate
- High tensile strength steel for added durability in high volume applications
- Laser etching for permanent identification and easy reading
- Chamfered edge design for easy on/off transition
- Powder coat finish provides added rust protection
- Precision engineered for exact fit and smooth operation
- Each socket individually boxed and labeled with bar code



MODEL	SIZE	MODEL	SIZE	MODEL	SIZE
18501	2-3/32"(6pt.)	18514	4" (6pt.)	18527	3-13/16" (8pt.)
18502	2-3/8"(6pt.)	18515	4-1/8" (6pt.)	18528	2-9/16"(6pt)
18503	2-3/8"(8pt.)	18516	4-3/8"(6pt.)	18532	2-7/8"(6pt.)
18504	2-9/16" (6pt.)	18517	4-3/8"(8pt.)	18533	2-7/8"(8pt)
18505	2-9/16" (8pt.)	18518	4-7/8"(6pt.)	18534	3-1/8"(6pt.)
18506	3" (6pt.)	18519	4-7/8"(8pt.)	18535	3-1/8"(8pt.)
18507	3" (8pt.)	18520	2-1/4" (6pt.)	18536	2-3/8"(6R)
18508	3-1/4" (6pt.)	18521	2-1/2"(6pt.)	18537	2-3/4"(8pt.)
18509	3-1/4" (8pt.)	18522	2-5/8" (6pt.)	18538	4-1/2"(8pt.)
18510	3-1/2" (6pt.)	18523	2-3/4" (6pt.)	18539	5-1/4"(6pt.)
18511	3-1/2"(8pt.)	18524	3-3/8" (8pt.)	18540	4-1/8"(8pt.)
18512	3-7/8"(6pt.)	18525	3-3/4" (8pt.)	18541	4-13/16"(8pt.)
18513	3-7/8"(8pt.)	18526	3-3/4" (6pt.)		

COMBINATION 2 AND 3 JAW REVERSIBLE GEAR PULLERS

Model 57000, 57001, 57002, 57003

- Reversible jaw design allows for internal or external pulling
- Includes 3 jaws for maximum stability or can be converted to 2 jaws where space is limited
- Jaws, yoke, and forcing screw made of heat treated Chrome Vanadium for ultimate strength
- Ideal for use with crankshaft pulleys and other Heavy Duty and Automotive applications
- Forcing screw can be tightened with a wrench or ratchet



MODEL	DESCRIPTION	REACH	SPREAD	CAPACITY	SHIP WEIGHT
57000	3" Gear Puller	3-1/4"	4-3/4"	2 ton	2.20 lbs
57001	4" Gear Puller	3-1/4"	7"	5 ton	3.25 lbs
57002	6" Gear Puller	5-1/2"	7"	5 ton	4.00 lbs
57003	8" Gear Puller	5-1/2"	9-1/2"	3 ton	7.17 lbs



MAGNETIC PARTS TRAY CIRCULAR

MODEL 920

- Prevents loss of sockets, bits, bolts, and nuts
- Retracts down to 1-1/4" for easy storage
- Rubber cover provides scratch resistance
- Works upside down
- Dimensions: 5" length x 6" wide
- Ship weight .28 lbs



MAGNETIC PARTS TRAY OVAL

MODEL 921

- Prevents loss of sockets, bits, bolts, and nuts
- Retracts down to 1-3/8" for easy storage
- Rubber cover provides scratch resistance
- Works upside down
- Dimensions: 12" length x 9" wide
- Ship weight 1.32 lbs



AFF 5 GALLON BUCKET

MODEL AFFBUCKET

- Durable plastic construction
- Provides general storage for a variety of items
- Equipped with a strong metal handle
- Locking lid included
- Ship weight 2.0 lbs



American Forge & Foundry Super Duty Shop Presses are constructed with a fully welded frame and heavier gauge steel for exceptional strength and durability. A lateral head adjuster provides smooth side to side movement of the press head which adds versatility that you won't find with other standard duty shop presses. Optimal use of shop press is 80% of rated capacity or less.

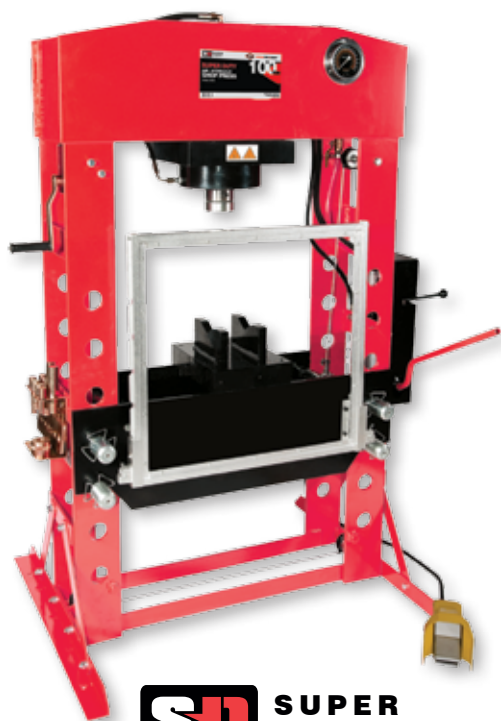

**100 TON SUPER-DUTY SHOP PRESS
MODEL 859ASD**

- Shatter resistant polycarbonate guard for added operator safety
- Includes 2 pc press plate set and 10 pc pin and bearing press adapter set
- Dual air motor operation for faster pressing process
- Large liquid filled glycerin gauge accurately shows pressing force
- Heavy duty cable winch system for effortless bed adjustment
- Air pressure 110-120 PSI

**75 TON SUPER-DUTY SHOP PRESS
MODEL 856ASD**

- Shatter resistant polycarbonate guard for added operator safety
- Includes 2 pc press plate set and 10 pc pin and bearing press adapter set
- Dual air motor operation for faster pressing process
- Large liquid filled glycerin gauge accurately shows pressing force
- Heavy duty cable winch system for effortless bed adjustment
- Air pressure 110-120 PSI

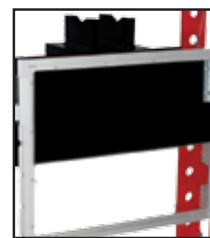
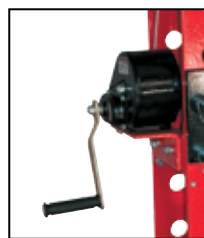
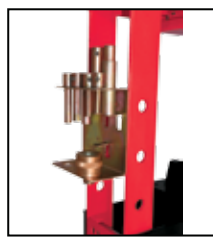

MODEL	CAPACITY (Tons)	RAM STROKE	OVERALL DIMENSIONS	BED DEPTH	BED WIDTH	THROAT DEPTH	THROAT WIDTH	SHIP WEIGHT
859ASD	100	11.58"	55"Wx84"H	13.5"	31"	9"	16.5"	1476 lbs
856ASD	75	9.75"	57"Wx77"H	10.87"	31.5"	8"	19.75"	1030 lbs.



50 TON SUPER DUTY SHOP PRESS

MODEL 854ASD

- Shatter resistant polycarbonate guard for added operator safety
- Includes 2 pc press plate set and 10 pc pin and bearing press adapter set
- Dual air motor operation for faster pressing process
- Large liquid filled glycerin gauge accurately shows pressing force
- Heavy duty cable winch system for effortless bed adjustment
- Air pressure 110-120 PSI



MODEL	CAPACITY (Tons)	RAM STROKE	OVERALL DIMENSIONS	BED DEPTH	BED WIDTH	THROAT DEPTH	THROAT WIDTH	SHIP WEIGHT
854ASD	50	7.75"	54"Wx75"H	10.125"	28.75"	7.25"	16.75"	660 lbs.

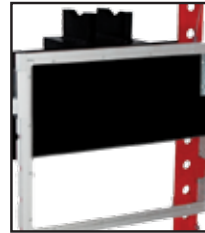
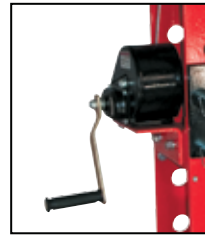

30 TON SUPER-DUTY SHOP PRESS

MODEL 852ASD

- Shatter resistant polycarbonate guard for added operator safety
- Includes 2 pc press plate set and 10 pc pin and bearing press adapter set
- Dual air motor operation for faster pressing process
- Large liquid filled glycerin gauge accurately shows pressing force
- Heavy duty cable winch system for effortless bed adjustment
- Air pressure 110-120 PSI



MODEL	CAPACITY (Tons)	RAM STROKE	OVERALL DIMENSIONS	BED DEPTH	BED WIDTH	THROAT DEPTH	THROAT WIDTH	SHIP WEIGHT
852ASD	30	5.9"	40"Wx71"H	7.25"	21.5"	6.5"	15"	363 lbs.

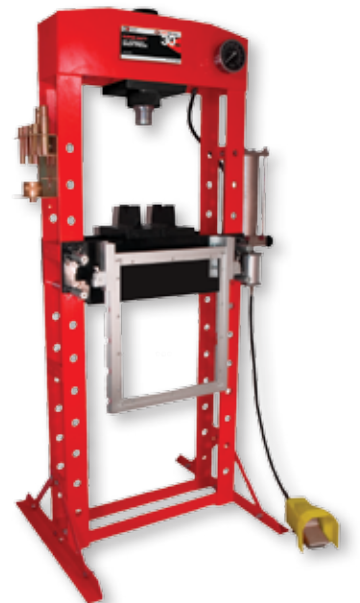
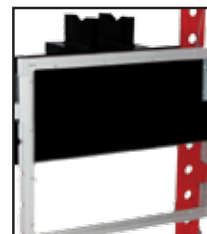
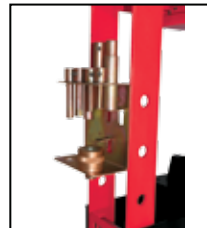

20 TON SUPER-DUTY SHOP PRESS

MODEL 850ASD

- Shatter resistant polycarbonate guard for added operator safety
- Includes 2 pc press plate set and 10 pc pin and bearing press adapter set
- Dual air motor operation for faster pressing process
- Large liquid filled glycerin gauge accurately shows pressing force
- Heavy duty cable winch system for effortless bed adjustment
- Air pressure 110-120 PSI



MODEL	CAPACITY (Tons)	RAM STROKE	OVERALL DIMENSIONS	BED DEPTH	BED WIDTH	THROAT DEPTH	THROAT WIDTH	SHIP WEIGHT
850ASD	20	7.5"	35"Wx64"H	7"	19.25"	5.75"	10.75"	282 lbs.

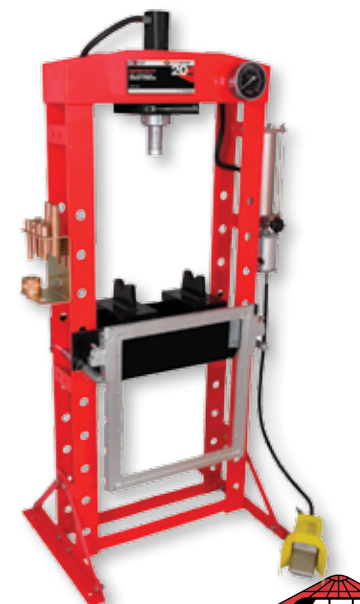
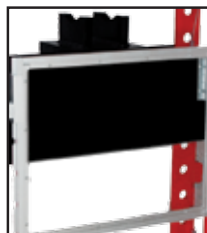
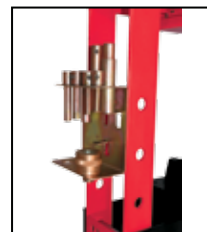

50 TON CAPACITY FLOOR PRESS

MODEL 837

- Ideal for straightening, bending, and removing gears, bearings, and bushings
- Winch operated press bed with 7 adjustment levels
- Includes 2 pressing plates
- Two-speed hand pump provides faster travel to load while air/hydraulic pump allows for effortless operation
- Frame mounted hydraulic pressure gauge



MODEL	CAPACITY (Tons)	RAM STROKE	SPACE INTERVAL	BED RAIL OPENING	POST OPENING	BASE WIDTH	HEIGHT	SHIP WEIGHT
837	50	7"	5.5"	9"	32"	44"	68"	672 lbs.

35 TON CAPACITY FLOOR PRESS

MODEL 834

- Ideal for straightening, bending, and removing gears, bearings, and bushings
- Winch operated press bed with 7 adjustment levels
- Includes 2 pressing plates
- Two-speed hand pump provides faster travel to load while air/hydraulic pump allows for effortless operation
- Frame mounted hydraulic pressure gauge



MODEL	CAPACITY (Tons)	RAM STROKE	SPACE INTERVAL	BED RAIL OPENING	POST OPENING	BASE WIDTH	HEIGHT	SHIP WEIGHT
834	35	6.5"	4.5"	7.5"	24"	30"	66"	312 lbs.

30 TON CAPACITY FLOOR PRESS

MODEL 832A

- Ideal for straightening, bending, and removing gears, bearings, and bushings
- 8 level bed adjustment
- 30 ton bottle jack with overload protection (6-1/2" stroke)
- Heavy duty return springs for fast ram retraction
- Reinforced head plate



MODEL	CAPACITY (Tons)	RAM STROKE	SPACE INTERVAL	BED RAIL OPENING	POST OPENING	BASE WIDTH	HEIGHT	SHIP WEIGHT
832A	30	6.5"	4.5"	7.25"	22.5"	30"	66"	405 lbs.



20 TON CAPACITY FLOOR PRESS

MODEL 820A

- Ideal for straightening, bending, and removing gears, bearings, and bushings
- 8 level bed adjustment
- 20 ton bottle jack with overload protection (8-1/2" stroke)
- Heavy duty return springs for fast ram retraction
- Reinforced head plate

MODEL	CAPACITY (Tons)	RAM STROKE	SPACE INTERVAL	BED RAIL OPENING	POST OPENING	BASE WIDTH	HEIGHT	SHIP WEIGHT
820A	20	8.5"	4.5"	7.25"	22.5"	27"	61"	280 lbs.

12 TON CAPACITY FLOOR PRESS

MODEL 812

- Designed for light duty applications
- 7 level bed adjustment
- Heavy duty return springs for fast ram retraction

MODEL	CAPACITY (Tons)	RAM STROKE	SPACE INTERVAL	BED RAIL OPENING	POST OPENING	BASE WIDTH	HEIGHT	SHIP WEIGHT
812	12	6.75"	3.5"	3"	16"	20"	70"	112 lbs.

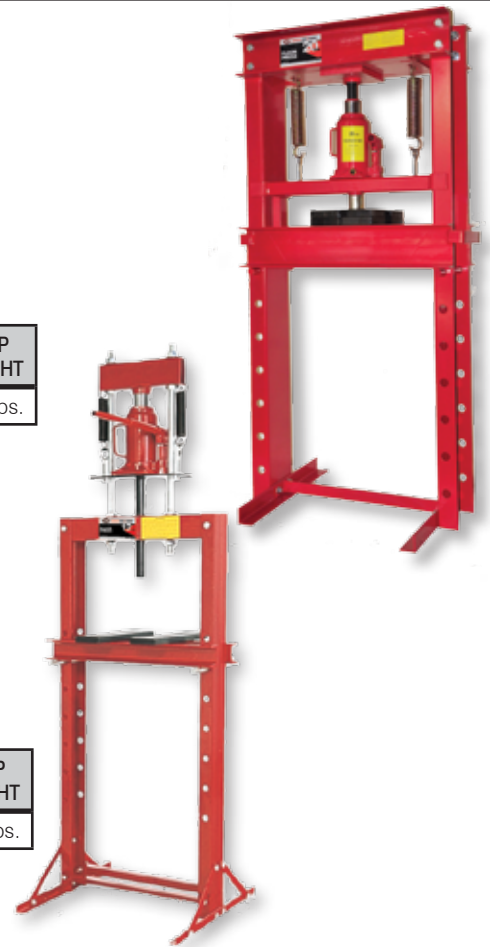

REPLACEMENT ARBOR PLATES

MODEL 812K20

Arbor plate fits Model 812 12-ton Floor Press
Ship weight 12 lbs.

MODEL 820AK7

Pair of arbor plates fits Model 820A 20-ton Floor Press
Ship weight 51 lbs.

MODEL 832AK12

Pair of arbor plates fits Model 832A 30-ton Floor Press
Ship weight 99 lbs.

MODEL 820AK7



MODEL 832AK12



INDIVIDUAL POLYCARBONATE PROTECTIVE SHOP PRESS GUARDS

- Shatter resistant polycarbonate material provides maximum protection against shrapnel and other debris
- No additional hardware needed if you have an existing AFF brand Super Duty Shop Press
- Fits the following AFF Shop Presses: 850SD, 850ASD, 852SD, 852ASD, 854SD, 854ASD, 856SD, 856ASD, 859SD, and 859ASD

MODEL 850ASD-P

- Polycarbonate guard for Models 850SD and 850ASD 20 Ton Shop Press

MODEL 852ASD-P

- Polycarbonate guard for Models 852SD and 852ASD 30 Ton Shop Press

MODEL 854ASD-P

- Polycarbonate guard for Models 854SD and 854ASD 50 Ton Shop Press

MODEL 856ASD-P

- Polycarbonate guard for Models 856SD and 856ASD 75 Ton Shop Press

MODEL 859ASD-P

- Polycarbonate guard for Models 859SD and 859ASD 100 Ton Shop Press

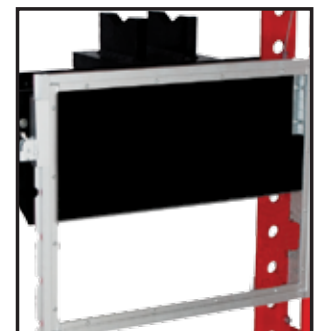

NEW PRODUCT!



2 SHELF POLYPROPYLENE SHOP CART

MODEL 961

- 5" x 1" casters (2 swivel, 2 fixed)
- Convenient organizer tray
- Super strong polypropylene
- 500 lb. overall capacity.
- Tray size: 30"L x 16"W x 3" D
- 39.75"L x 17"W x 33.25"H overall
- Ship weight 40 lbs..



ADD-A-SHELF

MODEL 964

- 36" x 24"
- Ship weight 16 lbs.

2 SHELF POLYPROPYLENE SHOP CART

MODEL 962

- SAME AS ABOVE except:
- Tray size: 36"L x 24"W x 3" D
- 46"L x 25.5"W x 33.25"H overall
- Ship weight 51 lbs.

ADD-A-SHELF

MODEL 963

- 30" x 16"
- Ship weight 13 lbs.

HEAVY DUTY WORKBENCH

MODEL 990

- 10-gauge rolled edge steel work top with 2" retaining wall on sides and back (1750 lb. load capacity)
- Two 12-gauge steel shelves each with a 550 lb. load capacity



*10 Gauge Steel
Powder Coated Finish*

MODEL	WORKTOP CAPACITY	DRAWERS	SHELF CAPACITY	NUMBER SHELVES	LENGTH	WIDTH	HEIGHT	SHIP WEIGHT
990	1750 lbs.	N/A	550 lbs.	2	79"	25.25"	34.5"	275 lbs.

HEAVY DUTY WORKBENCH

MODEL 992

- 10-gauge rolled edge steel work top with 2" retaining wall on sides and back (1750 lb. load capacity)
- Two key lock steel drawers with full extension ball bearing slides
- One 12-gauge steel shelf with a 550 lb. load capacity



*10 Gauge Steel
Powder Coated Finish*

MODEL	WORKTOP CAPACITY	DRAWERS	SHELF CAPACITY	NUMBER SHELVES	LENGTH	WIDTH	HEIGHT	SHIP WEIGHT
992	1750 lbs.	2	550 lbs.	1	59"	25.25"	34.5"	236 lbs.

HEAVY DUTY TEARDOWN TABLE

MODEL 994

- Fluids drain through table top into a removable plastic container
- Comes with locking storage drawer on ball bearing slides
- Multiple shelf location adds versatility
- Square tube leg design adds strength and stability to table top
- Large 4" heavy duty swivel casters (2 locking)
- Table top features 1/2" rim
- Extra heavy duty construction

Tapered table top with drain hole allows convenient fluid drainage into plastic container.



*10 Gauge Steel
Powder Coated Finish*

MODEL	WORKTOP CAPACITY	DRAWERS	SHELF CAPACITY	NUMBER SHELVES	LENGTH	WIDTH	HEIGHT	SHIP WEIGHT
994	1000 lbs.	1	1500 lbs.	1	48"	31"	40"	249 lbs.

5" GENERAL DUTY SWIVEL VISE

MODEL 3941

- Class 30 iron
- 30,000 lb. tensile strength castings
- Precision machined hardened steel jaws (replaceable)
- Built-in pipe jaws
- Machine ground anvil surface
- 360° swivel base with dual lock down handles
- Maximum opening : 5"
- Throat depth: 3"
- Ship weight: 29.7 lbs.



6" GENERAL DUTY SWIVEL VISE

MODEL 3942

- Class 30 iron
- 30,000 lb. tensile strength castings
- Precision machined hardened steel jaws (replaceable)
- Built-in pipe jaws
- Machine ground anvil surface
- 360° swivel base with dual lock down handles
- Maximum opening : 6"
- Throat depth: 3-1.2"
- Ship weight: 44 lbs.



8" GENERAL DUTY SWIVEL VISE

MODEL 3943

- Class 30 iron
- 30,000 lb. tensile strength castings
- Precision machined hardened steel jaws (replaceable)
- Built-in pipe jaws
- Machine ground anvil surface
- 360° swivel base with dual lock down handles
- Maximum opening : 8"
- Throat depth: 4"
- Ship weight: 68.2 lbs.



5" MULTI-PURPOSE SWIVEL VISE

MODEL 3944

- Class 30 iron
- 30,000 lb. tensile strength castings
- Precision machined hardened steel jaws (replaceable)
- Built-in pipe jaws
- Machine ground anvil surface
- 360° swivel base with dual lock down handles
- Maximum opening : 5"
- Throat depth: 2-5/8"
- Ship weight: 35.2 lbs.
-



5" HEAVY DUTY SWIVEL VISE

MODEL 3947

- Extra heavy duty casting provides high clamping force
- Fully enclosed spindle, slide, and screw prevents grit, grime, and other contaminants from entering chamber
- Permanently sealed and lubricated chamber allows years of smooth operation
- Precision machined hardened steel jaws (replaceable)
- 360° swivel base with double lock down handles
- Large anvil work surface
- Maximum opening: 5-1/4"
- Throat depth: 3-3/4"
- Ship weight: 53 lbs



6" HEAVY DUTY SWIVEL VISE

MODEL 3948

- Extra heavy duty casting provides high clamping force
- Fully enclosed spindle, slide, and screw prevents grit, grime, and other contaminants from entering chamber
- Permanently sealed and lubricated chamber allows years of smooth operation
- Precision machined hardened steel jaws (replaceable)
- 360° swivel base with double lock down handles
- Large anvil work surface
- Maximum opening: 6"
- Throat depth: 4"
- Ship weight: 66 lbs



6" BENCH GRINDER

MODEL 31510

- Adjustable steel work rest
- 1 Standard Safety Glass, 1 Magnifying Safety Glass
- Cast aluminum base
- Large flexible work light (bulb not included)
- Water Tray
- Dust proof switch
- 6" Grinder
- 1/2 HP Ball bearing motor 120V, 2.8 Amp 60 Hz
- 1/2" Arbor
- 3/4" Wheel Width
- 3,450 RPM (no load speed)
- Ship weight 21 lbs.



8" BENCH GRINDER

MODEL 31520

- Adjustable steel work rest
- 1 Standard Safety Glass, 1 Magnifying Safety Glass
- Cast aluminum base
- Large flexible work light (bulb not included)
- Water Tray
- Dust proof switch
- 8" Grinder
- 3/4 HP Ball bearing motor 120V, 4.8 Amp 60 Hz
- 5/8" Arbor
- 1" Wheel Width
- 3,450 RPM (no load speed)
- Ship weight 33 lbs.



ADJUSTABLE HEIGHT STAND

MODEL 31500

- Extra large 12" x 10" steel table top reduces vibration and breakage compared to typical cast tops.
- Predrilled slots allow for mounting most bench grinders 5"-10".
- Heavy duty cast iron base predrilled for securing
- Adjustable table height from 28" - 36"
- Ship weight 20 lbs.



FIXED HEIGHT STAND

MODEL 31501

- Extra large 12" x 10" steel table top reduces vibration and breakage compared to typical cast tops.
- Predrilled slots allow for mounting most bench grinders 5"-10".
- Heavy duty cast iron base predrilled for securing
- Height 32"
- Ship weight 23 lbs.



37" CREEPER

MODEL 3905

- Full length, padded, oil-resistant vinyl center panel (1-3/4" thick)
- Additional 1-1/2" thick headrest
- Six 2-1/2" swivel casters
- 37" L x 18" W x only 3-1/2" H
- Ship weight 16 lbs.



Double post caster mounting bolts are stronger, longer lasting and more durable

CREEPER SEAT

MODEL 3906

- Padded, reinforced, oil-resistant vinyl seat (1-3/4" thick)
- Convenient under seat tray keeps tools and small parts handy
- 1" steel tube frame with four 2-1/2" ball bearing casters
- Fully assembled
- 17-1/2" L x 14" W x 14" H
- Ship weight 10 lbs.



AIR PISTON CREEPER SEAT

MODEL 3907

- Padded and reinforced seat
- Air piston allows height adjustment to 18"
- Under seat parts tray keeps tools at hand
- Five 2-1/2" heavy duty casters
- Ship weight 14 lbs



42" HEAVY DUTY MECHANICS CREEPER

MODEL 3908

- Longer and wider for additional working comfort
- Drop frame at shoulder for ease of movement
- Full length, padded, oil-resistant vinyl center panel
- Six heavy duty, dual-post casters
- 42" L x 21" W x 3-1/2" H
- Ship weight 21 lbs.



Double post caster mounting bolts are stronger, longer lasting and more durable

American Forge & Foundry parts washers are designed for fast and efficient cleaning of vehicle parts and sub-assemblies. Each unit includes a fusible linked fire cover for maximum operator safety. Each is designed for use with aqueous water-based cleaners.

7 GALLON PORTABLE PARTS WASHER

MODEL 31350B

- 3-1/2 gallon working capacity
- 45 GPH pump output
- UL listed on complete unit
- 18-1/2" x 13-1/2" x 9" overall dimensions
- Ship weight 18 lbs.



20 GALLON HYDRA-FLOW PARTS WASHER

MODEL 31200B

- 12-gallon working capacity
- 50 GPH pump output
- Removable work shelf and parts basket
- UL listed on complete unit
- 30" x 20-1/2" x 36-1/2" overall dimensions
- Ship weight 62 lbs.



40 GALLON INDUSTRIAL-DUTY PARTS WASHER

MODEL 31400B

- 22 gallon working capacity
- 50 GPH pump output
- Removable work shelf and parts basket
- UL Listed on complete unit
- 45" x 21-1/4" x 35-5/8" overall dimensions
- Ship weight 107 lbs.



FLO-THRU PARTS WASHER BRUSH

MODEL PWBRUSH

- Reduces parts cleaning time by 50%
- 4" long bristles suitable for use with water-based (aqueous) cleaner, as well as petroleum-based product
- Easy attachment fitting
- Fits all AFF parts washers
- 10" L x 1-1/2" W
- Ship weight 2 lbs



POWER MAT

MODEL 3901

- Thick closed cell EVA foam material protects workers from hard and rough surfaces
- Can be used as an anti-fatigue mat, kneeling pad, under car mat, or anywhere a worker needs to be kept off the ground
- Resists absorption of water, oil, and many chemicals
- Ultra-lightweight for easy portability with convenient hand hole for carrying
- Product dimensions: 19-1/4"x11-3/4"x1-3/16"
- Ship weight 16.5 lbs.

NEW PRODUCT!



POWER MAT XL

MODEL 3902

- Thick closed cell EVA foam material protects workers from hard and rough surfaces
- Can be used as an anti-fatigue mat, kneeling pad, under car mat, or anywhere a worker needs to be kept off the ground
- Resists absorption of water, oil, and many chemicals
- Ultra-lightweight for easy portability with convenient hand hole for carrying
- Product dimensions: 43"x19-5/8"x1-3/16"
- Ship weight 23 lbs.

NEW PRODUCT!



3/8" AIR HOSE REEL

MODEL 760

- Mounting base is slotted and roller arm has 5 positions for multiple mounting configurations.
- Heavy steel construction adds durability and longer life cycles
- Rubber air hose with heavy-duty crimping and spring guard ensure longevity
- Automatic return via heavy-duty sealed spring with 8 locking stops, roller guide and ball stop
- 3/8" x 50'
- 1/4" NPT
- 300 PSI maximum pressure
- Ship weight 40 lbs.

1/2" AIR HOSE REEL

MODEL 761

- Same as 760 except:
- 1/2" x 50'
- 1/2" NPT
- 300 PSI maximum pressure
- Ship weight 53 lbs.



American Forge & Foundry offers a wide variety of lubrication tools, drains, and pumps to fit the demanding needs of any Heavy Duty or Automotive professional. Each are engineered with tight fittings, durable components, and quality material for years of trouble free service.

**50:1 AIR OPERATED PORTABLE GREASE UNIT
MODEL 8600A**

- For use with 5-gallon (35 lb.) containers
- 50:1 pump
- 70-100 PSI operating pressure
- Pumps up to 1.76 lbs. per minute
- 82 dB noise level
- Carrying handle
- 13' delivery hose
- 12.20" drum cover
- Control valve
- Ship weight 23 lbs.



REPLACEMENT PUMPS

MODEL 8600AP

- 50:1 Air-operated grease pump only for use with 5-gallon (35 lb.) containers.
- 70-100 PSI operating pressure
- Pumps up to 1.76 lbs. per minute
- 82dB noise level
- Ship weight 12 lbs.

MODEL 8620AP

- 50:1 Air-operated grease pump only for use with 16-gallon (120 lb.) containers.
- Ship weight 14 lbs.

**50:1 AIR OPERATED PORTABLE GREASE UNIT
MODEL 8620A**

- For use with 16-gallon (120 lbs) containers
- 50:1 pump
- 70-100 PSI operating pressure
- Pumps up to 1.76 lbs. per minute
- 82 dB noise level
- 13' delivery hose
- 15.10" drum cover
- 14-1/2" follower plate
- Control valve
- Ship weight 38 lbs.



8620A

**AIR OPERATED PORTABLE GREASE UNIT WITH MODEL 8625 BAND DOLLY
MODEL 8621A**

- Same as 8620A (see specs above)
- Includes 8625 Band Dolly
- Ship weight 38 lbs.

8621A is 8620A+ Band Dolly

**AIR OPERATED PORTABLE GREASE UNIT WITH MODEL 4-WHEEL CART
MODEL 8622A**

- Same as 8620A (see specs above)
- Includes 4-wheel cart
- Ship weight 54 lbs.



8620A

8622A is 8620A+ Cart

PROFESSIONAL DUTY GREASE GUN

MODEL 8000

- 10,000 PSI
- 14 oz. capacity via cartridge suction or bulk loading
- Heavy duty aluminum diecast head
- Bulk loader and air bleeder valve
- Four-jaw coupler with ball check
- Ship weight 4 lbs.



STANDARD GREASE GUN

MODEL 8002

- 8,000 PSI
- Four-jaw coupler with ball check
- 14 oz. capacity via cartridge or suction
- Ship weight 4 lbs.



PISTOL GRIP GREASE GUN

MODEL 8003

- 5,000 PSI with flexible hose
- Comfortable one-hand operation in confined spaces
- Heavy duty aluminum diecast head
- Four-jaw coupler with ball check
- 14 oz. capacity via cartridge or suction
- Ship weight 4 lbs.



COLD WEATHER GREASE GUN

MODEL 8004

- Large grease inlet allows better functionality even in cold weather
- Capacity: 14 oz cartridge or 500cc bulk fill
- 18" high pressure flex hose and 4-jaw coupler
- 7500 PSI
- Ship weight 3.5 lbs.



CONTINUOUS FLOW AIR GREASE GUN

MODEL 8605

- Continuous flow with trigger pressed
- Cartridge, bulk, or suction loading
- 6" ext and 12" hose/coupler included
- 4,800 PSI
- Ship weight 4.5 lbs.



SUCTION GUN

MODEL 8006

- Transfers gear oils into and out of gear boxes, transfer cases and differentials.
- Single piece aluminum diecast head
- 12" flexible vinyl hose
- 16 oz. capacity
- Ship weight 2 lbs.



DELUXE MINI PISTOL GREASE GUN

MODEL 8007

- 3,500 PSI
- One-hand operation
- Aluminum diecast head with front and top discharge ports
- Four-jaw coupler with ball check
- 3 oz. capacity
- Ship weight 5 lbs.



PNEUMATIC GREASE GUN

MODEL 8010

- 4,800 PSI
- 14 oz. capacity via cartridge, suction or bulk loading
- Single shot with every trigger pull
- Heavy-duty aluminum diecast head
- 40:1 pressure ratio
- Four-jaw coupler
- Bulk loader valve
- Ship weight 5 lbs.



18V PROFESSIONAL DUTY GREASE GUN

MODEL 8008A

- 10,000 PSI
- 264 oz./min dispense rate
- 1 Hour quick charger
- Two 18-volt NiCad batteries
- Extra long 42" flex hose
- Holds 14 oz. cartridge
- Comes complete with convenient blow mold case
- Electrical and pressure overload protection
- Ship weight 4 lbs.



PISTOL OIL CAN

MODEL 8040

6 oz. Pistol style



LONG NECK OIL CAN

MODEL 8041

6 oz. Long neck

OIL CAN

MODEL 8042

7 oz. with 4" straight and flexible spouts



OIL CAN

MODEL 8043

10 oz. with 4" straight and flexible spouts

OIL CAN

MODEL 8044

16 oz. with 4" straight and flexible spouts



GREASE FITTING KITS

MODEL 8103 & 8104

- Replacements for broken or damaged grease fittings
- Kit contains 80 individual grease fittings contained in a plastic case.
- Ship weight 1 lbs.

MODEL 8103 (SAE)

Thread spec/contents:
1/8"-25 NPT:

- 25 each straight
- 10 each 45°
- 10 each 90°

1/4"-28 SAE-LT:

- 15 each straight
- 10 each 45°
- 10 each 90°



MODEL 8104 (Metric)

Thread spec/contents:

- M6x1: 20 straight,
10 each 90°
- M8x1: 15 straight,
10 each 90°
- M10x1: 15 straight,
10 each 90°



FLUID TRANSFER GUN

MODEL 8005

- Transfers liquids from one container to another
- 8 ft. of vinyl hose (4 ft. for each valve)
- Suitable for petroleum products
- 16 oz. capacity
- Ship weight 3 lbs.



7 PC LUBRICATION KIT

MODEL 8090

- 8014: Whip hose with quick disconnect (QD) and heavy duty coupler
- 8025: Recessed QD lube adapter
- 8037: Rubber-tipped QD seal-off dispenser
- 8022: 1-1/2" narrow needle adapter (QD)
- 8034: Right angle adapter (QD)
- 8021: 90° adapter (QD)
- 8091: Needle adapter
- Cloth roll up pouch for storage
- Ship weight 2 lbs.



GREASE FITTING UNBLOCKER

MODEL 8100

- Opens clogged grease fittings and loosens hardened grease joints
- Tapping tool with a hammer forces a light viscosity oil into the fitting, breaking up and removing dirt and debris
- Excellent for maintaining bearings, control arms, king pins etc.
- Built-in hand guard for operator protection
- Complete with coupler and flex hose for reaching recessed fittings
- Includes 2 spare piston seals
- Ship weight 1.5 lbs



GREASE GUN WHIP HOSES

MODEL 8012 - 12"

MODEL 8018 - 18"

- For hand-operated grease guns
- 3,500 PSI working pressure
- 11,600 PSI burst pressure
- 1/8" NPT threads



HEAVY DUTY GREASE GUN WHIP HOSES

MODEL 8013 - 12"

MODEL 8019 - 18"

- Heavy duty spring guard for added durability/safety
- For hand-operated grease guns
- 3,500 PSI working pressure
- 11,600 PSI burst pressure
- 1/8" NPT threads



QUICK DISCONNECT GREASE GUN WHIP HOSE

MODEL 8014 - 12"

- Quick disconnect
- Heavy duty coupler
- For hand-operated grease guns
- 3,500 PSI working pressure
- 11,600 PSI burst pressure
- 1/8" NPT threads



HIGH PRESSURE GREASE GUN HOSES

MODEL 8612 - 12"

MODEL 8618 - 18"

- Polyamide inner tube with polyurethane sheathing
- 0.425" outer diameter
- 5,800 PSI working pressure (13,775 PSI burst)
- Zinc-plated end connections
- 1/8" NPT threads



90° LUBE ADAPTER (QD)

MODEL 8021

- Reach hidden fittings in shoulders & confined areas
- 0.24" greasing end diameter
- Locking sleeve
- For hand-operated grease guns only

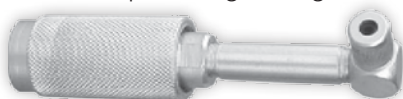

1-1/2" NARROW NEEDLE ADAPTER (QD)

MODEL 8022

- Reach flush or hidden fittings
- 0.156" needle diameter
- Locking sleeve
- For hand-operated grease guns only



GREASE CONTROL VALVE

MODEL 8698

- Continuous grease flow with trigger depressed
- 1/4" NPT (f) inlet and 1/8" NPT (f) outlet threads
- For power lube equipment
- Ship weight 2 lbs.



360° "Z" SWIVELS 1/4" NPT (m) x 1/2" 27 (m)

MODEL 8686

360° "Z" SWIVELS 1/4" NPT (m) x 1/4" NPT (m)

MODEL 8687

Heavy-duty steel installed between delivery hose and grease control valve prevents hose twisting

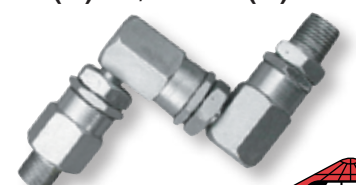

4" NEEDLE ADAPTER (QD)

MODEL 8023

- Dispense a fine line of grease
- For hand-operated grease guns only



QUICK DISCONNECT (QD) ADAPTER

MODEL 8024

- Grease fitting on one end and 1/8" NPT threads on the other
- For hand-operated grease guns only

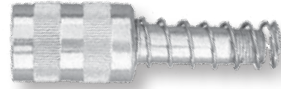

RECESSED LUBE ADAPTER (QD)

MODEL 8025

- For recessed fittings where hydraulic couplers can't reach
- Cup-shaped 0.22" diameter tip
- 0.31" body diameter, 3.15" length
- Locking sleeve
- For hand-operated grease guns only



BULK LOADER VALVE

MODEL 8026

- Replacement valve for hand-operated grease guns only



1-1/2" NEEDLE ADAPTER

MODEL 8027

- Use to dispense a fine line of grease
- Reach flush or hidden hydraulic type fittings
- For hand-operated grease guns only
- 1/8" NPT threads



NEEDLE ADAPTERS

MODEL 8028 - 5/8"

- Use to dispense a fine line of grease
- Reach flush or hidden hydraulic type fittings
- For hand-operated grease guns only
- 1/8" NPT threads
- Zinc-plated end connections



NEEDLE ADAPTERS

MODEL 8029 - 6"

- Use to dispense a fine line of grease
- Reach flush or hidden hydraulic type fittings
- For hand-operated grease guns only
- 1/8" NPT threads
- Zinc-plated end connections



GREASE GUN EXTENSION

MODEL 8030

- 6" length
- 1/8" NPT threads



GREASE GUN HOLDER

MODEL 8031

- Snap-action clamp for easy grease gun storage
- Standard (3,000 PSI)



HYDRAULIC COUPLER

MODEL 8032

- Standard (3,000 PSI)



HYDRAULIC COUPLER

MODEL 8033

- Professional (6,000 PSI)
- Four-jaw coupler with ball check
- For hand-operated grease guns only



RIGHT-ANGLE GREASE COUPLER

MODEL 8034

- Polyurethane seal fits perfectly on fittings
- Hardened coupler housing slot provides 90° access
- For hand-operated grease guns only
- 1/8" NPT threads



3-JAW SWIVELING COUPLER

MODEL 8035

- 360° swivel locks in any of eight 45° positions
- Adjustable coupler section
- 7,000 PSI maximum operating pressure



BEARING PACKER

MODEL 8036

- For greasing taper roller bearings with 1/2" min. inner diameter, 5" maximum outside diameter & height from 1/4" to 2"
- For hand operated or power lube equipment



SEAL-OFF DISPENSER

MODEL 8037

- For lubricating cars with grease plugs
- For hand-operated grease guns only
- Threaded 1/8" female NPT

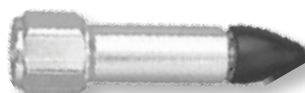

FINE-POINT NEEDLE ADAPTER

MODEL 8091

- For dispensing very fine line of grease
- Sharp point to inject grease into ball joints
- For hand-operated grease guns only



LEVER ACTION BARREL PUMP

MODEL 8055

- For use with: DEF, water based media, detergents, soaps, antifreeze, etc.
- Designed to pump high viscosity oils
- Anti-siphon vent cap
- Delivers 1 pint (500ml) per stroke
- Pump includes suction tube for use with 15-55 gallon drums and a 3'x3/4" flexible discharge hose
- Wetted Components: polyacetal, polypropylene, polyethylene, PVC, Viton
- Ship weight 3.4 lbs



E-Z FLOW 5 GALLON OIL PUMP

MODEL 8060

- Designed for containers with Rieke or regular openings
- High density polyethylene pump head with steel suction tube
- Interchangeable bung adapter
- Rigid steel outlet spout and 48" discharge tube
- Use for transfer of oils, diesel fuel and 100% antifreeze
- Delivers 1 quart per 15 strokes
- Ship weight 2 lbs.



CHEMICAL PUMP - NYLON BODY

MODEL 8064

- Self priming vertical lift pump
- Nylon pump with stainless steel plunger rod and Teflon seals.
- Complete with 2" polypropylene bung adapter
- Excellent for use with lacquer thinners, acetone, antifreeze, brake klean detergents, glycerin, water, etc.
- Fits 15-55 gallon drums
- Delivers 14 oz. per stroke
- DEF compatible
- Ship weight 3 lbs.



15-55 GALLON HAND ROTARY PUMP

MODEL 8070

- Cast iron pump housing with heavy duty cast vanes and nitrite rubber seals
- Three-section 37-1/4" telescopic suction tube with interchangeable bung adapters
- Use for diesel fuel and non-corrosive petroleum-based fluids of light to medium viscosity
- Ship weight 14 lbs.



HIGH VOLUME ALUMINUM ROTARY PUMP

MODEL 8071

- Delivers over one quart per revolution
- Long lasting diecast aluminum construction with cast aluminum Buna-N-Seals
- Powder coated finish with zinc plated handle and discharge spout
- Curved metal spout, suction tube and bung adapter
- Use for transfer of petroleum-based products
- Ship weight 13 lbs.



POLYPROPYLENE ROTARY BARREL PUMP

MODEL 8075

- High density polypropylene with Rytan vanes
- 3 pc extension tube with filter and 2" bung adapter
- Use with water, water-based chemicals, 50/50 antifreeze mix, windshield washer solvents, alcohol, and petroleum-based products
- Works with DEF fluid
- Ship weight 5 lbs.

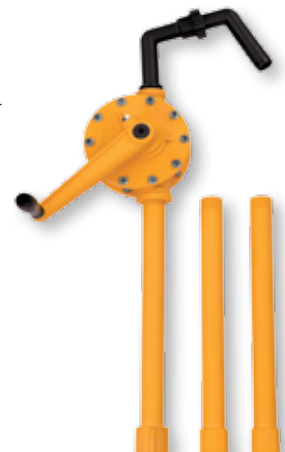

ROTARY DEF PUMP

MODEL 8076

- Specifically designed for use with diesel exhaust fluid (DEF,) AdBlue, and Urea
- Constructed with high density polypropylene with polypropylene vanes
- Delivers 1.3 gallons per 20 revolutions
- 3 pc extension suction tube with strainer fits 15-55 gallon drums
- 2" bung adapter included
- Ship weight 5 lbs



FM APPROVED ROTARY FUEL PUMP

8210

- Conforms to highest national and international standards
- Allows quick refueling of vehicles and equipment
- Self-priming operation with vacuum release
- Graphite vanes are self-lubricating and nonwearing
- Includes 8' antistatic hose with nonsparking nozzle
- Ship weight 19 lbs



LEVER ACTION 15-55 GALLON BARREL PUMP FOR GAS/DIESEL

MODEL 8080

- For use with petroleum-based fluids
- Hi-Nitrile rubber seals and packing
- Durable steel piston and foot valve
- Curved metal spout, 34-1/2" telescopic suction tube with 1-1/2" and 2" bung adapters. Use with oil-based fluids, heating oils and motor oils
- Delivers 10 oz. per stroke
- Ship weight 5 lbs.



LEVER ACTION 15-55 GALLON ANTIFREEZE BARREL PUMP

MODEL 8081

- Same as 8080 but designed for use with 100% antifreeze, noncorrosive chemicals, oils, and petroleum based fluids.

BUNG NUT ADAPTER

MODEL 8077

- 2" bung hole adapter converts buttress threaded drum opening to 2" NPT thread permitting easy application of various AFF pumps.
- A Buttress thread can be found on plastic drums used with DEF fluid, antifreeze, washer solvent, and other liquid media.



BULK GREASE FILLER PUMP

MODEL 8038

- Fill grease guns through a bulk loader valve or with a bearing packer
- Fits 5-gallon (25-50 lb.) pails
- 11 1/8" rubber-lined follower plate
- Ship weight 5 lbs.



HIGH-PRESSURE (3500 PSI) GREASE PUMP

MODEL 8039

- Fits 5-gallon (25-50 lb.) pails
- Steel construction with aluminum head and pumping chamber
- Includes 12' drum cover, 11-1/8" rubber-lined follower plate
- 48" high-pressure flexible hose with steel extension and four-jaw coupler
- Use for clean, high-pressure volume greasing of cars, trucks, equipment and machinery
- Ship weight 9 lbs.



BUCKET LEVER PUMPS

MODEL 8050

5 Gallon (25 to 50 lbs)

MODEL 8051

16 Gallon (120 lbs)

- Designed for use with differential fluids or heavier oils
- 48" fuel-resistant PVC hose with nozzle
- Delivers 1 pint per stroke
- Ship weight 5 lbs. (Model 8050)
- Ship weight 9 lbs. (Model 8051)



LOW PROFILE STEEL OIL DRAIN

MODEL 8877

- Ideal for draining oil where a pit or hoist is not available
- 15 gallon capacity
- Large metal screen provides extra draining area and keeps out debris
- Convenient rotary hand pump for fast evacuation



LOW PROFILE WASTE OIL DRAIN

MODEL 8878

- Low profile drain height of 7.75"
- Large 18 gallon baffled tank reduces "slosh" during transport
- Large metal screen provides extra draining area and keeps out debris
- Convenient rotary hand pump for fast evacuation
- Long steel handle provides easy mobility to drain area
- Ship weight 47 lbs



12V DC POWERED PUMP FOR 8878

MODEL 8815

- Replaces rotary pump on 8878 Low Profile Oil Drain
- Operates on DC power (from 12V battery or battery tester)
- Easy to use on/off switch and alligator style power leads
- Includes all fittings and hardware



LOW PROFILE ANTIFREEZE DRAIN

MODEL 8879

- Ideal for draining antifreeze where a pit or hoist is not available
- Large 18 gallon baffled tank reduces "slosh" during transport
- Large metal screen provides extra draining area and keeps out debris
- Convenient rotary hand pump for fast evacuation
- Aluminum design keeps antifreeze from corroding inner components
- Ship weight 46 lbs



8 GALLON WASTE OIL DRAIN WITH METAL TROLLEY

MODEL 8870

- 8 gallon capacity
- Plastic drain container
- Comes with 16.5" funnel
- Extends from 34" to 65"
- Metal trolley comes with 4 casters and pull handle for safe and easier movement around the shop.
- Ship weight 18 lbs.



18 GALLON WASTE OIL DRAIN WITH METAL TROLLEY

MODEL 8874

- 18 gallon capacity
- Plastic drain container
- Comes with 16.5" funnel
- Extends from 40" to 73"
- Metal trolley comes with 4 casters and pull handle for safe and easier movement around the Shop.
- Oil can be drained either by pour gravity, integrated drain valve or using integrated bung hole rotary barrel pump (not included)
- Ship weight 24 lbs.



CANTILEVER WASTE OIL DRAIN/EVACUATOR

MODEL 8888

- Unique design operates as an evacuator OR pressurized drain
- Ideal when oil extraction is preferred over oil drainage
- Pressurized air/suction transfers drained oil directly from basin to tank
- Suction probes evacuate oil directly from vehicle to tank
- Includes 6 individual suction probes along with special connectors for BMW and VW
- 23.75 gallon tank capacity with 17 gallon basin capacity
- Ship weight 123 lbs



24 GALLON WASTE OIL DRAIN AND PRESSURIZED EVACUATOR

MODEL 8890

- Large 24 gallon steel recovery tank with 6' drain hose
- Tank-mounted oil-level sight gauge and convenient tool tray
- Standard 15-3/4" drain funnel and wide 24" funnel adapter (shown) with drain tube that extends from 54" to 79"
- Pressure regulator
- Heavy duty wheels and casters
- Ship weight 82 lbs.



REPLACEMENT STANDARD PLASTIC FUNNEL

MODEL 8890K08

Fits AFF Model 8890 24 Gallon Waste Oil Drain and Pressurized Evacuator.

- 15-3/4" wide
- Ship weight 8 lbs.



18 GALLON WASTE OIL DRAIN WITH AIR EVACUATION

MODEL 8893

- 18 gallon steel recovery tank with 6' wire reinforced drain hose.
- Tank mounted oil level sight gauge
- Standard 14" x 5" deep drain funnel
- Extendable drain tube from 43.5" to 71"
- Preset pressure regulator
- Heavy duty wheels and casters
- Ship weight 66 lbs.



24 GALLON WASTE OIL DRAIN AND EVACUATOR WITH PROBE KIT

MODEL 8895

- 18 gallon suction capacity
- 100 PSI shop air connected to vacuum gauge quickly creates suction
- Large 16" collection funnel (4-7/8 gallon capacity)
- Suction extraction at 1/2 gallon per minute
- 78" suction and drain hoses
- Pressurized evacuation of tank makes emptying easy
- 70.8" maximum height
- Six flexible evacuation probes and VW, Mercedes and BMW adapters
- Two air ports: 1 for pressure, 1 for vacuum
- Ship weight 93 lbs.



3 LITER AXLE OIL DRAIN PAN

MODEL 8830

- For use with wheels ranging from 13.75" I.D. and larger
- Catches oil from hubs after removing the cap
- Fits on the rims of buses, trailers, and large trucks
- Prevents messy oil spills during wheel repair
- Side opening is designed for easy pouring into collector
- Durable polypropylene design
- Ship weight 1 lb



5 LITER AXLE OIL DRAIN PAN

MODEL 8831

- For use with wheels ranging from 19" I.D. and larger
- Catches oil from hubs after removing the cap
- Fits on the rims of buses, trailers, and large trucks
- Prevents messy oil spills during wheel repair
- Side opening is designed for easy pouring into collector
- Durable polypropylene design
- Ship weight 1.43 lbs



No Effect OK
 Minor to Moderate Effect SOME
 Severe Effect- Not Recommended NO

PUMP CAPABILITY CHART

AFF Model Number **8050 8051 8055 8060 8064 8070 8071 8075 8076 8080 8081 8210**

Chemical	8050	8051	8055	8060	8064	8070	8071	8075	8076	8080	8081	8210
Acetaldehyde	NO	NO	NO	NO	SOME	NO	NO	NO	NO	NO	NO	NO
Acetic acid 20%	NO	NO	NO	NO	NO	NO	NO	SOME	OK	NO	NO	NO
Acetone	NO	NO	NO	NO	OK	NO	NO	NO	NO	NO	NO	NO
Alcohol: Amyl	NO	NO	SOME	SOME	OK	SOME	SOME	SOME	OK	SOME	SOME	OK
Alcohol: Benzyl	NO	NO	NO	NO	OK	NO	NO	SOME	OK	NO	NO	NO
Alcohol: Butyl	NO	NO	SOME	SOME	OK	SOME	SOME	SOME	OK	SOME	SOME	SOME
Alcohol: Diacetone	NO	NO	NO	NO	OK	NO	NO	NO	NO	NO	NO	NO
Alcohol: Ethyl	SOME	SOME	SOME	SOME	OK	SOME	SOME	OK	NO	SOME	SOME	SOME
Alcohol: Hexyl	SOME	SOME	SOME	SOME	OK	SOME	SOME	SOME	NO	SOME	SOME	SOME
Alcohol: Isobutyl	SOME	SOME	SOME	SOME	OK	SOME	SOME	SOME	NO	SOME	SOME	SOME
Alcohol: Isopropyl	SOME	SOME	SOME	SOME	OK	SOME	SOME	SOME	NO	SOME	SOME	OK
Alcohol: Methyl	SOME	SOME	NO	NO	OK	SOME	SOME	NO	SOME	SOME	SOME	OK
Alcohol: Propyl	SOME	SOME	NO	NO	OK	OK	SOME	OK	OK	SOME	SOME	OK
Ammonia: 10%	NO	NO	NO	NO	NO	NO	NO	OK	NO	NO	NO	NO
Ammonia, anhydrous	NO	NO	NO	NO	NO	NO	NO	NO	NO	NO	NO	NO
Ammonia, liquid	NO	NO	NO	NO	NO	NO	NO	NO	NO	NO	NO	NO
Ammonium Hydroxide	NO	NO	NO	NO	NO	NO	NO	SOME	OK	NO	NO	NO
Anti-freeze	NO	NO	OK	OK	OK	NO	NO	OK	NO	NO	OK	NO
Benzene	NO	NO	NO	NO	NO	NO	NO	OK	NO	NO	NO	NO
Benzoic Acid	NO	NO	NO	SOME	OK	NO	NO	NO	OK	NO	NO	NO
Bleach	NO	NO	NO	NO	NO	NO	NO	NO	NO	NO	NO	NO
Boric Acid	NO	NO	SOME	SOME	OK	NO	NO	OK	OK	NO	NO	NO
Calcium Chloride(30% in water)	NO	NO	NO	NO	NO	NO	NO	NO	OK	NO	NO	NO
Calcium Hypochlorite	NO	NO	NO	NO	NO	NO	NO	NO	OK	NO	NO	NO
Calcium Sulfate	SOME	SOME	SOME	SOME	OK	NO	NO	OK	OK	SOME	SOME	NO
Citric Acid	NO	NO	SOME	SOME	NO	NO	NO	SOME	OK	NO	NO	NO
Copper Chloride	NO	NO	SOME	SOME	NO	NO	NO	NO	NO	NO	NO	NO
Copper Sulfate(5%)	NO	NO	SOME	SOME	NO	NO	NO	OK	OK	NO	NO	NO
DEF/Urea	NO	NO	OK	NO	OK	NO	NO	SOME	OK	NO	NO	NO
Detergents	NO	NO	OK	OK	OK	NO	NO	OK	OK	NO	NO	NO
Diesel Fuel	OK	OK	NO	OK	OK	OK	OK	NO	NO	OK	OK	OK
Ethyl Acetate	NO	NO	NO	NO	OK	NO	NO	NO	NO	NO	NO	NO
Ethylene Glycol	NO	NO	OK	OK	OK	NO	SOME	OK	OK	NO	OK	NO
Formic Acid	NO	NO	NO	NO	OK	NO	NO	SOME	SOME	NO	NO	NO
Fuel Oils	SOME	SOME	NO	NO	OK	SOME	SOME	NO	OK	SOME	SOME	OK
Gasoline	NO	NO	NO	NO	NO	NO	OK	SOME	NO	NO	NO	OK
Glycerin	NO	NO	OK	OK	OK	NO	SOME	OK	OK	NO	NO	NO
Hydrochloric Acid, to 37%	NO	NO	NO	NO	NO	NO	NO	NO	NO	NO	NO	NO
Hydrochloric Acid, to 50%	NO	NO	NO	NO	NO	NO	NO	NO	NO	NO	NO	NO
Hydrogen Peroxide, to 30%	NO	NO	NO	NO	NO	NO	NO	SOME	NO	NO	NO	NO
Jet Fuel(JP3: JP4: JP5)	NO	NO	NO	NO	OK	NO	SOME	NO	OK	NO	NO	OK
Kerosene	OK	OK	NO	NO	OK	OK	OK	NO	NO	OK	OK	OK
Lacquers	NO	NO	NO	NO	OK	NO	NO	NO	NO	NO	NO	NO
Lacquer Thinners	NO	NO	NO	NO	OK	NO	NO	NO	NO	NO	NO	NO
Lactic Acid	NO	NO	SOME	SOME	SOME	NO	NO	SOME	OK	NO	NO	NO
Methyl Ethyl Ketone	NO	NO	NO	NO	OK	NO	NO	NO	NO	NO	NO	NO
Mineral Spirits	NO	NO	NO	NO	OK	NO	NO	NO	NO	NO	OK	OK
Naphtha	NO	NO	NO	NO	NO	NO	NO	NO	OK	NO	NO	OK
Nitric Acid, to 20%	NO	NO	NO	NO	NO	NO	NO	SOME	SOME	NO	NO	NO
Oxalic Acid, (Cold)	NO	NO	SOME	NO	NO	NO	NO	SOME	OK	NO	NO	NO
Phosphoric Acid, to 40% solution	NO	NO	NO	NO	NO	NO	NO	SOME	OK	NO	NO	NO
Photographic(developer)	NO	NO	SOME	SOME	NO	NO	NO	SOME	NO	NO	NO	NO
Potassium Chloride	NO	NO	SOME	SOME	NO	NO	SOME	SOME	OK	NO	NO	NO
Potassium Hydroxide	NO	NO	NO	NO	OK	NO	NO	NO	NO	NO	NO	NO
Propylene Glycol	NO	NO	SOME	SOME	SOME	NO	NO	SOME	NO	NO	SOME	OK
Silicone	OK	OK	OK	OK	OK	OK	OK	OK	OK	OK	OK	NO
Sodium Bicarbonate	NO	NO	SOME	SOME	OK	NO	SOME	OK	OK	NO	NO	SOME
Sodium Chloride	NO	NO	SOME	SOME	OK	NO	NO	SOME	OK	NO	NO	NO
Sodium Hydroxide 50%	NO	NO	NO	NO	SOME	NO	NO	NO	NO	NO	NO	NO
Sodium Hypochlorite < 20%	NO	NO	NO	NO	NO	NO	NO	NO	NO	NO	NO	NO
Sodium Nitrate	NO	NO	NO	SOME	OK	NO	NO	NO	OK	NO	NO	OK
Sodium Sulfate	SOME	SOME	SOME	SOME	OK	NO	NO	SOME	OK	SOME	SOME	OK
Stoddard Solvent	SOME	SOME	NO	NO	OK	NO	NO	NO	SOME	SOME	SOME	NO
Sulfuric Acid, 75%	NO	NO	NO	NO	NO	NO	NO	NO	SOME	NO	NO	NO
Toluene, Toluol	NO	NO	NO	NO	SOME	NO	NO	NO	SOME	NO	SOME	NO
Tricochlorethane	NO	NO	NO	NO	SOME	NO	NO	NO	NO	NO	SOME	NO
Trichlorethylene	NO	NO	NO	NO	SOME	NO	NO	NO	SOME	NO	SOME	NO
Turpentine	NO	NO	NO	NO	SOME	NO	NO	NO	NO	NO	SOME	NO
Xylene	NO	NO	NO	NO	OK	NO	NO	NO	OK	NO	SOME	NO



American Forge & Foundry offers a wide array of powerful merchandising displays and point-of-purchase assortments to help maximize sales and product awareness.

AXLE NUT SOCKET DISPLAYS

6 AND 8 PT MIXED ASSORTMENT MODEL 18500P

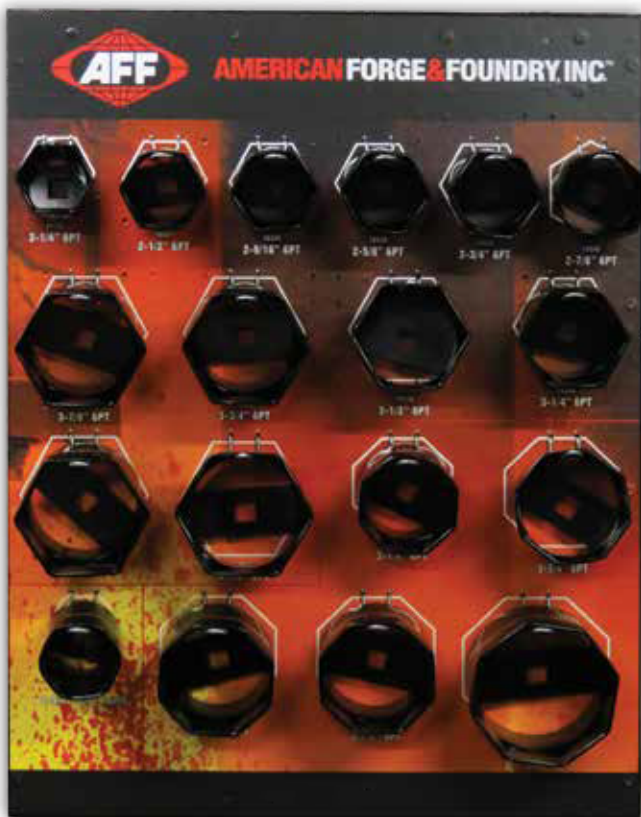

6 AND 8 PT BOARD ONLY MODEL 18499



- Display includes a mix of the most popular 6 and 8 pt sockets on one board
- Includes peg hooks and hardware for easy wall mounting
- No up-charge for display. Ships FREE with product.
- Includes 2 sockets of each size
- Each socket individually boxed and labeled for easy picking
- Dimensions: 30.5" high x 24" wide

MODEL	Description	MODEL	Description
18504	2-9/16" (6pt.)	18520	2-1/4" (6pt.)
18508	3-1/4" (6pt.)	18521	2-1/2" (6pt.)
18509	3-1/4" (8pt.)	18522	2-5/8" (6pt.)
18510	3-1/2" (6pt.)	18523	2-3/4" (6pt.)
18512	3-7/8" (6pt.)	18525	3-3/4" (8pt.)
18513	3-7/8" (8pt.)	18526	3-3/4" (6pt.)
18514	4" (6pt.)	18527	3-13/16" (8pt.)
18515	4-1/8" (6pt.)	18528	2-9/16" (6pt.)
18519	4-7/8" (8pt.)	18532	2-7/8" (6pt.)
18500P (display includes two of each sockets above).			

Merchandising



6 PT AXLE NUT SOCKET DISPLAY

MODEL 18560P

MODEL	Description
18501	2-3/32" LOCKNUT SOCKET 6 POINT
18502	2-3/8" LOCKNUT SOCKET 6 POINT
18504	2-9/16" LOCKNUT SOCKET 6 POINT
18508	3-1/4" LOCKNUT SOCKET 6 POINT
18510	3 1/2" LOCKNUT SOCKET 6 POINT
18512	3 7/8" LOCKNUT SOCKET 6 POINT
18514	4" LOCKNUT SOCKET 6 POINT
18515	4-1/8" LOCKNUT SOCKET 6 POINT
18516	4-3/8" LOCKNUT SOCKET 6 POINT
18518	4-7/8" LOCKNUT SOCKET 6 POINT
18520	2-1/4" LOCKNUT SOCKET 6 POINT
18521	2-1/2" LOCKNUT SOCKET 6 POINT
18523	2-3/4" LOCKNUT SOCKET 6 POINT
18526	3-3/4" LOCKNUT SOCKET 6 POINT
18528	2-9/16" LOCKNUT SOCKET 6 POINT ROUNDED
18532	2-7/8" LOCKNUT SOCKET 6 POINT
18534	3-1/8" LOCKNUT SOCKET 6 POINT
18536	2-3/8" LOCKNUT SOCKET 6 POINT ROUNDED
18539	5-1/4" LOCKNUT SOCKET 6 POINT
18560	DISPLAY BOARD

18560P 6PT kit includes 2 each



- Displays includes all industry standard 6 pt (18560P) or 8 pt (18580P) sockets
- Includes peg hooks and hardware for easy wall mounting
- No up-charge for display. Ships FREE with product.
- Empty display boards can be purchased separately
- Display dimensions: 30.5" high x 24" wide

8 PT AXLE NUT SOCKET DISPLAY

MODEL 18580P

MODEL	Description
18503	2-3/8" LOCKNUT SOCKET 8 POINT
18505	2-9/16" LOCKNUT SOCKET 8 POINT
18507	3" LOCKNUT SOCKET 8 POINT
18509	3-1/4" LOCKNUT SOCKET 8 POINT
18511	3-1/2" LOCKNUT SOCKET 8 POINT
18513	3-7/8" LOCKNUT SOCKET 8 POINT
18517	4-3/8" LOCKNUT SOCKET 8 POINT
18519	4-7/8" LOCKNUT SOCKET 8 POINT
18524	3-3/8" LOCKNUT SOCKET 8 POINT
18525	3-3/4" LOCKNUT SOCKET 8 POINT
18527	3-3/16" LOCKNUT SOCKET 8 POINT
18533	2-7/8" LOCKNUT SOCKET 8 POINT
18535	3-1/8" LOCKNUT SOCKET 8 POINT
18537	2-3/4" LOCKNUT SOCKET 8 POINT
18538	4-1/2" LOCKNUT SOCKET 8 POINT
18540	4-1/8" LOCKNUT SOCKET 8 POINT
18541	4-13/16" LOCKNUT SOCKET 8 POINT
18580	DISPLAY BOARD

18580P 8PT kit includes 2 each of:



6 PT AND 8 PT MIXED AXLE NUT SOCKET SHOP DISPLAY

MODEL 18501P

MODEL	18501P Package
18504	2-9/16" LOCKOUT SOCKET 6 POINT
18508	3-1/4" LOCKOUT SOCKET 6 POINT
18509	3-1/4" LOCKOUT SOCKET 8 POINT
18510	3-1/2" LOCKOUT SOCKET 6 POINT
18512	3-7/8" LOCKOUT SOCKET 6 POINT
18513	3-7/8" LOCKOUT SOCKET 8 POINT
18514	4" LOCKOUT SOCKET 6 POINT
18515	4-1/8" LOCKOUT SOCKET 6 POINT
18519	4-7/8" LOCKOUT SOCKET 8 POINT
18520	2-1/4" LOCKOUT SOCKET 6 POINT
18521	2-1/2" LOCKOUT SOCKET 6 POINT
18522	2-5/8" LOCKOUT SOCKET 6 POINT
18523	2-3/4" LOCKOUT SOCKET 6 POINT
18525	3-3/4" LOCKOUT SOCKET 8 POINT
18527	3-3/16" LOCKOUT SOCKET 8 POINT
18528	2-9/16" LOCKOUT SOCKET 6 POINT ROUNDED
18526	3-3/4" LOCKOUT SOCKET 6 POINT
18532	2-7/8" LOCKOUT SOCKET 6 POINT
18497	DISPLAY KIT FREE!

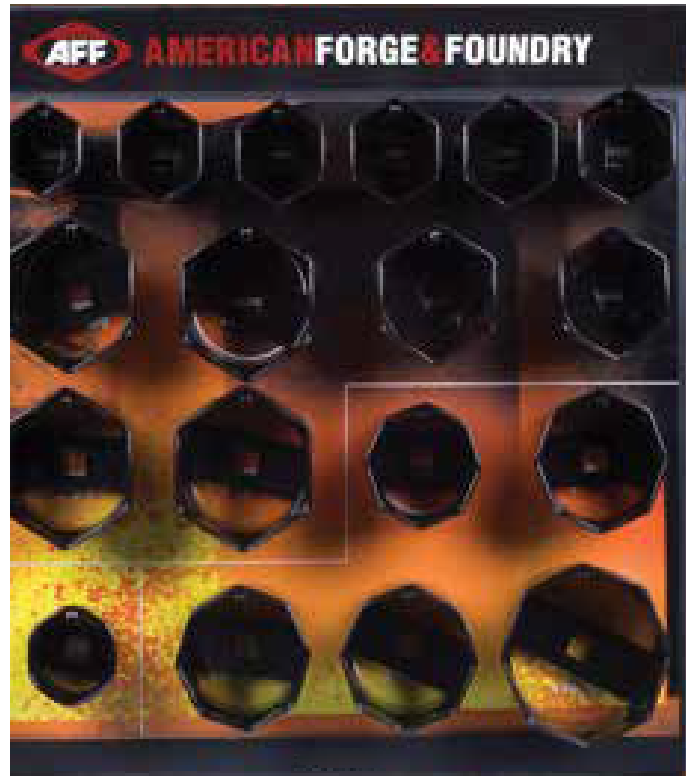

VINYL GRAPHIC KIT ONLY

MODEL 18497

- Created with the end user customer in mind this display is great for Fleet, Heavy Duty, and Automotive shops
- Most popular 6 and 8 pt sizes for any application
- Puts sockets in plain view and within easy reach
- Display attaches to a pegboard wall in minutes
- Includes vinyl roll and peg hooks
- Dimensions: 30.5" high x 24" wide



GREASE GUN DISPLAY MODEL 8901



8901 Grease Gun display includes:

- (2) 8000 professional grease gun
- (4) 8003 pistol grip grease gun
- (2) 8006 suction gun
- (2) 8031 grease gun holder
- (1) 8900 grease gun display board

GREASE GUN DISPLAY - BOARD ONLY MODEL 8900



- Includes the most popular grease guns
- Display is free with product purchase
- Comes preassembled with peg hooks and easy instructions
- Dimensions: 30-1/4" high x 24" wide



LUBE ACCESSORY DISPLAY
MODEL 8903



8903 Lube Accessory display includes:

- (2) 8012 12" whip hose
- (2) 8013 12" whip hose with spring
- (2) 8018 18" whip hose
- (2) 8019 18" whip hose with spring
- (2) 8021 90 degree adapter
- (2) 8022 1-1/2" needle adapter, narrow
- (2) 8023 4" needle adapter
- (2) 8025 recessed adapter
- (2) 8026 bulk loader valve
- (2) 8027 1-1/2" needle adapter
- (2) 8028 5/8" needle adapter
- (2) 8029 6" needle adapter
- (2) 8032 coupler
- (2) 8033 heavy duty coupler
- (2) 8034 right angle coupler
- (2) 8035 swivel coupler
- (2) 8037 seal off dispenser
- (1) 8902 lube display board

LUBE ACCESSORY DISPLAY - BOARD ONLY
MODEL 8902



- Includes a popular assortment of couplers, hoses, and adapters
- Display is free with product purchase
- Comes preassembled with peg hooks and easy instructions
- Dimensions: 30-1/4" high x 24" wide



PUMP RACK DISPLAY
MODEL 8904D1

- Attractively displays 8 of the best selling AFF pumps
- Part Number 8904D1 includes 2 each of the following skus:
 - 8055 Lever Action Barrel Pump
 - 8060 E-Z Flow 5 Gallon Oil Pump
 - 8064 Chemical Pump Nylon Body
 - 8070 Hand Rotary Diesel Pump
 - 8075 Polypropylene Rotary Barrel Pump
 - 8076 Polypropylene Rotary Barrel DEF Pump
 - 8080 Lever Action Barrel Pump for Gas/Diesel
 - 8081 Lever Action Antifreeze Barrel Pump
- Smaller footprint takes up less space than conventional displays (72"L x 21"W x 21"D)
- Want to customize? Order Part Number 8904 for the Display Only
- Literature rack included for AFF catalogs

PUMP RACK DISPLAY ONLY
MODEL 8904



AIR TOOL DISPLAY - MIXED ASSORTMENT

MODEL 7000D1

7010	3/8" Air Ratchet
7011	3/8" Air Ratchet Super Duty
7150	.3 HP 1/4" Die Grinder
7160	.6HP 1/4 Die Grinder
7161	.6HP 1/4" Angle Die Grinder
7200	3/8" Air Drill
7205	3/8" Air Drill Angle Head
7210	1/2" Air Drill
7640	3/8" Impact Wrench Super Duty
7667	1/2" Impact Wrench Super Duty
7668	1/2" Impact Wrench w/Ext Anvil Super Duty
7675	3/4" Impact Wrench Super Duty

AIR TOOL DISPLAY - SUPER DUTY ASSORTMENT

MODEL 7000D2

7011 (2)	3/8" Air Ratchet Super Duty
7021 (2)	1/2" Air Ratchet Super Duty
7640 (2)	3/8" Impact Wrench Super Duty
7667 (2)	1/2" Impact Wrench Super Duty
7668 (2)	1/2" Impact Wrench w/Ext Anvil Super Duty
7675 (2)	3/4" Impact Wrench Super Duty



AIR TOOL DISPLAY - HEAVY DUTY ASSORTMENT

MODEL 7000D3

7010	3/8" Air Ratchet
7020	1/2" Air Ratchet
7100	4" Angle Grinder
7150	.3 HP 1/4" Die Grinder
7151	.3 HP 1/4" Angle Die Grinder
7161	.6HP 1/4" Angle Die Grinder
7162	.6HP 1/4" Angle Die Grinder w/ Ext Shaft
7205	3/8" Air Drill Angle Head
7210	1/2" Air Drill
7660	1/2" Impact Wrench
7665	1/2" Air Impact Wrench w/Extended Anvil
7670	3/4" Impact Wrench



DISPLAY ONLY

MODEL 7000

- Purchase a preset assortment or any 12 air tools and receive the merchandiser for free
- Slat wall design offers flexibility for any showroom
- Can also be used as a counter display
- Includes threaded connectors and Feature and Benefit cards
- Eye catching molten graphics
- Dimensions: 24W"x17"Hx13.5" D

4-Shelf Vertical Display

MODELS 399, 399D1, 399D2, 399D3

- Heavy Duty display features diamond plate steel and a durable powder coat finish
- Preset assortments already available or contact an AFF representative to create a display to fit your customer base
- Ideal for small ton to medium ton bottle jacks, foot pumps, and vises
- Display ships FREE when purchased with product
- Display dimensions: 44-1/2"Lx24"Wx9-1/2"D

MODEL 399



MODEL 399D1



Merchandising



399D1 Includes:

- 2 ea – 3502
- 2 ea – 3504
- 2 ea – 3506
- 2 ea – 3508
- 1 ea – 3514
- 2 ea – 3512
- 1 ea – 3522
- 1 ea – 3520

399D2 Includes:

- 1 ea – 30510
- 1 ea – 3944
- 1 ea – 3948
- 1 ea – 3522
- 1 ea – 3520

399D3 Includes:

- 2 ea – 8040
- 2 ea – 8042
- 1 ea – 8043
- 2 ea – 8044
- 2 ea – 8041
- 1 ea – 3504
- 1 ea – 3506
- 1 ea – 3508
- 1 ea – 3512
- 1 ea – 3522
- 1 ea – 3520

MODEL 399D2



MODEL 399D3



Merchandising



4-Shelf Waterfall Display

MODELS DISPLAY-350, 350D1, 350D2

- Heavy Duty display features diamond plate steel and a durable powder coat finish
- Preset assortments already available or contact an AFF representative to create a display to fit your customer base
- Ideal for floor jacks, safety stands, large ton bottle jacks, and hose reels
- Display ships FREE when purchased with product
- Display dimensions: 64-1/2"Lx26"Wx43-1/2"D
- 120 lb weight capacity per shelf



MODEL DISPLAY-350

MODEL 350D1



350D1 Includes:

- 1 ea - 3502
- 1 ea - 3504
- 1 ea - 3506
- 1 ea - 3512
- 1 ea - 3514
- 1 ea - 3522
- 1 ea - 3520
- 1 ea - 200T
- 1 ea - 350SS

MODEL 350D2



350D2 Includes:

- 1 ea - 3502
- 1 ea - 3504
- 1 ea - 3506
- 1 ea - 3508
- 1 ea - 3514
- 1 ea - 3506C
- 1 ea - 3512
- 1 ea - 3522
- 1 ea - 3520
- 1 ea - 3530
- 1 ea - 3550

INVINCIBLE HAMMER DISPLAY

MODEL 50999

- All steel construction with powder coat finish
- Sets up in minutes
- Display can hold up to 16 Invincible Handle Hammers
- Model 509D1 preset display includes "1" each of the following:
 - 50100 Club Hammer
 - 50105 Club Hammer
 - 50110 Club Hammer
 - 50210 Sledge Hammer
 - 50220 Sledge Hammer
 - 50230 Sledge Hammer
 - 50300 Ball Pein Hammer
 - 50400 Cross Pein Hammer
- Want to customize? Order a combination of 8 different hammers and receive Model 50999 for free



Product Number	Type	Head Weight (lbs)	Product Weight (lbs)	Handle Length (inches)
50100	Club	2.50	3.85	12
50105	Club	4.00	5.25	12
50107	Copper Club	4.00	5.75	12
50110	Club	4.00	5.75	16
50206	Sledge	6.00	8.70	16
50208	Sledge	8.00	10.00	16
50210	Sledge	8.00	11.10	24
50217	Copper Sledge	8.00	11.50	24
50220	Sledge	8.00	12.00	30
50222	Sledge	8.00	13.00	36
50224	Sledge	12.00	17.50	36
50230	Sledge	14.00	18.50	30
50237	Copper Sledge	14.00	18.20	30
50300	Ball Pein	2.50	2.90	16
50400	Cross Pein	3.50	5.10	16



MODEL NUMBER INDEX

4KR20	26	814-40	26	3233A	33
4KR21	26	814-41	27	3303	32
4KR22	26	814C	25	3306	32
200T	4	815-40	26	3305A	32
200TK40	9	815-41	27	3309A	32
200TK42	9	815C	25	3310A	32
202T	4	818SD	25	3312B	32
206	7	818SD-40	25	3314	32
208	7	818SD-41	25	3320A	33
210	7	820A	55	3315A	33
300T	5	820AK7	55	3318	33
302T	5	832A	54	3340SD	34
320SS	4	832AK12	55	3342SD	34
322SS	5	834	54	3344SD	34
350D1	83	837	54	3400A	24
350D2	83	850ASD-P	55	3420ASD	34
350GTK23	9	850SD	53	3502	13
350GTK41	9	852ASD-P	55	3504	13
350SS	6	852ASD	53	3506	13
350SSK24	9	854ASD-P	55	3506C	13
352SS	6	854ASD	53	3508	13
352SSK24	9	856ASD-P	55	3512	13
390	8	856ASD	52	3514	13
399	80	859ASD-P	55	3520	13
399D1	80	859ASD	52	3522	13
399D2	81	920	51	3530	13
399D3	81	921	51	3550	13
535A	10	961	56	3577	31
536	11	962	56	3582	28
545SD	20	963	56	3584	28
546SD	20	964	56	3586B	29
547SD	21	990	56	3590A	31
548SD	21	992	56	3591	31
549SD	21	994	56	3595A	31
551	11	2145	17	3596	24
565E	10	2158	17	3598	24
565E-HANDLE	10	2195B	17	3700	22
565E1	10	3040A	23	3749	22
571B	30	3120	14	3751	22
573B	30	3125	14	3752	22
582	29	3130	14	3753	22
583	29	3135	15	3900A	36
584	29	3160	18	3901	61
760	61	3165	8	3902	61
761	61	3167	8	3904	36
804-09	26	3171	18	3905	59
804-10	27	3172	18	3906	59
804-11	27	3178	18	3907	59
805	26	3180	19	3908	59
806	26	3181	19	3911A	31
810-07B	27	3190B	16	3912A	31
810-41	27	3190SS	16	3917	23
810-45	27	3192B	16	3941	57
812	55	3198	19	3942	57
812-41	27	3220	15	3943	57
812K20	55	3225	15	3944	57



MODEL NUMBER INDEX

3947	57	8023	66	8815	69	50230	44
3948	57	8024	66	8830	71	50237	44
4001	37	8025	66	8831	71	50300	44
4002	37	8026	66	8870	70	50400	44
4003	37	8027	66	8874	70	50500	45
4005	37	8028	66	8877	69	50501	45
4008	37	8029	66	8878	69	50502	45
5512B	13	8033	66	8879	69	50503	45
5520B	13	8030	66	8888	70	50504	45
5612SD	12	8031	66	8890	70	50505	45
5620SD	12	8032	66	8890K08	70	50506	45
5621SD	12	8034	66	8893	71	50601	45
5630SD	12	8035	66	8895	71	50999	84
7000	79	8036	66	8900	76	57000	50
7000D1	79	8037	66	8901	76	57001	50
7000D2	79	8038	68	8902	77	57002	50
7000D3	79	8039	68	8903	77	57003	50
7010	40	8040	64	8904	78	AFFBUCKET	51
7011	38	8041	64	8904D1	78	DISPLAY350	82
7020	40	8042	64	18497	75	LOCKNUT SOCKETS	50
7021	38	8043	64	18499	73	LRC3B	27
7100	43	8044	64	18500P	73	LRC8B	27
7150	42	8050	69	18501P	75	PWBRUSH	61
7151	42	8051	69	18560P	74		
7160	42	8055	67	18580P	74		
7161	43	8060	67	30200	37		
7162	43	8064	67	30400	37		
7200	40	8070	67	31200B	60		
7205	40	8071	67	31350B	60		
7210	40	8075	67	31400B	60		
7640	38	8076	68	31500	58		
7660	41	8077	68	31501	58		
7665	41	8080	68	31510	58		
7667	38	8081	68	31520	58		
7668	39	8090	65	40012	46		
7670	41	8091	66	40200	46		
7675	39	8100	65	40300	47		
7685	41	8103	64	40400	47		
7687	39	8104	64	40405	48		
7688	39	8210	68	41050	49		
8000	63	8600A	62	41051	49		
8002	63	8600AP	62	41052	49		
8003	63	8605	63	41053	49		
8004	63	8612	65	41054	49		
8005	64	8618	65	41055	49		
8006	63	8620A	62	50100	44		
8007	63	8620AP	62	50105	44		
8008A	64	8621A	62	50107	44		
8010	63	8622A	62	50110	44		
8012	65	8625	35	50206	44		
8013	65	8654	36	50208	44		
8014	65	8655	35	50210	44		
8018	65	8656	35	50217	44		
8019	65	8686	65	50220	44		
8021	65	8687	65	50222	44		
8022	65	8698	65	50224	44		

