



Load Support Product Catalog

Adjustable Air Spring Kits and
On-Board Compressor Systems





IF YOU DON'T KNOW AIR LIFT,

YOU KNOW SQUAT.



Air Lift Company began developing air spring suspension products in 1949. Over the last 70 years we've learned a bit about squat. Whether you're towing the family travel trailer or hauling mulch, squat compromises your safety and comfort.

We're committed to eliminating squat by providing the best adjustable air helper springs for trucks, RVs, SUVs, CUVs and vans, as well as the most technologically advanced and easy-to-use on-board air compressor systems for one-touch inflation and deflation of your air springs.

That's why we say... If you don't know Air Lift, you know squat.



AIR LIFT IS A FAMILY-OWNED LANSING, MICHIGAN COMPANY.



Contents



Why Air Springs?4

Why Air Lift?5

Load Support Products

LoadLifter 7500 XL6

NEW! LoadLifter 5000 Ultimate Plus7

LoadLifter 5000 Ultimate8

LoadLifter 50009

RideControl.....10

NEW! Air Lift 1000 & 1000 HD.....11

NEW! Universal Air Spring Spacers12

SlamAir.....12

AirCell.....12

On-Board Air Compressor Systems13

WirelessAIR14

NEW! WirelessONE15

NEW! EZ Mount.....15

LoadController16

QuickShot.....17

SmartAir II18

Air Lift 1000 Universal Air Springs.....20

Parts & Pieces

Replacement Air Springs.....21

Fittings, Hoses and Air Lines22

Compressors23

Gauges and Valves.....24

Tanks and Miscellaneous25

Frequently Asked Questions26



4

Why Air Springs?



5

Why Air Lift?



6-12

Air Spring Kits



13-18

On-board Air Compressor Systems



21-25

Parts & Pieces



26

FAQs

Why Air Springs?

Tow and Haul with Safety and Comfort with Air Lift Adjustable Air Springs

- Air springs ensure that weight is properly distributed to all four tires, which maximizes vehicle stability, safety and comfort (see graphics below)
- Add air when towing or hauling a heavy load; deflate when riding empty for a softer ride
- Made with rugged, durable components
- Most kits are easy and quick to install with common hand tools



WITHOUT AIR LIFT AIR SPRINGS...

The vehicle squats, and the possibility of body roll and bottoming out increase.

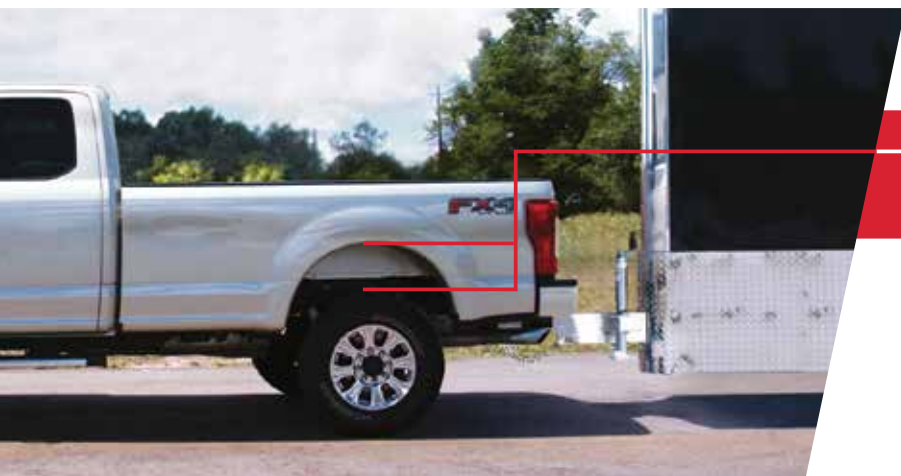

WITH AIR LIFT AIR SPRINGS...

Ideal ride height is restored, providing greater safety and comfort.

Air Lift air spring kits help solve these common problems

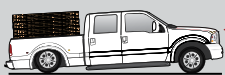

Squat

Proper weight distribution to all tires improves steering, braking and tire wear. This is especially important while towing.



Headlight Aim

Only level and stable vehicles provide safe and proper headlight aiming — critical for night driving safety.



Light Steering & Braking Feel

Front tires account for the majority of braking and steering. Air springs ensure that weight is properly distributed to all four tires for optimal braking and steering.



Bottoming Out

Air Lift springs restore normal ride height when heavily loaded or towing, reducing suspension wear and eliminating crashing on bumps.



Rough Ride

Air Lift's progressive spring rate soaks up bumps, keeping tires on the road for better handling.

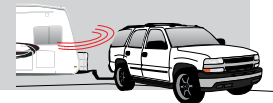

Body Roll

Air springs increase spring rate and vastly improve vehicle stability. Less roll means a safer and more comfortable ride.

Trailer Sway

When towing a trailer, air springs permit precise vehicle height adjustment for exact alignment, reducing trailer sway.

Why Air Lift?



INDUSTRY EXCLUSIVE!

Only Air Lift's Lifetime Warranty Covers the Entire Contents of the Air Spring Kit

While other companies offer a lifetime warranty on their air springs, only Air Lift covers the air springs as well as the entire contents of the kit including brackets, fittings and air line. Air Lift Company warrants that Air Lift 1000, RideControl, LoadLifter 5000, LoadLifter 5000 Ultimate, LoadLifter 5000 Ultimate Plus, LoadLifter 7500 XL and AirCell air springs systems will be free from defects in workmanship or materials for the lifetime of the vehicle of original installation. This does not include installation or other service charges for replacement.



Two-Year Warranty When Consumer Installs Themselves

Air Lift Company warrants that WirelessAIR, WirelessONE, SmartAir II, QuickShot and all LoadController on-board air compressor systems will be free from defects in workmanship or materials for two years on the vehicle of original installation. This does not include installation or other service charges for replacement.



Four-Year Warranty When Installed by an Authorized Installer

When installed by an Air Lift Authorized Installer, Air Lift Company warrants that WirelessAIR, WirelessONE and SmartAir II on-board air compressor systems will be free from defects in workmanship or materials for four years on the vehicle of original installation. This does not include installation or other service charges for replacement.

Quality Load Support Products That Fit, Work and Last. We Guarantee it!

- A 3rd generation, family-owned Lansing, Michigan suspension-specialty company since 1949
- The most comprehensive warranty plus an exclusive 60-day no-questions-asked, money-back guarantee
- Over 450 vehicle fitments
- Don't run around town trying to find a working air pump... Air Lift has the most innovative, easy-to-use on-board air compressor systems available

LoadLifter 7500 XL™	Lifetime Limited
LoadLifter 5000™ Ultimate Plus	Lifetime Limited
LoadLifter 5000™ Ultimate	Lifetime Limited
LoadLifter 5000™	Lifetime Limited
RideControl™	Lifetime Limited
Air Lift 1000™	Lifetime Limited
AirCell™	Lifetime Limited
SlamAir™	Lifetime Limited
WirelessAIR™	2 or 4 Year Limited
WirelessONE™	2 or 4 Year Limited
SmartAir™ II	2 or 4 Year Limited
LoadController™ Single and Dual	2 Year Limited
LoadController™ I and II	2 Year Limited
Other Accessories	2 Year Limited
Performance Systems	1 Year Limited

Dedication to Quality

Air Lift Company is proud to be ISO 9001:2008 certified.



Air Lift Company is committed to fulfilling the requirements of their quality management system: to develop, manufacture and continuously improve the highest quality products that fit, work and last. Our goal is to consistently provide products and services that meet or exceed the requirements and expectations of our customers.



57500 Series LoadLifter 7500 XL™

Leveling Loads With Less Pressure for a Better Ride Quality

LoadLifter 7500 XL™ offers up to 7,500 lbs. of load-leveling capacity and is designed to support the largest loads on the road. What sets the LoadLifter 7500 XL apart from other load support applications is its combination of maximum leveling ability, adjustability, and an uncompromising ride quality. This makes it the best choice for towing and hauling the heaviest loads with the utmost safety and comfort.



Popular LoadLIFTER 7500 XL Applications

Year	Make and Model	LoadLIFTER 7500 XL
2011-2016	Ford F250/350 - 4WD	57596
2017-2019	Ford F250/350 - 4WD	57599
2011-2019	Chevy/GMC 2500/3500 - 4WD	57538
2003-2018	Dodge RAM 3500 - 4WD	57595
2001-2010	Chevy/GMC 2500/3500 - 2WD/4WD	57575
2014-2018	RAM 2500 - 2WD/4WD	57589

XL Features

- **OUR HIGHEST CAPACITY:** Up to 7,500 lbs. of load-leveling capacity*
- Massive 7-inch double-convoluted-bellow air springs creates a better ride than most products with similar weight ratings
- Up to 20% more air spring volume than LoadLifter 5000 air springs
- Air adjustable from 5 to 100 PSI
- Upper and lower roll plates protect the air springs from possible abrasion and increase load capacity up to 10%
- End caps made of ultra high-strength, corrosion-proof, nylon composite which is as strong as steel but weighs less and will not rust
- Most kits use the existing holes in the vehicle's frame for a bolt-on installation – no drilling required!
- Easy to install with illustrated installation manual
- All kits are compatible with most 5th wheel and gooseneck hitches

20% more volume!



LoadLifter 7500 XL
7-inch diameter



LoadLifter 5000
6-inch diameter



* Never exceed manufacturer's recommended Gross Vehicle Weight Rating.
** Maintain minimum air pressure for the ultimate ride comfort. Minimum of 5 PSI must be maintained when used with a control system.

LoadLifter 5000™ 89000 Series

ULTIMATE PLUS+



NEW!



Air Lift's Highest-Quality Stainless Steel Components

LoadLifter 5000™ Ultimate Plus offers 5,000 lbs. of load-leveling capacity and is designed with Air Lift's highest quality, longest-lasting components. With high-end stainless steel roll plates, braided air lines and mounting hardware, LoadLifter 5000 Ultimate Plus provides an ultimate combination of leveling ability, adjustability, and ride quality.

Ultimate Plus Features

- Up to 5,000 lbs. load-leveling capacity*
- **EXCLUSIVE:** Stainless steel air spring mounting hardware
- Stainless steel roll plates which protect the air springs and help increase load capacity of the springs by up to 10%
- **EXCLUSIVE:** Jounce bumper inside the air spring prevents bottoming out and can be safely run with zero air pressure**
- **EXCLUSIVE:** Military-grade AN fittings simply thread together for a metal-to-metal seal, ensuring an easy-to-install, leak-free system with no air line cutting required
- **EXCLUSIVE:** Stainless steel braided air lines (2 x 5.5') for added protection against sharp edges and road debris
- Most kits require no drilling into the vehicle's frame
- Air adjustable from 5 to 100 PSI
- Most kits are compatible with most 5th wheel and gooseneck hitches
- Easy to install with fully-illustrated installation manual



LoadLIFTER 5000 Ultimate Plus Cutaway showing internal jounce bumper

NEW!

Upgrade Any LoadLifter 5000 Series Kit

Ultimate Plus Upgrade Kit	Includes stainless air lines (2 x 5.5'), roll plates, AN fittings, mounting hardware	PN 52301
Braided Air Line Upgrade Kit	Includes stainless air lines (2 x 5.5') and AN fittings only	PN 52300



60 DAY MONEY BACK GUARANTEE



* Never exceed manufacturer's recommended Gross Vehicle Weight Rating.

** Maintain minimum air pressure for the ultimate ride comfort. Minimum of 5 PSI must be maintained when used with a control system.



88000 Series LoadLifter 5000™ ULTIMATE



LoadLIFTER 5000
Ultimate
Cutaway showing
internal jounce
bumper

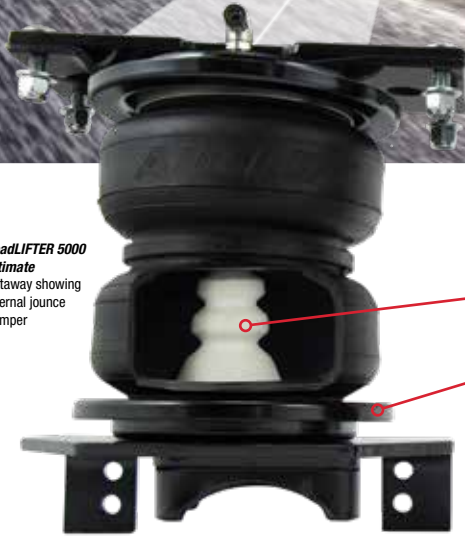

5000 Ultimate Features

- Up to 5,000 pounds of load-leveling capacity*
- **EXCLUSIVE:** Jounce bumper inside the air spring prevents bottoming out
- Roll plates to protect the air springs and help increase load capacity of the springs by up to 10%
- Eliminates squat, sway and bottoming out, and even the harsh jarring on rough roads
- Maintenance-free! Safely run with zero air pressure**
- Air adjustable from 5 to 100 PSI
- Easy to install with illustrated instruction manual
- Quick connecting, easy-to-use nickel-plated air fittings
- Replaces factory jounce bumper
- Fits all the same vehicles as the LoadLifter 5000™ line
- Adjustable for a safe, comfortable ride, loaded or unloaded
- End caps made of an ultra high-strength nylon composite which is as strong as steel, but weighs less and is corrosion proof

The Ultimate in Ride Safety and Comfort

All the benefits of a LoadLifter 5000™ air spring kit with the addition of an industry-exclusive internal jounce bumper for the ULTIMATE in ride comfort and protection.

An Air Lift

EXCLUSIVE

Internal jounce bumper with multi-stage ride comfort

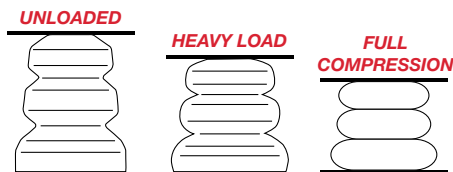

*Never exceed manufacturer's recommended Gross Vehicle Weight Rating.

** Maintain minimum air pressure for the ultimate ride comfort. Minimum of 5 PSI must be maintained when used with a control system.

LoadLifter 5000™ 57000 Series



Underframe kits available for most popular towing vehicles

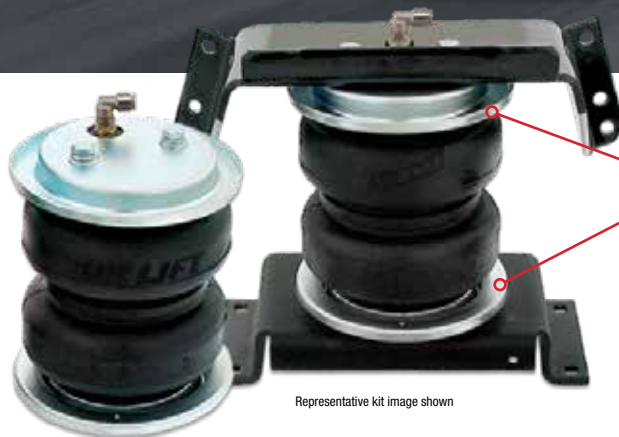

Representative kit image shown

Handle Your Heaviest Loads with Increased Safety and Ride Comfort

LoadLifter 5000™ kits are specifically engineered for towing and hauling your heaviest loads. These tough, durable air springs provide up to 5,000 pounds of leveling capacity* and are fully adjustable to keep your vehicle riding stable, level and comfortable whether loaded or unloaded.

5000 Features

- Up to 5,000 pounds of leveling capacity*
- Air adjustable from 5 to 100 PSI
- Roll plates to protect the air springs and help increase load capacity of the springs by up to 10%
- Most popular kits require no drilling into the frame
- Easy to install with illustrated instruction manual
- Quick connecting, easy-to-use nickel-plated air fittings
- The air springs used in the LoadLifter 5000 kits are built like a tire and are reinforced by durable 2-ply fabric for maximum strength
- End caps made of an ultra high-strength nylon composite which is as strong as steel, but weighs less and is corrosion proof



With Roll Plate



Without Roll Plate

Roll Plates:

Upper and lower roll plates are included in each LoadLifter 5000 kit. They protect the air springs from sharp edges, such as brackets or the vehicle's frame, and increase load capacity up to 10%*.

*Never exceed manufacturer's recommended Gross Vehicle Weight Rating.



RideControl Features

- Up to 2,000 pounds of leveling capacity*
- Air adjustable from 5 to 100 PSI
- Most popular kits require no drilling into the frame
- **EXCLUSIVE:** Alignment tool included with most kits to speed installation
- Easy to install with illustrated instruction manual
- Quick connecting, easy-to-use nickel-plated fittings

RideControl Delivers More Stability, Safety and Ride Comfort

Many of today's most popular light-to-medium duty trucks and vans are built for a more comfortable, car-like ride. That's fine when the vehicle is lightly loaded, but add a heavy load and the vehicle squats, compromising safety and ride comfort. RideControl™ air spring kits stabilize your loaded vehicle for greater safety and comfort.



60 DAY
MONEY BACK
GUARANTEE



*Never exceed manufacturer's recommended Gross Vehicle Weight Rating.



Representative kit image shown





Air Lift 1000™ & Air Lift 1000 HD™

60000/80000 Series



Adjustable Load Support for Coil Sprung Vehicles

Air Lift 1000™ and Air Lift 1000 HD™ are adjustable air springs engineered for coil spring suspensions, front or rear. Custom tune the ride you want for greater safety and comfort whether you're carrying a heavy load or riding light!



Air Lift 1000
Representative kit image shown

Air Lift 1000 Features

- Provides up to 1,000 pounds of leveling capacity*
- Air adjustable: typical maximum pressure is 35 PSI on cars and SUVs, 90 PSI for motorhomes
- Tough molded polyurethane construction
- Easy installation using common mechanic's tools
- Easy-to-follow illustrated instruction manual



Air Lift 1000 HD Features

- Exclusively for a 2009-2018 RAM 1500
- 2019 RAM 1500 coming soon
- Provides up to 2,100 pounds of leveling capacity*
- Tough molded polyurethane construction
- Easy installation using common mechanic's tools
- Easy-to-follow illustrated instruction manual
- No drilling required for installation



Air Lift 1000 HD
Representative kit image shown



*Never exceed manufacturer's recommended Gross Vehicle Weight Rating.

Universal Air Spring Spacer

Level Your Loads While Lifted

Add air springs to your lifted truck! The universal air spring spacer allows you to add an air spring kit to your already lifted pickup truck.



Universal Air Spring Spacer Features

- Works with all brands of bellows-style air springs (including Air Lift's LoadLifter 5000 series and LoadLifter 7500 XL)
- Available in 2" straight, 4" straight, 4" angled, 6" straight, and 6" angled heights
- Made with high-grade 1/4" steel and rated to handle over 10 tons of force
- Attaches between lower air spring bracket and the air spring
- Unique spinal design makes it easy to attach air springs using the provided hardware



2-inch straight P/N 52420

4-inch straight P/N 52440
4-inch angled P/N 52445

6-inch straight P/N 52460
6-inch angled P/N 52465

AirCell™



Maintenance-Free, Fixed Load Support

- Better ride than rubber load supports or steel overload springs
- Tough, long-lasting – same rugged material as factory jounce bumpers
- Half the cost of steel overload springs
- Front kits provide support for trucks with snow plows or other heavy front equipment

AirCELL vs Hollow Rubber Springs	RIDE COMFORT Vertical Acceleration & Pitch	HANDLING Roll Control	EASE OF INSTALLATION
AirCELL	Better than stock	Better than stock	Easy: AirCell spring snaps in with no need to lift vehicle (in most applications).
Rubber	Worse than stock	Worse than stock	More difficult: Spring must be bolted on, requiring vehicle lift.

SlamAIR™ 59100/59200 Series



Load Support for Lowered Vehicles

SlamAir™ kits fit most lowered trucks with a 2- to 6-inch drop, including trucks with flipped axles and notched frames. See the application guide, check online, or call to see which kit is right for you.

SlamAir Features

- Air adjustable from 5 to 100 PSI
- **EXCLUSIVE:** Alignment tool included with most kits to speed installation
- Easy to install with illustrated instruction manual
- Quick connecting, easy-to-use air fittings



Representative kit image shown



Air Lift On-Board Air Compressor Systems

Add an on-board air compressor system to inflate and deflate your air springs automatically or with the touch of a button — from inside or outside your vehicle

- For convenient, on-the-go control of your air springs, add an Air Lift on-board air compressor system
- Air Lift on-board air compressor systems eliminate the search for gas stations that have a working compressor, saving you time, energy and money
- All Air Lift compressor systems are compatible with all brands of air springs
- All systems include a compressor, controller and all parts needed for an easy installation

Choosing the Right On-Board Air Compressor System

- 1.** Choose Single Path or Dual Path Inflation
- 2.** Choose Automatic, Wireless or Analog

Automatic



P/N 25490

SmartAir II



P/N 25491

SmartAir II

Wireless

WirelessONE

P/N 25980

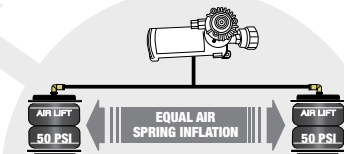

Single Path

Air springs are routed together for equal inflation. Good for loads that are evenly distributed from left-to-right

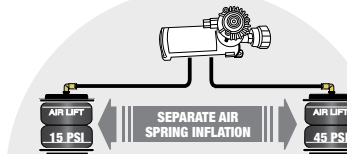

Dual Path

Air springs are routed separately for different air pressure side-to-side. Perfect for uneven or top-heavy loads



WirelessAIR

P/N 72000

Analog

LoadController
Single Compact

P/N 25850
P/N 25854



LoadController
Single Panel

P/N 25592
P/N 25655



LoadController
Dual Panel

P/N 25812
P/N 25651



LoadController
Dual Compact

P/N 25852
P/N 25856



To access detailed information on Air Lift's On-Board Air Compressor Systems



WirelessAir Features

- Dual path control means that drivers can set the left and right air springs to different pressures — perfect for users with uneven or top-heavy loads
- Easiest installation ever — no lines to the cab!
- Wireless handheld unit for convenient operation anywhere near the vehicle
- Provides advanced system diagnostics such as leak detection or compressor monitoring
- Two user-defined memory buttons allow for frequently used settings—for example, one setting for towing your RV, one for towing your boat
- System includes heavy-duty compressor, manifold and wireless remote —everything you need to install
- The manifold is weather resistant for maximum life expectancy in harsh climates
- Works with all brands of air springs
- 2-year Limited Warranty plus a 60-Day No Questions Asked, Money-Back Guarantee

60 DAY
MONEY BACK
GUARANTEE

2 YEAR
LIMITED WARRANTY

Compact and Convenient

The remote is the size of a garage door opener and clips to your vehicle's visor.



Premium On-Board Control of Your Air Springs

WirelessAIR™ provides one-touch inflation and deflation of your air springs from inside or outside the vehicle! System includes a heavy-duty compressor. Control two air spring independently for maximum flexibility, plus get advanced diagnostics which alerts you if there are any issues with the system. The convenience of an Air Lift on-board air compressor system means you'll never need to search for a gas station with a working compressor again to adjust your air spring pressure.



It's Easy to Install WirelessAIR™

Install with common mechanic tools and no air lines to the cab!

1. Install the compressor using the hardware provided
2. Mount the manifold
3. Install the electrical components and control your air helper springs wirelessly, with the touch of a button!

WirelessONE™

Single Path • P/N 25980
With EZ Mount • P/N 25980EZ



Economically Priced, Wireless Control of Your Air Springs

WirelessONE provides one-touch control of your air springs from inside or outside the vehicle! Standard-duty compressor included. Inflate 2 air springs to equal pressures. Get the convenience of on-board, wireless control of your air springs at an affordable price with WirelessONE.

WirelessONE is now available with EZ Mount™



Designed to Give You Faster Install Times!

- EZ Mount comes pre-assembled from the factory with:
- Black powder-coated steel mounting plate
- Upgraded compressor 120 PSI 1.03 CFM 9% Duty Cycle 12V
- Integrated manifold
- Reduces installation time by up to 1 hour
- Also includes a removable U-bolt for an easy and drill-free attachment to the frame rail 
- Factory-tested to be leak-free
- Can be mounted vertically or horizontally

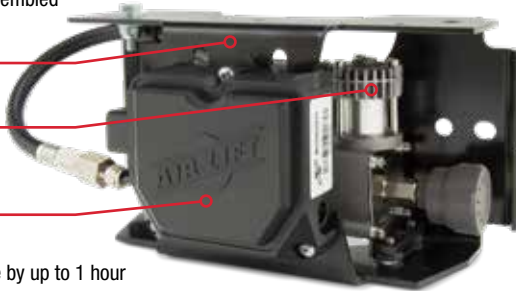

Now You Can Control your WirelessONE with your phone!

The free app turns your compatible smart phone into a fully-functional controller. The app provides all the functionality of the controller and much more.



WirelessONE Features

- Improved graphical display, programmable with up to three user-defined presets
- Manifold software updates provided over-the-air via free iOS and Android mobile app
- 2-way Bluetooth communication allows for built-in diagnostics
- 100 PSI 0.92 CFM 15% Duty Cycle 12V compact air compressor
- Weather-resistant and corrosion-proof manifold
- Automatic low-pressure monitor and air spring leak detection features
- Compact, relay-integrated, single path manifold
- Works with all brands of air springs
- 2 year Limited Warranty plus 60-Day No Questions Asked, Money-Back Guarantee (see page 5)



LoadController™



LoadController Single and Dual On-Board Air Compressor Systems

Provide One-Touch, In-Cab Control of Your Air Springs at an Economical Price!

LoadController on-board air compressor systems are easily installed with common mechanic tools in a few hours.

1. Install the compressor using the hardware provided.
2. Mount the gauge.
3. Hook up the air lines.
4. Install the electrical components.

Each system comes with everything needed to install. Choose from either a standard or heavy duty compressor.



Representative kit image shown

LoadController™ Single

Set both air springs to the same pressure



Deflate Both
Inflate Both

Standard-Duty Compressor P/N 25850
Heavy-Duty Compressor P/N 25854

LoadController™ Dual

Set each air spring to an independent pressure



Deflate Left
Inflate Both
Deflate Right

Standard-Duty Compressor P/N 25852
Heavy-Duty Compressor P/N 25856

LoadController Single and Dual gauges are compact in size. They come with a mounting pod or can easily fit into a pillar pod or can be flush mounted.



Single and Dual

LoadController Features

- One-touch control buttons are built into the gauge to reduce overall size — no need to find room in the vehicle to mount a large gauge panel
- Mounting pod included! Also fits in any 2 1/8" gauge pod or can be flush mounted
- Low-pressure sensor automatically activates the air compressor if air spring pressure falls below safe level to protect air springs
- Includes everything you need to easily install — compressor, wiring harness, air lines, gauge pod and hardware
- 2-year Limited Warranty plus an industry-exclusive 60-Day No Questions Asked, Money-Back Guarantee (see page 5)

60 DAY
MONEY BACK
GUARANTEE

2
YEAR
LIMITED
WARRANTY



Choosing a compressor

Standard or Heavy Duty?



Standard-Duty Compressor



Heavy-Duty Compressor

LoadController systems are available with either a standard or heavy-duty compressor. A standard-duty compressor is for those who use their compressor intermittently. The heavy duty compressor is best for daily use, it inflates faster and more quietly than the standard.

LoadController I & II Panel Analog also available

Panel Mounted Systems



Single Path

Standard-Duty Compressor
P/N 25592
Heavy-Duty Compressor
P/N 25655



Dual Path

Standard-Duty Compressor
P/N 25812
Heavy-Duty Compressor
P/N 25651

QuickShot™

Pressure-Driven System For Quick Inflation

QuickShot is a pressure-driven reservoir system that moves air faster. This means quick inflation of your air springs and your toys while you're on-the-go.*



Representative kit image shown

Single Path **P/N 25690** | Dual Path **P/N 25572**

*Not designed for high pressure or high volume applications

QuickShot Features

- In-dash control panel for easy monitoring and adjustment of air springs
- .81 cfm, 33% duty cycle compressor (at 100 PSI)
- 2-gallon reserve tank provides plenty of air when it's wanted
- Available as single-gauge/single-path system or single-gauge/double-needle/dual-path system
- Convenient easy-connect auxiliary air line makes air readily available for adjusting tires and filling air toys
- Two year warranty and an industry-exclusive 60-Day No Questions Asked, Money-Back Guarantee (see page 5)

60 DAY
MONEY BACK
GUARANTEE

2
YEAR
LIMITED
WARRANTY





Level Every Time!

Automatic Self-Leveling System

SmartAir™ II is our new and improved automatic self-leveling on-board air compressor system. Leveling sensors detect when the vehicle is not level and automatically returns the air springs to the desired ride height. It works on any road, under any load conditions and simply keeps the vehicle level, no matter what!



Single Path System
P/N 25490

Dual Path System
P/N 25491

SmartAir II Features

- No gauges or controller to mess with
- True automatic control — just load up and go!
- Unique non-contact height sensor maintains level ride with no lines or controls in the cab
- Easy to install with illustrated instruction manual
- Responsive and accurate to less than 1/16"
- Improved weather-resistant harness
- OEM standards for quality and function
- Kit comes complete with pre-assembled wiring harness, height sensor ECU, compressor — everything you need
- Two year warranty and a 60-Day, No Questions Asked Money-Back Guarantee (see page 5)

60 DAY
MONEY BACK
GUARANTEE

2 YEAR
COMPRESSOR OIL
WARRANTY

Note: SmartAir II fits leaf sprung vehicles only.

AIR LIFT
PERFORMANCE

PERFORMANCE AIR SUSPENSION®



Over 250 custom kits available!

Ford Mustang S550 Front Kit #78521 shown



AIR LIFT 3H
PERFORMANCE

**THE NEXT LEVEL
IN AIR MANAGEMENT**



TRACK TESTED AND TUNED FOR MAXIMUM PERFORMANCE

KIT FEATURES

1. Adjustable camber plates with high-quality spherical bearings, depending on application
2. Compact double-bellows air spring or sleeve-style bags
3. Red anodized aluminum accents
4. 30 levels of damping adjustment, monotube threaded strut with independent ride height adjustment
5. Black powder-coated strut bodies and lower mounts
6. Up to 5.0" (128mm) of drop, depending on vehicle
7. Vehicle-specific upper and lower mounts to ensure an OEM quality fit
8. Most kits also come with braided stainless steel air lines and all necessary fittings and hardware for mounting

Universal Air Springs



Features

Air Lift 1000 Universal Air Spring Kits contain everything needed for a full installation!

- Two Air Lift 1000 air springs
- Air spring spacers (if applicable)
- Two heat shields with clamps
- Air line, tee, zip ties, and two schrader valves
- Detailed installation guide with advice for a proper installation



Representative kit image shown

We Have a Kit for Almost Any Coil-Sprung Vehicle

Can't find an air spring kit for a coil-sprung vehicle? Air Lift 1000™ Universal Air Spring Kits fit almost any open coil spring to provide up to 1,000 lbs. of load-leveling support*. Just take two simple measurements and use the chart below to find the correct kit for your application.

Finding the correct application is as easy as 1-2-3!

- 1. Unload the vehicle** in order to take the most accurate measurements of the coil springs. Once the vehicle is at normal ride height, then move on to step two.
- 2. Take two measurements.** Measure the inside height (X) — the available height within the coil spring. Then measure the inside diameter (Y), or the width available inside the coil from side to side at its widest point (see diagram).
- 3. Find the corresponding part number.** Using the chart on the right, find the row that contains the correct inside height and inside diameter, and see which part number lines up with those values. It is better to be slightly undersized than oversized.

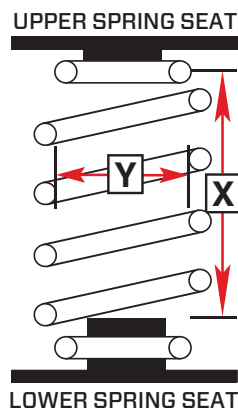

Air Lift 1000 Universal Air Springs

Kit #	Min. Diameter (Y)	Min. Length (X)
60900	3.00"	5.50"
60901	3.00"	8.00"
60902	3.00"	9.00"
60903	3.50"	5.26"
60904	3.50"	7.75"
60905	3.50"	9.50"
60906	4.00"	5.00"
60907	4.00"	6.00"
60908	4.00"	7.00"
60909	4.00"	8.00"
60910	4.00"	9.00"
60911	4.00"	10.00"
60912	4.00"	11.00"
60913	4.00"	12.00"
60914	4.50"	6.50"
60915	4.50"	7.50"
60916	4.50"	9.00"
60917	4.50"	10.00"
60918	5.00"	5.25"
60919	5.00"	7.00"
60920	5.00"	9.00"
60921	5.00"	11.00"
60922	5.50"	5.50"
60923	5.50"	7.50"
60924	5.50"	8.50"
60925	5.50"	9.50"
60926	5.50"	10.50"
60927	5.50"	11.50"

* Never exceed manufacturer's recommended Gross Vehicle Weight Rating.

Replacement Air Springs

Specifications

Refer to this chart to find the replacement air spring for your application.



Description	P/N	Replacement for Kit P/N	Max Ext. Height	Comp Height	Max Dia.	Max Load at 100 psi	Design Height	Air Fitting Size (NPTF)	Top Fastener	Bottom Fastener	Mtg. Hole Centers
Sleeves											
Sleeve 3.0"	58988		8.0	3.6	3.25	410	5.0-6.0	1/8"	3/4" - 16	3/8" - 24	N/A
Sleeve 4.0"	58482	50254	7.0	2.4	4.6	870	4.0-6.0	1/8"	3/4" - 16	1/2" - 13	N/A
Sleeve 4.5"***	58483	50255	6.25	2.6	5.1	1022	4.0-5.75	1/8"	3/4" - 16	1/2" - 13	N/A
Sleeve 4.0"	58287	50269	8.75	3.1	4.6	780	5.5-7.5	1/8"	3/4" - 16	1/2" - 13	N/A
Sleeve 4.0"***	58430	50208	8.75	3.3	4.6	858	5.0-8.0	1/8"	3/4" - 16	1/2" - 13	N/A
Sleeve 4.5"***	58387	50260	6.75	2.6	5.1	1076	4.0-6.0	1/8"	3/4" - 16	1/2" - 13	N/A
Sleeve 4.5"	58487	50256	6.8	2.4	5.1	1065	4.0-6.0	1/8"	3/4" - 16	1/2" - 13	N/A
Sleeve 4.5"***	58587	50262	7.75	3.3	5.1	915	4.5-7.0	1/8"	3/4" - 16	1/2" - 13	N/A
Sleeve 4.5"	58987	50259	7.75	3.1	5.1	935	4.5-7.0	1/8"	3/4" - 16	1/2" - 13	N/A
Sleeve 4.5"	58486		9.75	3.1	5.1	920	6.0-8.0	1/8"	3/4" - 16	1/2" - 13	N/A
Sleeve 4.0"	58586	50272	9.91	3.1	4.6	787	6.0-8.5	1/8"	3/4" - 16	1/2" - 13	N/A
Sleeve 4.0"	58786	50202	10.25	3.1	4.6	782	7.5-9.5	1/8"	3/4" - 16	1/2" - 13	N/A
Sleeve 4.5"	58571	50203	10.25	3.1	5.1	900	6.5-8.5	1/8"	3/4" - 16	1/2" - 13	N/A
Sleeve 5.0"	58471	50261	10.25	3.1	5.6	965	6.5-8.5	1/8"	3/4" - 16	1/2" - 13	N/A
Sleeve 5.0"	58688		7.75	3.1	5.6	965	5.0-7.0	1/8"	3/4" - 16	1/2" - 13	N/A
Sleeve 6.0"	58341	50200	10.9	4.4	6.8	1680	7.0-8.6	1/8"	M20-2.5	M20-2.5	N/A
Bellows											
Bellows 1B-5	58103	50207	5.8	1.8	6.5	1555	3.5-5.0	1/4"	3/8" - 16	3/8" - 16	1.75"
Bellows 1B-6	58407	50352/50252	7.1	1.9	7.0	2210	4.0-6.0	1/8"	3/8" - 24	3/8" - 24	2.75"
Bellows 1B-6**	58736	50284	7.1	2.7	7.0	2210	4.0-6.0	1/8"	3/8" - 24	3/8" - 24	2.75"
Bellows 1B-6 Ultimate**	58740	84201	7.0	2.7	7.0	2210	4.0-6.0	1/8"	3/8" - 24	3/8" - 24	2.75"
Bellows 1B-8	58124	50211	7.3	1.8	9.4	3340	4.0-6.5	1/4"	3/8" - 16	3/8" - 16	2.75"
Bellows 2B-6, Reg.	58439	50351/50251	7.7	2.3	6.5	2025	4.5-6.5	1/8"	3/8" - 24	3/8" - 24	2.75"
Bellows 2B-6, Reg. Ultimate**	58494		8.25	2.7	6.5	2025	4.5-6.5	1/8"	3/8" - 24	3/8" - 24	2.75"
Bellows 2B-6, Ext.	58437	50301/50201	9.1	2.3	7.0	2270	5.0-7.0	1/8"	3/8" - 24	3/8" - 24	2.75"
Bellows 2B-6, Ext.*	58401	50309	9.1	2.3	7.0	2270	5.0-7.0	1/4"	3/8" - 24	3/8" - 24	1.75"
Bellows 2B-6, Ext.**	58491	50232	9.1	2.7	7.0	2270	5.0-7.0	1/8"	3/8" - 24	3/8" - 24	2.75"
Bellows 2B-6, Ext. Ultimate**	58496	84252	9.1	2.7	7.0	2270	5.0-7.0	1/8"	3/8" - 24	3/8" - 24	2.75"
Gen IV Dominator	58343		10.5	2.8	7	2030	5.5-7.5	1/2"	3/8"-16	3/8"-16	1.75"-Top
Series D2500 - Single 1/2" Port											Centered - Bottom
Bellows 2B-7, Ext.	58115	50329/50229	9.0	3.3	8.0	2585	6.0-8.0	1/4"	3/8"-16	3/8"-16	2.75"
Gen IV Dominator	58616		12.5	2.8	8	3055	6.0-9.0	1/2"	3/8"-16	3/8"-16	2.75"
Series D2600 - Single 1/2" Port											
Tapered Sleeve											
1TS5.0"	58130		9.5"	4.25"	5.4"	1216	6.5-8.5	1/4"	3/8"-24	3/8"-16	2.75"-Top Centered-Bottom

* Replaces Firestone 255C ** Has internal jounce bumper.

NOTE: When ordering replacement bellows for kit numbers 57125 and 57131, the mounting stud, P/N 17210, is not included.

Branch PTC Tee



Part#	Fitting Size	Material
21003	1/8" NPT to 1/8" tube	Nickel
21845	1/8" NPT to 1/4" tube	Nickel
21385	1/4" NPT to 1/2" tube	Composite
21868	3/8" NPT to 3/8" tube	Nickel
21872	3/8" NPT to 1/2" tube	Composite

Bushings



Part#	Fitting Size	Material
21610	1/4" NPT to 1/8" NPT	Nickel
21735	3/8" NPT to 1/8" NPT	Nickel
21738	3/8" NPT to 1/4" NPT	Nickel
21251	1/2" NPT to 1/8" NPT	Nickel
21247	1/2" NPT to 1/4" NPT	Nickel
21732	1/2" NPT to 3/8" NPT	Nickel

Check Valves



Part#	Fitting Size	Material
26050	1/4" barbed to 1/4" barbed	Brass
21664	1/8" NPT to 1/8" NPT	Brass
21760	1/4" FNPT to 1/4" FNPT	Brass
21285	1/2" NPT to 1/2" NPT	Nickel

Couplings



Part#	Fitting Size	Material
21809	1/8" NPT to 1/8" NPT	Nickel
21758	1/4" NPT to 1/4" NPT	Nickel
21220	1/2" NPT to 1/2" NPT	Nickel

Female Straight



Part#	Fitting Size	Material
21875	1/8" NPT to 1/8" PTC	Brass
21834	1/8" NPT to 1/4" PTC	Nickel
21759	1/4" NPT to 1/8" PTC	Nickel
21869	1/4" NPT to 1/4" PTC	Nickel
21871	3/8" NPT to 1/4" PTC	Brass
21873	1/4" FNPT to 1/2" PTC	Brass

Air Line



Order by the foot	
1/8"	20914
1/4"	20946
3/8"	20947
1/2"	20966
1/4"	20937*

*Poly hose for Air Lift 1000 series bags

Male Elbow



Part#	Fitting Size	Material
21559	1/8" NPT to 1/8" PTC	Nickel
21837	1/8" NPT to 1/4" PTC	Nickel
21854	1/4" NPT to 3/8" PTC	Composite
21830	1/4" NPT to 1/4" PTC	Nickel
21851	1/4" NPT to 3/8" PTC	Composite
21263	1/4" NPT to 1/2" PTC	Composite
21846	3/8" NPT to 1/4" PTC	Nickel
21867	3/8" NPT to 3/8" PTC	Composite
21637	3/8" NPT to 1/2" PTC	Composite
21866	1/2" NPT to 3/8" PTC	Composite
21370	1/2" NPT to 1/2" PTC	Composite

Male Straight



Part#	Fitting Size	Material
21839	1/8" NPT to 1/4" PTC	Nickel
21807	1/4" NPT to 1/4" PTC	Nickel
21853	1/4" NPT to 3/8" PTC	Brass
21261	1/4" NPT to 1/2" PTC	Brass
21864	3/8" NPT to 3/8" PTC	Brass
21368	3/8" NPT to 1/2" PTC	Brass
21369	1/2" NPT to 1/2" PTC	Brass

Misc Fittings



Part#	Fitting Size	Material
21754	1/4" NPT drain cock	Brass
21842	Y Tee fitting 1/4" PTC	Nickel
10530	Air line cutter	
24290	200 PSI blow off valve	Brass
21931	150 PSI blow off valve	Brass



Male Pipe Couplers



Part#	Fitting Size	Material
21733	1/8" NPT to 1/4" NPT	Nickel
21799	1/4" NPT to 1/2" NPT	Brass
21508	3/8" NPT to 3/8" NPT	Nickel
21729	1/2" NPT to 1/2" NPT	Nickel

Pipe Plug



Part#	Fitting Size	Material
21585	1/4" NPT	Nickel
21737	3/8" NPT	Nickel
21193	1/2" NPT	Nickel
21190	1/2" NPT (countersunk)	Nickel

Branch Street Tee



Part#	Fitting Size	Material
21740	1/8" MNPT X 1/8" MNPT X 1/8" FNPT	Nickel
21507	3/8" MNPT X 3/8" MNPT X 3/8" FNPT	Nickel

Union PTC Elbow



Part#	Fitting Size	Material
21025	1/4" PTC	Composite
21860	1/4" PTC	Nickel
21857	3/8" PTC	Composite

Union PTC straights



Part#	Fitting Size	Material
21660	1/8" PTC to 1/4" PTC	Composite
21840	1/4" PTC	Nickel
21859	3/8" PTC	Composite
21377	1/2" PTC	Composite

Tee Union PTC



Part#	Fitting Size	Material
21874	1/8" X 1/8" X 1/8" PTC	Composite
21236	1/4" X 1/4" X 1/4" Press In	Composite
21739	1/4" X 1/4" X 1/4" Barbed Ends	Brass
21838	1/4" X 1/4" X 1/4" PTC	Nickel
21852	3/8" X 3/8" X 3/8" PTC	Composite
21372	1/2" X 1/2" X 1/2" PTC	Composite

Inflation Valve



Part#	Fitting Size	Material
21428	8 PSI inflation valve	Brass
21455	1/4" push on-to valve	Brass
21366	1/8" NPT to valve	Nickel
21633	1/4" PTC to valve	Brass
21727	Deflate knob (Requires P/N 21726)	
21726	Deflate button (Requires P/N 21727)	

(PTC) Push-to-Connect Fitting

(NPT) National Pipe Thread

Part material type subject to change. If you require a specific material type, please call to verify before purchasing.

Compressors



Compressors						
Part #	Description	CFM*	Max Pressure	Max Amp Draw	Duty Cycle	Fill Rate (5 gallons unless otherwise specified)
16060	Air Lift standard duty compressor	0.92	100 PSI	N/A	15%	Not for use with air tanks
16092	Air Lift heavy duty compressor	1.03	120 PSI	10	9%	0-105 PSI 2 Min. 20 Sec. (1 gallon)
16130	16130	0.60	130 PSI	N/A	15%	0-105 PSI 1 Min. 40 Sec. (1 gallon)
16190	VIAIR 325C	1.59	150 PSI	21	33%	0-145 PSI 6 Min. 51 Sec.
16380	VIAIR 380	1.58	200 PSI	23	100%	0-200 PSI 6 Min. 10 Sec.
23380	Dual Pack (2-380 compressors, relay)					165-200 PSI 3 Min. 30 Sec.
16400	VIAIR 400C	2.62	150 PSI	28	33%	0-145 PSI 4 Min. 50 Sec.
23400	Dual Pack (2-400 compressors, relay)					110-145 PSI 1 Min. 40 Sec.
16444/16444B	VIAIR 444	3.53	200 PSI	40	100%	0-200 PSI 5 min 30 Sec.
23444/23444B	Dual Pack (2-444 compressors, relay)					165-200 PSI 1 Min. 35 Sec.
16450	VIAIR 450C	1.80	150 PSI	23	100%	0-145 PSI 6 Min. 40 Sec.
23450	Dual Pack (2-450C compressors, relay)					110-145 PSI 2 Min. 11 Sec.
16480	VIAIR 480C	1.88	200 PSI	23	100%	0-200 PSI 10 Min 8 Sec.
23480	Dual Pack (2-480C compressors, relay)					165-200PSI 2 Min. 20 Sec.
23485/23485B	VIAIR 485 Dual Pack (2-485C compressors, relay)	3.82	200 PSI	44	100%	0-200PSI 4 Min. 50 Sec. 165-200 PSI 1 Min. 15 Sec.

* CFM = Cubic feet per minute @ 0 PSI.



P/N 16060



P/N 16092



P/N 16380



P/N 23450



P/N 16190



P/N 23480



P/N 23444
P/N 23444B (Black not shown)



P/N 16444
P/N 16444B (Black not shown)

Replacement Parts

Leader Hoses

P/N 22001 - 1/4" NPT X 1/4" NPT X 21" long, includes built in check valve (Replacement for: 16190, 16380, 16400, 16450, 23380, 23400, 23450)

P/N 22037 - 3/8" NPT X 3/8" NPT X 24" long, includes built in check valve (Replacement for: 16480, 23480)

Replacement Filters

P/N 10978 - Replacement filter for 16092, 16130 compressors

P/N 10951 - Remote intake air filter, assembly plastic housing, 1/4" MNPT x 3/8" tube fitting (Replacement for 16190, 16380, 16450, 23380, 23400, 23450 compressors)

Compressor Isolator Kit

Probably something everyone can agree on when it comes to air suspensions is that the 12-volt compressors are a bit noisy. The solution is our compressor isolator brackets. These brackets are designed to work with the VIAIR 380, 400, 444, 450, 480 model compressors and will significantly reduce noise and vibration.

P/N 50714



Gauges & Valves

Gauges

(Single needle gauges 2-3/4" deep and dual needle gauges 3-1/2" deep)



P/N 26227 Single Needle 200 PSI
P/N 26228 Dual Needle 200 PSI
 Single- and dual-needle gauges feature a chrome bezel, 2" diameter with a spun aluminum and white illuminated face, 1/8" FNPT threads



P/N 25193 Single Needle 100 PSI
P/N 24017 Dual Needle 100 PSI
 Single- and dual-needle gauges feature a black bezel, 2" diameter white illuminated face, 1/8" FNPT threads

Gauge Panels



P/N 26157
 200 PSI dual needle gauge, two electric switches (#24525) placed in panel for easy mounting (5" W x 2 3/4" H x 3 1/2" D)



P/N 26229
 200 PSI dual needle gauge, two manual paddle switches (#21703) placed in panel for easy mounting (5 1/2" W x 3 1/2" H x 3" D)



P/N 26161
 200 PSI single needle gauge, one manual paddle switch (#21703) placed in panel for easy mounting (4" W x 3 1/2" H x 3" D)



P/N 26156
 (1) 100 PSI single-needle gauge, one electric switch, one deflate button (5" W x 2 3/4" H x 4" D)



P/N 26159
 (2) 100 PSI single-needle gauges, one electric switch, two pressure deflate buttons (8" W x 2 3/4" H x 4" D)



P/N 26163
 (1) 100 PSI dual-needle gauge, one electric switch, two deflate buttons (5 1/4" x 2 3/4" H x 5 1/2" D)

Valves



P/N 24636 - 5/64" valve
 1/8" FNPT ports, 1/8" orifice (used primarily in 25651 Load Controller I™)



P/N 24300 - 1/2" valve
 1/2" FNPT ports, 1/2" orifice, 180 PSI max pressure 5.5CV and nickel plated finish



P/N 21703
Manual Paddle Switch/Valve
 Mechanical 1/4" hose barbs

Tanks | Miscellaneous



Aluminum Tanks



Aluminum 4 Gallon
P/N 11955 - Raw Finish
P/N 12955 - Polished
 (2) 1/4" NPT End Ports
 (2) 3/8" NPT End Ports
 (1) 1/4" NPT Drain Port
 Dimensions: 30"L X 6"D



Aluminum 2 1/2 Gallon
P/N 11958 - Raw Finish
P/N 12958 - Polished
 (4) 1/4" NPT Face Ports
 (1) 1/4" NPT Drain Port
 Dimensions: 20"L X 6"D



Aluminum 4 Gallon
P/N 11957 - Raw Finish
P/N 12957 - Polished
 (4) 1/4" NPT Face Ports
 (2) 3/8" NPT End Ports
 (1) 1/4" NPT Drain Port
 Dimensions: 30"L X 6"D



Aluminum 5 Gallon
P/N 11956 - Raw Finish
P/N 12956 - Polished
 (4) 3/8" NPT Face Ports
 (1) 1/4" NPT Drain Port
 Dimensions: 36"L X 6"D

Steel Tanks



P/N 10997- 12 Gallon
 (8) 1/2" NPT Ports
 Dimensions: 12-1/2" H X 44" L



P/N 10980
2 Gallon Powder-coated
 (4) 1/4" NPT Ports
 (2) 3/8" NPT Ports
 Dimensions:
 6"H X 17" L



P/N 10991
5 Gallon Powder-coated
 (8) 1/2" NPT Ports
 Dimensions:
 12 1/2" H X 20" L



This tank is perfect for any vehicle where space is a factor

P/N 10995
4 Gallon Pancake Tank
 (4) 1/2" Ports
 (2) 3/8" Ports
 (1) 1/4" Port
 (1) 1/8" Port
 Dimensions: 8" H X 16" D



P/N 10994
8 Gallon Powder-coated
 (8) 1/2" NPT Ports
 Dimensions:
 12 1/2" H X 32" L

Miscellaneous Parts

Pressure Switches

- P/N 24544**
On 85 PSI / Off 105 PSI
- P/N 24551**
On 110 PSI / Off 145 PSI
- P/N 24575**
On 145 PSI / Off 175 PSI



Heat Shield - P/N 34505

Universal heat shield kit to protect air springs



U-Bolts

- P/N 10594** - 3/8" Diameter X 3"W X 2"H
- P/N 10583** - 3/8" Diameter X 3"W X 4 1/2"H





Frequently Asked Questions

Q. Will adding air springs increase the weight rating of my vehicle?

A. No. Adding air springs does not change the Weight Rating (GVWR, GCWR, GAWR) of a vehicle. Adding weight over the factory rating is dangerous and voids your Air Lift warranty. Weight ratings take into account tires, bearings, frame, brakes and more. Increasing your suspension's ability to support weight does not increase the weight ratings. Never exceed your vehicle's weight ratings.

Q. Do you have to add a compressor (On-Board Air Compressor System) to your air springs?

A. A compressor isn't required, but it is convenient! An On-Board Air Compressor System allows you to inflate and deflate your air springs on the go. Compressors remove the hassle of pulling over or searching for service stations with air pumps. With our on-board air compressor systems, all adjustments are either automatic or can be made with the touch of a button.

Q. Do I have to keep air in the springs all the time, and how much pressure do I need?

A. Yes, you should always maintain the recommended minimum air pressure of 5 PSI, even if your vehicle isn't loaded. This keeps the air springs "in shape" and able to perform without rubbing or wearing. Just check the air pressure periodically, as you do for your tires.

Q. Can air springs raise or lower my vehicle?

A. If you're asking if conventional air springs can take the place of a lift or lowering kit, the answer is NO. If you're asking if air springs will cause a normal ride height vehicle to ride higher, the answer is, YES, if you want them to, by adding pressure, but only by an inch or two. If you DO want to lower your vehicle, look into our Air Lift Performance products. If you have a lowered truck and want to add air springs for towing, look at SlamAir™ (page 12). If you have a lifted truck and would like to add the support of air springs, check out Universal Air Spring Spacers (page 12).

Q. My vehicle rides rough; will adding air make it ride better?

A. Absolutely! Air springs are engineered to increase ride quality when carrying heavy loads and help fatigued springs ride smoothly. Our air springs greatly improve ride quality when towing or hauling.

Q. Can I use air springs with factory overload springs?

A. Yes, most of Air Lift's applications work with overload springs. Check our application guide for your vehicle.

Q. How long do air springs last?

A. Forever! If they are properly installed and maintained, our air springs can last indefinitely. Just check the pressure regularly, or use an on board air system to maintain it for you.

Q. What's better, steel helper springs or air helper springs?

A. Air Lift offers a Lifetime Warranty on all of our air spring kits. See page 5 for details. Air Lift air helper springs are the best solution because they are totally adjustable — steel springs are not. All you have to do is add or remove air to fine tune your ride for all load situations! That's the reason professional drivers choose air over steel. If you have a constant load and do not need the adjustability of air, our microcellular urethane springs (AirCell, see page 12) will provide load support and improve your ride with their simple, zero maintenance solution.

Q. How do I get replacement parts if I ever need them?

A. Air Lift sells many parts individually while our competitors want to sell you pairs of parts. You can get Air Lift replacement parts from your distributor or directly from Air Lift Company.



[View other performance suspension parts made by Air Lift on our website.](#)