



4X4 ACCESSORIES



CATALOG

CATALOG

CONTENTS



PRODUCTS

- 6 PROTECTION ACCESSORIES**
- 20 OLD MAN EMU SUSPENSION**
- 28 AIR LOCKERS**
- 34 AIR COMPRESSORS & TIRE ACCESSORIES**
- 38 FRIDGE FREEZERS**
- 44 ROOF RACKS**
- 46 CAMPING & TOURING**
- 52 DRAWERS**
- 56 GENERAL ACCESSORIES**
- 58 SAFARI SNORKELS**
- 60 RECOVERY EQUIPMENT**
- 64 AUXILIARY DRIVING LIGHTS**

VEHICLES

TOYOTA

- 72 200 Series**
- 73 100 Series**
- 74 80 Series**
- 75 FJ Cruiser**
- 76 Tacoma**
- 78 4 Runner**
- 79 Tundra**

JEEP

- 80 Wrangler JK**
- 82 Wrangler TJ**
- 83 Cherokee XJ / Liberty KJ**
- 84 Grand Cherokee**

LAND ROVER

- 86 LR3, LR4 & Defender**

NISSAN

- 88 Xterra**
- 89 Frontier**

FORD

- 90 Super Duty**

DODGE

- 92 Ram**

CHEVY/GMC

- 93 Chevy & GMC**

COMPANY

- 94 INTERNATIONAL VEHICLES**
- 96 BULL BAR APPLICATION CHART**
- 98 AIR LOCKER APPLICATIONS**

THE COMPANY



THE ROAD LESS TRAVELED...

ARB has been at the forefront of 4x4 accessories for nearly 40 years. We are constantly evolving to ensure our products suit the world's most unique destinations and the people driven to reach them.

ARB has grown from humble beginnings to become Australia's largest manufacturer and distributor of 4x4 accessories. That growth is a direct result of ARB's dedication to producing high quality, durable equipment specifically engineered for punishing conditions. By utilizing the most modern engineering systems and technologically advanced fabrication equipment, ARB will continue to be one of the most trusted and innovative leaders in the industry.

We hope that you find the equipment and inspiration in this catalog to head out and experience your own adventures. This catalog covers accessories for the most popular models typically outfitted, but there are many other applications we have products for.



THE HISTORY



FROM HUMBLE BEGINNINGS



Previous ARB factory in Bayswater, Australia during the early 1980s.

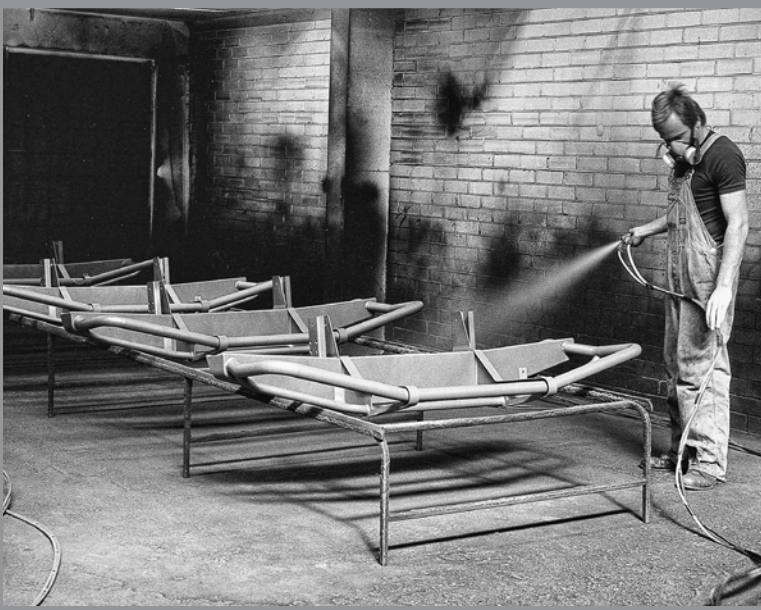

This year, ARB marks the 40th anniversary of being at the forefront of the 4x4 accessories industry. In 1975, Tony Brown headed for the Cape York Peninsula in north Queensland Australia in his Series I Land Rover. After witnessing the toll that overland travel was taking on the other adventurer's vehicles, an idea was born. While it may have been set up in his parent's garage, Tony began work on creating a solution to the widespread problem... reliable and durable accessories based on sound design. Within a year, there was enough interest and demand in the products for him to set up a 1000 sq ft. production facility.

ARB has grown from the humble beginnings of that garage to become Australia's largest manufacturer and distributor of 4x4 accessories, serving the needs of the 4x4 community around the world. By utilizing the most modern engineering systems and technologically advanced fabrication equipment, ARB will strive to continue to be a trusted and innovative leader.

We hope that our equipment helps you find the inspiration to head out and experience your own adventure. After all, ARB has been...
Your partner in adventure since 1975.



What better way to celebrate our 40th Anniversary than to select five of the most iconic 4x4 vehicles of the last four decades, restore them to their former glory—and pit them against one of Australia's most iconic 4x4 destinations...the Simpson Desert.

That is exactly what we are doing with the Off Road Icons project and we want you to come along with us on the journey.

ENGINEERING

DEFINING INNOVATION



40 YEARS

ON AND OFF THE ROAD

ARB places substantial emphasis and capital into research, design, and manufacturing each year. 30 highly trained individuals make up the ARB engineering department, which is tasked with designing, testing, and developing product lines that defines ARB as an industry innovator.

After the concept designs have been completed, the team uses their state of the art equipment and industry knowledge to create 3D models to ensure the perfect fit on the vehicle. The specialized software and CAD models perform a Finite Element Analysis (FEA) to simulate how the part will react to different conditions.

Extensive field testing, data recording, and a Failure Mode and Effect Analysis destructive analysis are all used to ensure all fabricated products are the most advanced accessories on the market.





Frontal impact testing



Vehicle specific shock valving analysis



Shock dyno testing

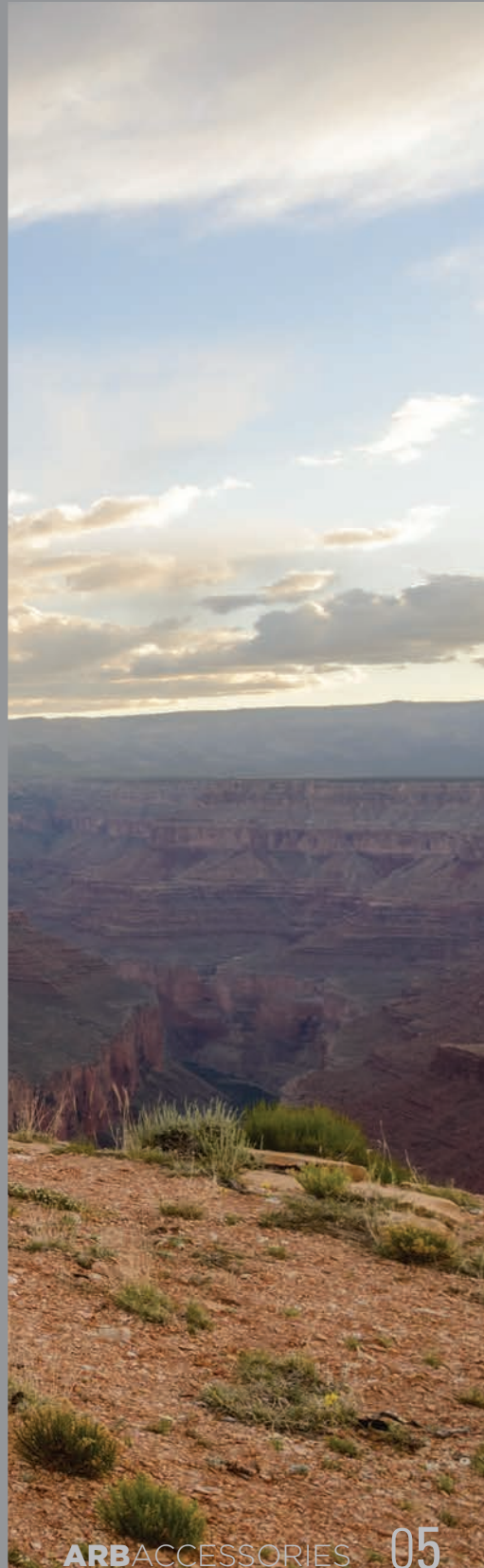

PROTECTION

ACCESSORIES





ARB engineers and manufactures a range of vehicle specific front protection bumpers known as bull bars. Both the Deluxe and Sahara style bull bars replace a vehicle's standard bumper with a protection system that provides numerous advantages and benefits.

The engineering of each bull bar incorporates vehicle design, collision crush rate, air bag deployment, approach angles, winch fitment, strength, weight and aesthetics to achieve the highest quality protection equipment.



BULL BARS

FEATURES & BENEFITS

SAHARA BAR

ARB Sahara Bars offer a unique look and practical features for both on and off the road.

Careful attention is paid to the styling and detail of the ARB Bull Bars to make certain each complements the particular body style of their intended product application.



ARB pioneered the five-fold upswept and tapered wing design to provide an enormous amount of strength while maintaining an optimal approach angle. The strength of this area is crucial in the event of an animal strike or impact.

An optional polished center tube offers a different look to the traditional bull bar design.

The majority of ARB Deluxe and Sahara bars feature recessed indicators and optional fog lights inset on the wings.

A design characteristic employed in many ARB bull bars is the split pan system. This design ensures the radiator receives a massive amount of airflow while further increasing the strength of the bar.

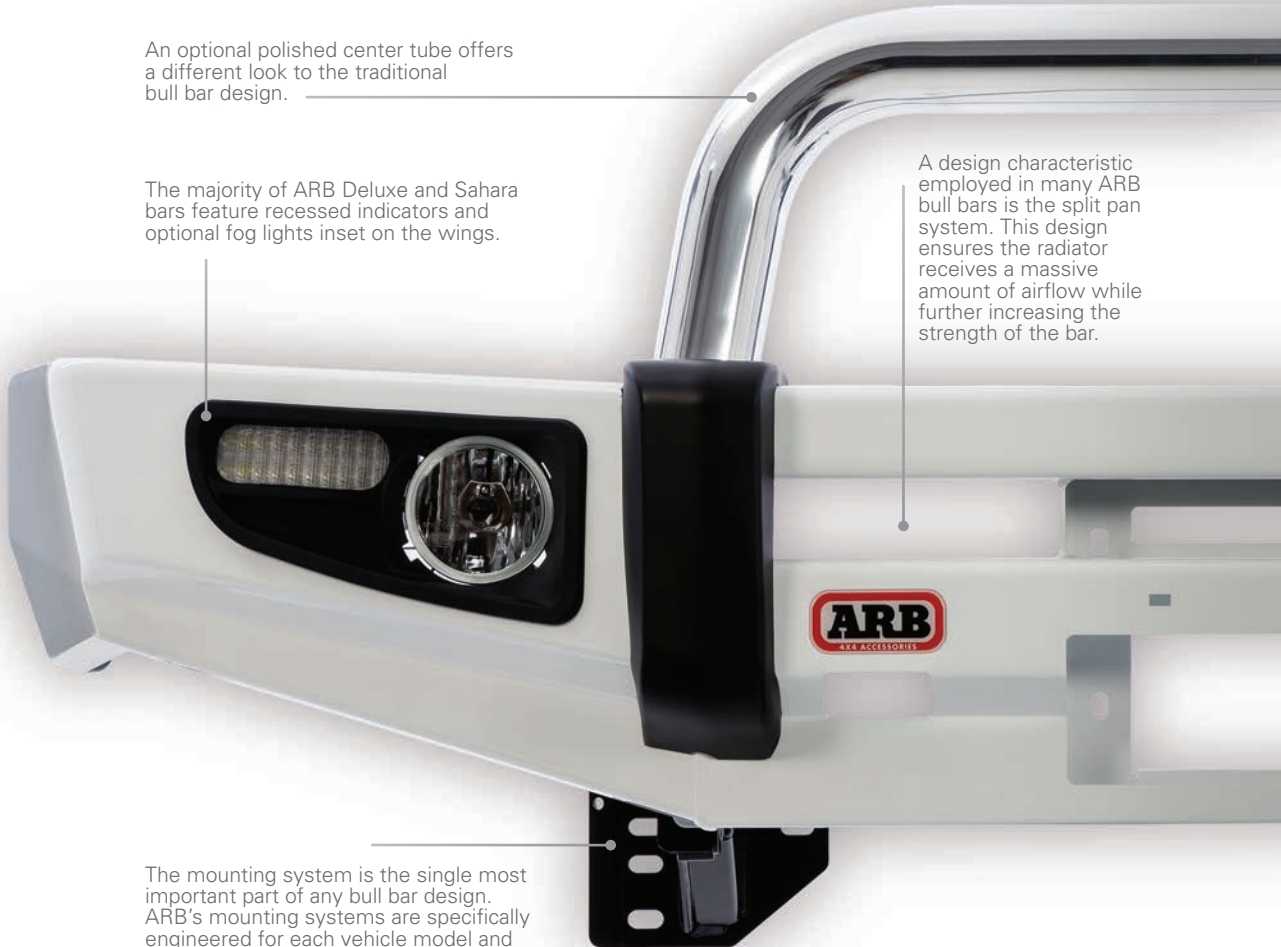

The mounting system is the single most important part of any bull bar design. ARB's mounting systems are specifically engineered for each vehicle model and are designed to evenly distribute impact and winching loads for increased safety.

DELUXE BAR

ARB Deluxe Bars set the benchmark for outstanding quality and features.

Each vehicle's frontal crush characteristics are assessed and the rate is replicated in the design of the bull bar and its mounting system to achieve maximum possible protection. With air bag equipped vehicles, it is critical that the vehicle's crush rate and air bag triggering is not altered by the installation of a bull bar.

Two CB antenna brackets are welded behind the top tube, to aid in clear communication when in remote areas.



Driving light mounting provisions are standard on ARB bull bars to ensure an easy to use and secure, vibration free location for additional lighting.

Each bull bar upright is a single piece of steel that extends from the outer framing tube and forms part of the chassis mount to ensure the outer frame receives the maximum possible support. Cover straps are then welded onto each upright to ensure there are no exposed sharp edges.

Winch installation is an option for most bull bar models. Mounting a winch requires a properly supported structure due to the stresses associated with winching. ARB takes this into account when a bull bar is engineered.

Many bull bar models incorporate reinforced Hi-Lift jacking points for lifting the vehicle.

Certain ARB bull bar models may not incorporate all of the above features.



BULL BAR

ENGINEERING & PRODUCTION



ARB UTILIZES A MIX OF MODERN MANUFACTURING TECHNOLOGIES TO ENSURE EACH BULL BAR RESULTS IN A SUPERIOR FIT AND FINISH.

ENGINEERING - Careful consideration is taken to vehicle design, crush rate, air bag deployment, approach angles, strength and aesthetics are incorporated into each bumper before any production happens.

TESTING - ARB has invested in vehicle crash barrier tests to validate the performance and compliance of the air bag compatible bull bars to replicate the vehicle's crush rate and air bag triggering.

LASER CUTTING - Starting off as a steel sheet, the components are cut into shape using a laser cutter, resulting in 100% accuracy without any heat distortion.

FOLDING - The flat pieces of steel are then folded using a Computer Numerical Control (CNC) pneumatic press. Most ARB bull bars utilize a five-fold design that provides increased strength with each fold.

TUBE WORK - For bars that utilize tubing, each tube is cut to length and bent on a CNC internal mandrel bender to ensure consistency.

ROBOT WELDING - After being folded into shape, each section is welded using a robotic welder, providing accuracy and speed.

ASSEMBLY - All sections—pan, wing, uprights, outer frame and chassis brackets—are placed in a jig and then welded together for a superior assembly. This is followed by finish welding for strength and aesthetics.

POST ASSEMBLY - Each bar is shot blasted, bathed in a phosphate solution, then powder coated and oven baked to ensure a rich, durable, paintable finish.

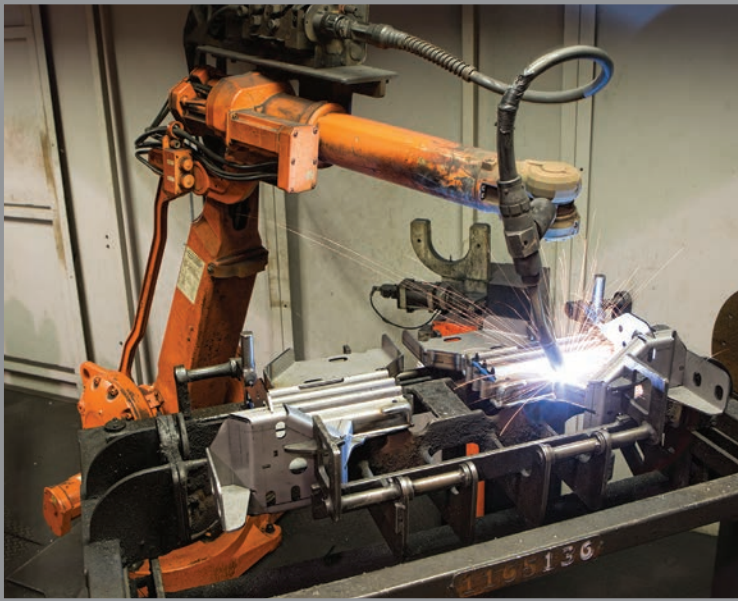



DELUXE BULL BAR

Protection and vehicle safety is vital when on a remote dirt road or busy highway. Setting the benchmark in outstanding quality, no other bumper will provide the same level of vehicle integration, protection and functionality as an ARB Deluxe Bull Bar.

The range of Deluxe Bull Bars offered by ARB is extensive, covering most 4WD vehicles. Each bull bar model is specifically designed to match and integrate with a vehicle's aesthetics and structure to provide the peace of mind you need to drive with confidence.

FRONTIER - 3438320



SAHARA BAR



Delivering a more refined appearance, the Sahara Bar offers fantastic protection and a long list of features for both on and off road use similar to the Deluxe Bull Bar. The Sahara styling is designed to closely match a vehicle's aesthetics and can be configured with or without an optional aluminum center hoop.

TUNDRA - 3915030





MODULAR BULL BAR



Very modern in styling yet distinctively ARB in heritage, these new bumpers are truly innovative and utilize a modular design. Three distinct configurations are available for each application, allowing for customization to meet individual needs or preferences. The integrated features were also designed from the ground up as shown by the Integrit textured, matte black powder coat, the unique press formed fog light housings, and the ability to mount a variety of winches (up to a Warn 16.5ti) within the bumper.



SIDE PROTECTION

Side protection equipment acts as a shield between the vehicle's vulnerable lower panels and the rugged terrain encountered on the trails. A range of options are available for various vehicle models. The applications for each style of side protection have been carefully selected to best match different models.

JEEP JK UNLIMITED - 4450210

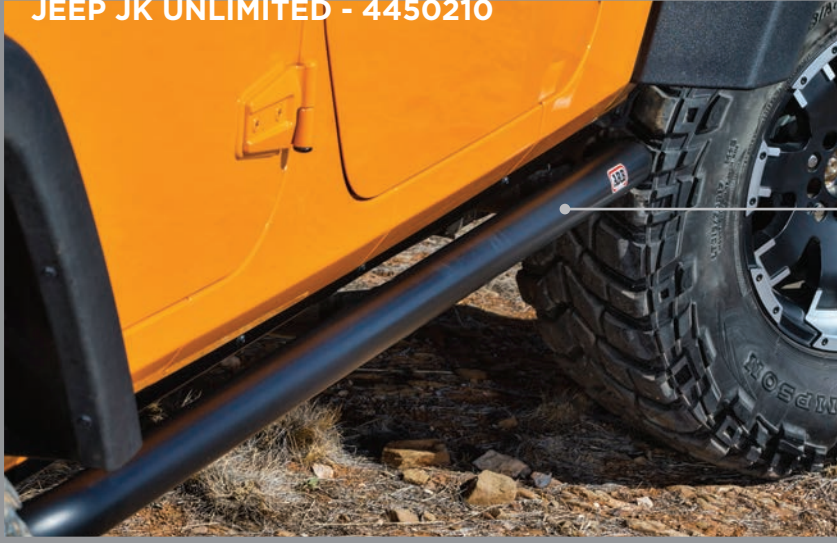

ROCK SLIDERS

Manufactured from tough, tubular steel for optimum strength, ARB Rock Sliders are ideal for use on steep or rocky terrain.

60 SERIES LAND CRUISER - 4410020



SIDE RAILS AND STEPS

ARB's side rail with an integrated step system provides outstanding protection for off road driving as well as easier access to the vehicle due to the fitment of tread plates to the topside. Protective strength is imparted on the side rails by anchoring the system to the ARB Bull Bar and vehicle frame.



REAR BUMPERS & TIRE CARRIERS



TOYOTA 100 - 5615010, 5700211, 5700222

Like all ARB products, rear protection equipment is manufactured to extremely high standards for maximum strength and is designed for optimum fit.

ARB offers a range of rear bars, incorporating wheel carriers and jerry can holders, to provide additional functionality while delivering high quality vehicle protection.





FJ CRUISER - 5620010

FEATURES:

- Allows for the fitment of larger tires in an easily accessible location.
- Wheel and jerry can carriers can be optioned on either side of the rear bar on most vehicles.
- Carriers are mounted via dual shear pivots for maximum strength.
- The wheel carrier and jerry can holder is simple to operate and can be opened with the easy pull of a handle.
- Gas strut assists with the opening of each arm, with a locking pin to hold the carrier open on steep inclines.
- Carrier arms close with a simple slam.
- Durable powder coat finish that provides a perfect base for color matching to a vehicle's factory paint.

* Certain ARB rear bar models may not incorporate all of the above features. Several models do not utilize a tire carrier option.



JEEP JK - 5650360, 5750320



SKID PLATES & UNDER VEHICLE PROTECTION



ARB SKID PLATES ARE AN ENGINEERED SYSTEM EXPERTLY MANUFACTURED TO PROTECT VITAL VEHICLE DRIVETRAIN COMPONENTS FROM ROCKS AND DEBRIS.

- Provides a formidable safeguard to ensure the most vulnerable components are protected.
- Protects components between the bumper and the transfer case.
- Each system is designed for specific vehicle platforms.
- Manufactured from laser cut, pressed and folded steel.
- Designed for optimal strength-to-weight ratio.
- Bolts directly to the chassis using a recessed mounting system to protect hardware from being damaged by contact with debris or rocks.
- Easily removable for vehicle servicing.



Jeep JK — 2007-11(5450100)
2012+ (5450110)



DIFFERENTIAL COVERS

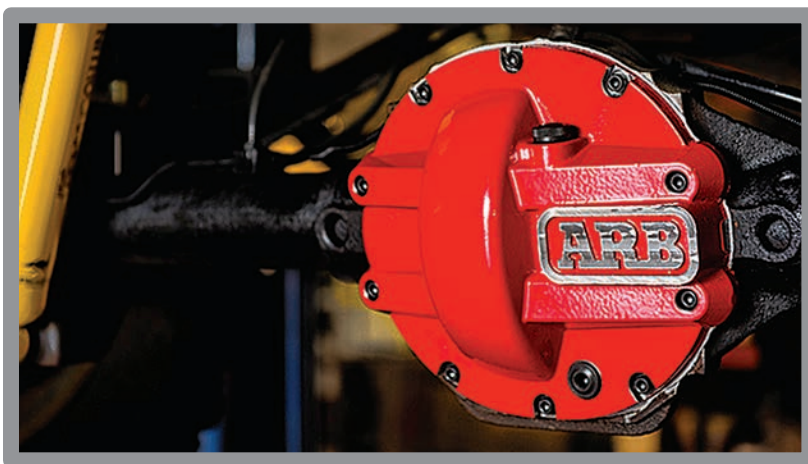

APPLICATIONS LIST:

- Dana 30
- Dana 35
- Dana 44
- Dana 60
- Chrysler 8.25in
- Ford 8.80in
- GM 10-Bolt
- Nissan M226

When on the trail, it is inevitable that obstacles will be encountered that could potentially inflict expensive damage on your differential. Available for a range of axle models, ARB Differential Covers are designed to protect against the hazards of impacts while off road and to counteract flexing of the axle assembly.

FEATURES:

- High tensile nodular iron structure.
- Computer optimized cross brace design increases structural rigidity of the whole axle.
- Optimized approach/departure angles.
- Additional housing strength greatly increases ring and pinion life and overall maximum load strength.
- High power magnets in both the drain plug and dipstick collect metallic particles from the oil and makes checking for contamination very quick and efficient.
- Drain plug allows for easy fluid changes.
- Available in red or black powder coat.



OLD MAN EMU

SUSPENSION



OLD MAN EMU
4X4 SUSPENSION BY ARB





DESIGNED FOR SUPERIOR PERFORMANCE OVER ALL TYPES OF TERRAIN

Few products can provide noticeable improvements to a vehicle's performance, load carrying capacity and vehicle handling control characteristics like Old Man Emu vehicle suspension systems.

Unlike many other aftermarket suspensions where a single configuration targets a certain lift height, Old Man Emu offers a unique and fully integrated solution. OME provides a range of tuned, matched and integrated systems to ensure the right suspension components are fitted to suit specific vehicle requirements.

Old Man Emu employs a team of suspension engineers to carry out exhaustive testing and development. They utilize the most modern testing equipment, including Solidworks, spring and shock dynamometers and Motec data acquisition, to ensure that each suspension system developed can handle any terrain while imparting fantastic vehicle control to the driver.

All Old Man Emu products are supported with a 3 year/35,000 mile warranty.

BP-51



BYPASS SHOCK ABSORBER

BP-51 OME



4X4 SUSPENSION



The BP-51 High Performance Bypass Shock Absorber is the result of an exhaustive development process aimed at delivering the ultimate in both comfort and control.

This new line technology was designed, developed, and tested in-house by ARB's team of Old Man Emu engineers. BP-51 shock absorbers are vehicle specific and utilize existing mounting locations to provide easy installation without the need for any vehicle modification.

Unlike other adjustable shock absorbers, which only provide compression adjustments, the BP-51 range allows for independent adjustment of both rebound and compression to offer class leading ride customization that can be tailored to individual vehicle or trip requirements.

Bypass Technology

In addition to the velocity sensitive damping used in most shock absorbers (faster the piston moves, the higher the level of damping that is generated), BP-51 shock absorbers also generate damping dependent on the position of the piston within the shock absorber's body via fluid flow through the internal bypass design.

Typical shock absorbers are only able to provide damping based on fluid transfer through the piston. BP-51's unique bypass design offers the best of both worlds, allowing the high performance oil to pass directly through the piston while also being channeled around the assembly via the bypass passages. The result is a shock absorber that can adapt to any terrain, providing increased ride control at the upper and lower travel limits.

Development and Manufacturing

All BP-51 shock absorbers are manufactured in-house by ARB. In order to achieve this, state of the art machining and hard anodizing equipment have been acquired, allowing ARB to maintain total control over the manufacturing process ensuring the highest possible quality.

BP-51 shock absorber bodies are manufactured using aircraft grade (6061 T6) anodized aluminum, which provides extremely efficient heat dissipation and superior corrosion resistance.

Extensive real world, lab, and destructive testing have been undertaken throughout the development process to ensure that the reliability, longevity, and performance of this system meets ARB's lofty standards.

The BP-51 range is backed by a three year, 40000 mile warranty.

RACING TECHNOLOGY

FOR YOUR ADVENTURES

HIGH PERFORMANCE BYPASS RIDE CONTROL

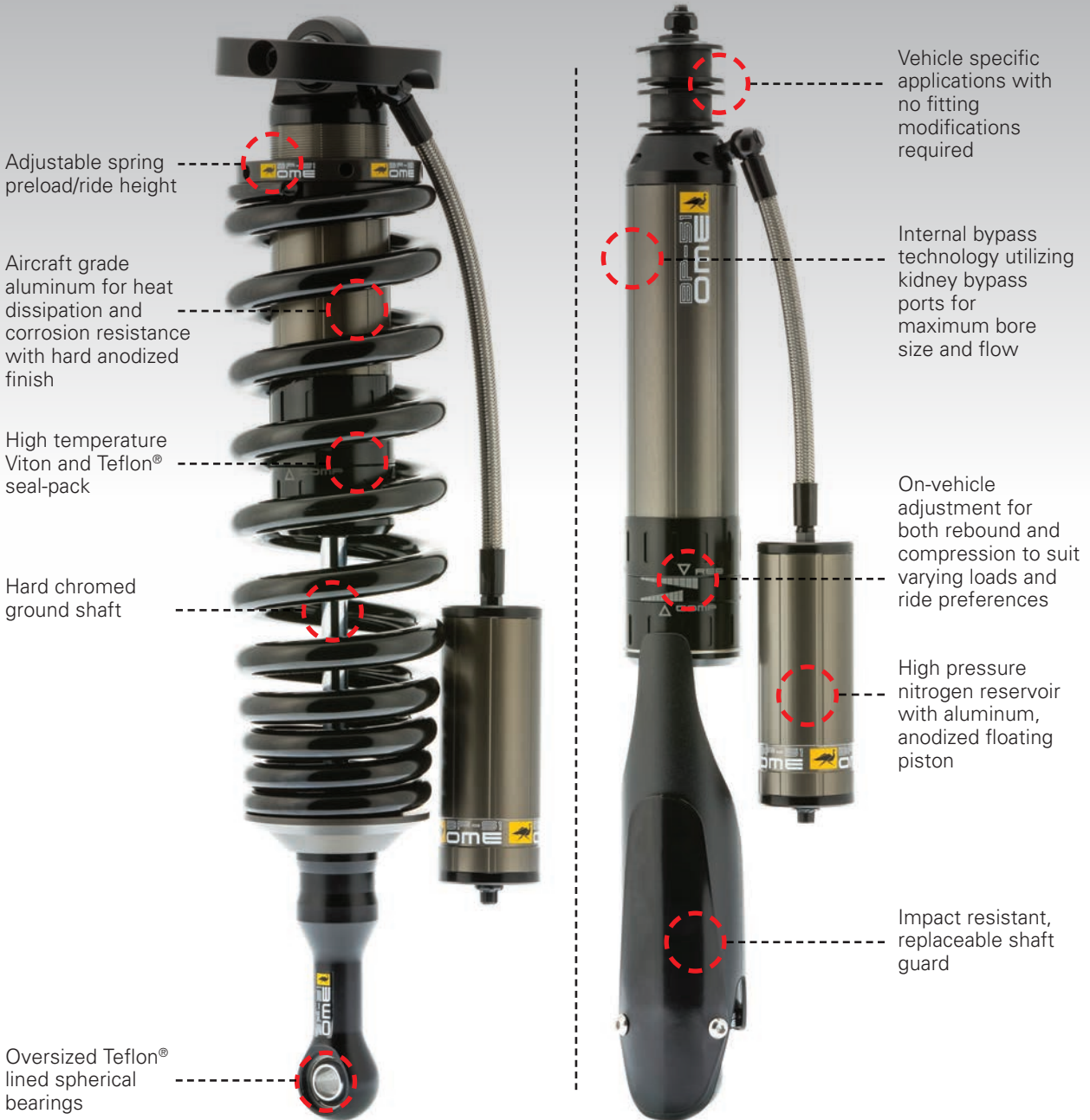

ENGINEERED, DESIGNED AND MANUFACTURED BY ARB 4X4 ACCESSORIES

NITROCHARGER

ARB

SPORT SHOCK ABSORBER



NITROCHARGER SPORT SHOCKS ARE THE NEXT STEP IN VEHICLE SPECIFIC VALVING, AND OFFER THE MOST COHESIVELY BALANCED AND FINELY TUNED SYSTEM ON THE MARKET.

Several Nitrocharger Sport part numbers may be listed for an individual vehicle model. This is because each 4x4 is outfitted differently and each owner may want slightly different ride characteristics. A heavily loaded SUV that is driven on harsh back-country roads for long periods will need a different valving setup than the same model vehicle that is daily driven on pavement, but makes occasional weekend trips to the trails.

A competition line of Nitrocharger Sport shocks is also available. These models incorporate all of the standard features, with additional open length for greater control in off road competitions.

FEATURES:

- Engineered for both on and off road drivability.
- Scientifically proven durability, tested under extensive laboratory and real-world Outback conditions.
- Instantaneously adapts to the terrain due to the latest valving technologies.
- The most finely tuned 4x4 shock absorber on the market, with all tuning completed by in-house Old Man Emu engineers.
- Fully compatible with Old Man Emu's extensive range of springs, bushings, and hardware for a complete integrated suspension system.
- 3 year/35,000 mile warranty.
- Made in Australia.

3 YEAR
35,000 MILE
WARRANTY



OLD MAN EMU
4X4 SUSPENSION BY ARB



NITROCHARGER

THE ADVANTAGE

1 Rod Guide and Piston

The rod guide has been engineered with a less restrictive design and open apertures to ensure more uniform oil flow through the disc stacks, resulting in greater consistent control. This improves control over a higher temperature range—as the shock absorber heats up, oil flow over the valving remains stable, giving dependable fade-free damping.

a Triple Lip Oil Seal

Capable of handling greater internal pressures and higher temperatures, a triple lip oil seal incorporates a gas retention check valve design to virtually eliminate contaminant damage and provide outstanding gas and oil retention.

b Slip Ring

A Teflon infused bronze slip ring has been incorporated into the rod guide design to ensure tight manufacturing tolerances are maintained for consistent performance.

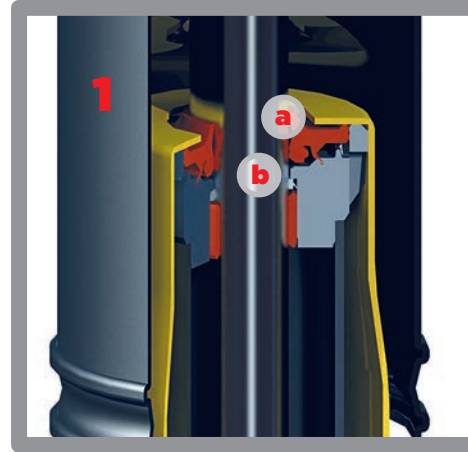

2&3 Multi-Staged Tuning

The combination of the compression and rebound stacks enable OME ride control engineers to produce the most finely tuned 4x4 shocks on the market. Old Man Emu shocks are specifically tailored to individual vehicle models and their driving characteristics to guarantee rapid valving responses and improvements in ride quality, handling and control.

c Piston-Based Compression Stack

Tuned to influence oil flow returning above the piston, this area of compression works in conjunction with the cylinder end compression valving to produce dynamic balance of oil distribution throughout the shock absorber. This permits even greater fine tuning for vehicle specific valving and more comfort over uneven terrain, particularly at slow speeds.

d Piston-Based Rebound Stack

With up to ten discs used to control rebound, this stack allows multi-staging of the mid range for initial control over small road imperfections with heavier and more commanding control when harsher conditions are encountered.

3 Cylinder End Compression Stack

Located at the base of the shock absorber, this stack offers significant valving advantages by combining the bleed disc with five thinner discs. This translates to a more rounded and comfortable ride over patchy and uneven road conditions. By using different diameter discs, a multi-stage compression stack is created to generate a comfortable to ride while a stronger second stage gives more control in rougher conditions.

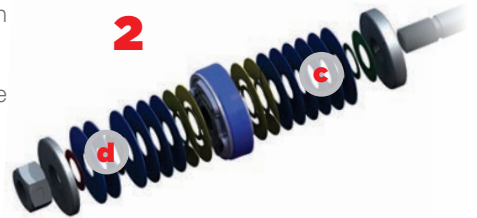

OLD MAN EMU



SPRINGS & HARDWARE



Punishing off road conditions combined with the added weight of gear, fuel and water can push a standard suspension spring to its limits. As part of the integrated 4WD suspension systems, Old Man Emu designs a range of springs for each vehicle. This enables the most appropriate springs to be selected for the vehicle's intended purpose and setup. While ride heights are obtained with Old Man Emu coils, the emphasis is placed on ride control.

COIL SPRINGS

FEATURES:

- Formed on precision mandrels to ensure consistency.
- Constant and variable rate coils available for multiple applications.
- Double scragged before and after shot peening to enhance spring life.
- Durable black powder coat.

LEAF SPRINGS

FEATURES:

- Draw tapered and diamond cut leaves ensure the load is progressively distributed over a larger surface area to reduce stress and increase spring life.
- Bolt clamps and anti-squeak liners.
- Fully scragged and load tested to ensure the spring takes a permanent 'set' which reduces the chance of sagging.
- Military wrap spring ends for added safety.
- Anti-friction nylon pads reduce friction on the leaf tips.
- Flat axle seat area allows for a safe axle mount.
- Shot peening on the tension side of all leaves reduces spring stress and has been shown to potentially double the life of the spring.
- Two-stage leaf pack is featured on most rear springs for optimum comfort when the vehicle is unladen or carrying a heavy load.

PLEASE NOTE: Most Emu Dakar leaf springs have the listed features, but where design or physical limitations exist, one or more features may not be incorporated.

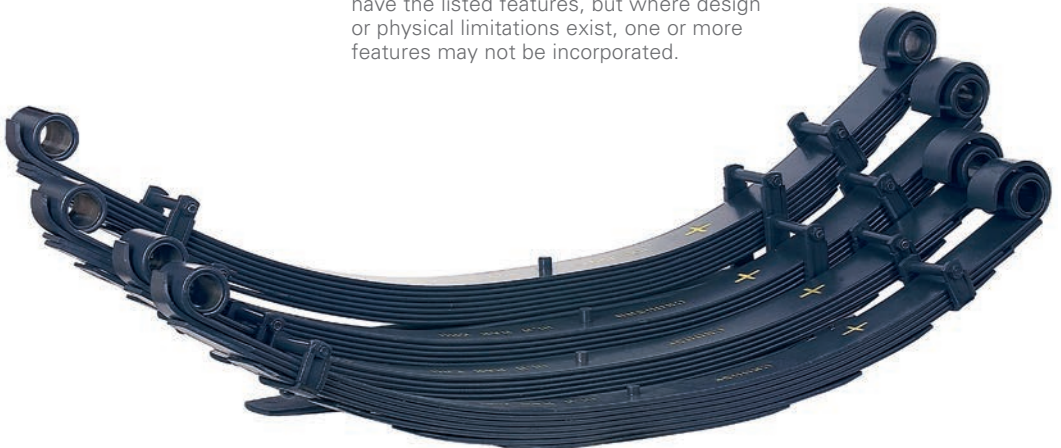

OLD MAN EMU
4X4 SUSPENSION BY ARB



STEERING STABILIZERS

An often-overlooked component to a suspension system, these dampers are designed to reduce the effect and feel of wheel vibration.

FEATURES:

- 9 stage coil spring valving for optimum performance.
- The piston rod is stronger than the factory component.
- Steel or rubber stone guards and twin tube design protect internal components from stone damage.
- 35mm piston and bore provide increased oil volume.

TORSION BARS

Similar to Old Man Emu springs, these torsion bars are designed and set for optimum ride performance, while maintaining maximum wheel travel.

FEATURES:

- Manufactured from premium grade spring steel.
- Precision drawn, dropped forged ends for optimum strength and integrity.
- Pressure rolled splines for precise fitment.

GREASABLE SHACKLES

Old Man Emu's greasable shackles make the necessary task of greasing the leaf spring bushing easy by removing the need to disassemble the shackle itself.

FEATURES:

- Each pin has two grease outlet holes to guarantee grease coverage between the pin and bushing.
- Heat treated pins ensure long pin life, even under heavy loads.
- Side plates are zinc plated for corrosion protection.

BUSHES

OME offers a variety of urethane bush kits for shock absorbers, leaf springs, panhard rods, control arms and sway bars. Unique features like the exclusive splined leaf spring bushes and caster correction kits ensure proper performance.

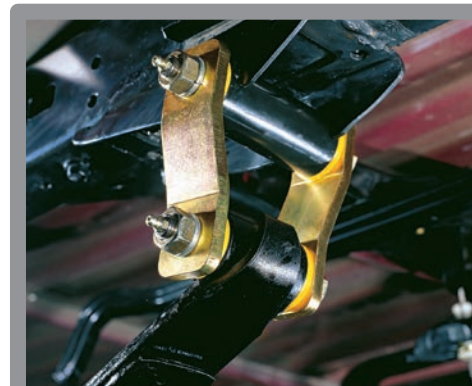



AIRLOCKER 

AIR LOCKERS

THE ORIGINAL. THE TOUGHEST.
STILL THE BEST.

Air Lockers give you on-demand traction on the toughest terrain. A common misconception is that all four wheels on a 4-wheel drive vehicle receive the same amount of drive.

When one wheel on an axle has more traction than the other, the traditional open differential will send power to the wheel with the least amount of traction and none to where you need it.

Replacing the standard differential, ARB Air Lockers use compressed air to activate a clutch gear within the differential, which mechanically locks the axle shafts together. This ensures that equal power is sent to both wheels, giving you traction when you need it.

The ability to activate and deactivate the locking mechanism in the differential means that the Air Locker is completely selectable, giving the driver full control. When deactivated, Air Lockers provide all of the safety and predictability of a factory open differential. This is something that auto-lockers cannot claim.

Air Lockers can enhance the ability of your vehicle whether it is tackling rock, clay, gravel, sand, snow or mud.



AIR LOCKERS



FEATURES & PARTS

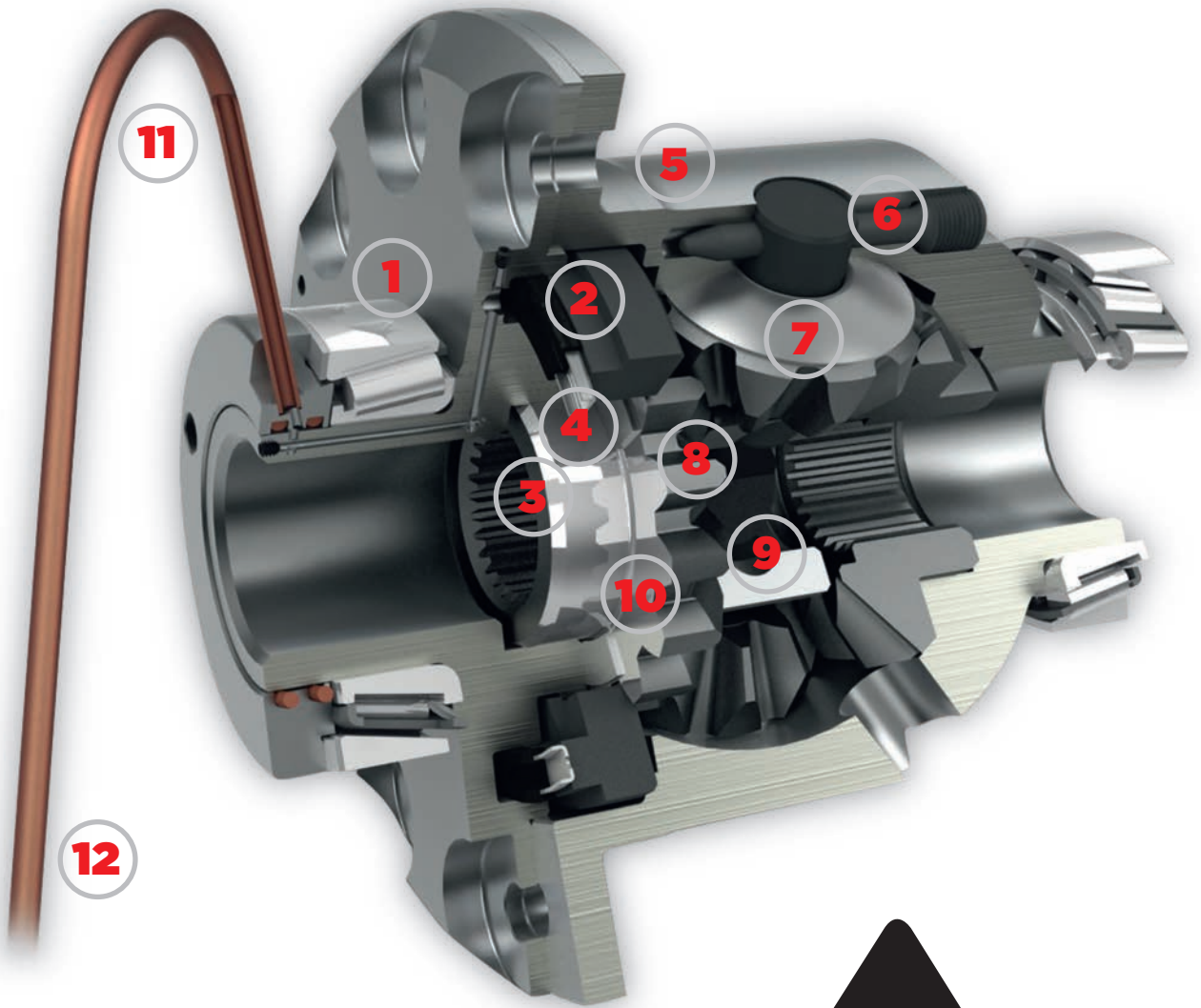



1

FLANGE CAP ASSEMBLY

Fully machined, nodular iron cap incorporates ARB's proven and patented locking mechanism.



2

CLUTCH GEAR

Actuated by air pressure, this gear locks the splined side gear to the differential case.



3

BONDED SEAL

Proven to handle over 20,000+ cycles under extreme temperatures, the steel reinforced, elastomer bonded annular seal is used to actuate the clutch gear when the pressurized air is delivered into the differential.

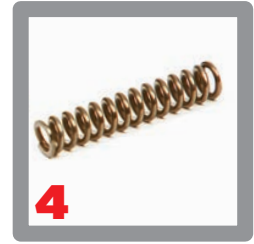

4

RETURN SPRING

Rapid disengagement of the clutch gear occurs on demand, quickly unlocking the Air Locker, due to the springs that are positioned around the profile of the gear.



5

DIFF CASE

Fully machined, one piece nodular iron diff carrier case offers superior rigidity and strength when compared to factory open differentials and other selectable lockers.



6

CROSS SHAFT RETAINING PIN

Hardened pins that utilize a tapered thread to hold cross shafts in place.



7

PINION GEAR

ARB has redefined differential gear tooth geometry by utilizing a design that yields a sizable 30% structural advantage over commercially available gears.



8

LONG CROSS SHAFT

Alloy steels and surface technology make for a high pressure running fit that can handle enormous amounts of punishment.

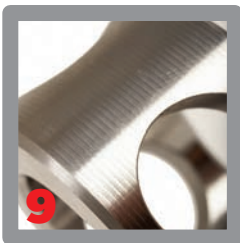

9

SPIDER BLOCK

A billet machined alloy steel spider block supports the cross shafts, using torque from each shaft to support the next shaft along.



10

SPLINED SIDE GEAR

The clutch gear locks the outer teeth of this forged gear to the flange cap when the Air Locker is activated.



11

AIR SUPPLY

With the flip of a dash-mounted switch, compressed air is delivered into the axle housing and differential via a nylon air line.



12

SOLENOID VALVE

Sealed against moisture and dust, this electromagnetic valve controls the release of pressurized air to the Air Locker.

AIR LOCKERS

DESIGN & MANUFACTURING



ARB Air Lockers are designed and manufactured in Melbourne, Australia where five full-time engineers utilize state of the art computer modeling and testing technology. With the introduction of forged gears and the two-piece case design across the full line of Air Locker models, the strength and durability of these products has never been higher.

The ongoing design and testing of the Air Locker product line involves the utilization of both virtual and real-world testing. Engineers put designs through computerized Finite Element Analysis (FEA), destructive laboratory testing and extreme environmental tests that subject the Air Locker to severe temperature variances. Prototypes are tested to ensure that the strength of the Air Locker exceeds that of all other driveline components.

For additional peace of mind, all ARB Air Lockers are backed by a five year warranty.

AIR COMPRESSOR AND INSTALLATION

A qualified differential technician should perform installation, although no special tools or skills are required apart from those necessary for the installation of a factory differential. Each Air Locker is packaged with the necessary installation parts including the nylon airline, axle bulkhead fittings, solenoid and dash switch.

ARB has a full line of compressors suited to provide the necessary compressed air for the engagement of the Air Locker. Using an ARB air compressor is the easiest way to achieve a complete system, as they are specifically designed to work with the Air Locker. Several air compressor models are engineered and designed to serve as an on-board air system to re-inflate tires, air mattresses or operate pneumatic tools. To learn more about the ARB line of air compressors, please see page 34-35.

AIR LOCKERS

PERFORMANCE & COMPETITION MODELS

Used by some of the biggest names in off road competition around the world, a number of unique Air Locker models are built specifically to exceed the needs of the most demanding applications. These models are designed to withstand more torque than any standard differential would ever see. This need is due to the high horsepower engines and high-strength aftermarket axle shafts that these custom vehicles are running. Special applications range from off road racing and rock crawling, to drag racing.



FOR ANYONE WHO TAKES TO THE TRAILS, VERY FEW ACCESSORIES OFFER AS MANY ADVANTAGES AS HAVING A PREMIUM QUALITY AIR COMPRESSOR.

Considered a staple for anyone traveling into remote areas, ARB's air compressors are designed to provide on-demand compressed air for the task at hand, including tire inflation, operating pneumatic tools or activating an Air Locker.

Designed to withstand harsh conditions, the range incorporates vehicle mounted and portable compressors. Each unit is individually tested for leaks, current draw and airflow at the factory before being packaged, and come with a comprehensive two-year warranty.



AIR COMPRESSORS & TIRE ACCESSORIES

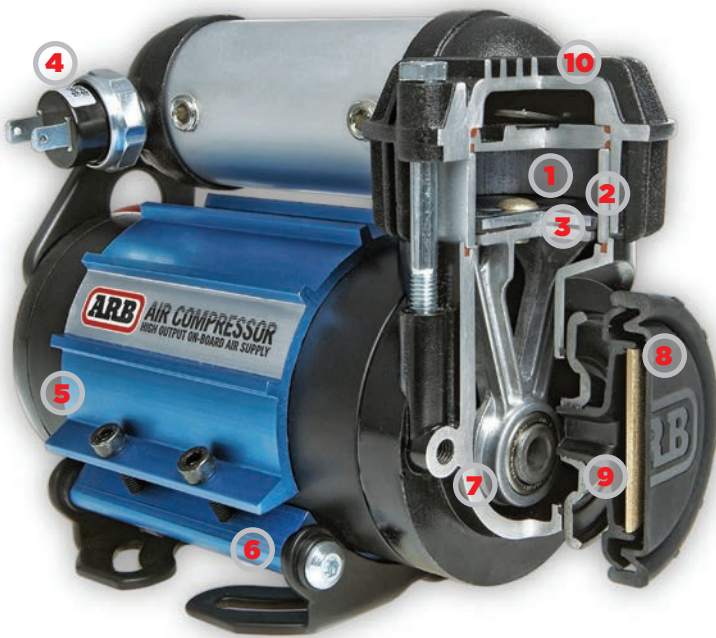

High Performance (CKMA12) Features:

- 1 Hard-anodized cylinder bore for reduced friction.
- 2 Fully sealed components for moisture and dust resistance.
- 3 Teflon impregnated carbon fiber seal for maximum trouble-free life.
- 4 Pressure switch controlled air manifold system specially designed to suit all ARB Air Locker equipped vehicles.
- 5 Rotatable anodized mounting bracket dissipates motor heat.
- 6 Anti-vibration grommets are integrated into the mounting system.
- 7 Compressor piston is equipped with a German-made cylindrical roller bearing.
- 8 Relocatable splash resistant air filter assembly allows for versatile intake positioning.
- 9 High density and high flow sintered bronze air filter element.
- 10 High strength cast aluminum construction.

ARB VEHICLE MOUNTED AIR COMPRESSORS

Compact Compressor (CKSA12)

This compact solution has been specifically designed to activate ARB Air Lockers.

- Small size with a multi-position mounting bracket.
- Sealed for moisture and dust resistance.
- Simplified power harness allows for versatile positioning.

High Performance Compressor (CKMA12)

Activate Air Lockers and inflate tires or other items with this model.

- A full wiring harness and pressure switch are included.
- Multi-position mounting bracket eases installation.
- Fully sealed to ensure a long service life.
- Designed to provide air for most inflation needs.

Approx. Inflation Time (minutes/tire)

	0-30 psi	15-30 psi
31x10.5R15	2:34	1:11
33x12.5R15	3:53	1:45
35x12.5R15	5:15	3:00



Twin Motor Compressor (CKMTA12)

The maximum performance, twin motor, dual cylinder compressor is suitable for operating air tools, tire inflation and activating Air Locker.

- Compresses 6.16 cubic feet per minute (CFM).
- Utilizes lightweight, high strength materials and quality components throughout the construction.
- Features a 100% duty cycle.
- Necessary wiring harness, pressure switch and dash isolation switch are included.

Approx. Inflation Time (minutes/tire)

	0-30 psi	15-30 psi
33x12.5R15	2:06	0:55
35x12.5R15	2:18	1:00
37x12.5R17	2:47	1:40





PORTABLE AIR COMPRESSORS



Twin Motor Portable (CKMTP12)

- Compact sized air source that has the ability to create a high volume of air for large tires and pneumatic tools applicable in both recreational and industrial markets.
- Ultra compact twin motor, dual cylinder design makes it the highest flowing compressor of its size.
- Integrated one gallon aluminum air tank.
- Sealed cooling fan dissipates heat, allowing for 100% duty cycle.
- Mounted in a waterproof carry case.
- Comes with a 20ft air hose and battery clip power harness.

High Performance Portable (CKMP12)

- Engineered to suit any off road adventure.
- Based on the same motor as the High Performance on-board model (CKMA12).
- Mounted in a durable case for easy carrying and storage.
- Comes with a 20ft air hose, battery clip power harness and all the necessary fittings to inflate tires or miscellaneous leisure gear.



TIRE ACCESSORIES

(171302)

Inflation Kit (171302)

Includes a unique high-heat tolerant hose and a dust free air chuck that boasts an enclosed bearing system to prevent dirt ingestion. It also comes with a tire filler attachment and extra nozzle attachments for inflating items such as sports balls, air mattresses, etc.



Speedy Seal Tire Repair Kit (10000010)

This compact kit includes all the necessary components to repair a tire puncture, making it a must-have piece of emergency equipment.



Tire Inflator (ARB605)

A quick and accurate inflator with an in-line gauge and a clip on chuck makes tire inflation a breeze.

E-Z Tire Deflator (ARB505)

The unique design of the E-Z deflator allows for the removal of a tire's valve core for rapid tire deflation, while also providing accurate pressure reading via the simple movement of a sliding valve.

Air Tanks

- One Gallon Tank (171601)

Incorporating forged aluminum with two JIC4 ports, this tank is designed to be hard mounted and serve as a reservoir for the use of air tools.

- Manifold (171503)

Small, mountable manifold body with dedicated ports for the installation of Air Locker solenoids along with two other 1/4" NPT ports.



(ARB505)

Other Accessories

To complement the full line of compressors, ARB offers multiple air chucks and pressure gauges to complete your tool kit.

(ARB605)



(171503)



(171601)





FRIDGE FREEZERS

LOSE THE ICE.



The result of years of research and development, ARB Fridge Freezers incorporate four feature-packed sizes specifically designed to perform in the toughest conditions.



FRIDGE FEATURES FREEZERS

Whether it's a weekend road trip or a long distance expedition, this line of fridges provide the convenience of having cold food and drinks no matter where adventure leads. The extensive list of features is an indication of the depth of design that was dedicated to making these fridges easy to use. A very low power draw and voltage cutoff ensure peace of mind.

INTERNAL FEATURES



INTERNAL LED LIGHT

Low power draw LED light utilizes a hidden magnetic switch to turn off light when the lid closes.

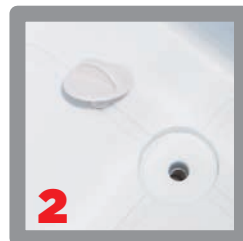

DRAIN PLUG

Integrated into the base of the fridge for effortless cleaning.



INTEGRATED EVAPORATOR

Designed as a part of the internal cabinet, ensuring optimal use of internal space and simplified cleaning.



SECOP COMPRESSOR

Highest quality compressor with a smart control system, which enables rapid cooling to the desired target temperature.



REVERSIBLE BASKET WITH DIVIDER

Allows for multiple storage options of the fridge's contents.



1 DURABLE CASE
 Sturdy powder coated steel cabinet sides designed to withstand even the harshest conditions.

EXTERNAL FEATURES



DURABLE DETENT HINGE
 Stainless steel hinge allows the lid to be released and securely slid back into place.



LID AND INTEGRATED SEAL
 Tough, injection molded lid incorporates a recessed seal to increase cooling efficiency.



CONTROL PANEL
 Easy to use with a bright temperature display.



RECESSED HANDLES
 Integrated into the cabinet to provide an easy location for lifting and doubles as a tie down point.



FRONT LATCH
 Large and simple to use, this latch provides a positive seal between the lid and cabinet.



RUBBER FEET
 Attached to the fridge base to increase grip and stability.



FRIDGE SIZES & ACCESSORIES FREEZERS

Available in four user-friendly capacities, the ARB Fridge Freezer suits a myriad of situations, from fishing and weekend camping to serious off road trips.

37QT FRIDGE

#10800352



CAPACITY

37qts

COOLING CAPACITY

50°F to 0°F

WEIGHT

45.6lbs

EXTERNAL DIMENSIONS

H16.9" x W15" x D27.8"

INTERNAL DIMENSIONS

Dairy/Fruit Compartment:
H5" x W11.2" x D6"

Main Compartment:
H12.6" x W11.2" x D13.3"

POWER

Built-in 12/24V DC and
100~240V AC power
Integrated battery
protection system

50QT FRIDGE

#10800472



CAPACITY

50qts

COOLING CAPACITY

50°F to 0°F

WEIGHT

49.6lbs

EXTERNAL DIMENSIONS

H20" x W15" x D27.8"

INTERNAL DIMENSIONS

Dairy/Fruit Compartment:
H8.1" x W11.2" x D6"

Main Compartment:
H15.8" x W11.2" x D13.3"

POWER

Built-in 12/24V DC and
100~240V AC power
Integrated battery
protection system

63QT FRIDGE

#10800602



CAPACITY

63qts

COOLING CAPACITY

50°F to 0°F

WEIGHT

54lbs

EXTERNAL DIMENSIONS

H16.9" x W17.7" x D33.3"

INTERNAL DIMENSIONS

Dairy/Fruit Compartment:
H5" x W14" x D6"

Main Compartment:
H12.6" x W14" x D18.8"

POWER

Built-in 12/24V DC and
100~240V AC power
Integrated battery
protection system



82QT FRIDGE

#10800782

CAPACITY

82qts

COOLING CAPACITY

50°F to 0°F

WEIGHT

59.7lbs

EXTERNAL DIMENSIONS

H20" x W17.7" x D33.3"

INTERNAL DIMENSIONS

Dairy/Fruit Compartment:
H8.1" x W14" x D6"

Main Compartment:
H15.8" x W14" x D18.8"

POWER

Built-in 12/24V DC and
100~240V AC power
Integrated battery
protection system



A full line of quality accessories are available to protect and increase the functionality of your ARB Fridge Freezer.

1 Tie Down System (10900010)

Simplify the process of securing your fridge with this strong clamp, webbing, and metal cam buckle system. Adaptor brackets and stainless steel hardware ensure the installation is stress free.

2 Wiring Loom (10900027)

Ideal for running power to the rear of any vehicle, this wiring loom can power a multitude of accessories, including the ARB Fridge Freezer. Designed specifically to eliminate problematic voltage drop that is found in many inadequate factory systems, this kit ensures you have power right where you need it, and includes 20ft (6m) of insulated cable and surface mount socket to complete the kit.

3 Remote Fridge Monitor (10900026)

Keep an eye on the operating status of the ARB Fridge Freezer from the driver seat. Display efficiently shows current temperature, voltage use, and compressor status on a backlit LCD screen. Information is wirelessly transmitted over 50ft, ideal for enthusiasts who keep their fridge in a trailer, RV, or camper.

4 Fridge Slides

The practical and simple answer to gaining easy access to the cold food stored in an ARB Fridge Freezer, the line is designed to accommodate the range of fridges. Sealed roller bearings ensure the slide rolls smoothly each time you need access to your fridge, while an integrated locking mechanism ensures that the slide stays where you want it to, regardless of the incline. Designed to work in conjunction with the ARB tie down system, the fridge slide is available in a number of sizes.

- Standard 37qt & 50qt Slide – (10900021)
- Standard 63qt & 82qt Slide – (10900022)
- Extended Length 37qt & 50qt Slide – (10900029)

5 Transit Bag

Designed to protect the ARB Fridge Freezer from dents and scratches, the transit bag is made of tough, durable navy blue canvas. The transit bag also features openings for the fridge's rubber feet, drain plug, and power cables for added versatility.

- 37qt – (10900012)
- 63qt – (10900014)
- 50qt – (10900013)
- 82qt – (10900015)



ROOF RACKS



**ARB ROOF RACK
STEEL**



RENOWNED FOR THEIR DURABILITY AND USER PRACTICALITY, A ROOF RACK IS A VERSATILE ACCESSORY—EFFECTIVELY INCREASING A VEHICLE'S LOAD CARRYING CAPABILITY AND INTERIOR RIDING COMFORT.

Perfectly suited for the demands of load carrying, whether it is for work, a weekend on the trail, or an expedition, ARB's Roof Racks are available in either steel or aluminum. Depending on your vehicle model, there are many different sized racks to fit a range of vehicles.

Steel racks come with spaced crossbar supports or with an optional steel mesh floor. Aluminum racks are 40% lighter than similar ARB steel racks, but maintain the same strength and load ratings. Mounting systems are sold separately for custom or application specific platforms.

TOURING RACK





ARB ROOF RACK ALUMINUM

- 1** ARB's alloy racks utilize quality aluminum, making them 40% lighter than ARB's steel roof racks.
- 2** An Amplimesh® alloy mesh floor comes standard on the Aluminum Series, (rated to carry up to 330lbs).
- 3** A combination of TIG and the acclaimed CMT (cold metal transfer) revolutionary welding process is used to ensure the optimum strength of each rack.
- 4** Top rail sits well above rack floor to ensure a secure load.
- 5** Top rail is constructed from tough, 1" tube, while the bottom rail utilizes 1.40" tubing.
- 6** Rails are bent with a mandrel bender, ensuring consistency and even wall thickness across all sections.
- 7** Millennium gray powder coat with zinc-rich primer gives 1000 hours of salt spray resistance.
- 8** Air deflector plate significantly reduces wind noise.
- 9** Full length, zinc annealed steel support channel with plastic protection strip to distribute the load along the gutter and prevent vehicle damage.
- 10** Pressed steel feet and legs are height and width adjustable, allowing for multi-vehicle installations.
- 11** Stainless steel fitting hardware.
- 12** Unique, super-strong clamping system that's easy to install and remove.
- 13** Variable height fitting kits allow even greater flexibility for multi-vehicle applications.



Specifically designed to mount an ARB Roof Top Tent, while still allowing for gear storage towards the front of the vehicle.



A fully welded steel mesh floor can be optioned if extra support for gear is desired.



CAMPING & TOURING

COMFORT.
OFF THE GROUND.

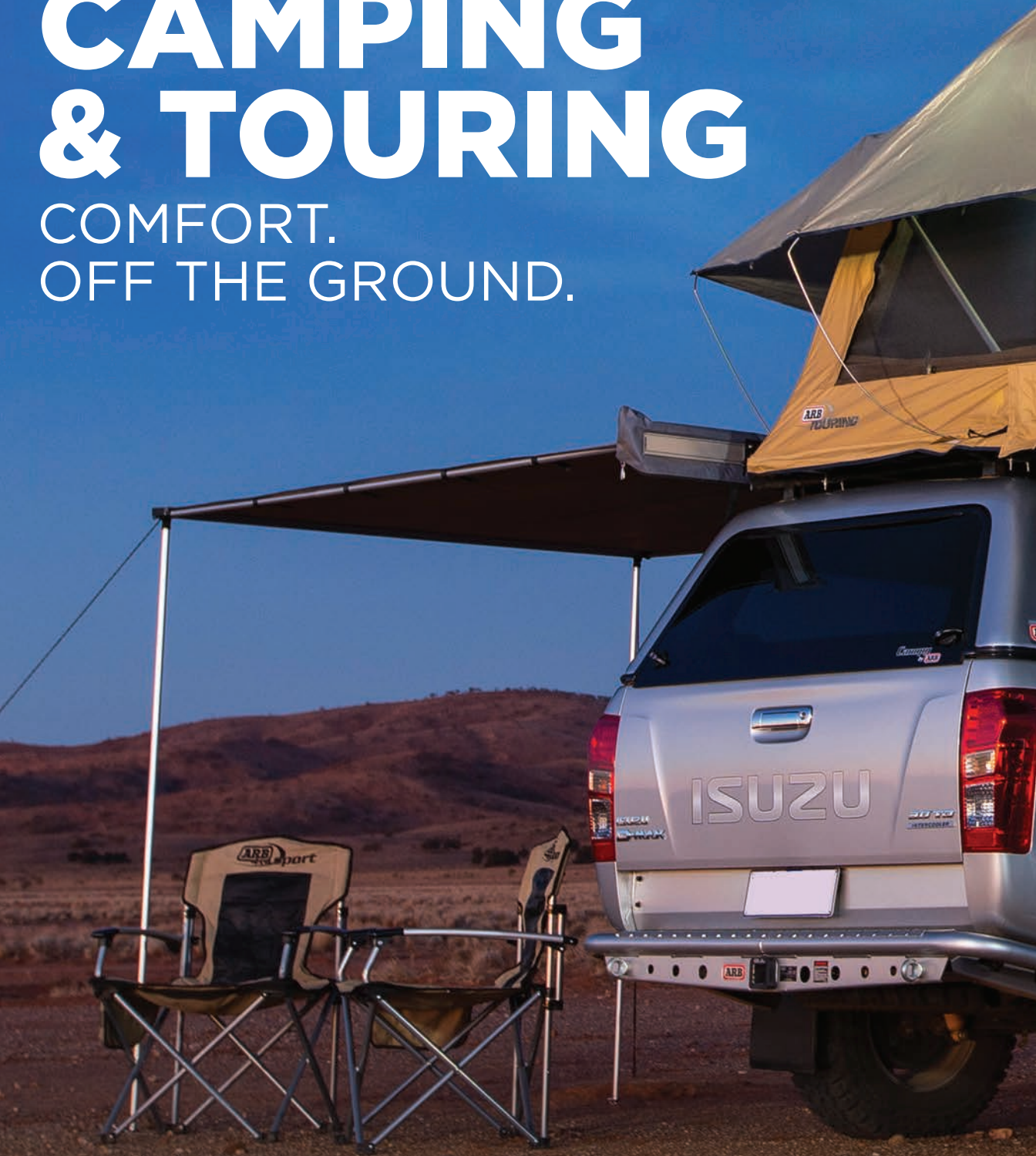





ROOFTOP TENTS

ON THE TRAIL OR ON THE ROAD—COMFORT AND A GOOD NIGHT'S SLEEP CAN BE FOUND IN THESE CONVENIENT, EASY TO SET UP ROOF-MOUNTED TENTS.

Series III Simpson (ARB3201)

The two side windows are protected by a canvas awning, which is held in place by easy-to-use spring rods. The flysheet covers the larger, single window opposite the entrance. The extendable veranda and optional annex (ARB3102) provides added space and protection from the elements at the base of the tent.





Kakadu (ARB4101A)

Designed for warm climates, this tent features large windows for increased ventilation, while the flysheet is held taught by eight spring rods for protection in adverse conditions. The Kakadu is specifically designed for fitment to trailers and utility/pick-up vehicles with low height requirements.





AWNINGS & ACCESSORIES



FIND SHELTER ANYWHERE YOU SET UP CAMP.

Awnings

These retractable awnings offer fast and convenient protection from the elements.

- Manufactured from poly/cotton ripstop canvas, which meets current fire retardant standards.
- Self-standing design is deployable in 30 seconds.
- Provides UV protection and is waterproof.
- Easily mounted to most roof racks or bars.
- Height adjustable with telescopic legs (includes guy ropes and pegs).
- Stores in a UV stable PVC bag.
- Available in three widths:

- ARB3110A – 1250 Model • 49.21" (1250mm) W x 82.50" (2100mm) extended
- ARB4402A – 2000 Model • 78.74" (2000mm) W x 98.43" (2500mm) extended
- ARB4401A – 2500 Model • 98.43" (2500mm) W x 98.43" (2500mm) extended

Mosquito Nets

- Manufactured from 48gsm midge proof mesh to provide a comfortable space to eat and relax.
- Mud/storm flap and double stitching for additional strength.
- Hardened steel pegs included for anchoring the room to the ground.
- Available for the two larger sized awnings and various extended lengths. Check online for which models fit different generation ARB awnings.

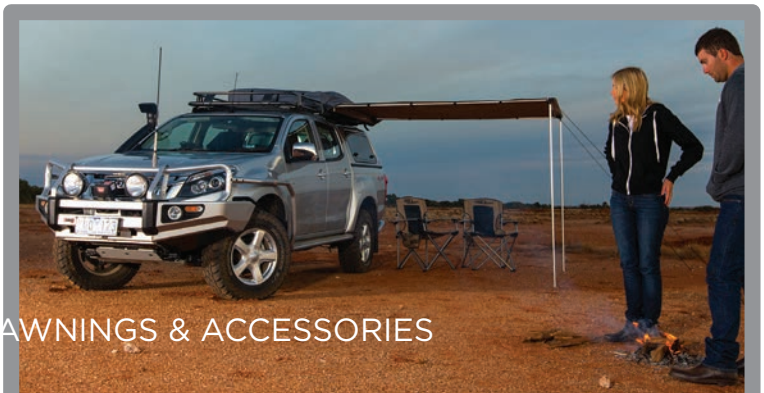



Wind Break

- Ideal for creating extra protection and space under the awning.
- Lightweight and waterproof with UVP 50+ rated material secures wind break to the awning.
- Different models designed to suit the different awning sizes:
 - ARB4403A – Fits 2500 Awning (Front)
 - ARB4410A – Fits 2000 Awning (Front)
 - ARB4405A – Fits 1250 Awning (Front)
 - ARB4404A – (Side) for All Sizes

Awning Room with Floor

- Functions as a fully enclosed room.
- Durable floor, two large mesh windows with roll blinds and zippered door.
- The rear wall features a central door for access to a vehicle door.
- Attaches to the underside of the awning through the use of clips attaching to the awning arms and legs.
- Various dimensional layouts available to fit current and older generations of ARB awnings.

Three Wall Set

- Comprised of three individual walls that wrap around the outside of awning legs and zip together.
- Each wall can be used individually, as a pair, or a set.
- Two sides feature a window and a blind. The blind can be anchored out at an angle for rain protection.
- One wall features a zippered door section that can also be rolled up for easy access.
- The bottom of each wall is a mud flap with adjustable tension straps for securing the walls to the ground.
- Various dimensional layouts available to fit current and older generations of ARB awnings.

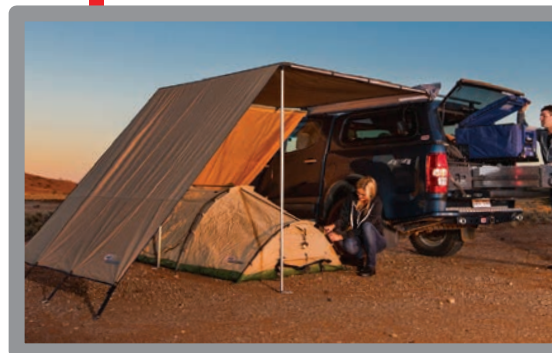





OUTBACK SOLUTIONS DRAWERS



Every vehicle has slightly different storage necessities. The Outback Solutions line of modular drawers provides a storage solution tailored for any vehicle and need.

Quality components go into these drawers to ensure the maximum functionality of a vehicle's storage space whether it is camping gear and an ARB Fridge Freezer, or tools and sensitive equipment. Single unit, two drawers side by side or stacked modules are available to provide over 200 bolt-together configurations.

DRAWERS

FEATURES



Standard Drawer Stack (L&R) ▲



- 1 Modular design allows for individualized setup and installation.
- 2 Different sizes and lengths available to suit any vehicle.
- 3 3 types of modules (roller drawer, roller drawer with roller floor, and roller floor).
- 4 Engineered to hold up to rough off road conditions.
- 5 Push-pull slam shut latches that are key-lockable for security and ease of use.
- 6 Long lasting UV stable commercial carpet to complement modern vehicle interiors.
- 7 Vehicle specific and universal side floor kits provide the perfect fit and finish.
- 8 Stainless steel runners provide smooth drawer and slide operation.
- 9 Cross folded floor provides strong support for stored items.
- 10 Drawers and slides self-lock at full extension.



Single Drawer & Roller Floor
 Jeep JK Unlimited -
 (2010+) 5012010



Roller Floor ▲



Two Roller Floors (L&R) ▲



Two Standard Drawers (L&R) ▲



**Roller Floor (L) with
 Standard Drawer Stack (R) ▲**



GENERAL ACCESSORIES



GET OUT THERE WITH ALL THE LATEST GEAR SPECIFICALLY DESIGNED FOR VEHICLE-BASED TRAVEL ANYWHERE YOU WANT TO GO.

Differential Breather Kit (170112)

This kit is a universal piece of hardware that replaces factory breathers with a high-flow, zero backpressure system to prevent water ingestion into a vehicle's axles, transmission or transfer case. Fittings and hose for two assemblies are included with the aluminum manifold.

NOTE: With additional fittings, the manifold can be connected with four breather lines.





1 Sport Chair (10500100)

2 Air Locker Camp Chair (10500110)

Sit back in comfort and style in these camping chairs. Rated up to 264lb, each comes with a padded backrest, side pockets, drink holder and a carry bag for storage.

3 Storm Bags

Pack up the gear and toss these bags up on a roof rack with confidence. Water-resistant thanks to their PU coated Oxford weave fabric, rubberized construction and the taped and sealed seams, these storm proof bags are perfect for carrying gear wherever your travels take you. The roll up top closure creates a hassle-free water resistant seal, so they can be loaded up on a roof rack with the confidence that the gear inside will remain dry.

Large - (10100350) Small - (10100300)

4 LED Adventure Light (10500010)

Drawing just one amp or less, these tough and compact 12V lights are perfect for setting up camp or performing trail side maintenance due to their incredibly bright and efficient LED panel.





SAFARI SNORKELS



A BREATH OF FRESH AIR

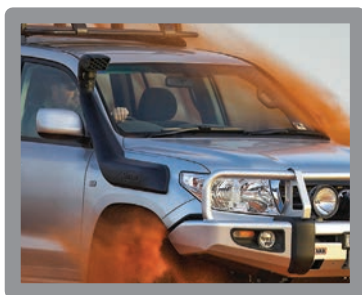

PROTECT YOUR VEHICLE AGAINST DUST AND WATER INGESTION WITH A RAISED AIR INTAKE SNORKEL.

Safari snorkels relocate an engine's air intake from a relatively low, vulnerable position to a higher and safer location where a constant source of cool, clean air is available. The unique Safari Charge Air Ram incorporates a highly effective water separator system that removes rainwater from the incoming air stream, ensuring safe vehicle operation even in torrential downpours.

FEATURES:

- UV stable, premium polyethylene construction.
- Offered in vehicle specific platform applications to ensure top of the line fit and appearance.
- High flow design ensures airflow exceeds engine requirements.
- Each individual component is designed for maximum dust and water sealing.
- Designed and manufactured in Australia.







RECOVERY EQUIPMENT

DESIGNED TO HANDLE ANY RECOVERY SITUATION, NO MATTER THE CONDITIONS.

ARB vehicle recovery accessories are engineered and manufactured to the highest standards to suit any vehicle and environment. Having high quality recovery gear is essential to be prepared for any situation.





Basic Recovery Kit (RK11)

Essentials that every off-road enthusiast should have in their vehicle for the unexpected.

Includes:

- 17,500lb snatch strap
- 26,500lb tree trunk protector
- 19,800lb snatch block
- 2 shackles
- Storage bag

Premium Recovery Kit (Rk9)

Keep all of the necessary gear to perform a recovery in one thorough and complete kit.

Includes:

- 17,500lb snatch strap
- 9,900lb winch extension strap
- 26,500lb tree trunk protector
- 19,800lb snatch block
- Recovery damper
- 2 shackles and gloves
- Storage bag



RECOVERY EQUIPMENT



Snatch Straps

ARB snatch straps are designed to stretch and return to their original length, allowing for the transfer of kinetic energy into the recovery generating more recovery power and reducing the chance of vehicle damage. The 17,500lb strap is suitable for most 4WD vehicles, with the 24,000lb and 33,000lb straps better suited to heavier applications.

Part Number:	ARB705	ARB710	ARB715
Min. Break Strength:	17,500lb	24,000lb	33,000lb
Length:	30ft	30ft	30ft
Width:	2 3/8in	3 1/8in	4 1/3in
Stretch (genuine):	20%	20%	20%
Material:	100% nylon	100% nylon	100% nylon
Reinforced Eyes:	Yes	Yes	Yes
Eye/Seam Protector Sleeves:	Yes	Yes	Yes

Winch Extension Straps

ARB winch extension straps are the ideal way to extend the length of your winch cable's length when an anchor point is out of reach.

Part Number:	ARB720	ARB725
Min. Break Strength:	9,900lb	17,500lb
Length:	66ft	66ft
Width:	2 1/8in	3 1/8in
Material:	100% polyester	100% polyester
Reinforced Eyes:	Yes	Yes
Eye/Seam Protector Sleeves:	Yes	Yes



Tree Trunk Protectors

Prevent damaging your winch cable and protect the trees you use as anchor points with the wide 3 1/8" webbing of these tree trunk protectors.

Part Number:	ARB730	ARB735
Min. Break Strength:	26,500lb	26,500lb
Length:	10ft	16ft
Width:	3 1/8in	3 1/8in
Material:	100% polyester	100% polyester
Reinforced Eyes:	Yes	Yes
Eye/Seam Protector Sleeves:	Yes	Yes

(ARB501)

(ARB502)



(ARB503)

Recovery Equipment Bags

A full line of recovery bags have been designed by ARB for the storage of recovery equipment, with sizes available to stow everything from a full kit to a single strap and shackles.

Large - ARB501
Small - ARB502

Compact - ARB503
Micro - ARB504



Snatch Blocks

An incredibly useful and a necessary piece of equipment when on the trail, ARB's Snatch Blocks allow the retrieval of loads by doubling a winch's capability.

Part Number:	ARB209A	10100020A
Working Load:	15,400lb	19,800lb
Breaking Strain:	31,900lb	38,500lb
Side Plate Material:	3/16in Cold rolled steel	1/5in Cold rolled steel
Pulley Material:	Solid billet steel	Specialized polymer
Pulley Diameter:	3 2/3in	4 1/3in
Cable Size:	1/4in — 1/2in	1/3in — 1/2in
Weight:	7.7lb	5.3lb
Greasable:	Yes	Not required

(ARB209A)

(10100020A)



Recovery Damper (ARB220)

A great precautionary item to have, the ARB Damper is manufactured of heavy duty vinyl and features pockets for added convenience.



X-Jack Exhaust Jack (72X10)

An invaluable, inflatable recovery tool, the exhaust jack provides 30" of lift on soft surfaces such as sand, mud and snow.

FEATURES:

- 8,800lb lifting capacity.
- Wide footprint provides a stable base in unpredictable areas of mud, snow and sand.
- Can be inflated with vehicle exhaust or compressed air.
- Triple layer construction for added durability.
- Collapses flat for easy storage.





AUXILIARY DRIVING LIGHTS

ADVENTURES DON'T END
WHEN THE SUN SETS.





LIGHTING

ARB

INTENSITY LED DRIVING LIGHTS



ARB

INTENSITY

NEXT GENERATION LED DRIVING LIGHTS

Engineered in Australia and manufactured in the USA, the ARB intensity LED light range delivers outstanding performance in all conditions.

Available in a spot or flood beam, Intensity LED driving lights are vastly more efficient than traditional halogen lamps, producing a white light that is the closest possible color to sunlight. This reduces eyestrain and driver fatigue.

The lights feature a heatsink with numerous fins to ensure the LEDs run as cool as possible and produce an optimum light output, while also extending the light's longevity.

ARB Intensity LED lights are engineered to withstand long periods of extreme conditions and are vibration certified to military standards, while also featuring a dust and waterproof to a IP68 rating, while also being submersible to 3m.

ARB Intensity LED driving lights are available in two sizes. The AR32 models feature 32 LEDs with a 50,000+ hour lifespan. The AR21 models utilize 21 LEDs and were designed as a smaller alternative to the larger light.

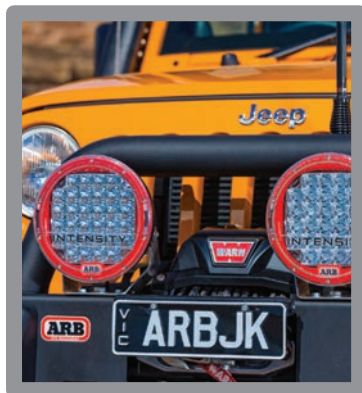

AR32

Virtually unbreakable, scratch resistant lens.

AR21

Stylish, adjustable, stainless steel mounting bracket.



High pressure cast aluminum body, specifically engineered for the rigors of off road driving.

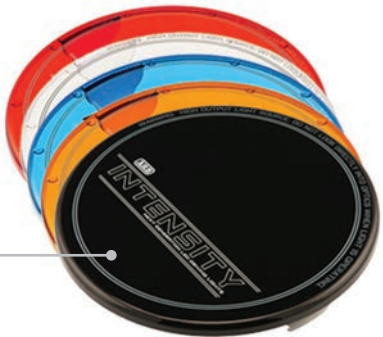

A variety of accessory light covers are available to further enhance overall light utility.



LIGHTING



IPF DRIVING LIGHTS & ACCESSORIES



IPF

IPF High Intensity Discharge (HID) 900 HID Series Lights

- Available in spot or driving beam.
- HID bulb and ballast provides an incredibly powerful yet energy efficient 'true' white light.
- Hardened glass lens and heavy gauge steel body.
- Internally mounted ballast, secured behind the reflector.
- Supplied individually, with a cover.
- Dimensions: 8.5" H x 8" W x 4.5" D
- Spot Beam – (901HIDDG), Driving Beam – (901HIDSG)



800/901 Xtreme Sport Series Lights

- Available in spot or driving beam.
- Advanced 100W H9 bulb delivers an unmatched output utilizing an optimized bulb design.
- Hardened glass lens and heavy gauge steel body.
- Waterproof connections and loom.
- Kits includes: 2 lights, wiring loom, relay, switch, guards/covers.
- Multiple styles of paired beam patterns available as kits.
- Dual Beam Kit – (900DB) - A dual-beam system utilizing a high performance H4 bulb to provide selectable low and high beam patterns.
- Dimensions:
 - Rectangular: 6.5”H x 8.5”W x 4.5”D
 - Round: 8.5”H x 8”W x 4.5”D



800 Series



901 Series

868/968 Series Lights

- Excellent quality and performance at a budget price.
- Hybrid reflector gives a combined spot and driving flood pattern.
- High impact resin body and polished, hardened glass.
- Available in round and rectangular styles.
- Kit includes: 2 lights, wiring loom, relay, switch, and guards/covers.
- Round with grill kit – (968CSG)
- Rectangular with grill kit – (868CSG)
- Dimensions:
 - Rectangular: 4.5”H x 7”W x 3”D
 - Round: 7”H x 6.5”W x 3”D



(868CSG)



(968CSG)

IPF Headlight Inserts

Upgrading the factory headlight system with a new insert, superior bulb and high performance loom is one of the easiest ways to improve headlight performance. Each insert allows for the fitment of an H4 bulb.

- Round: 7” dia – (920H)
- Rectangle: 5.5”H x 8”W – (820H)

(920H)



Backup Light (8161)

Improve visibility when backing up or setting up camp with this auxiliary light that incorporates a unique three-way switch that allows for manual or automatic control.

Looms

ARB has a range of high performance wiring looms available for high wattage headlight upgrades, improving low wattage applications where the original vehicle wiring is inadequate.

(8161)



900DB





VEHICLE ACCESSORIES

ENGINEERED FOR THE EXTREMES
OF FOUR WHEEL DRIVING.





DELUXE BULL BAR



SAHARA BAR

ACCESSORY LISTING

- ARB Deluxe Bull Bars
- ARB Sahara Bars
- ARB & IPF Lights
- ARB Side Rails
- ARB Rear Bumper & Tire Carriers
- ARB Roof Racks
- ARB Air Lockers
- Old Man Emu Suspension Systems
- Outback Solutions Drawers
- Safari Snorkels

TOYOTA200 SERIES

The newest model to carry the venerable Land Cruiser badge can be equipped with either a Deluxe Bull Bar (3415150) or a Sahara Bar (3915150) and all the other traditional accessories needed for tackling the Outback. Whether it is gaining the necessary ground clearance or weight-carrying capabilities, there is a specific Old Man Emu suspension system for any task demanded of this capable machine.





DELUXE BULL BAR



REAR BUMPER WITH TIRE CARRIER

TOYOTA100 SERIES

A vehicle that earned a worldwide reputation for versatility and strength deserves a line of accessories that serve to further enhance its capabilities. The Deluxe Bull Bar (3413190) provides an enormous amount of protection, while also providing a strong platform for the fitment of a winch, driving lights and communication antennas. Available front and rear Air Lockers serve as superior traction aids by allowing traction to be delivered on-demand.

ACCESSORY LISTING

- ARB Deluxe Bull Bars
- ARB Sahara Bars
- ARB & IPF Lights
- ARB Side Rails & Steps
- ARB Protection Steps
- ARB Rear Bumper & Tire Carriers
- ARB Roof Racks
- ARB Air Lockers
- Old Man Emu Suspension Systems
- Outback Solutions Drawers
- Safari Snorkels





ACCESSORY LISTING

- ARB Deluxe Bull Bars
- ARB & IPF Lights
- ARB Side Rails & Steps
- ARB Rear Bumper & Tire Carriers
- ARB Roof Racks
- ARB Air Lockers
- Old Man Emu Suspension Systems
- Outback Solutions Drawers
- Safari Snorkels



REAR BUMPER WITH TIRE CARRIER

TOYOTA80 SERIES

A long list of ARB accessories can be fitted to this tough, rugged, and immensely popular Land Cruiser. Protection is provided by a Bull Bar (3411050) and rear bumper/tire carrier combination, while the Old Man Emu suspension components make light work of carrying the necessary load of any excursion. Gear management is also a breeze with an Outback Solutions drawer system and ARB roof rack.





ACCESSORY LISTING

- ARB Deluxe Bull Bars
- ARB & IPF Lights
- ARB Skid Plates
- ARB Rock Sliders
- ARB Rear Bumper
- ARB Roof Racks
- ARB Air Lockers
- Old Man Emu Suspension Systems
- Outback Solutions Drawer
- Safari Snorkels

TOYOTA FJ CRUISER

The Deluxe Bull Bar (3420210) engineered specifically for this distinctive SUV is a perfect example of how a product can match the vehicle's styling while incorporating air bag compatibility and the exceptionally strong five-fold wing design. Meanwhile, the split pan construction is integrated to facilitate airflow to the engine while also providing integrated winch-mounting provisions. Combine this bumper with an Under Vehicle Protection System, side rails, and a rear bumper for the ultimate in trail protection.





ACCESSORY LISTING

- ARB Deluxe Bull Bars
- ARB & IPF Lights
- ARB Air Lockers
- Old Man Emu Suspension Systems
- Outback Solutions Drawers
- Safari Snorkels



TOYOTATACOMA

The Deluxe Bull Bar (3423140) for the extraordinary Tacoma pickup is fantastic way to improve the vehicle's practicality and protection in both on and off road situations. This bumper features an integrated winch mounting provision, Hi-Lift jacking points, driving light and CB antenna mounting locations, integrated turn signals and optional fog lights. When fitted with Old Man Emu suspension and Air Locker locking differentials, these trucks can tackle all types of terrain. Accessories are available for both generations of this popular truck.





DELUXE BULL BAR



DELUXE BULL BAR



DELUXE BULL BAR



ACCESSORY LISTING

- ARB Deluxe Bull Bars
- ARB & IPF Lights
- ARB Skid Plates
- ARB Roof Racks
- ARB Air Lockers
- Old Man Emu Suspension Systems
- Outback Solutions Drawers
- Safari Snorkels



TOYOTA4RUNNER

As this SUV has grown from a small, leaf-sprung truck platform to the larger independent front suspension models, the catalog of ARB accessories for them has also grown. Vehicle specific Bull Bars, Old Man Emu suspension, and Air Lockers are available for all five different platforms.





SAHARA BAR



DELUXE BULL BAR

TOYOTA TUNDRA

The Sahara Bar allows Tundra owners the choice of fitting a bumper with or without the center tube. Meanwhile the Deluxe Bull Bar incorporates the same excellent construction, but offers an increased level of protection. Both options provide the opportunity for winch fitment and Hi-Lift jacking points, while also providing driving light and CB antenna mounting locations. Optional fog light provisions are also available.

ACCESSORY LISTING

- ARB Deluxe Bull Bars
- ARB Sahara Bars
- ARB & IPF Lights
- ARB Air Lockers
- Old Man Emu Suspension Systems
- Outback Solutions Drawers





ACCESSORY LISTING

- ARB Deluxe Bull Bars
- ARB Stubby Bars
- ARB Rock Bars
- ARB & IPF Lights
- ARB Skid Plates
- Rock Sliders
- ARB Rear Bumper & Rear Wheel Carrier
- ARB Air Lockers
- ARB Differential Covers
- Old Man Emu Suspension Systems
- Outback Solutions Drawers
- Safari Snorkels



DELUXE BULL BAR

JEEP WRANGLER JK

The newest generation in a long heritage of extremely capable vehicles to bear the Wrangler name. The JK can be outfitted with any number of ARB accessories that will expand the vehicle's ability. A full range of Bull Bars, including the Deluxe (3450230), Stubby (3450430) and Rock Bar (3450210) have been developed to meet the needs or style of any build. In a similar fashion, a wide range of suspension options has been developed to give superior performance over all types of terrain. Accessories like the Safari Snorkel, rear bumper/tire carrier combination, and differential covers are options for anyone looking to create the ultimate 4x4.





STUBBY BAR

REAR BUMPER & TIRE CARRIER



OUTBACK SOLUTIONS DRAWERS





REAR BUMPER & WHEEL CARRIER



ACCESSORY LISTING

- ARB Deluxe Bull Bars
- IPF Lights
- ARB Rock Sliders
- ARB Rear Bumpers & Rear Wheel Carriers
- ARB Air Lockers
- ARB Differential Covers
- Old Man Emu Suspension Systems
- Outback Solutions Drawers
- Safari Snorkels

JEEPWRANGLER TJ

The Deluxe Bull Bar (3450070) for this vehicle was specifically designed to match the unique styling and to exceed the demands that are often asked of these vehicles while they are on the trail. By providing excellent protection through superior construction and a mounting platform for a variety of winch models and driving lights, this bumper is an excellent upgrade over the factory option.





COMBINATION BULL BAR

JEEP CHEROKEE XJ & LIBERTY KJ

The unique Bull Bar for these vehicles replaces the entire factory bumper, and is engineered with a distinctive style to closely match the vehicle's aesthetics. Couple these bumpers with a complete Old Man Emu suspension system to prepare for travel into remote areas or a commute into the urban jungle.

ACCESSORY LISTING

- ARB Deluxe Bull Bars
- ARB Combination Bars
- ARB & IPF Lights
- ARB Roof Racks
- ARB Air Lockers
- ARB Differential Covers
- Old Man Emu Suspension Systems
- Outback Solutions Drawers
- Safari Snorkels





ACCESSORY LISTING

- ARB Deluxe Bull Bars
- ARB & IPF Lights
- ARB Roof Racks
- ARB Air Lockers
- ARB Differential Covers
- Old Man Emu Suspension Systems
- Outback Solutions Drawers
- Safari Snorkels

DELUXE BULL BAR



JEEP GRAND CHEROKEE

Under the sheet metal of this luxury SUV lies some very capable 4x4 hardware. Each generation of the Grand Cherokee has been built with cutting edge technology and well-appointed luxury features. ARB has applicable Bull Bars and Old Man Emu suspension systems reaching back from first Grand Cherokee model up to the newest WK2 models. With the addition of front and rear Air Lockers (for most models), these SUVs are transformed into extremely comfortable and capable vehicles, ready to hit trails around the backcountry.





DELUXE BULL BAR



DELUXE BULL BAR



DELUXE BULL BAR



SAHARA BULL BAR

ACCESSORY LISTING

- ARB Deluxe Bull Bars
- ARB Sahara Bars
- ARB & IPF Lights
- ARB Side Rails & Steps
- ARB Protection Steps
- ARB Roof Racks
- ARB Air Lockers
- Old Man Emu Suspension Systems
- Outback Solutions Drawers
- Safari Snorkels



LAND ROVER

Generations of Land Rover vehicles have proven to be extremely capable in some of the most remote areas of the globe. As the Land Rover line of vehicles has evolved, the full line of ARB products engineered for them has also evolved. In addition to being compliant with the newer vehicle's airbag safety system and including under-wing protection, the Deluxe Bull Bar even integrates provisions for the stock fog lights and headlight washers. The newly developed Air Lockers for the LR3 & LR4 guarantee that traction is never an issue.





DELUXE BULL BAR



DELUXE BULL BAR



DELUXE BULL BAR



ACCESSORY LISTING

- ARB Deluxe Bull Bars
- ARB & IPF Lights
- ARB Air Lockers
- Old Man Emu Suspension Systems



DELUXE BULL BAR

NISSAN XTERRA

Unlike most brush guards and bumpers, the Deluxe Bull Bar (3438270) incorporates a fully engineered mounting system and is designed to completely replace the factory bumper. The Deluxe Bar is loaded with features aimed at making remote area travel safer. No other bumper offers the same degree of vehicle integration, protection and functionality. The Old Man Emu suspension system available for the second generation (2005-2014) features a similar level of vehicle integration and design. The end result is an improved ride quality, handling and load carrying ability.





DELUXE BULL BAR



ACCESSORY LISTING

- ARB Deluxe Bull Bars
- ARB & IPF Lights
- ARB Rear Bumper
- ARB Air Lockers
- Old Man Emu Suspension Systems
- Outback Solutions Drawers

NISSANFRONTIER

These pickups are small, sturdy platforms perfect for taking into the backcountry. When equipped with a Deluxe Bull Bar (3438260), Old Man Emu suspension, ARB rear step tow bar (3638030), and Air Lockers, these trucks can head out to any point on the map.





ACCESSORY LISTING

- ARB Deluxe Bull Bars
- ARB Sahara Bars
- ARB & IPF Lights
- ARB Air Lockers
- ARB Differential Covers
- Old Man Emu Suspension Systems
- Outback Solutions Drawers
- Safari Snorkels



FORDSUPER DUTY

Responding to the increasing demand for suspension lifts over 2"; Old Man Emu has designed a new 4" system and a leveling option for the newest generation truck. Both kits are focused on comfort and ride quality while also supporting towing needs. A new Modular Bull Bar is also available and features three different potential configurations, and also features a textured powder coat, Hi-Lift jacking points and driving light mounting locations. Add front and rear Air Lockers and these trucks are capable of being prepared for anything.





MODULAR BULL BAR - DELUXE KIT

MODULAR BULL BAR - SAHARA STYLE KIT





ACCESSORY LISTING

- ARB Deluxe Bull Bars
- ARB Modular Bull Bar
- ARB Sahara Bars
- ARB & IPF Lights
- ARB Differential Covers
- ARB Air Lockers
- Outback Solutions Drawers



MODULAR BULL BAR - BASE KIT

DODGE/RAM

A Modular Bull Bar designed to specifically match the aggressive styling of the newest generation Ram truck. Each aspect was evaluated to ensure the styling was as advanced and modern as the vehicle itself. This system also allows vehicle owners to modify or upgrade the configuration if their protection needs change. The base configuration provides an air bag compatible winch mounting platform, integrated fog lights, Hi-Lift jacking points and driving light mounting locations





DELUXE BULL BAR

ACCESSORY LISTING

- ARB Deluxe Bull Bars
- ARB & IPF Lights
- ARB Air Lockers
- Outback Solutions Drawers

CHEVY & GMC

A wide scope of trucks, ranging from 1500 up to 3500HD platforms, can be outfitted with a Deluxe Bull Bar. Each of these bumpers comes in a durable black powder coat and provides engineered protection for your vehicle. In addition to this, features such as an integrated winch mount, driving light mounts and recovery points enhance the functionality of your vehicle.



ACCESSORY LISTING

- ARB Bull Bars
- ARB Sahara Bars
- ARB & IPF Lights
- ARB Skid Plates
- ARB Side Rails & Steps
- ARB Rock Sliders
- ARB Rear Bumpers & Rear Wheel Carriers
- ARB Roof Racks
- ARB Air Lockers
- Outback Solutions Drawers
- Safari Snorkels



INTERNATIONAL VEHICLES

ARB manufactures an extensive line of products for numerous international vehicles. As Australia's largest manufacturer and distributor of 4x4 accessories, we produce high quality products for an extensive line of other vehicle models, including Isuzu D-Max, Ford Ranger, Mazda BT-50, Mitsubishi Pjero, Toyota Hilux, and Holden Colorado.

Please contact your ARB sales representative to receive detailed information on products for specific vehicles.





BULL BAR

APPLICATION CHART

Make	Year	Bull Bar/ Bumper Type	Part No.	Fitting Notes	Note Details
CHEVROLET					
1500 Silverado	99-02	Combination	3462010	1	(1) Order fit kit #3562010 to complete installation.
	03-06	Combination	3462020	4	(2) Order fit kit #3562020 to complete installation.
1500HD/2500 Silverado	99-02	Combination	3462010	2	(3) Order fit kit #3562030 to complete installation.
	03-06	Combination	3462020	5	(4) Order fit kit #3562040 to complete installation.
	15-0n	Modular Base	2262010		
	15-0n	Modular - Sahara Style	2262020		
	15-0n	Modular - Deluxe Style	2262010		
2500/3500HD Silverado	99-02	Combination	3462010	3	(5) Order fit kit #3562050 to complete installation.
	03-06	Combination	3462020	6	(6) Order fit kit #3562060 to complete installation.
1500/2500/3500 Silverado	88-98	Deluxe	3462030		
K1500 Suburban	00-06	Combination	3462010	1	
K2500 Suburban	00-06	Combination	3462010	2	
K1500 Tahoe	00-05	Combination	3462010	1	
Suburban & Tahoe	93-99	Deluxe	3462030		
Avalanche K1500	03-06	Combination	3462020	4	
GMC					
1500 Sierra	03-07	Combination	3462040	1	(1) Order fit #3562040 to complete installation.
1500HD/2500 Sierra	03-07	Combination	3462040	2	(2) Order fit #3562050 to complete installation.
2500HD/3500 Sierra	03-07	Combination	3462040	3	(3) Order fit #3562060 to complete installation.
1500/2500/3500 Reg/Ext Cab	88-98	Deluxe	3462030		
2500/3500 Crew Cab	93-00	Deluxe	3462030		
Suburban	93-00	Deluxe	3462030		
DODGE / RAM					
Ram 1500/2500/3500	94-96	Sahara	3952010	1,2,3	(1) Order #9381FCK for option fog light.
Ram 1500	97-01	Sahara	3952010	1,2	(2) Will not fit "Sport" models due to unique grill.
	02-05	Combination	3452020	4	(3) 94-96 models require modifications.
	06-07	Combination	3452030	6	(4) Order fit kit #3552010 to complete installation.
Ram 2500/3500	06-08	Sahara	3952120	8,9,10,11	(5) Order fit kit #3552020 to complete installation.
	97-02	Sahara	3952010	1,2	(6) Order fit kit #3552030 to complete installation.
	03-05	Combination	3452020	5	(7) Order fit kit #3552040 to complete installation.
	06-07	Combination	3452030	1,7	(8) Order #5152010 frame & #5100140 buffer kit.
	06-09	Sahara	3952120	8,9,10,12	(9) Order #5100150 buffer kit only.
Ram 2500/3500	10-0n	Modular Base	2237030		(10) Order #3512050 loom kit for the 12-1500lb winches.
		Modular - Sahara Style	2237020		(11) Order fit kit #3552050 to complete installation.
		Modular - Deluxe Style	2237010		(12) Order fit kit #3552060 to complete installation.
FORD					
F250/350	99-04	Combination	3436030		(1) Order #9381FCK for optional fog light.
	99-04	Sahara	3936020	1	(2) Order #6821201 for optional fog lights.
	05-07	Combination	3436040		(3) Order #5136010 frame & #5100140 buffer kit.
	05-07	Sahara	3936040	1	(4) Order #5100150 buffer only kit.
	08-09	Sahara	3936150	2,3,4	
	11-0n	Modular Base	2236030		
		Modular - Sahara Style	2236020		
	Modular - Deluxe Style	2236010			
HUMMER					
H3/H3T	06-09	Combination	3468020	1,2	(1) Pre 08 models require skid plate from OE 2008 model. (2) Order #6821201 for optional fog light.
ISUZU					
Trooper w/Overfenders	98-03	Deluxe	3444070	1	(1) Measures 70.5" wide to suit overfenders.
Trooper w/Standard Flares	98-03	Deluxe	3444060	2	(2) Measures 68" wide to suit standard fender flares.
Trooper	92-97	Deluxe	3444050		
Amigo/Rodeo/Rodeo Sport	98-02	Combination	3448200		
Rodeo	90-92	Deluxe	3448040		
JEEP					
Liberty KJ	01-04	Combination	3450110	2	(1) IMPORTANT: Upgrade to hydraulic cooling system req'd to 99-00 models.
	05-07	Combination	3450120		(2) Minor modification to fender flare req'd for fitting.
Grand Cherokee WK2	2011-13	Deluxe	3450410	6,7,8	(3) Minor modification req'd to fit large diameter lights.
	2014-0n	Deluxe	3450420	6,7,8	(4) Will fit Warn Power Plant and Zeon.
Grand Cherokee WK	05-07	Deluxe	3450130		(5) Will fit LWB or Unlimited models.
Grand Cherokee WJ	99-04	Combination	3450100	1	(6) Order #6821201 for optional fog lights.
Grand Cherokee ZJ	93-98	Deluxe	3450060		(7) Additional fit kit #3550100 when fitting vehicle with factory parking sensors.
Cherokee XJ	97-01	Deluxe	3450080	3	(8) Winch install kit #3450050 required when fitting winch.
	84-96	Deluxe	3450010	3	
Wrangler JK	07-0n	Combination	3450230	4,5	
	07-0n	Rockbar	3450250	4,5	
	07-0n	Hoopless	3950200	4,5	
	07-0n	Stubby	3450430	4,5	
Wrangler TJ	97-06	Deluxe	3450070		

Make	Year	Bull Bar/ Bumper Type	Part No.	Fitting Notes	Note Details
LAND ROVER					
LR4	09-13	Deluxe	3432200	5,6	(1) Order spacer kit #3500050 to fit Warn XD9000/M8000.
LR3	05-09	Combination	3432150	5	(2) Order spacer kit #3532050 to fit Warn XD9000.
Discovery II	03-04	Sahara	3932020		(3) Modifications req'd to grill for winch fitment.
	03-04	Deluxe	3432120		(4) Winch fitment requires optional kit #3532070.
	99-02	Deluxe	3432060	1	(5) May require modifications for parking sensors.
Discovery I	94-98	Deluxe	3432050		(6) Please contact ARB USA for more info.
	94-98	Deluxe (Non-Airbag)	3432080	1,2	(7) 1997 NAS spec vehicles contact ARB USA.
Range Rover Classic	87-94	Deluxe	3430020	1,2	
Defender 90,110, 130	85-15	Deluxe	3432300	3,4,7	
	85-15	Deluxe (Classic)	3432090	2	
	85-15	Sahara	3932400	3,4	
LEXUS					
LX470	03-07	Sahara	3913160	2	(1) Order spacer kit #3500050 to fit Warn XD9000/M8000.
	98-02	Sahara	3913140	2	(2) Order #6821201 for optional fog lights.
LX450	90-97	Deluxe	3411050	1	
MITSUBISHI					
Montero NS	07-09	Combination	3434170	2	(1) Order #9381FCK for optional fog lights.
	07-09	Sahara	3934100	2,3,4	(2) Order #6821201 for optional fog lights.
Montero NP	04-08	Combination	3434060	2	(3) Order #5134010 frame & #5100020 buffer kit.
Montero NM	00-04	Sahara	3934020	1	(4) Order #5100030 buffer only kit.
	00-04	Deluxe	3434050		
Montero	81-88	Deluxe	3434010		
Montero Sport	97-99	Deluxe	3435010		
NISSAN					
Pathfinder	08-10	Deluxe	3438290	1	(1) Order #9381FCK for optional fog lights.
	05-07	Sahara	3938150	1,2,3	(2) Order #5138010 frame & #5100020 buffer kit.
	05-07	Deluxe	3438260	1	(3) Order #5100030 buffer kit.
	00-02	Sahara	3938120	1	(4) Suits SE & LE only (not Pro-4X)
	87-95	Deluxe	3438040		
Xterra	05-14	Deluxe	3438270	1	
	00-04	Deluxe	3438110		
Frontier	09-10	Deluxe	3438330	1,4	
	05-08	Deluxe	3438260	1	
	97-00	Deluxe	3438110		
Hardbody Pickup	91-97	Deluxe	3438050		
Titan	04-09	Combination	3464010	1	
SUZUKI					
Equator	09-10	Deluxe	3438280	3	(1) Order #9381FCK for optional fog lights.
Grand Vitara	08-10	Deluxe	3426050	1	(2) Does not fit 'Sport' models.
	06-08	Deluxe	3436040		(3) Order #6821201 for optional fog lights.
Samurai	86-95	Deluxe	3424110	1,4	(4) Order #3524010 to install winch.
Sidekick (2 Door)	88-95	Deluxe	3426010	1	
Sidekick (4 Door)	88-95	Deluxe	3426020	1,2	
TOYOTA LAND CRUISER					
200 Series	12-0n	Deluxe	3415150	2,6,7,8,11	(1) Order #9381FCK for optional fog lights.
	12-0n	Sahara	3915150	2,8,9,11	(2) Order #6821201 for optional fog lights.
	08-11	Deluxe	3415120	2,10,11	(3) Order #5700140 buffer & #5115010 tube kit.
	08-11	Sahara	3915050	2,3,4,10,11	(4) Order #5100140 buffer only kit (no holes), if optional hoop is not fitted.
100 Series (IFS)	03-07	Sahara	3913160	2,12,13	(5) Fitment of XD900 and M8000 requires spacer kit #3500050.
	03-07	Combination	3413190	2	(6) Camera relocation kit #3515030.
	98-02	Sahara	3913140	2,12,13	(7) Fit kit cable extension kit #3512050.
80 Series	98-02	Combination	3413050	5	(8) 2012+ models require #3500440 when fitting optional 6821201 fog lamps.
75/78/79 Series	90-97	Deluxe	3411050	5	(9) Optional center hoop (#5115020) and buffer (#5100140) available.
75/78/79 Series	All	Deluxe	3412130		(10) Bumper is designed to work with factory headlight washer system.
60/62 Series	80-89	Deluxe	3410100		(11) M12000 fitment requires additional fit kit #3512050.
40 Series	69-85	Deluxe	3420020		(12) Optional center hoop (#5100160) and buffers (#5100060).
TOYOTA TRUCKS & SUVs					
FJ Cruiser	10-14	Combination	3420210	3,7	(1) Modification req'd - call ARB for details.
	06-09	Deluxe	3420200	3,6	(2) Order #9381FCK for optional fog lights.
Tacoma	05-14	Deluxe	3423130	3	(3) Order #6821201 for optional fog lights.
	05-14	Deluxe	3423030	8	(4) Order #5115030 frame & buffer kit.
	95-04	Deluxe	3423020		(5) Order #5100150 buffer only kit.
Tundra	07-13	Sahara	3915030	3,4,5	(6) Wing under panel kit available #3520010.
	07-13	Combination	3415010	2	(7) Order #3520020 for under wing panel.
	99-05	Sahara	3915020	2	(8) Does not have provisions for optional fog lights.
Pickup	86-94	Deluxe	3414070	1	
	84-85	Deluxe	3414090		
4Runner	10-13	Combination	3421520	3	
	06-09	Combination	3421510	3	
	03-05	Deluxe	3421500	3	
	86-95	Deluxe	3414070	1	
	84-85	Deluxe	3414090		

AIR LOCKER

APPLICATION CHART



ARB Part No.	Description	Splines	Ratio	Superseded Part(s) #
RD81	Ford 8.8", 31 SPL	31	All	RD15
RD82	Ford 8.8", 28 SPL	28	All	RD16
RD83	GM 10 Bolt, 28 SPL, 8.5"	28	2.73 & UP	RD10
RD84	GM 10 Bolt, 30 SPL, 8.5"	30	2.73 & UP	RD28
RD90	Toyota 7.5" IFS	27	All	
RD93	Chrysler 8.25" 29 SPL	29	All	
RD99	Ford 9", 35 SPL, 2" BRNG	35	All	
RD99CE	Ford 9"(Competition), 35 SPL, 2" BRNG	35	All	
RD100	Dana 30, 27 SPL, 3.73 & UP	27	3.73 & UP	RD30
RD101	Dana 30, 27 SPL, 3.54 & DN	27	3.54 & DN	RD31
RD102	Dana 35, 27 SPL, 3.54 & UP	27	3.54 & UP	RD49, RD59, RD69
RD103	Dana 35, 27 SPL, 3.31 & DN	27	3.31 & DN	RD48, RD58, RD68
RD104	Dana 30, 30 SPL, 3.73 & UP	30	3.73 & UP	
RD105	Dana 35, 30 SPL, 3.54 & UP	30	3.54 & UP	
RD109	Dana 44, 35 SPL, 3.92 & UP	35	3.92 & UP	
RD110	Mitsubishi IFS, 28 SPL	28	All	
RD111	Toyota 8" IFS, 53mm BRNG	30	3.91 & UP	
RD113	Dana 44, 33 SPL, 3.92 & UP	33	3.92 & UP	
RD114	GM 14 Bolt, 10.5", FF	30	4.10 & DN	
RD116	Dana 44, 30 SPL, 3.92 & UP	30	3.92 & UP	RD06
RD117	Dana 44, 30 SPL, 3.73 & DN	30	3.73 & DN	RD07
RD119	Ford 9", 31 SPL	31	All	RD55, RD55A, RD55B
RD121	Toyota 8" IFS, 53 BRNG	30	3.73 & DN	
RD123	Mazda RR, Shim Adjusted	30	All	
RD125	Dana 35, non C-clip, 30 SPL, 3.54 & UP	30	3.54 & UP	
RD126	Santana PS-10, RR	34	All	
RD127	Land Rover, 10 SPL, Banjo	10	3.54	RD03
RD128	Land Rover, 24 SPL, Banjo	24	All	RD56
RD129	Toyota Tacoma, RR	30	All	RD89
RD131	Toyota 8" IFS, 50mm BRNG	30	All	RD92
RD132	Toyota 8", 50mm BRNG	30	All	RD01, RD23
RD133	Toyota 8", RR, Shim Adjusted	30	All	
RD134	Nissan H233, 31 SPL	31	All	RD04
RD135	Nissan H233B, 33 SPL	33	All	RD17, RD24
RD136	Nissan H223B, 31 SPL	31	All	RD09, RD78, RD78A
RD137	Nissan R230, 33 SPL, IRS RR	33	3.54 & UP	
RD138	Land Rover, 24 SPL, Banjo, P38A	24	All	RD57
RD139	AAM 11.5"	30	All	
RD140	Ford 10.25" & 10.5" (Sterling/Corporate)	35	All	RD37
RD142	Toyota 8.9", 50mm BRNG	30	All	RD02, RD33
RD143	Dana 44, 32 SPL, 3.73 & DN	32	3.73 & DN	
RD145	Rockwell 2.5 Ton	16	All	
RD146	Toyota 10.5", RR, 36 SPL	36	All	
RD147	Dana 44, 35 SPL, 3.73 & DN	35	3.73 & DN	
RD148	AAM 760, 28 SPL, IFS	28	All	
RD149	Nissan M226, 32 SPL, 10 bolt RG	32	All	
RD150	Ford 9.75", 34 SPL, C-clip	34	All	
RD151	Toyota 8" IFS, 34 SPL	34	All	RD141
RD152	Toyota 9.5", 32 SPL	32	All	
RD153	Toyota 8.9", C-clip, 50mm BRNG	30	All	RD08, RD124
RD154	Mitsubishi 9.5", 31 SPL, Live Axle	31	All	
RD155	Mitsubishi 9.5", 33 SPL, IFS	33	All	
RD156	Hyundai 9.5" 34 SPL, Live Axle	34	All	
RD157	Jeep JK Rubicon, 35 SPL	35	All	
RD158	Dana 50, 30 SPL	30	All	RD50
RD159	Nissan M226, 32 SPL, 12 bolt RG	32	All	
RD160	Land Rover, Salisbury, 4.70:1	24	4.7	RD32
RD161	Land Rover, Salisbury, 3.54:1	24	3.54	RD20
RD162	Dana 60, 30 SPL, 4.56 & UP	30	4.56 & UP	RD21
RD163	Dana 60, 30 SPL, 4.10 & DN	30	4.10 & DN	RD22
RD164	Dana 60, 32 SPL, 4.56 & UP	32	4.56 & UP	RD95
RD165	Dana 60, 32 SPL, 4.10 & DN	32	4.10 & DN	RD96
RD166	Dana 60HD, 35 SPL, 4.56 & UP	35	4.56 & UP	RD35
RD167	Dana 60HD, 35 SPL, 4.10 & DN	35	4.10 & DN	RD36



GENERAL NOTES:

While every effort has been made to ensure that this list is accurate, ARB Corporation LTD. cannot possibly guarantee its accuracy or completeness given the large number of vehicle makes, models, and option variations, and therefore it is the clients responsibility to establish the correct model Air Locker for their application.

While ARB supplies Air Lockers for the front of many vehicles, they should only be engaged for off-highway use only.

TBD: Refers to information that is still yet "to be determined" at this time.

& UP: Means that the Air Locker is suitable for the stated ratio and those which are numerically higher.

& DN: Means that the Air Locker is suitable for the stated ratio and those which are numerically lower.

RG: The ring gear or crown gear of the vehicle.

Dia RG: The outside diameter taken over the outside of the ring gear teeth.

SPL: The spline of the axle shaft.

FR: Front axle application.

RR: Rear axle application.

IFS: Independent front suspension.

BRNG: Carrier bearing inside diameter.

LSD: Refers to vehicles originally equipped with a Limited Slip Differential.

Air Locker Applications (continued)

ARB Part No.	Description	Splines	Ratio	Superseded Part(s) #
RD168	Dana 60HD, C-clip, 35 SPL, 4.56 & UP	35	4.56 & UP	RD42
RD169	Dana 60HD, C-clip, 35 SPL, 4.10 & DN	35	4.10 & DN	RD43
RD170	Dana 70/80, 32 SPL, Low Speed	32		RD97
RD171	Dana 70/80, 32 SPL, High Speed	32		RD98
RD172	Dana 70/80, 35 SPL, Low Speed	35		RD53, RD65
RD173	Dana 70/80, 35 SPL, High Speed	35		RD54, RD66
RD174	Dana 70/80, 37 SPL, Low Speed	37		RD115
RD175	Dana 70/80, 37 SPL, High Speed	37		RD91
RD176	Dana 70/80, 40 SPL, Low Speed	40		
RD177	Dana 70/80, 40 SPL, High Speed	40		
RD180	Nissan R180A, 27 SPL, 3.69 & UP	27	3.69 & UP	
RD181	Nissan R180A, 27 SPL, 3.54 & DN	27	3.54 & DN	
RD182	Nissan R180A, 27 SPL, 8 Bolt RG	27	All	
RD183	Toyota 10.5", RR, 34 SPL	34	All	
RD186	AMC Model 20, 3.08 & UP	29	3.08 & UP	RD60
RD187	AMC Model 20, 2.73:1	29	2.73	RD47
RD188	Dana 60XHD, 40 SPL, 4.56 & UP	40	4.56 & UP	
RD189	Dana 60XHD, 35 SPL, 4.10 & DN	40	4.10 & DN	
RD193	Toyota 8.25" RR, 12 Bolt RG, Shim Adjusted	30	All	
RD195	Nissan Patrol Y62, RR	34	All	
RD196	Nissan C200K, 31 SPL	31	All	RD106
RD197	GM / AAM 9.25"/9.5", 33 SPL	33	All	RD40, RD51
RD198	VW Amarok Rear	30	All	
RD200	Rockwell 2.5T, 40 SPL	40	All	
RD201	Nissan C200, 31 SPL	31	All	
RD202	Nissan C200K/R200A, 29 SPL	29	All	RD27, RD107
RD203	Isuzu IFS, 17 SPL	17	All	RD94
RD204	Suzuki Vitara, RR, 26 SPL, 10 bolt RG	26	All	RD74
RD205	Suzuki, FR, 22 SPL, 10 bolt RG	22	All	RD73, RD75
RD206	Suzuki Jimny, FR, 22 SPL, 10 bolt RG	22	All	RD118
RD207	Suzuki Jimny, FR, 22 SPL, 8 bit RG	22	All	RD87
RD208	Suzuki, 26 SPL, 10 bolt RG	26	All	RD72, RD88
RD209	Suzuki Vitara, RR, 26 SPL, 12 bolt RG	26	All	RD79
RD210	Mitsubishi 8", RR, 28 SPL	28	All	RD05
RD212	Mitsubishi 9", RR, 28 SPL	28	All	RD25, RD46
RD213	Isuzu RR, 26 SPL	26	All	RD44
RD214	Nissan H260, 34 SPL	34	All	RD144
RD215	Nissan H260, 37 SPL	37	All	RD70, RD7
RD216	GM 12 Bolt, 8.9", 30 SPL, 3.73 & UP	30	3.73 & UP	RD12
RD217	LR Discovery 3 & 4, FR, 29 SPL	29	All	
RD218	LR Discovery 3, RR, 31 SPL	31	All	
RD219	T6 Ranger/BT50, FR, 29 SPL	29	All	
RD220	T6 Ranger/BT50, RR, 32 SPL	32	All	
RD223	Ford Ranger PJ, PK/Mazda BT50, IFS, 30 SPL	30	All	
RD224	Nissan M205	30	All	



DIFF COVER

Applications

Axles	Part No.	Notes:
Dana 30	0750002*	Not suitable for IFS applications
Dana 35	0750004	
Dana 44	0750003*	Not suitable for D44A models
Dana 60	0750001*	
Chrysler 8.25"	0750006*	
Ford 8.8"	0760006*	
GM 10-Bolt	0750007*	

Performance Model Air Locker Applications

Description	Ratio	Notes	Spline Count	Shaft Diameter	Spline Type	Pressure Angle	ARB Part Number
Ford 9"	All		35	38.1 (1.50")	24/48 DP	30°	RD99 ¹
Ford 9"	All		35	38.1 (1.50")	24/48 DP	30°	RD99CE
Dana 30	3.73 & UP		30	33.3 (1.31")	24/48 DP	30°	RD104
Dana 35	3.54 & UP	Suits C-clip and non-C-clip type shaft	30	33.3 (1.31")	24/48 DP	30°	RD105
Dana 35	3.54 & UP	Suits ONLY non-C-clip retained shafts (4 pinion)	30	33.3 (1.31")	24/48 DP	30°	RD125
Dana 44	3.73 & DN	Suits all ratios of some late model D44 (eg. JK)	32	35.8 (1.41")	24/48 DP	37.5°	RD143
Dana 44	3.92 & DN		33	34.8 (1.37")	24/48 DP	45°	RD113
Dana 44	3.92 & DN		35	38.1 (1.50")	24/48 DP	30°	RD109
Dana 44	3.73 & DN	Suits all ratios of some late model D44 (eg. JK)	35	38.1 (1.50")	24/48 DP	30°	RD147
Dana 60	4.56 & UP		40	43.2 (1.70")	24/48 DP	45°	RD188
Dana 60	4.10 & DN		40	43.2 (1.70")	24/48 DP	45°	RD189
Dana 70/80	___ & UP	Low Speed Carrier	37	40.6 (1.60")	24/48 DP	45°	RD174
Dana 70/80	___ & DN	High Speed Carrier	37	40.6 (1.60")	24/48 DP	45°	RD175
Dana 70/80	___ & UP	Low Speed Carrier	40	43.2 (1.70")	24/48 DP	45°	RD188
Dana 70/80	___ & DN	High Speed Carrier	40	43.2 (1.70")	24/48 DP	45°	RD189
Rockwell 2.5 Ton	All		16	41.3 (1.63")	Tapered	30°	RD145
Rockwell 2.5 Ton	All		40	43.2 (1.70")	24/48 DP	45°	RD200

NOTES: Performance application models do not suit any original equipment axle shafts. Custom shafts to suit your specific axle assembly must be obtained. Contact ARB for more information on performance upgrades available to suit your axle type.

¹ Can be manually modified to accept some other axle splines. Contact ARB.
RD99 will suit Ford 9 3/8" third member if alternative ARB adjuster nut is used.