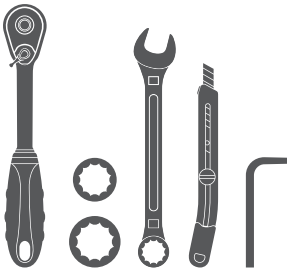

Parts List

1	Grille guard
1	Driver / left frame mounting bracket
1	Passenger / right frame mounting bracket
1	Driver / left top mounting bracket
1	Passenger / right top mounting bracket
1	LED support flange
2	Clip nut, 8mm
2	Hex bolt, 8mm
2	Flat washer, 8mm
2	Lock washer, 8mm
4	Bolt plate, 10mm
6	Hex bolt, 10mm
2	Button head bolt, 10mm
20	Flat washer, 10mm
12	Lock washer, 10mm
12	Hex nut, 10mm
2	Plastic retainer, 10mm

Tools Required

Ratchet	Wrench, 16mm
Socket, 13mm	Utility knife
Socket, 17mm	Allen wrench, 6mm

**Level of Difficulty**

Easy

Product Image**Notes and Maintenance**

Before you begin installation, read all instructions thoroughly.

Proper tools will improve the quality of installation and reduce the time required.

For black finishes, mild soap may be used to clean the product.

Step 1

Select an LED light, mounting hardware and brackets (sold separately). Attach the hardware to the support flange.

Note: LED manufactures may have different mounting styles or brackets. Once the mounting option is determined, attach it to the support flange.



Step 2

With the LED light attached to the support flange, place a clip nut on both ends of the support flange.

Insert an 8mm hex bolt, lock washer and flat washer into the clip nut. Leave enough space between the flat washer and clip nut to slot the support flange into the light bar cage on the grille guard.



Step 3

Place the grille guard face down on a flat, stable work surface.

Insert the support flange into the light bar cage on the grille guard and ensure the flat washer, lock washer and head of the hex bolt are on the outside of the center flange.

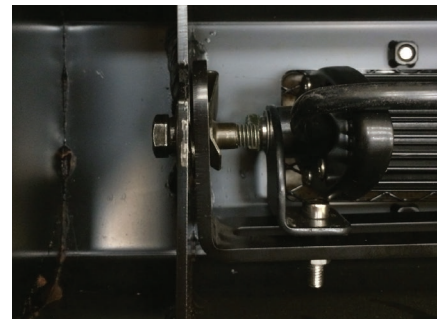

Step 4

Locate and remove the air dam on the bottom of the front bumper.



Step 5

Locate and remove the factory hex bolt on the passenger side of the vehicle.

Insert a 10mm bolt plate into the large frame hole and 10mm bolt retainer to keep the bolt plate from falling into the frame of the vehicle.

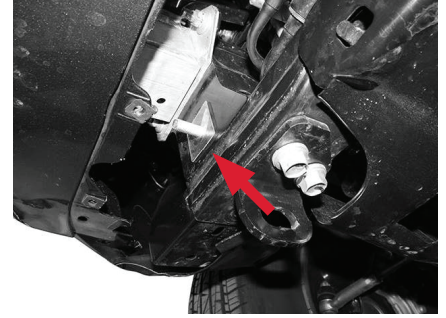
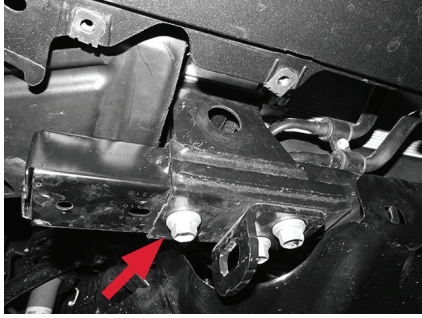

Step 6

Place the passenger-side mounting bracket up to the vehicle.

Secure the mounting bracket to the vehicle using the previously remove hardware on the lower mounting point and a 10mm flat washer, 10mm lock washer and 10mm hex nut.

Repeat steps 5 and 6 to install the driver-side mounting bracket.

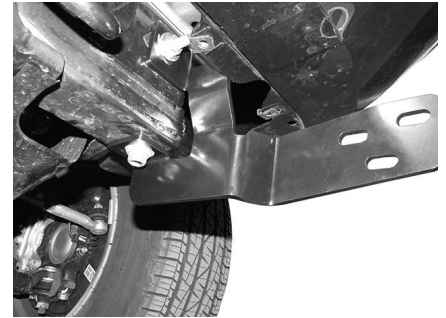
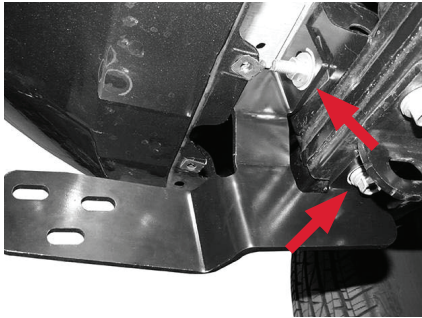

Step 7

Open the hood of the vehicle and remove the plastic cover.

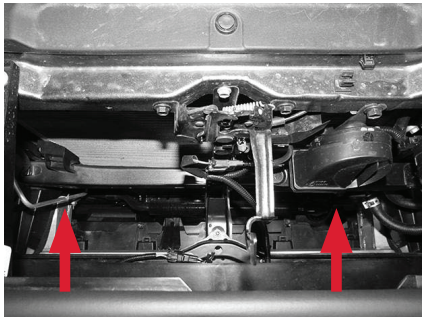

Step 8

Locate the support bar in front of the radiator. Insert a 10mm bolt into the two outer-most holes on the support bar.

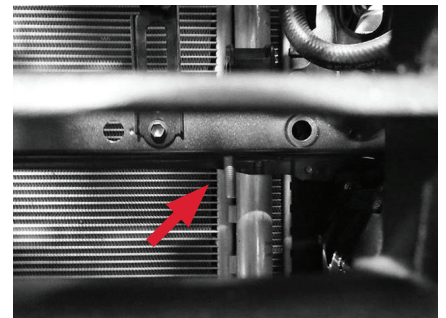
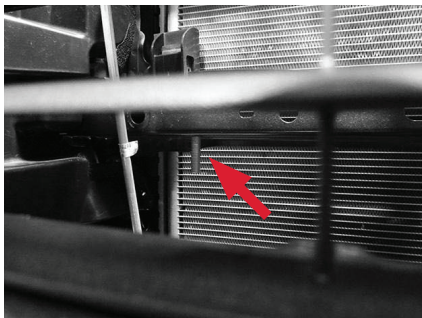

Step 9

Place the passenger-side top mounting bracket up to the support bar.

Secure the mounting bracket to the support bar using a 10mm flat washer, 10mm lock washer and 10mm hex nut.

Repeat this process to install the driver-side top mounting bracket.

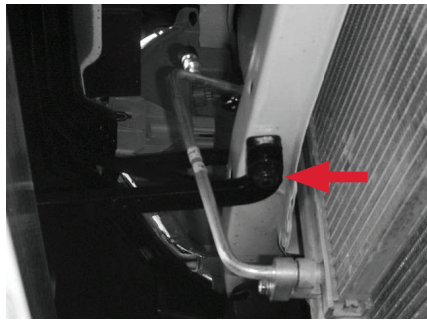

Step 10

Hold the air dam up to the front bumper and align it with the mounting points. Mark the locations of the mounting brackets on the air dam, using a marker and tape.

With the locations marked, cut two slots large enough to clear the mounting brackets. With the slots cut, reinstall the air dam.



Step 11

With help, lift the grille guard up to the mounting brackets.

Secure the passenger-side lower frame bracket using a 10mm hex bolt and flat washer on the outside and a 10mm flat washer, 10mm lock washer and 10mm hex nut on the inside of the grille guard.

Repeat for the remaining mounting points.

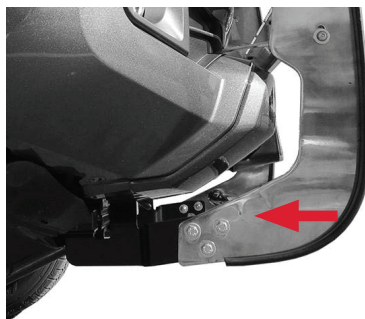

Step 12

Secure the passenger-side top mounting bracket to the grille guard using a 10mm button head bolt and flat washer on the outside of the grille guard and a 10mm flat washer, 10mm lock washer and 10mm hex nut on the inside of the grille guard.

Repeat process on the driver side.

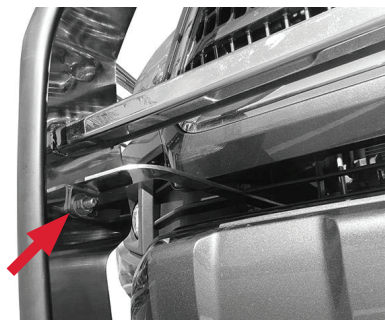

Step 13

Once the grille guard is aligned, tighten all hardware.

Congratulations on the installation of your new grille guard.

With the grille guard installed, periodic inspections should be performed to ensure all mounting hardware remains tight.

To protect your investment, see the 'Notes and Maintenance' section on the first page of this instruction manual.



Parts List

1	LED light bar, 10"
1	Mounting bracket, left
1	Mounting bracket, right
1	Wiring harness
2	Security screw, M6 - 1.0 x 25mm
2	Rubber spacer, M6
2	Flat washer, M6
2	Hex head cap screw, M8 - 1.25 x 18mm
2	Flat washer, M8
2	Nylock nut, M8 -1.25mm
1	Security screw L-wrench
1	15-amp fuse, pre-installed

Step 1

Mount the LED light in the desired location with a rubber spacer between the mounting surface and each bracket.

Note: If this light bar is being used with a 24V system, the relay will need to be replaced with a 24V unit.

Disconnect the supplied switch from the wiring harness and install in the desired location.

Step 2

Once the LED light bar and switch are installed, route the wiring harness to the light. Insert the male plug on the wiring harness into the female socket on the LED light. Reconnect the blue, red and black spade connectors to the switch (see the wiring diagram).

Step 3

Connect the red fused wire with the ring terminal to the positive (+) battery post. Connect the black wire ring terminal to the negative (-) battery post or other suitable vehicle grounding point.

Step 4

Mount the provided relay to the vehicle and secure all wires with zip ties away from moving parts to avoid damage. Test the light to ensure proper function.

Level of Difficulty

Easy

Product Image



Wiring Diagram

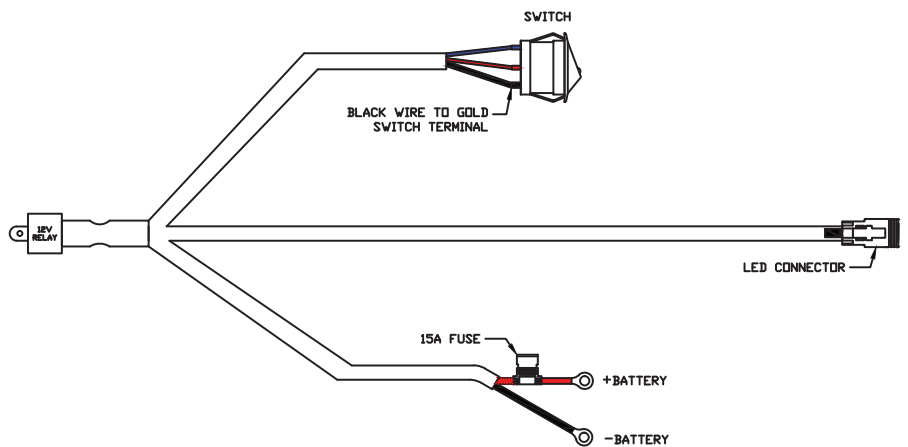

Notes and Maintenance

Before you begin installation, read all instructions thoroughly.

Periodic inspection of all wires and connections should be performed to ensure there is no visible damage or loose connections.

WARNING: Improper electrical installation may damage electronic components resulting in personal injury, property or equipment damage. Damaged caused by incorrect installation is not covered by warranty. Installation should only be performed by qualified personnel with a solid understanding of electrical systems.

Basic Dimensions

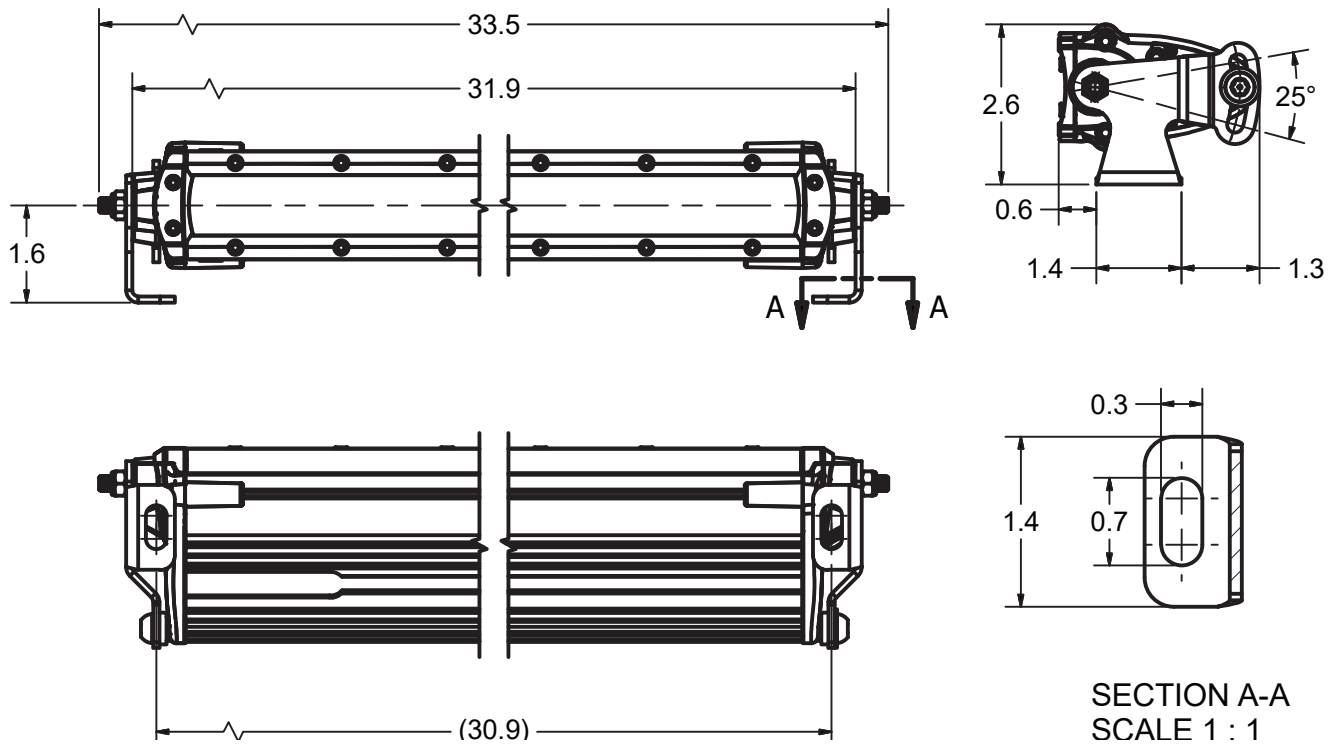

Mounting Illustration

