



ASSOCIATED

BEST 6044 BATTERY TESTER

OPERATOR AND SAFETY MANUAL

The BEST 6044 is designed to test electrical systems on 12, 12/24, and 24 volt vehicles. It can test and evaluate starters, batteries, alternators, regulators, wiring connections, and other electrical equipment in the low voltage circuits in the vehicle. Before operating this unit, thoroughly familiarize yourself with the safety instructions included in this booklet and in the service manual.

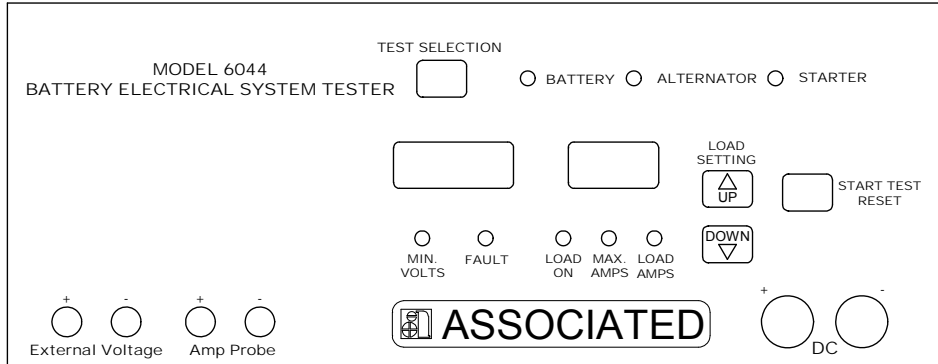

TABLE OF CONTENTS

Features	1
Safety instructions.....	2
Battery Load Tests.....	3
Starter Tests	5
Charging System Tests.....	5
Troubleshooting Hints	7
Assembly Instructions	8

FEATURES OF THE BEST 6044 INCLUDE:

- Large, easy to read, LED digital AMPS and VOLTS meters. The VOLTS meter reads voltages to ± 40 volts DC when reading the differential voltage and up to 40.0 volts DC for the battery voltage. The AMPS meter reads DC currents up to 999 amps.
- The input impedance of the differential voltage is 2 megohms for accurate testing of solid state circuits.
- The load is rated 500 amps on 12 volt batteries for load testing batteries up to 1000 CCA capacity.
- Fixed loads designed to insure longer life.
- Amp probe zero button allows for maximum accuracy in AMPS reading.
- LOAD ON light indicates the load is actuated and serves as a reminder to not disconnect leads while load is on.
- AMPS meter reads both + and - amps for easy diagnosis of leakage current problems.
- Unit monitors the voltage ripple letting you know when alternator output diodes have failed.
- The electronic circuits are protected against reverse voltages caused by connecting leads incorrectly.

- The electronic circuit board has a protective coating to prevent damage and meter inaccuracy due to moisture and dirt.
- Heavy duty leads are single extended so that they may be used for testing at points up to 15 feet apart.
- The clamps on the heavy duty lead are vinyl dipped and have a flexi-spring stain relief to prevent cable damage. Solid copper jaws provide better electrical conduction and are field replaceable.
- Heavy duty leads have internal tracer lead wires for voltage reading the battery voltage. These leads should not be attached to any voltage source that could rise above 45 VDC.
- The light gauge voltage sensing leads (red and black) have small test clips to allow testing at points where the heavy duty leads can not reach. Use the leads when the unit is set for the external voltage (differential voltage) reading. The leads can test points in a vehicle up to 15 feet apart and read voltages up to 40 VDC.
- The inductive AMP PICKUP has 10 foot long lead to allow for testing in hard to reach areas.
- All leads are long enough to test trucks, "high-rise" four wheel drive, or off road vehicles.
- The optional cart has a long wheel-base for greater stability when moved over rough surfaces or cracked floors.
- Optional printer: prints a report of all the results of any test performed by the 6044.

IMPORTANT SAFETY INSTRUCTIONS

SAVE THESE INSTRUCTIONS. The safety information contained herein should be reviewed every time the unit is used.

BATTERY SAFETY:

ALWAYS WEAR EYE PROTECTION WHEN WORKING NEAR A BATTERY.

CAUTION: The electrolyte in automotive batteries is sulfuric acid, which is capable of causing severe damage to skin, eyes, and clothing. When contact with battery acid occurs, proceed as follows:

- 1) Eyes: Force open and flood with cool running water at least for 10 minutes, then see a doctor. Never use eyes drops or other medication before seeing a doctor.
- 2) Skin: Remove contaminated clothing and flood skin for at least 10 minutes with clear, cool water.

While batteries are being charged or tested, an explosive gas mixture forms inside each cell. Some of this gas escapes through the vent holes in the filler caps and may remain around the battery in an explosive condition. Sparks or flames igniting this gas mixture will burn back through the vent hole and explode inside the battery cell. Such an explosion is dangerous not only because of its own force, but also because of the acid electrolyte which could spray onto anything in the vicinity.

TO PREVENT EXPLOSIONS:

- 1) Use well ventilated areas for charging and testing batteries.
- 2) Allow no smoking, sparks or open flames near batteries being charged, tested or batteries recently charged or tested.
- 3) Do not break live electrical circuits at the terminals of batteries because a spark may occur at that point causing an explosion. Always turn battery chargers or tester **OFF** before connecting or disconnecting the clamps from the battery terminals.

PERSONAL PRECAUTIONS:

- 1) Wear complete protection and avoid touching eyes while working near battery.
- 2) **NEVER** smoke or allow a spark or flame in the vicinity of battery or engine.
- 3) Be extra cautious to reduce risk of dropping a metal tool onto a battery. The tool may spark or short-circuit the battery or other electrical parts which may cause an explosion.
- 4) Remove personal metal items such as rings, bracelets, necklaces, and watches when working with a lead-acid battery. A lead-acid battery can produce a short-circuit current high enough to instantly weld a ring or the like to metal, and cause severe burn.
- 5) Spilled acid: Neutralize with a solution of baking soda (1 pound per gallon of cold water) or household ammonia (1 pint per gallon of cold water)

VEHICLE SAFETY:

- 1) Keep your body, clothing, and test leads away from all moving parts of the vehicle. Remember, electric fans may start at any time.
- 2) Avoid hot engine parts.
- 3) Engine exhaust contains deadly carbon monoxide gas. Run engine only in a well ventilated area with exhaust gases ventilated outdoors.
- 4) When running engine tests, be sure that the vehicle is in "park" or "neutral" and the parking brake is on when starting the vehicle. Block wheels to prevent vehicle movement.
- 5) Do not connect any test lead to carburetor, fuel lines, or sheet metal parts of frame.

TESTER PRECAUTIONS AND NOTES:

- 1) Only very minor arcing should occur when connecting the tester to a battery. If any thing more than this occurs disconnect unit and have qualified service personnel examine the unit.
- 2) Never block ventilating holes on the sides, front, back, or the bottom of the unit. This could lead to excessive heat on the cabinet.
- 3) Some smoke or odor may occur on the first use on the tester or if it has not been used for a long period of time, this is normal.
- 4) Never use the load more than twice in a 5 minute period. If the unit becomes over heated it will display "Hot" until it has cooled. For maximum life, always let the unit cool before running a second load test.
- 5) For the ammeter to read +amps, attach current probe so arrow on probe points in direction of current flow (from positive to negative). For negative values the last decimal point will light.
- 6) Residual magnetism in the Amp Probe may cause it to read incorrectly. Therefore, the Amp Probe should be zeroed before each use. This can be done with the blue button on the amp probe.
- 7) In the booklet, the word "positive" refers to the red clamp or lead. The word "negative" refers to the black clamp or lead.
- 8) "Positive" when referring to a battery terminal will mean the one marked Pos, P,(+).
- 9) "Negative" when referring to a battery terminal will mean the one marked Neg, N,(-).

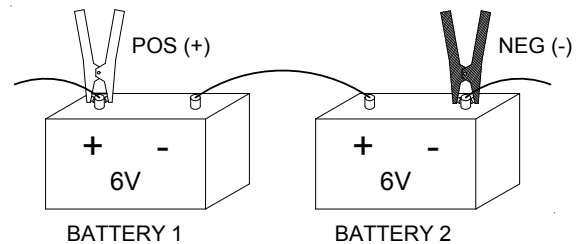

FIGURE 1

BATTERY LOAD TESTS

TESTING 12 VOLT BATTERIES:

The standard battery load test is to apply a load on the battery equal to ½ the cold cranking amp (CCA) capacity of the battery for 15 seconds. Both the voltage and temperature of the battery under load determine whether a battery is good or not.

Before testing the battery be sure that:

- Battery terminals are clean.
- The battery does not have any physical damage.
- The battery is not frozen.

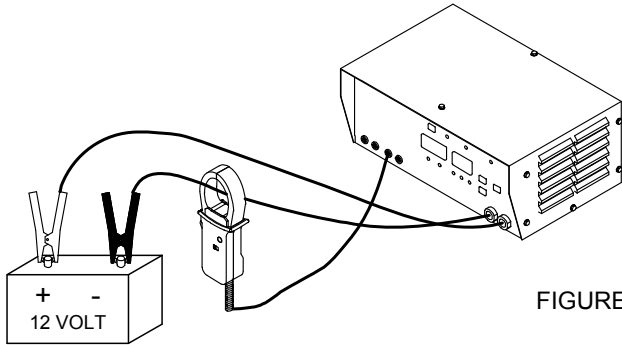

FIGURE 2

PROPER TEST PROCEDURE IS AS FOLLOWS:

- 1) Attach red and black heavy duty leads to the positive and negative battery posts (see figure 2). Twist or rock clamps back and forth several times to make a good connection.
- 2) The "Battery" LED should now be on. Press "Start Test" [4] button.
- 3) 300 should now be displayed in the Amp display along with the load amps LED. Adjust the value to read ½ the CCA reading of the battery using the up and down arrows. The minimum value is 70A.
- 4) Once the proper load current is displayed press the "Start Test" [4] button again; the tester will then start the battery test.

- 5) If the battery voltage is below 12.4V prior to the test the display will show "LO". If the voltage is above 13.0V then the unit will apply a proportional load current to remove the surface charge before starting the load test.
- 6) The testing unit will apply a load current for 15 seconds displaying the current and the voltage while the test is running. The load LED will be lit while this test is in progress. The load current will vary some as it tries to keep the correct load current with the varying battery voltage. The battery test LED will also flash.
- 7) After the test is complete, the tester will alternate in the voltage window between the minimum voltage reading during the battery test and the present open circuit battery voltage. If the minimum voltage was below 9.6V then it will also flash "Bd"

The minimum acceptable voltage for a battery at the different temperatures is as follows:

BATTERY TEMPERATURE COMPENSATION 15 SECOND LOAD TEST								
°C	21↑	16	10	4	-1	-7	-12	-18
°F	70↑	60	50	40	30	20	10	0
MIN .VLT	9.6	9.5	9.4	9.3	9.1	8.9	8.7	8.5

If the CCA of the battery is not known check vehicle manufacturer's recommendation for the proper battery CCA rating and test the battery using that value.

Warning: NEVER TRY TESTING A FROZEN BATTERY.

TESTING 12/24 VOLT SYSTEMS:

For best results in a 12/24 volt system that has batteries connected per the diagrams below, each battery should be tested separately and the connection between the batteries tested at the same time. Both battery tests should be run as described in the previous section.

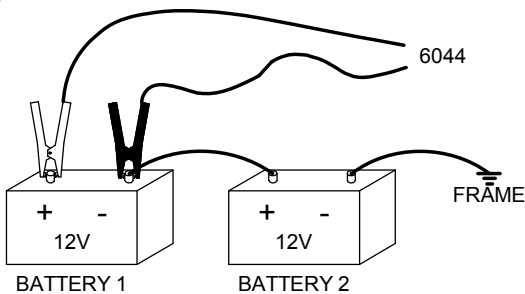

FIGURE 3

PROPER TEST PROCEDURE IS AS FOLLOWS:

- 1) Attach heavy duty leads to Battery 1 and run battery load test. Evaluate the results. (See figure 3)
- 2) Attach the negative heavy duty lead to the negative terminal of Battery 2. Attach the positive heavy duty to the negative terminal of Battery 1. (By attaching at that point and not at the positive terminal of Battery 2, we will check the connection between the batteries at the same time.) Attach the positive external (differential) voltage lead to the negative terminal of

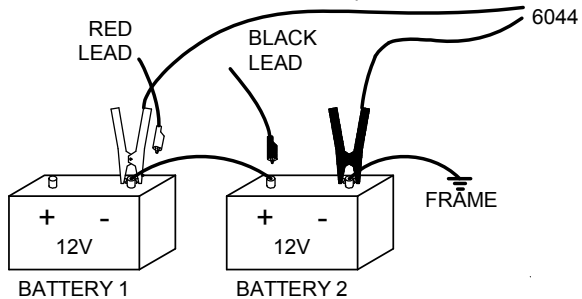

FIGURE 4

- 3) Battery 1 and the negative external (light gauge) lead to the positive terminal of Battery 2. (See figure 4)
- 3) Run the battery load test on battery 2. After the test is complete press the down arrow button this will display the voltage that was read across the jumper during the battery test. This value should be less than 0.2V if not check the jumper and connections to the battery. Subtract the jumper voltage from the minimum voltage displayed for the battery test and evaluate the results.

USE THIS SECTION FOR BATTERY TESTING IF YOUR 12/24 VOLT SYSTEM LOOKS SIMILAR TO THIS:

- One six volt battery by itself cannot be tested with this unit. It will not provide enough voltage under load to allow the digital circuitry to work.
- Please note: When two six volt batteries are connected in series, the voltage of the array is 12. The CCA rating of the series does not double. It is the same CCA as either of the individual batteries. (If you have two, 500 CCA, 6 volt batteries in series, it is equivalent to a 500 CCA, 12 volt battery and should be tested with a 250 amp load.)
- Both the heavy duty and light gauge leads will be used in this test (see figure 5).
 - 1) Attach the positive heavy duty lead to the positive terminal of Battery 1 and the negative heavy duty lead to the negative terminal of Battery 2. Connect the external voltage leads; red lead to positive terminal of Battery 2 and the black lead to the negative terminal of Battery 2.
 - 2) Proceed with the battery test. After the test evaluate the results. If the battery group as a whole does not pass then press the down arrow button to read the minimum voltage on Battery 2. See the table below for the minimum voltages of a 6 volt battery.
 - 3) To determine the battery voltage of Battery 1 just subtract the external voltage reading from the minimum overall voltage.
 - 4) If the battery voltage on Battery 2 looks good but the overall battery voltage is too low, check the jumper voltage. This is done by repeating step 1 but connect the external voltage leads across the jumper, positive lead to negative terminal of Battery 1 and negative lead to the positive terminal of Battery 2. After testing read the external voltage it should be less than 0.2V.

BATTERY TEMPERATURE COMPENSATION 15 SECOND LOAD TEST						
°C	21↑	10	2	-4	-9	-15
°F	70↑	50	35	25	15	5
MIN. VOLT	4.8	4.7	4.6	4.5	4.4	4.3

- Please note that the test described above is not the easiest way to run a test on two batteries in series, but it is the most accurate. If you were to test the batteries and take only one voltage reading from the positive terminal of Battery 1 to the negative terminal of Battery 2, there are problems that could remain hidden or cause excessive replacement costs.

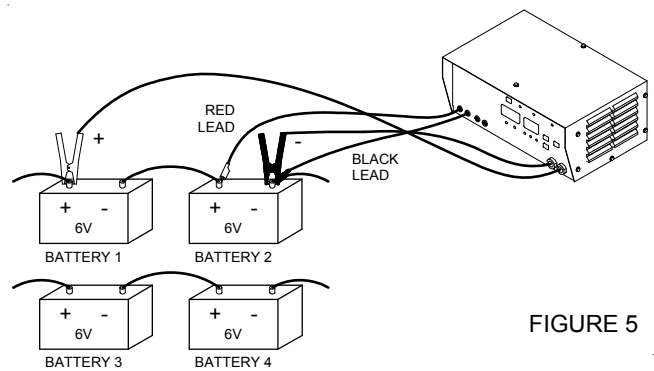

FIGURE 5

- The voltage reading under load from the positive terminal of Battery 1 to the negative terminal of Battery 2 is the sum of the voltage drops across Batteries 1, 2, and the cable jumper.
 - Total voltage = B1 voltage + B2 voltage + jumper voltage drop (see figure 6).
 - If you had two good batteries and a bad jumper connection, the total voltage may be less than acceptable. If the batteries were replaced, the new ones may test bad due to the bad connection. Replacing or cleaning a bad jumper cable is cheaper and easier than replacing batteries if that is all that is needed.
- In another situation, you may have one good battery, a good jumper connection, and one bad battery. If the good battery voltage is high enough to offset the bad battery voltage, you will have no indication of the potential problem. If the good battery voltage is not high enough to offset the bad battery voltage, the group may test bad and both batteries replaced when only one of the needs to be.

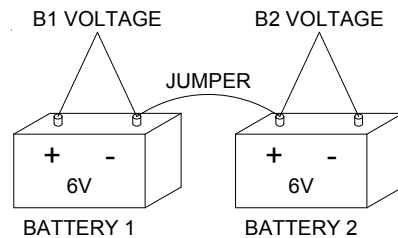

FIGURE 6

TESTING 24 VOLT SYSTEMS:

- 24 volt batteries may not be load tested with this unit. Most 24 volt systems are made up of 2 12V batteries. See above for testing.
- The unit is capable of testing 24 volt alternator and the starting systems.

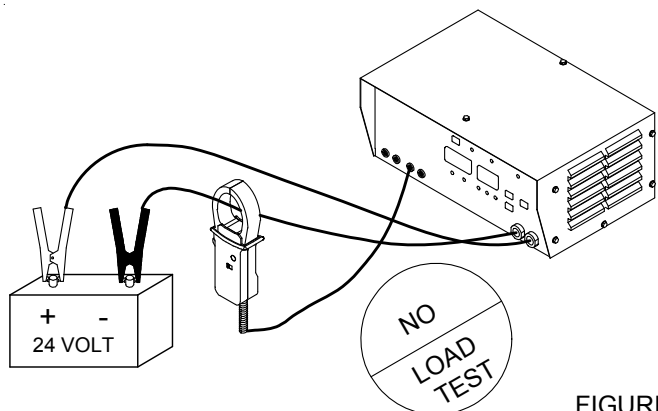

FIGURE 7

STARTER TESTS

- Current draw of the starter, battery voltage, and voltage drop of leads can be measured when connected as shown (See figure 8).
- This unit is designed to capture the maximum (peak) starting current, the running starting current and the minimum battery voltage when the vehicle is started.
- Review the Safety section in the front of this manual.
 - 1) Attach the heavy duty leads to the battery as shown.
 - 2) Press Test Selection [2] button until the starter LED is lit.
 - 3) Press Start Test [4] button Starter LED will start to flash. Attach the Amp Probe around the lead from the positive battery terminal to the starter. If that cable is not accessible, it may be placed around the ground cable that runs from the frame or engine block to the negative battery terminal.
 - 4) Be sure that all the lights and accessories are turned off.
 - 5) Start the engine. Under no condition should you crank more than 10 seconds at a time. The tester will alternate the amps display showing the maximum cranking current with the "MAX. AMPS" LED lit and the **starter running current** at this time in the amps display. It will also display the minimum battery voltage with the "MIN. VOLTS" LED lit alternating with the actual battery voltage in the voltage display.
 - 6) Minimum acceptable voltage for most vehicles while cranking is 9.6 volts. Typical **starter running currents** (this would be the smaller current displayed) for vehicles are:
 - 4 cylinder gas engine--up to 175 amps
 - 6 cylinder gas engine--up to 225 amps
 - 8 cylinder gas engine--up to 250 amps
 - 8 cylinder diesel engine--up to 650 amps
- The vehicle service manual should be consulted for more detailed information. While the vehicle is starting, you should listen for high pitch or low growling sounds that may indicate bearing or other problems.
- Connections between the battery and starter and between the battery and frame can also be checked at this time.

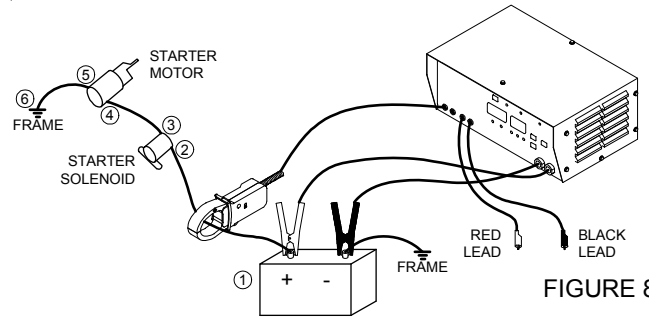

FIGURE 8

Excessive voltage drop in either cable caused by loose or corroded connections, undersized, or broken wires may be the problem, not the starter.

Testing procedure using the Eternal Voltage leads: Review safety section in the front of the manual. (see figure 8)

- 1) Attach tester to battery as shown. Press Test Selection [2] button until the Starter LED is lit: press Start Test [4] button.
- 2) Attach positive external lead to positive battery terminal (1). Attach negative (light gauge) external lead to starter solenoid where the lead from the battery terminates (2).
- 3) Start the vehicle, press the up arrow this will display the maximum differential (external) voltage reading during the starter test.
- 4) Repeat the same procedure, checking the voltage drop across the solenoid, (negative lead to starter side of solenoid), (2 to 3).
- 5) Repeat again, checking the voltage drop between the solenoid and the starter. (Positive lead at solenoid, negative lead at starter.) (3 & 4).
- 6) Repeat again, checking the ground cable from the battery to the engine block. (Positive lead to engine block, negative lead to battery negative terminal.) (5 & 6).
- 7) Acceptable voltage drop on any wire lead should be 0.2 volts or less. Voltage drop across the starter solenoid should 0.3 volts or less. Check vehicle service manual for further details.

CHARGING SYSTEM TESTS

- Please review all the safety instructions in the front of this manual before running these tests.
- Charging problems can be caused by a number of different things. These can include loose belts, defective diodes or stators, defective regulators, corroded or loose connections or defective diode trios (GM cars).
- Undercharging will shorten battery life and may not provide the proper charge to start the vehicle. Overcharging will cause excess water usage in the battery and shorten battery life.
- Proper charging voltage and current from the charging system to the battery is important for the longest life and maximum performance.
- The proper end of charge voltage will depend on the type of battery installed by the manufacturer and ambient temperature of the charging system.
 - A conventional battery (lead-antimony) will require charging voltages up to about 14.5 volts.
 - A recombination battery or low maintenance battery may require charging voltages up to about 14.8 volts.
- Voltage specifications will vary from manufacturer to manufacturer. The service manual for the vehicle should be consulted for exact charging specifications.

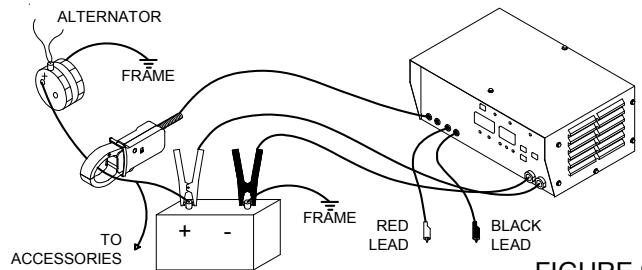

FIGURE 9

It is also important that the charging system be capable of putting out it's rated current. If the electrical load, (lights, blower, power accessories, etc.) in the vehicle is more than the output of the alternator, the battery will discharge to provide the needed current. The battery may become discharged and will not recharge until some of the load is turned off. This type of discharge/charge cycle will greatly shorten the life of the battery. Therefore, output current as well as output voltage of the charging system should be checked. **NOTE:** A check of the charging system should include a check of the battery cables to ground and to the alternator to determine bad connections.

ALTERNATOR TEST SET UP:

- 1) Connect tester to battery as shown in (see figure 9). Press the Test Selection [2] button until the Alternator LED is lit. Connect Amp Probe around positive output cable of alternator. If wires split off to feed power to accessories, the pickup must be placed over the wires between the point of the split and the alternator. Do not place the pickup closer than 6 inches to the alternator or the current readings may be affected by the magnetic field of the alternator.
- 2) Make sure all accessories are off in the vehicle.
- 4) Start vehicle and allow the engine a few seconds to stabilize the voltage. Press the Start Test [4] button.

REMEMBER: Charging systems in a vehicle will compensate for ambient temperatures by increasing the charging voltage at low temperatures. Check the vehicle service manual for proper charging voltages at low temperatures.

ALTERNATOR TEST:

- 1) The tester will first check the battery voltage; it should be in the range of 13.0V and 14.8V, older vehicles may have slightly higher voltages. If the voltage is below this the tester will display "LO" with the FAULT LED lit at end of test. If the voltage is above the 14.8V then it will display "HI" with the FAULT LED lit at the end of the test.
- 2) After checking the voltage, the unit checks the ripple on the Alternator if the tester determines the ripple to be too high an indication of a bad diode or stator problem then it will display "HIA" with the FAULT LED lit at end of test.
- 3) After the no load test the unit will apply a 70A load, the operator should see the current increase in the amp display to reflect this. The test then checks the voltage on the battery again to make sure it falls in the range mentioned above. If the unit is above the 14.8V the tester will display "HI" with the FAULT LED on. If the voltage falls below the 13.0V the unit will flash the minimum voltage and turn on the FAULT LED. At this point it is up to the technician to determine due to the size of the alternator or the RPM of the alternator if this is a problem. If the voltage was within the recommended range of the test it will display "Good" and the min voltage reading during the test.

MEASURING CURRENTS and DIFFERENTIAL VOLTAGES:

To use the Amp Probe and the Differential Voltage leads when not doing a standard test take the following steps:

- 1) Make sure the differential voltage leads and the amp probe are not connected. The 6044 zero's these two items on power-up so any voltage reading on them now will be considered zero.
- 2) Connect the unit to the battery. (see figure 10)
- 3) Connect/install Differential Voltage leads and Amp-Probe into there respective jacks. Amp-probe should not be around any cables at this time, this would cause the amp-probe to use amp reading at this time to be zero.
- 4) Turn on the Amp-Probe and press the blue auto zero button on the front. This will remove any memory of magnetism left in the core and should be pressed before any test using the amp-probe
- 5) Press Test Selection [2] until the Starter LED is lit.
- 6) Press Start Test [4] the Starter LED should start flashing.
- 7) Press the up arrow; now the Differential (external) Voltage will be displayed in the voltage window and the Amp-Probe reading will be displayed in the Amps window.
- 8) For negative values the right most decimal point will be lit in the display (235.).

Measuring Maximum values with the Amp-probe and Differential Voltage leads:

- 1) Make sure the differential voltage leads and the amp probe are not connected. The 6044 zero's these two items on power-up so any voltage reading on them now will be considered zero.
- 2) Connect the unit to the battery. (see figure 10)
- 3) Connect/install Differential Voltage leads and Amp-Probe into there respective jacks. Amp-probe should not be around any cables at this time, this would cause the amp-probe to use amp reading at this time to be zero.
- 4) Turn on the Amp-Probe and press the blue auto zero button on the front. This will remove any memory of magnetism left in the core and should be pressed before any test using the amp-probe
- 5) Press Test Selection [2] until the Starter LED is lit.
- 6) Press Start Test [4] the Starter LED should start flashing.
- 7) Press the down arrow; the unit is now in the record mode it will look for the maximum and minimum differential voltages and the peak current measured on the amp-probe. The display will show the active readings on the amp-probe and the differential leads.
- 8) After testing is done press the Test Select [2] button: the voltage display will now alternate between the maximum and minimum voltage values recorded while testing, the "MIN VOLTS" LED will lit when displaying the minimum voltage value. The Amp display will show the maximum current recorded by the amp-probe and light the "MAX. AMPS" LED.
- 9) To reset press the Test Select [2] button.

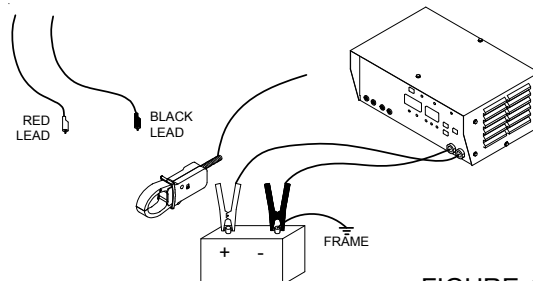

FIGURE 10

The AEC 132-0137 (6043) Amp-Probe may also be used independently of the 6044. Plug the insulated jacks into a standard digital Multimeter and set the meter for DC millivolts (mV); the Amp-Probe reads 1mV = 1 Amp. If the Amp-probe needs to be used for AC current just set the Multimeter to ACV (AC volts).

6044 TROUBLESHOOTING HINTS:

- Was the unit connected with the correct polarity?
- The unit needs at least 7.5V from the battery to operate correctly if the voltage drops below this level the display may go blank or have an erratic display.
- Is the battery in the Amp-probe good?
- Is the unit displaying "HOT"? It will not run the battery test when the unit is hot. Let unit cool before attempting battery test.
- The differential leads(external leads) and the amp-probe are zeroed at power up if a voltage or current is present at this time then those values are considered zero, and can cause errors in further readings by those devices/items. The zero value can be checked by installing the amp-probe and pressing the zero button and connecting the differential leads and then shorting them together then placing the unit in the display mode. This is done by pressing Select Test [2] until the starter LED is lit, then pressing Start Test [4] button (starter Led will be flashing) and then pressing the up arrow. At this time the values in the amp and voltage display should be reading very close to zero. If not, leave the amp probe and differential leads as they are and disconnect the unit from the battery and reconnect (resetting power to the unit) this should zero the devices.