

# AuburnGear

## AFTERMARKET PRODUCT CATALOG

**Your One Stop Shop for Aftermarket Products**





# TABLE OF CONTENTS

06	ECTED MAX
08	LIMITED SLIP DIFFERENTIALS
12	AMC
13	CHRYSLER
17	AUBURN
28	FORD
34	GM
43	TOYOTA
46	NISSAN
47	SERVICE KITS
48	D-REX PROGRAM
50	OPTIMAL GEAR RATIO CHART
52	FAQ

**NEW**

**DIFFERENTIALS FROM  
AUBURN GEAR**

CHRYSLER 9 1/4" "ZF REAR"

AUBURN PRO 60

AUBURN 70 ECTED

AUBURN 80 ECTED

GEN 5 CAMARO 218MM 10 BOLT

NISSAN TITAN 10 BOLT

HIGH PERFORMANCE RING & PINION

MASTER INSTALL KITS

MAX LOCK LOCKERS



## OUR MISSION FOR QUALITY...

Auburn Gear, LLC is dedicated to achieving total customer satisfaction by continuously improving our products & services.

***ENHANCED PERFORMANCE.  
QUALITY. RELIABILITY.***

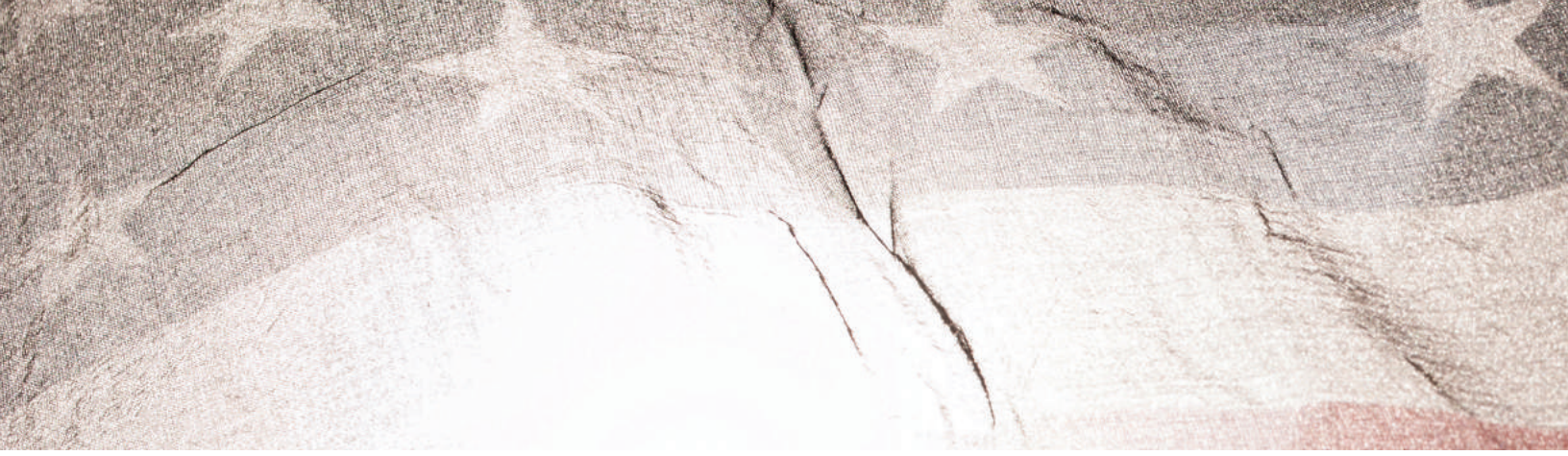

# AMERICAN MADE DIFFERENTIALS WITH A CAN DO ATTITUDE.

## TRACTION FOR EVERYTHING THAT MOVES

Through each curve, bump, burnout and obstacle, your vehicle will be guided by the traction and control that has been skillfully engineered by the minds and hands at Auburn Gear.

We design and build high-performance selectable lockers and limited-slip differentials for enthusiasts like you who remember what it means to be American made.

With more than 70 years of gear technology experience, Auburn Gear rolls on.

All of our knowledge and experience goes into ensuring you receive a reliable, performance traction control differential that will step up when you need it and take you where you want to go—street, strip, track, on or off road. That's command traction control.



# AMERICAN MADE





## Production:

AUBURN, INDIANA | 250K SQ. FT. | FULLY INTEGRATED FOR OPTIMUM CONTROL OF QUALITY & VALUE

- Application engineering and rapid prototyping
- Development, gauge, gear and metallurgical laboratories
- Turning, gear cutting, spline rolling, heat treating, shot peening, and finished grinding

## Testing:

IN DESIGN | IN THE LAB | IN THE REAL WORLD

- Finite Element Analysis (FEA)
- Axle dynamometer testing
- Vehicle application stress tests in the field
- “Real World” tested by thousands of customers across the globe

**THIS IS WHY YOU'RE HERE.**

**THIS IS WHAT IT BOILS DOWN TO – WHERE THE TRACTION MEETS THE ROAD, TRACK, ROCKS, MUD AND DIRT**

For more than 70 years, high-performance street and off-road enthusiasts have looked to Auburn Gear for enhanced traction capabilities beyond the OE standard.

True command traction courtesy of the ECTED Max, two differentials in one, the world’s only selectable locking differential with full-time limited-slip capabilities. Page 6.



Smooth, fast, high-bias torque-sensing power in a range of Auburn Gear limited-slip differentials. Page 8.





# LEAD THE PACK

## ECTED

### MAX



GO ANYWHERE WITH THE ONLY 2-IN-1 PERFORMANCE TRACTION DIFFERENTIAL

### It's Limited-Slip Plus the Power of a Selectable Full-Locker!

The ECTED Max is a traction technology product that puts a selectable full-locker or limited-slip operational mode right at your fingertips.

Shift on the fly with just the flip of a switch, and go from high-performance traction control to a full-locker mode that delivers 100 percent torque transfer to both wheels for extreme-duty off-roading and high performance drag racing.

The ECTED Max enhances 2-WD mobility unlike any other performance traction differential on the market and makes 4-WD vehicles virtually unstoppable. ECTED Max is ideal for street-strip use: limited-slip traction for street and full-locker performance for the strip in one differential. ECTED Max is the best solution for 4-WD vehicles that are used both on and off road.

## ECTED:

Electronically Controlled Traction Enhancing Differential

ECTED Max™ Limited Slip To Lock Advantages

- Gearing is made from aircraft quality, 9310 heat treated billet steel to make it tough, durable, and reliable.
- Switch the locker on or off on the fly, at moderate road speeds (with all 4 wheels on the ground).
- No need for shift forks or pins that must be lined up to obtain locker mode.
- Noisy lockers? Not here! ECTED Max is quiet.
- Backed by a one-year warranty, plus the industry exclusive D-REX (new differential exchange) program. See page 47 for details.
- ECTED Max can be used in front axle applications, with or without lockout hubs.

**IMPORTANT NOTE:** ECTED Max Limited Slip To Lock is NOT recommended for use with front axles that feature an "inter-axle disconnect."

### NEW ECTED Max™ Open-To-Lock Advantages

- Electronic open-to-lock
- 100% Made in the USA
- King of the Hammers Race Proven and MOAB Proven
- Lightning fast engagement and disengagement
- No Air Lines! No Problems!
- High strength military grade case design, essentially bullet proof
- The gear geometry of our new differential minimizes mechanical complexity, locks the gears to the differential housing and thus transfers torque directly from the differential case, NOT through the gears!



# THE AUBURN GEAR DIFFERENTIAL ADVANTAGE IS SIMPLE



Here's an equally simple chart to prove it. No other locker offers limited-slip capabilities when switched off.

	OPEN DIFF	LIMITED-SLIP DIFF	LOCKER
<b>Auburn Gear ECTED Max</b>		X	X
<b>Air Locker</b>	X		X
<b>Electric Locker</b>	X		X



**Everything you need to install the ECTED Max comes in one box—the unit, wiring harness, Auburn Gear limited-slip additive and instructions.**

## THE SCIENCE BEHIND THE SUPERIORITY

The ECTED Max is a selectable traction device featuring an ON/OFF switch mounted near the driver. When OFF, the clutch pack (7), located behind the side gear (6), activates the limited-slip mode. As torque increases, the separating forces within the differential gears increases, causing the clutch pack to be compressed, providing bias torque to the high traction wheel. When selected on, current is sent to the electromagnetic coil (8). The

coil is retained by a clip that fits over one of the bearing cap bolts, making it non-rotational. The coil rides on a ball bearing (9), and the ball bearings spin with the differential case (10). The coil creates a magnetic flux so that the pilot cone (1) is pulled into engagement with the differential case (10). This frictional engagement causes the bearing balls (2) to ride up on a ramp machined into the side gear (3). This radial travel of the balls (2) also causes lateral movement

of the side gear (3). The lateral movement of the side gear (3) applies a force onto the center block (4). The center block (4) has an elongated hole that the center pin (5) fits through, allowing it to float. The center block (4) also applies force to the opposite side gear (6) to compress the clutch pack (7) and provide the vehicle with a solid axle assembly and 100% transfer of torque to both wheels for maximum traction.

NOTE: The side gear (3) is not included in the Master Install Kit. However, the pinion gears (\*) are included.

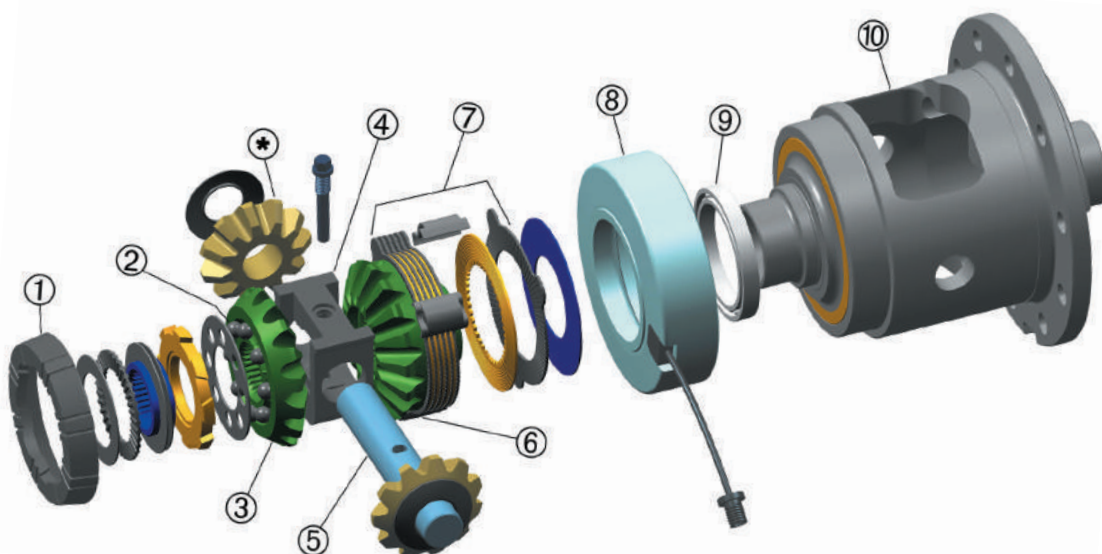

**EXAMPLE:** Other ECTED Max differentials will vary in design layout.



# GET A GRIP

## PERFORMANCE LIMITED-SLIP DIFFERENTIALS

**More traction, lightning-fast action.** Unleash your vehicle's true performance. The Auburn Gear, High Performance Series, high-bias torque Pro Series, and Race Series limited-slip differentials out perform virtually every standard OEM differential.

To really see and feel what your vehicle can do, Auburn Gear differentials effectively and efficiently transfer your power to the wheels. Auburn Gear differentials deliver usable traction and faster engagement for controlled power transfer and lightning-fast reaction to changing road conditions.

No matter what your application—performance or passenger, light or heavy, on or off road—Auburn Gear limited-slip differentials are engineered to provide smooth torque-sensing operation and durable, dependable performance.



Auburn Gear's flagship limited-slip differential gives you smooth torque-sensing operation with the correct bias ratios to out perform the competition.



The Pro Series turns your torque up another notch, offering an even higher bias ratio and faster sensing reaction than HP for the very best in controlled power transfer.



Auburn Gear has developed, tested and is making available a racing differential for the 7 5/8 Firebird/Camaro, original gear ratio of 3.23 and up, with 28 axle spline. We've also developed, tested and are making available a racing differential for Ford 8.8, all ratios, and 28-axle spline.



## Why Auburn Gear limited-slip differentials?

Auburn Gear Pro Series and High Performance Series differentials provide superior performance through a unique cone-clutch design that transfers more power to the high-traction wheel for quick acceleration and tight cornering.

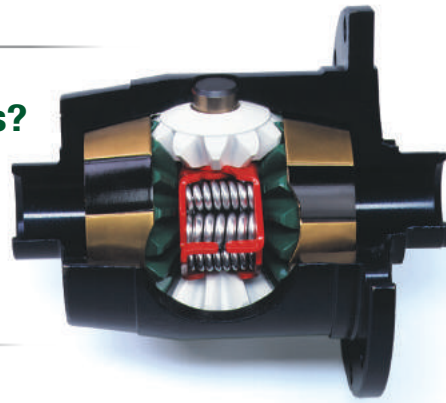

## IT COMES DOWN TO THE CONE AND CUP DESIGN

The Auburn Gear limited-slip differential employs an integral cone clutch side gear unit that creates friction with the carrier to drive both tires. The highly efficient torque transfer capability of the Auburn Gear limited-slip differential is achieved through the use of cone clutches coupled to beveled side

gears. As torque is transmitted through the differential side gears to the axle shafts, the side gear separating forces and preload spring firmly seat the cones into the differential case. The cone design, along with the applied force, determines the torque transfer capability of the differential. When

torque levels decrease, as in a cornering maneuver, the gear separating forces also decrease, allowing the axle shafts to rotate independently. This divides the torque between the two wheels, delivering more torque (bias torque) to the wheel with the most traction.

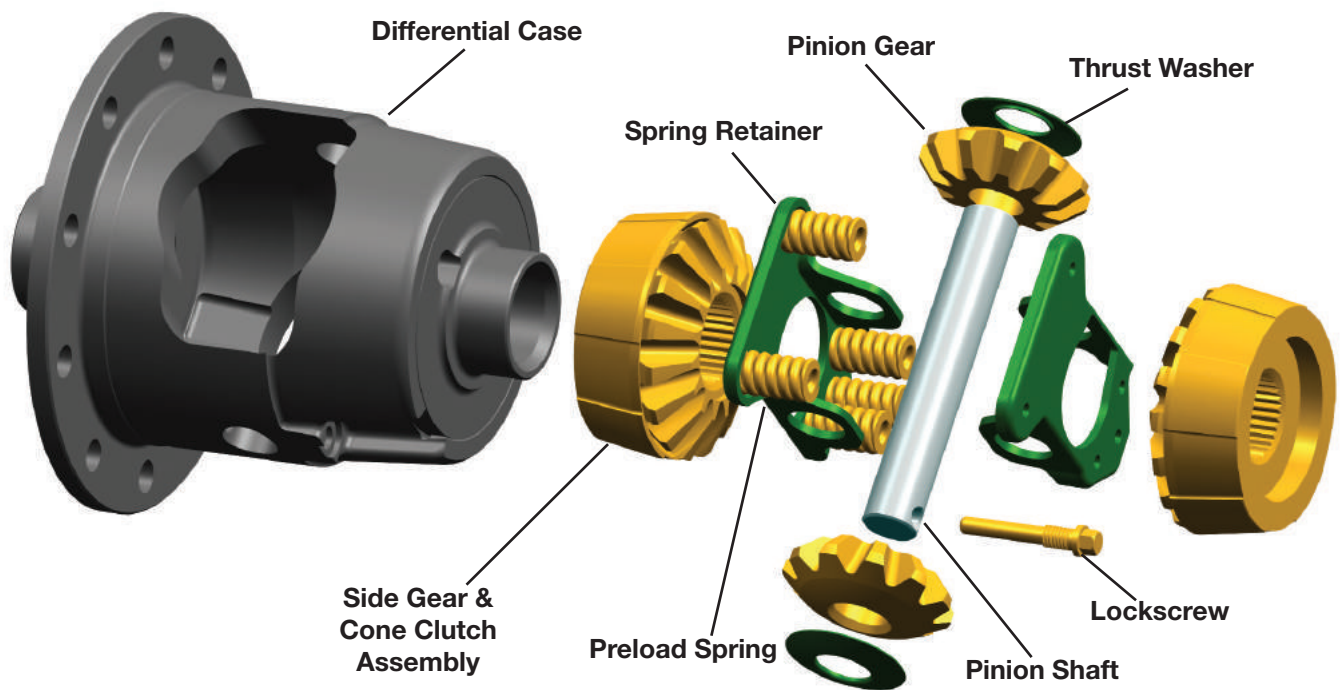

# MAKING THE RIGHT SELECTION

**IT'S ABOUT MORE  
THAN THE VEHICLE  
YOU DRIVE.**

**It's about you**—where you plan to go, particularly if you're taking on new frontiers, and what your performance expectations are when you get there.

We've designed our new catalog to make product selection as easy as possible for you. If you still have questions, however, your authorized Auburn Gear distributor and Auburn Gear customer service representatives are always ready to provide the help and answers you need.







- Made in the USA.
- Auburn Gear's flagship Limited Slip Differential gives you smooth torque-sensing operation with the correct bias ratios to outperform the competition.
- Provides maximum amount of torque transfer without compromising the performance requirements of a vehicle in situations where torque transfer is required.
- Backed by a one year limited warranty, plus an exclusive four years of coverage through the D-REX Program!



- Made in the USA.
- Turn up your torque with our Pro Series differential for the very best in controlled power transfer.
- High Torque bias Cone Clutch design provides Maximized Torque Transfer, making it the Ultimate Limited Slip Differential for true performance.
- Backed by a one year limited warranty, plus an exclusive four years of coverage through the D-REX Program!



- Made in the USA.
- Performance Racing limited-slip differential developed specifically for road racing.
- A differential case designed to allow the center pin to float along with the axle shafts
- Race design features benefit drivers by, giving the racer an extremely "tight" rear axle when cornering.
- Backed by a one year limited warranty, plus an exclusive four years of coverage through the D-REX Program!



- Made in the USA.
- 2 Diffs in 1.
- Aircraft quality 9310 heat treated billet steel gearing.
- With the flip of a switch, go from Limited Slip to a Full Locking mode that delivers 100% torque to both wheels!
- Backed by a one year limited warranty, plus an exclusive four years of coverage through the D-REX Program!

# AMC 20, 12 Bolt

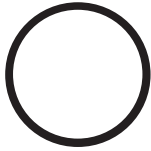

10 1/32" x 10 25/64"  
12 Holes, Round

**ECTED Max  
Selectable Locker**

**Pro Series Differential**

YEAR	PART #	RATIOS	SIDE GEAR SPLINE	BEARING CONE*	BEARING CUP*
<b>1966–Present</b>	545006	2.73:1 & Down	29 Teeth	LM60304	LM603012
<b>1966–1986</b>	545007	3.07:1 & Up	29 Teeth	LM603049	LM603012
<b>1966–1986</b>	542081	3.07:1 & Up	29 Teeth	LM603049	LM603012

**Applications:**

All AMC 20 Axles

**IMPORTANT NOTE:** Be certain that the axle shaft extends beyond the gear face. Some aftermarket one-piece axle shafts are shorter than the stock shaft. Using an axle shaft that is too short will promote failure to the axle shaft splines.

**SPECIAL NOTES:** Some AMC 20 applications require the use of an axle spacer, which is included with the unit.

(Not used if axle bearing is updated on 1 pc. axles.)

Part #545006 fits H1 Hummer

**Make Year**

Jeep C101	1967–1972
Jeep CJ5 & CJ7	1967–1986
Jeep Wagoneer	1967–1986
Jeep J-10	1966–1986
Ambassador	1968–1974
AMX	1968–1979
Concord	1978–1979
Gremlin	1970–1978
Hornet	1972–1978
Javelin	1968–1974
Matador	1972–1978
Pacer V8	1978–1979
Rambler	1969–1972
Scrambler	1976–1978
Spirit V8	1979



Use Auburn Gear limited-slip additive for maximum performance. A 6 oz. bottle is included with your Auburn Gear differential. Part #504102.

**ECTED Max Features and Benefits**

- Made in the USA.
- 2 Diffs in 1.
- Aircraft quality 9310 heat treated billet steel gearing.
- With the flip of a switch, go from Limited Slip to a Full Locking mode that delivers 100% torque to both wheels!
- Backed by a one year limited warranty, plus an exclusive four years of coverage through the D-REX Program!

**Pro Series Features and Benefits**

- Made in the USA.
- Turn up your torque with our Pro Series differential for the very best in controlled power transfer.
- High Torque bias Cone Clutch design provides Maximized Torque Transfer, making it the Ultimate Limited Slip Differential for true performance.
- Backed by a one year limited warranty, plus an exclusive four years of coverage through the D-REX Program!

**IMPORTANT NOTE:** Bearings not included unless specifically stated. Applications listed (make & year) are for reference only. Always verify axle/ring gear size, the ratio to be used and the number of axle splines prior to purchase and installation.





# Chrysler 8<sup>1</sup>/<sub>4</sub>" & 8<sup>3</sup>/<sub>8</sub>" 10 Bolt

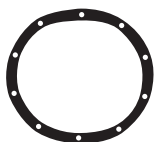

11<sup>3</sup>/<sub>8</sub>" 10 Holes, Oval

**High Performance Differential**

YEAR	PART #	RATIOS	SIDE GEAR SPLINE	BEARING CONE*	BEARING CUP*
1966-1996	542072	2.71:1 & Up	27 Teeth	LM603049	LM603012
1997-Present	542074	2.71:1 & Up	29 Teeth	LM603049	LM603012

**Applications:**

All Chrysler products with 8 1/4" & 8 3/8" ring gear. Accepts tone ring for ABS applications.



Use Auburn Gear limited-slip additive for maximum performance. A 6 oz. bottle is included with your Auburn Gear differential. Part #504102.

Make	Year
Jeep Liberty	2002-Present
Passenger Cars, Various	1973-1997
B100, 150, 200, 250	1969-Present
B,D,W-100	1966-1997
B,D,W-200	1969-1997
B,D,W-300	1966-1997
Aspen/Volare	1976-1980
Barracuda/Challenger	1970-1974
Charger/Coronet	1973-1976
Chrysler 300	1972-1979
Cordoba	1975-1983
Dakota	1987-Present
Dart	1972-1976
Diplomat/LeBaron	1977-1983
Fifth Avenue/New Yorker	1972-1988
Imperial	1981-1983
Fury	1970-1981
Mirada/Magnum	1978-1983
Newport	1972-1973
Polara/Satellite	1970-1974
St. Regis	1979-1981
W100, 150	1986-Present

## High Performance Series Features and Benefits

- Made in the USA.
- Auburn Gear's flagship Limited Slip Differential gives you smooth torque-sensing operation with the correct bias ratios to outperform the competition.
- Provides maximum amount of torque transfer without compromising the performance requirements of a vehicle in situations where torque transfer is required.
- Backed by a one year limited warranty, plus an exclusive four years of coverage through the D-REX Program!

Chrysler 8 1/4" applications require modification to the axle housing as shown to provide clearance for the differential case. Clean housing after grinding.

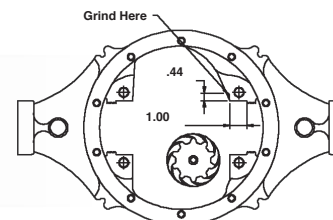

## Chrysler 8<sup>3</sup>/<sub>4</sub>" 10 Bolt

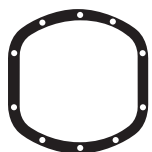

8<sup>11</sup>/<sub>16</sub>" x 10<sup>19</sup>/<sub>32</sub>"  
10 Holes, Round

### Pro Series Differential

YEAR	PART #	RATIOS	SIDE GEAR SPLINE	BEARING CONE*	BEARING CUP*
1957-1974	542051	All Ratios	30 Teeth	LM104949	LM104912

#### Applications:

All Chrysler products with 8<sup>3</sup>/<sub>4</sub>" ring gear.



Use Auburn Gear limited-slip additive for maximum performance. A 6 oz. bottle is included with your Auburn Gear differential. Part #504102.

#### Make Year

300	1957-1973
B200/B250	1965-1974
Barracuda	1964-1974
Belvedere	1957-1970
Challenger/Duster	1970-1974
Charger (Daytona)	1966-1974
Concord	1963-1968
Coronet	1969-1970
Dart/Swinger	1966-1972
Fury	1957-1974
Imperial	1957-1974
Monaco	1963-1974
Newport/New Yorker	1969-1974
Polara	1963-1974
Road Runner/Satellite	1967-1974
Super Bee	1968-1970
Town & Country	1957-1974
Vallant	1960-1974
W100/W150	1965-1974

### Pro Series Feature

High Torque bias Cone Clutch design provides Maximized Torque Transfer, making it the Ultimate Limited Slip Differential for true performance.

## Chrysler 9<sup>1</sup>/<sub>4</sub>" 12 Bolt

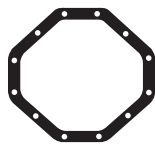

12<sup>3</sup>/<sub>8</sub>" x 11<sup>1</sup>/<sub>2</sub>"  
12 Holes, Irregular

### High Performance Differential

YEAR	PART #	RATIOS	SIDE GEAR SPLINE	BEARING CONE*	BEARING CUP*
1968-1983	542071	2.71:1 & Up	31 Teeth	JLM704649	JLM704610
1984-2009	542070	2.71:1 & Up	31 Teeth	JLM704649	JLM704610

#### Applications:

Part #542071: All Chrysler products with 9<sup>1</sup>/<sub>4</sub>" ring gear.

Part #542070: All Chrysler products with 9<sup>1</sup>/<sub>4</sub>" ring gear.

Accepts tone ring for ABS applications.



Use Auburn Gear limited-slip additive for maximum performance. A 6 oz. bottle is included with your Auburn Gear differential. Part #504102.

#### Make Year

B350	1984-Present
Bordoba	1975-1979
Charger	1974-1976
D200	1966-Present
D300/D350	1974-Present
Dakota V8	1998-Present
Durango	1997-Present
Fifth Avenue/Fury	1973-1981
Imperial	1974-1975
Monaco	1975-1985
Newport/New Yorker	1973-1981
Polara	1970-1974
Ramcharger/Trailduster	1974-Present
W100/W150/W200/W250	1966-Present

\*Bearing parts numbers are for reference and NOT included unless specifically noted.

### High Performance Series Feature

Auburn Gear's flagship Limited Slip Differential gives you smooth torque-sensing operation with the correct bias ratios to outperform the competition.

**ENHANCED PERFORMANCE.  
QUALITY. RELIABILITY.**

Always in stock at your authorized Auburn Gear distributor.



**NEW**

# Chrysler 9 1/4" RING & PINION REAR STYLE

PART #	OEM REFERENCE #	TEETH	RATIO
342043	3837595	39-11	3.55:1
342049	n/a	47-12	3.92:1

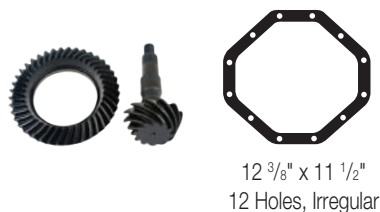

**Specifications:**

Ring Gear Diameter 9.25"  
 12<sup>7</sup>/<sub>16</sub>" X 18 LH Threaded Bolts  
 Pinion Diameter 1.876" 29 Splines  
 Case Ratio: 2.71:1 & Numerically Higher  
 8620 Material—Heat Treated

**Compatible Auburn Gear Differential Part Numbers**  
 542071 542070

Make	Year
B350	1984–Present
Charger	1974–1976
Cordoba	1975–1981
D300/D350	1974–Present
Dakota W/V8	1998–Present
Durango	1998–Present
Fifth Avenue	1980–1981
Fury	1973–1981
Imperial	1974–1975
Monoco	1975–1985
Newport	1973–1981
New Yorker	1972–1981
Polara	1970–1974
Ramcharger	1974–1993
Trailduster	1974–Present
Truck 1/2 Ton	1974–2009
Truck 3/4 Ton	1974–Present
Truck 1 Ton	1974–2000
W100/W150/W200/W250	1974–Present

## MASTER INSTALLATION KIT REAR STYLE

PART #	DESCRIPTION	MODEL YEARS
541085	Chrysler 9.25" 12 Bolt	1969–2000
541086	Chrysler 9.25" 12 Bolt	2001–Present

**\*Kit Contains Timken Bearings**



### MASTER INSTALLATION KITS

- Ring Gear Bolts • Differential Bearings • Silicone Sealant • Pinion Bearings • Crush Collar • Brush • Pinion Shims • Differential Shims • Gear Marking Compound • Pinion Seal • Pinion Nut • Thread Adhesive •

**NEW**

**Chrysler 9 1/4" 12 Bolt "ZF Rear"**

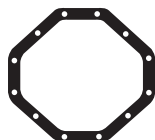

11.87" x 12.8"  
12 Holes, Irregular

**High Performance Differential**

YEAR	PART #	RATIOS	SIDE GEAR SPLINE	BEARING CONE*	BEARING CUP*
2010–Present	5420142	2.71:1 & Up	31 Teeth	JLM704649	JLM704610

**Applications:**

NEW Chrysler 9.25" 12 Bolt "ZF Rear"  
Works with OEM ABS Applications



Use Auburn Gear limited-slip additive for maximum performance. A 6 oz. bottle is included with your Auburn Gear differential. Part #504102.

Make	Year
Dodge Durango Citadel	2011–2015
Dodge Durango Crew	2011–2013
Dodge Durango Express	2011
Dodge Durango Heat	2011
Dodge Durango Limited	2015
Dodge Durango R/T	2011–2015
Dodge Durango Rallye	2015
Dodge Durango Special Service	2012–2015
Dodge Durango SXT	2012–2015
Jeep Grand Cherokee Laredo	2010–2015
Jeep Grand Cherokee Limited	2010–2015
Jeep Grand Cherokee Overland	2011–2015
Jeep Grand Cherokee Overland Summit	2012
Jeep Grand Cherokee SRT	2015
Jeep Grand Cherokee SRT8	2012–2013
Jeep Grand Cherokee Summit	2015
RAM 1500 Big Horn	2012
RAM 1500 Big Horn	2015
RAM 1500 Express	2012–2015
RAM 1500 HFE	2013–2015
RAM 1500 Laramie	2011–2015
RAM 1500 Laramie Limited	2013–2015
RAM 1500 Laramie Longhorn	2011–2015
RAM 1500 Lone Star	2015
RAM 1500 Outdoorsman	2012
RAM 1500 Outdoorsman	2015
RAM 1500 R/T	2013
RAM 1500 SLT	2011–2015
RAM 1500 Special Service	2014
RAM 1500 Sport	2011–2015
RAM 1500 ST	2011–2012
RAM 1500 Tradesman	2011–2015
RAM 1500 Tradesman HD	2012

**High Performance Series Features and Benefits**

- Made in the USA.
- Auburn Gear's flagship Limited Slip Differential gives you smooth torque-sensing operation with the correct bias ratios to outperform the competition.
- Provides maximum amount of torque transfer without compromising the performance requirements of a vehicle in situations where torque transfer is required.
- Backed by a one year limited warranty, plus an exclusive four years of coverage through the D-REX Program!





# Auburn 30

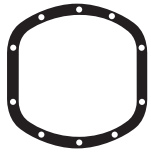

9 1/8" x 8 3/4" 10 Holes

**ECTED Max Selectable Locker**

YEAR	PART #	RATIOS	SIDE GEAR SPLINE	BEARING CONE*	BEARING CUP*
1967–Present	545016	3.55:1 & Down	27 Teeth	LM501349	LM501314
1967–Present	545017	3.73 & Up	27 Teeth	LM501349	LM501314

**Applications:**  
All Dana 30 models without "C" clips.

**IMPORTANT NOTE:** Model 30 setup bearing kit available, part number 541074.



Use Auburn Gear limited-slip additive for maximum performance. A 6 oz. bottle is included with your Auburn Gear differential. Part #504102.

Make	Year
Jeep C-101 Jeepster	1967–1972
Jeep Cherokee/Wagoneer Full Size	1971–1973
Jeep CJ	1971–1986
Jeep MJ Comanche	1984–mid 1991
Jeep TJ	1986–Present
Jeep XJ Cherokee	1984–2001
Jeep YJ	1987–1996
Jeep ZJ/	
WJ Grand Cherokee	1993–Present
Ford Aerostar (R)	1985–1989

Front Axle	
Courier * (F)	1979–1980
Ford Bronco (F)	1967–1971
International Scout (F)	1967–1978
Jeep JK (Non Rubicon)	2007–Present
Mazda * (F)	1979–1980
Nissan * (F)	1979–1980
Toyota * (F)	1979–1980

\* Above vehicles that are equipped with conversion front ends

## ECTED Max Feature

With the flip of a switch, go from Limited Slip to a Full Locking mode that delivers 100% torque to both wheels!

## Auburn 30 RING & PINION

PART #	OEM REFERENCE # FRONT	OEM REFERENCE # REAR	TEETH	RATIO
342048*	n/a	n/a	39-8	4.88:1
342050^	n/a	n/a	39-8	4.88:1
342057•~	n/a	n/a	39-8	4.88:1



9 1/8" x 8 3/4" 10 Holes

\*JK—Front, Reverse Cut

^Standard Cut

•Short Pinion—Pinion Length 7" (Fits '97 and up TJs)

~ Does fit TJ 342050 '96 and prior

### Specifications:

- Ring Gear Diameter 7.20"
- 10 3/8" X 24 RH Threaded Bolts
- Pinion Diameter 1.376" 26 Splines
- Case Ratio: 3.55:1 & Numerically Lower
- Case Ratio: 3.73:1 & Numerically Higher
- 8620 Material—Heat Treated

**Compatible Auburn Gear Differential Part Numbers**  
545016 544901  
545017

## MASTER INSTALLATION KIT

PART #	DESCRIPTION	MODEL YEARS
5410115	Bearing Master Kit Auburn 30 JK Front	2007–2016
5410116	Bearing Master Kit Standard Auburn 30 TJ	1997–2006

**\*Kit Contains Timken Bearings**

Make	Year
AMC Eagle FRT	1987–1987^
Bronco & U100	1967–1971^
Explorer	2001–Present^
Ford Aerostar	1987–mid 1989
Grand Cherokee WJ	1999–Present^
Grand Cherokee ZJ	1992–1996^
IHC Scout F	1967–1975^
Jeepster	1972–1973^
Jeep C101 F&R	1967–1974
Jeep CJ5, CJ7F & CJ8	1974–1986
Jeep J10 F	1966–1971
Jeep Wagoneer F	1972–1973
Jeep Cherokee XJ	1984–Present
Jeep TJ^	1997–2006
Jeep JK Non Rubicon	2007–2016
Jeep Wrangler TJ	1997–Present
Jeep Wrangler YJ	1987–1996
Liberty Truck	2002–Present

# Auburn 35

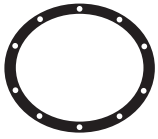

9 1/4" x 10 3/8" 10 Holes

**ECTED Max  
Selectable Locker**

YEAR	PART #	RATIOS	SIDE GEAR SPLINE	BEARING CONE*	BEARING CUP*
1987–Present	545012	3.31:1 & Down	27 Teeth	LM102949	LM102911
1987–Present	545013	3.55:1 & Up	27 Teeth	LM102949	LM102911
1987–Present	545014	3.31:1 & Down	30 Teeth^	LM102949	LM102911
1987–Present	545015	3.55:1 & Up	30 Teeth^	LM102949	LM102911

^30 teeth requires aftermarket axle shafts.

**Applications:**

All Dana 35 models.

**IMPORTANT NOTE:** These are not stock bearings. Bearings are available from Auburn Gear. Bearing kit part number 541070.



Use Auburn Gear limited-slip additive for maximum performance. A 6 oz. bottle is included with your Auburn Gear differential. Part #504102.

**Make**

**Year**

Jeep MJ Comanche	1984–mid 1991
Jeep TJ	1997–Present
Jeep XJ Cherokee	1984–1901
Jeep YJ	1987–1996
Jeep ZJ/	
WJ Grand Cherokee	1993–Present

**Front Axle**

Ford Explorer/	
Ford Ranger 4.0L * (F)	1990–1997
Mazda B4000 * (F)	1990–1997
Mountaineer 4.0L * (F)	1990–mid 1995

\* Above units will work by adding coil spring in the right side axle slip yoke assembly







# Auburn 44

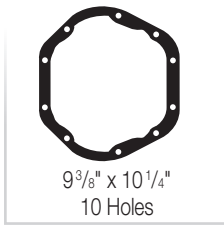

9 3/8" x 10 1/4"  
10 Holes

**Applications:**

All Dana 44 models without "C" clips.

**SPECIAL NOTE:**

Some Dana 44 applications (19 tooth axle splines) require the use of an axle spacer, which is included with the unit.

**IMPORTANT NOTES:**

Auburn 44 differentials will not fit Dodge Viper or Corvette. Will not work w/ aluminum axle housing. There is a 1" difference in length of differential.

Model 44 setup bearing kit available, part #541075. This is for fit only. Setup prior to bearings being pressed on.

Also, for models 2007 and newer, check your vehicle axle shaft spline before ordering. Some vehicles may have a 31 tooth configuration.

Will not fit in JKs with Tracklock installed "OE."

High Pinion 44 Aftermarket uses 545019

\*\*\*Ring gear bolt holes on flange may or may not need to be drilled out for proper ring gear bolt fit and alignment.\*\*\*

	YEAR	PART #	RATIOS	SIDE GEAR SPLINE	BEARING CONE*	BEARING CUP*
<b>ECTED Max Selectable Locker</b>	1971–Present	545018 <sup>^*</sup>	3.73:1 & Down	30 Teeth (only)	25590	25523
	1971–Present	545019	3.92:1 & Up	30 Teeth (only)	25590	25523
	1971–Present	5420109	3.92:1 & Up	30 Teeth	25590	25523
<b>High Performance Differential</b>	1987–Present	5420110*	3.73:1 & Down	30 Teeth	25590	25523
	1970 & Prior	5420111	3.92:1 & Up	19 Teeth	25590	25523
	1970 & Prior	5420112*	3.73:1 & Down	19 Teeth	25590	25523
<b>Pro Series Differential</b>	1971–Present	542082	3.92:1 & Up	30 Teeth	25590	25523
	1971–Present	542083*	3.73:1 & Down	30 Teeth	25590	25523
	1970 & Prior	542084	3.92:1 & Up	19 Teeth	25590	25523
<b>4 Pinion Open Differential</b>	1970 & Prior	542085*	3.73:1 & Down	19 Teeth	25590	25523
	1971–Present	5420151	4:10 & Up	30 Teeth	25590	25523
	1971–Present	5420147	3.73 & Down	30 Teeth	25590	25523

<sup>^</sup>For the 2003-2006 TJ Rubicon, all ratios, please specify part #545018.  
\*Jeep JK & TJ always use 3.73:1 & Down regardless of ratio.

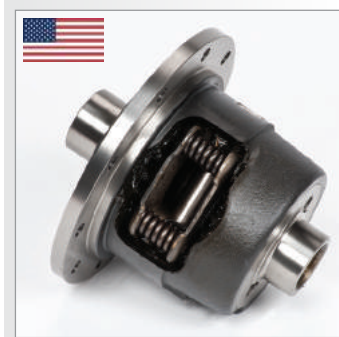

Make	Year
Jeep Comanche	1986–1992
Jeep Cherokee	1976–1992
Jeep C101	1967–1972
Jeep CJ5	1967–1975
Jeep CJ7	1967–1975
Jeep CJ7	1985–1986
Jeep JK (Non Rubicon)	2007–Present
Jeep "TJ"	2001
Jeep Wagoneer	1967–1983
Chevrolet C10, 5	1960–1970
Cobra	1963–1967
Ford F100 F150 4x4	1967–1978
Thunderbird	1955–1956
IHC Scout	1967–1980
IHC 100, 150, 200, 1100, 1110, 1200, 1210	1965–1970

Front Axle	
Jeep CJ5	1967–1975
Jeep CJ7	1967–1975
Jeep Grand Wagoneer	1984–1992
Jeep J10, 20	1974–1986
Jeep Wagoneer	1967–1983
Blazer	1975–1979
Chevrolet K10, 25	1960–1980
Chevrolet K30, 35	1967–1976
Chrysler W100,150	
200, 300 & 350	1969–Present
Dodge Ram 1500	1997–2001
Ford Bronco	1971–1997
Ford F100	1967–1997
Ford F150	1975–1997
Ford F250	1967–1997
U100	1971–1978
IHC Scout	1967–1980
IHC 100, 150, 200, 1100, 1110, 1200, 1210	1965–1970



Use Auburn Gear limited-slip additive for maximum performance. A 6 oz. bottle is included with your Auburn Gear differential. Part #504102.

\*Bearing parts numbers are for reference and NOT included unless specifically noted.

**NEW**

**Auburn Super 44**

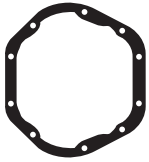

9 3/8" x 10 1/4"  
10 Holes

**ECTED Max  
Selectable Locker**

YEAR	PART #	RATIOS	SIDE GEAR SPLINE	BEARING CONE*	BEARING CUP*
2007–Present	545021	All Ratios	35 Teeth	JLM704649	JLM704610

**Applications:**  
Rubicon Rear,  
Jeep JK Non-Rubicon

**IMPORTANT NOTE:**  
Auburn Super 44 will not fit Jeep WK.  
Will not fit in JKs with Tracklock installed "OE."

\*\*\*Ring gear bolt holes on flange may or may not need to be drilled out for proper ring gear bolt fit and alignment.\*\*\*



Use Auburn Gear limited-slip additive for maximum performance. A 6 oz. bottle is included with your Auburn Gear differential. Part #504102.

Make	Year
Jeep JK, non-Rubicon	2007–Present
Rubicon, Rear Only, Non C-Clip	2007–Present

Check bearing size prior to purchase.

**MASTER INSTALLATION KITS**



- Ring Gear Bolts • Differential Bearings • Silicone Sealant • Pinion Bearings • Crush Collar • Brush • Pinion Shims • Differential Shims • Gear Marking Compound • Pinion Seal • Pinion Nut • Thread Adhesive •



**NEW**

# Auburn 44 RING & PINION

PART #	OEM REFERENCE # FRONT	OEM REFERENCE # REAR	TEETH	RATIO
342038	706017-4X	706017-4X	41-11	3.73:1
342039 T	706017-5X	706017-5X	45-11	4.09:1
342040	706017-8X	706017-8X	43-8	5.38:1
342045	n/a	n/a	39-8	4.88:1
342046 RS*	n/a	n/a	39-8	4.88:1



\*RS Kits: Reverse Cut, Short Pinion

**Specifications:**

Ring Gear Diameter 8.5"  
 10<sup>3</sup>/<sub>8</sub>" X 24 RH Threaded Bolts  
 Pinion Diameter 1.376" 26 Splines  
 Case Ratio: 3.73:1 & Numerically Lower  
 Case Ratio: 3.92:1 & Numerically Higher  
 8620 Material—Heat Treated

**Compatible Auburn Gear  
Differential Part Numbers**

545018	5420112
545019	542082
545021	542083
5420109	542084
5420110	542085
5420111	544914

**IMPORTANT NOTE:**

Part #342039 is a thick gear & works with carrier ratio 3.73:1 & numerically lower.

## MASTER INSTALLATION KIT

PART #	DESCRIPTION	MODEL YEARS
541087	Bearing Master Kit 1967 and Earlier	1967 & Earlier
541088	Bearing Master Kit 1968 and Later	1968 & Later
541089	Bearing Master Kit 1994 and later Dodge Ram 1500/2500	1994 & Later
541090	Bearing Master Kit -JK Non Rubicon - Rear	2007–2015
541091	Bearing Master Kit - JK Rubicon - Rear	2007–2015
541092	Bearing Master Kit - JK Rubicon - Front	2007–2015
541093	Bearing Master Kit - TJ Rubicon F&R 2003–2006	2003–2006

**\*Kit Contains Timken Bearings**



**Make**

**Year**

Bronco (F)	1967–1996
Bronco II (F)	1980–1982
Jeep Cherokee (F)	1978–1985
Jeep Cherokee (R)	1977–1980
Grand Cherokee WJ	1999 & Later
Chevrolet K10, 25 (F)	1960–1980
Chevrolet K30, 35 (F)	1967–1976
Chevrolet C10, 5 (R)	1960–1970
Chrysler W100, 150, 2000, 300, 350 (F)	1969 & Later
Chrysler 1/2 Ton (F)	1969–1993
Dodge 1/2 Ton Ram (F)	1994 & Later
Chrysler 3/4 Ton (F)	1969–1984
Dodge 3/4 Ton Ram (F)	1994 & Later
Cobra 63–67	1963–1967
Corvette 80–83	1980–1983
Corvette w/Manual Transmission	1985–1996
Firebird 84–85	1984–1985
Firebird 92–94	1992–1994
Ford F100, F50, 4x4	1967–1978
Ford 1/2 Ton (F)	1967–1996
Ford 1/2 Ton	1967–1979
Ford 3/4 Ton (F)	1967–1988
Ford 1 Ton (F)	1981–1985
GM 1/2 Ton (F)	1969–1980
GM 1/2 Ton (R)	1965–1972
GM 3/4 Ton (F)	1968–1980
IHC Scout (F)	1972–1980
IHC Scout (R)	1968–1980
IHC 100, 150, 200, 1100, 1110, 12000, 1210 (F & R)	1965–1975
Jeep C101 (R)	1969–1972
Jeep J10, J20 (F)	1978–1987
Jeep CJ Series (R)	1982–1986
Jeep TJ	2001
Jeepster (R)	1972–1973
Jeep Cherokee (F)	1978–1985
Jeep Cherokee (R)	1977–1980
Jeep Comanche XJ (R)	1986–1993
Jeep Wagoneer (F)	1974–1984
Jeep Wagoneer (R)	1972–1979
Jeep Grand Wagoneer (F)	1985–1991
Thunderbird	1995–1996
Viper (R)	1993
JK Rubicon (F)	2007–20015
JK Rubicon (R)	2007–2015
Non-Rubicon (R)	2007–2015

## Auburn 50

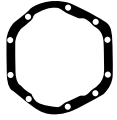

11.98" x 11.15"  
10 Holes

**Applications:** Ford F-250, F-350 and Excursion front axles.

**ECTED Max  
Selectable Locker**

YEAR	PART #	RATIOS	SIDE GEAR SPLINE	BEARING CONE*	BEARING CUP*
1981-2004	545020	All Ratios	30 Teeth	JLM104948	LM104911A
2000-2005	545020	All Ratios	30 Teeth	JLM104948	LM104911A



Use Auburn Gear limited-slip additive for maximum performance. A 6 oz. bottle is included with your Auburn Gear differential. Part #504102.

Make	Year
Excursion	2000-2005
F250/F350	1981-2004

### ECTED Max Features and Benefits

- Made in the USA.
- 2 Diffs in 1.
- Aircraft quality 9310 heat treated billet steel gearing.
- With the flip of a switch, go from Limited Slip to a Full Locking mode that delivers 100% torque to both wheels!
- Backed by a one year limited warranty, plus an exclusive four years of coverage through the D-REX Program!



**NEW**

**Auburn Pro 60**

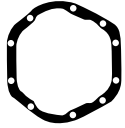

12.53" x 11.15"  
10 Holes

**ECTED Max  
Selectable Locker**  
(Open rear to locking only)

PART #	RATIOS	SIDE GEAR SPLINE	BEARING CONE*	BEARING CLIP*
545022	4.10:1 & Down	35 Teeth	387A	382S
545023	4.56:1 & Up	35 Teeth	387A	382S
545024	4.10:1 & Down	30 Teeth	387A	382S
545025	4.56:1 & Up	30 Teeth	387A	382S

**Applications:**

Gear Ratios: 4.10:1 & Down, 4:56:1 & Up  
Axle Spline Count: 30 & 35 Teeth  
Open to Lock

**IMPORTANT NOTES:**

All Auburn Pro 60 units with the "Reverse Cut-High Pinion" must use 4:10 & Down Case no matter what gear ratio is being used.

Does not work with C-Clip axles.

For Currie Housings, opposite ratio applies.



Use Auburn Gear limited-slip additive for maximum performance. A 6 oz. bottle is included with your Auburn Gear differential. Part #504102.

**Make**

**Year**

Studebaker E12 3/4t and E14 1t	1956-1964
Dodge Coronet & R/T	1966-1970
Dodge Charger & R/T	1966-1972
Dodge Super Bee	1968-1972
Challenger	1970-1971
Dodge RAM 2500/3500	1963-1993
Dodge RAM 2500 (V8 Only)	1994-2002
Dodge RAM SRT-10	2004-2006
Plymouth Belvedere	1966
Plymouth Satellite	1966
Plymouth Road Runner	1968-1972
Plymouth GTX	1967-1971
Plymouth 'Cuda	1970-1971
Ford 3/4 Ton Trucks	1955-1985
Ford 1 Ton Trucks	1955-1985
Ford E200/E250/E350	1980-1998
Ford UK A0406 Truck (Option)	1973-1982
Chevrolet and GMC 3/4 Ton Pickups	1964-1977
Chevrolet and GMC 1 Ton Pickups and Suburbans	1975-1987
Chevrolet and GMC 1 Ton Vans	1979-2012
Jeep J2600/J2700/J3600/J3700	1968-1970
Jeep J4000/4600/J4700	1971-1973

**Front Axle**

Chevrolet 1 Ton K30/V30	1977-1991
Chevrolet Commercial Utility Cargo Vehicle	1984-1988
Dodge 3/4 Ton D-600/W-250/2500	1975-2002
Dodge 1 Ton D-700/W-350/3500	1975-2002
Ford F250 (Optional)	1974-1979
Ford F250 (Optional)	1999-2011
Ford F350 (Optional)	1974-2011
F450/F550	2000-2004



**GET EVERYTHING YOU NEED IN ONE BOX  
WITH NO AIR LINES & NO PROBLEMS!  
OPEN-TO-LOCK ELECTRONIC OPERATION**

**100% LOCKING DIFFERENTIAL**

**LOCKS BOTH AXLES TO CENTER OF THE CARRIER**

# Auburn Pro 60 RING & PINION

PART #	OEM REFERENCE # FRONT	OEM REFERENCE # REAR	TEETH	RATIO
342041	706033-3X	706033-3X	41-10	4.10:1
342042	706033-4X	706033-4X	41-9	4.56:1
342051	706033-2X	706033-2X	41-11	3.73:1
342054*	n/a	n/a	39-08	4.88:1
342055	n/a	n/a	43-08	5.38:1



12.53" x 11.15"  
10 Holes

\*Rear only

**Specifications:**

- Ring Gear Diameter 9.75"
- 12 1/2" X 18 RH Threaded Bolts
- Pinion Diameter 1.626" 29 Splines
- Case Ratio: 4.10:1 & Numerically Lower
- Case Ratio: 4.56:1 & Numerically Higher
- 8620 Material—Heat Treated

**Compatible Auburn Gear  
Differential Part Numbers**

- 545022 545024
- 545023 545025

## MASTER INSTALLATION KIT

PART #	DESCRIPTION	MODEL YEARS
541094	Bearing Master Kit 1968–1991 Chevy, 1959–1998 Dodge, 1960–1998 Ford	1998 and Earlier
541095	Bearing Master Kit 1998 and Later	1998 and Later

**\*Kit Contains Timken Bearings**

Make	Year
Studebaker E12 3/4t	1956–1965, 1966–1970
and E14 1t	1956–1959
Dodge Coronet & R/T	1966–1970
Dodge Super Bee	1968–1972
Challenger	1970–1971
Dodge RAM 2500/3500	1963–1993
Dodge RAM 2500 (V8 Only)	1994–2002
Dodge RAM SRT-10	2004–2006
Plymouth Belvedere	1966
Plymouth Satellite	1966
Plymouth Road Runner	1968–1972
Plymouth GTX	1967–1971
Plymouth 'Cuda	1970–1971
Ford 3/4 Ton Trucks	1955–1985
Ford 1 Ton Trucks	1955–1976
Ford E200/E250/E350	1980–1998
Ford UK A0406 Truck (Option)	1973–1982
Chevrolet and GMC 3/4 Ton Pickups	1964–1977
Chevrolet and GMC 1 Ton Pickups and Suburbans	1975–1987
Chevrolet and GMC 1 Ton Vans	1979–2012
Jeep J2600/J2700/ J3600/J3700	1968–1970
Jeep J4000/4600/ J4700	1971–1973
Chevrolet 1 Ton K30/V30 (F)	1977–1991
Chevrolet Commercial Utility Cargo Vehicle (F)	1984–1988
Dodge 3/4 Ton D-600/W-250/2500 (F)	1975–2002
Dodge 1 Ton D-700/W-350/3500 (F)	1975–2002
Ford F250 (Optional) (F)	1974–1979
Ford F250 (Optional) (F)	1999–2011
Ford F350 (Optional) (F)	1974–2011
F450/F550	2000–2004



**NEW**

**Auburn Pro 70**

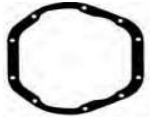

9 3/8" x 10 1/4"  
10 Holes

**ECTED Max  
Selectable Locker  
(Open To Lock)**

PART #	RATIOS	SIDE GEAR SPLINE	BEARING CONE*	BEARING CUP*
545026	4.56:1 & Up	35 Teeth	n/a	n/a
545027	4.10:1 & Down	35 Teeth	n/a	n/a
545035	4.10:1 & Down	40 Teeth	n/a	n/a

\*Auburn Pro 70 is compatible with Dana 70 model axle housings.

**Applications:** Gear Ratios: 4.10:1 & Down, 4:56:1 & Up  
Axle Spline Count: 35 & 40 Teeth  
Open to Lock

**IMPORTANT NOTE:**

For Currie Axle Housings, always use 4.10:1 & Down case  
Dana 70 Model uses 387A/382X carrier bearing & race.  
Dana 70HD model uses 469.453X carrier bearing & race

Make	Year
C30 1 Ton 2WD Rear	1974-1988
C3500 Rear	1989-1998
C35/3500 1 Ton 2WD Rear	1974-1998
D250 2WD 3/4 Ton Rear	1965-1984
D300 2WD 1 Ton Rear	1960-1980
D350 2WD 1 Ton Rear	1981-1993
E-350 Van 3500 1 Ton Rear	1975-2008
Ford E-450 Rear Express Van 3500 1 Ton Rear	2000-2010
Ford F-350 1 Ton 4WD Rear	1996-2001
Ford F-350 Super Duty 1 Ton Rear	1980-1997
G35/G3500 1 Ton Rear	1999-2002
K30/3500 1 Ton 4WD Rear	1973-1991
K35/3500 1 Ton 4WD Rear	1970-1989
P30 1 Ton Van	1977-2000
P3500 Rear	1997-2001
Ram Van 3500 1 Ton Rear	1997-1999
Savana 3500 1 Ton Rear	1971-1984
W200 3/4 Ton 4x4 Front	1996-2001
W250 3/4 Ton Rear	1967-1975
W300 1 Ton 4x4 Front	1981-1984
W300 1 Ton 4x4 Rear	1960-1978
W350 1 Ton 4x4 Rear	1968-1978
	1981-1984

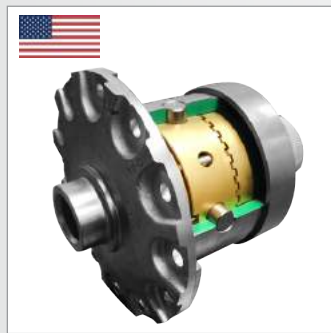

Use Auburn Gear limited-slip additive for maximum performance. A 6 oz. bottle is included with your Auburn Gear differential. Part #504102.



**GET EVERYTHING YOU NEED IN ONE BOX  
WITH NO AIR LINES & NO PROBLEMS!**

OPEN-TO-LOCK ELECTRONIC OPERATION

100% LOCKING DIFFERENTIAL

100% MADE IN THE USA

LOCKS BOTH AXLES TO CENTER OF THE CARRIER



**NEW**

# Auburn Pro 70 RING & PINION



9 3/8" x 10 1/4"  
12 Holes, Irregular

PART #	OEM REFERENCE # FRONT	OEM REFERENCE # REAR	TEETH	RATIO
342044	n/a	n/a	41-10	4.10:1
342052* (Thick Gear)	n/a	n/a	41-09	4.56:1

\*Fits 4.10:1 & Numerically Lower Carrier Case Ratio Only

**Specifications:**

Ring Gear Diameter 10.50"  
12 1/2" X 18 RH Threaded Bolts  
Pinion Diameter 1.750" 29 Splines  
Case Ratio: 4.10:1 & Numerically Lower  
8620 Material—Heat Treated

**Compatible Auburn Gear  
Differential Part Numbers**

545026 545027  
545035

**Vehicle Application Model Year**

C30 1 Ton 2WD Rear	1974-1988
C3500 Rear	1989-1998
C35/3500 1 Ton 2WD Rear	1974-1998
D250 2WD 3/4 Ton Rear	1965-1984
D300 2WD 1 Ton Rear	1960-1980
D350 2WD 1 Ton Rear	1981-1993
E-350 Van 3500 1 Ton Rear	1975-2008

**Make Year**

Ford E-450 Rear	2000-2010
Express Van 3500 1 Ton Rear	1996-2001
Ford F-350 1 Ton	1980-1997
Ford F-350 Super Duty 1 Ton Rear	1999-2002
G35/G3500 1 Ton Rear	1973-1991
K30/3500 1 Ton 4WD Rear	1970-1989
K35/3500 1 Ton 4WD Rear	1977-2000
P30 1 Ton Van	1997-2001
P3500 Rear	1997-1999
Ram Van 3500 1 Ton Rear	1971-1984
Savana 3500 1 Ton Rear	1996-2001
W200 3/4 Ton 4x4 Front	1967-1975
W250 3/4 Ton Rear	1981-1984
W300 1 Ton 4x4 Front	1960-1978
W300 1 Ton 4x4 Rear	1968-1978
W350 1 Ton 4x4 Rear	1981-1984

**Challenge Accepted.**

**No Air Lines, No Problems!**

Get the performance you need with the NEW Auburn Pro 60, 70, & 80 Open-To-Lock fully electronic locker. Auburn Pro electronic lockers are 100% USA made, designed to lock both axles to the center of the carrier, and transfer the torque directly from the differential, NOT through the gears. Backed by our industry leading 1 year warranty.

# NEW

# AUBURN

## Auburn Pro 80



13 7/16"  
10 Holes Irregular

**ECTED Max  
Selectable Locker**

PART #	RATIOS	SIDE GEAR SPLINE	BEARING CONE*	BEARING CUP*
545032	4.10:1 & Up	35 Teeth	n/a	n/a
545033	3.73:1 & Down	35 Teeth	n/a	n/a
545036	4.10:1 & Up	40 Teeth	n/a	n/a
545037	3.73:1 & Down	40 Teeth	n/a	n/a

**IMPORTANT NOTE:**

Dana 80 model uses 469/453X carrier bearing & race

\*Auburn Pro 80 is compatible with Dana 80 model axle housings.

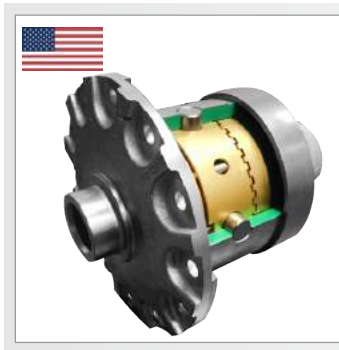

Use Auburn Gear limited-slip additive for maximum performance. A 6 oz. bottle is included with your Auburn Gear differential. Part #504102.

Make	Year
Dodge 3500	1994–2002
Dodge 2500 (equipped w/ manual transmissions & Diesel or V10 engines)	1994–2002
Ford F350 (Select chassis cabs & pick ups)	1988–1998
Ford F350	1999–2016
Ford F450	1988–2004
Ford F450 (13,050 GVW)	2011–2014
GM (C3500 HD)	1991–2002

## Auburn Pro 80 RING & PINION



13 7/16"  
10 Holes Irregular

PART #	OEM REFERENCE # FRONT	OEM REFERENCE # REAR	TEETH	RATIO
342047	n/a	73200-5X	41-10	4.10:1

**Specifications:**

Ring Gear Diameter 11.25"  
12 1/2" X 20 RH Threaded Bolts  
Pinion Diameter 2" 37 Splines  
Case Ratio: 3.73:1 & Numerically Lower  
Case Ratio: 4.10:1 & Numerically Higher  
8620 Material—Heat Treated

**Compatible Auburn Gear  
Differential Part Numbers**

545032	545033
545036	545037

Make	Year
Chevrolet C3500	1992–2001
Chevrolet Express Van 3500 1 Ton	1996–2007
Chevrolet G30 1 Ton	1992–1995
Chevrolet K30/K3500 1 Ton (4WD)	1990–1998
Chevrolet P30 1 Ton Van	1997–2005
Chevrolet P3500	1997–1999
Dodge B3500 Dodge Van 1 Ton	1995–1998
Dodge Ram 2500 3/4 Ton	1994–2002
Dodge Ram 3500 1 Ton	1994–2002
Dodge Ram Van 2500 3/4 ton	1999–2003
Ford E–350 1 Ton	1988–2010
Ford E–450	2000–2005
Ford F–350 1 Ton	1988–1998
Ford F–350 Super Duty 1 Ton	1998–2015
Ford F–450 Super Duty	1990–2005
GMC C35/C3500 1 Ton (2WD)	1992–2002
GMC K35/K3500 1 Ton (4WD)	1992–2000

## MASTER INSTALLATION KIT

PART #	DESCRIPTION	MODEL YEARS
541096	Bearing Master Kit 1988–1997 Ford, 1994–2001 Dodge	1988–1997 Ford, 1994–2001 Dodge
541097	Bearing Master Kit 1998 & Later Ford	1998 & Later Ford

\*Kit Contains Timken Bearings

# Ford 7<sup>1</sup>/<sub>2</sub>" 10 Bolt

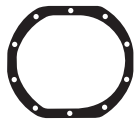

10 3/4" x 9 9/16"  
10 Holes, Oval

**High Performance Differential**

**Pro Series Differential**

YEAR	PART #	RATIOS	SIDE GEAR SPLINE	BEARING CONE*	BEARING CUP*
1978–Present	542023	All Ratios	28 Teeth	LM501349	LM501314
1978–Present	542048	All Ratios	28 Teeth	LM501349	LM501314

**Applications:** All Ford products with 7<sup>1</sup>/<sub>2</sub>" ring gear. Accepts tone ring for ABS applications.

**SPECIAL NOTE:**

Ford 7.5" applications require special "C" washers, which are supplied with the differential (542035). Includes milled pinion shaft to accept 3.73-4.56 ratios.



Use Auburn Gear limited-slip additive for maximum performance. A 6 oz. bottle is included with your Auburn Gear differential. Part #504102.

Make	Year
Aerostar	1986–1996
Bobcat	1975–1980
Bronco II	1983–1990
Capri except 86 w/V8	1979–1986
Cougar	1980–1987
Fairmont	1978–1983
Ford Full Size	1979–1986
Granada	1979–1984
Mercury Full Size	1979–1985
Mustang 4 & 6 Cylinder	1979–Present
Ranger without 4.0L	1983–1999
Thunderbird	1980–1994
Zephyr	1979–1983

**High Performance Series Feature**

Auburn Gear's flagship Limited Slip Differential gives you smooth torque sensing operation with the correct bias ratios to outperform the competition.

# Ford 8" 10 Bolt

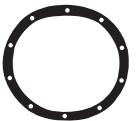

11" 10 Holes, Oval

**Pro Series Differential**

YEAR	PART #	RATIOS	SIDE GEAR SPLINE	BEARING CONE*	BEARING CUP*
1960–1979	542059	3.0 & Up	28 Teeth	LM102949	LM102910
1960–1979	5420115	3.0 & Up	31 Teeth	LM102949	LM102910

**Applications:** All Ford products with 7<sup>3</sup>/<sub>4</sub>" & 8" ring gear. Use Ford M-4216-B ring gear bolts for an open-type differential. Limited-slip type bolts are too long.

**Pro Series Feature**

High Torque bias Cone Clutch design provides Maximized Torque Transfer, making it the Ultimate Limited Slip Differential for true performance.



Use Auburn Gear limited-slip additive for maximum performance. A 6 oz. bottle is included with your Auburn Gear differential. Part #504102.

Make	Year
Comet	1964–1972
Cougar	1967–1972
Fairlane	1960–1972
Falcon	1962–1970
Mustang	1965–1979





# Ford 8.8" 10 Bolt

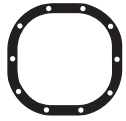

10 9/16" x 10 13/16"  
10 Holes, Oval

### ECTED Max Selectable Locker

### High Performance Differential

### Pro Series Differential

	YEAR	PART #	RATIOS	SIDE GEAR SPLINE	BEARING CONE*	BEARING CUP*
ECTED Max Selectable Locker	1978-2014	545001	All Ratios	28 Teeth	LM603049	LM603012
	1983-2014	545002	All Ratios	31 Teeth	LM603049	LM603012
	1983-2014	545005 <sup>^</sup>	All Ratios	31 Teeth	LM603049	LM603012
High Performance Differential	1979-2014	542079	All Ratios	28 Teeth	LM603049	LM603012
	1983-2014	542025	All Ratios	31 Teeth	LM603049	LM603012
Pro Series Differential	1979-2014	542080	All Ratios	28 Teeth	LM603049	LM603012
	1983-2014	542054 <sup>••</sup>	All Ratios	31 Teeth	LM603049	LM603012
	1983-2014	5420116 <sup>••</sup>	All Ratios	33 Teeth	LM603049	LM603012

<sup>^</sup> For IRS applications only  
<sup>••</sup> 9310 Gear Material

**Applications for High Performance and Pro Series:** All Ford products with 8.8" ring gear including IRS (Independent Rear Suspension) applications. Accepts tone ring for ABS applications.

**Applications for ECTED Max: Part #545001:** All Ford products with 8.8" ring gear including IRS & IFS applications. Accepts tone ring for ABS applications.

**Applications for ECTED Max: Part #545002 & Part #545005:** All Ford products with 8.8" ring gear. Accepts tone ring for ABS applications.



Use Auburn Gear limited-slip additive for maximum performance. A 6 oz. bottle is included with your Auburn Gear differential. Part #504102.

Make	Year
Aerostar with 4.0L	1990-1996
Bronco	1981-1994
Capri V8	1986-1997
Cougar	1988-2001
E150 - E250	1983-1999
Expedition Front	1997-2014
Explorer	1990-2014
F100	1981-1997
F150-250	1981-2014
F150 Front	1997-2014
Mercury Full Size	1982-2014
Mustang V8	1985-2014
Ranger with 4.0L	1990-2014
Raptor	2010-2014
Thunderbird	1987-1994



## ECTED Max Features and Benefits

- Made in the USA.
- 2 Diffs in 1.
- Aircraft quality 9310 heat treated billet steel gearing.
- With the flip of a switch, go from Limited Slip to a Full Locking mode that delivers 100% torque to both wheels!
- Backed by a one year limited warranty, plus an exclusive four years of coverage through the D-REX Program!

# Ford 8.8" PERFORMANCE RING & PINION

PART #	OEM REFERENCE # FRONT	OEM REFERENCE # REAR	TEETH	RATIO
342037	E3TZ4209J	M4 209G355	39-11	3.55:1
342059	n/a	n/a	41-11	3.73:1
342060	n/a	n/a	41-10	4.10:1



10 9/16" x 10 13/16"  
10 Holes, Oval

**Specifications:**

- Ring Gear Diameter 8.80"
- 10 7/16" X 20 LH Threaded Bolts
- Pinion Diameter 1.626" 30 Splines
- No Case Breaks
- 8620 Material - Heat Treated

**Compatible Auburn Gear Differential Part Numbers**

545001	542039
545002	542080
545005	542054
542079	5420116
542025	544921

**Make**

**Year**

Areostar with 4.0L	1990-1997
Bronco	1983-1996
Capri V8	1986
Cougar	1980-1997
E150-E250	1983-1999
Expedition	1997-2014
Explorer	1991-2014
F100	1981-1990
F150-F250	1981-2002
F150 Front	1999-2002
Ford 1/2 TON Rear	1997-2014
Ford 3/4 TON Rear	1983-1989
Full Size Car	1980-2014
Mustang V8	1986-2014
Ranger with 4.0L	1983-2014
Thunderbird	1983-1997

## MASTER INSTALLATION KIT

PART #	DESCRIPTION	MODEL YEARS
5410104	Bearing Master Kit 1981-1997	1981-1997
5410105	Bearing Master Kit 2010-Present	2010-2014
5410106	Bearing Master Kit 1997-2014 IRS Application	1997-2014
5410107	Bearing Master Kit 1997-2014 IFS Reverse Front End (F-150 & Expedition)	1997-2014

\*\*Starting 1997, production Model F150 comes with Factory Ford 8.8 IFS Style Reverse Cut Gears\*\*

**\*Kit Contains Timken Bearings**



## MASTER INSTALLATION KITS

- Ring Gear Bolts • Differential Bearings • Silicone Sealant • Pinion Bearings • Crush Collar • Brush • Pinion Shims • Differential Shims • Gear Marking Compound • Pinion Seal • Pinion Nut • Thread Adhesive •

## Ford 9" 10 Bolt



11 3/4" 10 Holes, Oval

**Pro Series Differential**

YEAR	PART #	RATIOS	SIDE GEAR SPLINE	BEARING CONE*	BEARING CUP*
1957-1987	542043	All Ratios	28 Teeth	LM102949	LM102910
1957-1987	542036	All Ratios	31 Teeth	LM603049	LM603011

**Applications:** All Ford products with 8 3/4" & 9" ring gear. Use Ford M-4216-A210 ring gear bolts for an open-type differential. Limited-slip type bolts are too long.



Use Auburn Gear limited-slip additive for maximum performance. A 6 oz. bottle is included with your Auburn Gear differential. Part #504102.

Make	Year
All Light Trucks	1957-1987
Bronco	1967-1986
Comet	1965-1967
Cougar	1965-1979
E100/150	1986-1987
E200	1968-1974
Fairlane	1962-1973
Ford	1957-1980
Granada	1975-1980
Ltd II	1971-1979
Mercury	1957-1973
Mustang	1965-1973
Monarch	1975-1980
Montego	1965-1976
Thunderbird	1957-1973
Torino	1971-1979
Versailles	1977-1980

### Pro Series Feature

High Torque bias Cone Clutch design provides Maximized Torque Transfer, making it the Ultimate Limited Slip Differential for true performance.

## Ford 9 3/4" 12 Bolt

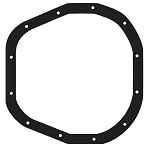

12.46" x 11.45"  
12 Holes, Irregular

**High Performance Differential**

YEAR	PART #	RATIOS	SIDE GEAR SPLINE	BEARING CONE*	BEARING CUP*
1997-Present	542090	All Ratios	34 Teeth	NP343847	NP372019

**Applications:** All Ford products with 9 3/4" ring gear. Accepts tone ring for ABS applications. Fits IRS applications.



Use Auburn Gear limited-slip additive for maximum performance. A 6 oz. bottle is included with your Auburn Gear differential. Part #504102.

Make	Year
E150	1997-2014
E250	1997-2014
E350	1997-2014
Expedition	1997-2014
F150	1997-2014
Lightning	1999-2014
Navigator	1997-2014

### High Performance Series Feature

Auburn Gear's flagship Limited Slip Differential gives you smooth torque-sensing operation with the correct bias ratios to outperform the competition.



# Ford 9"

## PERFORMANCE RING & PINION

PART #	OEM REFERENCE # FRONT	OEM REFERENCE # REAR	TEETH	RATIO
342036	n/a	n/a	37-10	3.70:1



11 3/4" 10 Holes, Oval

**Specifications:**

Ring Gear Diameter 9"  
 10<sup>7</sup>/<sub>16</sub>" X 20 RH Threaded Bolts  
 Pinion Diameter 1.313" 28 Splines  
 No Case Breaks  
 8620 Material—Heat Treated

**Compatible Auburn Gear  
Differential Part Numbers**

542043 544909  
 542036

Make	Year
Australian Falcon GT, WX, XY, XA, XB	1969–1974
Australian Fairlane ZC, ZD	1969–1974
Bronco (28 Spline)	1967–1970
Bronco (31 Spline)	1970–1986
Comet/Cyclone	1965–1967
Cougar (28 Spline)	1967–1970
Cougar (31 Spline)	1970–1979
E100/150	1986–1987
E200	1968–1974
F100/F150	1964–1986
Fairlane (28 Spline)	1957–70
Fairlane (31 Spline)	1970–1971
Ford Full Size 28 Spline	1957–1970
Ford Full Size 31 Spline	1970–1979
Ford 1/2 TON (28 Spline)	1957–1970
Ford 1/2 TON (31 Spline)	1970–1986
Ford 3/4 Ton (28 Spline)	1969–1970
Ford 3/4 Ton (31 Spline)	1970–1974
Granada	1975–1980
LTD II	1971–1979
Mercury (28 Spline)	1957–1970
Mercury (31 Spline)	1970–1979
Montego (28 Spline)	1970–1976
Montego (31 Spline)	1970–1976
Monarch	1975–1980
Mustang (28 Spline)	1965–1970
Mustang (31 Spline)	1970–1973
Thunderbird (28 Spline)	1957–1970
Thunderbird (31 Spline)	1970–1979
Versailles	1977–1980

### MASTER INSTALLATION KIT

PART #	DESCRIPTION	MODEL YEARS
5410108	Bearing Master Kit 28 Spline 2.891 with LM102910 & LM102949	1970–1986
5410109	Bearing Master Kit 28 Spline 2.891 Late with LM501310 & LM501349	1957–1970
5410110	Bearing Master Kit 2.891 with LM102910 & LM102949 Rear Pinion Bushings	1970–1986
5410111	Bearing Master Kit 3.062 with LM603011 & LM603049 STD Rear Pinion Bearings	1957–1986
5410112	Bearing Master Kit 3.062 with LM603011 & LM603049 LG Rear Pinion Bearings	1957–1986
5410113	Bearing Master Kit 3.25 Bore with LM104910 & LM104949 STD Rear Pinion Bearings	1957–1986
5410114	Bearing Master Kit 3.25 Bore with LM104910 & LM104949 LG Rear Pinion Bearings	1957–1986

\*Kit Contains Timken Bearings

# Ford 9 3/4"

## PERFORMANCE RING & PINION

PART #	OEM REFERENCE # FRONT	OEM REFERENCE # REAR	TEETH	RATIO
342053	n/a	n/a	41-10	4.10:1



12.46" x 11.45"  
 12 Holes, Irregular

**Specifications:**

Ring Gear Diameter 9.75"  
 12-12MM X 26 RH Threaded Bolts  
 Pinion Diameter 1.970" 31 Splines  
 No Case Breaks  
 8620 Material—Heat Treated

**Compatible Auburn Gear  
Differential Part Numbers**

542090

Make	Year
Expedition	1997–2014
E150	1997–2014
E250	1997–2014
E350	1997–2014
F150	1997–2014
Ford 1/2 Ton	1997–2014
Ford 3/4 Ton	1997–2014
Navigator	1997–2014

### MASTER INSTALLATION KIT

PART #	DESCRIPTION	MODEL YEARS
5410119	Bearing Master Kit 2011–Present	2011–Present

\*Kit Contains Timken Bearings

# Ford 10 1/4" & 10 1/2" 12 Bolt



12 1/8" x 13 5/16"  
12 Holes, Irregular

**High Performance Differential**

YEAR	PART #	RATIOS	SIDE GEAR SPLINE	BEARING CONE*	BEARING CLIP*
1983–Present	542089	All Ratios	35 Teeth	469	453X

**Applications:** All Ford products with 10 1/4" & 10 1/2" ring gear. Accepts tone ring for ABS applications.

**SPECIAL NOTE:**

Works with both C-clips (semi-float) and full float axles.



Use Auburn Gear limited-slip additive for maximum performance. A 6 oz. bottle is included with your Auburn Gear differential. Part #504102.

Make	Year
F250	1983–Present
F350	1983–Present
F450	1983–Present

## High Performance Series Features and Benefits

- Made in the USA.
- Auburn Gear's flagship Limited Slip Differential gives you smooth torque sensing operation with the correct bias ratios to outperform the competition.
- Provides maximum amount of torque transfer without compromising the performance requirements of a vehicle in situations where torque transfer is required.
- Backed by a one year limited warranty, plus an exclusive four years of coverage through the D-REX Program!



# GM 7 1/2" & 7 5/8" 10 Bolt

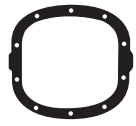

8 5/16" x 10 9/16"  
10 Holes, Oval

	YEAR	PART #	RATIOS	SIDE GEAR SPLINE	BEARING CONE*	BEARING CUP*
<b>High Performance Differential</b>	1976-1988	542057	3.23:1 & Up	26 Teeth	LM501349	LM501314
	1976-1988	542058	3.08:1 & Down	26 Teeth	LM501349	LM501314
<b>Pro Series Differential</b>	1976-1988	542044	3.23:1 & Up	26 Teeth	LM501349	LM501314
	1976-1988	542045	3.08:1 & Down	26 Teeth	LM501349	LM501314

**Applications:** All GM products with 7 1/2" & 7 5/8" ring gear.



Use Auburn Gear limited-slip additive for maximum performance. A 6 oz. bottle is included with your Auburn Gear differential. Part #504102.

Make	Year
Astro/Safari	1985-1988
Buick/Olds/Pontiac	
Camaro/Firebird	1982-1988
Century/Phoenix/Ventura	1978-1981
Chevrolet Full Size	1977-1988
Chevrolet Manza 26T	1975-1980
Cutlass/Grand Prix	1978-1987
El Camino	1977-1988
Full Size	1977-1988
Monte Carlo/Regal	1978-1987
Omega	1975-1979
S10/S15	1982-1988
Skylark	1976-1979



8 5/16" x 10 9/16"  
10 Holes, Oval

	YEAR	PART #	RATIOS	SIDE GEAR SPLINE	BEARING CONE*	BEARING CUP*
<b>High Performance Differential</b>	1988-Present	542040	3.23:1 & Up	28 Teeth	LM501349	LM501314
	1988-Present	542041	3.08:1 & Down	28 Teeth	LM501349	LM501314
<b>Pro Series Differential</b>	1988-Present	542046	3.23:1 & Up	28 Teeth	LM501349	LM501314
	1988-Present	542047	3.08:1 & Down	28 Teeth	LM501349	LM501314

**Applications:** All GM products with 7 1/2" & 7 5/8" ring gear. Accepts tone ring for ABS applications.

**SPECIAL NOTE:** GM 7 5/8" applications use (2) different tone wheels depending on the differential case series. 3.08:1 & down gear ratios—Series 2 Case 3.23:1 & up gear ratios—Series 3 Case.



Use Auburn Gear limited-slip additive for maximum performance. A 6 oz. bottle is included with your Auburn Gear differential. Part #504102.

Make	Year
Astro/Safari	1988-2005
Buick/Olds/Pontiac	
Camaro/Firebird	1988-2002
Chevrolet Full Size	1988-1996
Full Size	1988-1990
Isuzu Rodeo	1989-1993
Olds Bravada	1991-1002
S10/S15	1988-2005

## High Performance Series Feature

Auburn Gear's flagship Limited Slip Differential gives you smooth torque sensing operation with the correct bias ratios to outperform the competition.

## Pro Series Feature

High Torque bias Cone Clutch design provides Maximized Torque Transfer, making it the Ultimate Limited Slip Differential for true performance.



**NEW**

# GM 7 1/2" & 7 5/8" PERFORMANCE RING & PINION

PART #	DEM REFERENCE # FRONT	DEM REFERENCE # REAR	TEETH	RATIO
342035	n/a	26026782	41-12	3.42:1
342034	n/a	26036813	41-11	3.73:1



8 5/16" x 10 9/16"  
10 Holes, Oval

**Specifications:**

Ring Gear Diameter 7.50"  
10 3/8" X 18 LH Threaded Bolts  
Pinion Diameter 1.438" 27 Splines  
Case Ratio: 3.08:1 & Numerically Lower  
Case Ratio: 3.23:1 & Numerically Higher  
8620 Material - Heat Treated

**Compatible Auburn Gear Differential Part Numbers**

542057	542041
542058	542046
542044	542047
542045	544932
542040	544933

Make	Year
Astro	1985-2005
Buick Full Size	1975-1986
Buick Mid Size	1973-1987
Camaro	1982-2002
Century/Phoenix	
Ventura	1978-1981
Chevy Full Size	1975-1996
Chevy Mid Size	1976-1980
Cutlass	1978-1988
Firebird	1982 & Later
Grand Prix	1978-1987
Isuzu Rodeo	1989-1993
Monte Carlo	1981-1988
Olds Full Size	1977-1985
Olds Bravada	1991-2002
Omega	1975-1979
Pontiac Full Size	1977-1986
Regal	1978-1983
Skylark	1976-1979
S10, S15	1982-2005

## MASTER INSTALLATION KIT

PART #	DESCRIPTION	MODEL YEARS
541098	Bearing Master Kit 1977-1981	1977-1981
541099	Bearing Master Kit 1982-1998	1982-1998
5410100	Bearing Master Kit 1999 & Later	1999 & Later

\*Kit Contains Timken Bearings

## Chevy 8.2" 10 Bolt

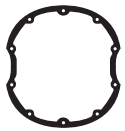

11 1/2" 10 Holes

**High Performance Differential**

**Pro Series Differential**

YEAR	PART #	RATIOS	SIDE GEAR SPLINE	BEARING CONE*	BEARING CLIP*
1964-1972	5420108	3.08:1 & Up	28 Teeth	LM501349	LM501314
1964-1972	542061	3.08:1 & Up	28 Teeth	LM501349	LM501314

**Applications:** Chevrolet with 8.2" ring gear. "C" lock axle. 25 tooth pinion spline.

**SPECIAL NOTE:** Ring Gear bolts are included.



Use Auburn Gear limited-slip additive for maximum performance. A 6 oz. bottle is included with your Auburn Gear differential. Part #504102.

Make	Year
Camaro	1967-1970
Chevelle	1964-1972
Chevrolet	1965-1970
Chevy II	1964-1970
Nova	1970-1972

# GM 8.2" PERFORMANCE RING & PINION

PART #	OEM REFERENCE # FRONT	OEM REFERENCE # REAR	TEETH	RATIO
342056	n/a		41-11	3.73:1



11" Oval or 10 5/8" Irregular, 10 Holes

**Specifications:**

Ring Gear Diameter 8.20"  
 10 3/8" X 24 RH Threaded Bolts  
 Pinion Diameter 1.438" 25 Splines  
 Case Ratio: 3.00:1 & Numerically Lower  
 Case Ratio: 3.08:1 & Numerically Higher  
 8620 Material—Heat Treated

**Compatible Auburn Gear Differential Part Numbers**  
 5420108  
 542061

Make	Year
Camaro	1967–1970
Caprice	1965–1971
Chevelle	1964–1972
Chevrolet	1965–1970
Chevy II	1964–1972
El Camino	1964–1971
Impala	1964–1971
Monte Carlo	1970–1972
Nova	1964–1972

## MASTER INSTALLATION KIT

PART #	DESCRIPTION	MODEL YEARS
5410118	Bearing Master Kit 1964-1972	1964-1972

\*Kit Contains Timken Bearings

## Buick - Olds - Pontiac 8.2" 10 Bolt

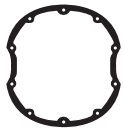

11 1/2" 10 Holes

**High Performance Differential**  
**Pro Series Differential**

	YEAR	PART #	RATIOS	SIDE GEAR SPLINE	BEARING CONE*	BEARING CUP*
High Performance Differential	1964–1971	5420113	3.36:1 & Up	28 Teeth	LM501349	LM501314
	1964–1971	5420114	2.93:1 to 3.23:1	28 Teeth	LM501349	LM501314
Pro Series Differential	1964–1971	542060	3.36:1 & Up	28 Teeth	LM501349	LM501314
	1964–1971	542099	2.93:1 to 3.23:1	28 Teeth	LM501349	LM501314

**Applications:** Buick, Olds, Pontiac with 8.2" ring gear. Non "C" lock axle—27 tooth pinion spline. Will not fit "O" axle with 12-bolt cover and 10-bolt ring gear.

**SPECIAL NOTE:** Differential bearings provided with 542099 and 5420114

**SPECIAL NOTE:** Stock bearings are usually LM603049/LM603012 for the ring gear side and LM501349/LM501314 for the opposite side. Some use LM501349/LM501314 for both sides. The Auburn Gear limited-slip differential will fit in either application. We supply 2 sets of LM102949/LM102911. Axles that have the LM603049/LM603012 bearing will still use that bearing, but the opposite side will require the LM102949/LM102911 that is included with the differential.



Use Auburn Gear limited-slip additive for maximum performance. A 6 oz. bottle is included with your Auburn Gear differential. Part #504102.

Make	Year
Firebird	1967–1971
Olds F85	1964–1970
Tempest/GTO	1964–1971

### High Performance Series Feature

Provides maximum amount of torque transfer without compromising the performance requirements of a vehicle in situations where torque transfer is required.

### Pro Series Feature

High Torque bias Cone Clutch design provides Maximized Torque Transfer, making it the Ultimate Limited Slip Differential for true performance.

# GM 8.2"/8.4" 10 Bolt 1955-1964 Chevy

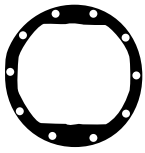

11.5" 10 Holes, Irregular

	YEAR	PART #	RATIOS	SIDE GEAR SPLINE	BEARING CONE*	BEARING CUP*
<b>Pro Series Differential</b>	1955-1964	5420100	3.70:1 & Down <sup>^</sup>	17 Teeth	LM603049	LM603014

<sup>^</sup>3 Series Case

**NOTE:** Comes with longer Ring Gear Bolts and Ring Gear Spacer.

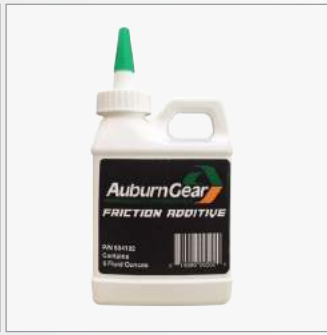

Use Auburn Gear limited-slip additive for maximum performance. A 6 oz. bottle is included with your Auburn Gear differential. Part #504102.

Make	Year
Bel Air	1955-1964
Biscayne	1955-1964
Corvette	1955-1962
Chevy II	1955-1964
El Camino	1955-1964
Impala	1955-1964
Series 150/210	1955-1964

## Housing modification for non-posi housings

Axle housings not originally equipped with a posi-traction will require modification to provide necessary clearance for the limited-slip differential. No modifications are required if using an original posi housing.

Modify the non-posi housing by removing a portion of the rib as shown below.

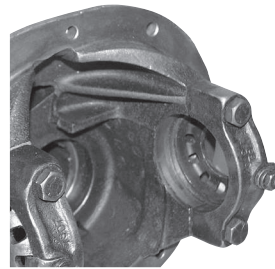

Unmodified non-posi Housing

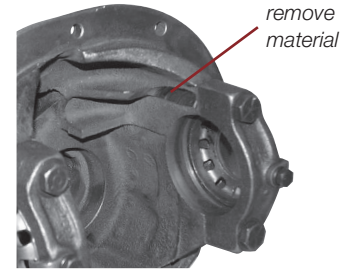

Modified non-posi Housing

## Pro Series Feature

High Torque bias Cone Clutch design provides Maximized Torque Transfer, making it the Ultimate Limited Slip Differential for true performance.

# Corvette 10 Bolt 1963-1979

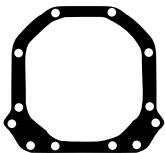

10 1/8" x 9 29/32" 12 Holes, Irregular

	YEAR	PART #	RATIOS	SIDE GEAR SPLINE	BEARING CONE*	BEARING CUP*
<b>Pro Series Differential</b>	1963-1979	542062	2.41:1 to 3.70:1	17 Teeth	LM603049	LM603012
	1963-1979	542063	4.10:1 & Up	17 Teeth	LM603049	LM603012

**Applications:**  
Corvette

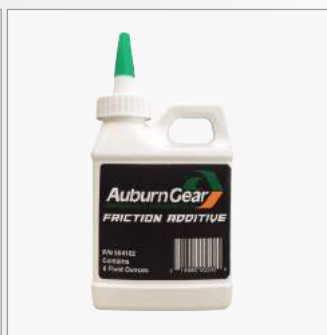

Use Auburn Gear limited-slip additive for maximum performance. A 6 oz. bottle is included with your Auburn Gear differential. Part #504102.

Make	Year
Corvette	1963-1979





# Gen 5 Camaro 218mm 10 Bolt

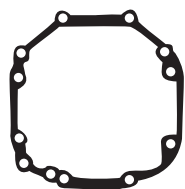

10" x 9 3/4"

**Pro Series Differential**

YEAR	PART #	RATIOS	SIDE GEAR SPLINE	BEARING CONE*	BEARING CUP*
2010–Present	5420138	3.27:1, 3.45:1, 3.73:1, & 3.91:1	32 Teeth	TR100802A	STA5078

**Applications:**

Gen 5 Camaro V-8 218mm 10 Bolt



Use Auburn Gear limited-slip additive for maximum performance. A 6 oz. bottle is included with your Auburn Gear differential. Part #504102.

Make	Year
Camaro SS	2010–Present

**Pro Series Features and Benefits**

- Made in the USA.
- Turn up your torque with our Pro Series differential for the very best in controlled power transfer.
- High Torque bias Cone Clutch design provides Maximized Torque Transfer, making it the Ultimate Limited Slip Differential for true performance.
- Backed by a one year limited warranty, plus an exclusive four years of coverage through the D-REX Program!

**NEW FROM AUBURN GEAR**

**Performance Enhancing Camaro Gen 5 v-8 Differential**

*GO LIKE HELL in total confidence with Auburn Gear's New Gen 5 Camaro Differential. Its robust, four-pinion, high-strength, billet steel design is engineered to take the horsepower and torque of even the most muscular Camaro completely in stride and dominate the competition.*

Gen 5 Camaro V-8  
218mm 10 Bolt  
Part#: 5420138  
Model Years: 2010-Present  
Axle Spline Count: 32 Teeth  
Gear Ratios: 3.27:1, 3.45:1, 3.75:1

**GO LIKE HELL**

# GM 8.5" & 8.6" 10 Bolt

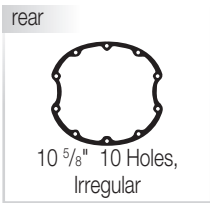
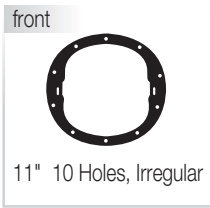

	YEAR	PART #	RATIOS	SIDE GEAR SPLINE	BEARING CONE*	BEARING CUP*
<b>ECTED Max Selectable Locker</b>	1971–1988	545003 <sup>•</sup>	2.73:1 & Up	28 Teeth	LM102949	LM102911
	1989–1998	545004	2.73:1 & Up	30 Teeth	LM102949	LM102911
	1999–Present	545004	2.73:1 & Up	30 Teeth	LM603049	LM603012
<b>High Performance Differential</b>	1971–1988	542018	2.73:1 & Up	28 Teeth	LM501349	LM501314
	1989–1998	542022	2.73:1 & Up	30 Teeth	LM501349	LM501314
	1999–Present	542097	2.73:1 & Up	30 Teeth	LM603049	LM603012
<b>Pro Series Differential</b>	1971–1988	542050 <sup>^</sup>	2.73:1 & Up	28 Teeth	LM102949	LM102911
	1989–1998	542052 <sup>^</sup>	2.73:1 & Up	30 Teeth	LM102949	LM102911
	1999–Present	542052 <sup>^</sup>	2.73:1 & Up	30 Teeth	LM603049	LM603012

•541070 bearing kit contains: Two (2) LM102949 and two (2) LM102911

<sup>^</sup>Large bearing hub—Bearings provided with 542050, Pro Series Unit

\*\*Bearings provided in 542052, however if vehicle is '99 model year or newer, bearings will not be used. Use bearings specified above.

**Applications:** All GM products with 8.5" & 8.6" ring gear.

**SPECIAL NOTE:** 542097 can be substituted for 542022 with a bearing change. Use LM102949, LM102911. The reverse case will not fit. 542022 cannot be substituted for the 542097.

541070 bearing kit contains: (2) LM102949 (2) LM102911.



Use Auburn Gear limited-slip additive for maximum performance. A 6 oz. bottle is included with your Auburn Gear differential. Part #504102.

Make	Year
Apollo/Regal/Century	1973–1977
Biscayne/Roadmaster	1971–1974
Blazer Front/Rear	1977–1991
Buick Full Size	1977–Present
Camaro	1977–1981
Chevelle	1970–1976
Chevy Full Size	1977–1996
Chevy II/Nova	1970–1979
Cutlass/Grand Prix/LeMans/GTO/Ventura/Phoenix	1971–1977
El Camino/Monte Carlo	1971–1977
Electra	1973–1978
G20/G25	1979–Present
Grand National	1984–1987
Grand Sport	1973–1984
GTO/Firebird/Trans Am	1970–1981
Hurst Olds	1985–1988
Impala/Roadmaster	1991–1996
K10/K15/K20/K26 Front	1977–1987
K10/K15 Rear	1982–Present
LeSabre	1973–1974
Olds F-85	1970–1976
Olds/Pontiac Full Size	1971–1989
Omega	1973–1975
Omega	1977–1979
Skylark/GS	1971–1975
Skylark/GS	1977–1979
Suburban	
C10/C15/G10/G15	1978–Present
Z-28	1972–1981

## ECTED Max Feature

With the flip of a switch, go from Limited Slip to a Full Locking mode that delivers 100% torque to both wheels!

## High Performance Series Feature

Auburn Gear's flagship Limited Slip Differential gives you smooth torque sensing operation with the correct bias ratios to outperform the competition.

## Pro Series Feature

High Torque bias Cone Clutch design provides Maximized Torque Transfer, making it the Ultimate Limited Slip Differential for true performance.

## GM 8.5" F&R/GM 8.6" RING & PINION REAR STYLE

PART #	DEM REFERENCE #	TEETH	RATIO
342030	26018279	41-11	3.73:1
342031	26037712	41-12	3.42:1
342032	3988515	39-7	4.11:1

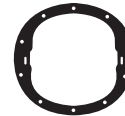

11" 10 Holes, Irregular  
Front

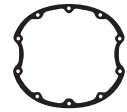

10 5/8" 10 Holes, Irregular  
Rear

### Specifications:

Ring Gear Diameter 8.5"  
10 7/16" X 20 RH Threaded Bolts  
Pinion Diameter 1.626" 30 Splines  
Case Ratio: 2.56:1 & Numerically Lower  
Case Ratio: 2.73:1 & Numerically Higher  
8620 Material—Heat Treated

### Compatible Auburn Gear Differential Part Numbers

545003 542050  
545004 542052  
542018 544905  
542022 544906  
542097

### Make Year

Apollo/Regal Century	1973–1977
Biscayne/Roadmaster	1971–1974
BUICK FULL SIZE	1971–1996
Camaro	1970–1981
Chevelle	1970–1976
CHEVY FULL SIZE	1971–1996
Chevy II/Nova	1970–1979
Cutlass/Grand Prix/ Lemans/GTO/Ventura/ Phoenix	1971–1977
El Camino	1971–1977
Electra	1973–1978
GTO/Firebird/Trans Am	1970–1981
Grand National	1984–1987
Grand Sport	1973–1984
Hurst Oldsmobile	1985–1988
Impala Roadmaster	1991–1996
Lesabre	1973–1974
OLDSV	1971–1992
Olds F-85	1970–1976
MONTE CARLO	1971–1983
PONTIAC FULL SIZE	1971–1989
SKYLARK/GS	1971–1979
Z-28	1972–1981
Blazer Front/Rear	1975–2002
C10/C15/G10/G15	1978–Present
G20/G25	1979–Present
GM 1/2 TON Front	1999–2011
GM 1/2 TON Rear	1974–2011
GM 1/2 TON with Posi Rear	1970–1999
GM 3/4 TON Front	1977–1999
GM 3/4 TON Rear	1979–1995
K10-K15-K20-K26 Front	1977–1987
K10-K15 Rear	1982–Present

## GM 8.5" MASTER INSTALLATION KIT

PART #	DESCRIPTION	MODEL YEARS
5410101	Bearing Master Kit 1970–1999 Non-IFS, & Rear Car	1970–1999
5410102	Bearing Master Kit 1999–2008	1999–2008
5410103	Bearing Master Kit 2009 & Later GM 8.6	2009 & Later

**\*Kit Contains Timken Bearings**



## MASTER INSTALLATION KITS

- Ring Gear Bolts • Differential Bearings • Silicone Sealant • Pinion Bearings • Crush Collar • Brush • Pinion Shims •
- Differential Shims • Gear Marking Compound • Pinion Seal • Pinion Nut • Thread Adhesive •



# GM 8 7/8" 12 Bolt - Car

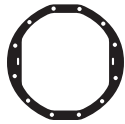

10 7/8" 12 Holes, Oval

**Applications:** Chevrolet passenger car with 8 7/8" ring gear.

	YEAR	PART #	RATIOS	SIDE GEAR SPLINE	BEARING CONE*	BEARING CUP*
<b>ECTED Max Selectable Locker</b>	1964-1972	545008**	3.07:1 to 3.73:1	30 Teeth	LM603049	LM603012
	1964-1972	545010^	4.10:1 & Up	30 Teeth	LM603049	LM603012
<b>High Performance Differential</b>	1964-1972	5420104^	4.10:1 & Up	30 Teeth	LM603049	LM603012
	1964-1972	5420106**	3.07:1 to 3.73:1	30 Teeth	LM603049	LM603012
<b>Pro Series Differential</b>	1964-1972	542031^	4.10:1 & Up	30 Teeth	LM603049	LM603012
	1964-1972	5420117*^	4.10:1 & Up	33 Teeth	LM603049	LM603012
	1964-1972	542033**	3.07:1 to 3.73:1	30 Teeth	LM603049	LM603012
	1964-1972	5420118***	3.07:1 to 3.73:1	33 Teeth	LM603049	LM603012

^ "C" axle-4 Series Case    \*\* "C" axle-3 Series Case    \* 9319 Gear Material



Use Auburn Gear limited-slip additive for maximum performance. A 6 oz. bottle is included with your Auburn Gear differential. Part #504102.

Make	Year
Camaro	1964-1972
Chevelle	1964-1972
Chevrolet	1964-1972
Chevy II	1964-1972
El Camino	1965-1972
Firebird	1967-1972
Grand Prix	1970-1972
GTO/LeMans	1965-1972
Monte Carlo	1970-1972
Nova	1970-1972
Olds F85	1968-1970

## GM 8 7/8" PERFORMANCE RING & PINION

PART #	OEM REFERENCE #	TEETH	RATIO
342033		41-11	3.73:1

**Specifications:**

- Ring Gear Diameter 8.875"
- 12 3/8" X 24 RH Threaded Bolts
- Pinion Diameter 1.625" 30 Splines
- Case Ratio: 2.73:1 & Numerically Higher
- 8620 Material—Heat Treated

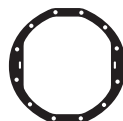

10 7/8" 12 Holes, Oval

Make	Year
Caprice	1966-1972
Chevelle	1964-1973
Chevy II	1965-1968
El Camino	1965-1972
Impala	1965-1972
Malibu	1965-1967
Monte Carlo	1970-1972
Nova	1969-1972
Ford Royal	1970-1972
GMC Sprint	1971-1972
Oldsmobile 442	1971
Olds 98	1965-1972
Cutlass/Cutlass Supreme	1971-1972
Delmont 88	1967-1968
Olds Delta 88 & F85	1965-1972
Jetstar 88	1965-1967
Vista Cruiser	1967-1972
Pontiac Acadian	1968-1971
Bonneville/Catalina	1965-1972
Firebird	1967-1972
GTO	1965-1972
Grand Prix	1970-1972
Grand Safari	1971-1972
Pontiac Grandville	1971-1972
LeMans	1965-1971
Star Chief	1955-1956
Pontiac Tempest	1970

Compatible Auburn Gear Differential Part Numbers	
545008	5420104
545010	5410106
542031	5420117
241033	5420118

Make	Year
Buick Centurion	1971-1972
Buick Electra	1965-1972
Buick Estate Wagon	1971-1972
Buick GS	1970-1972
Buick GS 350/400	1968-1969
Buick GS 455	1970-1972
Buick Gran Sport	1965-1967
Buick LeSabre/Skylark	1971-1972
Buick Special	1965-1969
Buick Sportwagon	1964-1972
Cevrolet Bel Air	1965-1970
Camaro	1967-1972

# GM 8 7/8" 12 Bolt - Truck

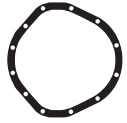

11 1/2" 12 Holes, Irregular

**Applications:** Chevrolet truck with 8 7/8" ring gear.

	YEAR	PART #	RATIOS	SIDE GEAR SPLINE	BEARING CONE*	BEARING CUP*
<b>ECTED Max Selectable Locker</b>	1964-mid 1982	545009**	2.76:1 to 3.42:1	30 Teeth	LM603049	LM603012
	1964-mid 1982	545011^	3.73:1 & Up	30 Teeth	LM603049	LM603012
<b>High Performance Differential</b>	1964-mid 1982	5420105^	3.73:1 & Up	30 Teeth	LM603049	LM603012
	1964-mid 1982	5420107**	2.76:1 to 3.42:1	30 Teeth	LM603049	LM603012
<b>Pro Series Differential</b>	1964-mid 1982	542032^	3.73:1 & Up	30 Teeth	LM603049	LM603012
	1964-mid 1982	542034**	2.76:1 to 3.42:1	30 Teeth	LM603049	LM603012

^ "C" axle-4 Series Case

\*\* "C" axle-3 Series Case



Use Auburn Gear limited-slip additive for maximum performance. A 6 oz. bottle is included with your Auburn Gear differential. Part #504102.

Make	Year
1/2 Ton Truck	1964-1982
3/4 Ton Truck	1964-1982
C10, C15	1964-1982
G10, G15	1969-1981
G20, G25	1969-1981
K10, K15	1964-1982

# GM 9 1/2" 14 Bolt

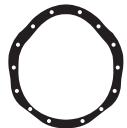

12 1/8" x 13 5/16" 14 Holes, Irregular

	YEAR	PART #	RATIOS	SIDE GEAR SPLINE	BEARING CONE*	BEARING CUP*
<b>High Performance Differential</b>	1981-Present	542087	All Ratios	33 Teeth	Set 42	Set 42

**Applications:** All GM products with 9 1/2" ring gear **SPECIAL NOTE:** Model years 2014-2016 are 12 bolt. Model years 1981-2013 are 14 bolt. GM 9 1/2" posi will fit present year vehicles.



Use Auburn Gear limited-slip additive for maximum performance. A 6 oz. bottle is included with your Auburn Gear differential. Part #504102.

Make	Year
C10, C15	1981-Present
C10, C15, C20	1988-Present
C30, C35	1983-Present
G10, G15	1981-Present
G20, G25	1988-Present
K10, K15	1989-Present

## ECTED Max Feature

With the flip of a switch, go from Limited Slip to a Full Locking mode that delivers 100% torque to both wheels!

## High Performance Series Feature

Auburn Gear's flagship Limited Slip Differential gives you smooth torque sensing operation with the correct bias ratios to outperform the competition.

## Pro Series Feature

High Torque bias Cone Clutch design provides Maximized Torque Transfer, making it the Ultimate Limited Slip Differential for true performance.

**NEW**

**Toyota Land Cruiser 12 Bolt**

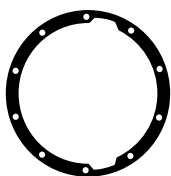

**Pro Series Differential**

YEAR	PART #	RATIOS	SIDE GEAR SPLINE	BEARING CONE*	BEARING CUP*
1968-1989	542030	All Ratios	30 Teeth	n/a	n/a

**Applications:** Land Cruiser



Use Auburn Gear limited-slip additive for maximum performance. A 6 oz. bottle is included with your Auburn Gear differential. Part #504102.

Make	Year
Land Cruiser	1968-1989

**SPECIAL NOTE:**  
1967 & prior must update to 30 tooth axle shafts.

**NEW**

**Toyota 8.0" 10 Bolt**

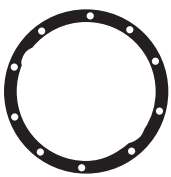

**Pro Series Differential**

YEAR	PART #	RATIOS	SIDE GEAR SPLINE	BEARING CONE*	BEARING CUP*
1974-Present	5420131^	All Ratios	30 Teeth	LM104948	LM104912

^4-pinion design

**Applications:** Toyota 8.0" 10 Bolt, Housing Cover and 10 Bolt Ring Gear



Use Auburn Gear limited-slip additive for maximum performance. A 6 oz. bottle is included with your Auburn Gear differential. Part #504102.

Make	Year
FJ Cruiser	2005-Present
Land Cruiser	1998-Present
Land Cruiser II	1990-2007
Pickup	1986-1996
T-100	2004-Present
Tacoma	2004-Present
Tundra	2005-2007

**Pro Series Features and Benefits**

- Made in the USA.
- Turn up your torque with our Pro Series differential for the very best in controlled power transfer.
- High Torque bias Cone Clutch design provides Maximized Torque Transfer, making it the Ultimate Limited Slip Differential for true performance.
- Backed by a one year limited warranty, plus an exclusive four years of coverage through the D-REX Program!



**NEW**

**Toyota 8.4" 10 Bolt**

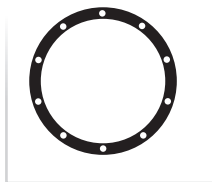

**Pro Series Differential**

YEAR	PART #	RATIOS	SIDE GEAR SPLINE	BEARING CONE*	BEARING CUP*
1990–Present	5420132^	All Ratios	30 Teeth	ST5186-N Set	ST5186-N Set

^4-pinion design

**Applications:** Toyota 8.4" 10 Bolt, Housing Cover and 12 Bolt Ring Gear



Use Auburn Gear limited-slip additive for maximum performance. A 6 oz. bottle is included with your Auburn Gear differential. Part #504102.

Make	Year
Lexus GX	1995–Present
Pickup	1986–1996
T-100	1995–2005
Tacoma	1995–2005
Tundra	1995–2005

**Pro Series Feature**

High Torque bias Cone Clutch design provides Maximized Torque Transfer, making it the Ultimate Limited Slip Differential for true performance.

**NEW**

**Toyota 9.5" 12 Bolt**

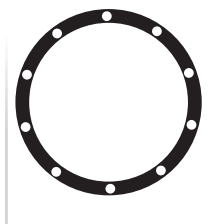

**High Performance Differential**

YEAR	PART #	RATIOS	SIDE GEAR SPLINE	BEARING CONE*	BEARING CUP*
2007–Present	5420133	All Ratios	32 Teeth	570064-1	32010J^

^Koyo

**Applications:** Tundra's with 4.7 liter V-8, T100 & 200 Land Cruisers 1998-present and Lexus LX470.



Use Auburn Gear limited-slip additive for maximum performance. A 6 oz. bottle is included with your Auburn Gear differential. Part #504102.

Make	Year
200 Land Cruiser	1998–Present
Lexus LX470	2007–Present
T-100	1998–Present
Tundra	2007–Present

**High Performance Series Feature**

Auburn Gear's flagship Limited Slip Differential gives you smooth torque-sensing operation with the correct bias ratios to outperform the competition.

# NEW

TOYOTA



## Toyota 10.5" 12 Bolt

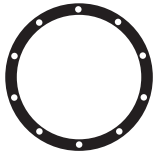

### High Performance Differential

Applications: Tundra's with 5.7 liter V-8

YEAR	PART #	RATIOS	SIDE GEAR SPLINE	BEARING CONE*	BEARING CUP*
2007–Present	5420134	All Ratios	36 Teeth	HR32011Xja4	R55-34NSK



Use Auburn Gear limited-slip additive for maximum performance. A 6 oz. bottle is included with your Auburn Gear differential. Part #504102.

Make	Year
Tundra	2007–Present

### High Performance Series Feature

Auburn Gear's flagship Limited Slip Differential gives you smooth torque-sensing operation with the correct bias ratios to outperform the competition.



## Autocross Road Race Units



10 9/16" x 10 13/16"  
10 Holes, Oval



8 5/16" x 10 9/16"  
10 Holes, Oval

Auburn Gear, LLC has developed a performance limited-slip differential designed specifically for road racing. It features a differential case designed to allow the center pin to float along with the axle shafts. This design aids in cornering; when turning, the outside wheel axle shaft will apply a force to the center pin causing the pinion gears to firmly seat inside the cone/side gear assembly. This gives the racer an extremely "tight" rear axle. The greater the G-force the more bite you get! If you are an avid road racer you'll want this unit.

### Race Series Differential

YEAR	PART #	RATIOS	SIDE GEAR SPLINE	BEARING CONE*	BEARING CUP*
1979–Present	542039	All Ratios	28 Teeth	LM603049	LM603012
1988–Present	542088	3.23:1 & Up	28 Teeth	LM501349	LM501314

#### Applications:

**Part #542039:** All Ford products with 8.8" ring gear. Accepts tone ring for ABS applications.

**Part #542088:** All GM products with 7 1/2" & 7 5/8" ring gear. Accepts tone ring for ABS applications.



Use Auburn Gear limited-slip additive for maximum performance. A 6 oz. bottle is included with your Auburn Gear differential. Part #504102.

### Race Series Features and Benefits

- Made in the USA.
- Performance Racing limited-slip differential developed specifically for road racing.
- A differential case designed to allow the center pin to float along with the axle shafts
- Race design features benefit drivers by, giving the racer an extremely "tight" rear axle when cornering.
- Backed by a one year limited warranty, plus an exclusive four years of coverage through the D-REX Program!

**Titan 10 Bolt**

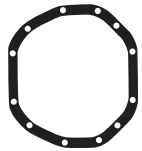

10.3" x 9.38"  
12 Holes, Irregular

**Pro Series Differential**

YEAR	PART #	RATIOS	SIDE GEAR SPLINE	BEARING CONE*	BEARING CUP*
2004-2007	5420137	All Ratios	32 Teeth	JLM704649	JLF704610

**SPECIAL NOTE:**

Replacement for factory open differential only. If replacing factory locker, new axle shafts are required.

Part #5420137 only works with axle shafts from an open differential.



Use Auburn Gear limited-slip additive for maximum performance. A 6 oz. bottle is included with your Auburn Gear differential. Part #504102.

Make	Year
Titan	2004-2015
Frontier	2005-2016
Equator	2009-2012



**Pro Series Features and Benefits**

- Made in the USA.
- Turn up your torque with our Pro Series differential for the very best in controlled power transfer.
- High Torque bias Cone Clutch design provides Maximized Torque Transfer, making it the Ultimate Limited Slip Differential for true performance.
- Backed by a one year limited warranty, plus an exclusive four years of coverage through the D-REX Program!



## DIFFERENTIAL SERVICE KITS

APPLICATION	AG DIFF. PART NUMBER	SPRING RETAINER SERVICE KIT	PINION GEAR SERVICE KIT	PINION SHAFT SERVICE KIT
GM 7.5" & 7 <sup>5</sup> / <sub>8</sub> "	542040, 41, 57, 58 542044, 45, 46, 47	541016 541017	541011 541011	541005 541005
GM 8.5" & 8.6"	542018, 22, 29, 97 542050, 52	541018 541019	541012 541012	541007 541007
GM 8.2"	542061, 108	541035	541036	541037
1963-79 Corvette	542062, 63	541035	541036	541037
GM 8 <sup>7</sup> / <sub>8</sub> " 12 Bolt, Car & Truck	542031, 32, 33, 34 5420104, 105, 106, 107	541022	541014	541024
GM 9.5"	542087	541043	541044	541042
Ford 7.5 <sup>**</sup> (C Washer Kit Available - 542035)	542023 542048	541016 541017	541011 541011	541006 541006
Ford 8.8", 28 Tooth	542024, 79 542053, 80	541018 541019	541012 541012	541007 541007
Ford 8.8", 31 Tooth	542025 542054	541020 541021	541013 541013	541008 541008
Ford 8" & 9"	542036, 43, 59	541023	541015	541010
Ford 9.75"	542090	541043	541044	541042
Ford 10 <sup>1</sup> / <sub>4</sub> "	542089	541045	541046	541047
Chrysler 9 <sup>1</sup> / <sub>4</sub> "	542070, 71	541038	541039	541040
Chrysler 8 <sup>1</sup> / <sub>4</sub> "	542072, 74	541041	541012	541007
Chrysler 8 <sup>3</sup> / <sub>4</sub> "	542051	541022	541014	541024
AMC Model 20	542081	541019	541012	541007
Toyota Landcruiser	542030	541022	541014	541024
Toyota 8.0" & 8.4"	5420131, 32	541079	541080	541081
Toyota 9.5"	5420133	541038	541039	54108
Toyota 10.5"	5420134	541045	541046	541083
Auburn (Dana) Model 44	542082, 83, 109,110	541019	541012	541007
Buick/Olds/Pontiac 8.2"	542060, 542099, 113, 114	541035	541036	541048
Chevy 8.4"	5420100	541041	541012	541049



**Pinion Gear Service Kit**



**Spring Retainer Service Kit**



**Pinion Shaft Service Kit**

**NOTE:** Also Available  
Additive 504102  
Single = (1) 6 oz. Bottle  
Case = (25) 6 oz. Bottles



**ECTED Max Master Kit**

**NOTE:** ECTED Max Master Kit is only used for ECTED Max Part Numbers 545001-545021

**NOTE:**

For information regarding MAX Lock Locker Spring Service Kits, please contact Auburn Gear.

## ECTED MAX SERVICE KITS

ECTED MAX APPLICATION	ECTED MAX PART NUMBER	WIRE HARNESS & SWITCH KIT	(8) COIL ASSEMBLY	(9) COIL BEARING	(7) CLUTCH KIT	(5) PINION SHAFT KIT	(1 THRU 7) MASTER KIT	AXLE SHAFT SPACER	DIFFERENTIAL BEARING KIT
Ford 8.8" with 28 Spline Axles	545001	541051	541052	541053	541054	541055	541057	N/A	N/A
Ford 8.8" with 31 Spline Axles (C-clip only)	545002	541051	541052	541053	541054	541056	541059	N/A	N/A
GM 8.5" with 28 Spline Axles	545003	541051	541052	541053	541054	541055	541057	N/A	541070
GM 8.5" with 30 Spline Axles	545004	541051	541052	541053	541054	541055	541058	N/A	(thru 1998) 541070
Ford 8.8" with 31 Spline Axles (IRS only)	545005	541051	541052	541053	541054	541056	541060	N/A	N/A
AMC 20	545006 & 07	541051	541052	541053	541054	541055	541061	N/A	N/A
Chevrolet 12 Bolt, Car & Truck, 30 Spline Axles	545008, 09, 10, 11	541051	541052	541053	541054	541055	541062	N/A	N/A
Auburn (Dana) 35, 27 Spline Axles	545012 & 13	541051	541063	541053	541064	541065	541066	N/A	541070
Auburn (Dana), 30 Spline Axles	545014 & 15	541051	541063	541053	541064	541065	541067	N/A	541070
Auburn (Dana), 27 Spline Axles	545016 & 17	541051	541063	541053	541069	541065	541068	N/A	N/A
Auburn (Dana), 30 Spline Axles	545018 & 19	541051	541063	541053	541072	541071	541073	N/A	541075
Auburn (Dana), 30 Spline Axles	545020	541051	541063	541053	541072	541071	541077	N/A	N/A

Note: 541070 Contains: (2)LM102949, (2)LM102911.

## LIMITED-SLIP ADDITIVE



Use Auburn Gear limited-slip additive for maximum performance. A 6 oz. bottle is included with your Auburn Gear differential. Part #504102.

The Auburn Gear limited-slip differential and ECTED Max selectable locker designs have been extensively tested with high-quality Non-Synthetic 80W 90 hypoid oils treated with limited-slip friction additive. Three (3) oz. of Auburn Gear additive (part #504102) will treat one (1) quart of oil. To avoid differential clutch chatter (noise) and for optimum performance, use the oil and additive described above. Use of other additive and oil types may cause differential clutch chatter. We do not recommend synthetic oil. Auburn Gear limited-slip additive (a 6 oz. bottle) is packed in every box with the differential. Auburn Gear limited-slip additive is available at your local authorized Auburn Gear distributor.

## DIFFERENTIAL REPLACEMENT EXCHANGE PROGRAM

### What It Is

*D-REX stands for Differential Replacement EXchange Program. Auburn Gear's limited-slip differentials are designed and manufactured with a robust and unique cone clutch mechanism. However, due to machining and assembly processes, the differential case and side gear/cone clutch mechanism are a matched set and therefore non-rebuildable. All other components within the Auburn Gear differential are replaceable and service kits are available. In order to address the non-rebuildable components within our limited-slip differentials we offer the D-REX unit.*

### What We Promise

*With Auburn Gear, you get a full one-year manufacturer's warranty, plus D-REX coverage for four years from date of purchase. D-REX stands for Differential-Replacement Exchange—which means Auburn Gear will replace your unit within the first four (4) years after purchase. Every part you get will be brand new. The unit comes assembled, tested, certified and ready for installation. No more rebuilding and mixing old worn parts with new parts! There is a nominal charge for the new replacement unit. The replacement unit is completely new, no rebuilt parts or case.*

### Qualifications for D-REX Program

*To qualify, the unit must have been purchased within the last four (4) years. This can be determined either from your original dated receipt OR by the date code stamped on the differential case. Example: 018 A20 12. 018 represents the part number.*

*Contact your distributor or Auburn Gear to get your Replacement Exchange Number. Do not return your unit without getting this number. Units received without the RE# will be returned to sender.*

*Do not return the differential with bearings and/or ring gear installed. Auburn Gear will not be held responsible for products returned with these components installed. They will be scrapped.*

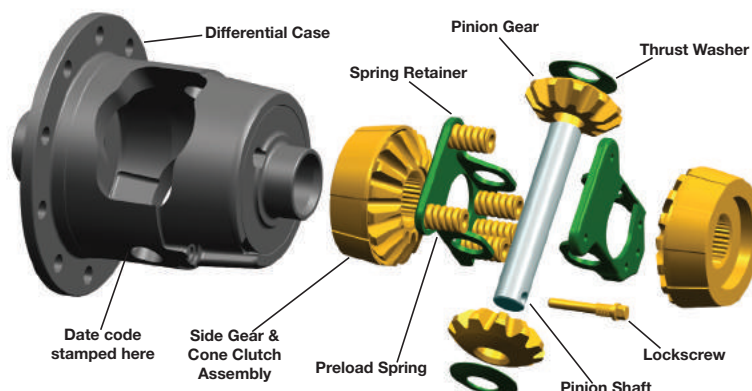

**LISTED ARE THE MAXIMUM TIRE SIZES FOR THE AUBURN GEAR TRACTION DIFFERENTIAL APPLICATIONS**

Application	MAXIMUM TIRE SIZE										
	30"	31"	32"	33"	34"	35"	36"	37"	38"	39"	40"
AMC 20 12 Bolt	✓	✓	✓	✓	✓	✓					
Chrysler 8 1/4" & 8 3/8" 10 Bolt	✓	✓	✓	✓	✓	✓					
Chrysler 8 3/4" 10 Bolt	✓	✓	✓	✓	✓	✓					
Chrysler 9 1/4" 12 Bolt	✓	✓	✓	✓	✓	✓	✓				
Auburn (Dana) 30	✓	✓									
Auburn (Dana) 35	✓	✓	✓	✓	✓						
Auburn (Dana) 44	✓	✓	✓	✓	✓	✓	✓	✓			
Auburn (Dana) 50 Front Axle	✓	✓	✓	✓	✓	✓					
Auburn (Dana) 60	✓	✓	✓	✓	✓	✓	✓	✓	✓		
Ford 7 1/2" 10 Bolt	✓	✓	✓	✓	✓						
Ford 8" 10 Bolt	✓	✓	✓	✓							
Ford 8.8" 10 Bolt	✓	✓	✓	✓	✓	✓					
Ford 9" 10 Bolt	✓	✓	✓	✓	✓	✓	✓	✓			
Ford 9 3/4" 12 Bolt	✓	✓	✓	✓	✓	✓	✓	✓	✓		
Ford 10 1/4" & 10 1/2" 12 Bolt	✓	✓	✓	✓	✓	✓	✓	✓	✓	✓	
GM 7 1/2" & 7 5/8" 10 Bolt	✓	✓	✓	✓	✓						
Chevy 8.2" 10 Bolt	✓	✓	✓	✓	✓						
B.O.P. 8.2" 10 Bolt	✓	✓	✓	✓	✓						
GM 8.2" / 8.4" 1955-64 10 Bolt	✓	✓	✓	✓	✓						
Corvette 1963-79 10 Bolt	✓	✓	✓	✓	✓						
GM 8.5" & 8.6" 10 Bolt	✓	✓	✓	✓	✓	✓					
GM 8 7/8" 12 Bolt Car	✓	✓	✓	✓	✓	✓					
GM 8 7/8" 12 Bolt Truck	✓	✓	✓	✓	✓	✓					
GM 9 1/2" 14 Bolt	✓	✓	✓	✓	✓	✓	✓	✓			
Toyota 8 7/8" 12 Bolt	✓	✓	✓	✓	✓	✓	✓				
Toyota 8.0" 10 Bolt	✓	✓	✓	✓	✓						
Toyota 8.4" 10 Bolt	✓	✓	✓	✓	✓						
Toyota 9.5" 12 Bolt	✓	✓	✓	✓	✓	✓					
Toyota 10.5" 12 Bolt	✓	✓	✓	✓	✓	✓	✓	✓	✓		



## CHOOSING THE OPTIMAL GEAR RATIO FOR YOUR VEHICLE

- Improve Fuel Economy
- Optimum Range (2,300-2,600 RPM)
- Improve Power

This chart shows RPM (rotations per minute) calculations at 55 miles per hour for various combinations of final gear ratios.

When selecting a gear ratio, consider the following:

1. Tire Size
2. Transmission Ratio
3. Final Gear Ratio
4. Engine RPM at cruise speed

GEAR RATIO	TIRE DIAMETER																
	24	25	26	27	28	29	30	31	32	33	34	35	36	38	40	42	44
2.56	1972	1892	1820	1752	1690	1631	1577	1526	1478	1434	1391	1352	1314	1245	1183	1126	1075
2.73	2102	2018	1940	1869	1802	1740	1682	1627	1577	1529	1484	1441	1401	1328	1261	1201	1147
2.94	2264	2173	2090	2012	1942	1874	1811	1753	1698	1646	1599	1552	1509	1429	1358	1294	1235
3.08	2372	2277	2189	2108	2033	1963	1897	1836	1779	1725	1674	1626	1581	1498	1423	1355	1294
3.21	2472	2373	2282	2197	2119	2046	1977	1914	1854	1798	1745	1695	1648	1561	1483	1412	1348
3.31	2549	2447	2353	2266	2185	2110	2039	1973	1912	1854	1799	1748	1699	1610	1529	1456	1390
3.42	2633	2528	2303	2341	2257	2179	2107	2039	1975	1915	1859	1806	1756	1663	1580	1505	1436
3.54	2726	2617	2516	2423	2336	2256	2181	2110	2044	1982	1924	1869	1817	1772	1635	1558	1487
3.73	2872	2757	2651	2553	2462	2377	2298	2224	2154	2089	2027	1969	1915	1814	1723	1641	1567
3.90	3003	2883	2772	2669	2574	2485	2402	2325	2252	2184	2120	2059	2002	1897	1802	1716	1638
4.10	3157	3031	2914	2806	2706	2613	2526	2444	2368	2296	2228	2165	2105	1994	1894	1804	1722
4.27	3288	3156	3035	2923	2818	2721	2630	2545	2466	2391	2321	2255	2192	2077	1973	1879	1793
4.56	3511	3371	3291	3121	3010	2906	2809	2718	2633	2554	2478	2408	2341	2218	2107	2006	1915
4.88	3758	3607	3469	3340	3221	3110	3006	2909	2818	2733	2652	2577	2505	2373	2255	2147	2050
5.29	4073	3910	3760	3621	3491	3371	3259	3154	3055	2962	2875	2793	2716	2573	2444	2328	2222
5.38	4143	3977	3824	3682	3551	3428	3314	3207	3107	3013	2924	2841	2762	2616	2486	2367	2260
5.71	4397	4221	4058	3908	3769	3639	3517	3404	3298	3198	3104	3015	2931	2777	2638	2512	2398
6.17	4751	4561	4385	4223	4072	3932	3801	3678	3563	3455	3354	3258	3167	3001	2851	2715	2591
7.17	5521	5300	5096	4907	4732	4569	4417	4274	4141	4015	3897	3786	3681	3487	3313	3155	3011

# WHY PURCHASE AN AUBURN GEAR PERFORMANCE DIFFERENTIAL?

## Simply...performance

Our units offer you more torque bias performance than any other limited slip differential available in the industry. Torque bias, measured in lbs-ft, is the ability of the limited slip differential to divide the input torque unequally, allowing more torque to be delivered to the wheel with the most traction. Bias torque translates to more driving force, hence more horsepower to the ground. Torque bias is the measuring stick by which all limited slip differentials are compared. It is the apples-to-apples performance comparison!

## Let's look at some hard test data

We ran competitive testing on an EatonPosi, TrueTrac by Tractech (the folks who make Detroit Locker), Torsen, and Traction-Loc by Ford. As you can see, the Auburn Pro is the clear-cut performance leader in the industry with the Auburn High Performance Series taking the close second. Everyone else falls way behind just like they will on the street, quarter-mile or off-road.

## Quality, controlled right here in the USA

One of the best reasons for buying an Auburn Gear Performance Differential is quality control. Every unit is hand inspected and assembled right here in the USA by our own highly-motivated inspector/assemblers. We don't rely on our suppliers' word (even though it's usually pretty accurate!); we insist on inspecting each and every casting, forging, and component before they are assembled into a super-reliable Auburn Gear Performance Differential.

## Best guarantees in the industry

We back up our performance advantage by offering the best warranty in the business: a one-year warranty, plus an additional four years of D-REX coverage. D-REX stands for Differential Replacement EXchange. We will replace your unit, no matter the reason, within the first 4 years after purchase for the price of a competitor's clutch pack. Every part you get will be brand new—the unit comes assembled, tested, certified, and ready for installation. No more rebuilding and mixing old worn parts with new parts!

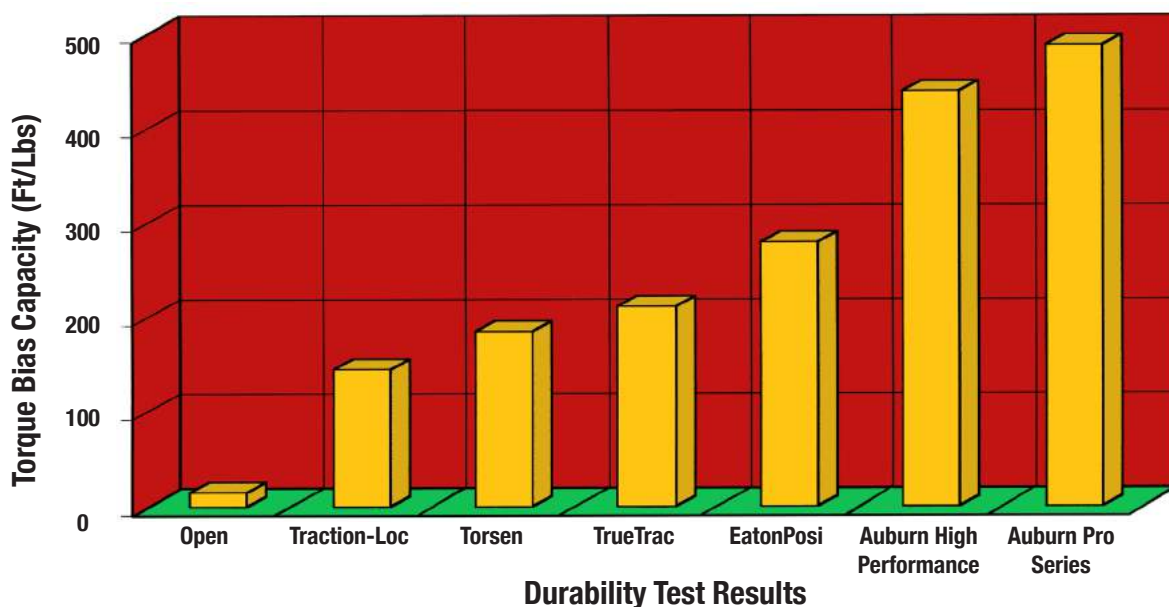

## GENERAL QUESTIONS

**What are the differences between the High Performance LSD, the Pro LSD, and ECTED Max?**

The ECTED Max is a limited-slip and a locker in one differential. The driver controls the mode with a switch inside the vehicle. The ECTED Max can be switched to lock mode, which allows 100% torque transfer to both wheels. The High Performance and Pro are limited-slip units. Any limited-slip differential can allow the low traction wheel to spin since the amount of torque that can be transferred to the opposite wheel is limited (hence the name limited-slip).

**What is the difference between the Auburn Gear Pro Series and the Auburn Gear High Performance Series?**

The High Performance Series is another option in the Auburn Gear traction enhancement products. The cone clutch design offers increased durability and performance in normal street use. The high bias cone clutch design of the Pro Series provides a higher torque and preload, making it the ultimate limited-slip differential for true performance. It is engineered to provide lightning-quick, torque-sensing traction when you need it. No buttons to push, no leavers to pull, it goes into action when you accelerate. It handles superbly—on and off road.

**Is the ECTED Max and/or limited-slip only for Jeeps/trucks/SUVs, or can it be installed in a car?**

Auburn Gear differentials are suitable for virtually all vehicle applications where additional traction is needed—for recreational, sport or work use. For example, installing an Auburn Gear differential in your performance car will give you spool-like performance when coming off the line, combined with full wheel differentiation when turning. Imagine two wheels gripping the pavement instead of one spinning effortlessly.

**What differential should be used for Drag Racing?**

For true street-strip performance, the ECTED Max is the best application. The ECTED Max is really two differentials in one. It is a full-time limited-slip differential, then with the flip of a switch, it converts to a full-locker. The best of both worlds and winning at the track. In the limited-slip product line, for both street and strip, the Pro Series is the choice; however, the High Performance limited-slip is effective in street and strip applications. For strictly drag racing (no street driving), a spool would be the choice.

**How much horsepower and torque will the High Performance LSD take? Is there a horsepower limitation?****What is it?**

Each size has its own limitations, but it is more related to torque than to horsepower. Additionally, the transmission type, driving habits (snap starts) and tires (traction) play a role.

**How can I determine if a traction device such as a positraction or locker is installed in my vehicle?**

Put the transmission in neutral and jack up both tires. Rotate one tire. If the other tire spins in the opposite direction, you have an open differential. If it spins the same direction, you do have a traction device.

**If only installing one traction differential, should I install in the front or rear?**

A rear locker can greatly increase the mobility of the vehicle. In many scenarios, a 4 X 2 with a rear locker can outperform a 4 X 4 without a locker. For severe traction applications and extreme off-road, the ECTED Max electronic locker with limited-slip differential is an excellent choice.

**What is clutch chatter?**

Clutch chatter occurs when the clutch cone engages and disengages rapidly in the differential case. It causes no damage and can be cured by using the correct oil and friction modifiers. Clutch chatter is caused by the difference between the static (non-slipping) friction coefficient and the dynamic (slipping) friction coefficient. When the difference becomes too great, the clutch cone cycles between the two (sticking and slipping), which creates the noise. Friction modifiers bring the static and dynamic friction coefficients closer together to minimize chatter. Auburn Gear recommends using Auburn Gear limited-slip additive (#504102) with a high-quality non-synthetic 80W 90 hypoid oil.

**What is a cone clutch?**

The Auburn Gear limited-slip differential employs an integral cone clutch side gear unit that creates friction with the carrier to drive both tires. The cone clutch design consists of two clutching members, one internal and one external (see image on page 9). The internal member is a unique single tapered part with lubrication grooves, attached to the side gear, creating the cone clutch assembly. The external member is also tapered with a matching angle. When the two are forced together, torque is transferred from one member to another. The cone clutch design allows for more clutch capacity in the same space and is less likely to chatter due to the reduced number of sliding surfaces. This means higher torque transfer for better traction, without the noise.

**Can I use the stock bearings?**

Yes. Exceptions are Ford 8", Ford 9" (some housings) and Dana 35. GM 8.5/8.6 may require special bearings when installing an ECTED Max in a pre-1999 vehicle. Bearings that should be used with the Auburn Gear Ford 8" and 9" differentials are determined by the bearing bore size. Small bearing bore 2.8 use bearings LM102949 & LM102910. Bore 3.062 use bearings LM603049 & LM603011. Bore 3.25 use spool only. Refer to the application pages for bearing part numbers.

**Does Auburn Gear have a limited-slip additive?**

Yes. Auburn Gear limited-slip additive, part #504102. Use for both ECTED Max and limited-slip differentials. It is available at your authorized Auburn Gear distributor.



## EFFECTS OF AUBURN DIFFERENTIALS

### Will the driving characteristics of my vehicle change?

For rear axle applications, any change will be minimal and usually unnoticeable. The operation of limited-slip differentials will be quiet, smooth and seamless. With front axle installations, there may be a slight addition to steering effort.

### Are the ECTED Max and limited-slip differentials noisy?

No. Operation is quiet and seamless with properly maintained lubricant and limited-slip additive. There is no clicking or banging.

### How do Auburn Gear differentials handle on slippery roads?

Any traction can affect handling on slippery roads. If the traction is overpowered by the driver, both wheels have lost traction instead of just one, which could cause a loss of side-to-side stability.

### Can I tow my vehicle if it has an ECTED Max and/or limited-slip?

Yes. If the unit is installed in the front, it is recommended to unlock the front wheel hubs and/or place the transfer case in 2-wheel drive.

### What affect will Auburn Gear differentials have on my towing capability?

The ECTED Max and the limited-slip differentials will not negatively affect trailer towing. In fact, you will find major improvement in traction. It will be beneficial when pulling the boat up the ramp, towing a camper on unpaved roads or anytime where increased traction is important.

### Does the Auburn Gear limited-slip differential affect gas mileage?

This would be negligible typically. However, an Auburn Gear limited-slip usually weighs more than an OE differential and since the clutches slip during turns, some energy loss does occur.

## TIRES

### Will tire pressure affect the operation of the differential?

Mismatched pressures mean different tire diameters and different wheel speeds. Keep the tire-rolling radius (with air pressure) within 1/4" for on-road vehicles and 1/2" for off-road vehicles.

### What size tire (diameter) can I use with Auburn Gear differentials?

Refer to the recommended tire size on page 49 of the catalog.

### Is tire wear affected by limited-slip differentials?

No. Auburn Gear differentials provide full wheel differentiation when turning so tire wear is minimized.

### Will I get tire hop or chirp with the ECTED Max or limited-slip differential?

It depends on the vehicle set-up and the tires. Typically, both the High Performance Series and Pro Series will accommodate turns on clean, dry pavement without wheel hop or tire chirp. In the "off" or limited-slip mode, the ECTED Max will accommodate turns on clean, dry pavement without wheel hop or tire chirp. In the full-locker mode (which should be used for severe off-road or drag strip performance) you may experience some wheel hop.

## MAINTENANCE AND WARRANTY

### What maintenance is required after the installation of an ECTED Max and/or limited-slip?

We recommend you change the differential oil according to your vehicle manufacturer's specifications and treat with Auburn Gear limited-slip additive (part number #504102).

### What kind of oil should be used with an Auburn Gear limited-slip differential/Auburn Gear ECTED Max differential?

Non-synthetic 80w90 GL-5 oil treated with Auburn Gear friction additive, part #504102 (also known as a friction modifier). See Catalog page 48. Three (3) ounces of additive will treat one quart of oil. GM or Ford limited-slip additive may be used. We do not recommend synthetic oil. Auburn Gear limited-slip additive is packed in every box with the differential.

### Can Auburn Gear differentials be rebuilt? Can I repair the Auburn Gear limited-slip differential?

New units—not rebuilt—are provided at a minimal cost for qualified replacements under the D-REX program. With the best warranty in the industry, there is no need to repair the Auburn Gear limited-slip differential. Please see the D-REX new replacement program and limited warranty on pages 48 and 55.

### Is there a way to tell if I have weak springs in my limited-slip?

Auburn Gear limited-slip springs will not weaken. The springs are not subject to cyclic compression/expansion, which can cause load loss. However, the clutch capacity can be reduced due to wear or damage from misuse.

### **What is the life expectancy of Auburn Gear differentials?**

As with all performance products, the application and driver skills dictate the life of the product. Long life can be expected with all Auburn Gear products when operated properly. Forcing one wheel to spin with respect to the other will greatly degrade the life of the differential.

### **What is the D-REX Replacement Exchange Program?**

Auburn Gear differentials, because of the precision design and machining, cannot be rebuilt. Under the D-REX Program, a NEW unit can be purchased for about the price of a competitor's clutch pack. The D-REX program covers four (4) years from the date code or four (4) years from original purchase receipt. See page 48 in the catalog.

## **INSTALLATION**

### **Can I install an Auburn Gear differential myself?**

Auburn Gear provides detailed differential installation instructions to allow an experienced mechanic to properly install the product.

### **What kind of break-in is required?**

All Auburn Gear differentials go through a break-in cycle at the factory, so no customer break-in procedure is required.

### **Should I install traction differentials in front and rear?**

It's a matter of personal preference, money and traction requirements. A single traction differential will usually double the vehicles off-road ability. Installation of traction differentials in front and rear increases traction to the maximum. Always consider safety and your driving conditions when making your decision.

### **Can I install Auburn Gear ECTED Max and/or limited-slip differential in a 2-WD vehicle?**

Yes. Traction improvement in a 2-WD vehicle provides the same traction improvement to the rear axle as installation in a 4-WD vehicle.

### **Can I install an ECTED Max and/or limited-slip differential in the front and rear of a 4-WD?**

Yes, if the application is available. However, we do not recommend installing a unit in the front differential if the vehicle has a full-time 4-WD and is primarily used on the pavement.

## **ECTED MAX**

### **Can I repair the ECTED Max if I need to?**

Yes. Depending upon your needs, several types of service kits are available. The gear service kit, locking mechanism kit, starter/amateur kit and the universal wiring kit. Please review the Auburn Gear D-REX warranty as it provides the best warranty in the industry.

### **Can the ECTED Max be used in the front axles?**

ECTED Max should not be used in front axles that have an inter-axle disconnect. On manual hub applications, both hubs are to be locked or unlocked. Do not lock one side and not the other. Differential damage can occur.

### **Can the ECTED Max be engaged on-the-fly?**

Yes, at reasonable speeds. The wheel speed difference between the wheels should be below 50 RPM to prevent impact loads to the drivetrain. It is recommended that the ECTED Max not be engaged if one wheel is completely off the ground or pavement.

### **How is the ECTED Max activated?**

The ECTED Max is activated by turning on the mounted switch inside the vehicle. When off, the limited-slip function responds automatically when torque is applied.

### **Is a relay necessary for ECTED Max operation?**

The ECTED Max switch is more than capable of managing the current that the ECTED Max requires. No need for a relay.

### **Can I purchase the wiring harness for the ECTED Max?**

Yes, the wiring harness is universal to fit any vehicle, and can be purchased separately. Refer to catalog page 37 for ECTED Max service kits.

### **Is the ECTED Max and/or limited-slip streetable?**

All Auburn Gear differentials are very streetable. Both the ECTED Max and the limited-slip provide smooth, quiet operation. In fact, Auburn Gear differentials were used as original equipment in the first muscle cars. Plus, they are aggressive enough to be used in other performance applications. When the ECTED Max is in full-locker mode, you may experience some under or push steering.