

AP[®]

APCLE-1002
500W

APCLE-2002
1000W

APCLE-3002
1500W

2 Channel Mosfet Power Amplifier

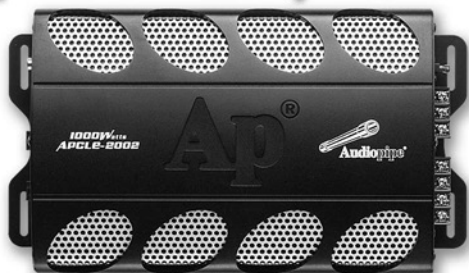

With Remote Bass Knob

Owner's Manual



INTRODUCTION

The Audiopipe APCLE-1002 / APCLE-2002 / APCLE-3002 is a full-featured two-channel amplifier incorporating the following features:

- Pulse-Width Modulated (PWM) MOSFET power supply for maximum performance with minimal distortion.
- Remote turn-on with “soft start” muting to prevent turn-on “thump”.
- Advanced circuitry design featuring bridgeable and mixed mode operation for use in various system configurations including 4, 3, or 2 channel systems.
- Variable high-pass/low-pass electronic crossover with a 12dB per octave slope (adjustable range: 55Hz to 5.5kHz).
- Variable bass boost circuit to reinforce low frequency signals that may be lost due to subwoofer enclosure design.
- Adjustable input level controls with ground loop isolation to minimize noise and distortion.
- 2 Ohm stereo stable, 4 Ohm mono stable.
- Platinum-plated power, speaker, and RCA connectors.
- Speaker level input.
- Low profile construction with aluminum heat sink for efficient heat dissipation.

ABOUT THE MANUAL

This manual describes the basic requirements to install the Audiopipe APCLE-1002 / APCLE-2002 / APCLE-3002 amplifier.

INPUT CONNECTIONS AND AUDIO CONTROLS

APCLE-1002

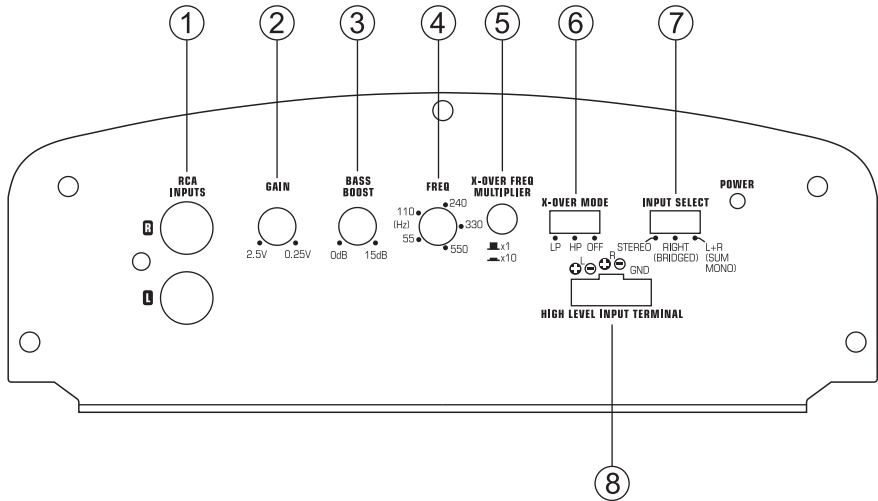

- | | |
|-------------------------------------|-------------------------------|
| 1. RCA Input Jacks | 5. Frequency Range Multiplier |
| 2. Gain Control | 6. X-Over Mode Switch |
| 3. Bass Boost Control | 7. Input Select Switch |
| 4. Frequency (Hz) Selection Control | 8. Speaker Level Input |

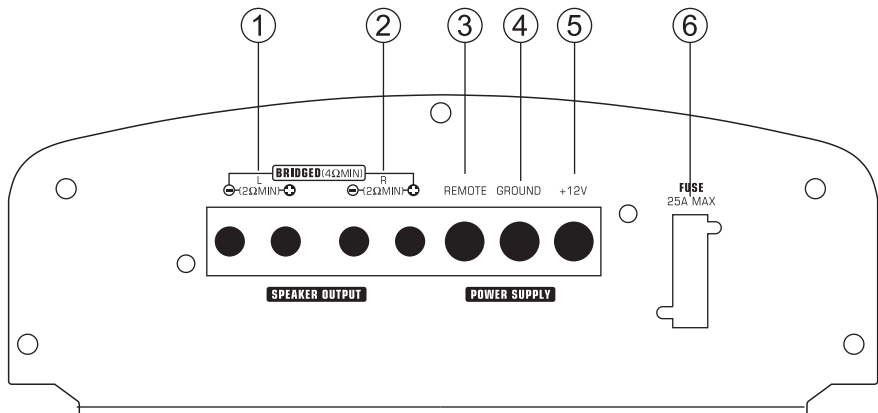

- | | |
|-------------------------|----------------------------|
| 1. Left Speaker Output | 4. Ground Input |
| 2. Right Speaker Output | 5. Battery +12v Input |
| 3. Remote Turn-on Input | 6. 25Amp Fuse / 40Amp Fuse |

APCLE-2002

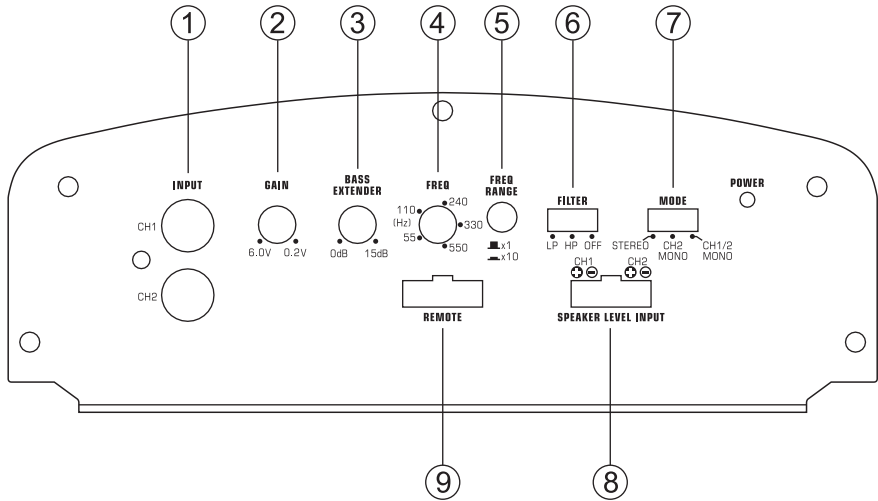

- | | |
|-------------------------------|--------------------------------|
| 1. CH1 / CH2 RCA Input | 6. CH1 / CH2 Filter |
| 2. Gain Control | 7. Output Mode Selector Switch |
| 3. Bass Extender | 8. Speaker Level Input |
| 4. CH1 / CH2 Frequency (Hz) | 9. Remote |
| 5. Frequency Range Multiplier | |

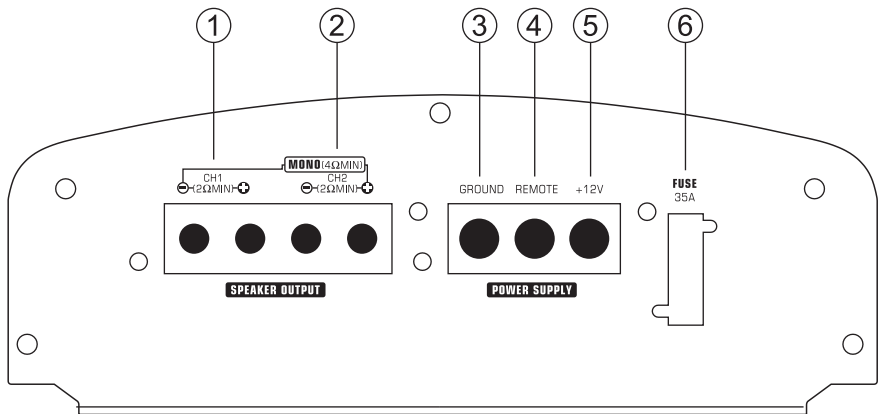

- | | |
|-----------------------|-------------------------|
| 1. CH1 Speaker Output | 4. Remote Turn-on Input |
| 2. CH2 Speaker Output | 5. Battery +12v Input |
| 3. Ground Input | 6. 35Amp Fuse |

APCLE-3002

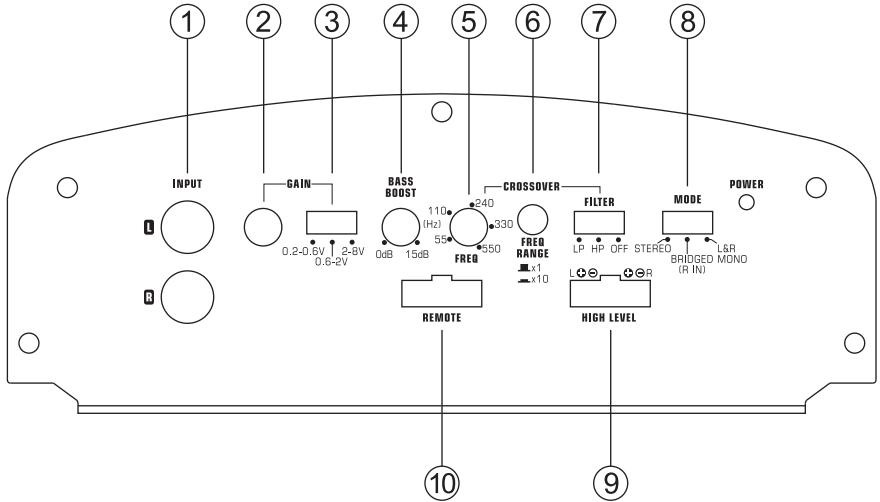

- | | |
|-------------------------------|-------------------------|
| 1. RCA Input Jacks | 6. Frequency Multiplier |
| 2. Gain Control | 7. X-Over Mode Switch |
| 3. Input Voltage Selector | 8. Input Mode |
| 4. Bass Boost Control | 9. Speaker Level Input |
| 5. Precise Frequency Selector | 10. Remote |

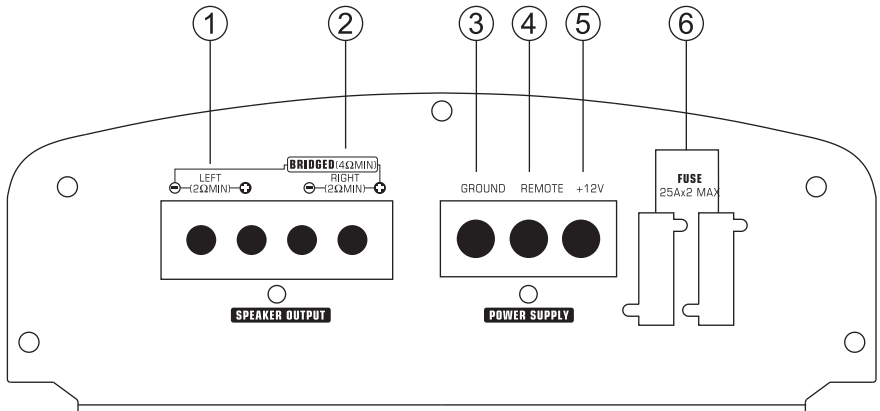

- | | |
|-------------------------|-------------------------|
| 1. Left Speaker Output | 4. Remote Turn-on Input |
| 2. Right Speaker Output | 5. Battery +12v Input |
| 3. Ground Input | 6. Fuse |

CONNECTIONS FOR POWER AND SPEAKERS

APCLE-1002

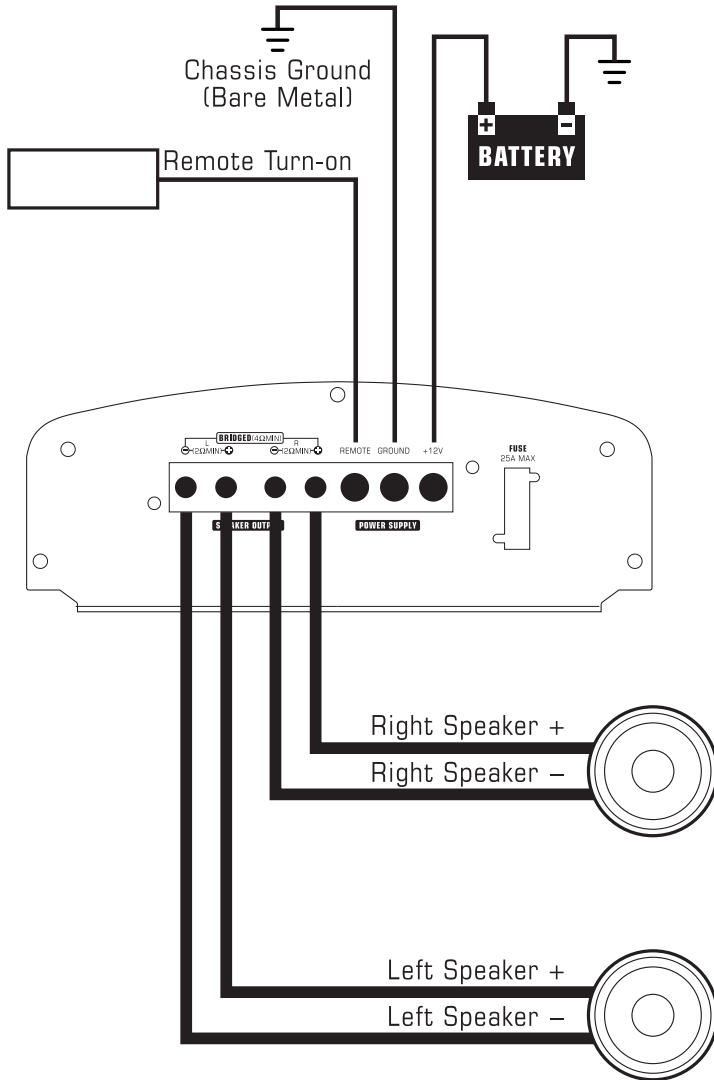

APCLE-2002

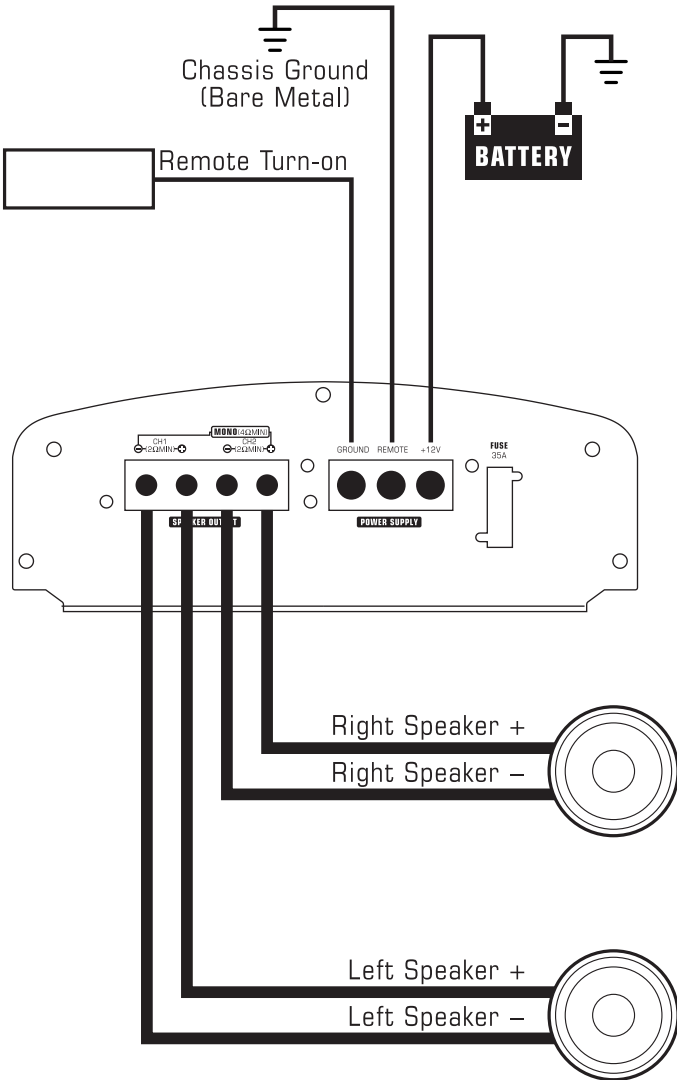

APCLE-3002

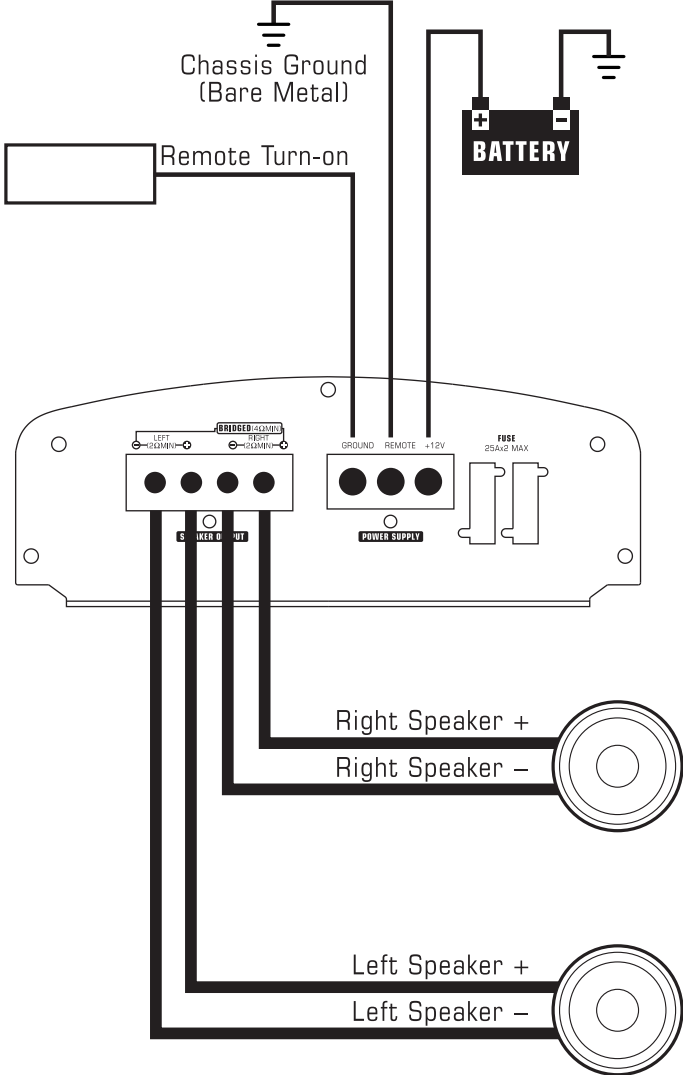

APCLE-1002

Bridged - Mono Subwoofer System

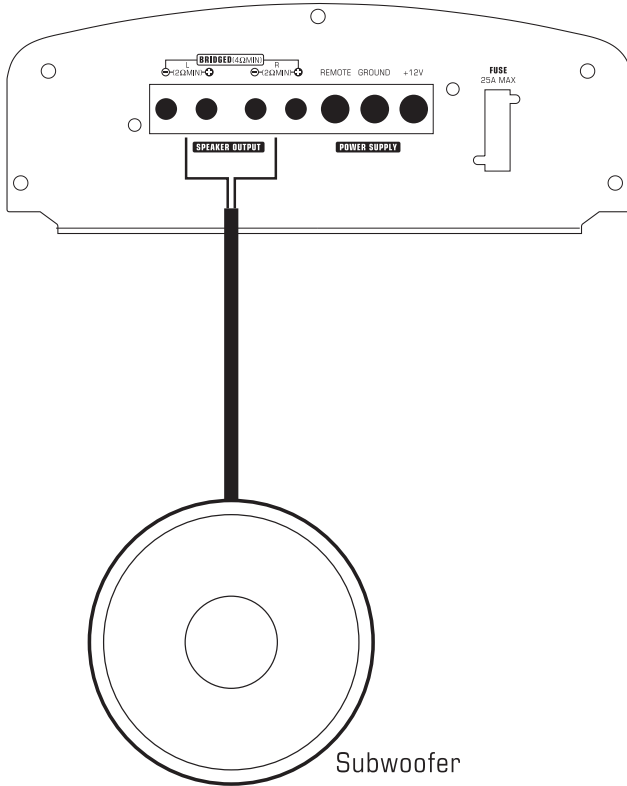

BASS BOOST **FREQ (Hz)** **X-OVER FREQ MULTIPLIER** **X-OVER MODE** **INPUT SELECT**

0dB 15dB 110 240 LP HP OFF STEREO RIGHT (BRIDGED) L+R (SUM MONO)

55 330 x1 x10

Set X-Over Mode to LP and adjust FREQ to subwoofer specifications

In this application the amplifier is bridged for mono operation to drive a subwoofer.

APCLE-1002

2-Channel Full-Range, Satellite, or Subwoofer Stereo System (Set INPUT SELECT Switch to STEREO)

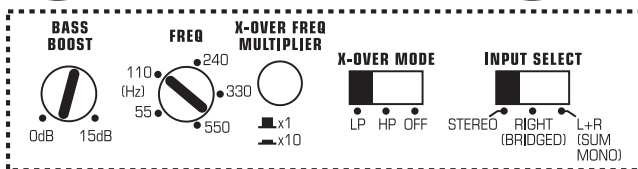
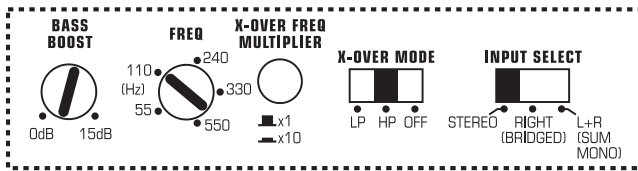
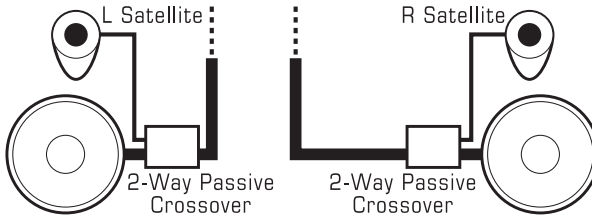
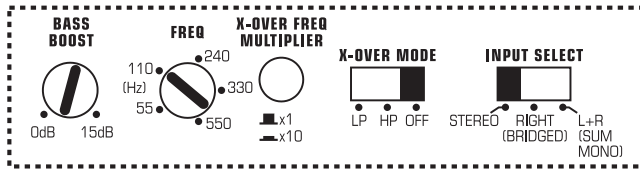
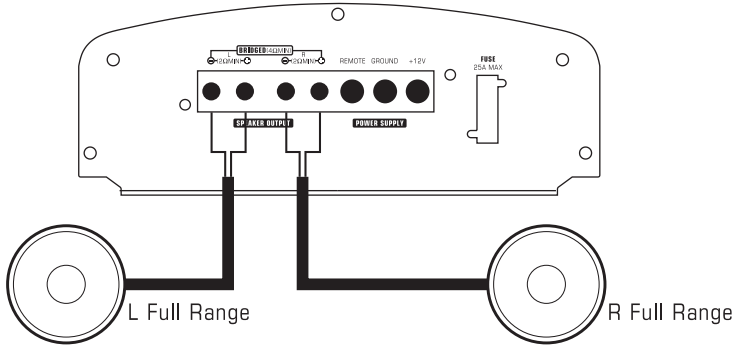

In this application, the amplifier is used in stereo and drives two full-range (or satellite or subwoofer) speakers. NOTE: A passive crossover must be used with satellite speakers.

APCLE-2002

Bridged - Mono Subwoofer System

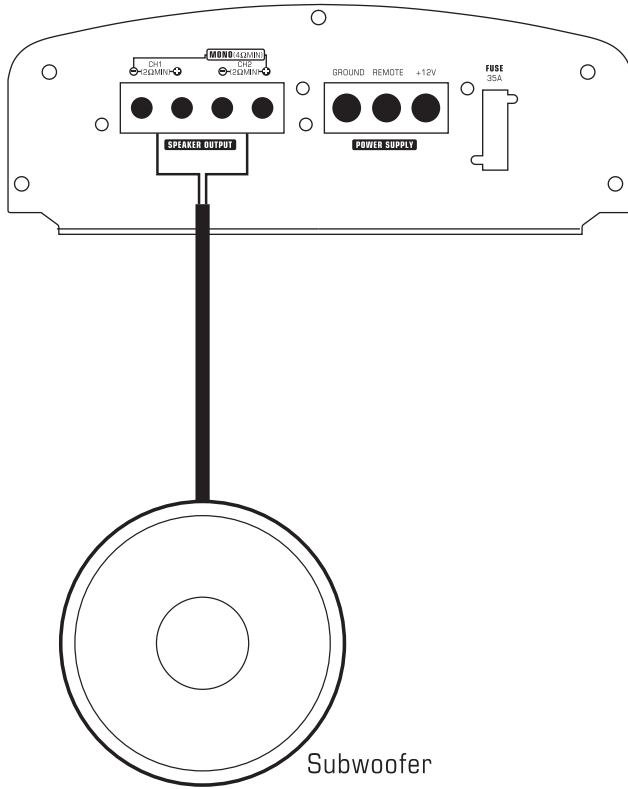

BASS EXTENDER
0dB 15dB

FREQ (Hz)
110 240 330 550
x1
x10

FREQ RANGE
x1
x10

FILTER
LP HP OFF

MODE
STEREO CH2 MONO CH1/2 MONO

Set X-Over Mode to LP and adjust FREQ to subwoofer specifications

In this application the amplifier is bridged for mono operation to drive a subwoofer.

APCLE-2002

2-Channel Full-Range, Satellite, or Subwoofer Stereo System (Set INPUT SELECT Switch to STEREO)

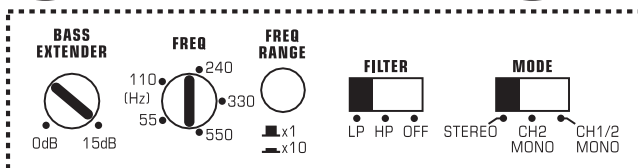
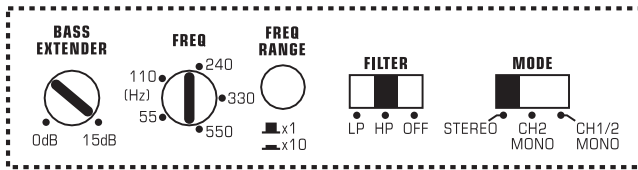
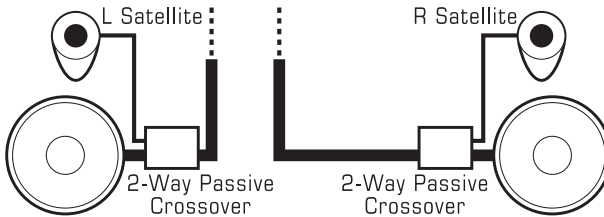
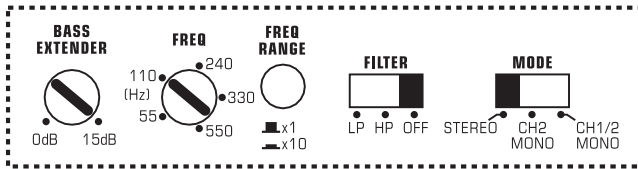
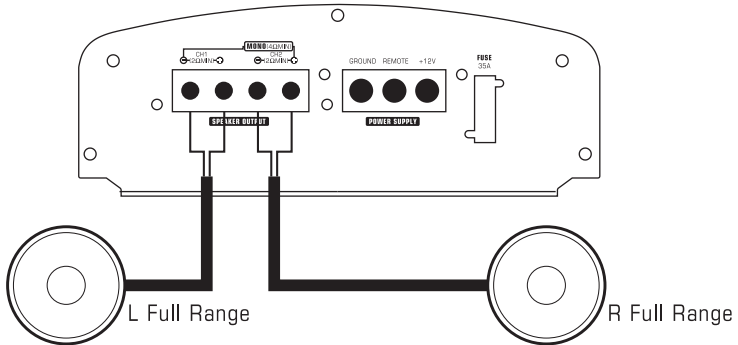

In this application, the amplifier is used in stereo and drives two full-range (or satellite or subwoofer) speakers. NOTE: A passive crossover must be used with satellite speakers.

APCLE-3002

Bridged - Mono Subwoofer System

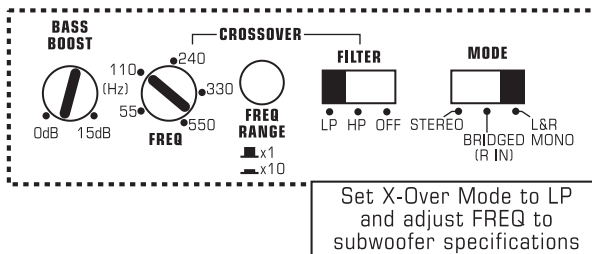
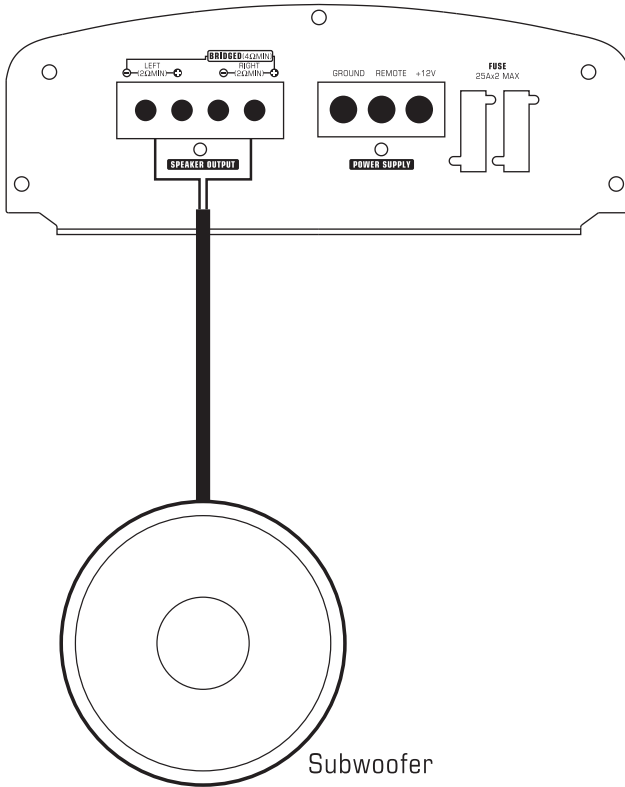

In this application the amplifier is bridged for mono operation to drive a subwoofer.

APCLE-3002

2-Channel Full-Range, Satellite, or Subwoofer Stereo System (Set INPUT SELECT Switch to STEREO)

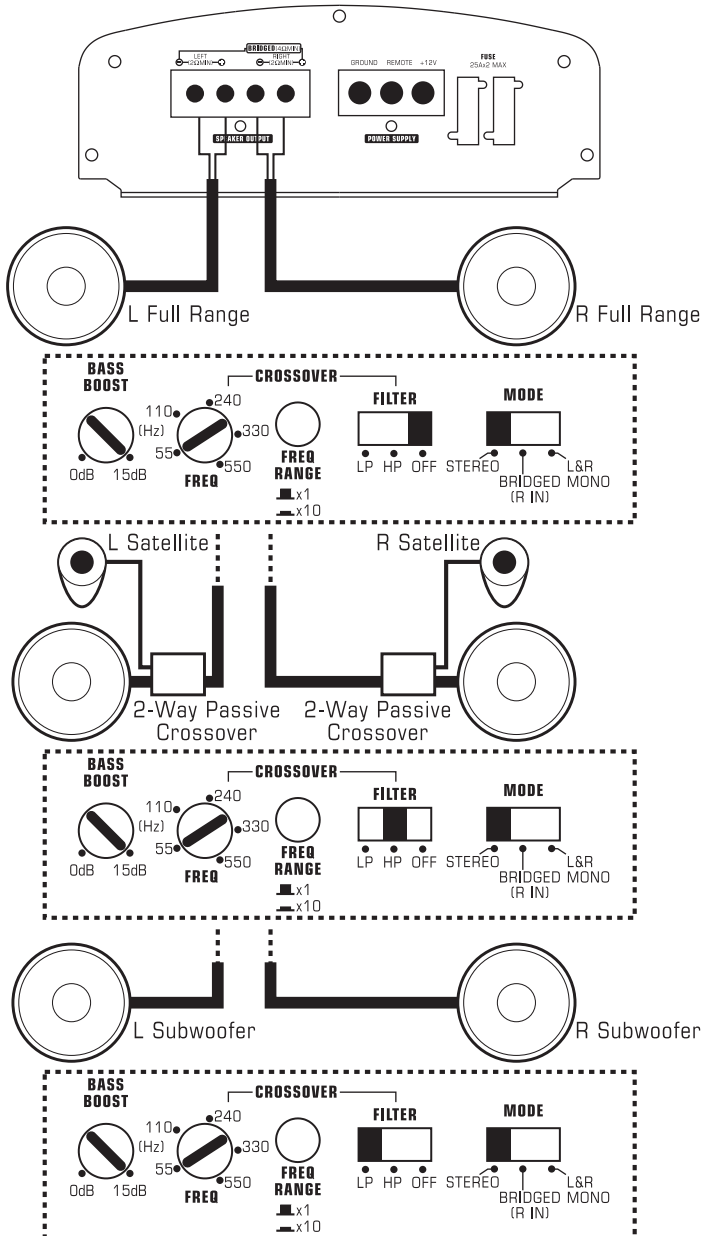

In this application, the amplifier is used in stereo and drives two full-range (or satellite or subwoofer) speakers. NOTE: A passive crossover must be used with satellite speakers.

SETTING THE GAIN

After completing the installation, follow these steps to set the Gain Control and then perform the Final System Checks.

1. Turn the Gain Control all the way counter-clockwise.
2. Turn the vehicle's Ignition Switch to the ON position. Then turn the ON/OFF Switch on the source units to the ON position. Set all Tone or Equalization Controls to "flat" positions and turn Loudness off.
3. Play a CD or Tape and set the Volume Control at 75% of full level. NOTE: If the system uses an equalizer, set its frequency controls to "flat" positions.
4. Slowly increase the Gain Control. Stop when you hear a slight distortion of audio.

SETTING THE Crossover

The Audiopipe APCLE-1002 / APCLE-2002 / APCLE-3002 features fully adjustable front and rear crossovers. To set the crossovers, follow these steps.

1. Using the X-Over Mode Switch, select the desired mode: LP for Low Pass, HP for High Pass or OFF for Full Range.
2. Using the Freq (Hz) Selection Control, select the desired frequency. If the desired frequency exceeds the range of the Freq (Hz) Selection Control, press the Crossover Frequency Multiplier Switch to increase the value by a multiplier of 10.
 - For example, 55Hz x 10 = 550Hz or 550Hz x 10 = 5.5kHz.
3. Repeat steps 1 and 2 for both the front and rear crossovers.

SETTING THE BASS BOOST

1. Initially set the Bass Boost control to its full left position (i.e. 0dB).
2. Listen to a variety of music styles (e.g. Rock, Rap, etc.) and slowly increase the Bass Boost control until a noticeable increase in low bass response is perceived.
3. Slowly adjust the Bass Boost control (up or down) to realize the best bass response.

CAUTION: If you hear a "pop" (due to speaker over-excursion), lower the Bass Boost to prevent speaker damage. If the system sounds muddy and distorted (due to amplifier clipping), lower Bass Boost to avoid shutdown from overheating.

FINAL SYSTEM CHECK

1. Start the engine and turn on the source unit. After a two-second delay, slowly increase the Volume Control and listen to the audio. If you hear any noise, static, distortion or no sound at all, check the connections, and also refer to Troubleshooting. Depending on your system design, the levels may become quite loud even at low Volume Control settings. Until you get an "audio feel" of the system's power, use care when adjusting controls.
2. Turn the Balance Controls to their extreme positions and listen to the results. Audio output should match control settings (audio from the left speaker when balance is left).
3. Increase the volume and verify that the amplifier reproduces audio (at full frequencies) without distortion. If you hear distortion, check the connections and verify that the Gain Control is set correctly. Another possibility is damaged speakers or under-powered speakers. Once again refer to Troubleshooting for additional help.

TROUBLESHOOTING

Problem

No Audio.

Solution

- *Low or no remote turn-on voltage. Check remote connections at amplifier and source unit.*
- *Blown amplifier fuse. Replace with new fast-blow fuse (same rating).*
- *Power wires not connected. Check battery and ground wiring at amplifier; also check battery connections.*
- *Speaker leads shorted. Check speaker continuity to ground, it should not show a common ground.*
- *Speakers not connected or are blown. Check speaker connections at amplifier, measure coil impedance.*

Problem

Audio cycles on and off.

Solution

- *Thermal protection circuits are shutting amplifier off. Check location for adequate ventilation; consult an authorized Audiopipe Dealer.*

Problem

Distorted audio.

Solution

- *Gain is not set properly, or damaged speaker cones. Review Setting Gain; inspect each speaker cone for signs of damage. (i.e. frozen cone, burning smell, etc.)*

Problem

Amplifier fuse keeps blowing.

Solution

- *Incorrect wiring or short circuit. Review Installation and check all wiring connections.*

Problem

Audio jacks punch.

Solution

- *Speaker wired incorrectly, which causes cancellation of bass frequencies. Check polarity of wires from amplifier to each speaker as defined by the system design.*

Problem

Whining or ticking noise in the audio with engine on.

Solution

- *Amplifier is picking up alternator noise or radiated noise. Turn down input gain; move audio cables away from power wires. Check power and ground connections on amplifier; install an in-line noise filter on source unit's power wire; check alternator and/or voltage regulator; test for weak battery or add water to battery.*

PRODUCT SPECIFICATIONS

APCLE-1002

Frequency Response	20Hz ~ 20kHz
Signal Noise Ratio	>95dB
THD05% all channels driven
Input Sensitivity Low Level	250mV ~ 2.5V
Input Sensitivity Speaker Level	500mV ~ 5V
Maximum Power Output	500W
Continuous Power Output	Stereo 2 Ch-50W x 2 @ 4 Ohm Stereo 2 Ch-100W x 2 @ 2 Ohm Bridge 1 Ch-200W x 1 @ 4 Ohm
Dimensions	(H)55 x (W)176 x (L)224 mm

APCLE-2002

Frequency Response	20Hz ~ 20kHz
Signal Noise Ratio	>95dB
THD05% all channels driven
Input Sensitivity Low Level	200mV ~ 6V
Input Sensitivity Speaker Level	1V ~ 20V
Maximum Power Output	1000W
Continuous Power Output	Stereo 2 Ch-100W x 2 @ 4 Ohm Stereo 2 Ch-125W x 2 @ 2 Ohm Bridge 1 Ch-300W x 1 @ 4 Ohm
Dimensions	(H)55 x (W)176 x (L)260 mm

APCLE-3002

Frequency Response	20Hz ~ 20kHz
Signal Noise Ratio	>95dB
THD05% all channels driven
Input Sensitivity Low Level	200mV ~ 8V
Input Sensitivity Speaker Level	1V ~ 20V
Maximum Power Output	1500W
Continuous Power Output	Stereo 2 Ch-150W x 2 @ 4 Ohm Stereo 2 Ch-300W x 2 @ 2 Ohm Bridge 1 Ch-600W x 1 @ 4 Ohm
Dimensions	(H)55 x (W)176 x (L)382 mm