

INSTALLATION INSTRUCTIONS

3 3/8" & 5" ELECTRIC QUAD GAUGES

2650-1178-00 Rev. A



Mounting

Mount a 3 3/8" gauge in a 3 3/8" dia. hole and a 5" gauge in 4 5/8" dia. hole in the dashboard. Fasten with brackets supplied as shown. **(Electrical wire for installation not included.)** To assure proper functioning of this instrument, please read instructions thoroughly before installing.

NOTE: Some late model vehicles use electronic sensors in their pressure and temperature senders for engine control functions. Before removing the original sender, we recommend that you contact your automotive dealer to be sure no critical functions will be disrupted. With pressure gauges it is beneficial to add a T-fitting to install your new gauge and to keep the warning light operational. This allows you to monitor the pressure and still have a warning light to indicate emergency conditions. The ground, fuel sender, temperature sender, and oil sender wires should be routed through fire wall using the supplied grommet.

3 3/8" Models

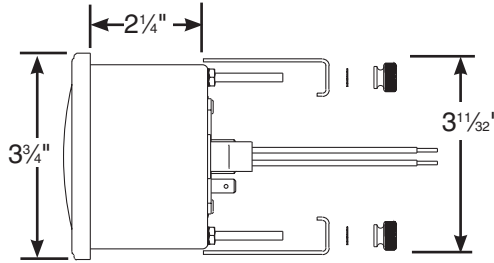

5" Models

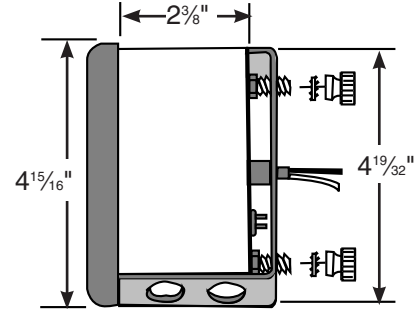

Step 1

1. Disconnect negative (-) battery cable.

CAUTION:

Do not touch ignition wire to the sender terminal on back of gauge or the sender will be damaged.

Step 2

Fuel Level

1. Gauge connects to 240-33 ohm fuel sender (3262), supplied in Quad gauge/Speedometer kit. Sender is **not included** in individual Quad gauges. The 3262 or comparable 240-33 ohm sender will be required. Route proper length of 18 gauge wire from fuel tank to gauge. Connect one end to terminal post on fuel level sender and the opposite end to the spade terminal labeled "FUEL" on back of gauge. See illustration.

NOTE: The Quad gauge will not operate with any other resistance range and cannot be modified to do so

CAUTION!

As a safety precaution the Red wire of this product should be fused before connecting it to the positive (+) side of the 12V DC battery. We recommend using a 4 Amp, 3AG fast-acting type cartridge fuse (Littlefuse® # 312 004 or an equivalent) inline with the Red wire of our product.

Install grounded wire to sender flange screw for proper operation

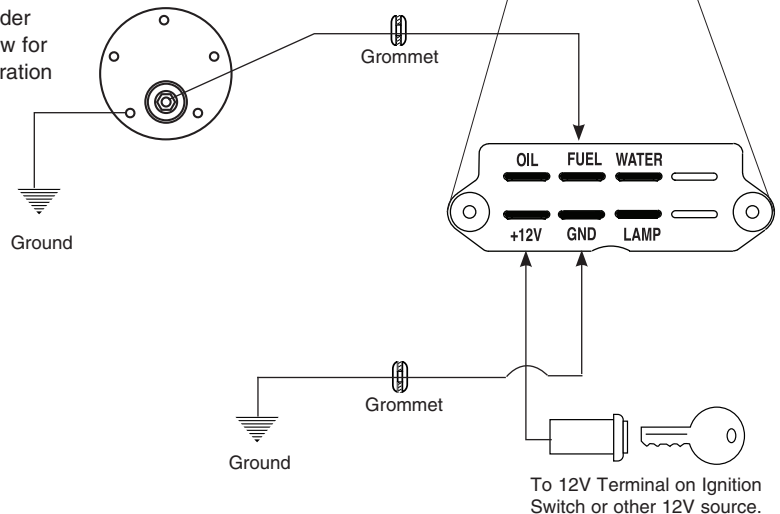
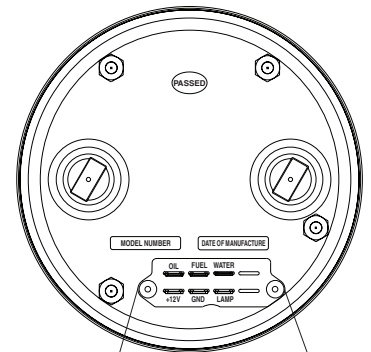
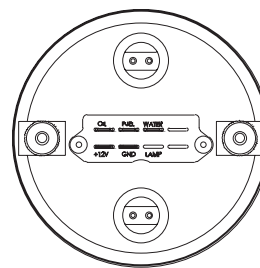

Step 3

Voltmeter

1. Using 18 gauge wire, route wire through firewall using grommet. Attach one end to the negative GND (-) spade terminal on back of gauge, and the opposite end to a good engine ground. See illustration at right.
2. Attach one length of wire to the positive +12V spade terminal on back of gauge and opposite end to +12V terminal on ignition switch or other switched +12V power source.

NOTE: Hook up of the voltmeter powers the quad gauge. Not hooking up these wires will result in the other gauges not working.

CAUTION:

Do not touch ignition wire to the sender terminal on back of gauge or the sender will be damaged.

Step 4 Water Temperature

1. Install water temperature sender. Remove stock sender for water temperature indicator light and install new sender.
Sender should automatically be grounded when installed. If not, proper ground connections should be made.

2. Route 18 gauge wire through firewall using grommet. Connect one end to the terminal post on sender and opposite end to spade terminal labeled "WATER" on back of gauge. See illustration below.

Includes No. 2258 sender with 1/8" NPT thread size, 3/8" NPT, and 1/2" NPT bushings. Hose adapters and metric adapters sold separately.

3 3/8" Models

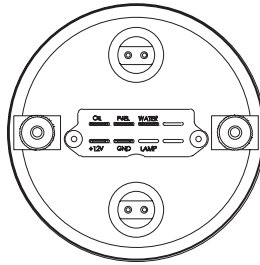

TEMPERATURE SENDER

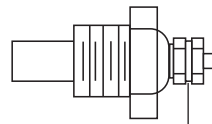

Grommet

CAUTION!

As a safety precaution the Red wire of this product should be fused before connecting it to the positive (+) side of the 12V DC battery. We recommend using a 4 Amp, 3AG fast-acting type cartridge fuse (Littlefuse® # 312 004 or an equivalent) inline with the Red wire of our product.

5" Models

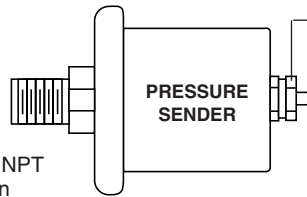
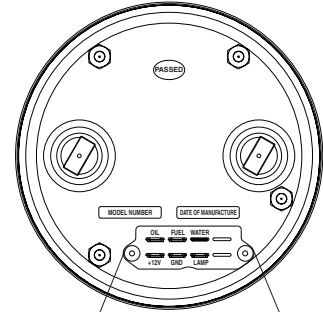

PRESSURE SENDER

Grommet

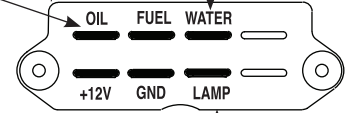

CAUTION:

Do not touch ignition wire to the sender terminal on back of gauge or the sender will be damaged.

Step 5 Oil Pressure

No. 2242 for Domestic Cars with 1/8" NPT Outlet. Ford uses 1/4" NPT Adapter included.

1. Remove stock sender for dash warning light and install gauge adapter. Sender fits 1/8" NPT and comes with 1/4" NPT adapter. Sender should automatically be grounded when installed. If not, proper ground connections should be made.
2. Route 18 gauge wire through firewall using grommet. Connect one end to terminal post on pressure sender, and opposite end to the spade terminal labeled "OIL" on back of gauge. See illustration above.

NOTE: Sender should be remotely mounted on high vibration applications to prevent premature failure of the sender.
If remote mounting we recommend #3227 stainless steel hose kit.

CAUTION:

Do not touch ignition wire to the sender terminal on back of gauge or the sender will be damaged.

Step 6 Lighting (3 3/8" models only)

1. Connect white wire to dash lighting or to other +12V power supply. Connect black wires to negative ground source.

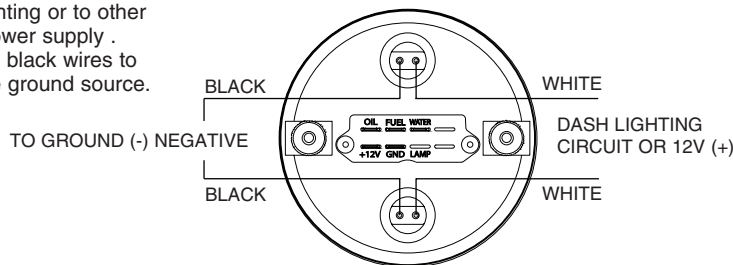

Lighting (5" models only)

1. Connect one wire to dash lighting circuit or to other 12V power source and opposite end to spade terminal labeled "LAMP" on back of gauge.

Dash lighting or +12V power supply

5" models only

Step 7

1. Reconnect negative (-) battery cable.