

# INSTALLATION INSTRUCTIONS

2650-1142



## Tach Calibration with Wire Loops

- 8 Cylinder:** No adjustment necessary.
- 6 Cylinder:** Clip BROWN wire loop only. Insulate with electrical tape.
- 4 Cylinder:** Clip BROWN and ORANGE wire loops. Insulate with electrical tape.
- Model 4594 only:** After clipping necessary wire(s) and insulating them, push wires into hole and use the hole plug to seal the hole.

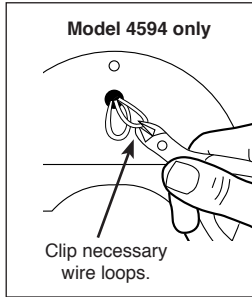
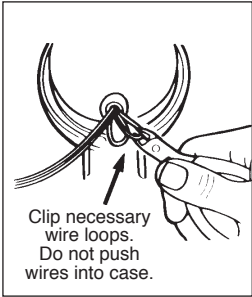

## Tach Calibration with Switches

The switch to change tachometer calibration is inside the tachometer and is accessible via the light hole on the back of the tachometer. The switch is located to the left of the light socket. Adjust switch with a small screw driver or unwound paper clip.

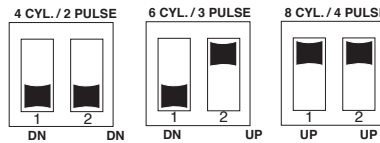

- 8 CYL:** Both switches up.
- 6 CYL:** Switch One down, Switch Two up.
- 4 CYL:** Both switches up.

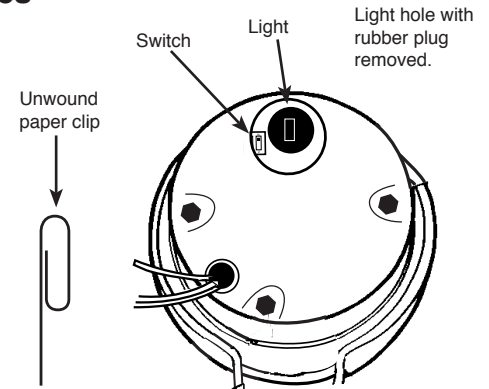

## MOUNTING

### In-Dash Tachs

- Cut a 3 $\frac{3}{8}$ " dia. hole in the dashboard for the tachometer.
- Drill a  $\frac{3}{8}$ " dia. hole in the firewall where the tachometer wires will be routed. Place rubber grommet in hole and route the green and black wires through to the engine compartment.
- Connect the tachometer wires as shown in this instruction.
- Secure the tachometer in the dashboard using the brackets, nuts and lockwashers provided.

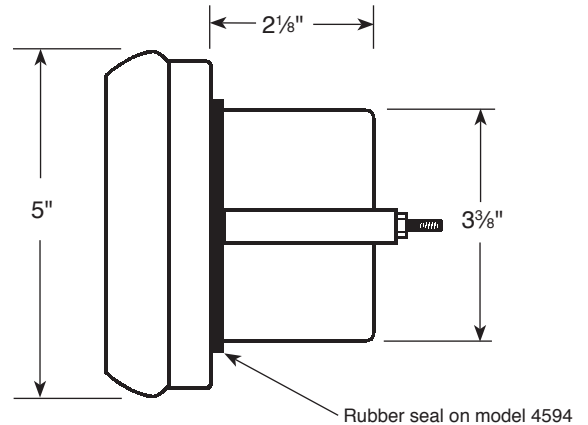

### Pedestal Tachs

The special design of the tachometer base allows for a variety of mounting possibilities. Loosening the hex screws at the mounting base allows the tachometer to be rotated in the shock strap. This will also allow the tachometer face to be angled forward or backward for better viewing. Attach the base using screws provided or some other means, such as pop riveting.

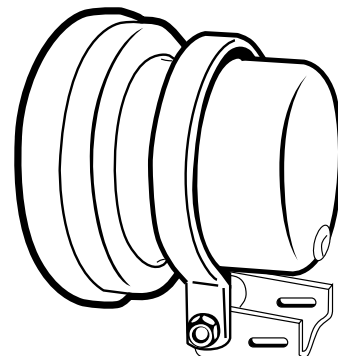

# REMOTE MEMORY SWITCH

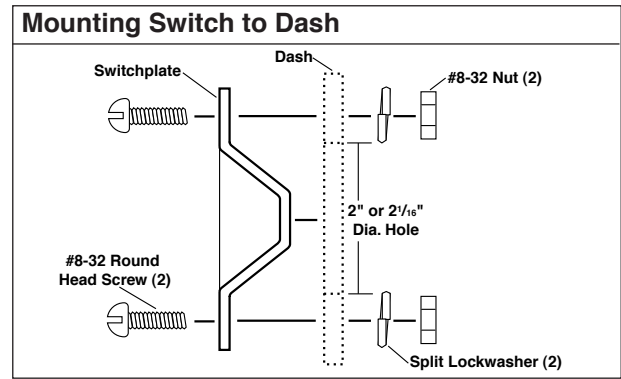
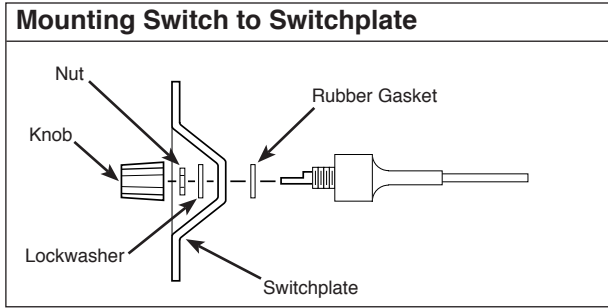

# REMOTE MEMORY FEATURE

Memory tachometers record the highest RPM reached during each race. This memory feature operate as shown below.

## Use As Tach

Race with the switch in "TACH" position. The tach will function as normal to monitor engine RPM.

## Recall RPM

Switch to "RECALL" to display peak RPM. This can be done during or after a race. To clear for next race, see Erase Memory step.

## Erase Memory

Switch to "ERASE" mode before each race. This clears previous runs from the memory. Recording will begin when switch is returned to TACH mode.

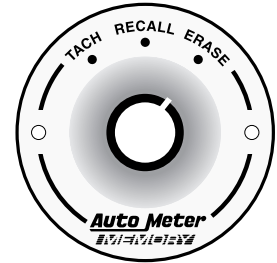
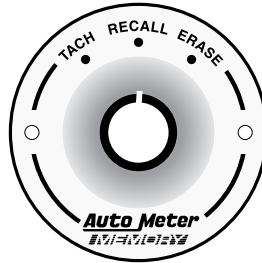
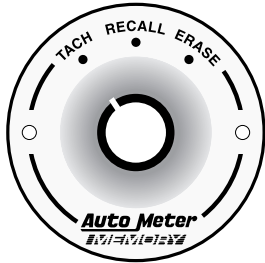

# TACH FACE MEMORY CONTROLS

Memory tachometers record the highest RPM reached during each race. This memory feature operates as follows.

ERASE MEMORY: Push "ERASE" button before each race. This clears the memory from the previous runs. You are now ready to record.

RECALL RPM: Push "RECALL" button to display the highest RPM reached.

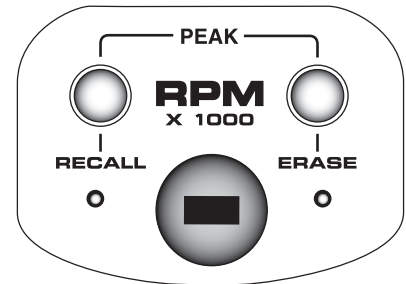

# LIGHT REPLACEMENT

## LIGHT REPLACEMENT FOR 5" TACHS

Rotate twist-lock socket counterclockwise and remove. Replace the old bulb with Auto Meter No. 3218 or GE86 Bulb.

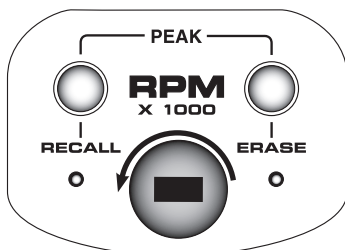

## LIGHT REPLACEMENT FOR 3 3/4" TACHS

Remove rubber plug. Rotate twist-lock socket counterclockwise using needle nose pliers and remove. Replace old bulb with Auto Meter NO. 3206 or GE 194 bulb.

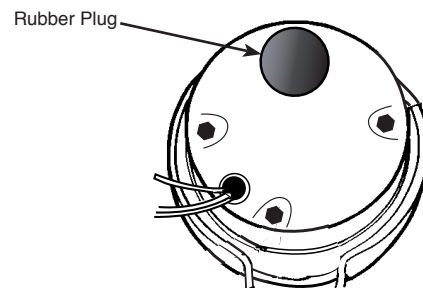

# WIRING

Connect the tachometer wires as shown below. All wires passing through firewall should be routed through the rubber grommet provided. If splice connector is used be sure to make the connection inside the car's driving compartment.

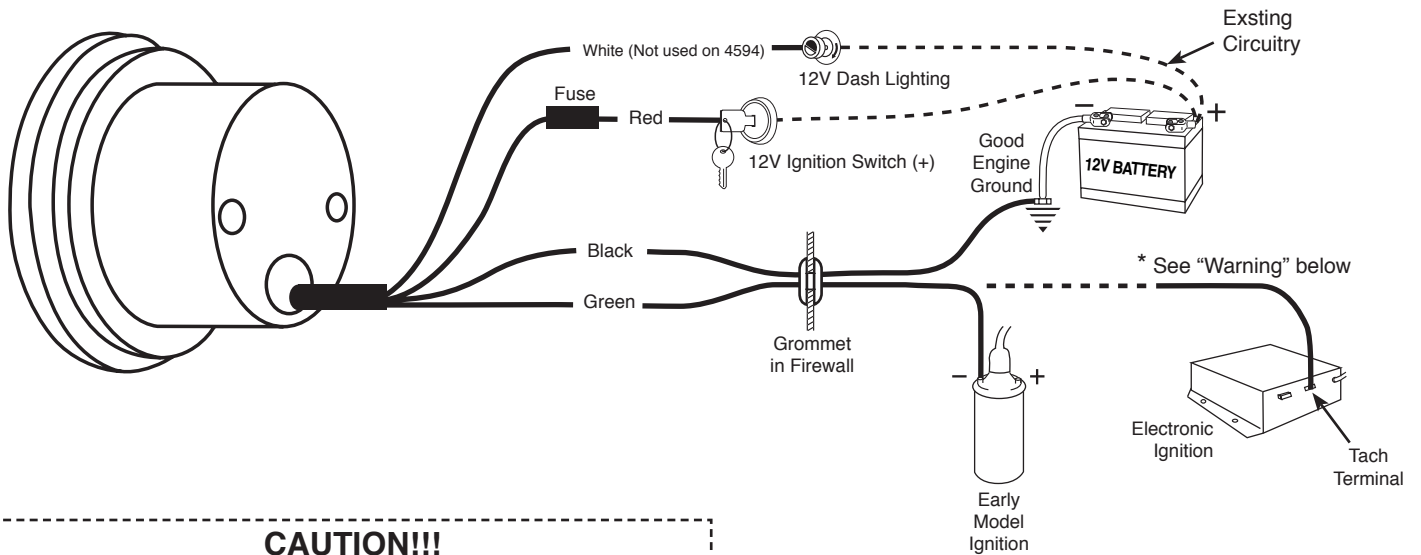

## CAUTION!!!

As a safety precaution the RED wire of this product should be fused before connecting it to the positive (+) side of the 12V DC battery. We recommend using a 1 Amp, 3AG fast-acting type cartridge fuse (Littlefuse® #312 001 or an equivalent) inline with the RED wire of our product.

**NOTE:** This tachometer operates on standard factory electronic and high performance electronic racing ignitions, such as Hy Fire and MSD. (This tachometer is **NOT** recommended for use on Accel BEI or Laser I & II ignitions.)

**Note (Model 4594 only):** The glow in the dark coating on the dial of this gauge may turn gray if exposed to direct sunlight for extended periods of time. When the car is not being used and will be in direct sunlight for a long time, place the provided red plastic cover on the gauge.

## WARNING

Warranty will be void if connected to coil when using an aftermarket ignition box such as, but not limited to products from the following manufacturers: MSD, Crane, Jacobs, Mallory, Holley, Etc.. Prior to installation of your tachometer, check with the ignition box manufacturer for recommended tachometer signal location.

\* See [autometer.com/tech\\_installation.aspx](http://autometer.com/tech_installation.aspx) for specific vehicle information.