



# Remy

®

**With PM TEST  
AGM Compatible**

U.S. Patent No.

6,061,638

6,359,442

D442,503

6,771,073

VDROP is a  
trademark of  
Auto Meter Products



Engineered &  
Manufactured by



## **BCT-200J** Instruction Manual

**Battery Load, Charging System, Starting System and  
Voltage Drop Tester for Truck Maintenance  
Optional J1708 Hookup**

Complement your battery testing with complete system test including a voltage drop test that measures the voltage drop of the starting and charging circuit. The BCT-200J is automated and menu driven with simple hook-up methods for testing the negative and positive legs in one operation. Special tests are included for the magnetic switch circuit.

# CONGRATULATIONS!

You have purchased one of Auto Meter's hand-held Voltage Drop Analyzers. It is designed to test each circuit of a trucks starting and charging circuit with speed and accuracy. If you should have any questions about your tester or the testing procedures please see back cover for contact information.

## BCT-200J

Test Capacity .....	120 Amp algorithmic load
Battery sizes .....	200-1600 CCA
Digital Display with backlight...	1" x 2.5" - 4 line x 16 character
Volt Ranges.....	Digital 0-40V
Cooling.....	Vented
Load Clamps.....	4 ft., 6 Gauge
External Leads.....	20ft 16 Gauge
Size .....	6" x 9 1/2" x 1 7/8"
Memory .....	stores the last 80 tests
Internal Battery.....	9 Volt Alkaline
Post Adapter Kit .....	For group 31 batteries
<i>Optional AC-25</i> .....	6 pin to 9 pin J1708 Adapter
<i>Optional AC-26</i> .....	J1708 Cable
<i>Optional PR-15</i> .....	Infrared printer
<i>Optional AC24J</i> .....	carrying case
<i>Optional AC-10</i> .....	PC Interface adapter cord
<i>Optional AC-27</i> .....	Alternator Adapters
<i>Optional AC-35</i> .....	PC download program
Weight.....	4.27 lbs.

## What to Expect from the BCT-200J:

***Immediately recognize a bad battery. Also perform a complete voltage drop test analysis on 12 and 24 Volt systems.*** Load test 12 Volt batteries, load a 12 Volt alternator and do a check on a 24 Volt alternator. The BCT-200J is a portable full-featured menu-driven battery tester and voltage drop tester that provides quick, professional load results using Auto Meter's advanced algorithmic load. The BCT-200J has the option of using a J1708 cable. It is professionally accurate and detailed test results are LCD displayed after each test and can be reviewed and printed from memory.

**CAUTION: The BCT-200J grill may get hot after repeated use. Be sure to hold the unit from the side grips only. Keep hands away from the grill.**

# SAFETY

- Carefully read all operating instructions before operating the BCT-200J
- Wear eye protection when working on batteries.
- Be sure each test is complete before removing load clamps to prevent arcing and potential explosion from battery gases. Never remove load clamps while testing. Keep sparks, flames or cigarettes away from battery.
- Keep hair, hands, and clothing as well as tester leads and cords away from moving blades and belt.
- Provide adequate ventilation to remove exhaust.
- In extremely cold temperatures check for frozen electrolyte fluid or swelled case before applying load. Do not attempt to Load Test or charge a battery under 20° F. (-7°C.). Allow the battery to warm to room temperature before testing or charging.
- **Warning!** BCT-200J can only be attached to a Delco Remy Bench Tester and used in prescribed manner. It should never be attached to any other tester or charging unit. Damage may result.



**Wear  
Safety  
Glasses**

## WARNING!

### TESTING OF HYBRID VEHICLES

**DO NOT** test the starter, alternator and/or 12 volt starting battery while it is in the vehicle.

**DO NOT** remove, service or test the hybrid battery pack under any circumstances.

**Remove** the 12 volt starting battery, starter or alternator from the vehicle prior to testing.

# CAUSE OF BATTERY FAILURE

- **Incorrect Application:** Wrong size battery may have inadequate cold cranking rating for original vehicle specifications.
- **Incorrect Installation:** Loose battery hold-downs cause excessive vibration, which can result in damage to the plates.
- **Improper Maintenance:** Low electrolytic fluid and corrosion on battery connections can greatly reduce battery life and effect battery performance.
- **Internal Connections:** Make sure internal connections of entire charging system meet proper specifications.
- **Age of Battery:** If the date code on the battery is old, test failure may indicate the need of replacement.
- **Overcharging:** Overcharging caused by a high voltage regulator setting or incorrect battery charging can cause excessive gas, heat and water loss.
- **Undercharging:** Undercharging caused by a faulty charging system or low voltage regulator setting can cause lead sulfate to gradually build up and crystallize on the plates, greatly reducing the battery's capacity and ability to be recharged.
- **Cycling:** Excessive drain on battery when alternator is not operating.

# INSPECTION

Valid automotive electrical system testing depends on all the components being in good operating condition. In addition, the battery MUST have sufficient charge for testing. Carefully perform the following before attempting electrical diagnosis.

## VISUAL CHECK

- **Inspect Battery** for terminal corrosion, loose broken posts, cracks in the case, loose hold-downs, low electrolyte level, moisture, and dirt around the terminal.

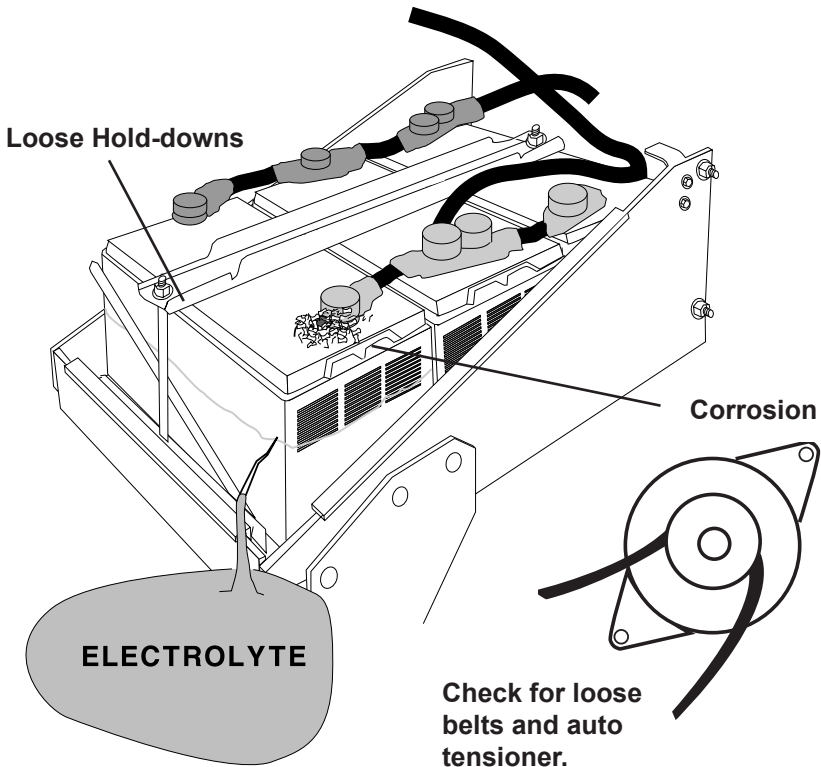

- **Important Note:** *A known defective battery must be replaced before proceeding with any test on the charging or starting system.*
- **Inspect Belts** for cracks, glazed surface and fraying. Tighten loose belts. Inspect auto-tensioner for proper belt tension.
- **Inspect Starting System.** Check starter, solenoid, and alternator for loose connections, loose mounts and frayed or cracked wires.

# CONTROLS AND FUNCTIONS

## LCD:

Displays menus and test results.

## KEYS:

When each key is pressed, a beep sounds to assure contact has been made.

### On/Off Key:

This is the manual on/off key.

### Y Enter Key:

This key selects the next menu, the cursor line item and answers 'yes' to a test progression.

### +Up Key:

This key moves the cursor up in order to select a menu line item. It also increments a value.

### -Down Arrow Key:

This key moves the cursor down in order to select a menu line. It also decrements a value.

### N Esc Key:

This key cancels a test or progression. It also returns to the previous menu.

### Print Key:

When the BCT-200J is pointed toward or at the optional PR-15 printer, pressing the print key will cause the test results to be printed.

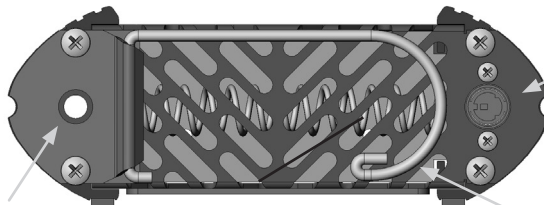
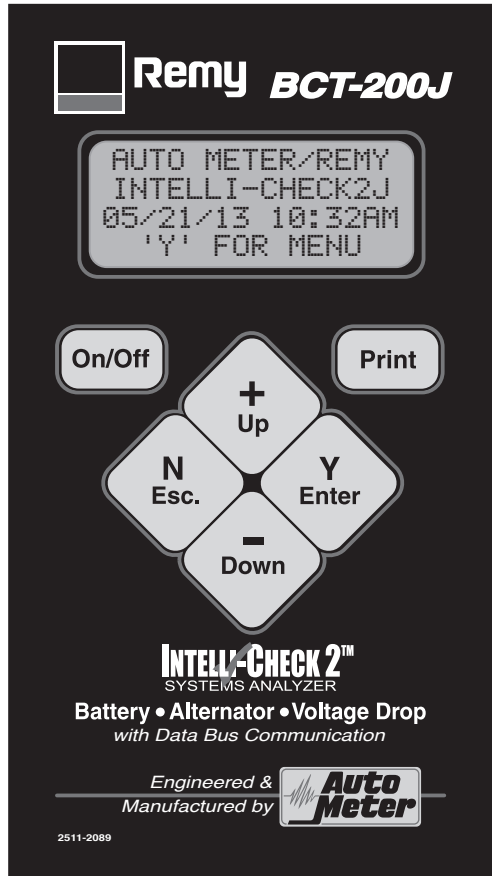

### Infrared Print Light:

Data is sent to the infrared printer when the print button is pressed.

### J1708 and PC Download Jack:

Adapter cord inserts here.

### Retractable Hanging Hook:

Hang unit at various points to free hands for clamp attachment.

# 2

## BATTERY BANK TEST

**NOTE:** When performing a PM Test the tester will automatically run the Battery Bank Test to make sure that the battery bank passes. Therefore, you need only use the Battery Bank Test for testing the battery bank only. The Battery Bank Test is designed for preventative maintenance only. If there is an electrical problem you should test each battery individually.

```
>ENTER NUMBER OF  
BATTERIES: 3  
USE +/-.  
'Y' TO CONTINUE
```

You will be asked to enter the number of batteries in the system. The number selected in the last test will appear. Simply use the (+) or (-) key to select the correct number. Then press ('Y' Enter) to continue.

```
>INSPECT BANK FOR  
DIRT, LEAKS OR  
CRACKS.  
'Y' TO CONTINUE
```

```
>INSPECT POSTS  
AND CONNECTIONS  
'Y' TO CONTINUE
```

Always check batteries, battery posts and connections before testing the batteries. If the batteries or posts are damaged replace the batteries. Make sure the batteries are free from dirt, cracks and leaks and that the connections are clean and secure.

## BATTERY BANK (Cont.)

```
>CONNECT LARGE  
LEADS TO THE  
BATTERY BANK  
'Y' TO CONTINUE
```

You will be instructed to connect the large leads. Connect the red clamp to the main positive cable coming to the bank and the black clamp to the main negative cable leaving the bank.

```
>BANK MUST BE  
STABILIZED FOR  
VALID RESULTS  
'Y' TO CONTINUE
```

For the most accurate and repeatable tests always allow the batteries to stabilize for at least 10 minutes after being charged or loaded before running a test.

Black Clamp at Negative Main

Red Clamp at Positive Main

Connect large alligator clips as far apart as possible.



Battery Bank of 3 Batteries

```
>ENTER BATTERY  
TEMP. 70F.  
12.39V  
'Y' TO CONTINUE
```

Using the (+) or (-) key adjust the temperature in units of 10 degrees. This should be the temperature of the battery(S). Consider where the vehicle has been before adjusting.

```
>ENTER BATT TYPE  
AGM USE +/-  
12.39V  
'Y' TO CONTINUE
```

Use the (+) or (-) key to select the battery type, either AGM or regular lead-acid.

```
>ENTER SINGLE  
CCA 650  
12.39V  
'Y' TO BEGIN
```

Using the (+) or (-) key adjust the CCA of an individual battery. If each battery varies in CCA approximate an average. If the CCA is unknown consider that most truck batteries range from 625-950 CCA.

```
TESTING BANK  
PLEASE WAIT...
```

Press (Y Enter) to begin the test and wait for results. Example is at the top of page 10 (Individual Battery Test).

# 3

## INDIVIDUAL BATTERY TEST

```
#211 12V BANK  
GOOD BATTERIES  
12.70V CHRG 100%  
11.50V LOADED
```

When the test results appear as GOOD BATTERIES after running the PM Check or Battery Bank Test there is no need to run the individual battery tests. Press (N Esc.) to return to the menu

```
#211 12V BANK  
TEST SEPARATELY  
12.38V CHRG 66%
```

If the battery bank test results are low you will be instructed to test each battery separately. Press (Y Enter) to continue.

```
PM TEST  
>BATTERY TEST  
BATTERY BANK  
VDROP TEST
```

Select BATTERY TEST from the main menu.

```
>INSPECT BATTERY  
FOR DIRT, LEAKS  
OR CRACKS  
'Y' TO CONTINUE
```

Always check for dirt and cracks or leaks in the battery.

```
>INSPECT POSTS  
AND CONNECTIONS  
'Y' TO CONTINUE
```

### **IMPORTANT**

Poor connections may be the reason for battery bank failure. Clean posts and connections are essential when checking each battery. Make sure batteries not being tested are disconnected.

**Note!** When testing batteries individually each battery should be disconnected. Avoid improper results and damage to the posts by using the included post adapters on threaded post batteries.

```
>CONNECT LARGE  
LEADS TO THE  
BATTERY.  
'Y' TO CONTINUE
```

Connect the large red clamp to the positive and the large black to the negative battery terminal. If the clamps are connected improperly you will be prompted to correct the problem. The tester will then revert back to the beginning or main menu. Be sure to use post adapters on threaded steel posts as illustrated on the next page then press (Y Enter).



# INDIVIDUAL BATTERY TEST (Cont.)

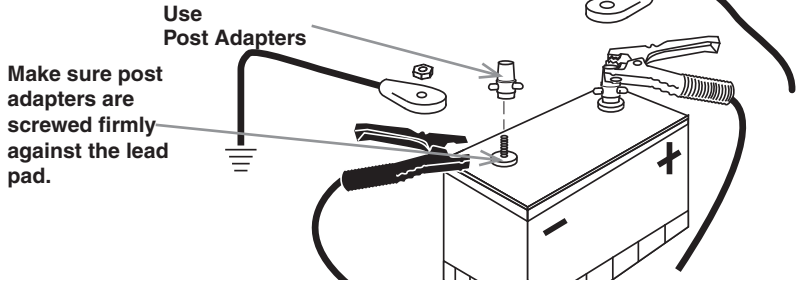

```
>ENTER BATTERY  
DATE CODE: A4  
USE +/- . 01/04  
'Y' TO CONTINUE
```

The prompt only appears if the user requests it in the SETUP. The first letter should be flashing, this is the month. Using the (+) or (-) adjust the month, then press enter. the year will then flash use the (+) or (-) to select the correct year. 'Y' to continue.

```
>ENTER BATTERY  
TEMP. 70F.  
12.39V  
'Y' TO CONTINUE
```

Using the (+) or (-) key adjust the temperature in units of 10 degrees. This should be the temperature of the battery.

```
>ENTER BATT TYPE  
AGM USE +/- .  
12.39V  
'Y' TO CONTINUE
```

Use the (+) or (-) key to select the battery type, either AGM or regular lead-acid.

```
>ENTER RATED CCA  
650  
12.39V  
'Y' TO BEGIN
```

Using the (+) or (-) key adjust the CCA of the battery. Press (Y Enter) to begin test.

```
TESTING BATTERY  
PLEASE WAIT...
```

Wait for results.

There are five test results which are explained in detail on Pg. 12

Make sure they are correct when done.

```
#220 12V BATTERY  
GOOD NEEDS CHRG.  
12.28 CHARGE 54%  
EST CCA 840
```

## **FIVE TEST RESULTS**

### **GOOD BATTERY**

- The battery has passed the load and capacity tests and is at a high enough state of charge to continue all electrical test or operate.

### **MARGINAL BATTERY**

- The battery has lost capacity and should be replaced if in a critical or harsh situation.

### **BAD BATTERY**

- The battery was at a high enough state of charge to test and failed. Replace battery.

### **GOOD, NEEDS CHARGING**

- Battery tested good, however it needs to be charged before going into operation, normal vehicle operation might not charge this battery(s). All batteries need to leave the repair facility at or near 100% state of charge for good electrical performance.

### **CHARGE AND TEST**

- The battery is at a low state of charge and can not be accurately tested unless it has been charged, Depending on the charger model, several hours may be needed to fully recharge and be ready to test.

# 4

## CHARGING CABLE VDROP™ TEST

### ALTERNATOR HOOKUP

Red to Positive

Black to Ground

Connect the large leads to the alternator pos. on output terminal and neg. on case.

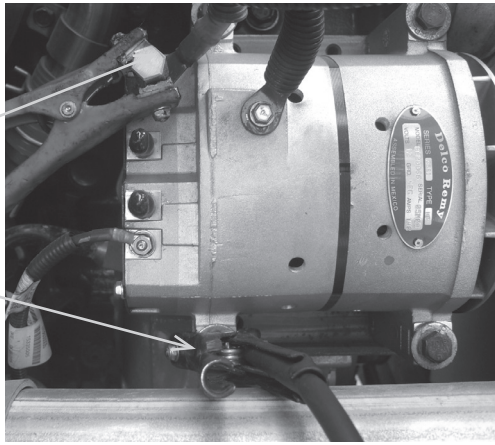

```
>CONNECT SMALL  
LEADS TO THE  
BATTERY  
'Y' TO BEGIN
```

Connect the small leads to the battery bank - the red on the positive main and the black on the negative main and not to an individual battery. The added small external leads will check the cables before the alternator is tested. This is the individual VDrop Test

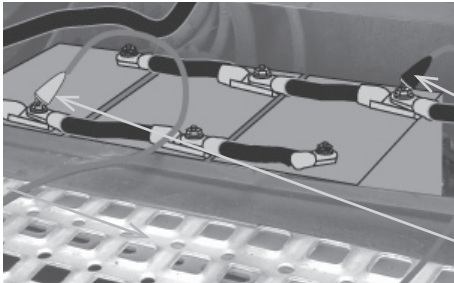

Black Clamp at Negative Main

### BATTERY HOOKUP

Red Clamp at Positive Main

```
PM TEST  
BATTERY TEST  
BATTERY BANK  
>VDROP MENU
```

This same test and hookup can be run individually by selecting VDrop Menu

```
>CHARGING CABLES  
STR MAIN CABLES  
MAG. CIRCUIT  
LIFEGATE VDORP
```

...and then Charging Cables.

# CHARGING CABLE VDROPTM (Cont.)

LOADING  
PLEASE WAIT...

The Charging System Test performs this individual VDrop Test before allowing you to test the alternator's output.

If all connections are correct press (Y Enter) to begin VDrop Test. Wait for a load to be applied.

#7 CHRGR CABLES  
PASSED @ 130A  
GOOD TO 192A  
0.15POS 0.19NEG

#8 CHRGR CABLES  
OUT OF SPEC @  
135A GOOD TO 123A  
0.16POS 0.46NEG.

The results will vary depending upon the conditions of the cables. Both the positive and negative circuit results will be indicated. If the test does not pass, correct the connection or replace the cable and run the test again. The BCT-200J will automatically resume the test after it is disconnected. Just answer 'YES' when prompted.

## Determining if the charging circuit is a "single" or "dual" system

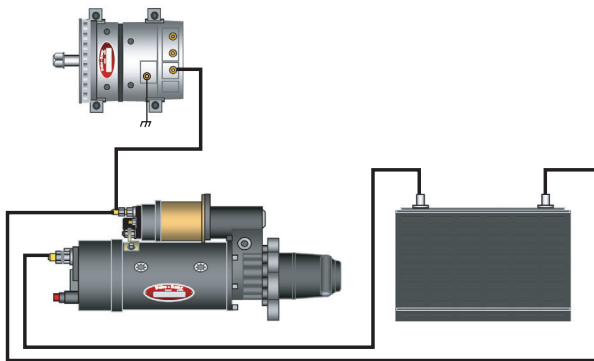

Single has one cable from the alternator output terminal.

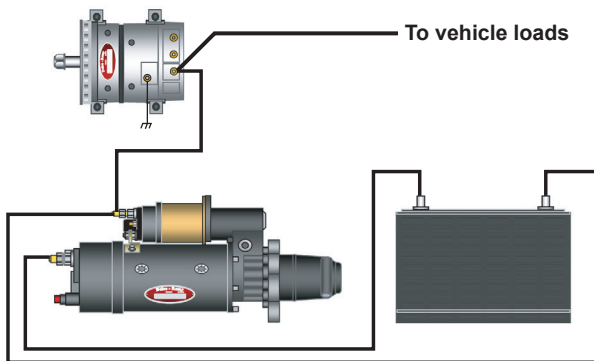

Dual system has two cables attached to the output terminal. Every load that the tractor and trailer utilize must be subtracted from the amount of current that can go to the batteries.

# CHARGING CABLE VDROPTM (Cont.)

## VDROP ERROR MESSAGES

One of the following may appear during any drop test sequence. Correct the situation before continuing.

```
ERROR:
LARGE LEADS
NOT CONNECTED
'Y' TO CONTINUE
```

One or both of the large leads are not connected.

```
ERROR:
BAD CONNECTION
ON LARGE LEADS
'Y' TO CONTINUE
```

Tester detected that one of the large leads does not have a good connection.

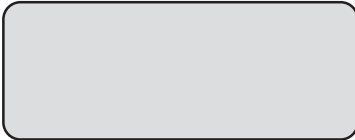

Tester detected that the large black lead is not connected properly

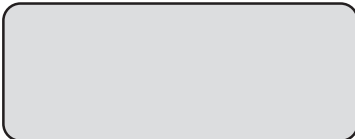

Tester detected that the large red lead is not connected properly

Note: On the large leads, both sides of the jaws must make a good connection

```
ERROR:
SMALL LEADS
NOT CONNECTED
'Y' TO CONTINUE
```

One or both of the small external leads is not connected

```
ERROR:
SMALL LEADS
REVERSED
'Y' TO CONTINUE
```

The tester detected that the small leads are hooked up backwards the tester should also beep when it occurs

# 5

## STANDARD ALTERNATOR OUTPUT TEST

After the battery or batteries have been tested and were good (or have been replaced) and after the charging cables have been tested and were good (or were repaired or replaced) you may proceed to test the alternator.

```
BATTERY TEST  ↑
BATTERY BANK
VDROP TEST
>ALTERNATOR  ↓
```

This test can also be selected from the main menu by selecting Alternator Test then press (Y Enter).

```
>INSPECT BELT
CONDITION.

'Y' TO CONTINUE
```

If the unit is setup to require visual checks you will be asked to inspect belt condition...

See picture below  
...and tension.

```
>INSPECT BELT
TENSION.

'Y' TO CONTINUE
```

```
>INSPECT CABLES
AND CONNECTIONS

'Y' TO CONTINUE
```

Inspect cables and connections before alternator rating is entered.

```
CONNECT LARGE LEADS
TO THE ALTERNATOR

'Y' TO CONTINUE
```

Red to output terminal and Black to ground / case output adapters recommended.

```
CONNECT LARGE LEADS
TO THE ALTERNATOR

'Y' TO CONTINUE
```

Check the alternator tag or housing and use the +/- key to select the rated output



# STANDARD ALTERNATOR OUTPUT TEST (Cont.)

DOES ALTERNATOR  
HAVE A  
REMOTE SENSE?  
'N' OR 'Y'

See photo of non remote sense  
alternator below "N" for  
Non-remote sense alternator

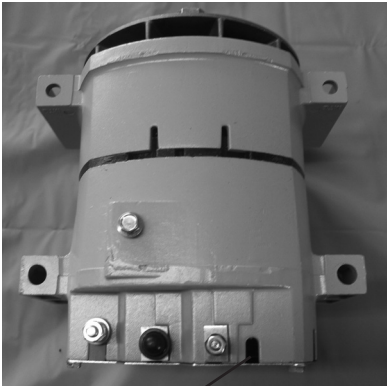

Non Remote Sense (empty port)

Non Remote Sense Alternator



DOES VEHICLE HAVE  
J-1708 DATA PORT?  
'N' OR 'Y'

If vehicle is equipped with a J-1708  
port and you have the optional  
cable. Select "Y". If vehicle is not  
equipped with J-1708 data port or  
you don't have an optional J-1708  
cable select "N"

If NO skip the next two steps.

>ATTACH J-170  
DATA CABLE  
'N' TO CANCEL

Attach the cable from the tester to  
the data port on the vehicle.

NOTE: if the tester does not detect it  
is hooked to the data port it will not  
go beyond this screen.

TURN IGNITION  
SWITCH ON

Once it detects it is hooked up  
properly it will prompt you to turn  
the ignition key to the run position.

# STANDARD ALTERNATOR TEST RESULTS

```
>CONNECT R CLIP  
TO THE R TERM  
ON ALTERNATOR  
'Y' TO CONTINUE
```

Connect the single alligator clip from the AC-26 J1708 cable to the R terminal on the alternator.

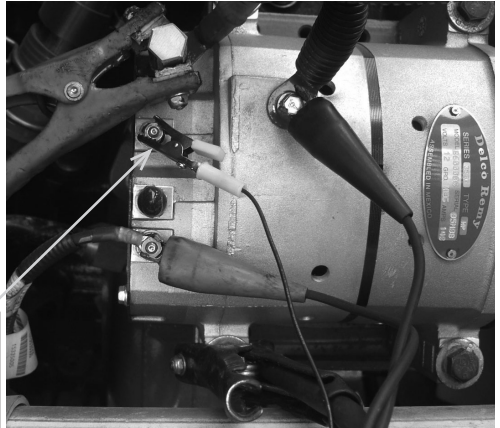

Output terminal adapter utilized

```
>START ENGINE.  
SET IDLE AT  
ABOUT 1000 RPM  
'N' TO CANCEL
```

Make sure all is clear. Start engine and run at fast idle - 1,000 RPM.

```
>ALLOW VOLTAGE  
TO STABILIZE.  
14.20V  
'Y' TO BEGIN
```

You **MUST** allow voltage to stabilize for an accurate test. If, voltage is low, tester will start a one minute clock to ensure proper test.

```
>REV ENGINE TO  
GOV. FOR 10 S.  
  
'N' TO CANCEL
```

Rev the engine to governed speed for 10 seconds. If no results appear press (Y Enter).



# STANDARD ALTERNATOR TEST RESULTS

```
TESTING ALT.  
PLEASE WAIT...
```

Wait for test to complete its testing cycle.

```
#147 12V ALTER.  
GOOD REG. 14.15V  
GOOD DIODE  
GOOD OUTPUT
```

This result indicates the alternator is in good working order.

```
#149 12V ALTER.  
LOW REG. 12.74V  
BAD DIODE  
LOW OUTPUT
```

This is a defective alternator. It has a defective component and is producing high ripple.

```
#151 12V ALTER.  
HIGH REG. 15.02V  
BAD DIODE  
PARTIAL OUTPUT
```

This is a defective alternator. Not only does it have defective components the regulation set point is high.

```
#148 12V ALTER.  
LOW REG. 12.74V  
LOW OUTPUT
```

This is a defective alternator. The output and regulation are low. Defective batteries can cause this condition.

```
#150 12V ALTER.  
HIGH REG. 15.02V  
GOOD DIODE  
LOW OUTPUT
```

Defective alternator. It can not handle the load and it is regulating high.

# REMOTE SENSE ALTERNATOR OUTPUT TEST

After the battery or batteries have been tested and were good (or have been replaced) and after the charging cables have been tested and were good (or were repaired or replaced) you may proceed to test the alternator.

```
BATTERY TEST  ↑
BATTERY BANK
VDROP TEST
>ALTERNATOR  ↓
```

This test can also be selected from the main menu by selecting Alternator Test then press (Y Enter).

```
>INSPECT BELT
CONDITION.

'Y' TO CONTINUE
```

If the unit is setup to require visual checks you will be asked to inspect belt condition...

See picture below

...and tension.

```
>INSPECT BELT
TENSION.

'Y' TO CONTINUE
```

```
>INSPECT CABLES
AND CONNECTIONS

'Y' TO CONTINUE
```



Inspect cables and connections before alternator rating is entered.

```
CONNECT LARGE LEADS
TO THE ALTERNATOR

'Y' TO CONTINUE
```

Red to output terminal and Black to ground / case output adapters recommended.

```
CONNECT LARGE LEADS
TO THE ALTERNATOR

'Y' TO CONTINUE
```

Check the alternator tag or housing and use the +/- key to select the rated output.

# REMOTE SENSE ALTERNATOR TEST (Cont.)

DOES ALTERNATOR  
HAVE A REMOTE SENSE?

'N' OR 'Y'

See photo of remote sense  
alternator.

Select 'Y' for remote sense

Remote Sense

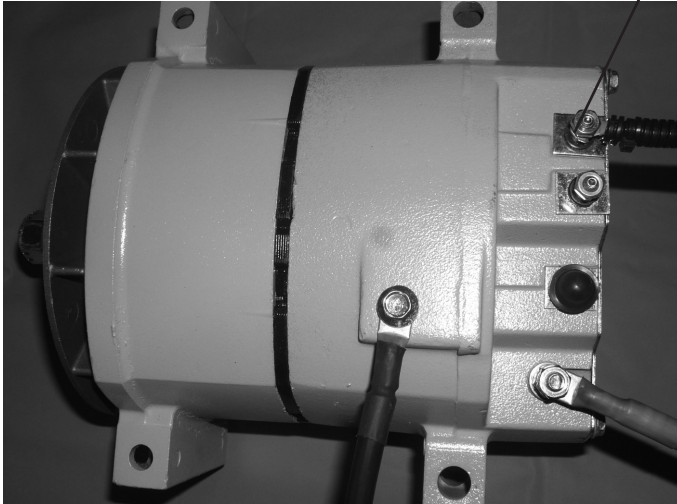

Use the small ext leads and connect  
the red to the remote sense port and  
the black to the Alt ground.

If the tester does not see battery  
voltage this error will appear.

DOES VEHICLE HAVE  
J-1708 DATA PORT?

'N' OR 'Y'

If vehicle is equipped with a J-1708  
port and you have the optional  
cable. Select 'Y'. If vehicle is not  
equipped with J-1708 data port or  
you don't have an optional J-1708  
cable select 'N' If NO skip the next  
two steps.

# REMOTE SENSE ALTERNATOR TEST (Cont.)

```
>ATTACH J-170  
DATA CABLE  
  
'N' TO CANCEL
```

Attach the cable from the tester to the data port on the vehicle.

**NOTE:** if the tester does not detect it is hooked to the data port it will not go beyond this screen.

```
TURN IGNITION  
SWITCH ON
```

Once it detects it is hooked up properly it will prompt you to turn the ignition key to the run position.

```
>CONNECT R CLIP  
TO THE R TERM  
ON ALTERNATOR  
'Y' TO CONTINUE
```

Connect the single alligator clip from the AC-26 J1708 cable to the R terminal on the alternator.

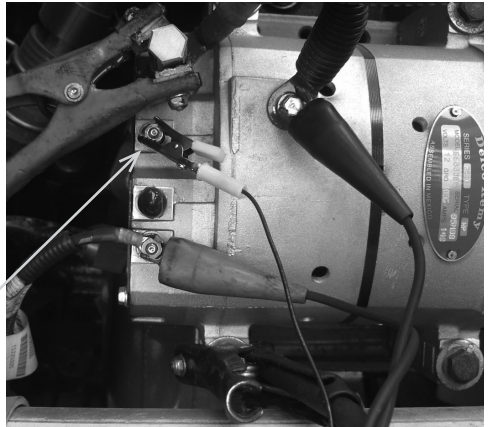

Output terminal adapter utilized

```
>START ENGINE.  
SET IDLE AT  
ABOUT 1000 RPM  
'N' TO CANCEL
```

Make sure all is clear. Start engine and run at fast idle - 1,000 RPM

```
>ALLOW VOLTAGE  
TO STABILIZE.  
14.20V  
'Y' TO BEGIN
```

You **MUST** allow voltage to stabilize for an accurate test. If, voltage is low, tester will start a one minute clock to ensure proper test.

# REMOTE SENSE ALTERNATOR TEST (Cont.)

```
>REV ENGINE TO  
GOV. FOR 10 S.  
  
'N' TO CANCEL
```

Rev the engine to governed speed for 10 seconds. If no results appear press (Y Enter).

```
TESTING ALT.  
PLEASE WAIT...
```

Wait for test to complete its testing cycle.

```
#147 12V ALTER.  
GOOD REG. 14.15V  
GOOD DIODE  
GOOD OUTPUT
```

This result indicates the alternator is in good working order.

```
#149 12V ALTER.  
LOW REG. 12.74V  
BAD DIODE  
LOW OUTPUT
```

This is a defective alternator. It has a defective component and is producing high ripple.

```
#151 12V ALTER.  
HIGH REG. 15.02V  
BAD DIODE  
PARTIAL OUTPUT
```

This is a defective alternator. Not only does it have defective components - the regulation set point is high.

```
#148 12V ALTER.  
LOW REG. 12.74V  
LOW OUTPUT
```

This is a defective alternator. The output and regulation are low. Defective batteries can cause this condition.

```
#150 12V ALTER.  
HIGH REG. 15.02V  
GOOD DIODE  
LOW OUTPUT
```

Defective alternator. It can not handle the loa and it is regulating high.

# 6

## STARTING SYSTEM MAIN CABLE VDROPTM TEST

The circuit from the battery to the starter junction is being tested.

**Note:** If a split battery bank is used go to the Generic Starter Drop Test and perform a split battery procedure. See section 11. By disconnecting each bank and testing the other using the Generic Voltage Drop Test and entering one half the starter draw you can test the starter main cables individually. First of all determine if the system you are going to test is a “split” or “single” system.

```

BATTERY TEST      ↑
BATTERY BANK
>VDROP MENU
ALTERNATOR        ↓
    
```

```

CHARGING CABLES
>STR MAIN CABLES
MAG. CIRCUIT
LIFTGATE VDROPTM
    
```

This test can be selected from the main menu by selecting VDROPTM MENU then by pressing (Y Enter).

...select >STR. MAIN CABLES and press (Y Enter).

### How to Determine if Single or Dual Cable System Chart

	# of Battery Boxes	# of Positive Cables	Type of System
A	1	1	Single
B	1	2	Dual
C	2	2	Dual

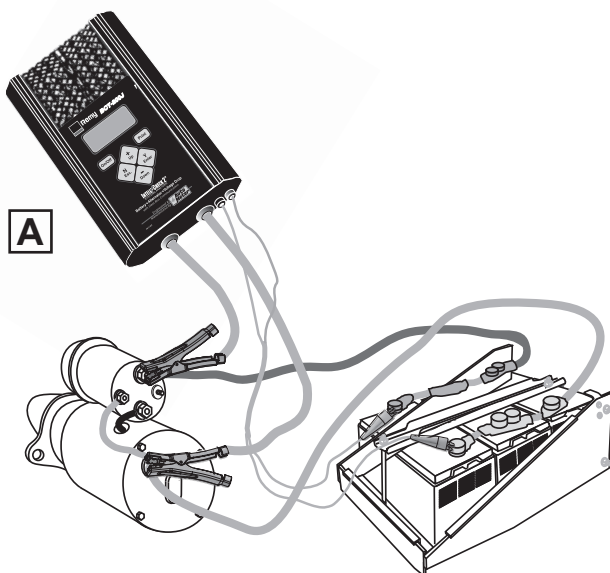

# STARTING VDROPTM MAIN CABLE. . . SINGLE

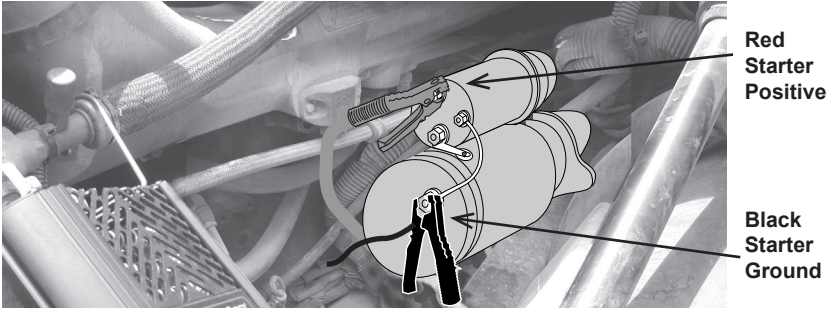

>CONNECT LARGE LEADS TO THE STARTER 'Y' TO CONTINUE

Connect large leads to the Starter

>CONNECT SMALL LEADS TO THE BATTERY 'Y' TO BEGIN

Then connect small leads to the battery bank – the red on the positive main and the black on the negative main and not to an individual battery. The added small external leads will check the main cables. Press (Y Enter).

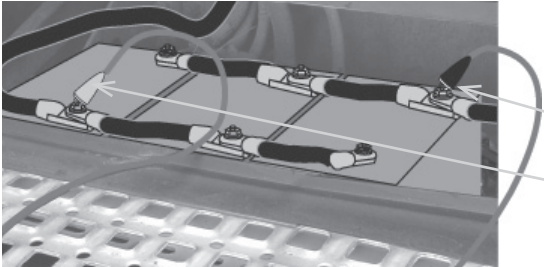

Just as the System Test checks the Magnetic Circuit first it also checks the main starting cables.

LOADING PLEASE WAIT...

If all connections are correct, wait for a load test to be performed.

The results will vary depending upon and the conditions of the cables. Both the positive and negative circuit results will be indicated from the single test. If the test does not pass, correct the connection or replace the cable and run the test again. The BCT-200J will automatically resume the test after it is disconnected. Just answer "Yes" when prompted.

# STARTING MAIN CABLE VDROPTM (Cont.) SINGLE

#10 MAIN CABLES  
PASSED @ 500A  
GOOD TO 545A  
0.18 POS 0.13 NEG

#11 MAIN CABLES  
OUT OF SPEC @ 500A  
GOOD TO 375A  
0.21POS 0.36NEG.

## STARTING VDROPTM . . . SPLIT SYSTEM TESTING PART A

BATTERY TEST  
BATTERY BANK  
>VDROP MENU  
ALTERNATOR

CHARGING CABLES  
STR MAIN CABLES  
MAG. CIRCUIT  
>LIFTGATE VDROPTM

TRAILER CHARGE  
TRAILER MOTOR  
TRUCK CHARGE  
>GENERIC VDROPTM

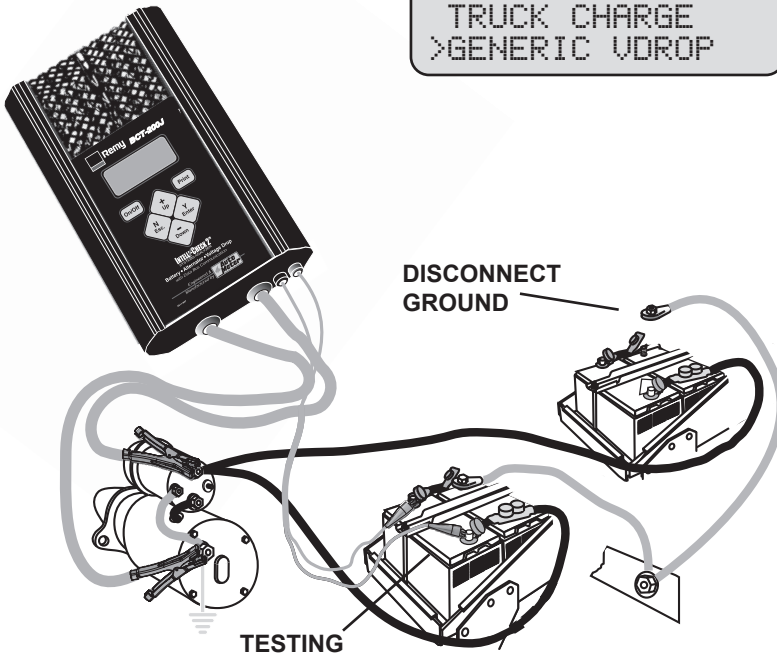



# SPLIT SYSTEM TESTING (Cont.) PART A

```
ENTER RATED  
CURRENT: 250  
  
'Y' TO CONTINUE
```

Scroll to 250 amps.

```
CONNECT LARGE  
LEADS TO THE  
SYSTEM  
  
'Y' TO CONTINUE
```

Red to Starter battery post.  
Black to Starter ground post.

```
CONNECT SMALL  
CLIPS TO THE  
SYSTEM  
  
'Y' TO BEGIN
```

Red to battery positive.  
Black to battery negative.

```
LOADING . . .
```

```
#5 GENERIC VDROPS  
VOLTAGE DROPS  
AT 250 AMPS  
.21 POS .16 NEG
```

You are allowed a total of 0.5 VDrop combined. Add the negative and positive voltage drop for total voltage drop. This example is within spec with a combined drop of only .37V

```
#6 GENERIC VDROPS  
VOLTAGE DROPS  
AT 250 AMPS  
.35 POS .29 NEG
```

This example is out of spec with a total drop of .64V

The results will vary depending upon and the conditions of the cables. Both the positive and negative circuit results will be indicated from the single test. If the test does not pass, correct the connection or replace the cable and run the test again. The BCT-200J will automatically resume the test after it is disconnected. Just answer 'Yes' when prompted.

# SPLIT SYSTEM TESTING (Cont.) PART B

Now test the other battery pack.

BATTERY TEST  
BATTERY BANK  
>VDROP MENU  
ALTERNATOR

CHARGING CABLES  
STR MAIN CABLES  
MAG. CIRCUIT  
>LIFTGATE VDROP

TRAILER CHARGE  
TRAILER MOTOR  
TRUCK CHARGE  
>GENERIC VDROP

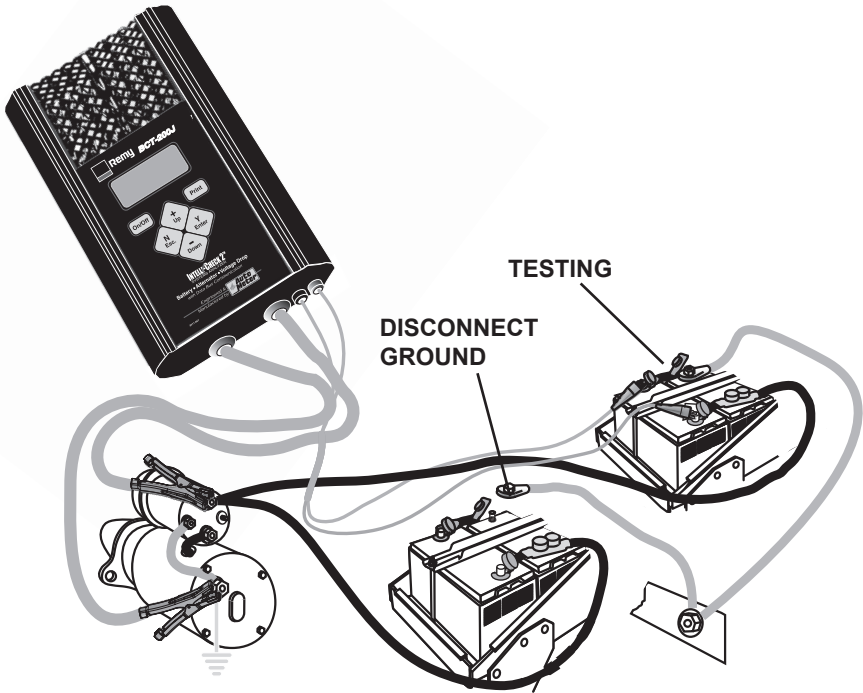

# SPLIT SYSTEM TESTING (Cont.) PART B

```
ENTER RATED  
CURRENT: 250
```

Scroll to 250 amps.

```
'Y' TO CONTINUE
```

```
CONNECT LARGE  
LEADS TO THE  
SYSTEM  
'Y' TO CONTINUE
```

Red to Starter Solenoid battery post.  
Black to Starter ground post.

```
CONNECT SMALL  
CLIPS TO THE  
SYSTEM  
'Y' TO BEGIN
```

Red to battery positive.  
Black to battery negative.

```
LOADING . . .
```

```
#5 GENERIC VDROD  
VOLTAGE DROPS  
AT 250 AMPS  
.15 POS .19 NEG
```

You are allowed a total of 0.5 VDrop combined. Add the negative and positive voltage drop for total voltage drop. This example is within spec with a combined drop of only .34V

```
#6 GENERIC VDROD  
VOLTAGE DROPS  
AT 250 AMPS  
.18 POS .41 NEG
```

This example is out of spec with a total drop of .59V

The results will vary depending upon and the conditions of the cables. Both the positive and negative circuit results will be indicated from the single test. If the test does not pass, correct the connection or replace the cable and run the test again. The BCT-200J will automatically resume the test after it is disconnected. Just answer "Yes" when prompted.

# 7

## MAGNETIC CIRCUIT VDROP™ TEST

The Magnetic switch circuit supplies a path for current to the coils of the starter solenoid with minimum voltage drop. The Magnetic circuit is indicated by the dotted line on the illustration below. The Magnetic circuit test is designed to test the voltage drop of this circuit. It has three steps. If it passes the first test the whole circuit passes and there is no need to continue. If the first test fails, the next two tests are completed to obtain results of each leg and the magnetic switch itself. The Magnetic switch is energized by the ignition switch in each test. For safety, disconnect the negative cable from the battery.

### Magnetic Circuit 3-Step Setup

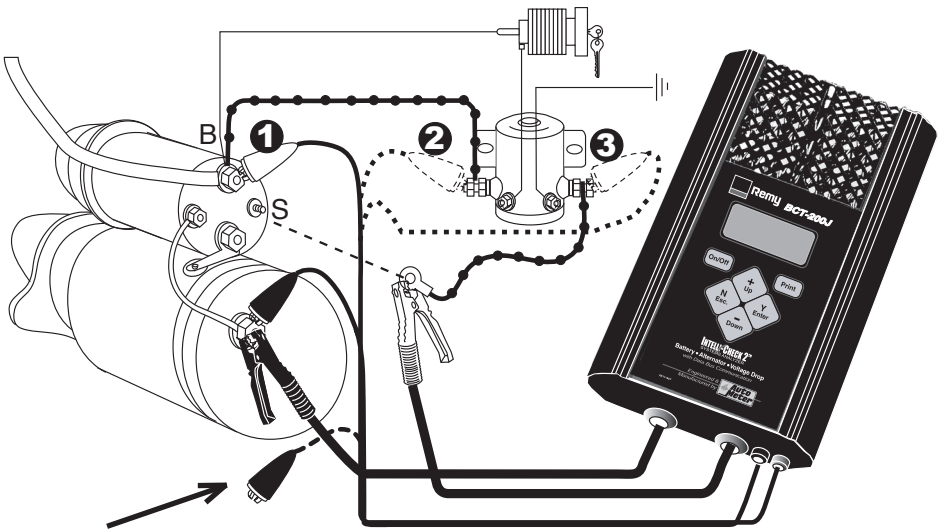

**NOTE: ON 12 VOLT SYSTEMS THE SMALL BLACK LEAD CAN BE LEFT DISCONNECTED OR CAN BE CONNECTED TO ANY GROUND. ON 24 VOLT SYSTEMS THIS LEAD MUST BE CONNECTED TO THE STARTER GROUND.**

```
CHARGING CABLES
STR MAIN CABLES
>MAG. CIRCUIT
LIFTGATE VDRO
```

This is a continuation of the Starting System Test, but can also be selected from the VDrop Menu by selecting >MAG. CIRCUIT then press Enter. In the individual test you will be asked to disconnect the Magnetic circuit from the "S" terminal on the starter solenoid as explained on the previous page. This is necessary to avoid starting the engine during this test sequence.

## MAGNETIC CIRCUIT TEST (Cont.)

DISCONNECT THE  
S-TERMINAL FROM  
STARTER SOL.  
'Y' TO CONTINUE

This is the small wire on the starter solenoid that activates the starter

SELECT STARTER TYPE.  
STRAIGHT DRIVE/GEAR  
REDUCTION  
'Y' TO CONTINUE

Use the + / - key to select the type of starter you are testing.

>CONNECT LARGE  
LEADS TO THE  
S-TERMINAL/GND.  
'Y' TO CONTINUE

Connect the large red clamp (+) to the disconnected ring from the S-terminal magnetic circuit. Connect the large black clamp (-) to the starter ground (See Illustration)

>CONNECT SMALL  
LEADS TO THE  
STARTER SOL/GND  
'Y' TO CONTINUE

Connect the small red lead (+) to the 'B' terminal (+) of the starter solenoid. Attach the small black lead (-) to the starter ground (See Illustration - small clamp position 1)

>ENERGIZE THE  
MAG SWITCH FOR  
3-5 SECONDS.  
'N' TO CANCEL

Reconnect the negative terminal on the battery. Then energize the Magnetic Switch for 3-5 seconds. Note. This can be done by a remote starter or by a second person turning the ignition.

LOADING  
PLEASE WAIT...

Wait for results.

#337 MAG/CIRCUIT  
PASSED!  
DROP WITHIN SPEC  
DROP @80A. 0.65V

If voltage drop is within specifications the whole circuit passes. This test should be done **THREE TIMES** when rotating contact magnetic switches are utilized.

## MAGNETIC CIRCUIT TEST (Cont.)

```
#338 MAG/CIRCUIT  
OUT OF SPEC!  
DROP @ 80A: 1.54V  
'Y' TO CONTINUE
```

If the test was out of spec Press 'Y' and the BCT-200J will advance to the next menu. Excessive drop at rated load is indicated by more than 1 Volt drop at 80 Amps.

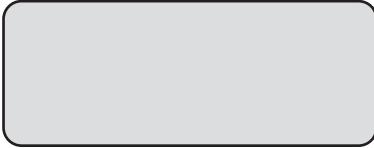

Move the small red lead to the magnetic switch hot side connection from the battery (2), press enter and energize the switch again for 3-5 seconds (See Illustration - small clamp position 2).

```
>MOVE SMALL RED  
LEAD TO OTHER  
SIDE OF MAG.  
'Y' TO CONTINUE
```

Move the small red lead to the negative (-) side of the magnetic switch (3), press enter and energize again for 3-5 seconds (See Illustration - small clamp position 3).

```
#340 MAG/CABLES  
LEG1: 2.22V FAIL  
MAG.: 0.41V FAIL  
LEG2: 0.12V PASS
```

The final results will appear indicating the section of the circuit or switch that is in need of repair.

# 8

## KEY SWITCH VDROP™ TEST

**Note:** This is a real time test and the operator must observe and record the data when the key switch is energized.

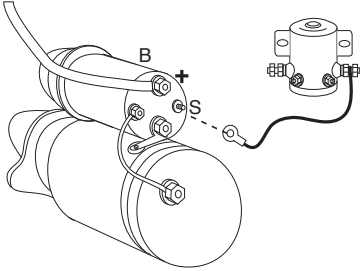

**S-terminal wire must be removed from the solenoid so that the starter does not engage.**

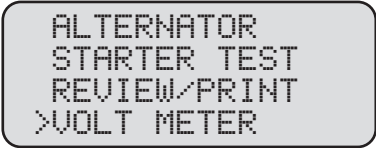

Scroll to Voltmeter

Connect large clips to magnetic switch coil.

Connect small leads to starter.

**NOTE:** Connections are the same for WITH OCP or WITHOUT OCP.

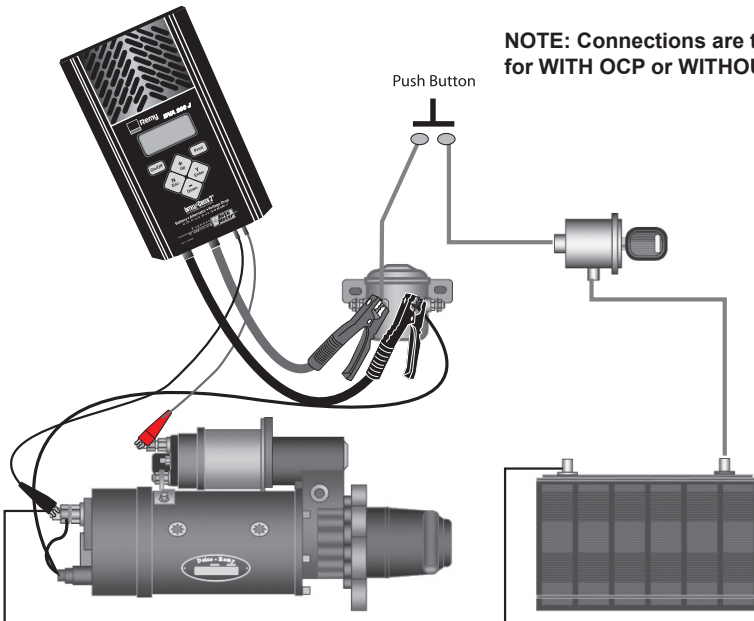

# KEY SWITCH VDROPTM TEST (Cont.)

```
-VOLTMETER-  
VOLTS      0.00V  
EXT. V     12.63V  
0.00 POS  0.00 NEG
```

Should read voltage at ext. V. No voltage at magnetic switch coil with ignition key off.

```
-VOLTMETER-  
VOLTS      12.15V  
EXT. V     12.40V  
.15 POS   .10 NEG
```

Turn the ignition key to start position and hold. Observe both volt results Voltage is at magnetic switch coil leads. External V is voltage at starter.

```
-VOLTMETER-  
VOLTS      12.15V  
EXT. V     12.40V  
.15 POS   .10 NEG
```

In this example the system passed, the total voltage drop is .25V which is less than the .5V drop allowed.

End of test.

```
-VOLTMETER-  
VOLTS      11.08V  
EXT. V     12V  
.33 POS   1.02 NEG
```

In this example the system is out of spec. The 1.35 volt drop exceeds the allowable .5 volt drop.

Continue testing each leg of the circuit.



# KEY SWITCH VDROPTM TEST (Cont.) (OCP)

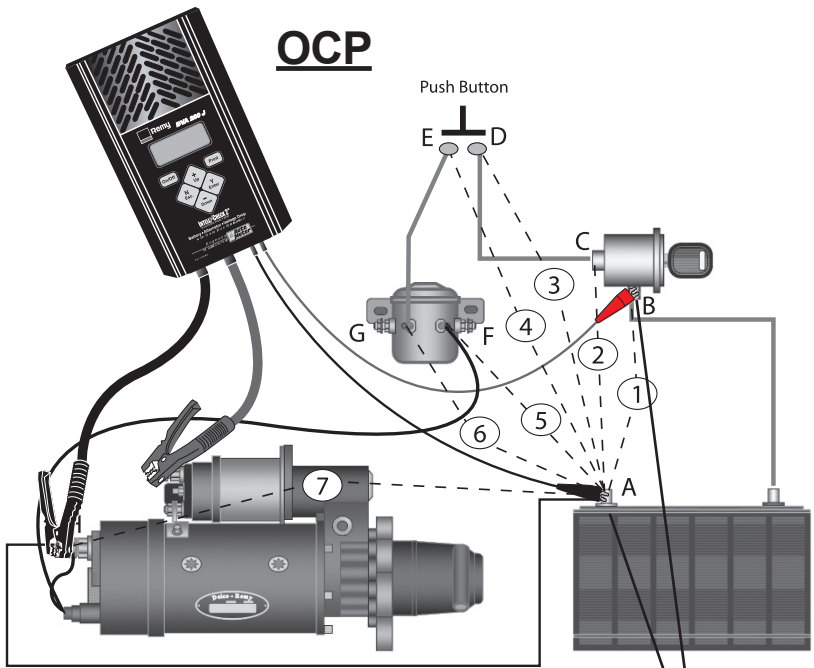

- A= will always be the small black lead
- A to B tests power at key switch
- A to C tests power out of keyswitch
- A to D tests power at the push button
- A to E tests power out of the push button
- A to F tests ground at the mag switch
- A to G tests power at mag switch
- A to H tests ground at starter

**Note:** D & E tests only pertain to vehicles equipped with push button start

**Example:** Connect small black lead at A and small red lead on B

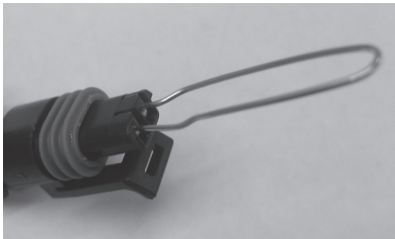

**Note:** For testing the OCP wiring the plug should be removed and a paper clip inserted in the connector body. (see picture)

# KEY SWITCH VDROPTM TEST (Cont.) (NON OCP)

## NON OCP

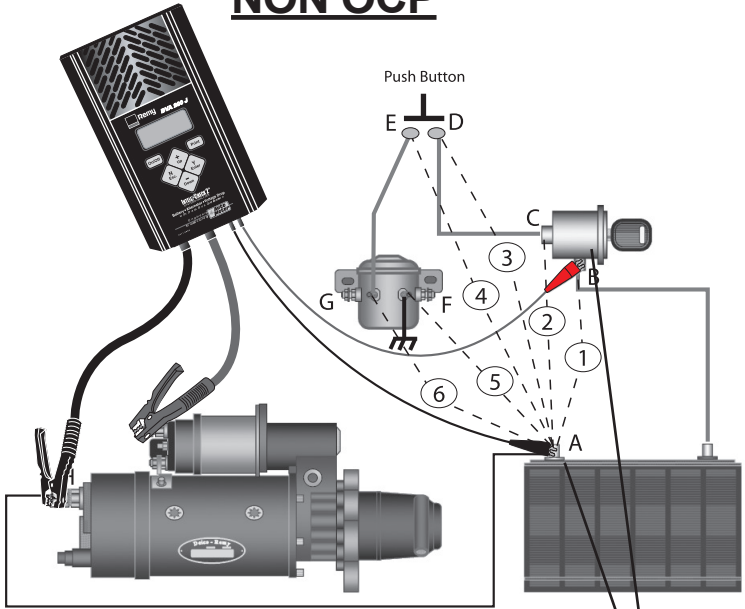

- A= will always be the battery ground
- A to B tests power at key switch
- A to C tests power out of keyswitch
- A to D tests power at the push button
- A to E tests power out of the push button
- A to F tests ground at the mag switch
- A to G tests power at mag switch

Note: D & E tests only pertain to vehicles equipped with push button start

Example: Connect small black lead at A and small red lead on B

# 9

## LIFTGATE VDROPTM TESTS

The various liftgate circuit voltage drop tests and the generic voltage drop test can be used to test the liftgate charging and motor circuits as well as any other circuit that includes a battery and cables and is designed to operate a load of 20 amps or more.

```
BATTERY TEST  ↑
                                     ↓
```

After selecting >VOLTAGE  
DROP from the main menu...

```
CHARGING CABLES
STR MAIN CABLES
MAG. CIRCUIT
>LIFTGATE VDROPTM
```

...select >LIFTGATE V DROP and  
press (Y Enter).

```
>TRAILER CHARGE
TRAILER MOTOR
TRUCK CHARGE
GENERIC VDROPTM
```

Select TRAILER CHARGE, TRAILER MOTOR or TRUCK CHARGE to perform a voltage drop test on the trailer charge circuit, trailer liftgate motor circuit or the truck's liftgate power circuit respectively.

The liftgate charging circuit includes the positive cables from the front of the trailer to the liftgate batteries and the negative cables and/or frame from the front of the trailer to the liftgate batteries.

The liftgate motor circuit includes the positive cables and the solenoid from the liftgate batteries to the liftgate motor and the negative cables and/or frame from the liftgate batteries to the liftgate motor.

The liftgate truck circuit includes the positive cables and the negative cables and/or frame from the trucks batteries to the front of the trailer (end of the "stinger" cord).

Adapters are available from Auto Meter to facilitate connecting the BCT-200J to single pole and dual pole connectors on both trucks and trailers. See the manual supplement that is included with those adapters for more detailed information on testing and trouble shooting the liftgate charging circuits and liftgate motor circuits.

```
TRAILER CHARGE
TRAILER MOTOR
TRUCK CHARGE
>GENERIC VDROPTM
```

Select >GENERIC VDROPTM  
and press (Y Enter) to run the  
generic voltage drop test.

```
>ENTER RATED
CURRENT: 150A
'Y' TO CONTINUE
```

Using the (+/-) key adjust Amp  
rating to that of the generic load  
device.

```
>CONNECT LARGE
LEADS TO THE
SYSTEM.
'Y' TO CONTINUE
```

Connect large leads to the generic  
load.

# LIFTGATE VDROPTM TESTS (Cont.)

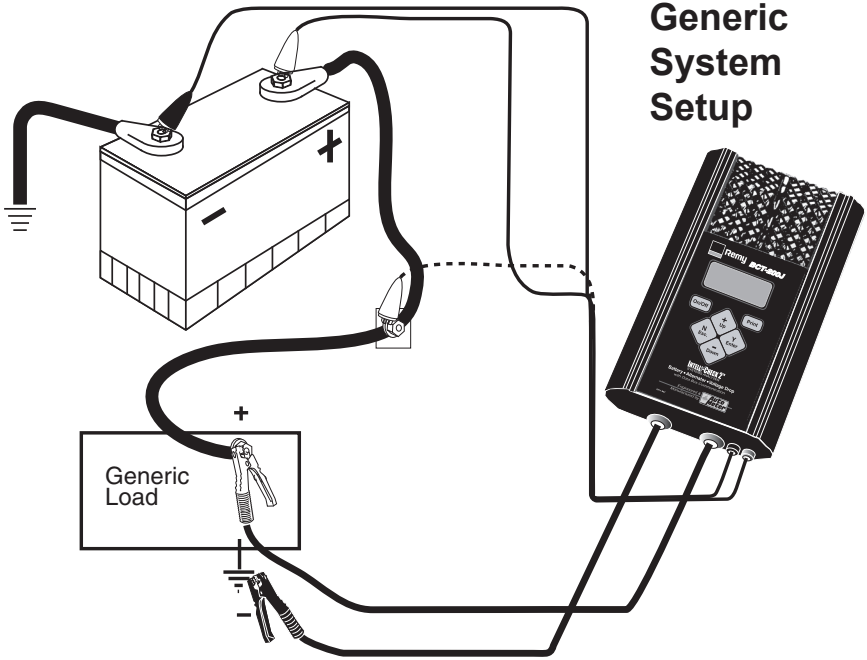

## Generic System Setup

```
>CONNECT SMALL  
LEADS TO THE  
SYSTEM.  
'Y' TO CONTINUE
```

Then connect small leads to the battery or along the circuit being tested as illustrated in the setup and press (Y Enter).

```
LOADING  
PLEASE WAIT...
```

If all connections are correct, wait for a load to be applied.

```
#28 GEN. VDROPTM  
VOLTAGE DROPS  
AT 150 AMPS  
0.33 POS 0.32 NEG
```

The results will vary depending upon and the conditions of the cables. Both the positive and negative circuit results will be indicated from the single test.

If the overall voltage drop is not within the desired specifications the small leads can be moved closer along the line being tested and the test run again (see dotted lead on previous page). If the results are desirable, it is the section not included in the last test. If the results are not desirable the problem is most likely in the section being tested. Repair and test the entire section again.

# DEFINITIONS - SYSTEM SPECIFICATIONS

## BATTERY TEST

During each battery test the BCT-200J uses various results that are displayed after each test. The definition of those results are as follows:

- **% Charge** = an approximate amount of charge the battery is currently holding. This is based upon the batteries voltage.
- **Est. CCA** = is the approximate CCA of the fully charged battery.
- **GOOD BATTERY** = a battery that is good and is charged.
- **GOOD NEEDS CHARGE** = a battery that is good but is low on charge.
- **MARGINAL BATTERY** = a battery that has passed the load test but the estimated CCA is getting low or the battery is approaching its end of life.
- **CHARGE and RETEST** = a battery with insufficient charge to provide accurate test results.
- **BAD BATTERY** = a battery that is bad and should be replaced. A bad battery is a battery that failed the load test or had an estimated CCA below about 70% of the rated value.

## VOLTAGE DROP TESTS

The specifications for those tests are listed below.

TEST	SYSTEM	ASS/FAIL
Charging Cables	12 Volt	Maximum drop at rated alternator output is 0.5 Volts
	24 Volt	Maximum drop at rated alternator output is 1.0 Volts
Main Starting Cables	12 Volt	Maximum drop at 500 Amps is 0.5 Volts
	24 Volt	Maximum drop at 250 Amps is 1.0 Volts
Magnetic Circuit Straight Drive	12 Volt	Maximum drop at 80 Amps is 1.0 Volts
	24 Volt	Maximum drop at 40 Amps is 2.0 Volts
Magnetic Circuit Gear Reduction	12 Volt	Maximum drop at 300 Amps is 1.0 Volts
	24 Volt	Maximum drop at 225 Amps is 2.0 Volts
Generic Voltage Drop Test	12 Volt	Reports the drops at the entered current
	24 Volt	Reports the drops at the entered current

The minimum system voltage to run a test is 12.25 Volts for a 12 Volt system and 24.5 Volts for a 24 Volt system.

# 10

## ALTERNATOR BENCH TESTING

The Bench Test is used to test the alternator that has been removed from the vehicle and setup on an alternator test bench.

```
ALTERNATOR  
STARTER TEST  
REVIEW/PRINT  
>BENCH TEST
```

From the main menu select Bench Test and press Y/Enter.

```
PRESS 'Y' TO  
SCROLL THROUGH  
BENCH SETUP OR  
'+' TO SKIP
```

Press 'Y' to scroll through the prompts for connecting the alternator to the bench or press the +/Up key to skip over the prompts to attach the alternator and the test leads.

```
REMOVE THE  
ALTERNATOR PULLEY  
  
'Y' TO SCROLL
```

If the pulley that is on the alternator is a different size or different style than the pulley that comes with the bench, then remove the pulley from the alternator and attach the pulley that goes with the bench to the alternator.

```
ATTACH BENCH  
PULLEY TO THE  
ALTERNATOR.  
'Y' TO SCROLL
```

Utilize the proper size pulley that works with the tester.

```
ATTACH THE  
ALTERNATOR TO THE  
BENCH.  
'Y' TO SCROLL
```

Securely mount the alternator to the bench following the instructions for the bench.

```
ROUTE BELT OVER  
LARGE BENCH  
PULLEY.  
'Y' TO SCROLL
```

It is important that the belt go around the large pulley that is attached to the bench motor. If the small pulley on the bench motor is used or if a larger pulley is used on the alternator then the bench will not spin the alternator at full speed.

# ALTERNATOR BENCH TESTING (Cont.)

MAKE SURE THAT  
THE BELT IS  
STRAIGHT.  
'Y' TO SCROLL

Align the belt so that it is straight and will not come off.

TIGHTEN THE BELT  
'Y' TO SCROLL

Make sure the belt is tight so that it will be able to properly turn the alternator under load.

ATTACH BLACK  
BENCH LEAD TO  
GROUND ADAPTER.  
'Y' TO SCROLL

Securely attach the black bench lead to the alternator's casing or to the ground adapter post (if the alternator has a ground post instead of a case ground).

ATTACH BLACK  
TESTER LEAD TO  
ALTERNATOR.  
'Y' TO SCROLL

Also attach the black lead from the BCT 200J to the alternator's casing or to the ground post (if the alternator has a ground post instead of a case ground).

ATTACH POSITIVE  
ADAPTER TO  
ALTERNATOR  
'Y' TO SCROLL

The AC-27 adapter makes it possible to attach the red lead from the bench and the red lead from the BCT 200J to the alternator output post. Be sure to thread the adapter completely onto the output post of the alternator and tighten.

ATTACH RED BENCH  
LEAD TO POSITIVE  
ADAPTER.  
'Y' TO SCROLL

ATTACH RED TESTER  
LEAD TO POSITIVE  
ADAPTER.  
'Y' TO SCROLL

## ALTERNATOR BENCH TESTING (Cont.)

ALTERNATOR AND  
TESTER SHOULD BE  
HOOKED UP.  
'Y' TO CONTINUE

If the prompts are skipped over by pressing the +/Up key then a prompt is displayed indicating that the alternator and the tester should at this point be connected to the bench. After verifying that the setup is correct press the Y/Enter key to continue.

DOES  
ALTERNATOR HAVE A  
REMOTE SENSE.  
'N' OR 'Y'

Some alternators have a remote sense post to enable the alternator to regulate the voltage at the battery instead of at the alternator. If the alternator has a remote sense post then the remote sense post must be attached to the output post of the alternator to test the alternator on the bench. Otherwise the alternator's regulator will not be connected and the alternator's output voltage will be high.

CONNECT REMOTE  
SENSE POST TO  
OUTPUT POST.  
'Y' TO CONTINUE

TURN BENCH POWER  
SWITCH ON.

'Y' TO CONTINUE

**Note: Output terminal and ground post adapters utilized. Model AC-27**

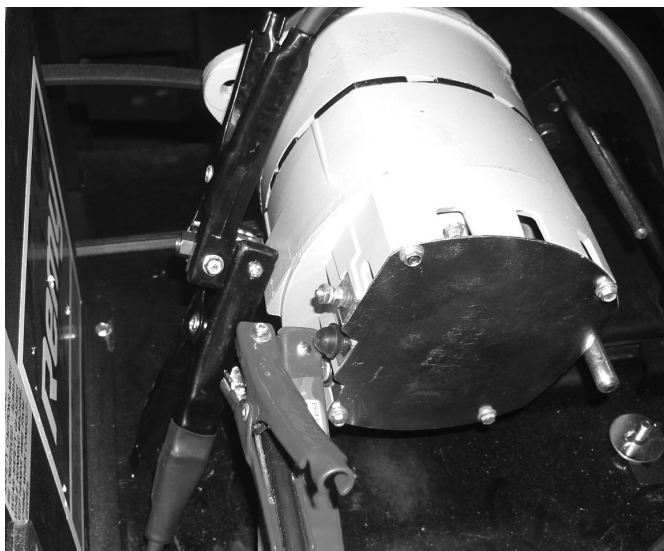



# ALTERNATOR BENCH TESTING (Cont.)



The BCT 200J will check the bench battery to ensure that it is charged and sufficiently good to continue with the alternator test.



If the battery has a charger connected to it the charger must be turned off or disconnected to continue with the alternator test.

```
BENCH BATTERY OR  
CABLES ARE  
DEFECTIVE.  
'Y' TO CONTINUE
```

If the bench battery is too weak or if the cables or leads of the bench have too high of a voltage drop then the battery and/or cables will need to be serviced before continuing with the alternator test.

```
BENCH BATTERY IS  
LOW, CHARGE OR  
REPLACE.  
'Y' TO CONTINUE
```

If the bench battery is discharged then charge or replace the battery before continuing with the alternator test.

```
ENTER RATED  
ALTERNATOR  
OUTPUT: 100A  
'Y' TO CONTINUE
```

Set the rated output of the alternator. The rated output is sometimes marked on the alternator, if it is not marked on the alternator check the manufacturer's documentation.

```
TURN MOTOR SWITCH  
TO FWD.  
'Y' TO CONTINUE
```

Turn the bench motor on to spin the alternator. If the nut to hold the pulley on the alternator has right-hand threads then by turning the motor forward the chances of the pulley coming loose during the test will be reduced.

# ALTERNATOR BENCH TESTING (Cont.)



```
TURN MOTOR SWITCH  
OFF.  
'Y' TO CONTINUE.
```

```
TURN BATTERY  
SWITCH OFF.  
'N' TO CANCEL
```

```
TURN BENCH POWER  
SWITCH OFF.  
'Y' TO CONTINUE
```

```
#45 12V BENCH  
GOOD ALTERNATOR  
GOOD REG. 14.47V
```

If this prompt shows up during the alternator test then verify that the belt goes around the large pulley on the bench motor and that the correct pulley is used on the alternator. If the correct pulleys are being used then press Y/Enter to continue otherwise press N/Cancel and use the correct pulleys.

After the BCT-200J has tested the alternator it will prompt for the motor, the battery switch and the bench power to be turned off.

After the bench is turned off the BCT-200J will report the condition of the alternator.

# ALTERNATOR BENCH TESTING (Cont.)

#48 12V BENCH BAD  
ALTERNATOR HIGH  
RIPPLE  
REG. 14.39V

This result indicates the alternator is in good working order

#147 12V ALTER.  
GOOD REG. 14.15V  
GOOD DIODE  
GOOD OUTPUT

#149 12V ALTER.  
LOW REG. 12.74V  
BAD DIODE  
LOW OUTPUT

This is a defective alternator. It has a defective component and is producing high ripple

#151 12V ALTER.  
HIGH REG. 15.02V  
BAD DIODE  
PARTIAL OUTPUT

This is a defective alternator. Not only does it have defective components - the regulation set point is high.

#148 12V ALTER.  
LOW REG. 12.74V  
LOW OUTPUT

This is a defective alternator. The output and regulation are low. Defective batteries can cause this condition

#150 12V ALTER.  
HIGH REG. 15.02V  
GOOD DIODE  
LOW OUTPUT

Defective alternator. It can not handle the load and it is regulating high.

## MAINTENENCE

### CLAMP INSPECTION

**IMPORTANT:** Both jaws of each clamp must firmly engage all terminals. The copper jaw contains the smaller gauge wire that reads the voltage and the silver jaw contains the larger conducting wire that draws the load in each test. Jaw insulation is necessary for accurate readings. Damaged clamps or loose wires will affect the readings. Keep clamps clean and in good repair. **DO NOT ATTEMPT TO REPLACE CLAMPS WITH ANYTHING OTHER THAN AUTO METER CLAMPS.**

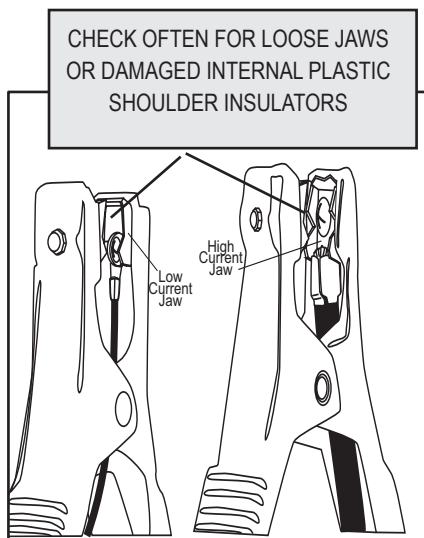

### BATTERY CLAMP REPLACEMENT

Over time the battery clamps will need to be replaced if the following are indicated:

- CCA values seem to be way off.
- If there is continuity between the silver and copper jaw.
- If there is excessive damage or corrosion to the cables or clamps.

#### PROCEDURE

- Disconnect the back cover.
- Remove the battery to prevent shorting.
- Disconnect the two small wires from the PC board.
- Remove the large cables from the copper busses.
- Carefully pull each wire through the grommets.
- Reverse the procedure in replacing new clamps.
- **Caution:** Make sure the red clamp wires are attached to the positive buss and the black clamp is attached to the negative buss. Putting a little mineral spirits on the new cable ends will increase ease of insertion through the grommets.

### BATTERY REPLACEMENT

When the LCD indicates a low internal battery. Remove the back cover and replace the battery with a 9 volt Alkaline battery.

# REVIEW TESTS

From the main menu select **REVIEW/PRINT**

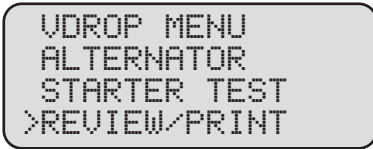

The last test will be displayed.

Press (+Up) or (-Down) key to select the desired test. Press



(N Esc.) to select MAIN MENU.

## OPTIONAL INFRARED PRINTER

The optional PR-15 printer receives an infrared beam from the BCT-200J up to 40 ft. No connection cords are needed. For more instructions on how to operate the printer consult the printer manual.

Printer Type -----Thermal  
Print Speed-----24-char. line per second  
Paper-----2.25 in x 80 ft. roll (included)\*  
Power ----- AC Adapter

**Note:** Thermal Paper can be purchased at any office supply.

# PRINTING TEST RESULTS

Point the BCT-200J in the direction of the optional PR-15 printer with the printer's IR receiver pointed in the direction of the BCT-200J. Press (Print). You should be within 15 ft. of the printer. Wait for the screen to clear before moving the BCT-200J. It takes a moment to send all the test data. The BCT-200J also operates the AC-14 printer installed in Auto Meter's XTC-160 tester/charger or BVA-2100 heavy duty tester/analyzer.

- Make sure the Infrared Printer is properly set up.
- After a test is made with the BCT-200J make sure the results are displayed on the LCD.
- Point the BCT-200J in the direction of the Infrared Printer (within 15 ft.)
- Press the <Print> key and the test results will be printed.
- Depending upon the test made the printer will sometimes yield more information than the LCD.
- Wait until the printer stops printing before you press the BCT-200J print key again.
- **Multiple Test Printing:**  
Pressing the print button repeatedly (up to six times) will automatically print the test in review and the previous tests.



For battery, starter, and alternator tests a unique warranty code is generated and printed at the bottom of the printout. This code is used for data and warranty verification.

**Example warranty code:**

**WARRANTY CODE**  
**2BC0813280B012H12**

# VOLT METER

```
ALTERNATOR      ↑  
STARTER TEST  
REVIEW PRINT  
>VOLT METER     ↓
```

Select VOLT METER from the main menu and press (Y Enter).

This gives the user a chance to check the voltage from the large clamps and the external leads.

```
-VOLT METER-  
VOLTS: 12.28V.  
EXT VOLTS: 3.77V  
0.00 POS 0.00NEG
```

```
-VOLT METER-  
VOLTS: 12.28V.  
EXT VOLTS: 3.77V  
RIPPLE: 0.00MV
```

Press (Y Enter) to switch between screens showing voltage drop or ripple

# J1708 DATA

```
STARTER TEST    ↑  
REVIEW/PRINT  
VOLT METER  
>J1708 DATA    ↓
```

Select J1708 for the main menu and press (Y Enter).

```
ERROR: J1708  
NOT READING
```

If ERROR appears the connections has not been established.

```
VIN: 12345689A  
BATTERY 14.10V.  
OIL TEMP 68F.  
AMB. TEMP. 75F.
```

```
VIN: 12345689A  
BATTERY 14.10V.  
OIL TEMP 68F.  
AMB. TEMP. 75F.
```

Press (Y Enter) to switch between screens.

This gives the user a chance to check the J1708 connections and obtain pertinent information such as the ambient temperature for later use in testing the battery. Keep in mind that the ambient temperature may not be the actual temperature of the battery unless the vehicle battery has been in the place sufficient time for the battery to reach the surrounding ambient temperature. A low oil temperature would add a greater demand on the starter. This information is used by the BCT-200J to calculate the condition of the starter.

# SETUP

```
REVIEW/PRINT
VOLT METER
J1708 DATA
>SETUP
```

From the main menu select  
SETUP.

```
>SET TEMPERATURE
SCALE: F.
USE +/- .
'Y' TO SELECT
```

Select the temperature in  
Fahrenheit or Centigrade.

```
>REQUIRE VEHICLE
ID NUMBERS? YES
USE +/- .
'Y' TO SELECT
```

You can require the entry of a vehicle  
identification number for each test.  
Use the (+) or (-) key to change the  
displayed request.

Note: The ID number will not be  
requested again as long as the unit  
is not turned off.

```
>ENTER VEHICLE
ID# 0000
USE +/- .
'Y' TO CONTINUE
```

If answered YES the above screen  
will appear at the beginning of the  
first test for a vehicle. Each digit,  
with a total of 6, requires increment  
or decrement to the desired  
number. The requested digit to  
change is flashing. By pressing (Y  
Enter) the next digit is selected. On  
the last enter the displayed number  
will be accepted and remain in  
memory.

```
>REQUIRE TECH.
NUMBERS? NO
USE +/- .
'Y' TO SELECT
```

To require technician numbers  
change YES or NO using the (+) or (-)  
key. Press (Y Enter) to select.

```
>REQUIRE VISUAL
CHECKS? NO
USE +/- .
'Y' TO CONTINUE
```

To require visual checks change  
YES or No using the (+) or (-) key.  
Press (Y Enter) to select.

```
>REQUIRE BATTERY
DATE CODES? NO
USE +/- .
'Y' TO SELECT
```

To require battery date codes  
change YES or No using the (+) or  
(-) key. Press (Y Enter) to select.



## SETUP (Cont.)



To require a battery serial number before each battery test select YES. If YES is selected then before each battery test the tester will prompt for a 14 digit alphanumeric serial number. This serial number will be printed near the bottom of the printout along with the warranty code.

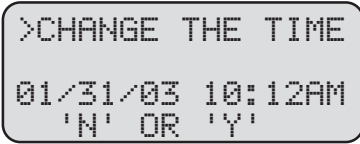

If you select Yes you can change the MONTH, DAY, YEAR, HOUR and MINUTE.



Select the month as 01 to 12

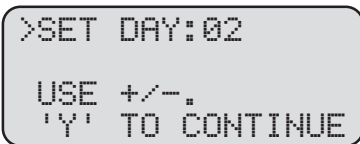

Select the day as 01 to 31

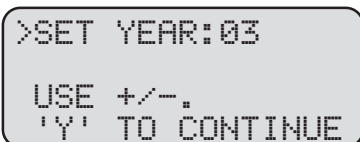

Select the year as 04 to 99

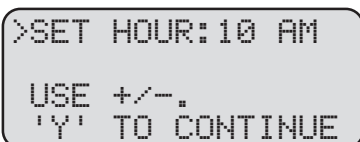

Select the hour as 01 to 12 AM/PM

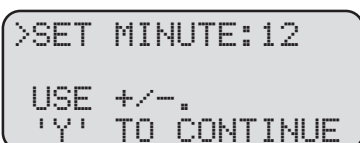

Select the minute as 01 to 60



Can delete all test data or one item at a time.

# PC INTERFACE

1. Scroll down the main menu to DOWNLOAD. Press (Y Enter) to select.



Using Auto Meter's optional adapter cord AC-10 insert the plug into the jack on the BCT-200J (see page 6) and then plug the serial adapter into a free serial port on your computer.

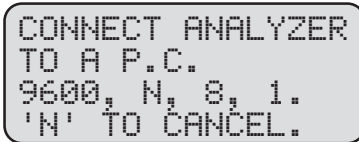

**Note:** Most computers are configured with at least one serial port (identified as COM 1), and some have a second serial port, usually identified as (COM 2). Check your computer manual to locate and identify a serial port connector. Even if you have a physical COM port you need to make sure it is working properly before you proceed. Consult your computer manual. If your computer serial port is configured for 25 pin you will need to obtain an adapter from your computer store. If your computer does not have an available serial port and you're planning on using *Windows HYPER Terminal* as illustrated below, you will need to buy and install an adapter card with a serial port.

2. Using Auto Meter's AC-35 Application Program  
By purchasing Auto Meter's PC Application Program, information that is stored and collected in the BCT 200J can be easily downloaded into a PC program format for storage. The AC-35 comes with a PC cable, installation and user instructions.

# USING WINDOWS 98/2000/NT/XP

**Note:** The BCT-200J will interface with any basic (ANSI) terminal emulation software. Most operating systems contain a program that will do this. Following are instructions for Windows. For other operating systems consult the Manual for that system.

## 3. Opening Windows HyperTerminal:

- Select Windows Start
- Then “Programs”
- Then “Accessories”
- Then “Communications”
- Then Click “Hyper-Terminal”
- Double Click “Hypetrm.exe” application
- Type in a name for your connection
- Select an icon for future identification
- Select “OK”
- Select the COM port number you have previously identified in step 1.
- Select “OK” and select the following from the pull down menus:

Bits per second	9600
Data bits	8
Parity	None
Stop Bits	1
Flow Control	None
- Select “OK”

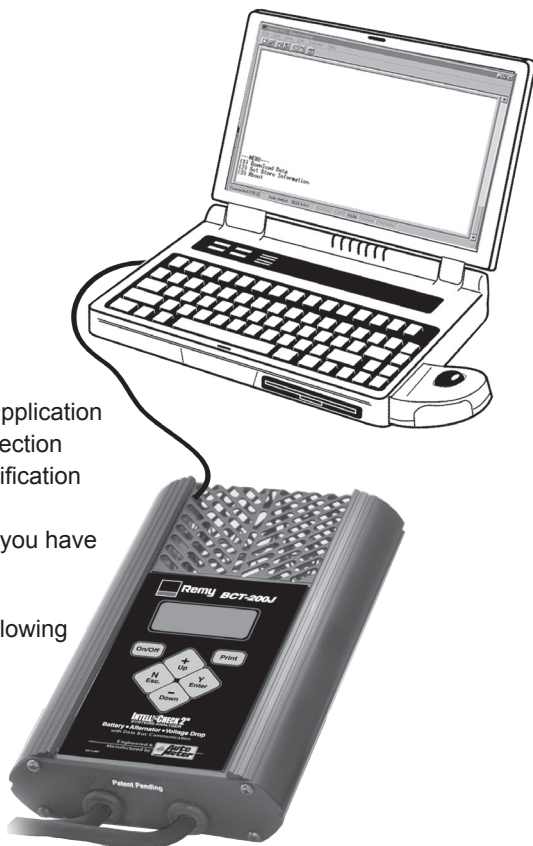

# DOWNLOAD TEST INFORMATION

## 4. PC Screen Menu

- If the BCT-200J is properly connected to your PC and the LCD shows “CONNECT ANALYZER TO A PC” the menu should automatically be displayed in Hyper Terminal.
- Press “1” to download the stored data.

To save the information displayed see “Capture text into Microsoft Excel.” See BCT-200J test labels below for identification.

- Press “Enter” to return to Menu.
- Press “Enter” to return to Menu.
- Press “3” to Exit.

HyperTerminal  
Windows

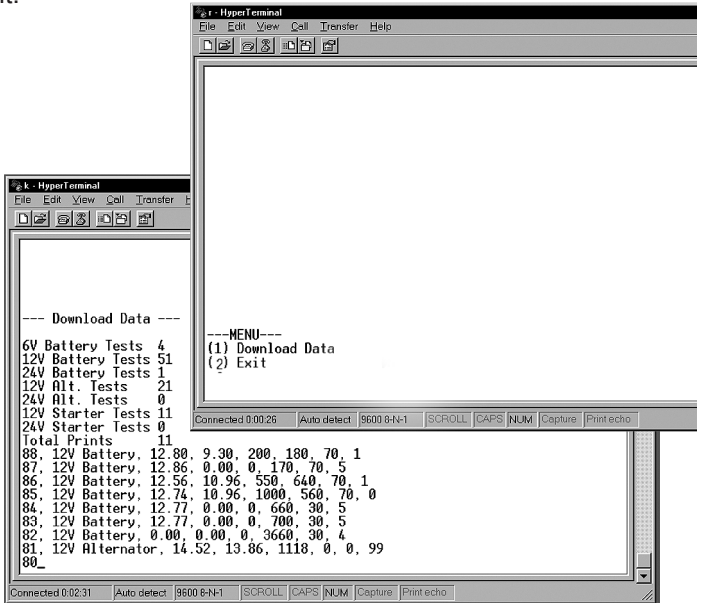

BCT-200J  
Test Labels

Battery Bank	Beginning Volts	Loaded Volts	Rated CCA	# of Batteries	Temperature	N/A	Amb. Temp
12V Battery	Beginning Volts	Loaded Volts	Rated CCA	Est. CCA	Temperature	1ST CCA	Amb. Temp
24V Battery	Beginning Volts	N/A	N/A	N/A	Temperature	N/A	Amb. Temp
12V Alter.	Beginning Volts	Loaded Volts	mVAC	Peak Volts	mVAC	Rated Current	R-Term
24V Alter.	Beginning Volts	Loaded Volts	mVAC	Peak Volts	N/A	Rated Current	R-Term
12V Starter	Beginning Volts	Loaded Volts	Ext Volts	Pos Drop	Cranking Volts	Pos Drop	Draw

# CAPTURING TEXT

## 5. Using Microsoft Excel

**Note:** For other software applications consult your software manual.

- Make sure menu is displayed as shown in illustration page 20 step 3.
- Select “Capture Text” in the Transfer Menu.
- Type in **c:\my documents\download.txt** and then select “Start.”
- Press “1” to download. When finished select Capture Text again from the Transfer Menu then select Stop.
- Launch Microsoft Excel and select open file.
- Under “Files of Type” at the bottom of the open file window select All Files (\*.\*)
- Highlight your “**download.txt**” file then select Open.
- Select “Delimited” and start at row 1 then “Next”
- Select “Comma” then “Next”

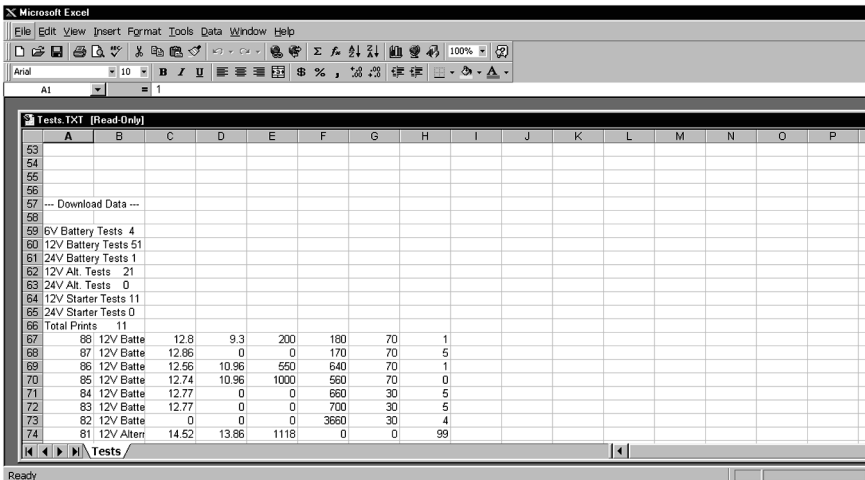

- Under Column Date Format select “General” then “Finish”
- After the file is loaded you can delete unwanted rows and format columns as desired. The following are labels for identifying the 8 columns of information.

### BCT-200J Test Labels

Date Code	N/A	N/A	N/A	N/A	N/A	Condition	Tech ID	Vehicle ID	VIN	Time/Date
Date Code	N/A	N/A	N/A	N/A	N/A	Condition	Tech ID	Vehicle ID	VIN	Time/Date
Date Code	N/A	N/A	N/A	N/A	N/A	Condition	Tech ID	Vehicle ID	VIN	Time/Date
Engine Speed	R-Term	Engine Speed	N/A	N/A	Code	N/A	Tech ID	Vehicle ID	VIN	Time/Date
Engine Speed	R-Term	Engine Speed	N/A	N/A	Code	N/A	Tech ID	Vehicle ID	VIN	Time/Date
Oil Temp	Amb. Temp	N/A	N/A	N/A	Code	N/A	Tech ID	Vehicle ID	VIN	Time/Date
Oil Temp	Amb. Temp	N/A	N/A	N/A	Code	N/A	Tech ID	Vehicle ID	VIN	Time/Date

## ABOUT



J1708                   ↑  
SETUP  
DOWNLOAD  
>ABOUT

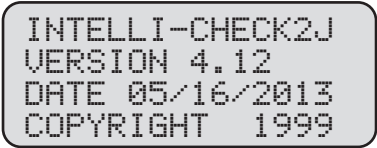

INTELLI-CHECK2J  
VERSION 4.12  
DATE 05/16/2013  
COPYRIGHT 1999

**Gives the version of the software.**

**NOTE:** This screen is for reference only. The software version and date shown in the screen illustration may not match what is displayed on the actual tester.

The program can be updated to the most recent version by reflashing the memory. Before turning the unit on hold the (N Exc.) and the (Y Enter) key down simultaneously. The following will appear.

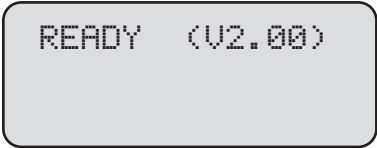

READY (V2.00)



REFLASHING!

**When a computer can be attached to the unit in the same way the test data can be downloaded. "REFLASHING!" will then appear.**

The software will be available from a CD or can be downloaded from our website. Contact Auto Meter for more information.

- A. Battery Positive
- B. Hot side of Key Switch
- C. Cold side of Key Switch
- D. Battery Positive on Solenoid
- E. S-Terminal
- F. Alternator Positive (output Terminal)
- G. Alternator Ground
- H. Starter Ground
- I. Frame Ground - Front
- J. Frame Ground - Back
- K. Battery Ground
- L. Hot Side of Mag Switch
- M. Cold Side of Mag Switch
- N. Mag Switch Coil Terminal
- O. Mag Switch Coil Terminal
- P. Motor Terminal
- Q. R-Terminal
- R. I-Terminal
- S. Remote Sense Terminal

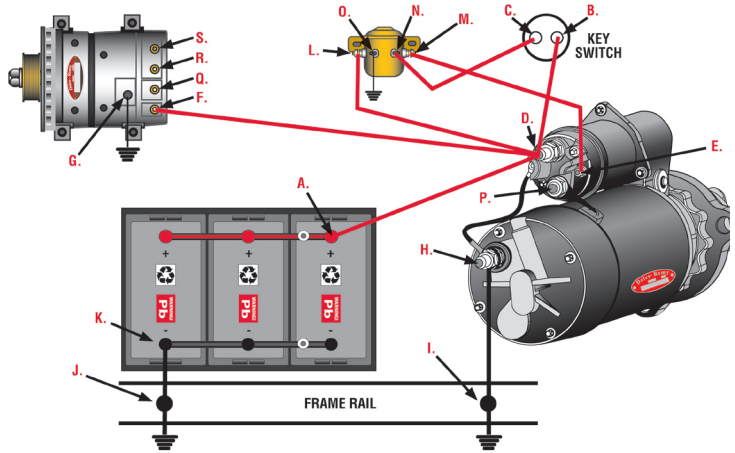



# Intelli-Check II™ Charging System Test

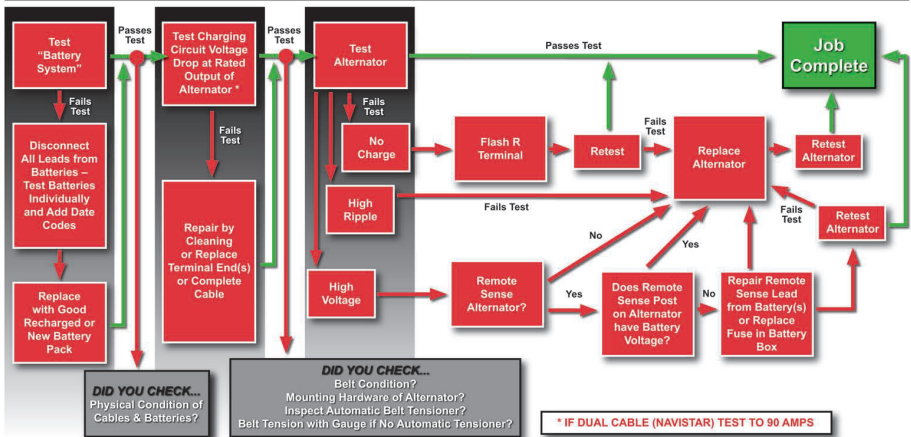

116106 © 2008 Remy Inc. All rights reserved.



# Intelli-Check II™ Cranking System Test

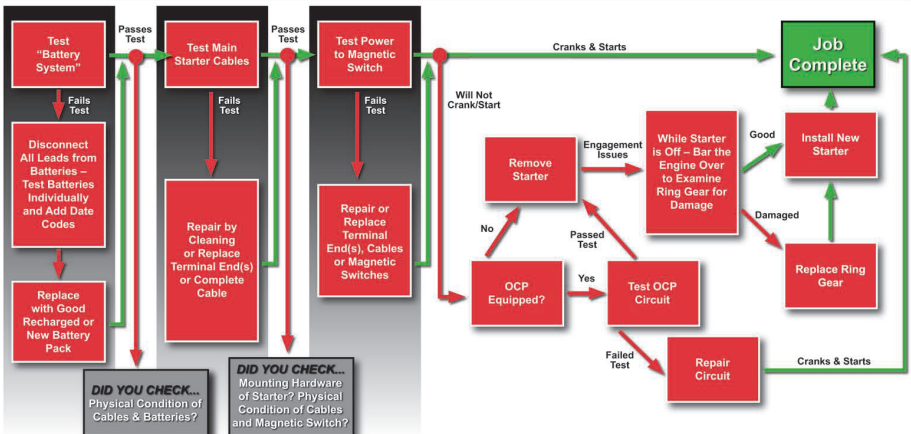

116107 © 2008 Remy Inc. All rights reserved.