

banks

with Installation Instructions

Owner's Manual

iDash[®] 1.8 Super Gauge

**2008 & later vehicles with CAN equipped OBDII,
No OBD Vehicles and Aftermarket ECU Vehicles.**

THIS MANUAL IS FOR USE WITH PART NUMBER 66560, 66560-DL, 66561,
66561-DL, 66562, & 66562-DL, 66563, 66563-DL

PROTECTED BY U.S. Patent 7,254,477 B1 U.S. Patent 7,593,808 B2

banks

Introduction

Welcome to the world of Banks iDash 1.8

Congratulations on your Banks iDash 1.8 (hereafter simply referred to as the **iDash**) purchase. You're about to discover that the iDash is designed to help you get the most out of your entire driving experience. Besides being fun and easy-to-use, the iDash's graphic, intuitive design makes each screen and feature a breeze to navigate. Use this manual to get you started.

With your iDash, you now have the most sophisticated and user friendly way to interact with your vehicle. Choose, select and change gauges in the display, change on-screen safety alerts, log vehicle data, interact with other Banks devices — all on-the-fly and at the touch of a button. With the iDash, you can also scan and clear OBDII diagnostic codes. It gives you virtually endless functionality and fits in an optional mount on your windshield or most mounts with a 52mm / 2¹/₁₆" hole. The iDash is a standalone vehicle data system that gives you the ability to monitor engine vitals that are not found on your factory dashboard display.

END USER LICENSE AGREEMENT (EULA)

IMPORTANT! READ CAREFULLY: This End-User License Agreement (“EULA”) is a legal agreement between you (either an individual or a single entity) later referred to as “LICENSEE” and Gale Banks Engineering (hereinafter referred to as “Company” for the software product related to the iDash and Banks AutoMind.

Programmer later referred to as “SOFTWARE”. By installing, copying, or otherwise using the SOFTWARE, you agree to be bound by the terms of this EULA. If you do not agree to the terms of this EULA, do not purchase, install or use the SOFTWARE.

Company or its suppliers may have patents, patent applications, trademarks, copyrights, or other intellectual property rights covering subject matter in this document. The furnishing of this document does not give you any license to these patents, trademarks, copyrights, or other intellectual property.

SOFTWARE LICENSE

Copyright laws and international copyright treaties, as well as other intellectual property laws and treaties protect the SOFTWARE. The SOFTWARE is licensed, not sold.

1. GRANT OF LICENSE.

This EULA grants LICENSEE the following rights:

—LICENSEE may use this SOFTWARE. “Use” of the SOFTWARE means that LICENSEE has loaded, installed, updated and/ or run the SOFTWARE on to a iDash, (latter referred to generally as “devices” or “device”).

—LICENSEE may not simultaneously use the SOFTWARE on more than one device unless they have purchased multiple devices for multiple vehicles.

—LICENSEE may use this SOFTWARE in compliance with all applicable laws and not for any unlawful purpose. - LICENSEE may make a copy of the licensed SOFTWARE for backup purposes.

2. DESCRIPTION OF OTHER RIGHTS AND LIMITATIONS.

—LICENSEE may not reverse engineer, recompile, and disassembly, modify, translate the SOFTWARE and make any attempt to discover the source code of the SOFTWARE.

—LICENSEE may not transfer, sell, re-sell, offer for sale or distribute the SOFTWARE.

The sale of and or distribution of copies of this SOFTWARE are strictly forbidden. It is a violation of this EULA to sell, loan, rent, lease, borrow, or transfer the use of copies of the SOFTWARE unless it is permitted by the terms and/or conditions of a separate agreement signed by Company.

3. DISCLAIMER OF WARRANTY.

THIS SOFTWARE AND THE ACCOMPANYING FILES AND/ OR UPDATES ARE DISTRIBUTED and SOLD “AS IS” AND WITHOUT WARRANTIES AS TO PERFORMANCE OR MERCHANTABILITY OR ANY OTHER WARRANTIES WHETHER EXPRESSED OR IMPLIED. LICENSEE USES THE SOFTWARE AT HIS/HER/ITS OWN RISK.

NO LIABILITY FOR CONSEQUENTIAL DAMAGES. To the maximum extent permitted by applicable law, in no event shall Company or its employees, contractors, agents, distributors or suppliers be liable for any special, incidental, indirect, or consequential damages whatsoever (including, without limitation, damages for loss of business profits, business interruption, loss of business information, loss of data, loss of business opportunity, loss or damages to property, injuries to any person or any pecuniary loss,) arising out of the use of or inability to use the SOFTWARE, even if Company has been advised on the possibility of such damages. In any case, Company’s entire liability under any provision of this EULA shall be limited EXCLUSIVELY TO PRODUCT REPLACEMENT.

4. GOVERNING LAW

This agreement shall be governed by laws of the State of California, U.S.A. applicable therein. You hereby irrevocably and submit to a court of proper jurisdiction in Los Angeles County, California, U.S.A., and any competent Courts of Appeal therefrom. If any provision shall be considered unlawful, void or otherwise unenforceable, then that provision shall be deemed severable from this license and not affect the validity and enforceability of any other provisions. Company reserves all rights not expressly granted here.

ACKNOWLEDGEMENT

By installing, copying, or otherwise using the SOFTWARE, you agree to be bound by the terms of this EULA. If you do not agree to the terms of this EULA, do not purchase, install or use the SOFTWARE.

Section 1:

SAFETY PRECAUTIONS

Always observe safety precautions!

Gale Banks Engineering urges you to always follow safety precautions. These pages include important information intended to prevent personal injury to yourself and/or others, and property damage.

Always be sure you carefully read and under-stand each precaution before moving on to the rest of the manual.

HANDLING PRECAUTIONS

- Never try to disassemble or modify the iDash in any way.
- Do not wipe with a wet cloth.

The iDash contains combustible and metal parts, so water and foreign substances can cause malfunction and create the risk of overheating due to wiring insulation failure, short circuiting, smoke, fire, combustion, and electric shock.

OUTDOOR PRECAUTIONS

When outdoors, avoid using the iDash anywhere it might get wet with rainwater or other moisture, and/or in dusty conditions. The iDash is not water resistant or dust resistant. Water and dust create the risk of fire and smoke, combustion, electric shock, resulting in damage and malfunction.

Never touch the iDash or its electronic accessories with wet hands. This will create the risk of electric shock, short circuiting or insulation failure, fire, smoke and combustion. Also, never allow the connector plugs to become wet.

Keep micro-SD cards out of the reach of small children as they may be swallowed. If you think this might have happened, Call 911 or consult your local emergency services (police, fire, or ambulance) immediately.

Do not touch the iDash or its OBDII cable if there is lightning in your area.

Lightning strikes create the risk of electric shock.

IN-VEHICLE PRECAUTIONS

Use this unit in 12V DC negative ground vehicles only.

WARNING: Below 32° F (0° C) or above 140° F (60° C), the iDash may be susceptible to damage as a result of extended direct exposure to sunlight, heat, or extreme cold. If the vehicle will be subjected to these conditions, we highly recommend that you remove the iDash from its mounting location. Gale Banks Engineering is not responsible for damage to the iDash resulting from exposure conditions.

Always drive in accordance with traffic rules and regulations. Failure to do so may result in traffic accident and injury to yourself and/or others.

Never take your eyes off the road to adjust the iDash settings or change screens while driving vehicle. Doing so can result in a traffic accident. Always stop your vehicle in a safe place before operating the unit. Only look briefly at the iDash screen images while operating your vehicle. Doing otherwise can take your mind off the road and create the risk of a traffic accident and injury to yourself and/or others. Do not set volume level too high. Blocking out the sound of other vehicles and traffic can create the risk of a traffic accident.

Never install the iDash in a location where it will interfere with operation of the motor vehicle, block the driver's view, or where it may endanger passengers. Installing the unit near the shift lever, brake pedals or other vehicle controls, or block front, side or rear vision, can create the risk of a traffic accident and cause injury to yourself and/or others. Never install the iDash where it can interfere with airbag operation. Do not install in a

SAFETY PRECAUTIONS, *continued*

location where deployment of the airbag cause the iDash or its parts to become projectiles. Also, be sure to check installation precautions for your exact vehicle model and year.

Make sure to install the iDash mount so it does not come off or fall down. Clean off any dirt and wax from the installation location, and install securely.

Periodically check the iDash mount installation and condition of the cradle.

PRECAUTIONS FOR USE IN VEHICLE

Use only the items that come with this unit and the Banks products it was designed to interface with. Use of non-specified items can damage the vehicle interior or result in a poor fit, creating the risk of accident, malfunction, or fire.

Install the iDash where it is out of the reach of small children. Failure to do so can cause an injury to the child or others due to mishandling of the iDash.

Do not install the iDash in a location where it will be splashed by water or subjected to large amounts of humidity, dust, or oil smoke. This can increase the risk of smoke, combustion, electric shock, and accident.

PRECAUTIONS DURING USE

- To protect the Liquid Crystal Display (LCD), avoid exposure to direct sunlight while not in use. Using a car sunshade or other means to block the sun is recommended.
- Do not clean the iDash while power is turned on. When wiping the LCD, use a dry soft, micro-fiber cleaning cloth.
- Do not use a paper towel to clean the screen.
- When transporting the iDash, make sure that the LCD screen does not come in contact with any foreign objects.

Precautions during use inside a motor vehicle: Always be sure to use the iDash in accordance with local rules and regulations.

Section 2:

MOUNTING AND CONNECTING THE iDASH

2.1 OBDII Connection

If installing into vehicle with OBDII communication (Standard):

1. Locate the OBDII port in your vehicle.

The OBDII port is located under the dash panel and can be found on either side of the steering wheel. Refer to your vehicles owner's manual if you are having difficulty locating the OBDII port. See **Figure 2-1**.

Figure 2-1

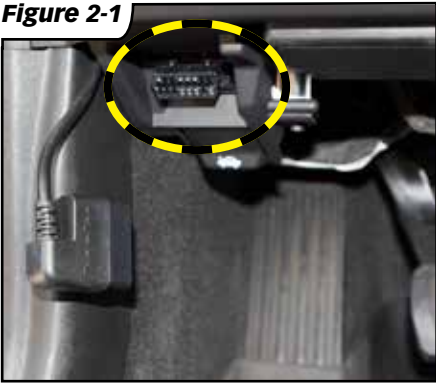

2. Connect the Banks OBDII Cable to the vehicle's OBDII port. See **Figure 2-1**.

NOTE: For some vehicle models the OBDII port may need to be disconnected from its mounting location.

Unclip or remove factory screws/bolts to relocate the OBDII port and allow the Banks OBDII connector to plug into the vehicles OBDII connector without bending or putting stress on the Banks OBDII cable. Secure the OBDII port under the dash

3. Route the Banks OBDII Cable to reach the iDash. See **Figure 2-7**.

NOTE: You may need to loosen or remove dash panel or covers to install the interface cable between dash crevices or behind dash panels.

4. Connect the Banks OBDII Cable to the 4-pin port on the iDash 1.8. See **Figure 2-3**.

Figure 2-2



6. Secure the Banks OBDII Cable away from any moving parts or sharp edges using the supplied cable ties.

Figure 2-3



MOUNTING AND CONNECTING THE iDASH, *continued*

2.2 No OBD or Aftermarket ECU Connection

Refer to iDash 1.8 Aftermarket ECU Setup Owner's Manual **97670** for aftermarket ECU wiring instructions.

2.3 General iDash 1.8 Mounting

If you bought an iDash 1.8 Gauge Pod or A-Pillar mount, follow the instructions provided in the kit.

All iDash 1.8 come with a Mounting Sleeve to mount to any aftermarket gauge mount. To install the iDash 1.8 with the provided hardware:

- 1.** Place the mounting sleeve behind the mounting surface and route the cables to the iDash 1.8 through.
- 2.** Connect cables (i.e. OBDII, Aftermarket ECU Harness, Starter Cable) to the iDash 1.8 4-Pin and 6-Pin Ports.
- 3.** Insert the iDash 1.8's studs through the Mounting Sleeve's holes.
- 4.** Hand tighten the nylon Thumb Nuts.

NOTE: If the mount used on the iDash 1.8 applies too much of a press fit, the iDash 1.8 buttons may become unresponsive.

Untighten or sand the aftermarket mount (Not the Mounting Sleeve) until you have a clearance fit. If you do not want to use the mounting sleeve, ensure the press fit is minimally applied so that the buttons remain functional.

Figure 2-4A

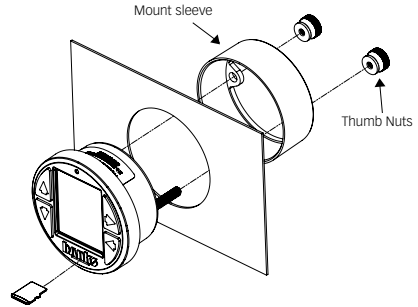
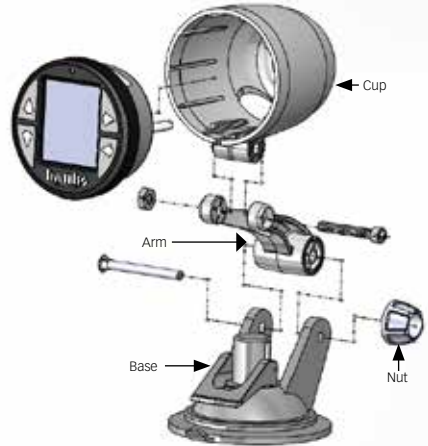

Figure 2-4B



MOUNTING AND CONNECTING THE iDASH, *continued*

2.4 B-Bus Network Termination

For multiple iDash Gauges and use with Banks Modules:

It is very important when communicating from one iDash 1.8 to another iDash 1.8 or B-Bus Module that there be **two (2) terminations**. Otherwise your primary iDash 1.8 will have trouble communicating to other devices on the network.

Depending on which **iDash 1.8 Hardware Revision** you have, you may have to use the **In-Cab Termination** **OR** the **Jumper Block Termination**.

ONLY the **Hardware Revision 2 iDash 1.8** will use the pre-installed **Jumper Block Termination**.

Check which iDash 1.8 Hardware Revision you have. Look behind the iDash 1.8 as shown in **Figure 2-5** to visually confirm the **Jumper Block Termination**. Alternatively you can check the "**Hardware Rev:**" in the "**System Information**" menu, as shown in **Figure 2-6**.

Figure 2-6

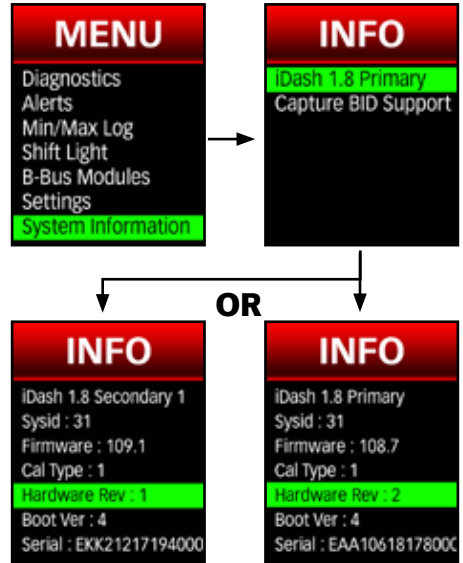

Figure 2-5



MOUNTING AND CONNECTING THE iDASH, *continued*

2.5 Simple B-Bus Network

The **simple B-Bus network** can consist of one iDash 1.8 Gauge, an In-Cab Terminator **OR** Jumper Block Termination, a B-Bus Starter Cable, a B-Bus Module, and a Black Termination Cap.

If using a single iDash Gauge:

1. If you have a HW Rev 1 iDash 1.8:

A. Connect the **Starter Cable** to the **In-Cab Terminator**. See **Figure 2-7, Step 2A**.

B. Connect the **In-Cab Terminator** to the **iDash 6-Pin Port**. See **Figure 2-8, Step 2B**.

2. If you have a HW Rev 2 iDash 1.8:

A. Connect the **Starter Cable** to the **iDash 6-Pin Port (Without the In-Cab Terminator)**. See **Figure 2-8**.

B. Confirm that the **Jumper Block** is connected to the **iDash 2-Pin termination**. See **Figure 2-7**.

Figure 2-7

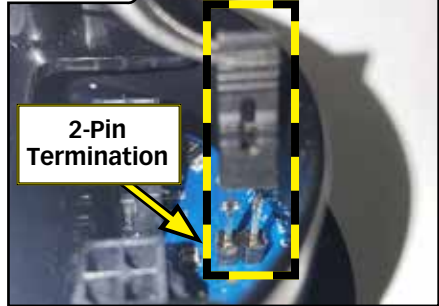
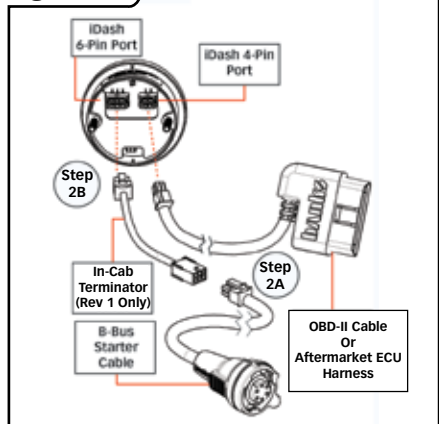
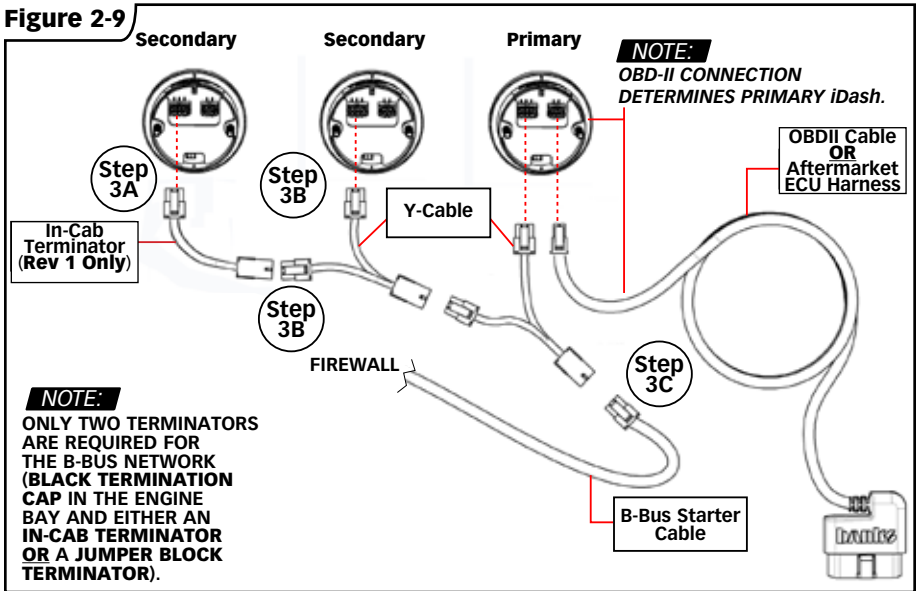

Figure 2-8



MOUNTING AND CONNECTING THE iDASH, *continued*

Figure 2-9



2.6 Advanced B-Bus Network

Up to three (3) additional iDash 1.8's can be added to the network; **maximum of four iDash 1.8 units.** Each additional iDash 1.8 requires a Y-Cable. See **Figure 2-9**.

The iDash 1.8 that has the OBD-II cable or aftermarket ECU harness plugged into it is referred to as the primary iDash 1.8. Only the primary iDash is capable of some features, such as:

- Vehicle Diagnostics (Reading/Clearing Codes and Emissions Readiness)
- Setting wake-up sensitivity
- Data logging
- Speed correction settings
- More

To start an Advanced B-Bus Network:

1. If you **ONLY** have HW Rev 1 iDash 1.8's

A. Connect the **In-Cab Terminator** to the **iDash 6-pin port**. See **Figure 2-9, Step 3A**. Only one **In-Cab Terminator** is required.

B. Connect the **Y-Cable** to the **In-Cab Terminator** and the second **iDash 1.8**. See **Figure 2-9, Step 3B**. For each additional **iDash 1.8**, a **Y-Cable** is used. See **Figure 2-9**.

C. Connect the **Starter Cable** to the **Y-Cable**. See **Figure 2-9, Step 3C**.

MOUNTING AND CONNECTING THE iDASH, *continued*

2. If you have ONLY HW Rev 2 iDash 1.8's:

B. Connect the **Y-Cable** to the **iDash 6-pin port** of the first and second **iDash 1.8 (Without the In-Cab Terminator)**. See **Figure 2-9**

C. Connect the **Starter Cable** to the **Y-Cable**. See **Figure 2-9, Step 3C**.

B. Remove extra **Jumper Blocks** from the added iDash 2-Pin terminations. See **Figure 2-7**.

NOTE: Only one Jumper Block Terminator is required.

3. If you have a HW Rev 1 AND Rev 2 iDash 1.8's

Follow either of the instructions for **Rev 1 OR Rev 2**, but only use a single terminator.

2.7 Part Number List

iDash and Data Input Cable

	P/N
iDash 1.8 SuperGauge CAN bus	62882
OBD-II CAN Bus	61300-35
Aftermarket ECU Cable	61301-36
Aftermarket ECU Termination Cable	61301-27

Banks Bus In Cab Cables

B-Bus Starter Cable	61301-20
B-Bus In Cab Terminator Cable (HW Rev 1).....	61301-23
B-Bus Termination Jumper (HW Rev 2)	61301-30
B-Bus In Cab Y-Adapter	61301-22
B-Bus Extension Cable (24")	61301-24
B-Bus Extension Cable (48")	61301-25

Banks Bus Under Hood Cables

B-Bus Under Hood Termination Cap	61300-22
B-Bus Under Hood Extension Cable (24")	61300-23
B-Bus Under Hood Extension Cable (48")	61300-24
B-Bus Under Hood Extension Cable (72")	61300-25

Section 3:

SOFTWARE INTRODUCTION AND NAVIGATION

3.1 Button Navigation

Press the **SELECT** button (see **Figure 3-1**) to enter menus or select an item. Holding down the button saves the current selection and returns to the **Gauge Screen**.

Use the **UP** button or **DOWN** button (see **Figure 3-1**) to change values or scroll through the menus. Hold down the button for rapid scroll/value change.

For the iDash 1.8 with Data Logging, holding the **DOWN** for two (2) seconds while viewing the **Gauge Screen** starts and stops data logging.

A single press of the **BACK** button (see **Figure 3-1**) returns you to the previous menu/screen. Holding down the button will return you to the **Gauge Screen**.

When data logging, the **BACK** button can be pressed while viewing the **Gauge Screen** to set laps or trigger points in a data log session.

Figure 3-1 – Button Function.



Section 3:

SOFTWARE INTRODUCTION AND NAVIGATION, *continued*

3.2 First Start-Up

NOTE: *It is recommended that you periodically check for software updates for best performance of your iDash 1.8".*

Once the iDash 1.8 is properly installed to the vehicle, it will wake-up and be ready for use when the vehicle engine is started.

The first time the iDash 1.8 is powered on it will instruct you to input your engines displacement in liters or in cubic inch units. This information is used in calculated parameters such as "**CFM Engine**." This can be changed at any time in "**Settings**"

After inputting your engine's displacement, the iDash 1.8 will display the "**Gauge Screen**" with the default "**5 Square Light**" layout (See **Figure 3-2**) which can be changed in the "**Gauge Selection**" menu (See "**Section 4: Gauge Selection on page 22**").

To access the main "**MENU**" screen you press the **Select** button .

When navigating through menus, the iDash will automatically return to the "**Gauge Screen**" after one (1) minute of inactivity.

Figure 3-2 – Start Up ("Gauge Screen")



3.3 Sleep Mode/Wake up

When the iDash 1.8 is connected while the vehicle is turned off, it will go into "**Sleep Mode**" after ten (10) seconds. There is no need to unplug the iDash 1.8.

To automatically wake-up the iDash 1.8 at vehicle ignition, the engine has to be running.

*It is also possible to wake-up the iDash 1.8 by pressing any of the buttons while the key is in the accessories-on position. It will only stay on for thirty (30) seconds and return to "**Sleep Mode**" if it does not see engine RPM.*

SOFTWARE INTRODUCTION AND NAVIGATION, *continued*

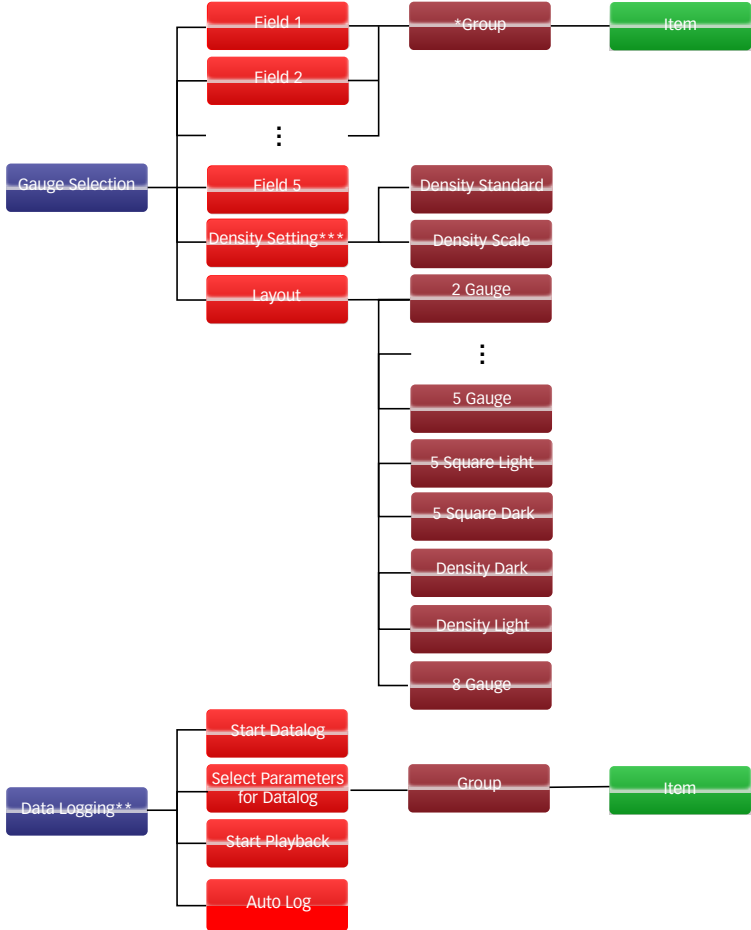

- *Group**

 - Air Density
 - Diagnostics
 - Emissions
 - Engine Performance- Air
 - Engine Performance- Fuel
 - Pressure
 - Speed and Velocity
 - Temperature
 - Transmission
 - Voltage
 - Vehicle Performance

****If equipped**

SOFTWARE INTRODUCTION AND NAVIGATION, *continued*



Continued on the next page

SOFTWARE INTRODUCTION AND NAVIGATION, *continued*

Continued from last page



SOFTWARE INTRODUCTION AND NAVIGATION, *continued*

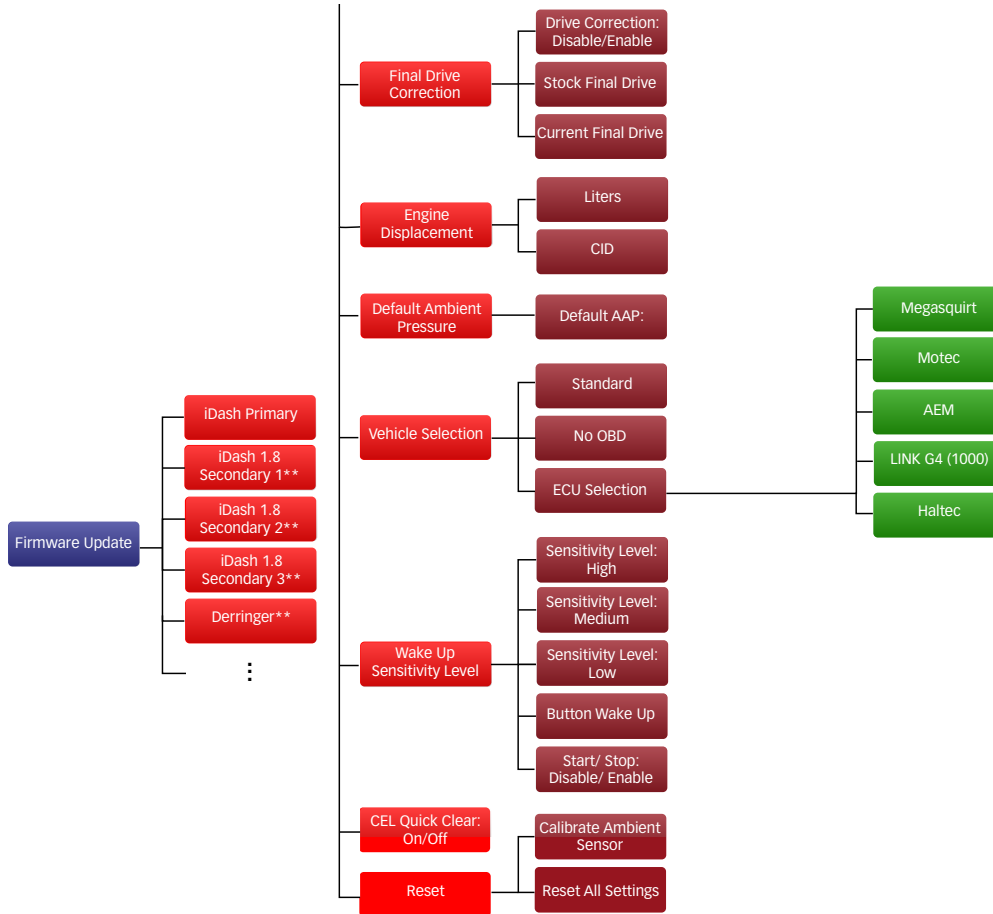

Section 4: GAUGE SELECTION

The "**Gauge Selection**" menu allows you to select various gauge layouts and parameters.

4.1 Gauge Screen

This menu allows you to set the layout of the **Gauge Screen**. The user can select the number of parameters to display or other special Banks layout screens, if available.

4.1.1 Number of Gauges

To modify the number of gauges displayed:

1. Go to "**MENU**" and select "**Gauge Selection.**"

2. Select "**Layout.**"

NOTE: The "**Layout**" menu can also be accessed in the "**Settings**" menu. See "**11.1 Layout**" on page 34.

3. Select the desired layout and you will automatically be returned to the **Gauge Screen**.

4.1.2 Parameter Selection

To change iDash 1.8's displayed parameters (See **Figure 4-1**):

1. Go to "**Menu**" and select "**Gauge Selection.**" See **Step A, B.**

2. Select a "**Field #**" to change the parameter. See **Step C.**

3. Select a "**GROUP**" parameter. See **Step D.**

4. Select an "**ITEM**" parameter to display. See **Step E.**

5. Hold the **BACK** button to return to the **Gauge Screen** and your new parameter will be displayed. See **Step F.**

6. Or select **BACK** to take you back to "**Gauge Selection**" to change another parameter. See **Step G.**

NOTE: Gauge units can be changed in "**Settings**" (see "" on page 39).

Figure 4-1 - Parameter Selection

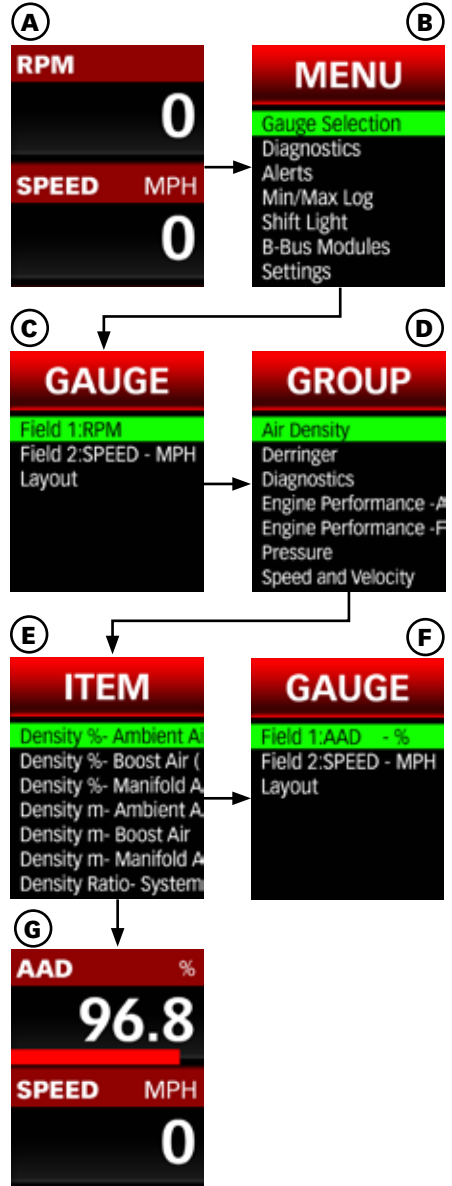

GAUGE SELECTION, *continued*

4.2 Density Layout

A detailed explanation of the Banks Density System is available in the glossary ("**14.1 Banks Engine Air Density System Overview**" on page 50).

NOTE: *Density is calculated from various vehicle sensors and will only be available if your vehicle is equipped with the proper sensors.*

To select the Density layout follow the instructions in "**4.1.1 Number of Gauges**" and select the "**Density Dark**" or "**Density Light**" layout. You will automatically be returned to the "**Gauge Screen**."

4.2.1 Field 1 Parameter Selection

In this layout, only "**Field 2**" through "**Field 4**" can be changed with user selectable parameters. "**Field 1**" of this layout is configured to only display "**MAD**" (Manifold Air Density) or "**BAD**" (Boost Air Density).

To change, press the "**Select**" button on "**Field 1**" to switch between these options

4.2.2 Density Bar Graph

When displaying "**MAD**," the green dashed line indicates your current "**AAD**" (Ambient Air Density). The red and blue section of the bar graph represents "**MAD**" (considering 0 to be the same baseline for "**AAD**" and "**MAD**"). See **Figure 4-2**.

If the MAD bar graph is only blue, your MAD is less than AAD. If the Bar graph is blue and red, the red portion of the bar graph represents your current boost air density (**BAD**).

When displaying "**BAD**," only the blue bar graph will be displayed.

To adjust the scaling on the bar graph shown in "**Field 1**" of the Density layout:

1. Select "**Gauge Selection**" from the main menu.
2. Press select on "**Density Scale:**" to change the scaling of the bar graph. Options are **125, 200, 300, 400** and **500**.

Figure 4-2 – Density Light Layout

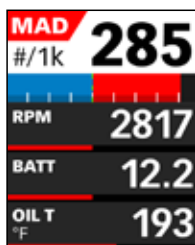

Section 5: DATA LOGGING (IF EQUIPPED)

Figure 5-1 – Data Logging Menu

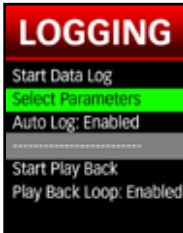

Data logging saves (*.CSV files) to any Micro SD card (all classes) as ".CSV" files at 0.1 sec intervals. Up to 100 parameters can be recorded at the same time but as the number of recorded parameters are increased, the recording rate will decrease, so only record the parameters you need.

NOTE: *Logged data will have 1 more digit than displayed, i.e., MAP 15.1 is displayed, but MAP 15.13 will be logged.*

When viewing the **Gauge Screen** of the primary iDash 1.8, a green dot at the top of the display will flash indicating that the device is logging. When logging is turned off, this dot will not appear.

NOTE: *Data logging is only available on the primary gauge. If you have multiple gauges, only one of them needs to be a data logging equipped gauge.*

5.1 Change Parameters to be Data Logged

To remove parameters from being recorded:

1. Select "**Data Logging**" from the main "**MENU**."
2. Select "**Select Parameters**"
3. Select the individual parameter(s) to be removed (See **Figure 5-2**). You can multi select parameters in this list. The non-highlighted (See **Step B**)

parameter will not be recorded and will be removed from the list once you exit the screen.

4. Or select "**CLEAR ALL BIDS**" to remove all parameters. See **Figure 5-2**.

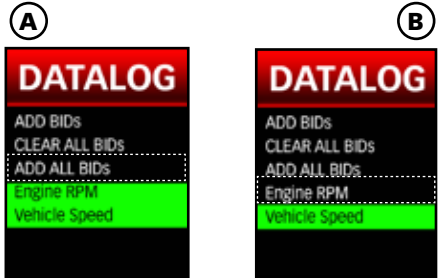

To set new vehicle parameters to record:

5. Select "**Data Logging**" from the main "**MENU**."
6. Select "**Select Parameters**." See **Figure 5-1**.
7. Select "**ADD BIDS**." See **Figure 5-3**.

Figure 5-2

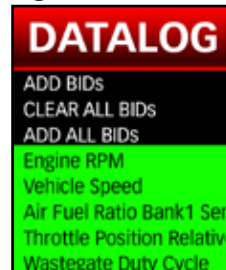

Alternatively, you can select "**ADD ALL BIDS**" to record all available parameters. See **Figure 5-2, A**.

DATA LOGGING (IF EQUIPPED), *continued*

8. Select a "GROUP" parameter.
9. Select one or more "ITEM" parameters to record. The parameter will be highlighted if selected. See **Figure 5-4**.

Figure 5-3

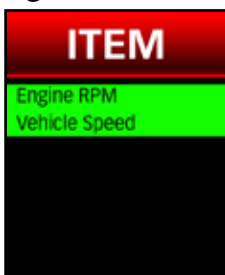

10. Press **BACK** to return to the "GROUP" menu and select more parameters from another group if desired.
11. Return to the "Datalog" menu. The screen will list all the highlighted parameters to be recorded. See **Figure 5-2, A**.
12. Once the parameter list for data logging is as desired, return to the **Gauge Screen**.

5.2 Start/Stop Data Log

To start and stop a data log (Method 1 of 2):

NOTE: A Micro SD card must be inserted into the card slot on the front face of the iDash 1.8 in order for data logging to begin. Each time a data log is stopped, a new CSV file containing the recorded data will be saved onto the Micro SD card.

1. Select "Data Logging" from the main "MENU."
2. Select "Start Data Log" to start recording parameters (See **Figure 5-1**). A banner will appear stating

"**Start Data Logging: Log###.csv**" once started.

NOTE: If no card is inserted, the device will display "**SD card is Not Ready.**"

3. On the "LOGGING" menu screen, select "Stop Data Log." A banner will appear stating "**Stop Data Logging: Log###.csv**" once stopped.

To start and stop a data log (Method 2 of 2):

4. While viewing the **Gauge Screen** hold the **DOWN** button for 2 seconds to start a new data log. A banner will appear stating "**Start Data Logging: Log###.csv**" once started.
5. To then stop the data log, while viewing the **Gauge Screen** hold the **DOWN** button for 2 seconds. A banner will appear stating "**Stop Data Logging: Log###.csv**" once stopped.

5.3 Auto-Log Feature

When enabled, this feature will automatically start data logging at vehicle startup. After this first log, data logging will need to be activated as stated in "5.2 Start/Stop Data Log."

If the Micro SD card is plugged in after the vehicle is started, the iDash 1.8 will automatically start data logging once the Micro SD card is recognized.

Parameters logged will be the parameters set before the iDash 1.8 went into "**Sleep Mode.**"

To end the log, hold the "**DOWN**" button while on the **Gauge Screen** until the iDash 1.8 states "**Stop Data Logging: Log###.csv**".

DATA LOGGING (IF EQUIPPED), *continued*

To enable "Auto Log":

1. Select "**Data Logging**" from the main "**MENU**."
2. Select "**Auto Log**:" to enable or disable. See **Figure 5-1**.

5.4 Data Play Back on Gauge(s)

The iDash 1.8 playback feature allows you to view the recorded data on the **Gauge Screen** of all connected iDash 1.8's.

When viewing the **Gauge Screen** of the primary iDash 1.8, a blue box at the top of the display will flash indicating playback mode is on. When playback is turned off, this indicator will not appear.

To set up play back:

1. Select "**Data Logging**" from the main "**MENU**."
2. Select "**Start Play back**" to open the list of saved data logs currently on the Micro SD card. See **Figure 5-1**.
3. Select the desired data log file for play back.
4. Configure the **Gauge Screen** layout and parameters displayed to show the parameters that were recorded. See "**Section 4: Gauge Selection**" for instructions on set up.

TIP: A useful parameter to display on the **Gauge Screen** during playback mode is "**Time Data Log**."

NOTE: At any time, parameters displayed on the **Gauge Screen** can be changed during play back.

The data will begin playing on the iDash **Gauge Screen**. The blinking

blue box at the top indicates that playback is active.

NOTE: Only parameters that were recorded on the log will be able to be shown. If a parameter shows "--" it was most likely not configured as a logged parameter at the time of the data log recording.

Navigating playback options during playback mode:

To pause data playback, press the **BACK** button on the iDash 1.8.

To resume data playback, press the **BACK** button a second time.

While data playback is paused, pressing the **UP** or **DOWN** buttons will move ahead or back one line of data per press (0.1 seconds). Holding the **UP** or **DOWN** buttons will skip 5 seconds at a time.

While data playback is running, pressing the **UP** or **DOWN** buttons will skip ahead or back by 5 seconds. Holding the **UP** or **DOWN** buttons will skip 30 seconds ahead or back

Section 6: DIAGNOSTICS

6.1 Vehicle Diagnostics Trouble Codes (DTC's)

See the cause of your vehicle's "check engine" light! With the iDash 1.8, you can read and clear vehicle manufacturer trouble codes.

To access vehicle diagnostics menu:

1. Select **"Diagnostics"** from the main **"MENU."**
2. Select **"Vehicle"** for vehicle diagnostics. See **Figure 6-1.**

Figure 6-1

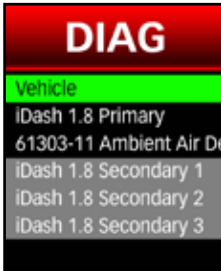

NOTE: *Vehicle must be stopped to access vehicle diagnostics.*

To check for all vehicle DTC's present:

In the vehicle diagnostics menu, select **"Check Vehicle Codes"** to read vehicle trouble codes. See **Figure 6-2.**

If vehicle codes are present, a list will appear below as shown in **Figure 6-2.** Write down the trouble code number and description before clearing.

To save codes to SD card:

If you have a microSD card installed, the codes will also be saved as a CSV file to your microSD card.

To view freeze frame data:

If the code has a "*" preceding it, if you click on the code it will pull up the

freeze frame data associated with that code.

To clear all vehicle DTC's present:

In the vehicle diagnostics menu, select **"Clear Vehicle Codes"** to erase vehicle trouble codes. See **Figure 6-2** and **Figure 6-3.**

Figure 6-2 - Vehicle Diagnostics



Figure 6-3

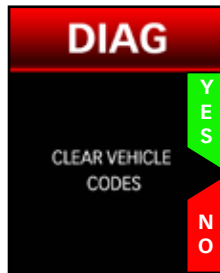

Diagnostic trouble codes and/or check engine light may recur if the cause of the code is not repaired prior to clearing the codes.

NOTE: *Some vehicle require that the engine be turned off to clear codes. Follow message prompts if your vehicle has this requirement.*

DIAGNOSTICS, *continued*

6.2 Vehicle Emissions Readiness

Check your vehicle's emissions readiness to test and see whether or not your vehicle's emission system is operating normally.

1. Select "**Diagnostics**" from the main "**MENU.**"
 2. Select "**Vehicle**" for vehicle diagnostics. See **Figure 6-1.**
 3. Select "**Check Emission Readiness**" for a list of supported emissions monitors. See **Figure 6-2.**
- "**YES**" indicates that the monitor has passed its test and the system is operating correctly. See **Figure 6-4.**
- "**NO**" indicates that the monitor has either failed the test or that the test has not completed. See **Figure 6-4.**
4. Scroll through the list of monitors and return to the **Gauge Screen** when finished.

NOTE: *The following may reset your monitors:*

- Clearing diagnostic trouble codes
- Loss of power to the vehicle by a dead or disconnected battery

Figure 6-4 - Emissions Check



Section 7: MIN/MAX VALUES

Each iDash 1.8 keeps an updated record of key parameter minimum/maximum values for you to view or reset.

NOTE: Some vehicles report a very large value for an instant during vehicle power down. This might cause an inaccurate maximum log

To view and/or clear your Minimum or Maximum Logs:

1. Select "**Min/Max Log**" from the main "**MENU**." See **Figure 7-1, A**.
2. Select either "**Maximum Log**" or "**Minimum Log**" to access logs. See **Figure 7-1, B**.
3. To reset all current min/max values to zero, select "**CLEAR ALL**." See **Figure 7-1, C & D**.

Maximum and minimum values are recorded for parameters on the **Gauge Screen** and on the "**Background alerts**" list. Min/Max values are recorded regardless if alerts are enabled or disabled.

Figure 7-1

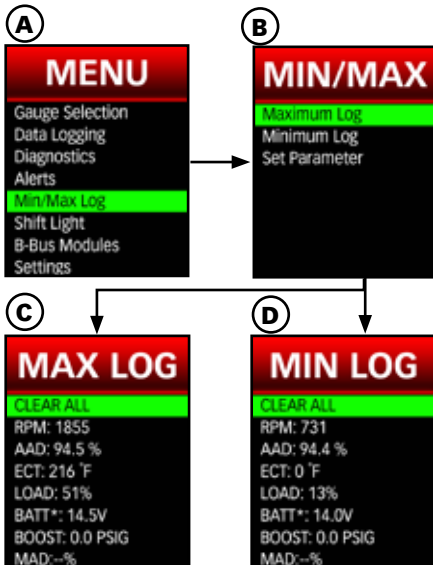

NOTE: The parameter list in the "**Min/Max Log**" is linked to the "**Background Alerts**" and Displayed "**Alerts**" lists. Adding, removing, or changing these alerts in one menu will change the alerts in the other.

To add/change parameters in the "Min/Max Log" list:

1. Select "**Min/Max Log**" from the main "**MENU**."
2. Select "**Set Parameter**."
3. Select any "**Alert #:**" to change.

NOTE: The "**Field #**" list can only be modified in the **Gauge Selection** menu.

4. Select "**Change Parameter**."

NOTE: If the alert is empty, you will be skipped to **Step 5**.

5. Select a "**GROUP**" parameter.
6. Select an "**ITEM**" parameter to change. You will be returned to the parameter's alert options.

Section 8: ALERTS

The iDash 1.8 allows users to configure alerts notifying the operator that a parameter has exceeded its set limit.

All alerts can be disabled/enabled and can be set to go off for a maximum or a minimum value. See **Figure 8-1, C**.

After an alert limit is tripped, a banner will appear, displaying a large banner with the parameter alert name for 3 seconds. See **Figure 8-1, D**.

If the alert limit continues to be exceeded for displayed parameters, the gauge will blink red (see **Figure 8-1, E**). If the alert limit continues to be exceeded for background alerts, a small banner in the top left corner will appear and it will cycle through each alert for ~1 second (if there is more than one background alert limit exceeded).

NOTE: All alerts must be configured for each individual iDash 1.8.

8.1 Displayed Gauge Alerts

In the Displayed "**Alerts**" menu, the parameter list will be the same as the **Gauge Selection** menu. To change the parameters of the Displayed "**Alerts**," the parameters must be changed from the **Gauge Selection** menu. See "**4.1.2 Parameter Selection**" for directions.

NOTE: If a parameter is already enabled and set up as a background alert, its settings will transfer to a displayed gauge alert.

To enable and configure gauge alerts:

1. Select "**Alerts**" from the main "**MENU**." See **Figure 8-1, A**.
2. Select a "**Field #**" with the parameter of interest. See **Figure 8-1, A**.

3. Select "**Alert High Enable**" and/or "**Alert Low Enable**" to turn "**On**" or "**Off**" the alert. See **Figure 8-1, B & C**.

4. Select "**Alert High**" and/or "**Alert Low**" to adjust the alert activation point value. See **Figure 8-1, C**.

5. Scroll **UP** or **DOWN** to adjust the activation point.

6. Hold **SELECT** to save the value and return to the **Gauge Screen** or return to the Displayed "**Alerts**" menu to configure other alerts.

Figure 8-1

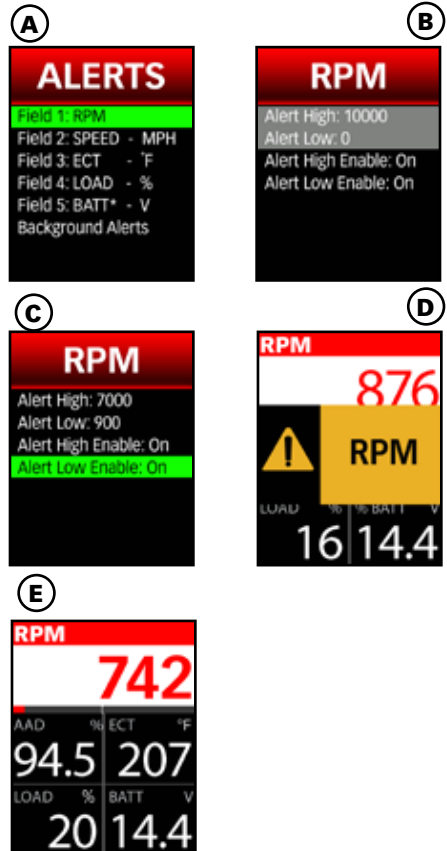

ALERTS, *continued*

8.2 Background Alerts

Background alerts are for a list of user selected parameters that are constantly being monitored by the iDash (when enabled), even when they are not being displayed on a gauge.

Unlike the displayed gauge alerts, background alert parameters are selected in the Background Alerts menu.

To change a background alert parameter:

NOTE: *The alerts list in the "Min/Max Values" menu are linked to the "Background Alerts" parameter list. Adding, removing, or changing these alerts in one menu will change the alerts in the other.*

1. Select **"Alerts"** from the main **"MENU."**
2. Select **"Background Alerts."** See **Figure 8-2, A.**
3. Select any **"Alert #:"** to change. See **Figure 8-2, B.**

NOTE: If the alert is empty, it will be skipped to **Step 5.**

4. Select **"Change Parameter."** See **Figure 8-2, C.**
5. Select a **"GROUP"** parameter. See **Figure 8-2, D.**
6. Select an **"ITEM"** parameter to change the background alert to (see **Figure 8-2, E**). You will be returned to the parameter's alert options.

To enable and configure background alerts:

1. Select **"Alerts"** from the main **"MENU."**
2. Select **"Background Alerts."** See **Figure 8-2, A.**

3. Select the **"Alert #:"** of interest. See **Figure 8-2, B**

4. Select **"Set Limit."** See **Figure 8-2, C.**

5. Select **"Alert High Enable"** and/or **"Alert Low Enable"** to turn **"On"** or **"Off"** the alert. See **Figure 8-1, B.**

6. Scroll **UP** or **DOWN** to adjust the activation point value.,

7. Hold **SELECT** to save the value and return to the **Gauge Screen** or return to the **"Background Alerts"** menu to configure other alerts.

Figure 8-2

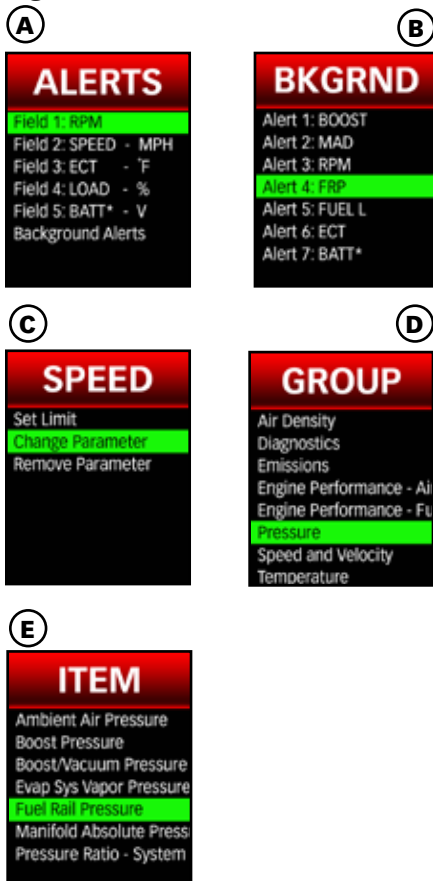

Section 9: SHIFT LIGHT

The iDash features a user configurable shift light for you to set to any desired RPM and change to any of the **23 colors** available.

When enabled, the shift light will take priority over all other alerts (see **Figure 9-2**) and will remain on the display as long as RPM is over the defined trigger RPM. The shift light will disappear from the display after engine RPM drops 300 RPM below the set trigger point.

To enable/disable the shift light and set the trigger rpm:

1. Select "**Shift Light**" from the main "**MENU.**"
2. Select the first item in the "**Shift Light**" menu to turn it "**On**" or "**Off**". See **Figure 9-1, A**.
3. Select "**Set RPM.**" See **Figure 9-1, B**.
4. Scroll **UP** or **DOWN** (see **Figure 9-1, B**) in increments of 100 RPM to set the trigger point at which the shift light will illuminate.

NOTE: Due to data communication delay of vehicle OBD-II, you may need to set your shift light RPM lower than your desired shift point.

To adjust shift light text and/or background color:

5. Select "**Shift Light**" from the main "**MENU.**"
6. Select "**Set Shift Light Font Color**" to change text color.
7. Scroll (**UP** or **DOWN**) through the list and press "**YES**" to select a color. Pressing "**NO**" will take you back to the "**Shift Light**" menu.
8. "**Set Shift Light Background Color**" to customize the look of your shift light.

9. Scroll **UP** or **DOWN** through the list and press "**Yes**" to select a color. Pressing "**No**" will take you back to the "**Shift Light**" menu.

10. Return to the **Gauge Screen** when finished.

Figure 9-1 – Shift Light Menu

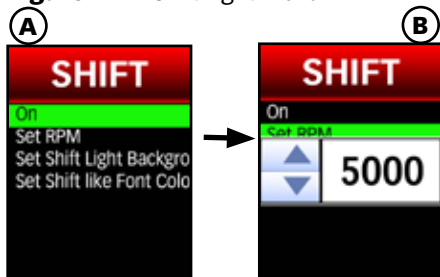

Figure 9-2 – Shift Light



Section 10:

B-BUS MODULES

The "**B-Bus Modules**" menu allows you to configure and/or control modules that are on the B-Bus system. Only connected Banks modules will show up in this section.

To access the menu:

1. Select "**B-Bus Modules**" from the main "**MENU**."
2. Scroll through the list and select the module you would like to configure.

See Owners Manual **97660** for more detailed information.

Modules coming soon are:

Banks 4-Channel Analog Module

Banks 4-Channel Thermocouple
Module

Section 11: SETTINGS

The iDash 1.8 features many customizable settings allowing for personalization. Most user configurable settings can be adjusted in the "Settings" menu.

11.1 Layout

This menu allows you to set up the number of gauges to display.

1. Go to "MENU" and select "Settings"
2. Select "Layout."

NOTE: The "Layout" menu can also be accessed in the "Settings" menu. See "4.1 Gauge Screen" on page 22.

3. Select the desired layout and you will automatically be returned to the "Gauge Screen."

11.2 Brightness

In this menu, customizing the brightness of your Dash 1.8's buttons and LCD screen is made easy.

All iDash 1.8 come with an "Auto-Dimming" feature that senses the ambient light conditions and adjusts the brightness of the buttons and LCD screen.

If you purchased the iDash 1.8, "Hardware Rev: 2," you will have the additional feature of changing button color. To check if you have this model, follow the instructions in "Section 12: System Information" on page 45 then look at the "Hardware Rev: #."

Figure 11-1

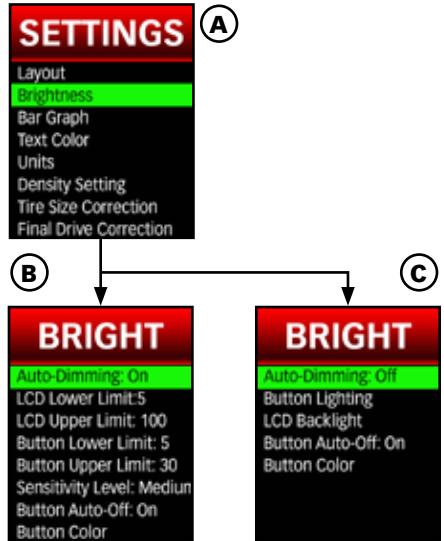

11.2.1 Auto-Dimming

"Auto-Dimming" can be configured to limit the range of brightness and its sensitivity to changes in ambient conditions.

If you do not desire to use this feature, "Auto-Dimming" can be deactivated. The LCD and button brightness can still be set to one constant brightness no matter what the ambient light conditions are.

NOTE: Brightness settings saved will not reset when switching between "Auto-Dimming" disabled and enabled.

To enable/disable "Auto-Dimming":

1. Select "Settings" from the main "MENU."
 2. Select "Brightness."
- See **Figure 11-1, A.**

Section 11:

SETTINGS, *continued*

3. Select "**Auto-Dimming**" to toggle **ON** or **OFF**. See **Figure 11-1, B & C**.

NOTE: The "**Brightness**" menu will change depending on the status of "**Auto-Dimming**."

11.2.2 Sensitivity Level

NOTE: Only available when "**Auto-Dimming**" is "**ON**."
See **Figure 11-1, B**.

This controls how sensitive the iDash device is to changes in ambient light.

If the sensitivity level is set to high, the display brightness will change often and at low sensitivity, it will change slowly.

To adjust auto-dimming sensitivity:

1. Select "**Settings**" from the main "**MENU**."

2. Select "**Brightness**."
See **Figure 11-1, A**.

3. Select "**Sensitivity Level**."
See **Figure 11-1, B**.

4. Adjust the sensitivity level ("**Low**," "**Medium**," or "**High**") and select the desired setting to save.

11.2.3 LCD Brightness Upper/Lower Limit

NOTE: Only available when "**Auto-Dimming**" is "**ON**."
See **Figure 11-1, B**.

The brightness of the display can be limited to a defined low brightness setting and high brightness setting for Auto-Dimming to adjust between these limits.

To adjust the LCD Brightness Upper/Lower Limit:

1. Select "**Settings**" from the main "**MENU**."

2. Select "**Brightness**."
See **Figure 11-1, A**.

3. Select "**LCD Lower Limit**."
See **Figure 11-1, B**.

A. Scroll **UP** or **DOWN** to adjust the LCD screen brightness for dark conditions (0-100%). The screen will display the brightness value shown.

B. Select the desired value to save the setting.

4. Select "**LCD Upper Limit**."
See **Figure 11-1, B**.

A. Scroll **UP** or **DOWN** to adjust the LCD screen brightness for bright conditions (0-100%). The screen will display the brightness value shown.

B. Select the desired value to save the setting.

5. Return to the **Gauge Screen** when finished.

11.2.4 Button Brightness Upper/Lower Limit

NOTE: Only available when "**Auto-Dimming**" is "**ON**."
See **Figure 11-1, B**.

To adjust the Button Brightness Upper/Lower Limit:

1. Select "**Settings**" from the main "**MENU**."

2. Select "**Brightness**."
See **Figure 11-1, A**.

3. Select "**Button Lower Limit**."
See **Figure 11-1, B**.

Section 11: **SETTINGS**, *continued*

A. Scroll **UP** or **DOWN** to adjust the button brightness for dark conditions (0-100%). The buttons will display the brightness value shown.

B. Select the desired value to save the setting.

4. Select "**Button Upper Limit.**"
See **Figure 11-1, B.**

A. Scroll **UP** or **DOWN** to adjust the LCD screen brightness for bright conditions (0-100%). The screen will display the brightness value shown.

B. Select the desired value to save the setting.

5. Return to the **Gauge Screen** when finished.

11.2.5 LCD Backlight

NOTE: Only available when "**Auto-Dimming**" is "**OFF.**"
See **Figure 11-1, C.**

This setting will determine the brightness of the LCD when "**Auto-Dimming**" is off.

To adjust the LCD Brightness:

1. Select "**Settings**" from the main "**MENU.**"

2. Select "**Brightness.**"
See **Figure 11-1, A.**

3. Select "**LCD Backlight.**"
See **Figure 11-1, C.**

4. Scroll **UP** or **DOWN** to adjust the LCD screen brightness for all conditions (0-100%). The screen will display the brightness value shown.

5. Select the desired value to save the setting.

6. Return to the **Gauge Screen** when finished.

11.2.6 Button Lighting

NOTE: Only available when "**Auto-Dimming**" is "**OFF.**"
See **Figure 11-1, C.**

This setting will determine the brightness of the buttons when "**Auto-Dimming**" is off.

To adjust the button brightness:

1. Select "**Settings**" from the main menu and then select "**Brightness.**"
See **Figure 11-1, A.**

2. Select "**Button Lighting.**"
See **Figure 11-1, C.**

3. Scroll **UP** or **DOWN** to adjust the button LED brightness for all conditions (0-100%). The buttons will display the brightness value shown.

4. Select the desired value to save the setting.

5. Return to the "**Gauge Screen**" when finished.

11.2.7 Button Auto-Off

"**Button Auto-Off**" is a feature that turns off the button LED's after ~10 seconds of inactivity on the "**Gauge Screen.**" This feature can be disabled to have the button LED's always on.

To enable/disable "Button Auto-Off":

1. Select "**Settings**" from the main menu and then select "**Brightness.**"
See **Figure 11-1, A.**

2. Select "**Button Auto-Off:**" to toggle "**On**" or "**Off.**"
See **Figure 11-1, B** or **C.**

3. Return to the **Gauge Screen** when finished.

Section 11:

SETTINGS, *continued*

11.2.8 Button Color

NOTE: Only available for "Hardware Rev: 2" iDash 1.8.

To adjust the button's LED color:

1. Select "**Settings**" from the main "**MENU**."
 2. Select "**Brightness**."
See **Figure 11-1, A**.
 3. Select "**Button Color**."
See **Figure 11-1, B or C**.
 4. Scroll **UP** or **DOWN** through the color selection screen and press "**Yes**" to select a color. The button LEDs will display the described color. See **Figure 11-2**.
- Pressing "**No**" will take you back to the "**Brightness**" menu.
5. Return to the **Gauge Screen** when finished.

11.3 Bar Graph

For layouts "2 Gauge" to "5 Square Light" there is a bar graph representation of the parameter values on the **Gauge Screen**.

In the "Bar Graph" menu, the bar graphs can be disabled/enabled, have the color changed, and adjust the min/max values represented.

Figure 11-2

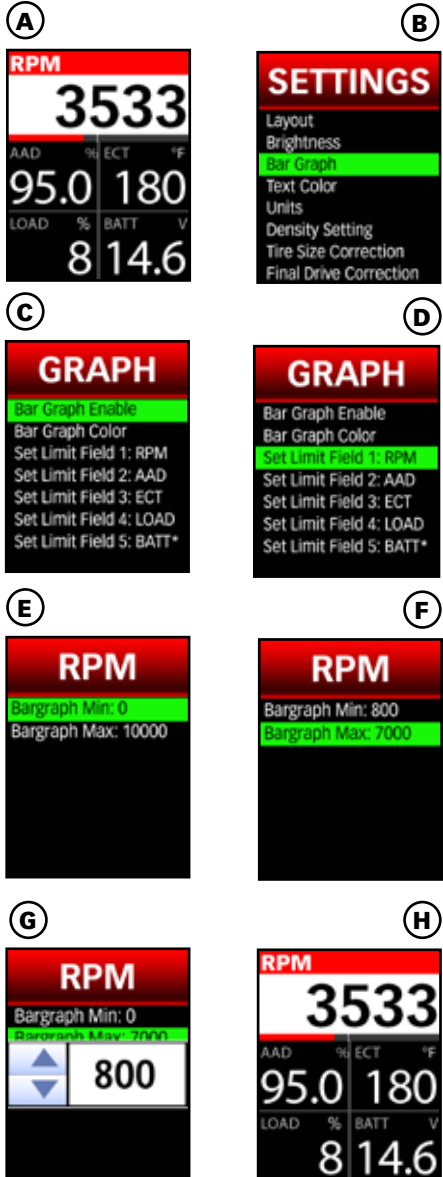

Section 11:

SETTINGS, *continued*

11.3.1 Enable/Disable Bar Graphs

When bar graphs are disabled, all graphs are removed from the display except for the bar graph in "**Field 1**" in the density layout. The density bar graph will be shown at 100%.

NOTE: This setting will not effect the Derringer Tuner power output bar graph.

To enable or disable the bar graphs:

1. Select "**Settings**" from the main "**MENU**."
2. Select "**Bar Graph**."
3. Select "**Bar Graph: Enable**" or "**Bar Graph: Disable**" to toggle the bar graphs on or off.
4. Return to the **Gauge Screen** when finished.

11.3.2 Bar Graph Color

The bar graphs displayed are user configurable to the **23 colors** available.

NOTE: Neither the density bar graph nor the Derringer Tuner power level bar graph does not support color customization.

To change the color of the bar graphs:

1. Select "**Settings**" from the main menu and then select "Bar Graph."
2. To change the color of the bar graphs, select "**Bar Graph Color**" to enter the color selection screen and then select a bar graph color. You will be returned to the previous screen.
3. Return to the **Gauge Screen** when finished.

11.3.3 Bar Graph Limits

Each bar graph can have the maximum and minimum value displayed changed.

The bar graph limit settings are not saved when the parameter is removed from the Gauge Screen, so the setting will have to be reconfigured every time a parameter is changed.

NOTE: The density bar graph does not support configurable limits, but can be scaled as explained in "**4.2.4 Density Bar Graph**".

To set the min and max values displayed on the bar graphs:

1. Select "**Settings**" from the main "**MENU**."
2. Select "**Bar Graph**."
3. Select a parameter "**Set Limit Field #:**" to adjust the bar graph.
4. Select "**Bargraph Min:**" or "**Bargraph Max:**"
5. Scroll **UP** or **DOWN** through the values. Select the value to save the setting.
6. Return to the "**Bar Graph**" menu and repeat this process to adjust any other parameter listed.
7. Return to the **Gauge Screen** when finished.

Section 11: SETTINGS, *continued*

11.4 Text Color

Customize the look of your gauge display by selecting from one of 23 different text colors. All text in the menu and Gauge Screen will show the color selected.

Text on alerts, the shift light, and notification banners will remain unchanged by this setting.

To change the text color setting:

1. Select **"Settings"** from the main **"MENU."**
2. Select **"Text Color"** to enter the color selection screen.
3. Scroll **UP** or **DOWN** through the color selection screen and press **"Yes"** to select a color. Pressing **"No"** will take you back to the **"Settings"** menu.
4. Return to the **Gauge Screen** when finished.

Figure 11-3

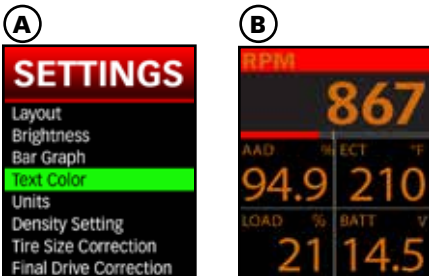

11.5 Units

Choose to display your preferred units for parameter values.

Figure 11-4

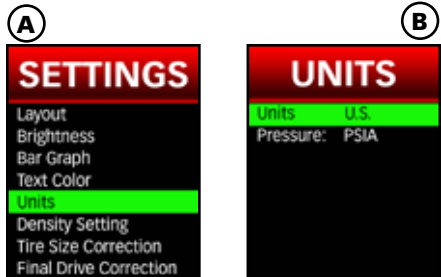

11.5.1 U.S./Metric

This setting allows you to select whether to view parameter information in U.S. or Metric units.

NOTE: This setting does not affect pressure parameters. The units for pressure parameters are set using the **"Pressure"** units setting.

To change the units setting:

1. Select **"Settings"** from the main **"MENU."**
2. Select **"Units"** in the **"Settings"** menu.
3. Select "Units:" to switch between "U.S." or "Metric"
4. Return to the **Gauge Screen** when finished.

Section 11:

SETTINGS, *continued*

11.5.2 Pressure Units

Depending on your preference, you can display pressure values in either Pounds per Square Inch (PSI), Bar, or Kilopascals (kPa).

To change the pressure units setting:

- 1.** Select "**Settings**" from the main "**MENU**."
- 2.** Select "**Units**" in the "**Settings**" menu.
- 3.** Select "**Pressure:**" to switch between "**PSIA**," "**BAR**" or "**KPA**."
- 4.** Return to the **Gauge Screen** when finished.

11.6 Tire Size Correction

This feature will allow you to correct the vehicle speed displayed on the iDash 1.8 when enabled. So when you change the tire size of your vehicle, you can still reference the correct **Figure 11-5**

vehicle speed.

To correct vehicle speed for a tire size change:

- 1.** Select "**Settings**" from the main "**MENU**."
- 2.** Select "**Tire Size Correction**."
- 3.** Select "**Speed Correction:**" to "**Enable**" or "**Disable**" the speed correction feature.
- 4.** Select "**Stock Tire:**" to then input the vehicle's stock tire size information.

A. Select "**Width**"

B. Scroll **UP** or **DOWN** to adjust the value.

C. Select the desired value to save the setting.

D. Repeat **steps 4-A to 4-C** for "**Aspect**" ratio and "**Wheel Diameter**."

5. Select "**Current Tire**" to then input the vehicle's current tire size information.

6. Repeat **steps 4-A to 4-C** for "**Width**" "**Aspect**" ratio and "**Wheel Diameter**" in the "**Current Tire**" menu.

7. The vehicle speed displayed on the iDash 1.8 will now be corrected for the current tire size on the vehicle.

NOTE: *This will only correct the iDash 1.8 speed reading, it will not correct your vehicles instrument cluster speedometer.*

Section 11:

SETTINGS, *continued*

11.7 Final Drive Correction

This feature will allow you to correct the vehicle speed displayed on the iDash 1.8 when enabled. This will correct the vehicle speed for changes in final drive ratios from what the vehicle was originally equipped with.

To correct vehicle speed for a drive ratio change:

1. Select "**Settings**" from the main "**MENU.**"
2. Select "**Final Drive Correction.**"
3. Select "**Drive Correction**" to "**Enable**" or "**Disable**" the drive correction feature.
4. Select "**Stock Final Drive**" to input the vehicle's stock final drive information.

A. Scroll **UP** or **DOWN** to adjust the value.

B. Select the desired value to save the setting.

5. Select "**Current Final Drive**" to input the vehicle's current final drive information.

A. Scroll **UP** or **DOWN** to adjust the value.

B. Select the desired value to save the setting.

6. The vehicle speed displayed on the iDash 1.8 will now be corrected for the current final drive ratio on the vehicle.

NOTE: *This will only correct the iDash 1.8 speed reading, it will not correct your vehicles instrument cluster speedometer.*

Figure 11-6



11.9 Engine Displacement

Engine displacement is required to calculate the volume of air being pumped through the engine (CFM). It is also necessary to calculate Cylinder Head Efficiency.

When you first boot-up your new iDash 1.8, it will prompt you to input this information.

To change the "Engine Displacement" setting:

1. Select "**Settings**" from the main "**MENU.**"
2. Select "**Engine Displacement.**"
3. Either select "**Liters**" or "**CID**" (Cubic Inches of Displacement) to input the vehicle's engine displacement. See **Figure 11-9.**
4. Scroll **UP** or **DOWN** to adjust the value. See **Figure 11-9.**

NOTE: The "**Liters**" and "**CID**" setting are linked. They will update to match each other when either parameter is changed. The values will adjust to the nearest 0.1 Liter.

5. Select the desired value to save the setting.
6. Return to the **Gauge Screen** when finished.

Section 11: SETTINGS, *continued*

Figure 11-7

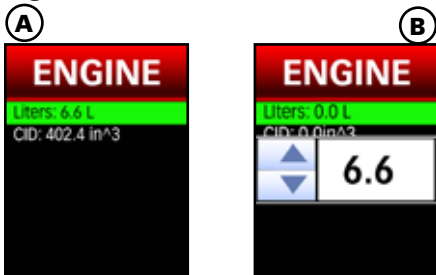

11.9 Vehicle Selection

Each iDash 1.8 can be set for either "**Standard**," "**No OBD**," or an Aftermarket ECU.

All iDash 1.8 are pre-programmed to the "**Standard**" vehicle setting and will read parameters common to most vehicles. When using it without communication to an ECU, select the "**No OBD**" option from vehicle selection.

If you are using the iDash 1.8 with an aftermarket ECU, reference iDash 1.8 aftermarket ECU setup, Owners Manual **97670** for more details

NOTE: If you connect the iDash 1.8 with the Derringer Tuner, the iDash 1.8 will be automatically set to your specific vehicle.

To change your "Vehicle Selection" setting:

1. Select "**Settings**" from the main "**MENU**."
2. Select "**Vehicle Selection**."
3. The initially highlighted setting is the current setting of the iDash 1.8.

Highlight the desired vehicle setting and select it.

4. Enjoy the additional parameters. The iDash will reboot and return to the **Gauge Screen**.

Figure 11-8

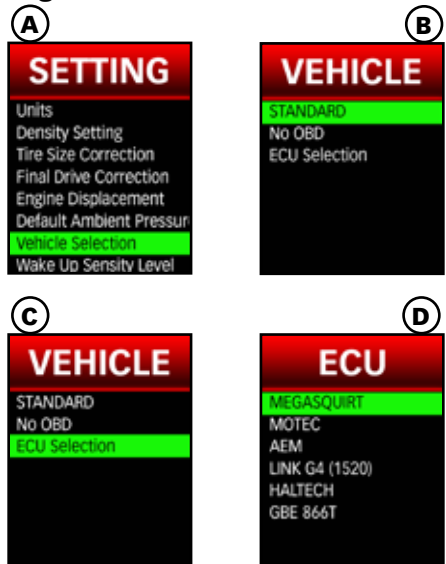

Section 11:

SETTINGS, *continued*

11.10 Wake-up

Figure 11-9

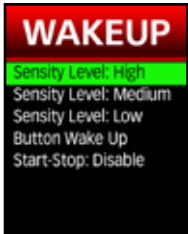

11.10.1 Sensitivity Level

The iDash 1.8's automatic wake-up uses battery voltage drop when cranking the vehicle. The wake-up sensitivity level allows you to adjust the iDash 1.8's sensitivity to the voltage drop. Some vehicles have greater voltage drops than others and would need to set the sensitivity to the low setting.

NOTE: *If the gauge is interfering with OnStar or other similar services, decrease the sensitivity one level lower.*

To adjust the wake-up sensitivity level:

1. Select **"Settings"** from the main **"MENU."**
2. Select **"Wake-up Sensitivity Level."**
3. Select the desired sensitivity level (**"Sensitivity Level: Low"**, **"...Medium"**, **"...High"**).

If unsure, set to **"Sensitivity Level: Low"** and then:

- A. Turn off your vehicle and wait for the iDash to go to Sleep Mode.
- B. Restart your vehicle and

the iDash should start within 10 seconds after startup.

- C. If it does not automatically wake-up, press any button to wake. Increase sensitivity level by one and repeat the process.

11.10.2 Start/Stop

For vehicles with engine start/stop functionality: When enabled, the iDash 1.8 will not shut off when RPM drops below 600 rpm. Instead, the vehicle will check for vehicle communication to the ECU to determine if the vehicle is shut off.

NOTE: It will also take longer for the iDash 1.8 to go into sleep mode.

To enable or disable "Start-Stop":

1. Select **"Settings"** from the main **"MENU."**
2. Select **"Wake-up Sensitivity Level."**
3. Select **"Start-Stop:"** to **"Enable"** or **"Disable"** this feature.
4. Return to the **Gauge Screen** when finished.

11.11 Check Engine Light Quick Clear

The Quick Clear setting allows you to clear diagnostic trouble codes without having to access the vehicle's diagnostic menu.

If enabled, a screen will appear once the check engine light is detected to ask if you would like to clear vehicle codes.

NOTE: Check engine light may recur if the cause of the code is not repaired

Section 11:

SETTINGS, *continued*

1. Select "**Settings**" from the main "**MENU.**"
2. Select "**CEL Quick Clear**" to toggle **ON** or **OFF**.
3. Return to the **Gauge Screen** when finished.

Figure 11-10

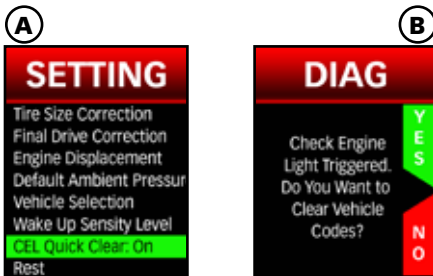

NOTE: You will not be able to save CEL info if the codes are cleared using the quick clear feature.

11.12 Reset

The "**Reset**" settings allow you to reset the iDash 1.8 to factory settings.

When calibrating the ambient light sensor, ensure to maintain a stable ambient light environment (Ex: inside Garage). If the lighting changes as the calibration takes place, auto-dimming will change inconsistently and calibration will need to be performed again.

To calibrate the ambient light sensor:

1. Select "**Settings**" from the main "**MENU.**"
2. Select "**Reset.**"

3. Select "**Calibrate Ambient Sensor**" to recalibrate.

4. Select "**YES**" to continue. Ensure that the lighting will stay the same for the calibration. It should only take 30 seconds.

Select "**NO**" to return to the "**Reset**" menu.

5. Return to the **Gauge Screen** when finished.

The iDash will reboot and return to the "**Gauge Screen**" if reset.

To reset all iDash 1.8 settings:

1. Select "**Settings**" from the main "**MENU.**"

2. Select "**Reset.**"

3. Select "**Reset All Settings.**"

4. Select "**YES**" to continue. Ensure that the lighting will stay the same for the lighting calibration.

Select "**NO**" to return to the "**Reset**" menu.

5. The iDash 1.8 will reset and display the pre-programmed **Gauge Screen** layout.

NOTE: If you have a vehicle specific gauge it will still reset to standard. Therefore you must reset manually in "**Vehicle Selection**" to your specific vehicle setting.

Section 12:

SYSTEM INFORMATION

The system info menu displays information regarding the Banks hardware and software of the iDash 1.8 and any Banks device connected to it. Please include this information when requesting Banks Tech Support for your device.

Information on any of the devices in your B-Bus network can be viewed in the System Information menu of the Primary iDash 1.8. This information is most useful in determining what firmware your devices are currently using.

Another feature in the "**System Information**" menu is "**Capture BID Support**." This feature will record onto a text file all the parameters available on your vehicle.

To access information on a Banks device on the B-Bus network:

1. Select "**System Information**" from the main "**MENU**."
2. Select the desired Banks device.
3. The system information will be displayed as shown in **Figure 19**. This is the information that will need to be supplied to Banks Tech Support if requested.
4. Return to the **Gauge Screen** when finished.

To record parameters supported on your vehicle:

1. Insert a Micro SD card.
2. Select "**System Information**" from the main "**MENU**."
3. Select "**Capture BID Support**."
4. After 3 seconds a banner will appear stating "**Done**" to indicate that the data was saved.

Figure 12-1

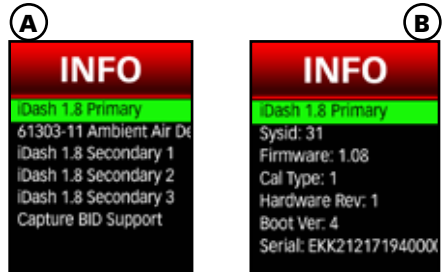

Section 13: FIRMWARE UPDATE

To ensure that your Banks Bus system is operating as designed, we recommended checking for firmware updates for your iDash 1.8 gauges or B-Bus Modules.

1. Visit **bankpower**
2. Click on the corresponding product that you would like to update. See **Figure 13-1**.

Figure 13-1



3. Insert a microSD Card into your computer using a USB-to-microSD card reader (not included) or similar device. See **Figure 13-2**.

Figure 13-2



NOTE: MicroSD card included if data logging option purchased. You can use any microSD card up to 32GB for firmware updates.

4. **Right click** on the appropriate firmware and select **"Save Link As..."** See **Figure 13-3**.

NOTE: You can save several updates for multiple products on the same microSD card.

Figure 13-3

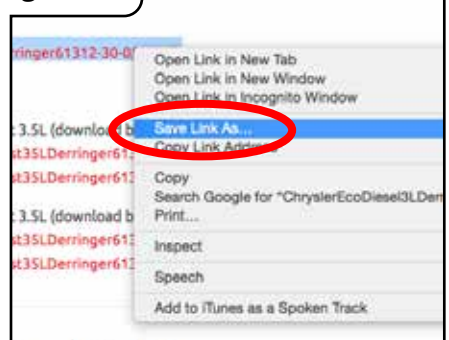

5. Navigate to the microSD card drive to save the file. This can be found under the "Computer" section on the left section of the window. The microSD card is typically labeled **"Removable Disk."**

NOTE: The disk letter will be different from computer to computer. See **Figure 13-4**.

Figure 13-4

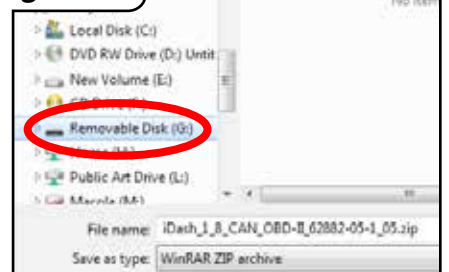

Section 13: BANKS BUS OPERATION, *continued*

6. Click the **"Save"** button to save the firmware file to the microSD card. See **Figure 13-5**.

- DO NOT change the file name of the firmware.
- Take note of the file name so you can select the correct firmware later. See **Figure 13-5**.

NOTE: DO NOT save file in a folder.

Figure 13-5

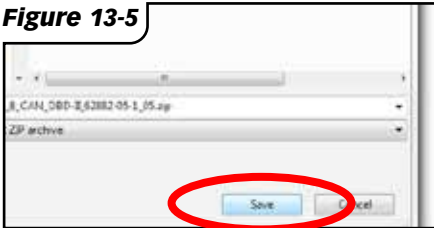

IF UPDATING THE iDASH 1.8, complete **Step 7**; otherwise, for any module skip to **Step 8**.

7. Extract the firmware from the zip folder to your microSD card.

A. Open a file browser and navigate to your microSD card folder.

B. **Right click** on the **"zip"** file that you just downloaded, then click on **"Extract Here"**.

Figure 13-6

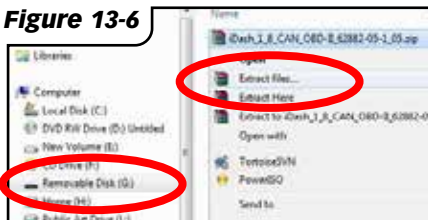

8. Eject and remove the microSD card from the computer by **right-clicking** on the removable drive and clicking on **"Eject"**. See **Figure 13-6**.

Figure 13-7

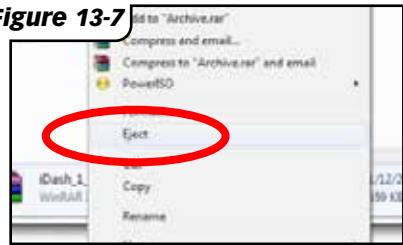

9. In the vehicle with the iDash 1.8 awake, insert the microSD into the iDash 1.8; you will see a notification stating that the microSD card is synced. See **Figure 13-8, 13-9**.

NOTE: **IF UPDATING B-BUS MODULE(S),** any iDash 1.8 connected could be used for updating the B-Bus Module(s).

IF UPDATING THE iDASH 1.8, each iDash 1.8 must be updated one by one.

Figure 13-8



Figure 13-9



Section 13: BANKS BUS OPERATION, *continued*

10. Press the "**SELECT**" button, then select "**Firmware Update.**" See **Figure 13-10.**

Figure 13-10



11. Scroll down and highlight the appropriate B-Bus Module that you want to update then press the "**SELECT**" button. See **Figure 13-11.**

Figure 13-11



12. Scroll down and highlight the appropriate Firmware version you downloaded in **Step 6** and press the "**SELECT**" button. See **Figure 13-12.**

NOTE: You will get an error if the firmware file you select is not compatible.

Figure 13-12



13. The update process will begin and show a progress bar. See **Figure 13-13.**

Figure 13-13



CAUTION

DO NOT remove the microSD card, OBD-II, power cable, or disconnect anything from the B-Bus network while an update is in process. Damage will be caused by failing to adhere.

Section 13:

BANKS BUS OPERATION, *continued*

14. If you have multiple Modules with the same part number on the B-Bus, the next Module will automatically begin updating after the first Module is complete. Let this process continue until all Modules are updated.

15. If updating an iDash 1.8, it will need to reset. See **Figure 13-14**.

NOTE: Leave the microSD card inserted for this process

Figure 13-14



If engine is off during iDash 1.8 update, you may need to press a button to wake up the iDash 1.8 to finish the update. When the iDash 1.8 wakes back up it will begin to load new files (30-45 seconds). See **Figure 13-15**.

Figure 13-15



Upon completion, a message box will let you know the update is complete. It is now safe to remove the microSD card. See **Figure 13-16**.

Figure 13-16



16. Repeat the process (Steps 9-16) for all iDash 1.8's or connected B-Bus Modules.

Section 14:

GLOSSARY

14.1 Banks Engine Air Density System Overview

Horsepower is directly dependent on the number of oxygen molecules available for combustion. Simply put, the more oxygen your engine has, the more fuel it can combust resulting in greater horsepower. Boost pressure has been the go to performance measurement to predict horsepower changes because it directly affects the amount of oxygen available to the engine. However, it is only part of the story and leaves out the temperature effects on oxygen content, which is a critical element that can greatly alter your engine's horsepower.

So if Boost isn't the best performance indicator, what is? Air Density is the most direct measurement of oxygen molecules being used by your engine for combustion. Unlike looking at Boost pressure, it accounts for the effect that temperature plays on oxygen content of the air. Density is defined as lbs. mass of air per ft³ of volume. We display this parameter as lbs./1000ft³ which scales it to an easier to read range of typically 0-300.

Because the air density changes based on pressure, temperature and humidity, the power output of your engine will also change based on your current ambient conditions. The Society of Automotive Engineers (SAE) has defined a set of ambient conditions that all engines must be corrected to when measuring Horsepower. SAE J1349, which is the most common correction factor, uses an ambient pressure of 14.4 psia, an ambient temperature of 77°F and a relative humidity of 0%, resulting with an ambient air density of 72.2 lbs./1000 ft³. Another common density standard is SAE J607 which has an ambient air density of 76.4 lbs./1000ft³.

Manifold Air Density (MAD) is calculated just like AAD except it uses the Manifold Absolute Pressure and Manifold Air Temperature data. This reading represents the mass of oxygen per unit volume available in the manifold.

Boost Air Density (BAD) is another useful measurement which is calculated as:

$$BAD = MAD - AAD$$

It is the additional Density available in the manifold greater than the current ambient conditions and is a more insightful performance measurement then simply using Boost pressure.

U.S. Patent 7,254,477 B1 U.S. Patent 7,593,808 B2 apply to this product.

Section 14:

GLOSSARY, continued

14.2 Definitions of Common Parameters

NOTE: *The following list of data parameters is not a comprehensive list of everything that the iDash can display. It is a smaller subset of some of the more common and useful parameters that you may want to monitor on your vehicle.*

The parameters available on your iDash is dependent on what sensors the manufacturer has installed on your vehicle. You will not be able to see every parameter listed in this glossary due to it not being supported by your vehicle.

Data is organized in groups/categories to easily locate the parameter you are interested in.

*Some vehicles will have multiple sensors in a system (Ex: EGT1/1, EGT1/2, EGT1/3...). In these instances Bank 1 (Ex: EGT**1**/1) refers to the side of the engine that the number 1 cylinder resides as defined by the manufacturer. Bank 2 (Ex: EGT**2**/1) is most commonly only found in "V" configuration engines and it indicates the side of the engine opposite of the number 1 cylinder. When there are multiple sensors measuring the same type of data in a system (Ex: IAT1, IAT2, IAT3...) then the number 1 sensor is located furthest upstream in the path of airflow and the highest number sensor available is furthest downstream in the system.*

AIR DENSITY **P** (Banks Patented) **E** (Banks Exclusive)

Abbreviation	Parameter Name
AAD	Ambient Air Density P - Mass of air per volume of the air surrounding the vehicle.
BAD.....	Boost Air Density P - Mass of air per volume in intake manifold greater than the Ambient Air Density.
DCF.....	Density Correction Factor P - Ratio of actual ambient air density to selected standard day.
D-RAT.....	Density Ratio P - Ratio of Manifold air Density compared to Ambient Air Density.
MAD.....	Manifold Air Density P - Mass of air per volume in the intake manifold.
MAN RH.....	Manifold Relative Humidity P - Relative humidity in the intake manifold, a value greater than 100% indicated condensation).
RH*	Relative Humidity (B-Bus) E - Percentage of water vapor in ambient air compared to maximum potential water vapor.

Section 14:

GLOSSARY, *continued*

DIAGNOSTICS

Abbreviation	Parameter Name
MIL.....	MIL Status - Status of the malfunction indicator lamp (or CEL).
DTCCLR.....	Run Time Since DTCS Cleared - Minutes the engine has been running since the last time a diagnostic code has been cleared.
MILACT	Run Time While MIL Active - Minutes the engine has been running with an active MIL or CEL light.



EMISSIONS

Abbreviation	Parameter Name
DPF SL	% DPF Soot Load - DPF soot load as a percentage of maximum.
REGEN	DPF Regen Status - States if vehicle is in active DPF regeneration cycle.
EGRCMD	EGR Commanded - Commanded position of the exhaust gas recirculation valve).
EGRACT	EGR Duty Cycle Actual - Actual open percentage of the exhaust gas recirculation valve.
EGRCMD	EGR Duty Cycle Commanded - Commanded open percentage of the exhaust gas recirculation valve.

ENGINE PERFORMANCE AIR

Abbreviation	Parameter Name
ABSTPS	Absolute Throttle Position - Current position of the throttle valve expressed as a percentage.
MAF	Mass Air Flow - Flow rate of air mass in intake.
THRCMD	Throttle Commanded - Commanded position of the intake throttle valve.
THRPOS	Throttle Position - Actual position of the intake throttle valve.
THRREL	Throttle Position Relative - Position of accelerator pedal.
VT CMD.....	Turbo Vane Command - Commanded position of the turbocharger vanes.
VT POS.....	Turbo Vane Position - Actual Position of the turbocharger vanes.
WG CMD	Wastegate Commanded - Commanded position of the wastegate. expressed as a %.



Engine Performance Fuel (*Banks Exclusive*)

Abbreviation	Parameter Name
AFR1/1.....	Air Fuel Ratio Bank1 Sensor1 - Measured Air Fuel Ratio.
AFRCMD	Air Fuel Ratio Commanded - Target air fuel ratio request by the ECU.
AFRERR.....	Air Fuel Ratio Error  - Error between the actual and commanded air fuel ratio (negative values are richer mixture).
LOOP.....	Fuel Closed Loop Status - States if vehicle is in open or closed loop fuel control.
FUEL R	Fuel Flow Rate - Instantaneous fuel consumption rate volume.
FUEL L.....	Fuel Tank Level - Percentage of fuel remaining in fuel tank.
TM ADV	Injection Timing Advance - Start of injection angle relative to TDC (after TDC is negative).
LTFT1	Long Term Fuel Trim Bank 1 - Historic fueling correction used while in closed loop fueling mode.
STFT1	Short Term Fuel Trim Bank 1 - Instantaneous fueling correction used while in closed loop fueling mode.
TFT 1.....	Total Fuel Trim Bank 1  - Incorporates long term and short term fuel trim into a single trim value.

Section 14:

GLOSSARY, continued

Pressure (Banks Exclusive)

<u>Abbreviation</u>	<u>Parameter Name</u>
AAP	Ambient Air Pressure - Pressure of air surrounding vehicle.
BSTCMD	Boost Commanded - Target boost value set by the powertrain control unit.
BOOST	Boost Pressure  - Pressure in intake manifold relative to barometric.
DPFIP1	DPF Inlet Press Bank 1 - Pressure measured at the inlet of the diesel particulate filter.
DPFOP1	DPF Outlet Press Bank 1 - Pressure measured at the outlet of the diesel particulate filter.
FRP	Fuel Rail Pressure - Pressure of fuel in fuel rail.
LIFT P	Lift Pump Fuel Pressure - Pressure of fuel at inlet to the high pressure fuel pump.
MAP	Manifold Absolute Pressure - Pressure in intake manifold relative to vacuum.
P-RAT	Pressure Ratio  - Ratio of Manifold Absolute Pressure compared to Ambient Air Pressure.
TCIP A	Turbo Inlet Pressure A - Air pressure measured at the inlet of the turbocharger.

SPEED AND VELOCITY

<u>Abbreviation</u>	<u>Parameter Name</u>
RPM	Engine RPM - Rotational speed of crankshaft.
TURBO	Turbo A RPM - Rotational speed of turbocharger.
SPEED	Vehicle Speed - Speed of vehicle relative to road.

TEMPERATURE



<u>Abbreviation</u>	<u>Parameter Name</u>
AAT	Ambient Air Temp - Temperature of air surrounding vehicle.
CAC1/1	CAC Temp Bank 1 Sensor 1 - Temperature of the air at the charge air cooler.
CAT1/1	Catalyst Temp Bank 1 Sensor 1 - Temperature of the catalytic convertor.
DPFIT1	DPF Inlet Temp Bank 1 - Temperature measured at the inlet of the diesel particulate filter.
DPFOT1	DPF Outlet Temp Bank 1 - Temperature measured at the outlet of the diesel particulate filter.
EGR1/1	EGR Temp Bank1 Sensor 1 - Temperature of the gas in the EGR system.
ECT	Engine Coolant Temp - ATemperature of engine coolant.
EOT	Engine Oil Temp - Temperature of engine oil.
EGT1/1	Exh Temp Bank 1 Sensor 1 - Temperature of the exhaust gases (sensor 1 is closest to the cylinder head).
IAT	Intake Air Temp - Temperature of air in air filter or entering compressor.

VEHICLE PERFORMANCE (Banks Exclusive)

<u>Abbreviation</u>	<u>Parameter Name</u>
LOAD	Absolute Engine Load - Normalized air mass per intake stroke as a percent of engine displacement.
APP D	Accelerator Pedal D - Measured position of the accelerator pedal for circuit D.
APPREL	Accelerator Pedal Relative - Position of the accelerator pedal normalized from 0-100%.

Section 14:

GLOSSARY, *continued*

HPCALC	Calc Engine Horsepower  - Instantaneous engine horsepower indicated by the power control module (does not account for mods).
TRQCAL.....	Calc Engine Torque  - Instantaneous engine torque indicated by the power control module (does not account for mods).
LOAD	Calculated Engine Load - Percentage of available engine torque being used.
TRQREF	Engine Reference Torque -Maximum Torque value the engine can produce.
IGN TM.....	Ignition Timing Advance - Ignition timing spark advance in degrees before top dead center for #1 cylinder.
TORQUE	Torque % Actual - Calculated output torque of the engine or indicated torque.
TRQCMD	Torque % Commanded - Requested torque output of the engine by the driver.

VOLTAGE

<u>Abbreviation</u>	<u>Parameter Name</u>
BATT	Battery Voltage - Voltage of the battery measured by the ECU.

Section 15:

TROUBLESHOOTING

If the iDash 1.8 does not power on when installed in the vehicle with the engine running, please check the following items:

1. Push any of the four buttons on the iDash 1.8.
 2. Make sure the iDash 1.8 is properly connected to the vehicle as described in "**Section 2 Mounting and Connecting the iDash 1.8**"
 3. Some situations can be resolved by **resetting the iDash 1.8**. **Unplug the iDash's OBDII cable** from the OBDII port and **wait 5 seconds**, then **re-connect the OBDII cable**.
 4. **Check the connection at the OBDII port** (under the driver's side dash area). Check for any damage to the OBDII port "hood", such as becoming dislodged from the connector housing.
 5. If the iDash 1.8 does not power on, **check the fuse** that powers the vehicle's **OBDII port**.
- If bad, replace** and check if the iDash 1.8 will power on. If the fuse is good continue to **Step 6**.
6. If the iDash 1.8 still does not power on when one of the four buttons is pressed, there **may be a problem with the CAN communication**.

If your vehicle is older than 2008, it may not be able to properly communicate with the iDash 1.8.

If your vehicle does have proper CAN communication, call technical support for further assistance.

If the gauge powers on but all the values report "---" intermittently or consistently:

1. Verify that the "**Vehicle Selection**" in the "**Settings**" menu is set to "Standard" if using the **OBDII Cable** or set to the proper "**Aftermarket ECU**" if using the **Aftermarket ECU Harness**. **See Section "11.10 Vehicle Selection" for instruction.**

2. Make sure the iDash 1.8 is properly connected to the vehicle as described in "**Section 2 Mounting and Connecting the iDash 1.8**"

If using **multiple iDash 1.8's**, make sure to check that there are **only two terminators** on the **B-Bus network**.

2. **If your vehicle is 2007 or older**, your vehicle most likely **does not support OBDII connection** and the iDash 1.8 will not work on your vehicle. **Check the "Vehicle Fitment Chart for iDash 1.8"**.

3. **If your connection is intermittent** with the **OBDII Cable** properly connected to the **OBDII port** and **iDash 1.8**, the **pins on any of those connectors might be damaged**, resulting in poor connection. Please call technical support for further assistance.