



Part#: 124635

Product: Long Arm Upgrade

Application: 2007-2013 Jeep Wrangler JK

READ AND UNDERSTAND ALL INSTRUCTIONS AND WARNINGS PRIOR TO INSTALLATION OF SYSTEM AND OPERATION OF VEHICLE.

SAFETY WARNING BDS Suspension Co. recommends this system be installed by a professional technician. In addition to these instructions, professional knowledge of disassembly/ reassembly procedures and post installation checks must be known.

PRODUCT SAFETY WARNING Certain BDS Suspension products are intended to improve off-road performance. Modifying your vehicle for off-road use may result in the vehicle handling differently than a factory equipped vehicle. Extreme care must be used to prevent loss of control or vehicle rollover. Failure to drive your modified vehicle safely may result in serious injury or death. BDS Suspension Co. does not recommend the combined use of suspension lifts, body lifts, or other lifting devices.

You should never operate your modified vehicle under the influence of alcohol or drugs. Always drive your modified vehicle at reduced speeds to ensure your ability to control your vehicle under all driving conditions. Always wear your seat belt.

PRE-INSTALLATION NOTES

1. Special literature required: OE Service Manual for model/year of vehicle. Refer to manual for proper disassembly/ reassembly procedures of OE and related components.
2. Adhere to recommendations when replacement fasteners, retainers and keepers are called out in the OE manual.
3. Larger rim and tire combinations may increase leverage on suspension, steering, and related components. When selecting combinations larger than OE, consider the additional stress you could be inducing on the OE and related components.
4. Post suspension system vehicles may experience drive line vibrations. Angles may require tuning, slider on shaft may require replacement, shafts may need to be lengthened or trued, and U-joints may need to be replaced.
5. Secure and properly block vehicle prior to installation of BDS Suspension components. Always wear safety glasses when using power tools.
6. If installation is to be performed without a hoist, BDS Suspension Co. recommends rear alterations first.
7. Due to payload options and initial ride height variances, the amount of lift is a base figure. Final ride height dimensions may vary in accordance to original vehicle attitude. Always measure the attitude prior to beginning installation.

POST-INSTALLATION WARNINGS

1. Check all fasteners for proper torque. Check to ensure for adequate clearance between all rotating, mobile, fixed, and heated members. Verify clearance between exhaust and brake lines, fuel lines, fuel tank, floor boards and wiring harness. Check steering gear for clearance. Test and inspect brake system.
2. Perform steering sweep to ensure front brake hoses have adequate slack and do not contact any rotating, mobile or heated members. Inspect rear brake hoses at full extension for adequate slack. Failure to perform hose check/ replacement may result in component failure. Longer replacement hoses, if needed can be purchased from a local parts supplier.
3. Perform head light check and adjustment.
4. Re-torque all fasteners after 500 miles. Always inspect fasteners and components during routine servicing.

PARTS LIST

Part # Qty Description

014691 Box Kit

A192 2 Adjustable Flex LCA
A193 2 Adjustable Flex UCA

014689 Box Kit

A194 2 Adjustable Rear LCA
A195 2 Adjustable Rear UCA

124635 Box Kit

342701 1 Loctite - 1mL

Front Control Arm Mounts

01983 1 Frt LCA Mount (drv)
01984 1 Frt LCA Mount (pass)
01998 2 Nut Tab - Frt LCA Mount
760 1 Bolt Pack - Frt LCA Mounts
2 1/2"-13 x 1-1/4" bolt
2 1/2"-13 x 1-1/2" bolt
2 1/2"-13 prevailing torque nut
6 1/2" SAE flat washer
2 9/16"-12 x 4" bolt
2 9/16"-12 prevailing torque nut
4 9/16" SAE flat washer
01900 2 Frt UCA Mount
92 2 Crush Sleeve - 0.750 x 0.134 x 1.980
761 1 Bolt Pack - Frt UCA Mounts

2 12mm-1.75 x 90mm bolt
2 12mm-1.75 x 100mm bolt
4 12mm-1.75 prevailing torque nut
8 1/2" SAE flat washer
4 7/16"-14 x 1-1/4" bolt
4 7/16"-14 prevailing torque nut
8 3/8" USS flat washer

Rear Control Arm Mounts

01985 1 Rear Control Arm Mount (drv)
01986 1 Rear Control Arm Mount (pass)
01797 3 Bolt Tab - Rear Mount
762 1 Bolt Pack - Rear Mounts
2 9/16"-12 x 4" bolt
2 9/16"-12 prevailing torque nut
4 9/16" SAE flat washer
3 1/2"-13 x 1-1/2" bolt
1 1/2"-13 x 4" bolt
4 1/2"-13 prevailing torque nut
8 1/2" SAE flat washer
4 7/16"-14 x 1-1/4" bolt
2 7/16"-14 prevailing torque nut
6 3/8" USS flat washer
2 12mm-1.75 x 90mm bolt
2 12mm-1.75 prevailing torque nut
4 1/2" SAE flat washer
27031 1 Fish Wire
95105A169 4 1/2-13 Rivet Nut (.063-.200)
95105A170 2 1/2-13 Rivet Nut (over .200)



INSTALLATION INSTRUCTIONS

PRE-INSTALLATION NOTES:

This upgrade kit is designed to work with most any properly installed aftermarket lift systems providing at least 4.5" of lift and no more than 8.5" of lift. Additional adjustment of previously installed components may be necessary if they impede the proper function of this upgrade system. For example, additional bump stop extension may be necessary for proper long control arm clearance during full suspension travel.

Front Installation

1. Park the vehicle on a clean, flat surface and block the rear wheels for safety.
2. Raise the front of the vehicle and support with jack stands up near the front of the frame rails. The normal support area behind the lower control arm mounts needs to remain unobstructed during the installation.
3. If equipped, remove the three bolts mounting the transmission skid plate to the frame rails and transmission crossmember (Fig 1). This skid plate will not be reused. Retain the mounting hardware.

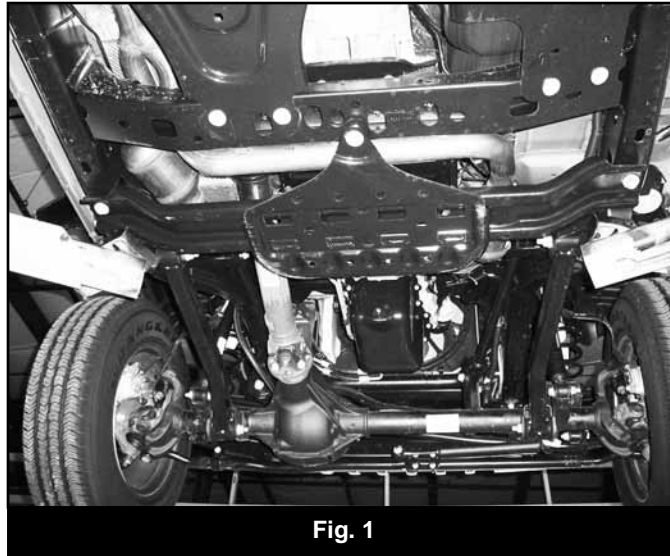

Fig. 1

4. Remove the outer transmission crossmember mounting bolt on each end of the crossmember (Fig 2). Retain the mounting hardware.

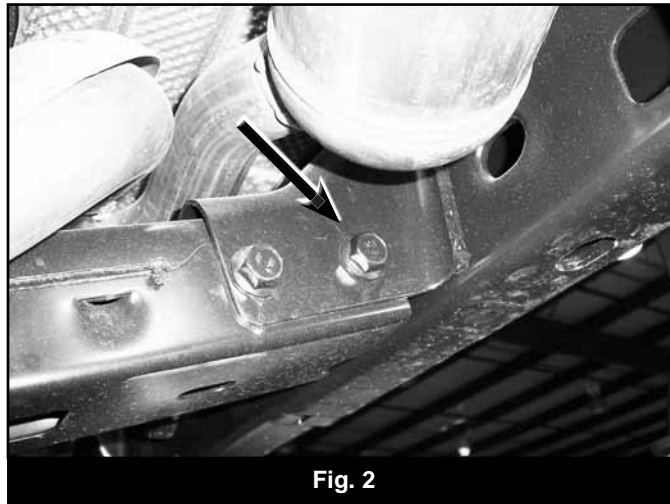

Fig. 2

5. Position the provided front LCA mount (01983-driv, 01984-pass) up to the frame rail and against the front face of the transmission crossmember (Fig 3). Loosely fasten the bracket to the frame with the OE skid plate bolt and to the crossmember with the OE crossmember hardware.

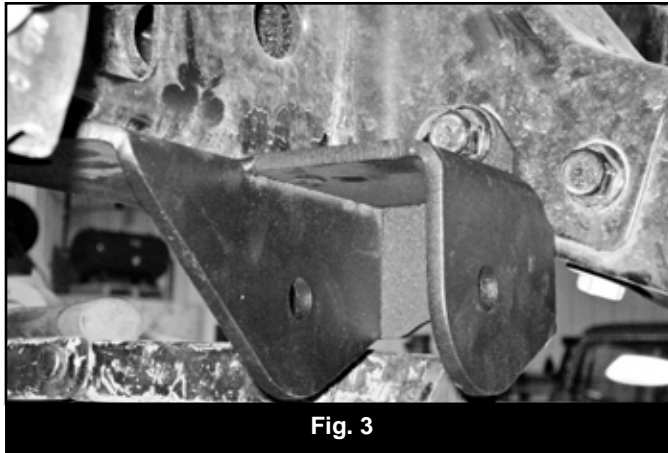

Fig. 3

6. With the bracket positioned flush to all the mounting surfaces, mark the outer mounting hole to be drilled in the frame (Fig 4). Remove the bracket and drill a $\frac{1}{2}$ " hole at the mark.

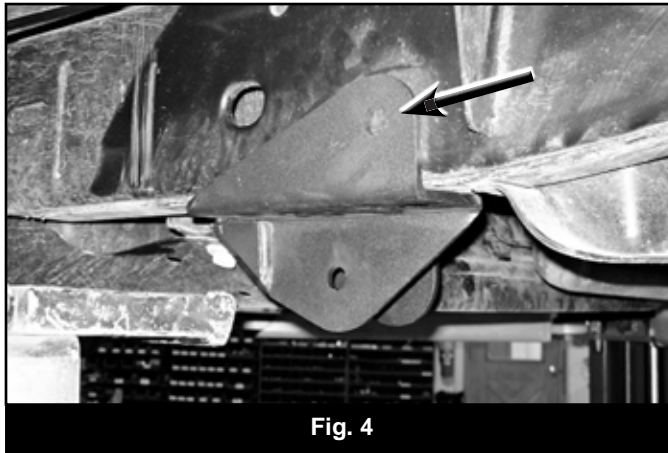

Fig. 4

7. After the mounting hole is drilled in the frame, reattach the LCA mount to the frame with the OE crossmember bolt and a $\frac{1}{2}$ " x 1-1/4" bolt, nut and $\frac{1}{2}$ " SAE washers (BP 760) through the newly drilled hole. Install a $\frac{1}{2}$ " x 1-1/2" bolt and $\frac{1}{2}$ " SAE washer (BP 760) up through the rear-most hole in the bracket into the existing frame hole and fasten with the provided nut tab (01998). Loosely install the OE skid plate bolt.
8. With all of the LCA mount hardware installed, torque fasteners to 65 ft-lbs. The OE skid plate bolt should be the last bolt to be tightened (Fig 5).

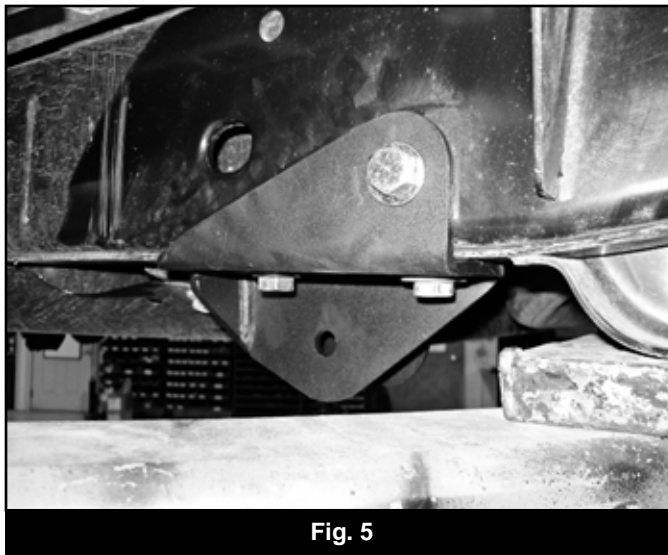

Fig. 5

9. With a jack supporting the front axle, remove the factory lower control arms.

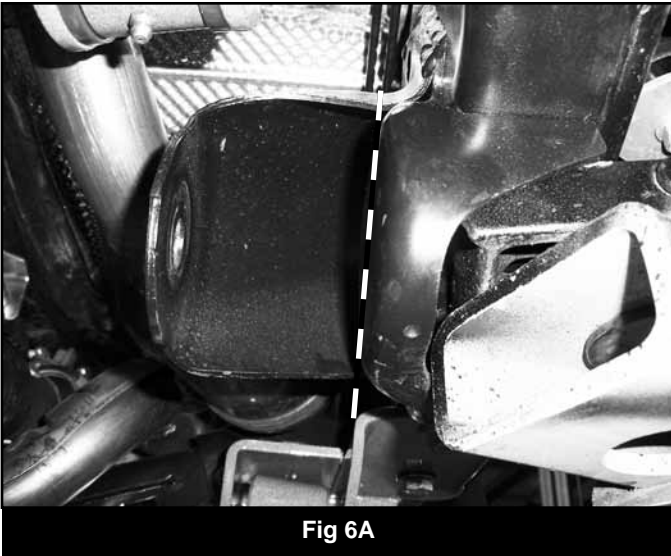

Fig 6A

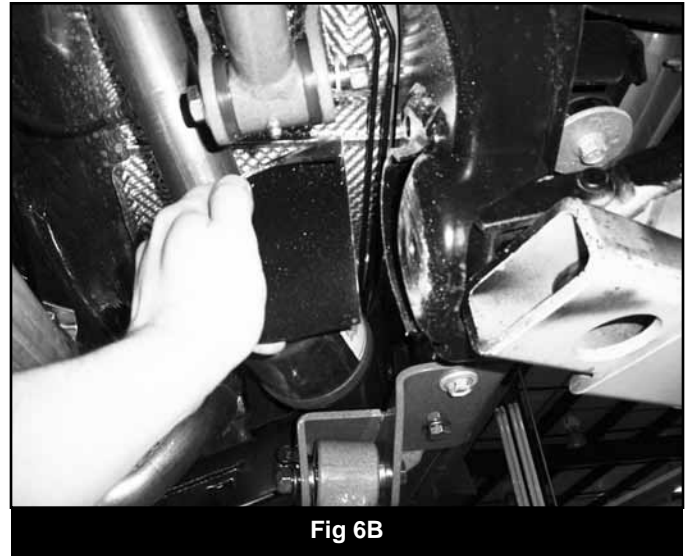

Fig 6B

10. Cut the passenger's side factory LCA mount in the same manner as the driver's side.
11. Locate the new front LCAs (A192), this is the longest set of arms. Adjust the arms to 33 3/8" center to center. Remove the pre-installed straight grease fitting and install the provided 90 deg. zerk fittings so they are angling 45 deg. from the arm towards the center of the vehicle once installed.
12. Install the flex end of the new control arms into the new LCA mounts and fasten with 9/16" x 4" bolts, nuts and 9/16" SAE washers (BP 760). The arms bend in toward the center of the vehicle and the grease fitting is on top. Rotate the axle enough to install the arms into the axle with the factory hardware, leave hardware loose.
13. Locate the new front UCA assembly (A193). Adjust the length of the arm to 22-1/8" from the center of the clevis bolt hole to the center of the flex end. Leave the jam nut loose. This is a good starting point for 4 & 6" lifts - adjust as necessary once the lift is complete.
14. Remove the heat shields from the upper control arm mounts. (Fig 7) There is a bolt on the top and bottom of each shield. These will not be reused.

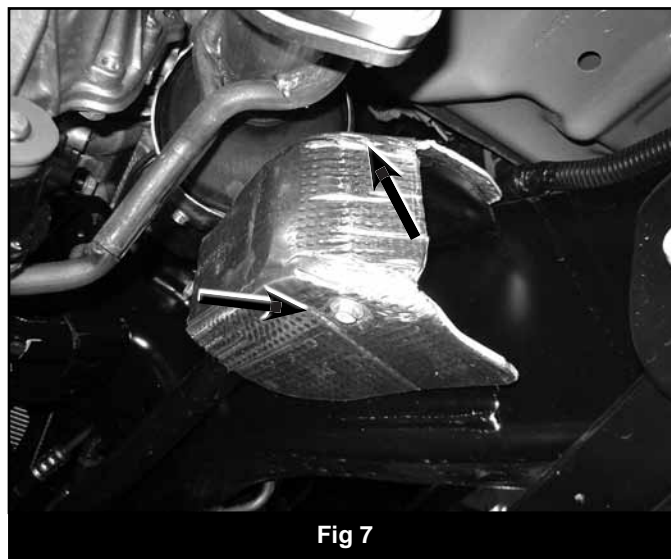
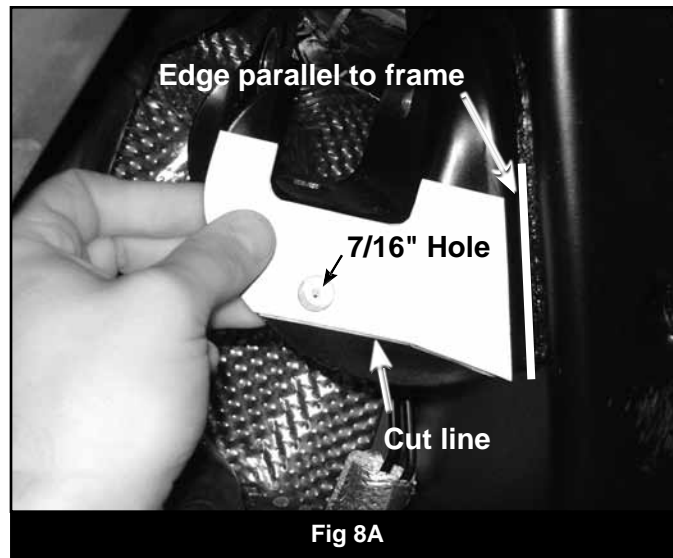
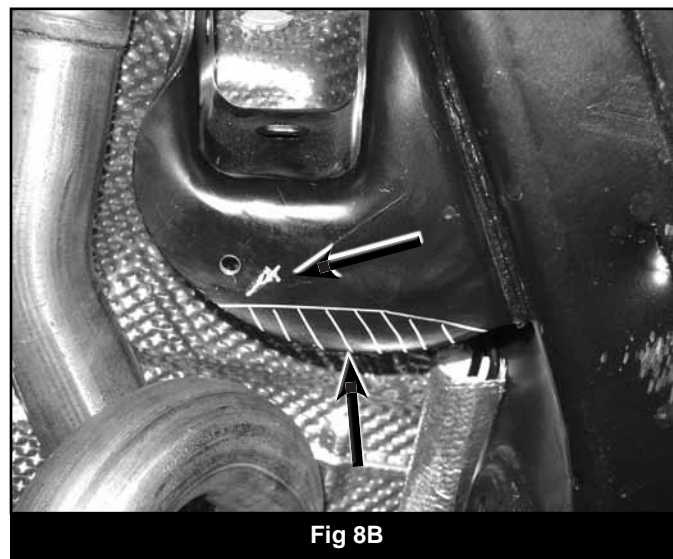

Fig 7

15. Remove the passenger's side UCA from the axle and the frame. Save the bolt/nut from the axle end.
16. Locate the provided UCA mount drill/cut template at the end of the instruction sheet and cut it out. Position the drill template on the bottom face of the factory upper control arm mount so that the profile of the template matches the mount. The straight edge of the template should be parallel to the frame rail (Fig 8A). Mark the center of the hole in the template on the mount. Remove the template and repeat procedure on the other side of the vehicle.



17. Drill a 7/16" hole at the marks made on the factory UCA mounts. Trim along the cut line, making the bottom-rear edge straight (Fig 8B).



18. Position a provided UCA bracket (01900) onto the backside of the original passenger's side UCA mount. Attach the bracket to the frame mount with 7/16" x 1-1/4" bolts, nuts and washers (BP 761) through the newly drilled lower hole and the existing hole in the backside of the OE mount. Leave hardware loose.
19. Position a provided crush sleeve (92) in the OE UCA mount and fasten the bracket through the OE UCA mount holes and sleeve with a 12mm x 100mm bolt, nut and 1/2" SAE washers (BP 761). Run the bolt from the outside. (Fig 9 A,B)
20. With the bracket in position, install one of the front upper control arms in the bracket so the grease zerk is down and loosely fasten with a 12mm x 90mm bolt, nut and 1/2" SAE washers (BP 761).



Fig 9A

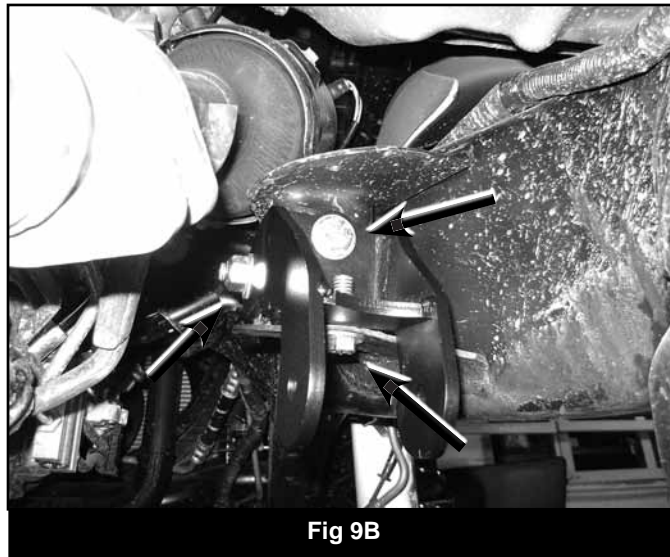
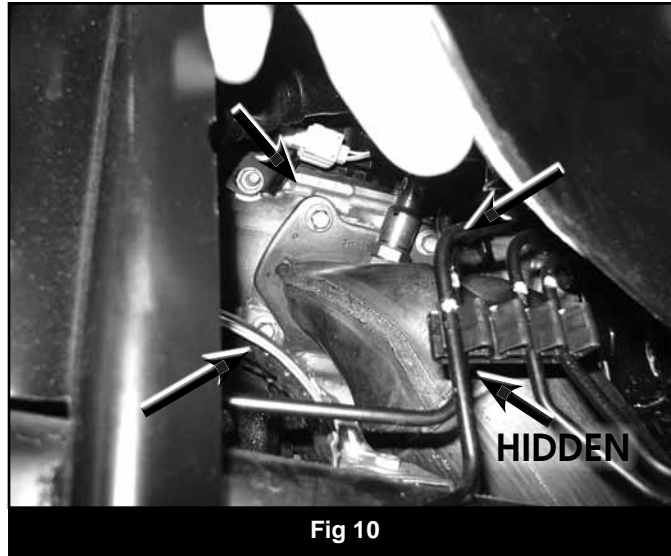

Fig 9B

21. With all the UCA mount hardware installed, torque the 7/16" hardware to 45 ft-lbs and the 12mm hardware (including the control arm bolt) to 65 ft-lbs.
22. With the axle still well supported, remove the driver's side UCA and rotate the axle to install the new passenger's side UCA to the axle with the factory hardware. Leave hardware loose.
23. Repeat the UCA bracket installation on the driver's side of the vehicle. The drivers bracket will not slide into position without loosening the exhaust at the engine. There are 4 small bolts mounting the exhaust to the engine. These can be accessed through the wheel well and from under the vehicle. Remove the top 2 bolts and loosen the lower 2 to gain slack/clearance needed to install the new UCA bracket. (Fig 10) Once the bracket is in position, tighten the exhaust hardware securely.



24. With the driver's side UCA bracket in position, fasten using the same steps as the passenger's side.
 25. Install the new driver's side UCA to the new bracket (new hardware) and OE axle mount (factory hardware). Torque the new hardware at the frame to 65 ft-lbs and leave the axle hardware loose.
- Note: Make sure the UCA is installed with the grease fitting pointed down.*
26. Be sure the UCA flex ends are square in the pockets and lock off the control arm jam nuts securely.
 27. Remove the jack stands and lower the vehicle to the ground.
 28. Torque the lower control arm bolts at the axle and new frame brackets to 95 ft-lbs. Torque the upper control arms hardware at the axle and new frame brackets to 60 ft-lbs.

Rear Installation

1. Block the front wheels for safety.
2. Raise the rear of the vehicle and support with jack stands up near the rear of the frame rails. The normal support area in front of the lower control arm mounts needs to remain unobstructed during the installation.
3. Support the rear axle with a jack.
4. Remove the passenger's side LCA from the frame and axle. Retain the hardware and discard the LCA.

⚠ Warning: The vehicle's fuel tank is located just inside the passenger's side frame rail and close to the passenger's side LCA mount. Use caution when performing the next step of removing this factory bracket. DO NOT use any type of flame or plasma cutting to perform this procedure. While using any cutting method, a properly charged fire extinguisher should be located close by.

5. The factory LCA mount must be cut off to provide clearance for the new arms under suspension compression. Mark and cut the LCA mount at frame. Cut off bottom and outside of bracket. The inside wing of the bracket can remain intact on the passenger's side, the driver's side can be completely removed.

ⓘ Note: Take care not to cut into the frame. (Figures 11 A/B)

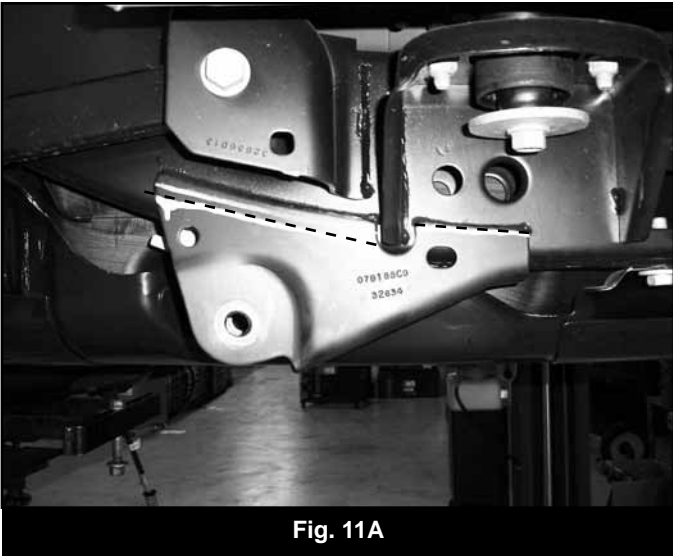

Fig. 11A

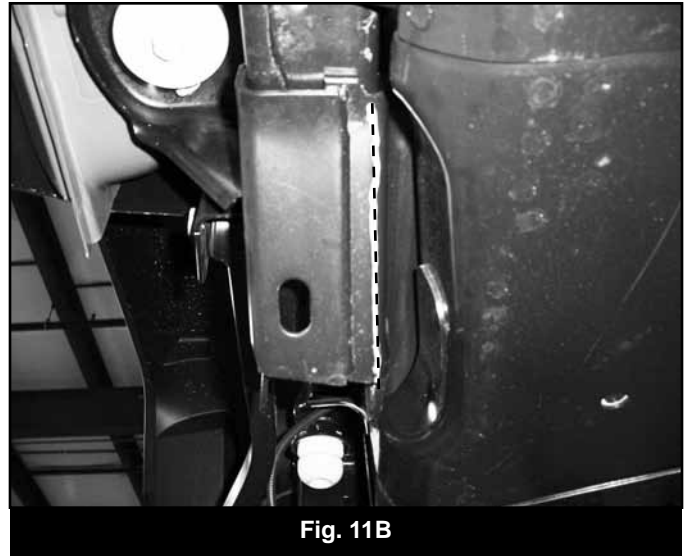

Fig. 11B

6. After removing the bracket, go back and grind the weld located within the body mount smooth 1" from the end. This will allow the new mounting bracket to lay flush against the frame when installed. (Fig 12)

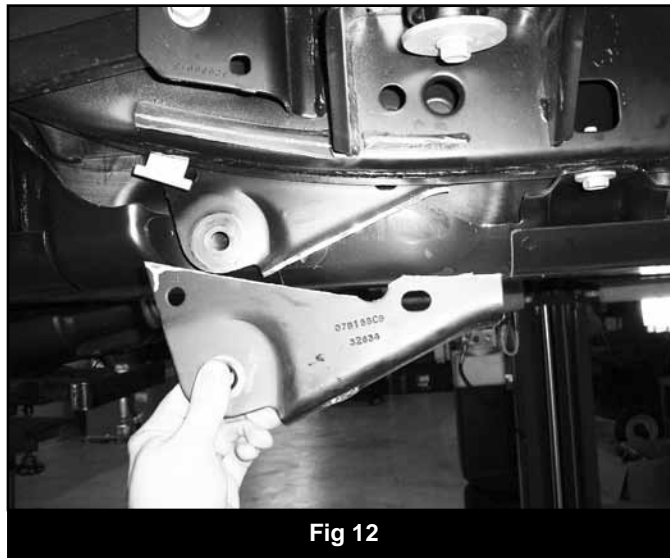

Fig 12

7. Measure up 1-1/4" from the bottom edge of the body mount, measure from frame over 3/8" and remove section from the body mount. (Figure 13, 14)

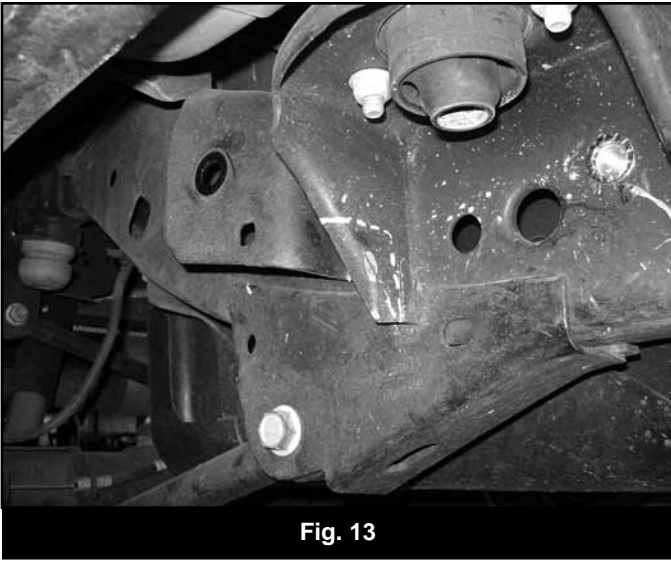

Fig. 13



Fig. 14

8. Remove the upper control arm pocket from the frame with a sawzall. Trim 1/4"-1/2" away from the frame all of the way up. (Figure 16, 17)

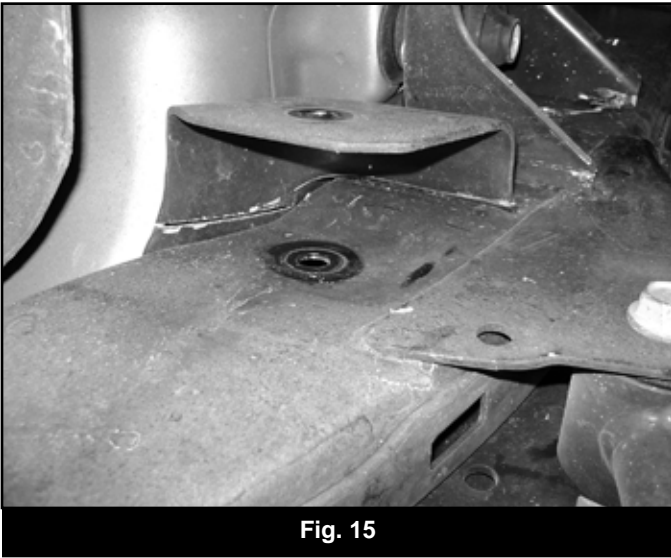

Fig. 15

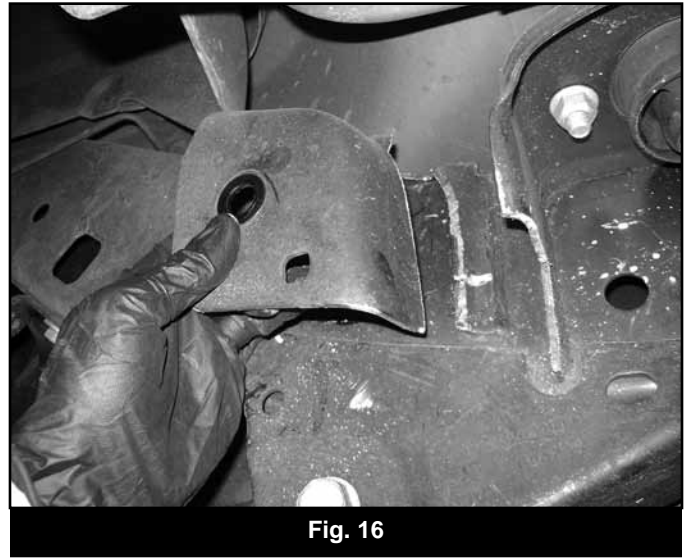

Fig. 16

9. Remove gas tank skid plate bolt located just ahead of the factory lower control arm mount. Retain skid plate bolt.
10. Temporarily install the new bracket passenger's side control arm bracket (01986) with the new 12mm x 35mm bolt (Fig 17).

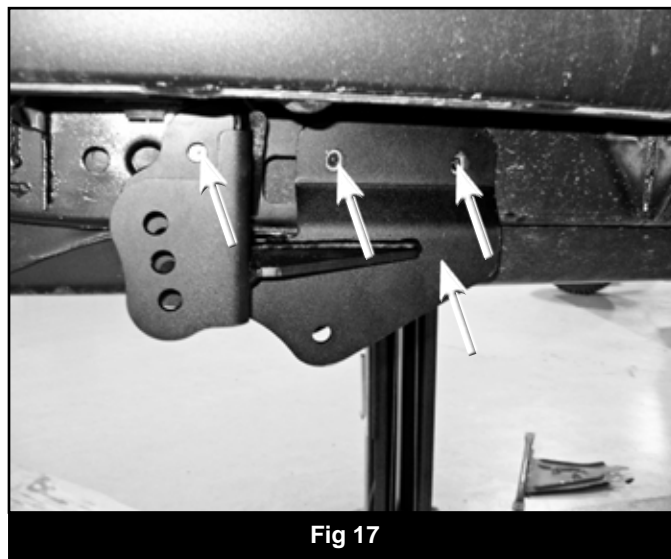

Fig 17

11. Mark holes to drill (Fig 19/20). Use drill template at the end of this instruction sheet to locate the hole to be drilled through the front side of the body mount (Fig 18 – driver's side shown). Set the edge of the template up flush to the frame surface.

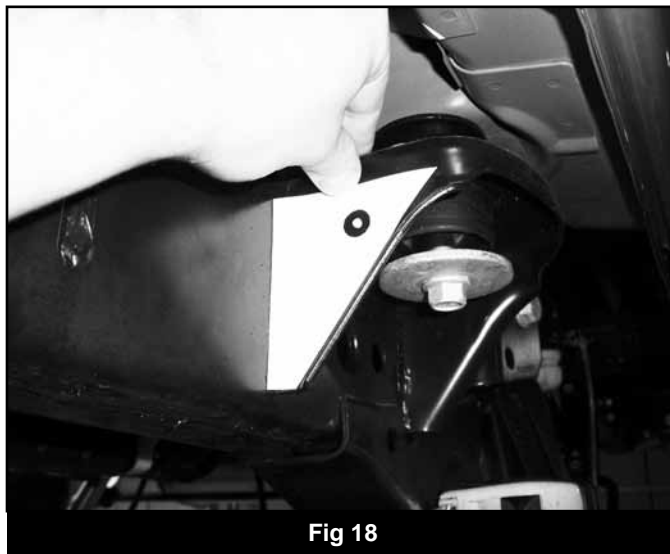

Fig 18

12. Remove the bracket and drill 11/16" holes at each of the 3 marks made on the frame rail. Drill the body mount hole to 1/2". Drill the hole in the bottom of the frame out to 9/16". This will provide clearance for the bolt to pass through with the fish wire attached.
13. Install the rivet nuts into the frame rail with 1/2" x 2-1/2" bolt, 9/16" high nut, washer, and serrated edge washer as shown. The rear 2 holes will take the short rivet nut, the forward most hole will take the long rivet nut. Tighten until the rivet nut is secure. (Fig 19, 20, 21)

 *Note: See the end of this instruction sheet for more detailed rivet nut installation instructions.*



Fig. 19

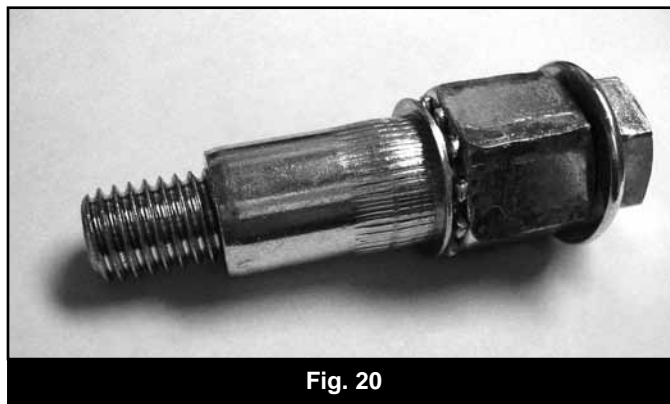

Fig. 20

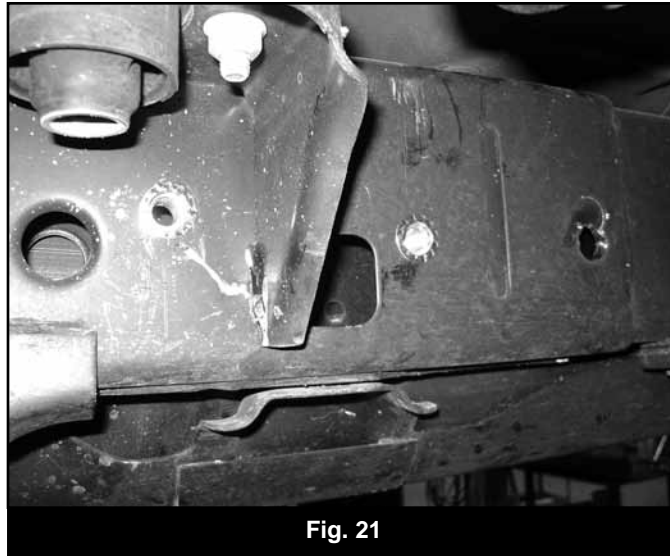

Fig. 21

14. Use the provided fish wire to pull the 1/2" bolt tab (01797) through the frame (Fig 22). Note: Do not put a washer on the bolt tab.

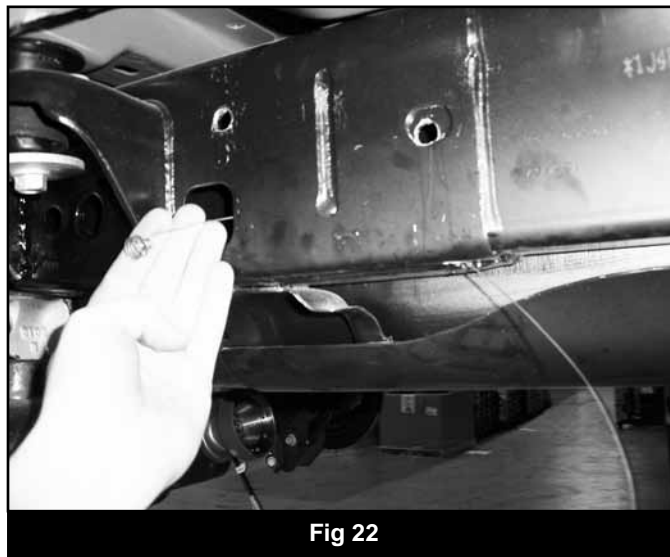

Fig 22

15. Reattach the bracket to the frame with new 12mm-1.50 x 35mm bolt with 12mm flat washer thru the OE skidplate mount. All the hardware for the rear control arm brackets is located in bolt pack #762. Install 1/2" x 1-1/2" bolts and 1/2" SAE washers into the rivet nuts. Fasten the bracket through the hole drilled into the body mount with a 7/16" x 1-1/4" bolt, nut and 3/8" USS washers. Fasten the bolt tab running out the bottom of the frame with a 1/2" nut and 1/2" SAE washer. Leave hardware loose until all hardware is installed. Torque 1/2" hardware to 65 ft-lbs and 7/16" hardware to 50 ft-lbs. Note: Use Loctite on bolts that go into rivet nuts. (Figure 23)

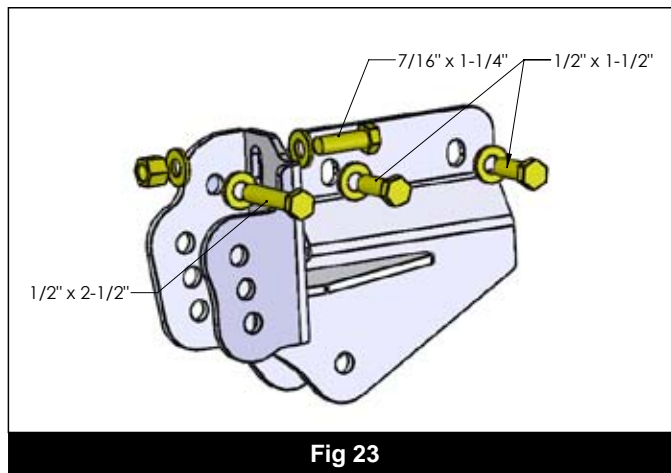

Fig 23

16. Install the new control arm bracket (01985) on driver's side frame. Locate the bracket just like the passenger's side. Clamp bracket into place and mark all holes to be drilled.
17. Drill holes at the marks to the same sizes as on passenger's side. Use the drill template to locate the body mount hole. (Fig 24). The 3 holes into the side of the frame rail will need to be drilled to 11/16" to accept rivet nuts. The hole thru the body mount will be 1/2" and the 2 holes that run from the bottom - up into the frame will need to be 9/16"

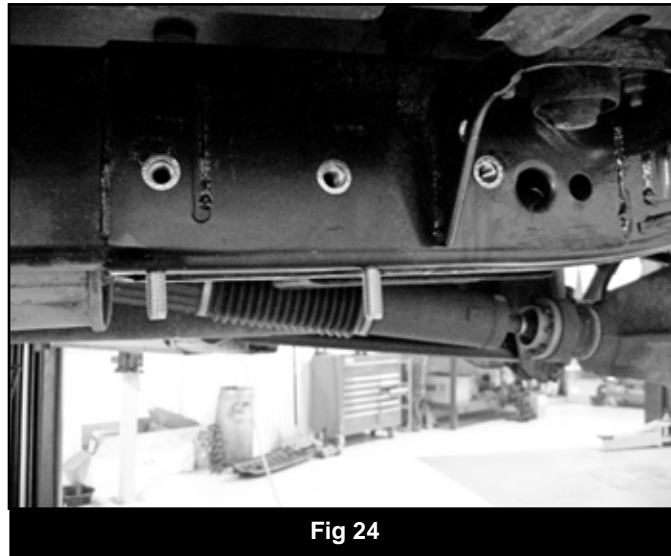

Fig 24

18. Use 1/2" x 2-1/2" bolt to install the rivet nuts just like on the passengers side. The front hole will take the long rivet nut, the rear 2 holes will take short rivet nuts.
19. Use the fish wire to pull bolt tabs (01797) through the frame into the 2 bottom holes (Fig 24).
20. Attach the bracket to the frame with the 1/2" nuts and 1/2" SAE washers on the two bolts tabs running out the bottom of the frame. Fasten the bracket through the hole drilled into the body mount with a 7/16" x 1-1/4" bolt, nut and 3/8" USS washers. Install a second 7/16" x 1-1/4" bolt and 3/8" USS washer through the hole located inside the body mount. Install a 1/2" x 1-1/2" bolt and 1/2" SAE washer through the remaining holes into the rivet nuts. Leave hardware loose until all hardware is installed. Torque 1/2" hardware to 65 ft-lbs and 7/16" hardware to 50 ft-lbs. Note: Use Loctite on bolts that go into rivet nuts.
21. Install new body mount bolt with large OD washer from bolt pack # 562. Repeat on opposite side. Tighten to 65 ft-lbs.
22. Go back and double check hardware. Torque 1/2" hardware to 65 ft-lbs and 7/16" hardware to 50 ft-lbs.
23. Locate the new rear LCAs (A194), Adjust the arms to 32 3/4" center to center. The ends are not parallel so be sure to measure from the center of the control arms. Remove the pre-installed straight grease fitting and install the provided 90 deg. zerk fittings so they are angling 45 deg. from the arm towards the center of the vehicle once installed.
24. Install the new LCA into the axle with the OE hardware. The LCAs are formed inward to clear the tire.
25. Install flex end into new LCA bracket. Attach with 9/16" x 4" bolt, washers, and nut (BP 762). The grease fitting should be on top. Leave loose at this time.
26. Locate the new rear upper control arms and adjust the length to 25-1/2" for 4 doors with 4.5-6.5" of lift or 26" for 2 doors with 4.5-5.5" kits. Measurement is from the center of end, to center of end. This is a good starting point and may need to be tweaked if a driveshaft vibration is present.
27. Install the UCAs to the axle with the OE hardware. Attach the adjustable end to the frame bracket with a 9/16" x 4" bolt, washers, and prevailing torque nuts (BP 762). Leave hardware loose at this time (Fig 25).

Note: It is recommended to use the upper most hole in the long arm bracket for all lift kits. To reduce rear anti-squat, choose a lower hole.

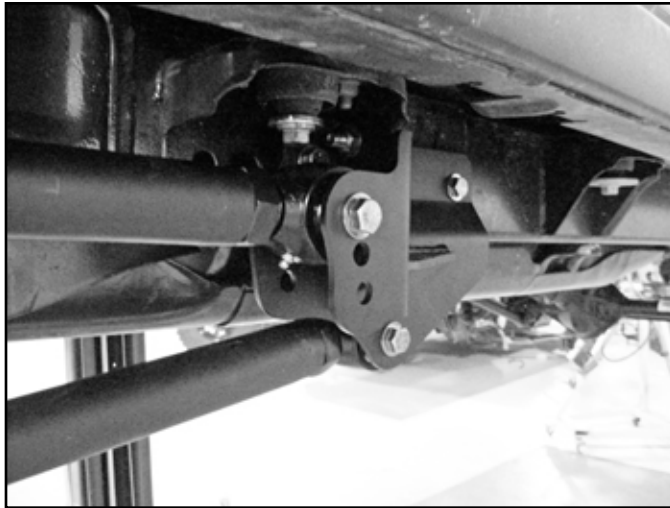

Fig. 25

28. Remove the jack stands and lower the vehicle to the ground.
29. Torque all of the rear control arm bolts to 95 ft-lbs.
30. Check all hardware for proper torque. Check hardware after 500 miles.
31. Lubricate all greaseable control arm ends. Lubricate joints at each scheduled maintenance interval.

DETAILED RIVET NUT INSTALLATION INSTRUCTIONS

Rivet Nut Sizing

32. Verify the correct size rivet nut for the application based on the thickness of material where the rivet nut is to be installed using the following chart.

Part Number	Thread Size	Body Length (in)	Material Thickness (in)		Drill Size (in)
			Min.	Max.	
95105A159	3/8-16	.690	.027	.150	17/32
95105A168	3/8-16	.805	.150	.312	17/32
95105A169	1/2-13	1.150	.063	.200	11/16
95105A170	1/2-13	1.300	.200	.350	11/16

Hole Preparation

33. Drill hole to appropriate size for rivet nut installation. 1/2" Rivnuts require an 11/16" hole and 3/8" Rivnuts require a 17/32" drill. It is critical that this hole is drilled to the correct size. Remove any burrs that could keep the rivet nut from seating flat against either side of the hole surface.

Note: If the correct drill size is not available, it is possible to drill the hole to an available smaller size and slowly grind it out to until the rivet nut fits tight.

Rivet Nut Installation Tool Assembly

34. For a 3/8" rivet nut, place the provided 3/8" SAE flat washer on the 3/8" x 1-1/2" bolt, followed by 7/16" hex nut and then a 3/8" serrated washer. Figure 1 Thread this tool assembly into the rivet nut.

35. For a 1/2" rivet nut, place the provided 1/2" SAE washer on a 1/2" x 2" bolt followed by a 9/16" high nut and 1/2" serrated edge lock washer. Thread this tool assembly into the rivet nut as shown. Figure 1

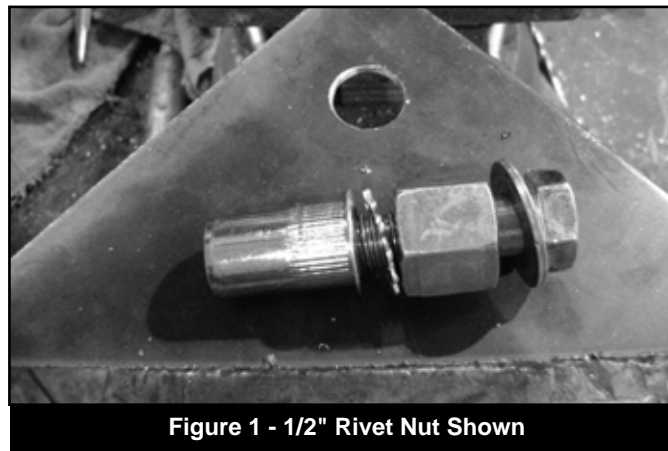

Figure 1 - 1/2" Rivet Nut Shown

Rivet Nut Installation

36. Place the installation tool with the rivet nut threaded on the end into the appropriately sized hole.

37. For a 3/8" rivet nut, hold the nut closest to the rivet nut still with an 5/8" wrench and tighten the 3/8" bolt with a 9/16" wrench to set the rivet nut. Be sure to hold the rivet nut flush to the surface and square to the hole as it is tightened. Figure 2

Note: If available, an impact gun is recommended for tightening the bolt to ensure the rivet nut remains square to the hole and to ease holding the nut from spinning.

38. For a 1/2" rivet nut, hold the nut closest to the rivet nut still with an 7/8" wrench and tighten the 1/2" bolt with a 3/4" wrench to set the rivet nut. Be sure to hold the rivet nut flush to the surface and square to the hole as it is tightened. Figure 4

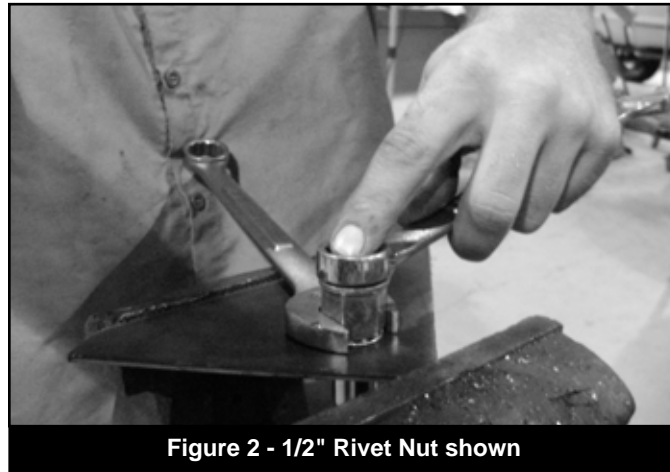

Figure 2 - 1/2" Rivet Nut shown

Torque Specifications

39. 3/8" rivet nuts will approach 40 ft. lbs for maximum grip strength. Do not exceed 45 ft-lbs when setting the rivet nut.
40. 1/2" rivet nuts will approach 90 ft lbs for maximum grip strength. Do not exceed 100 ft-lbs when setting the rivet nut.

ⓘ *Note: If using the recommended impact gun, use caution to not exceed the recommended torque specifications.*

Rivet Nut Tool Removal

41. Once the center bolt is tightened, remain holding the nut from spinning with the wrench and loosen the center bolt to remove the installation tool.

⚠ ***IMPORTANT*** It is very important to hold the nut as the bolt is loosened because the grip of the star washer will try to spin the rivet nut and ruin the installation.

42. Verify proper installation by checking for consistent rivet nut deformation to see the threads are square and centered to the rivet nut. Figure 3.

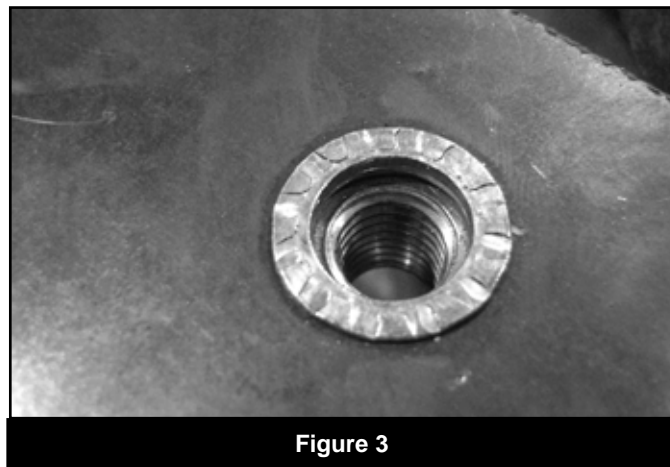

Figure 3

