



INSTALLATION INSTRUCTIONS

**PART # 17A096400MSS\17A096400MA
MODULAR GRILL GUARD FOR TOYOTA TACOMA 05-11**

QTY	DESCRIPTION
1	guard, center section
1	brush guard, left side
1	brush guard, right side
1	wire guard insert, left side
1	wire guard insert, right side
1	lower support bracket-left
1	lower support bracket-right
1	hardware kit

NOTE: Please read this information before assembling. Check components received with components listed above. **NO DRILLING REQUIRED.** Complete step by step instruction sheets will be found on the following pages.

- 1st. Stage, mounting of guard to vehicle.
- 2nd. stage, attaching brush guards to center section.
- 3rd . stage, attaching wire head light guards.

IMPORTANT: To obtain correct installation, we recommend you to follow these step by step instructions carefully.

Illustrations are for reference only, styles vary with application. Please review the instruction sheet before proceeding to assemble product.

Please take care when assembling and installing this product to protect the finish and your investment. To protect your investment, wax this product after installing. Regular waxing is recommended. Do not use any type of polish or wax that contains abrasive that could damage the finish.

INSTALLATION INSTRUCTIONS

1ST STAGE

PARTS LIST:

1	Grille Guard	6	12-1.75mm x 35mm Hex Head Bolts
1	Driver/Left Mounting Bracket	2	12-1.75mm x 120mm Hex Head Bolts
1	Passenger/Right Mounting Bracket	8	12mm Nylock Nut
1	Driver/Left Top Bracket	16	12mm ID x 32mm OD x 3mm Flat Washers
1	Passenger/Right Top Bracket	2	10mm x 30mm Button Head Bolts
2	10-1.50mm x 30mm "T" Bolts (plate 19x56x5mm)	4	10mm Nylock Nuts
		4	10.2mm OD x 26mm OD x 3.1mm Flat Washers

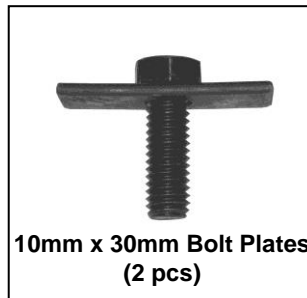
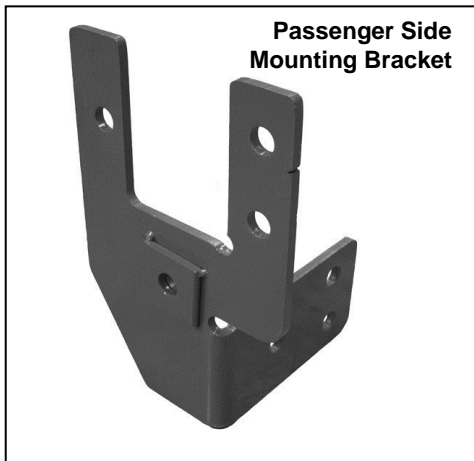

PROCEDURE:

- 1. REMOVE CONTENTS FROM BOX. VERIFY ALL PARTS ARE PRESENT. READ INSTRUCTIONS CAREFULLY BEFORE STARTING INSTALLATION. DO NOT ATTEMPT INSTALLATION ALONE; PERSONAL INJURY OR DAMAGE TO THE TRUCK MAY RESULT.**
2. Starting on the driver side remove the three existing nuts that hold the bumper support frame to the vehicle frame **(Figure 1)**.
3. Attach the upper holes on the driver side Mounting Bracket with existing nuts. To attach the lower hole on the Mounting Bracket use the included (1) 12mm x 120mm Hex Head Bolt, (1) 12mm Nylock Nut, and (2) 12mm Flat Washers **(Figure 1)**.
4. Repeat steps 2 & 3 for passenger side.
5. Locate one factory hole on each side of the radiator support, then insert from the top of the radiator support (1) 10mm Bolt Plate into each hole **(Figure 2)**
6. Slide the driver side Top Bracket through the plastic grille opening with 90° bend towards the front and side of the vehicle **(Figure 3)**. Attach the inner mounting location of the Top Bracket to already inserted Bolt Plate using the included (1) 12mm Flat Washer, and (1) 12mm Nylock Nut **(Figure 4)**.
7. With help position the Grille Guard on the inside of Mounting Brackets. Use the included (6) 12mm x 35mm Hex Head Bolts, (6) 12mm Nylock Nuts, and (12) 12mm Flat Washers to attach Grille Guard to Mounting Brackets **(Figure 1)**.
8. Proceed to attach the Top Brackets on the inner edge of the Grille Guard using the included (2) 10mm x 25mm Button Head Bolts, (2) 10mm Nylock Nuts, and (2) 10mm Flat Washers.
9. Align the Grille Guard properly; and then tighten all hardware at this time.
10. Do periodic inspections to the installation to make sure that all hardware is secure and tight.

To protect your investment, wax this product after installing. Regular waxing is recommended to add a protective layer over the finish. Do not use any type of polish or wax that may contain abrasives that could damage the finish.

For stainless steel: Aluminum polish may be used to polish small scratches and scuffs on the finish. Mild soap may be used also to clean the Grille Guard.

For gloss black finishes: Mild soap may be used to clean the Grille Guard.

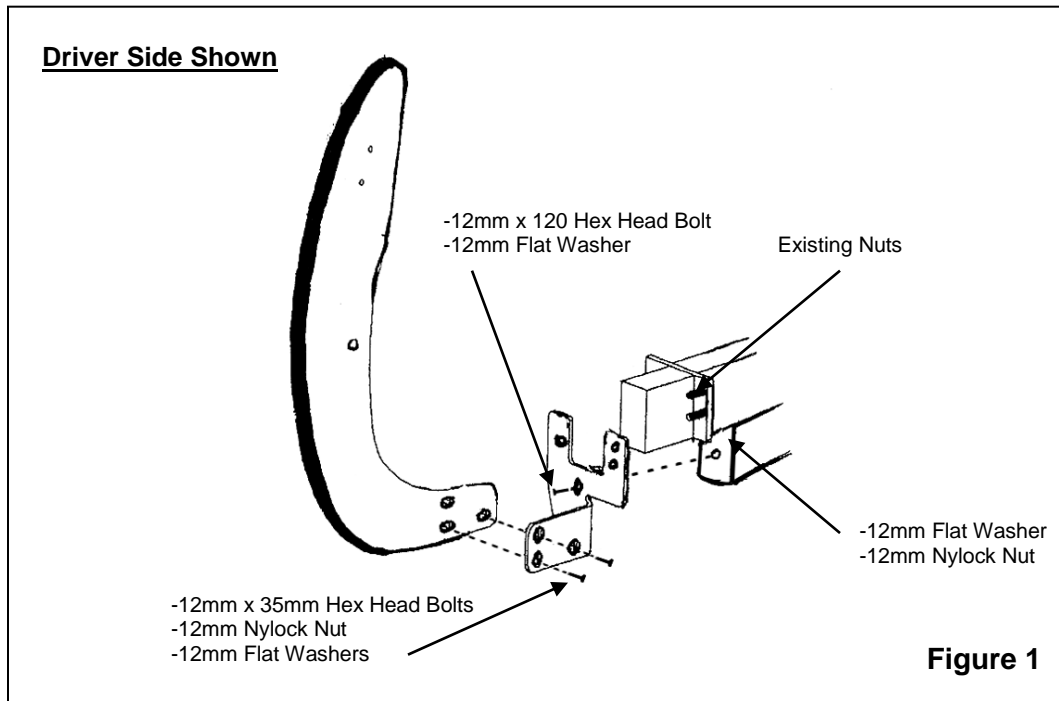

(Passenger Side Installation Shown Below)

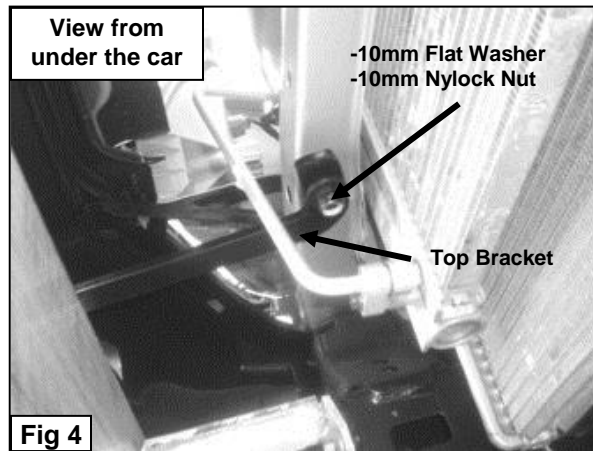
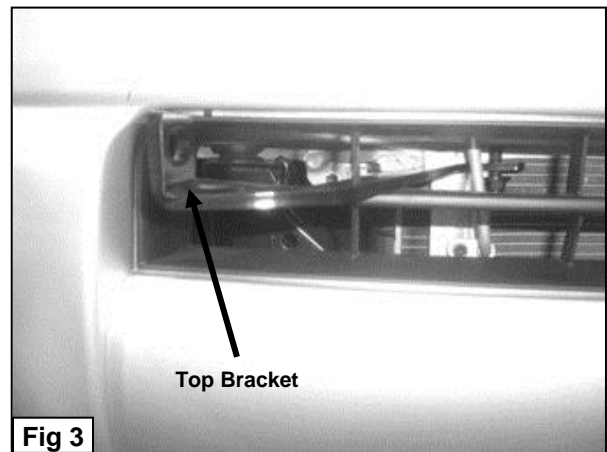
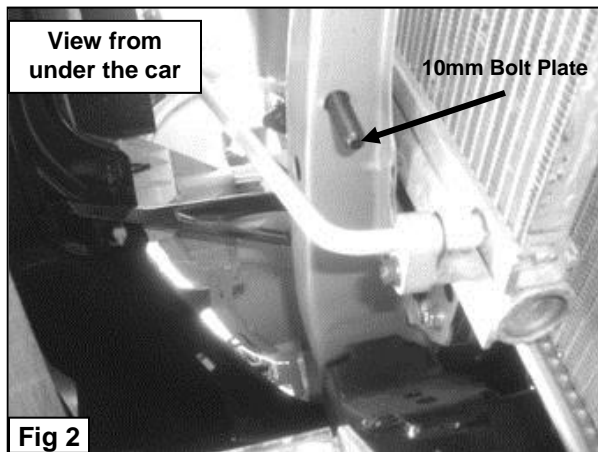

INSTALLATION INSTRUCTION

2nd STAGE

Step One: Locate hardware. Check contents with the hardware listed below.

QTY	DESCRIPTION
6	M8-1.25 x 20 button head bolts, stainless steel
6	M8-1.25 acorn nuts, stainless steel
12	M8 flat washers, stainless steel
2	rubber gaskets

Step Two: Securing brush guards to center section. Locate the following item's listed below.

QTY	DESCRIPTION
1	brush guard, left side
1	brush guard, right side

Assemble the brush guards to the center section of the guard as shown in illustration below. Use the hardware from step one to secure the parts together. Be sure to fully tighten all hardware at this time. Proceed ahead to stage four of the instruction sheet.

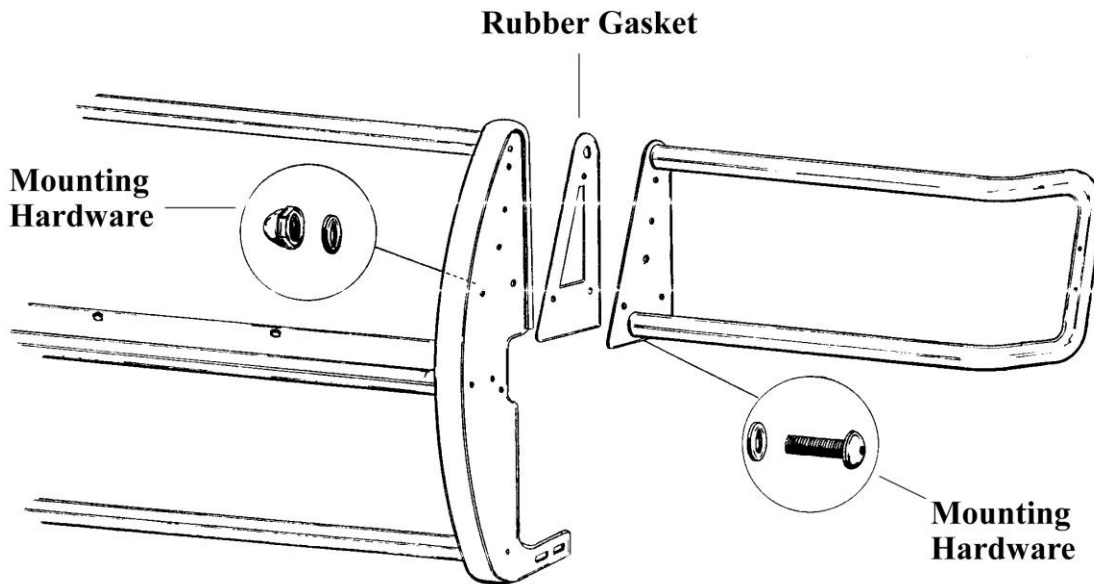

INSTALLATION INSTRUCTION

3rd STAGE

Step One: Locate hardware. Check contents with the hardware listed below.

QTY	DESCRIPTION
8	M6-1.00 x 25mm button head bolts, stainless steel
4	M6-1.00 acorn nuts, stainless steel
12	M6 flat washers, stainless steel
4	rubber gaskets

Step Two: Securing wire insert to brush guards. Locate the following item's listed below.

QTY	DESCRIPTION
2	wire guard insert, left & right side

Attach one rubber gasket to each end of the wire guard. Peel the paper backing off the rubber gasket. Place the gasket on the end of the bracket and press firmly till the gasket is secured in place.

Position the wire insert on the driver's side of the vehicle. Align the two holes in the bracket with the two holes in the brush guard as shown in illustration below. Using the hardware listed in step one, secure the wire insert to the brush guard. Be sure to fasten both ends before fully tightening hardware. Repeat this procedure on the opposite side of the vehicle. Be sure to use all hardware supplied and tighten all bolts.

