

INSTALLATION INSTRUCTION











ITEM NUMBER: 8B0520SS-DL

BRACKETS FOR S/S UNIVERSAL REAR BUMPER GUARD (DOUBLE LAYER) FOR HONDA CRV 07-15

NOTICE:

- ≡ The figures here are for reference only and may have differences with the actual product you received, however they share the same assembly way.
- ≡ Please read the instruction completely for easy installation, which will also help you to avoid scratches or other potential damages to your appealing car.
- ≡ Please periodically check and retighten all the hardware and clean the investment for a refresh look.

PART LIST

No.	Qty	Name	No.	Qty	Name
①	1	 Rear bar	⑥	4	 M8*25 Hex bolt
②	1	 Bracket-A-L	⑦	4	 M10*35 Hex bolt
			⑧	4	 M10*35 Hex bolt
③	1	 Bracket-A-R	⑨	12	 D10 Flat washer
			⑩	8	 D10 Spring washer
④	1	 Bracket-B-L	⑪	4	 D10 Hex nut
⑤	1	 Bracket-B-R			
					/

ASSEMBLY PROCEDURE:

Step 1: Check all the contents are available in accordance with the above list.

Step 2: Remove the bottom factory skid plate, using M10*35 Hex bolts (8) to install Bracket-B-L&R. Do not tighten all the bolts. (FIG.2&3)

Step 3: Install the factory skid plate. Then install the rear bar on Bracket-A-L &B. Connect Bracket-A & B as FIG.1. Do not tighten all the bolts.

Step 4: Test and make sure that the rear bar is steadily fixed, and then tighten all the hardware.

Step 5: Install the factory skid plate to original position, the small size skid plate is no need to install.

Step 6: Installation is finished.

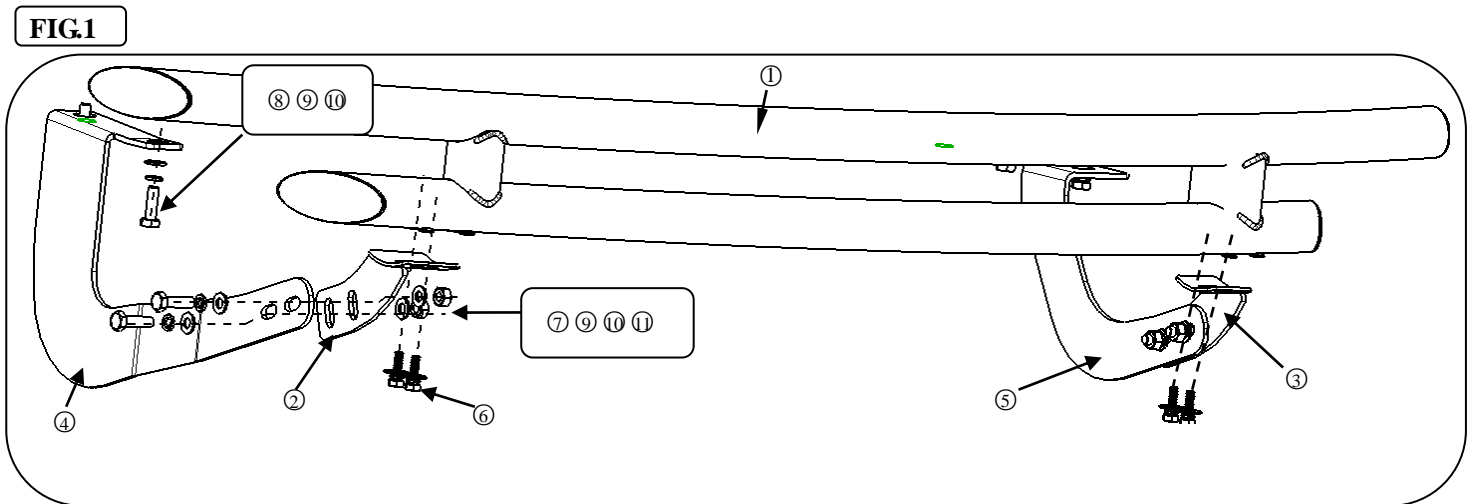

Remove the skid plate



Bracket-B will across the skid plate.

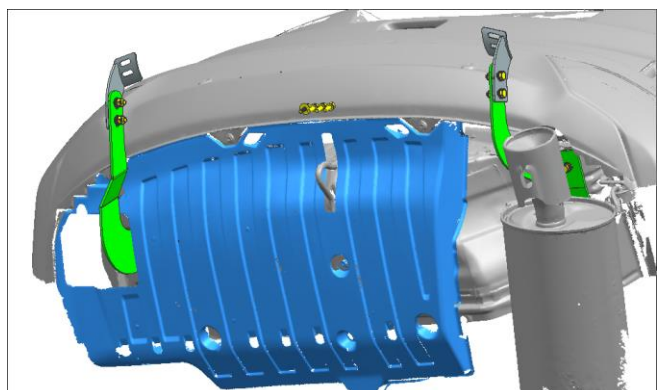

FIG.2

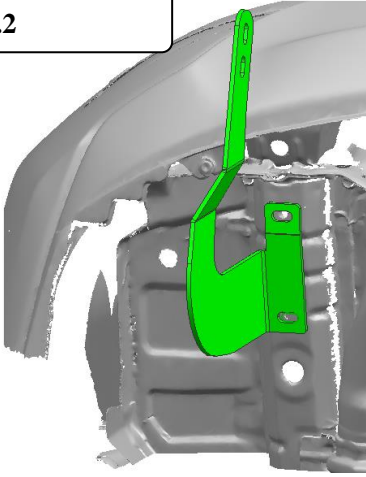
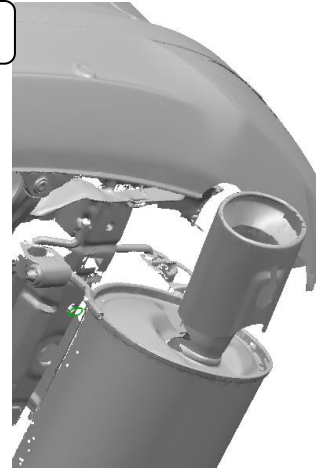

FIG.3



NOTE: Any damages and losses caused by improper installation and application, goes beyond our quality warranty.