



INSTALLATION INSTRUCTIONS

BLACK MODULAR FRONT RUNNER GRILLE GUARD FOR HONDA

CRV 2017-2020

PART #15HOCRA-17





Before Installation

- Please read the instruction completely for easy installation, which will also help you to avoid scratches or other potential damages to your appealing car.
- The figures here are for reference only and may have differences with the actual product you received, however they share the same assembly way.



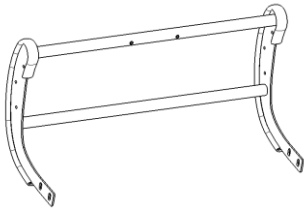
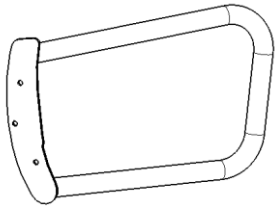
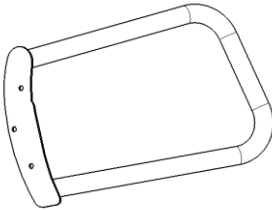
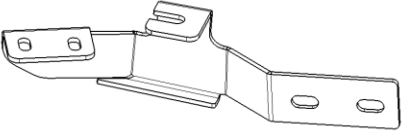
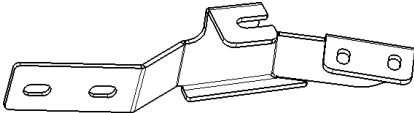

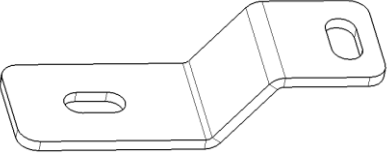



Care and Cleaning

- Mild soap may be used also to clean the Product.
- Please periodically check and retighten all the hardware and clean the investment for a refresh look.

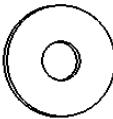
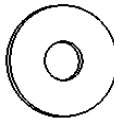
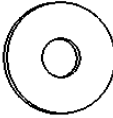
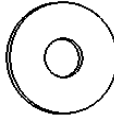
Parts list

NO.	QTY	PIC	NO.	QTY	PIC
①	1	 FRONT GUARD	②	1	 LEFT BRUSH GUARD
③	1	 RIGHT BRUSH GUARD	④	1	 LEFT BRACKET
⑤	1	 RIGHT BRACKET	⑥	2	 MOUNTING BRACKET
⑦	2	 Z BOLT PLATE	⑧	6	 SPLIT WASHERS D8

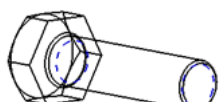
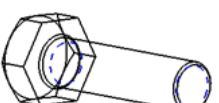
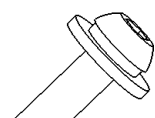
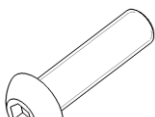
BLACK MODULAR FRONT RUNNER GRILLE GUARD FOR HONDA CRV 2017-2019

<p>⑨</p> <p>4</p>		 <p>SPLIT WASHERS D10</p>	<p>⑩</p> <p>4</p>	 <p>SPLIT WASHERS D12</p>
<p>⑪</p> <p>2</p>		 <p>LARGE WASHER D6</p>	<p>⑫</p> <p>12</p>	 <p>LARGE WASHER D8</p>
<p>⑬</p> <p>8</p>		 <p>LARGE WASHER D12</p>	<p>⑭</p> <p>4</p>	 <p>LARGE WASHER D10</p>
<p>⑮</p> <p>2</p>		 <p>HEX NUT M6</p>	<p>⑯</p> <p>6</p>	 <p>HEX NUT M8</p>
<p>⑰</p> <p>4</p>		 <p>HEX NUT M12</p>	<p>⑱</p> <p>4</p>	 <p>HEX NUT M12*35</p>
<p>⑲</p> <p>4</p>		 <p>HEX NUT M10*35</p>	<p>⑳</p> <p>6</p>	 <p>Button Head Bolt M6*20</p>
<p>㉑</p> <p>6</p>		 <p>HEX BOLT M8*25</p>	<p>㉒</p> <p>1</p>	 <p>ALLEN WRENCH S=4</p>
<p>㉓</p>		 <p>ALLEN WRENCH S=5</p>		

Installation Steps

INSTALLING PICTURE:

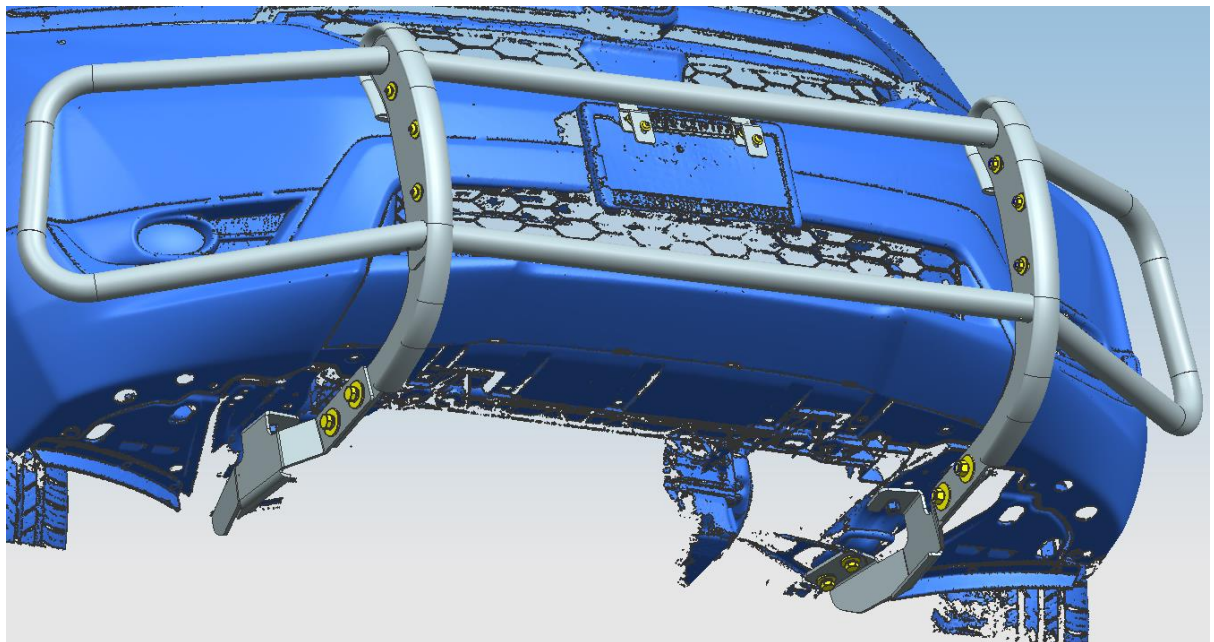
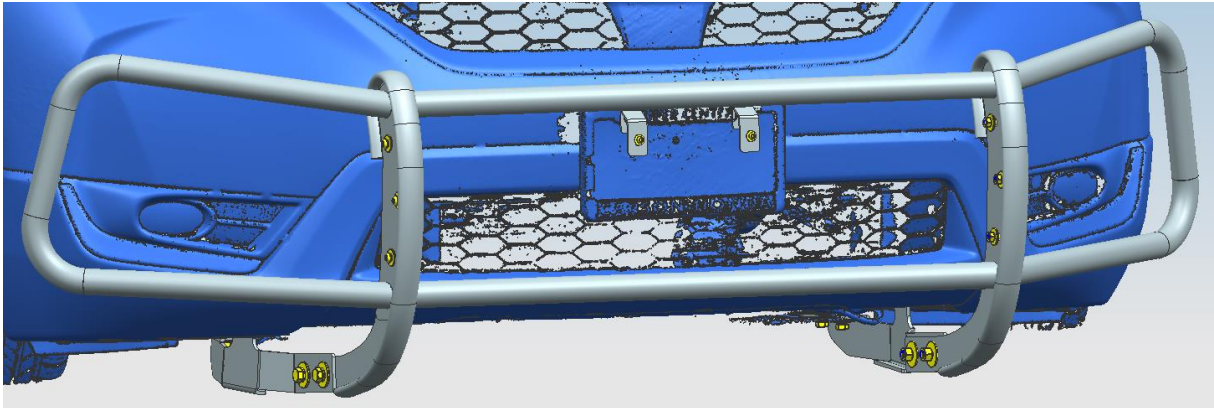
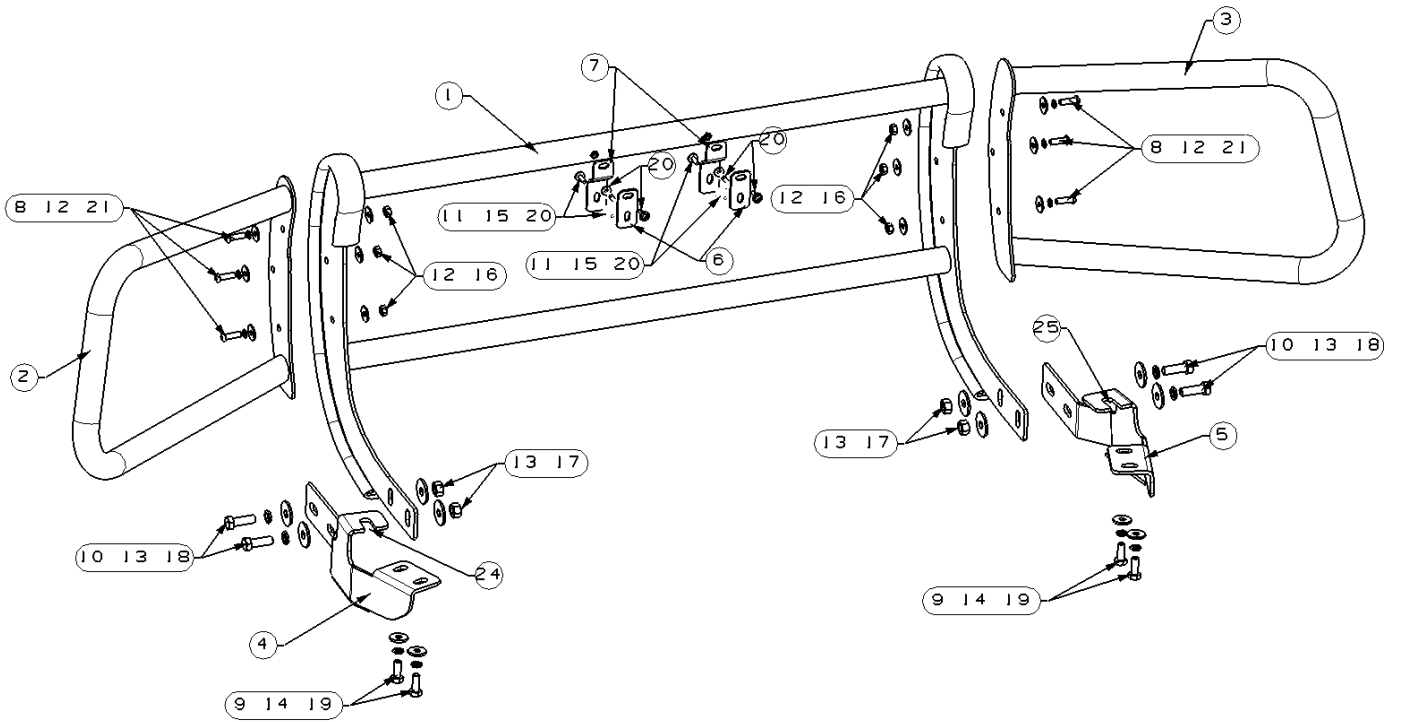

Step 1: Verify that all parts are present according to the manual.

Step 2: Install the Grille guard and brackets to the vehicle follow installing picture. No.24 and No.25 both are original standard parts.

Step 3: Test and make sure that the grille guard is steadily fixed, fully tighten all hardware.

Step 4: Installation is finished, pick up all tools.

NOTE

Any damages and losses caused by improper installation and application, goes beyond our quality warranty.