



# **INSTALLATION INSTRUCTIONS**

**BLACK MODULAR GRILLE GUARD FOR TOYOTA RAV4 2019-2021**

**PART # 17A093904MA**





## Before Installation



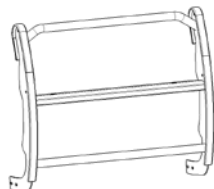
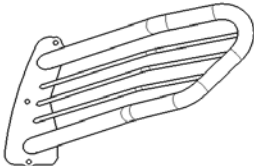
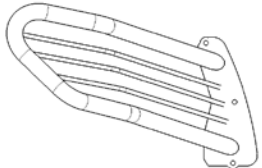
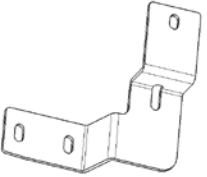
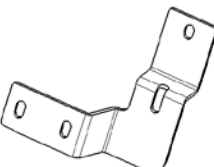

- Please read the instruction completely for easy installation, which will also help you to avoid scratches or other potential damages to your appealing car.
- The information shown here is for reference only and may differ from the product that you receive, however the goods are fitted in the same way.

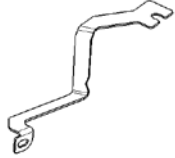
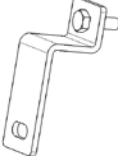
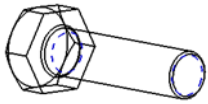
## Care and Cleaning

- Mild soap may be used also to clean the Product.
- Please periodically check and retighten all the hardware and clean the investment for a refresh look.

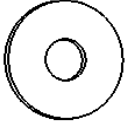
## Parts list

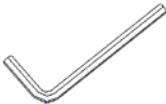
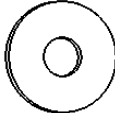
NO.	QTY	PICTURE	NO.	QTY	PICTURE
①	1	 GRILLE GUARD	②	1	 LEFT BRUSH GUARD
③	1	 RIGHT BRUSH GUARD	④	1	 BRACKET ( L )
⑤	1	 BRACKET ( R )	⑥	1	 SUPPORT BRACKET ( L )
⑦	1	 SUPPORT BRACKET ( R )	⑧	2	 PLATE BOLT
⑨	6	 HEX BOLT M10*35	⑩	8	 SPRING WASHER D10

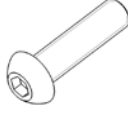
<p>⑪</p>	<p>14</p>	 <p>LARGE WASHER D10</p>	<p>⑫</p>	<p>8</p>	 <p>HEX NUT M10</p>
<p>⑬</p>	<p>1</p>	 <p>ALLEN WRENCH S=5</p>	<p>⑭</p>	<p>12</p>	 <p>LARGE WASHER D8</p>
<p>⑮</p>	<p>6</p>	 <p>TYPE 1 HEX LOCK NUT M8 WITH NON-METALLIC INSERT</p>	<p>⑯</p>	<p>6</p>	 <p>HEX SOCKET BUTTON HEAD SCREW M8</p>

**InstallationSteps**

**Installation Figure:**

Step 1: Mount support bracket L&R ⑥ ⑦ on the mounting point in the hood of the car, (Figure 1) .  
Do not fully tighten the bolts at this step.

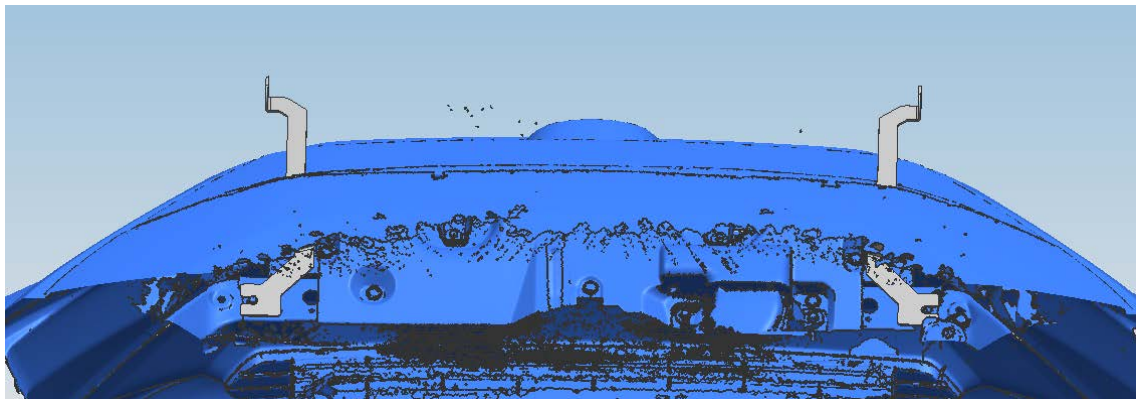

(Figure 1)

Step 2: Mount bracket L&R ④ ⑤ in the bottom of the frame with plate bolt ⑧, hex bolt m10\*35 ⑨, spring washer d10 ⑩, large washer d10 ⑪ and hex nut m10 ⑫. Do not fully tighten the bolts at this step.

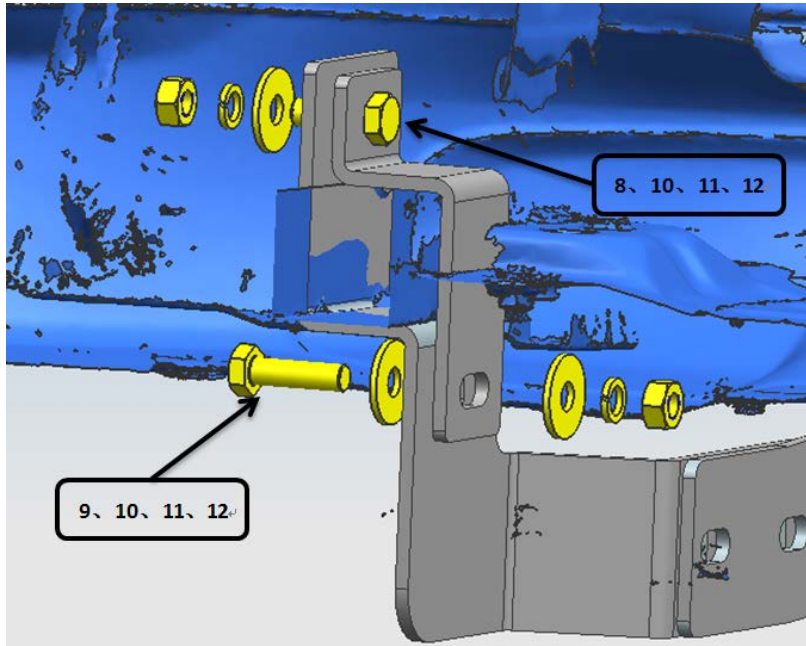

(Figure 2)

Step 3: Install grille guard ①, brush guard L&R ② ③ and support bracket L&R ⑥ ⑦ with allen wrench S=5 ⑬, large washer D8 ⑭, type 1 hex lock nut m8 with non-metallic insert ⑮ and hex socket button head screw M8 ⑯, (Figure 3). Connect grille guard and brackets with hex bolt m10\*35 ⑨, spring washer d10 ⑩, large washer d10 ⑪ and hex nut m10 ⑫, (Figure 4).

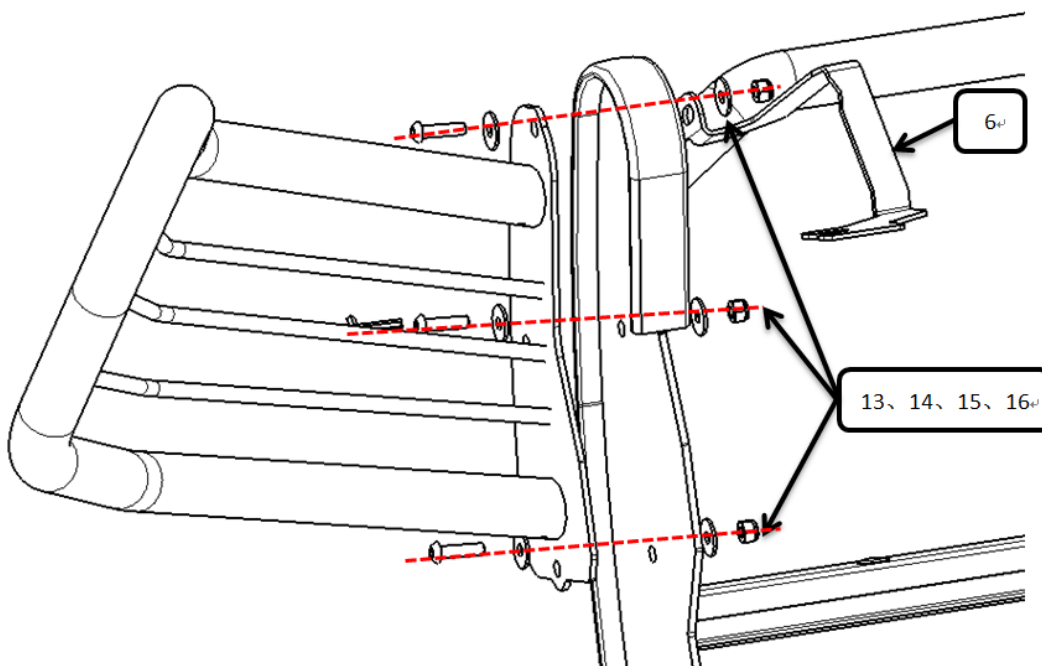

(Figure 3)

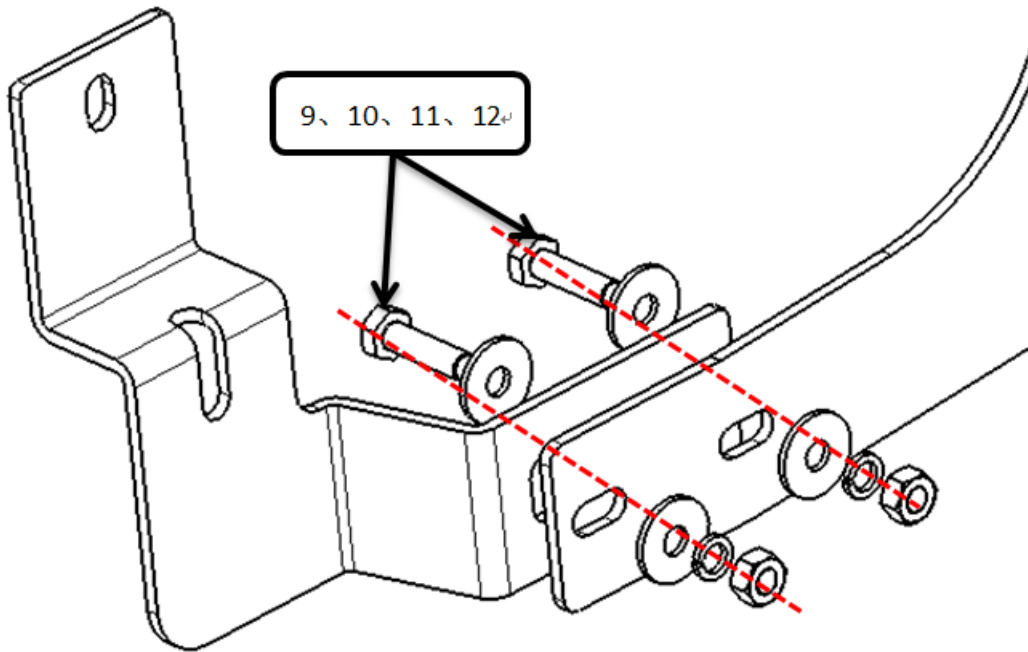

(Figure 4)

Step 4: Adjust the grille guard to perfect position and fully tighten all the hardware.

Step 5: Installation finished, pick up all tools.

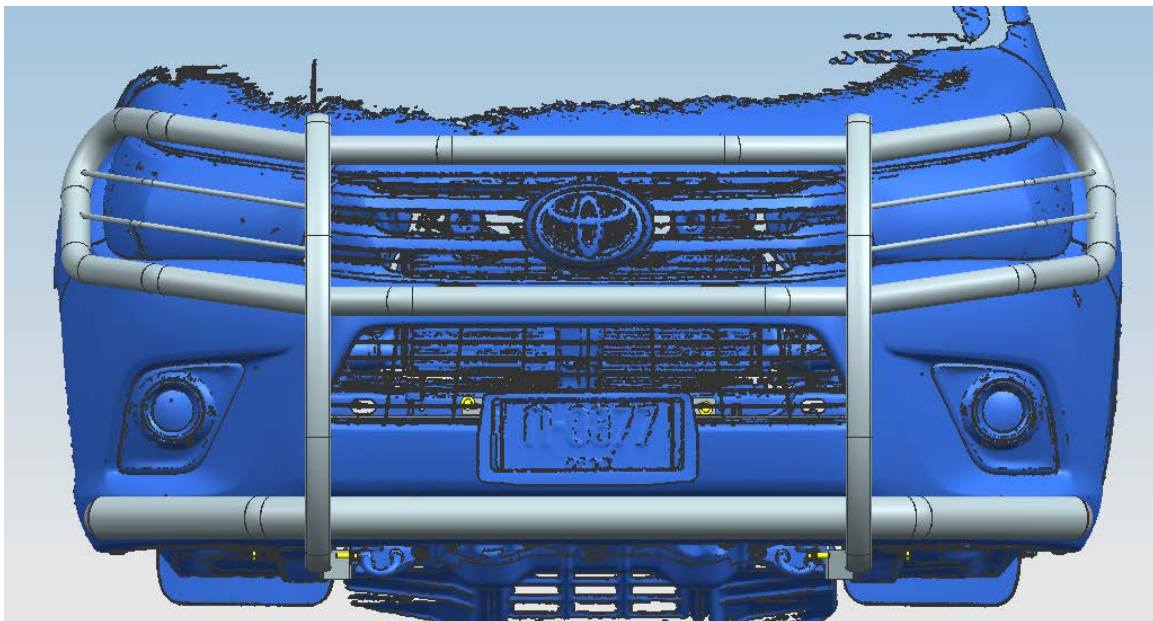

●NOTE: Any damages and losses caused by improper installation and application, goes beyond our quality warranty.