

5" OVAL BENT END SIDEBARS
04-15 NISSAN TITAN CREW CAB
2017-18 NISSAN TITAN CREW CAB
16-18 NISSAN TITAN XD CREW CAB



**BLACK HORSE
OFF ROAD**

INSTALLATION INSTRUCTIONS

**5" OVAL BENT END SIDEBARS
04-15 NISSAN TITAN CREW CAB
17-18 NISSAN TITAN CREW CAB
16-18 NISSAN TITAN XD CREW CAB
PART# 9NITIA-BN/9NITISS-BN**

PARTS LIST:

| | | | |
|----|-----------------------------------|----|--|
| 1 | Driver/Left Sidebar | 12 | 8-1.25mm x 25mm Combination Hex Bolts |
| 1 | Passenger/Right Sidebar | 12 | 8mm Lock Washers |
| 3 | Driver/Left Mounting Brackets | 6 | 8mm x 24mm OD x 2mm STD Flat Washers |
| 3 | Passenger/Right Mounting Brackets | 6 | 8mm x 16mm OD x 1.6mm Small Flat Washers |
| 12 | 8-1.25mm x 30mm Hex Bolts | 6 | 8mm Nylon Lock Nuts |

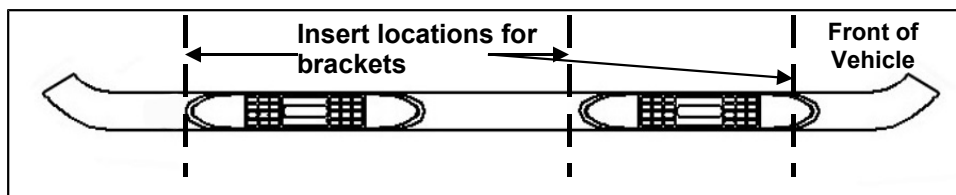
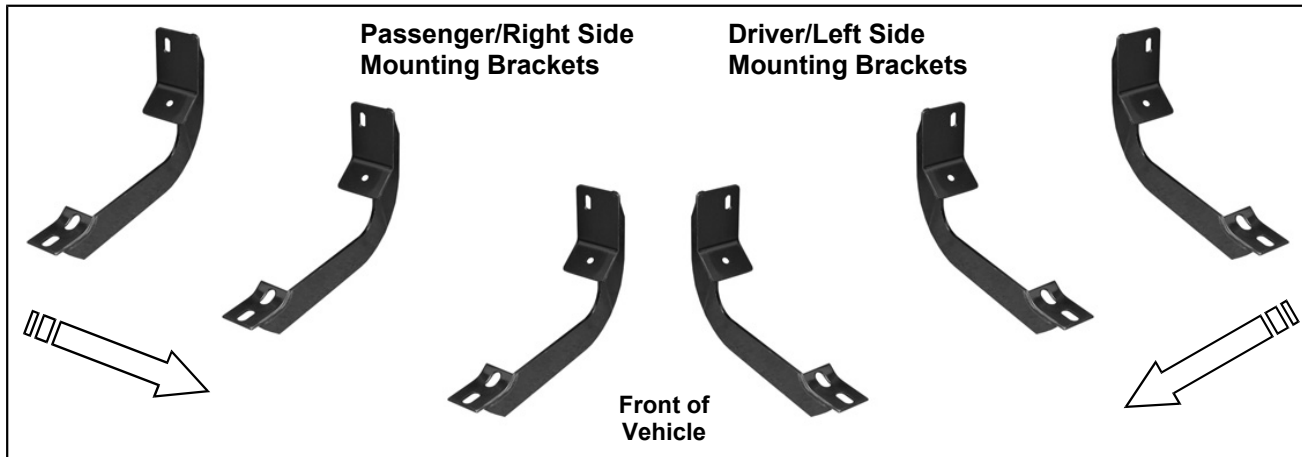

PROCEDURE:

- REMOVE CONTENTS FROM BOX. VERIFY ALL PARTS ARE PRESENT. READ INSTRUCTIONS CAREFULLY BEFORE STARTING INSTALLATION.**
- Start installation at the front of the driver side of the vehicle and locate the factory threaded holes or stud located on the side of the inner body panel, **(Figure 1)**. **NOTE:** Remove the plastic plug or any insulation on the side panel to locate the threaded holes.
- Select (1) driver side Mounting Bracket. Attach the Bracket to the mounting location with:
 - Models with threaded stud:** Attach Bracket to stud with (1) 8mm x 24mm STD Flat Washer and (1) 8mm Nylon Lock Nut. Next, insert (1) 8mm x 30mm Hex Bolt with (1) 8mm Lock Washer and (1) 8mm x 16mm Small Flat Washer through the remaining lower hole in the Bracket and into the threaded hole, **(Figures 1A, 2 and 3)**. Do not tighten hardware at this time.
 - Models without threaded stud:** Attach Bracket to the upper threaded hole with (1) 8mm x 24mm STD Flat Washer, (1) 8mm Lock Washer and (1) 8mm x 30mm Hex Bolt. Attach Bracket to the lower threaded hole with (1) 8mm x 16mm Small Flat Washer, (1) 8mm Lock Washer and (1) 8mm Hex Bolt, **(Figure 1B & 2)**. Do not tighten hardware at this time.
- There are (4) mounting locations along the body panel. Bracket installation will use the 1st, 2nd and 4th mounting locations. Repeat the appropriate **Steps 2—3** to install the center and rear Mounting Brackets, **(Figures 2—6)**. **NOTE:** The cradles on the Mounting Brackets should be facing the rear of the vehicle when properly installed, **(Figure 4)**.
- Once all three Mounting Brackets are partially installed, carefully place the driver Sidebar onto the Mounting Brackets. Use the included (6) 8mmx 25mm Combination Bolts to attach the Sidebar to the Mounting Brackets, **(Figures 5 & 6)**.
- Level and adjust the Sidebar and tighten all hardware at this time.

7. Repeat **Steps 2—6** for passenger Sidebar installation.

8. Do periodic inspections of the installation to make sure that all hardware is secure and tight.

To protect your investment, wax this product after installing. Regular waxing is recommended to add a protective layer over the finish. Do not use any type of polish or wax that may contain abrasives that could damage the finish.

For stainless steel: Aluminum polish may be used to polish small scratches and scuffs on the finish. Mild soap may be used also to clean the Sidebar.

For gloss black finishes: Mild soap may be used to clean the Sidebar.

Driver Side Installation Pictured

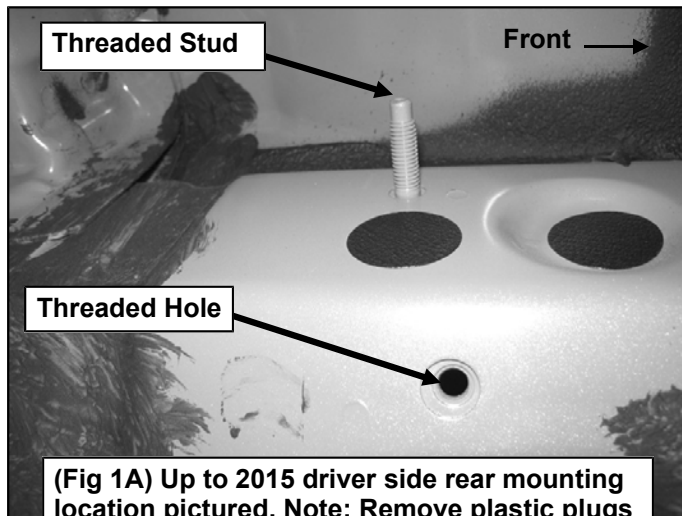

(Fig 1A) Up to 2015 driver side rear mounting location pictured. Note: Remove plastic plugs to locate factory threaded holes

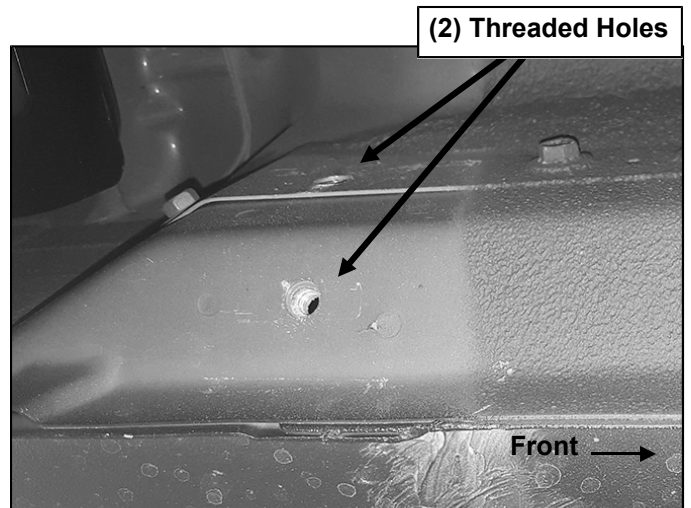

(Fig 1B) 2016-on driver side rear mounting location pictured. Note: two factory threaded holes only

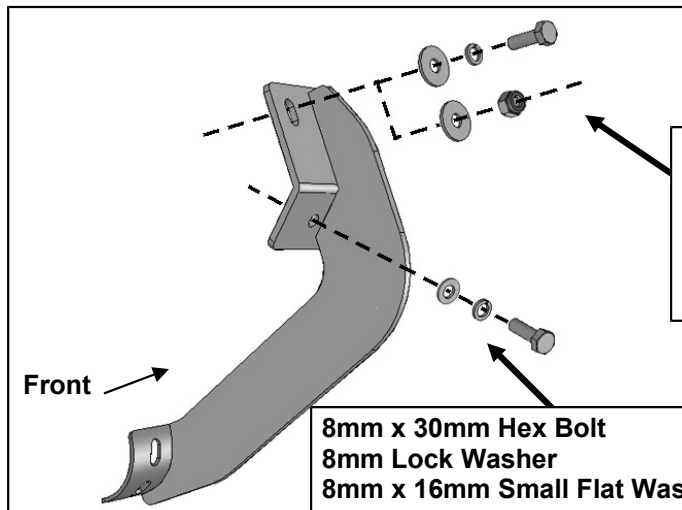

- 8mm x 30mm Hex Bolt
- 8mm Lock Washer
- 8mm x 24mm STD Flat Washer
- Or
- 8mm x 24mm STD Flat Washer
- 8mm Nylon Lock Nut

- 8mm x 30mm Hex Bolt
- 8mm Lock Washer
- 8mm x 16mm Small Flat Washer

(Fig 2) Driver/left Bracket illustrated for example only



(Fig 3) Up to 2015 Driver side front Bracket installed

5" OVAL BENT END SIDEBARS
04-15 NISSAN TITAN CREW CAB
2017-18 NISSAN TITAN CREW CAB
16-18 NISSAN TITAN XD CREW CAB

Driver Side Installation Pictured

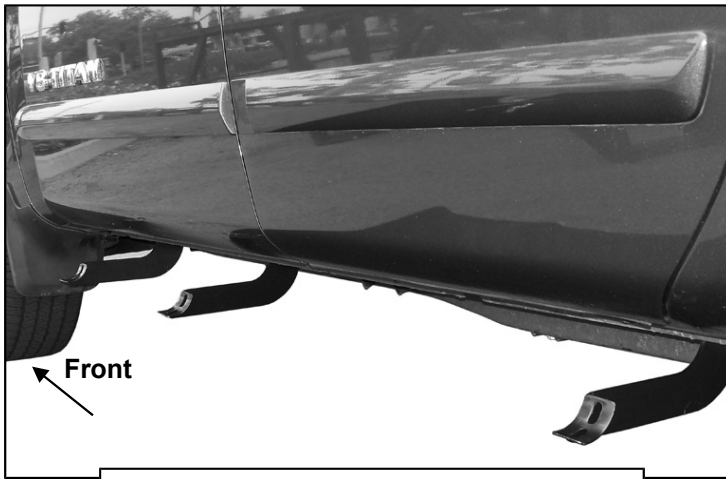

(Fig 4) Driver side Brackets installed.
Note all cradles face back of vehicle

8mm x 24mm STD Flat Washer
8mm Nylon Lock Nut
Or
8mm x 30mm Hex Bolt
8mm Lock Washer
8mm x 24mm STD Flat Washer

8mm x 30mm Hex Bolt
8mm Lock Washer
8mm x 16mm Small Flat Washer

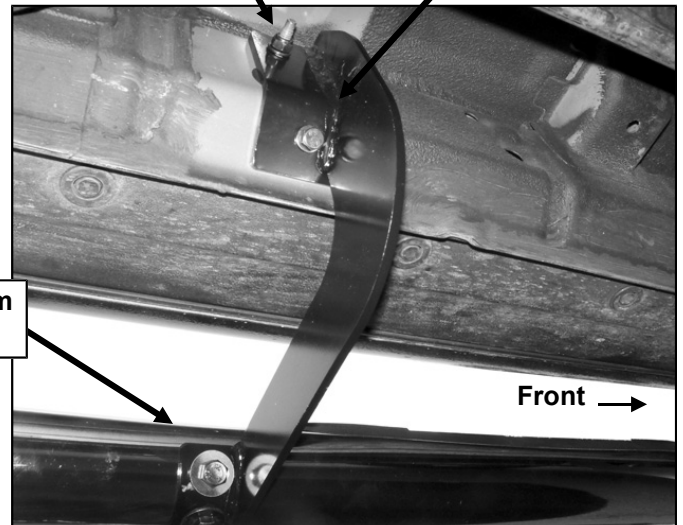

(Fig 5) Driver side center mounting location pictured

8mm x 30mm Hex Bolt
8mm Lock Washer
8mm x 16mm Small Flat Washer

(2) 8mm x 25mm Combo Bolts

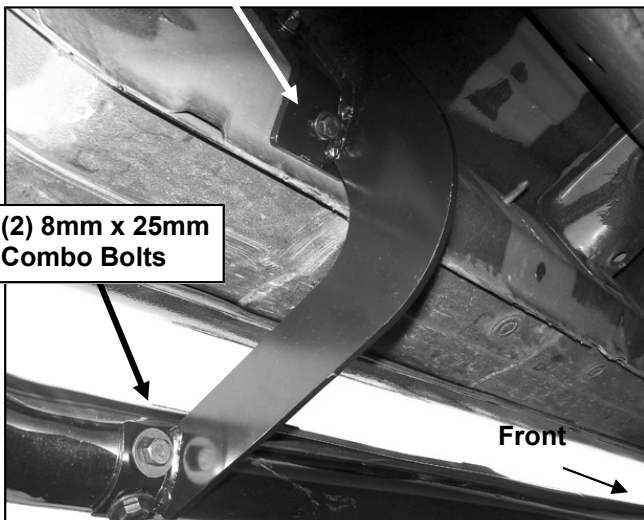

(2) 8mm x 25mm Combo Bolts

(Fig 6) Driver side rear mounting location pictured



Complete Installation