



INSTALLATION INSTRUCTIONS

UNIVERSAL REAR BUMPER GUARD (DOUBLE LAYER) FOR NISSAN

ROGUE 14-20

PART # CRDL-NIN101B

INSTALLATION INSTRUCTIONS











Before Installation

- Please read the instruction completely for easy installation, which will also help you to avoid scratches or other potential damages to your appealing car.
- The information shown here is for reference only and may differ from the product that you receive, however the goods are fitted in the same way.

Care and Cleaning

- Mild soap may be used also to clean the Product.
- Please periodically check and retighten all the hardware and clean the investment for a refresh look.

Parts list

NO.	QTY	PICTURE	NO.	QTY	PICTURE
①	1	 Rear bar	②	1	 Bracket-A-L
③	1	 Bracket-A-R	④	1	 Bracket-B-L
⑤	1	 Bracket-B-R	⑥	2	 Hook bolt
⑦	2	 Hook bolt connection plate	⑧	2	 Plastic plate
⑨	4	 Hex bolt M8*25	⑩	4	 Hex bolt M10*35

INSTALLATION INSTRUCTIONS

⑪	10	 Flat washer D10	⑫	6	 Spring washer D10
⑬	6	 Hex nut D10			

Installation Steps

FIG.1

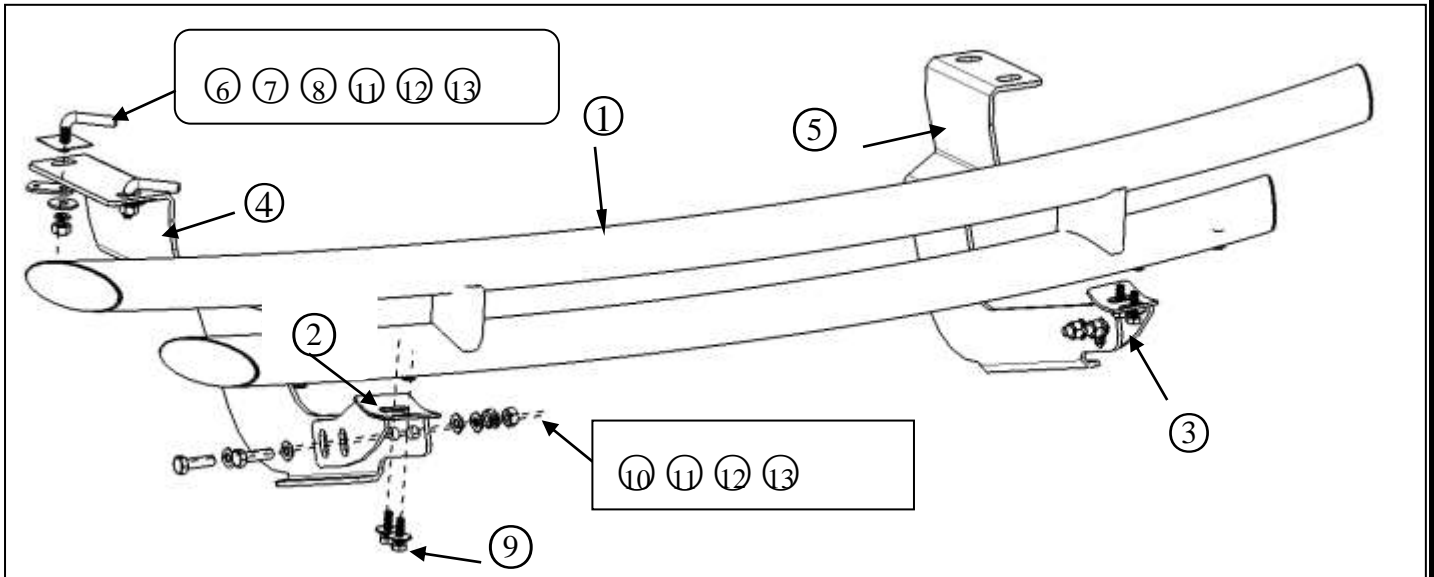

Install holes

using factory bolts to install

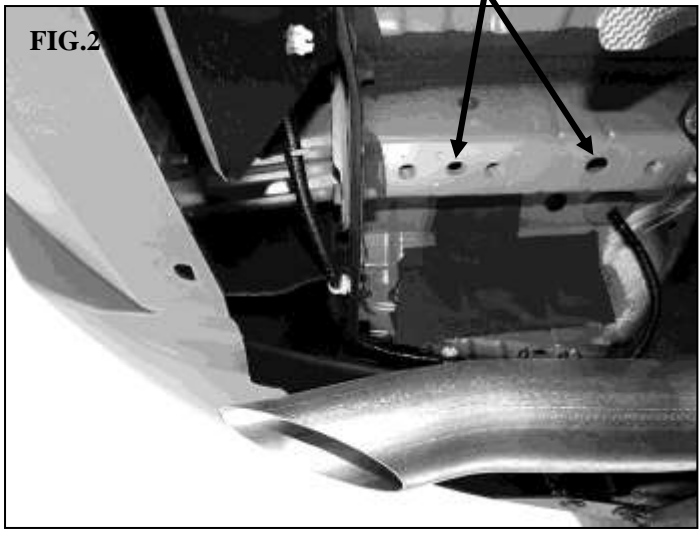

INSTALLATION INSTRUCTIONS

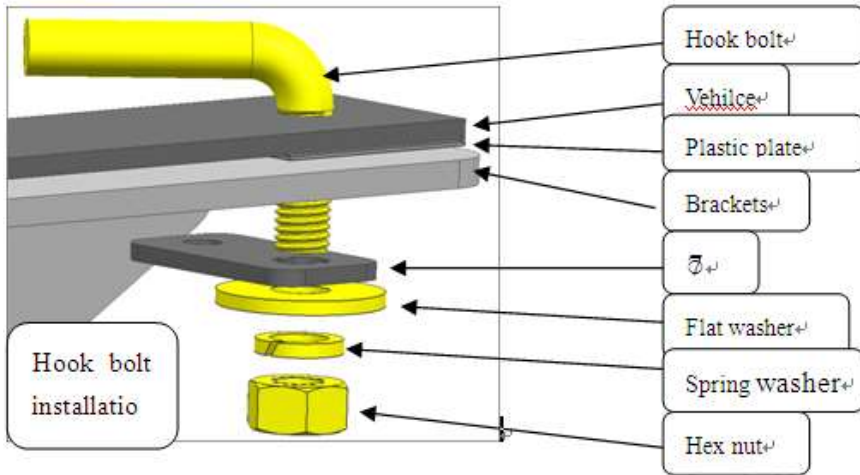

Step 1: Check all the contents are available in accordance with the above list.

Step 2: Remove the bottom factory skid plate, using Hook bolt to install Bracket-B-L. Do not tighten all the bolts. **(FIG.2)**

Step 3: Remove the bottom factory skid plate and tow hook, using factory bolts (from tow hook) to install Bracket-B-R. Do not tighten all the bolts. **(FIG.3)**

Step 4: Install the rear bar on Bracket-A-L & B. Connect Bracket-A & B as **FIG.1**. Do not tighten all the bolts.

Step 5: Test and make sure that the rear bar is steadily fixed, and then tighten all the hardware.

Step 6: Install the factory skid plate to original position.

Step 7: Installation is finished.

NOTE

Any damages and losses caused by improper installation and application, goes beyond our quality warranty.