



BX1146

2021-22 Jeep Grand Cherokee L (No Overland) (Includes Adaptive Cruise Control & Shuttters) Installation Instructions

Attachment Tab Height: 18.25"

Attachment Tab Width: 22"

Serial Number

Please read BOTH these Installation Instructions and the General Information sheet prior to installing or operating this equipment.

- Blue Ox® towing products and accessories are intended to be installed by Blue Ox® Dealers who are familiar with our products and have the equipment and knowledge necessary to do "fit work".
- Many Blue Ox® baseplates are designed to use existing holes and hardware to mount the baseplate to the towed vehicle. Even though bolts are there, do not assume they are adequate for baseplate mounting. Always use the hardware supplied in the hardware kit and existing hardware as specified in the installation instructions.

Bolt Torque Specifications

Torque in Foot-Pounds for Inch Bolts

Bolt Size	Grade 5	Grade 8
1/4"	10	14
5/16"	19	29
3/8"	33	47
7/16"	54	78
1/2"	78	119
5/8"	154	230
3/4"	257	380



Bolt Torque Specifications

Torque in Foot-Pounds for Metric Bolts

Bolt Size	Grade 8.8	Grade 10.9
6MM	6	8
8MM	16	22
10MM	31	40
12MM	54	70
14MM	89	117
16MM	161	230
18MM	222	318

Reference your vehicle owner's manual for manufacturer's towing specifications.



WARNING

Failure to read and follow these instructions could result in separation of the towed vehicle from the tow bar, causing property damage, loss of towed vehicle, personal injury or death.

BX1146

2021-22 Jeep Grand Cherokee L (No Overland) (Includes ACC & Shutters) Installation Instructions

Instruction Notes: The fascia and windshield washer fluid reservoir are removed and reinstalled for the baseplate installation. Some drilling and trimming is required.

Place all components that are removed on a flat, sturdy surface. All items will be reinstalled unless otherwise noted after the baseplate is installed.

The dimensional variations between otherwise identical vehicles can be considerable. While the baseplate was designed for easy installation, it may be necessary to tailor the baseplate slightly to compensate for vehicle manufacturer's tolerances.

The BX8848 Tail Light Wiring Kit is recommended for this vehicle.

NOTICE

- Handling of some cosmetic parts when installing this product may require the use of protective covers, rags, specialty tools, etc. to prevent damage.
- When using power drills be aware of the dangers of torque and drill bit length.
- When using a reciprocating saw be aware of objects behind the cutting surface.
- Use a good quality paint to spray cut edges of frame to prevent rusting.
- Be sure that **ALL** electrical connections are plugged in and accessories are functioning properly before reinstalling the fascia.
- The baseplate is computer tested to your vehicle's GVWR, exceeding this weight will void the manufacturer's warranty.
- Be sure to use a sufficient amount of Loctite® Red on all bolt threads before tightening. Tighten all bolts according to the torque chart provided unless specified.
- Dealer or installer be certain the user receives these instruction sheets.
- If the baseplate is in an accident, it must be replaced. **DO NOT** use it again! An accident can cause unseen damage and using it again could result in more damage or serious injury. **DO NOT** use the baseplate if it is damaged or missing parts.

BX1146

2021-22 Jeep Grand Cherokee L (No Overland) (Includes ACC & Shutters) Installation Instructions

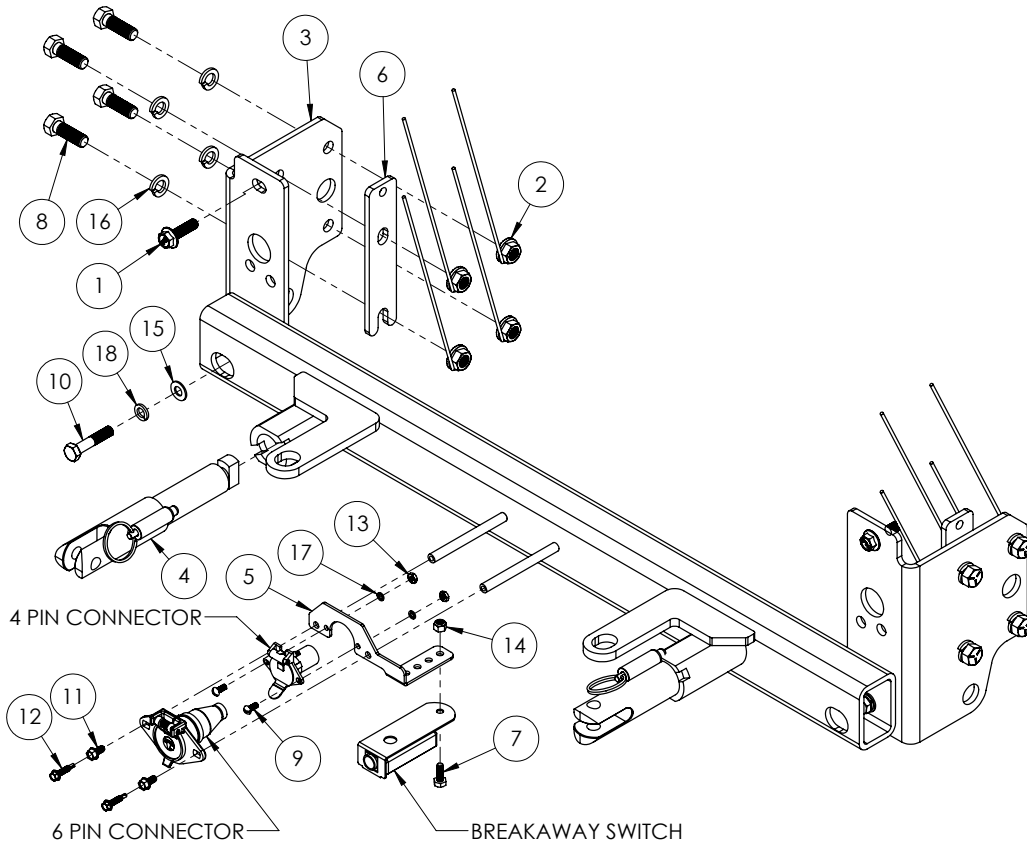

- | Tools Required | |
|----------------------|--|
| Large Vise Grip | |
| Flat Screwdriver | |
| Utility Knife | |
| Phillips Screwdriver | |
| Torque Wrench | |
| Drill | |
| Tape Measure | |
| Loctite® RED | |
| 3/8" Drill Bit | |
| 10MM Socket | |
| 9/16" Socket | |
| 9/16" Wrench | |

Item No.	Part No.	Description	Qty.
1.....	Existing.....	10MM x 35MM Lg. Flanged Bolt	2
2.....	61-4029.....	1/2"-13 Whiz Plate w/ 10" Wire.....	8
3.....	61-8515.....	BX1146 Baseplate.....	1
4.....	62-3469.....	Attachment Tab Assembly with Hole	2
5.....	101-10408.....	Electrical Bracket w/ Breakaway Switch Mount, Short....	1
6.....	101-10731.....	Spacer Plate.....	2
7.....	201-0050.....	1/4"-20 x 3/4" Hex Head Bolt, Grade 5, ZP	1
8.....	201-0051.....	1/2"-13 x 1-1/2" Hex Head Bolt, Grade 5, ZP	8
9.....	201-0192.....	#10-32 1/2" Round Slotted Head Screw.....	2
10.....	201-0428.....	10MM-1.5 x 50MM Hex Head Bolt, Grade 8.8, ZP.....	2
11.....	201-0553.....	1/4"-20 x 1/2" Hex Washer Head Type F TCS, ZP	2
12.....	201-0979.....	#12-14 x 1" Self Drilling Screw, ZP.....	2
13.....	202-0047.....	#10-32 Hex Nut	2
14.....	202-0102.....	1/4"-20 Hex Nylon Nut, ZP	1
15.....	203-0003.....	3/8" Flat Washer, ZP.....	2
16.....	203-0012.....	1/2" Lock Washer, ZP	8
17.....	203-0054.....	#10 Lock Washer, ZP	2
18.....	203-0104.....	10MM Lock Washer, ZP	2
19.....	226-0049(not shown).....	Class IV Safety Cables.....	2
20.....	229-0512(not shown).....	1/2" Quicklink, ZP	2
21.....	290-0437(not shown).....	Black Cap Plug Receiver.....	2

Important:

Use only genuine factory replacement parts on your baseplate. Do **NOT** substitute homemade or non-typical parts. If a bolt is lost or in need of replacement, for your safety and the preservation of your baseplate, be sure to use a replacement bolt of the same grade (In most cases it will be Grade 5, please reference the parts list above). Replacement parts may be ordered through your nearest Blue Ox® Dealer or Distributor. Failing to follow and/or altering these installation instructions in either installation or required equipment will void the manufacturer's warranty. Towing behind a non-motorized vehicle will void the warranty.

2021-22 Jeep Grand Cherokee L (No Overland) (Includes ACC & Shutters)
Installation Instructions

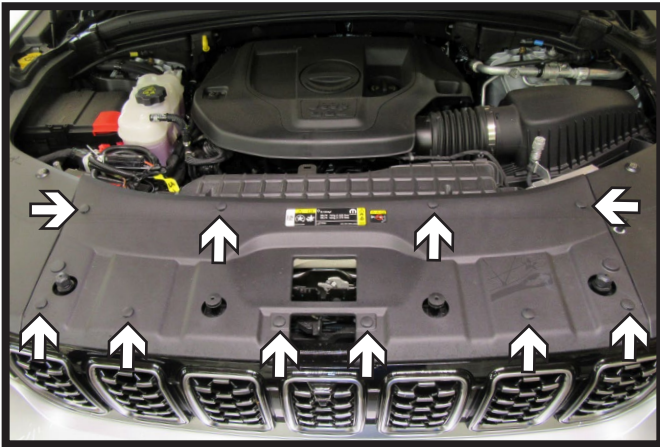

1. Remove the ten (10) push pins from the top of the fascia cover. Remove fascia cover and set aside to be reinstalled later.

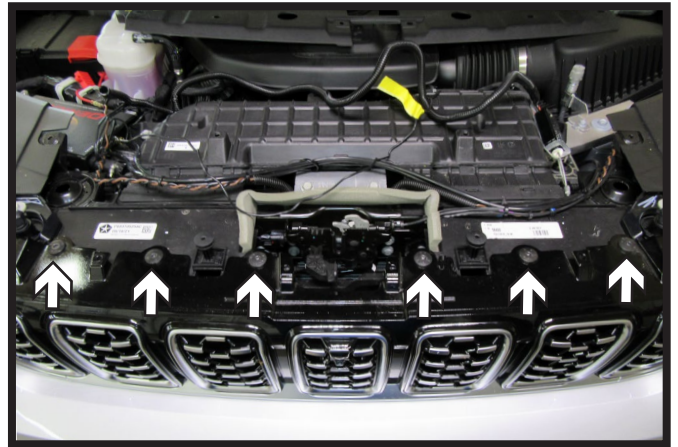

2. Using a T40 Torx, remove the six (6) bolts from the top of the fascia.

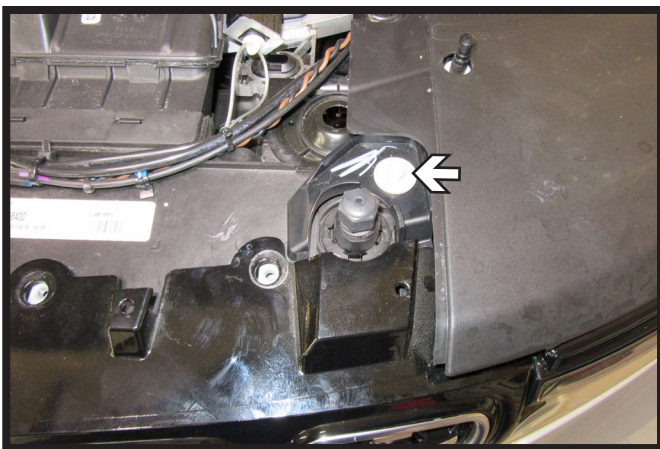

3. Using a 10MM socket, remove the one (1) bolt from the top of the fascia. Do this on both sides of the vehicle.

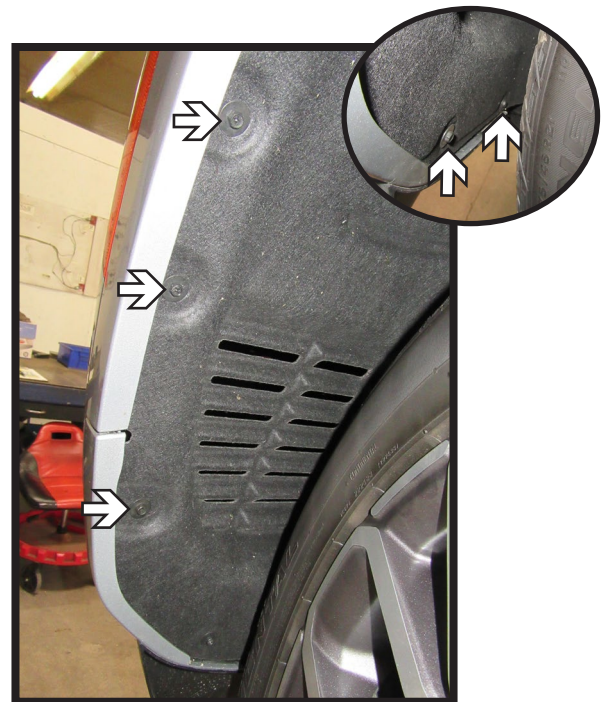

4. Using an 8MM socket, remove the five (5) bolts from along the edge of wheel well. Do this on both sides of the vehicle.

BX1146

2021-22 Jeep Grand Cherokee L (No Overland) (Includes ACC & Shutters) Installation Instructions



5. Pull back the wheel well liner. Using a 10MM socket, remove the one (1) bolt from the fascia joint. Do this on both sides of the vehicle.

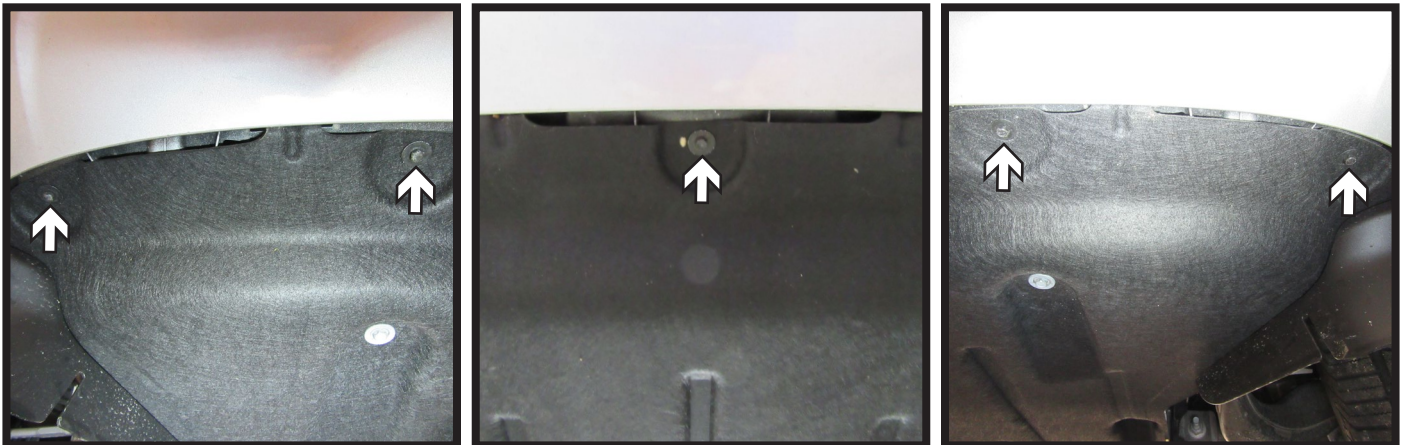

6. Using an 8MM socket, remove the five (5) bolts from the belly pan.

BX1146

2021-22 Jeep Grand Cherokee L (No Overland) (Includes ACC & Shutters) Installation Instructions

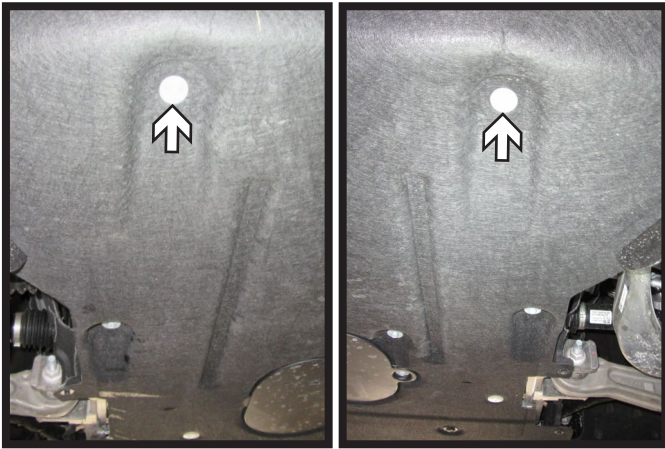

7. Using a 10MM socket, remove the two (2) bolts, one (1) on each side, from the belly pan.



8. Using an 8MM socket, remove the one (1) bolt on the underside of the fascia in front of the tire. Do this on both sides of the vehicle.

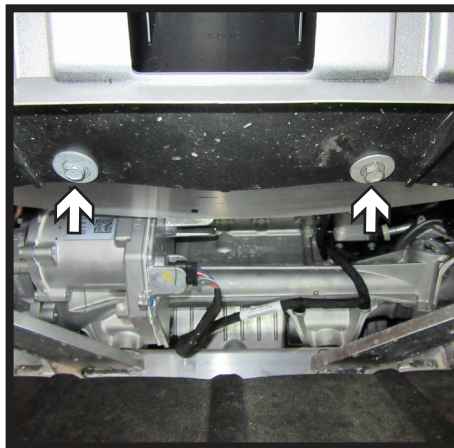
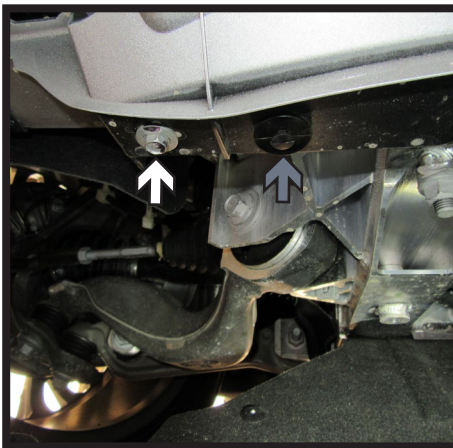

9. Let belly pan hang. Using a 10MM socket, remove the four (4) bolts (white) from the underside of the fascia. Then remove the two (2) push pins (gray).

2021-22 Jeep Grand Cherokee L (No Overland) (Includes ACC & Shutters)
Installation Instructions



10. Unplug two (2) electrical connections (white) on the passenger side of the vehicle. Then disconnect windshield washer fluid line (gray).

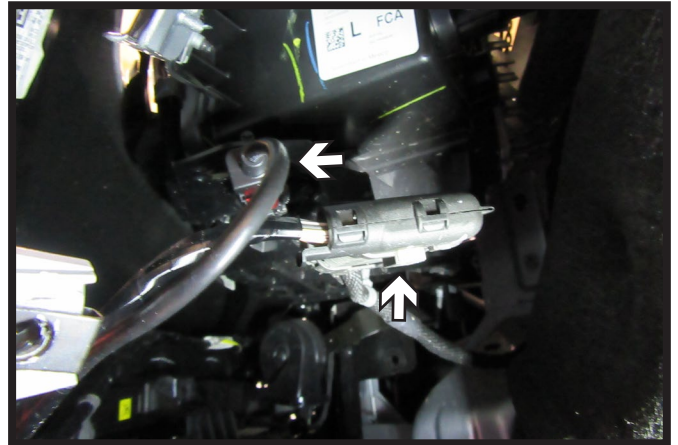

11. Unplug two (2) electrical connections on the driver side of the vehicle. Remove fascia and set aside to be reinstalled later.



12. Using a 16MM socket, remove the two (2) bolts (white) from the bumper. Then using a 10MM socket, remove the one (1) nut (gray). Do this on both sides of the vehicle. Remove bumper and set aside. It will not be reinstalled later. As the bumper is removed, remove two (2) push pins from shroud piece around bumper (inset). Remove shroud piece.



13. Using a reciprocating saw, trim the frame as shown. Do this on both sides of the vehicle.

BX1146

2021-22 Jeep Grand Cherokee L (No Overland) (Includes ACC & Shutters) Installation Instructions

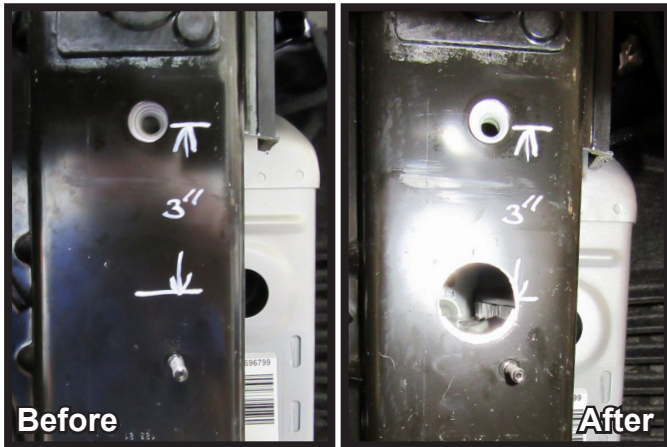

14. Measure 3" from the center of the top hole down. Using a 1-1/4" hole saw, drill hole centering hole with existing holes on the frame and the bottom of the 3" measurement. Do this on both sides of the vehicle.



15. Using a reciprocating saw, trim the plastic shroud as indicated. Do this on both sides of the vehicle.

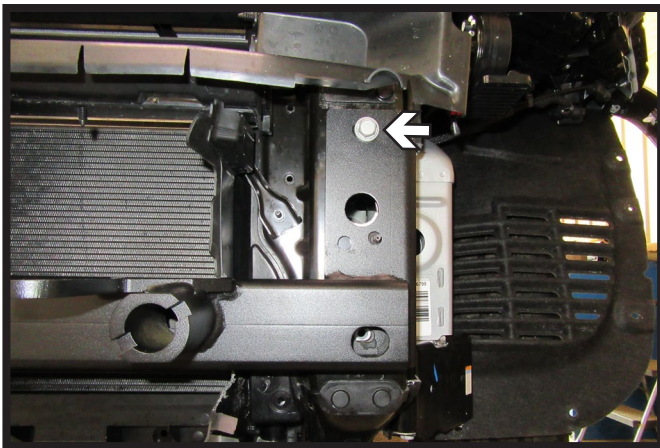

16. Hold baseplate into place on the vehicle frame and start the existing bolt in the top hole. Do this on both sides of the vehicle. Note: Ensure all holes line up before tightening bolts.

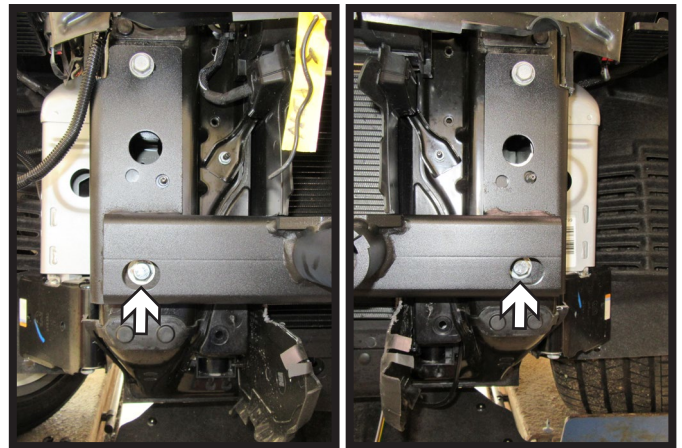

17. Install existing bolt into bottom hole on each side of the vehicle.

**** Use Loctite® Red on all bolt threads and tighten all bolts to the appropriate torque. ****

BX1146

2021-22 Jeep Grand Cherokee L (No Overland) (Includes ACC & Shutters) Installation Instructions

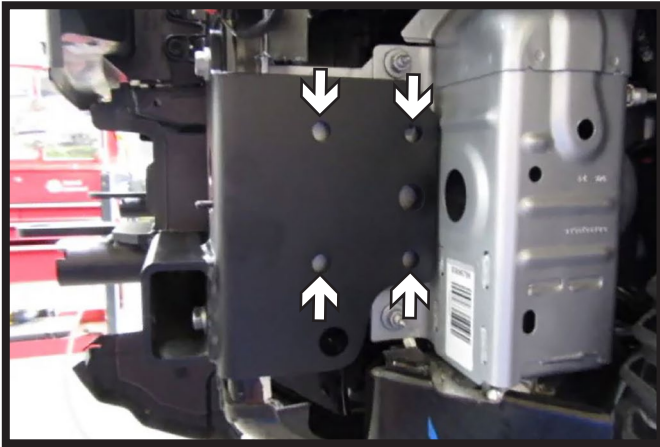

18. Using 1/2" drill bit. Drill the four (4) holes on the side of the frame using the baseplate as a template. Do this on both sides of the vehicle.

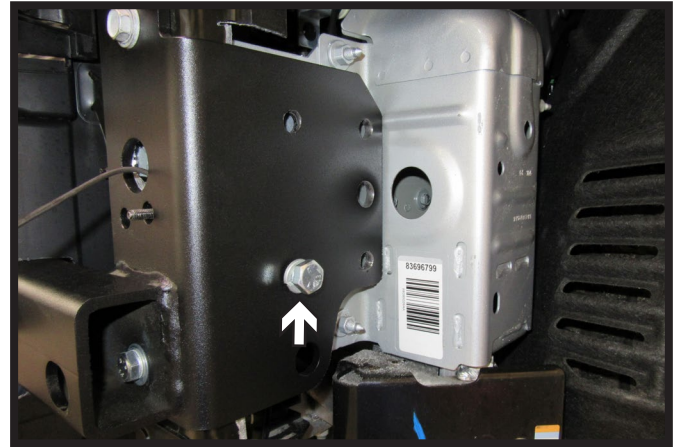

19. Start a 1/2" x 1-1/2" bolt with lock washer and whiz nut in the bottom front hole. Leave loose at this time. Do this on both sides of the vehicle.

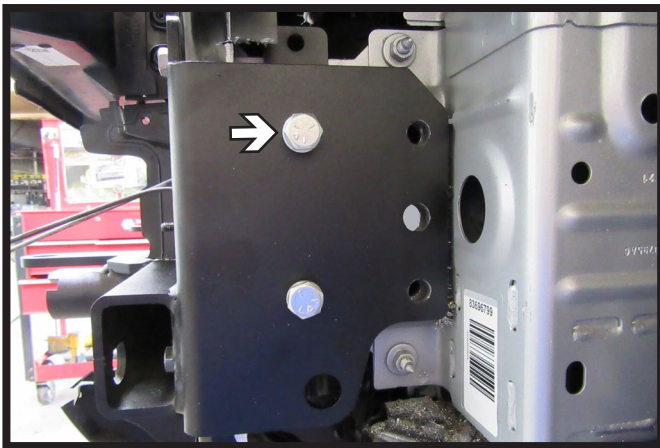

20. Insert spacer plate at top of baseplate between the frame and baseplate with the slotted end facing downward. Once spacer plate is in position insert 1/2" x 1-1/2" bolt with lock washer and whiz nut into top front hole. Do this on both sides of the vehicle.

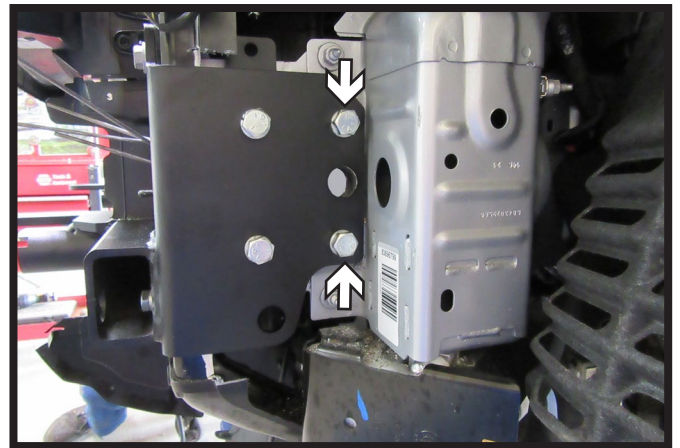

21. Install two (2) 1/2" x 1-1/2" bolts with lock washers and whiz nuts back holes. Do this on both sides of the vehicle. Tighten all bolts at this time.

**** Use Loctite® Red on all bolt threads and tighten all bolts to the appropriate torque. ****

BX1146

2021-22 Jeep Grand Cherokee L (No Overland) (Includes ACC & Shutters) Installation Instructions

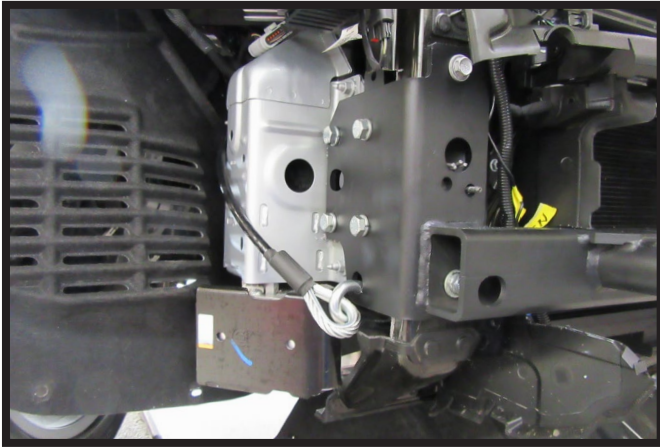

22. Attach the permanent baseplate safety cables to the provided convenience link on the baseplate. The photo above shows the recommended installation of the cables to frame of vehicle. Additional options may interfere with suggested mounting; in this case, secure the cables to a solid piece of the frame as described in the General Information sheet. Be sure the safety cables do not rub against any hoses or moving parts. Do this on **BOTH** sides of the vehicle.



23. Hold the fascia as close to its original position, mark and trim the fascia around the convenience links and attachment tabs. Reinstall the fascia, fascia cover, and belly pan. Reconnect all electrical connections and windshield washer fluid line.

General Information

1. It is crucial to register your product(s) so that you may be alerted of product offerings, updates, upgrades, maintenance and safety bulletins, and/or recalls.
2. **It is the owner's responsibility to inspect all towing equipment for cracked welds, missing or worn parts and loose bolts before each towing trip.** Be sure to use Loctite® Red on all bolts and tighten to the recommended specifications.
3. **It is the owner's responsibility to hook up all towing equipment per manufacturer's instructions/ recommendations.**
4. Remove the attachment tabs when not in use (if applicable).

Notice To Baseplate Installer

1. It is YOUR responsibility to watch for:

- Oil cooler and air conditioner lines
- Electrical wires and hoses
- Missing parts or attaching points on the frame

** If the baseplate is improperly installed and is against a wire or hose, it could cause fluid leaks or electrical shorts some time after the actual baseplate installation.

Permanent Baseplate Safety Cable Installation

Permanent baseplate safety cables are strongly recommended when towing a vehicle with a tow bar. The principle function of the permanent baseplate safety cables is to prevent the towed vehicle from breaking loose in the event the connection between the frame of the towed vehicle and the baseplate fails or becomes disconnected. The cables must be connected from the baseplate to the frame rail or cross member of the vehicle's frame. The illustrations below show the possible arrangements recommended by Blue Ox®. Each permanent baseplate safety cable must have an adequate weight rating for the towing system. The weight rating of the two (2) cables together will not qualify.

Do not mount the permanent baseplate safety cables against wires, hoses or brake lines.

These permanent baseplate safety cables should remain installed as long as the baseplate is installed on the vehicle. Permanent baseplate safety cables are to be used in conjunction with, and NOT a replacement for legally required safety cables attaching the towed vehicle to the towing vehicle.

Option #1

(Baseplates with Convenience Link Tabs)

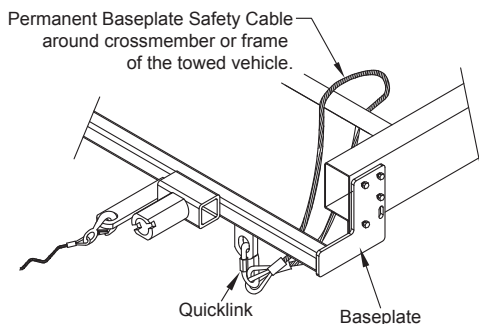

Option #2

(Baseplates with out Convenience Link Tabs)

