



BX2680

2019-2022 Lincoln Nautilus (2.7L Only) (Includes ACC, Shutters, & Turbo) Installation Instructions

Attachment Tab Height: 17"

Attachment Tab Width: 30"

Serial Number

Please read BOTH these Installation Instructions and the General Information sheet prior to installing or operating this equipment.

1. Blue Ox® towing products and accessories are intended to be installed by Blue Ox® Dealers who are familiar with our products and have the equipment and knowledge necessary to do "fit work".
2. Many Blue Ox® baseplates are designed to use existing holes and hardware to mount the baseplate to the towed vehicle. Even though bolts are there, do not assume they are adequate for baseplate mounting. Always use the hardware supplied in the hardware kit and existing hardware as specified in the installation instructions.

Bolt Torque Specifications

Torque in Foot-Pounds for Inch Bolts

Bolt Size	Grade 5	Grade 8
1/4"	10	14
5/16"	19	29
3/8"	33	47
7/16"	54	78
1/2"	78	119
5/8"	154	230
3/4"	257	380



Reference your vehicle owner's manual for manufacturer's towing specifications.

Bolt Torque Specifications

Torque in Foot-Pounds for Metric Bolts

Bolt Size	Grade 8.8	Grade 10.9
6MM	6	8
8MM	16	22
10MM	31	40
12MM	54	70
14MM	89	117
16MM	161	230
18MM	222	318



WARNING

Failure to read and follow these instructions could result in separation of the towed vehicle from the tow bar, causing property damage, loss of towed vehicle, personal injury or death.

BX2680

2019-2022 Lincoln Nautilus (2.7L Only) (Includes ACC, Shutters, & Turbo) Installation Instructions

Instruction Notes: The fascia cover, fascia and belly pan are removed and reinstalled for the baseplate installation. Some drilling and trimming is required.

Place all components that are removed on a flat, sturdy surface. All items will be reinstalled unless otherwise noted after the baseplate is installed.

The dimensional variations between otherwise identical vehicles can be considerable. While the baseplate was designed for easy installation, it may be necessary to tailor the baseplate slightly to compensate for vehicle manufacturer's tolerances.

A Light Bar is recommended for this vehicle.

NOTICE

- Handling of some cosmetic parts when installing this product may require the use of protective covers, rags, specialty tools, etc. to prevent damage.
- When using power drills be aware of the dangers of torque and drill bit length.
- When using a reciprocating saw be aware of objects behind the cutting surface.
- Use a good quality paint to spray cut edges of frame to prevent rusting.
- Be sure that **ALL** electrical connections are plugged in and accessories are functioning properly before reinstalling the fascia.
- The baseplate is computer tested to your vehicle's GVWR, exceeding this weight will void the manufacturer's warranty.
- Be sure to use a sufficient amount of Loctite® Red on all bolt threads before tightening. Tighten all bolts according to the torque chart provided unless specified.
- Dealer or installer be certain the user receives these instruction sheets.
- If the baseplate is in an accident, it must be replaced. **DO NOT** use it again! An accident can cause unseen damage and using it again could result in more damage or serious injury. **DO NOT** use the baseplate if it is damaged or missing parts.

BX2680

2019-2022 Lincoln Nautilus (2.7L Only) (Includes ACC, Shutters, & Turbo) Installation Instructions

Tools Required

Large Vise Grip
Flat Screwdriver
Utility Knife
Torque Wrench
Drill
Loctite® RED
3/8" Drill Bit
1/2" Drill Bit
1-1/4" Hole Saw
5/16" Nut Driver
5.5MM Socket
7MM Socket
8MM Socket
10MM Socket
9/16" Socket
9/16" Wrench
3/4" Socket
3/4" Wrench

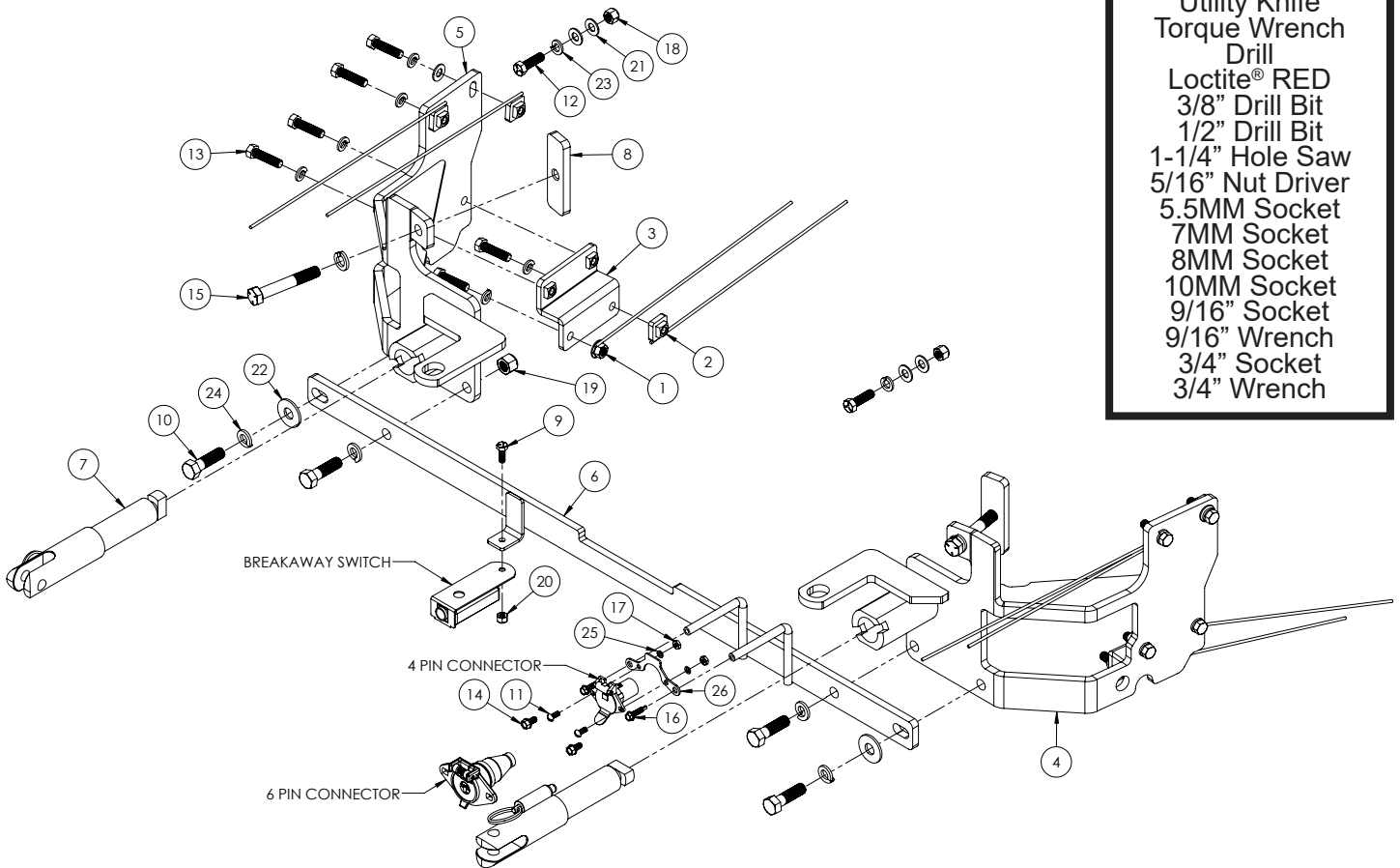

BX2680

2019-2022 Lincoln Nautilus (2.7L Only) (Includes ACC, Shutters, & Turbo) Installation Instructions

Item No.	Part No.	Description	Qty.
1	61-4978	3/8"-16 Whiz Nut w/ 14" Wire	2
2	61-5208	3/8" Nut Plate w/ 14" Wire	6
3	61-7681	Support Plate	2
4	61-8217	BX2680 Baseplate, DS	1
5	61-8218	BX2680 Baseplate, PS	1
6	61-8219	BX2680 Baseplate, Center	1
7	62-3469	Attachment Tab Assembly with Hole	2
8	102-7749	3/8" x 1-1/4" x 4" Flat with 1/2" Tapped Hole	2
9	201-0050	1/4"-20 x 3/4" Hex Head Bolt, Grade 5, ZP	1
10	201-0068	1/2"-13 x 1-3/4" Hex Head Bolt, Grade 5, ZP	4
11	201-0192	#10-32 1/2" Round Slotted Head Screw	2
12	201-0368	3/8"-16 x 1-1/4" Hex Head Bolt, Grade 5, ZP	2
13	201-0440	3/8"-16 x 1-1/2" Hex Head Bolt, Grade 5, ZP	12
14	201-0553	1/4"-20 x 1/2" Hex Washer Head, Type F TCS, ZP	2
15	201-0799	1/2"-13 x 3-1/4" Hex Head Bolt, Grad 5, ZP	2
16	201-0979	#12-14 x 1" Self Drilling Screw, ZP	2
17	202-0047	#10-32 Hex Nut	2
18	202-0090	3/8"-16 Hex Nylon Insert Lock Nut, ZP	2
19	202-0094	1/2"-13 Hex Nylon Insert Lock Nut, ZP	4
20	202-0102	1/4"-20 Hex Nylon Nut, ZP	1
21	203-0003	3/8" Flat Washer, ZP	6
22	203-0005	1/2" Flat Washer	2
23	203-0010	3/8" Lock Washer, ZP	14
24	203-0012	1/2" Lock Washer, ZP	6
25	203-0054	#10 Lock Washer, ZP	2
26	299-0685	4-Way Bracket	1
27	226-0049(not shown)	Class IV Safety Cables	2
28	229-0512(not shown)	1/2" Quicklink, ZP	2
28	290-0275(not shown)	8" Nylon Cable Tie	2
30	290-0437(not shown)	Black Cap Plug Receiver	2

Important:

Use only genuine factory replacement parts on your baseplate. Do **NOT** substitute homemade or non-typical parts. If a bolt is lost or in need of replacement, for your safety and the preservation of your baseplate, be sure to use a replacement bolt of the same grade (In most cases it will be Grade 5, please reference the parts list above). Replacement parts may be ordered through your nearest Blue Ox® Dealer or Distributor. Failing to follow and/or altering these installation instructions in either installation or required equipment will void the manufacturer's warranty. Towing behind a non-motorized vehicle will void the warranty.

BX2680

2019-2022 Lincoln Nautilus (2.7L Only) (Includes ACC, Shuttters, & Turbo) Installation Instructions

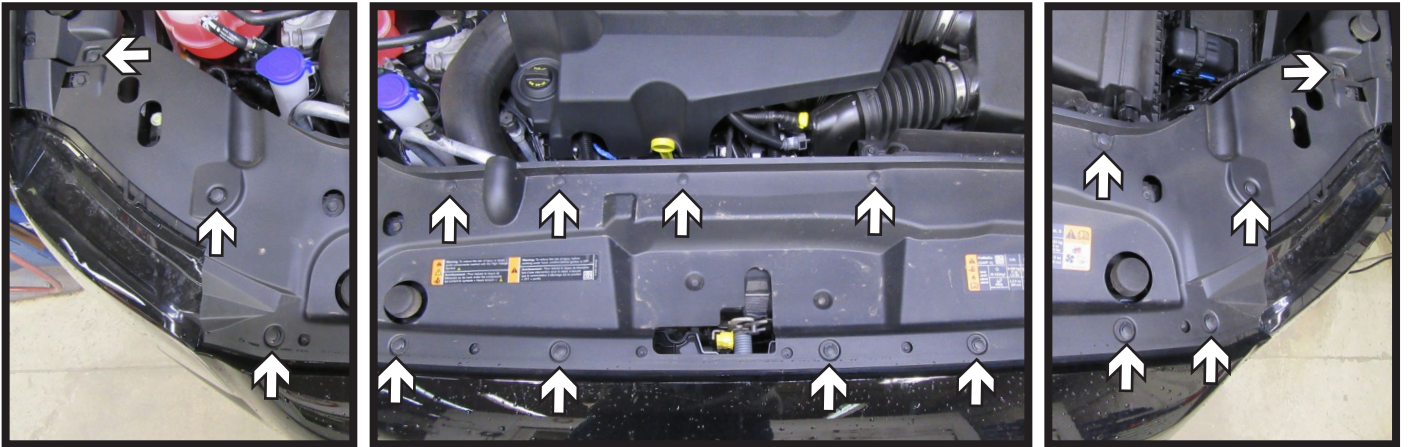

1. Remove the sixteen (16) push pins from the fascia cover. Set cover aside to be reinstalled later.

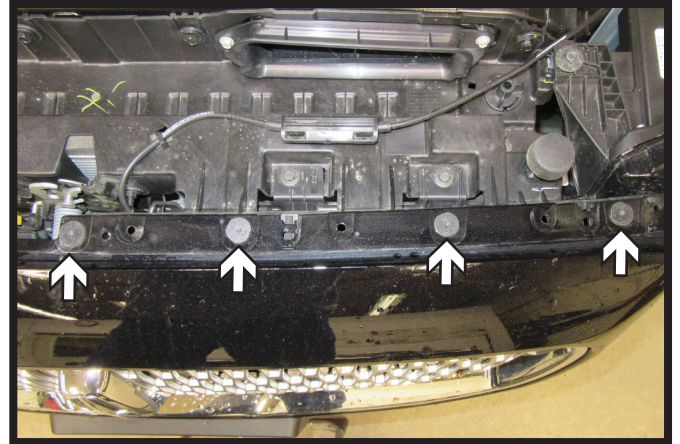
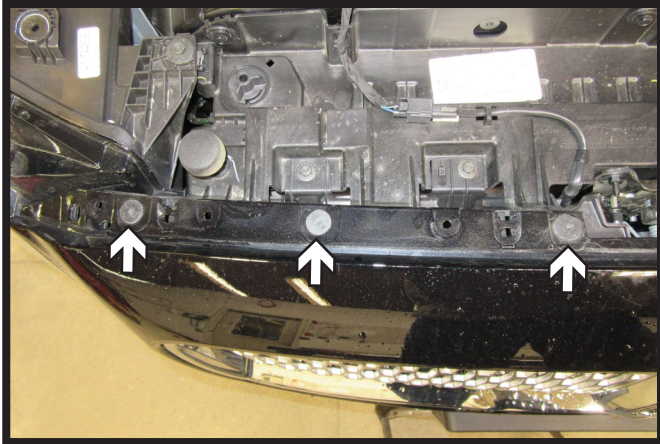

2. Using a T20 Torx, remove the seven (7) screws from the top of the fascia. There are four (4) on the driver side and three (3) on the passenger side.

BX2680

2019-2022 Lincoln Nautilus (2.7L Only) (Includes ACC, Shutters, & Turbo)
Installation Instructions



3. Remove the five (5) push pins from the edge of the wheel well. Do this on both sides of the vehicle.

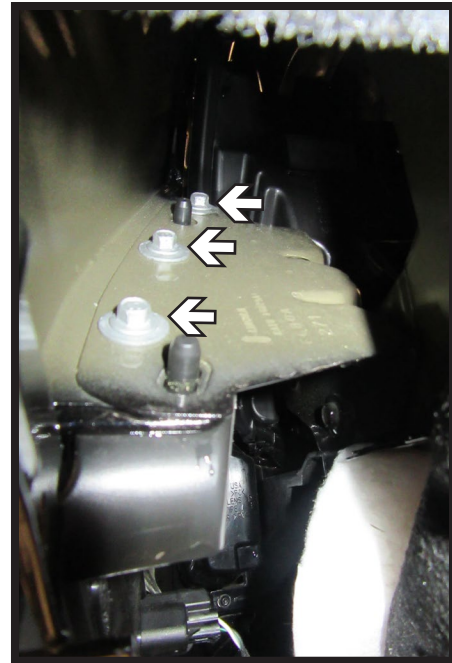

4. Pull back the wheel well liner. Using an 8MM socket, remove the three (3) bolts from the wheel well joint. Do this on both sides of the vehicle.



5. Using a 5.5MM socket, remove the twelve (12) bolts from the belly pan. There are six (6) on each side.



2019-2022 Lincoln Nautilus (2.7L Only) (Includes ACC, Shutters, & Turbo)
Installation Instructions

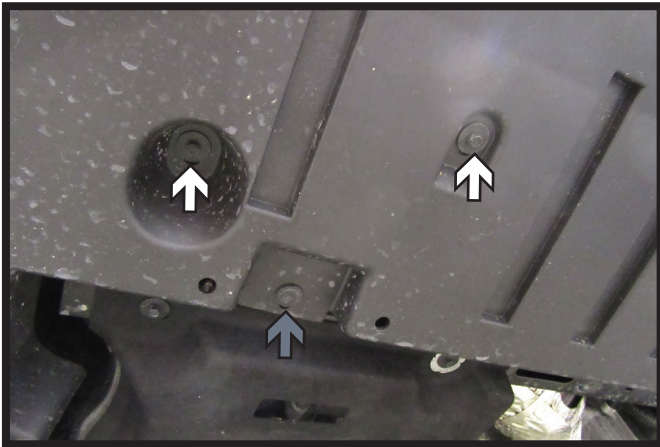

6. Using a 7MM socket, remove the two (2) bolts (white) and one (1) push pin (gray) from the belly pan. Do this on both sides of the vehicle.

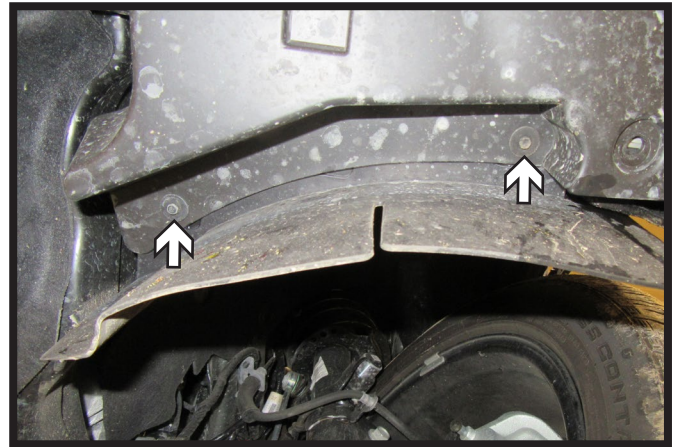

7. Using a 5.5MM socket, remove the two (2) bolts from in front of the tire on the underside of the vehicle. Do this on both sides of the vehicle. Remove belly pan and set aside to be reinstalled later.



8. Remove the three (3) push pins from the underside of the vehicle. Remove the fascia and set aside to be reinstalled later.

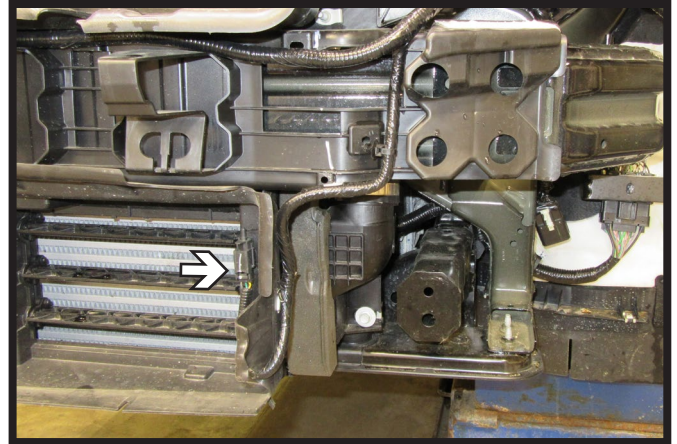

9. Unsnap the temperature sensor wire loom and place out of the way. It will be remounted later.

BX2680

2019-2022 Lincoln Nautilus (2.7L Only) (Includes ACC, Shutters, & Turbo) Installation Instructions

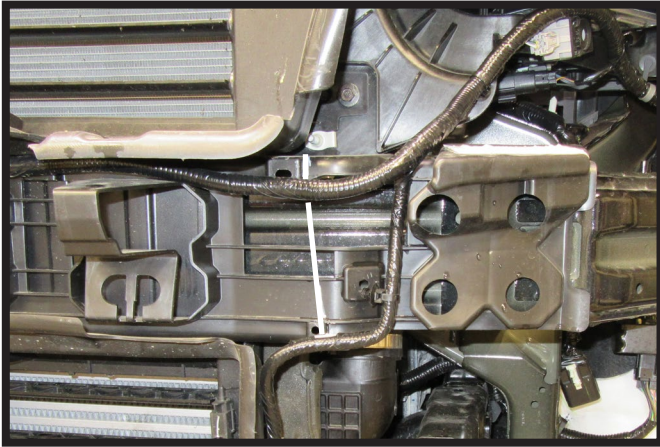

10. Using a reciprocating saw, trim the plastic piece as indicated. Do this on both sides of the vehicle.

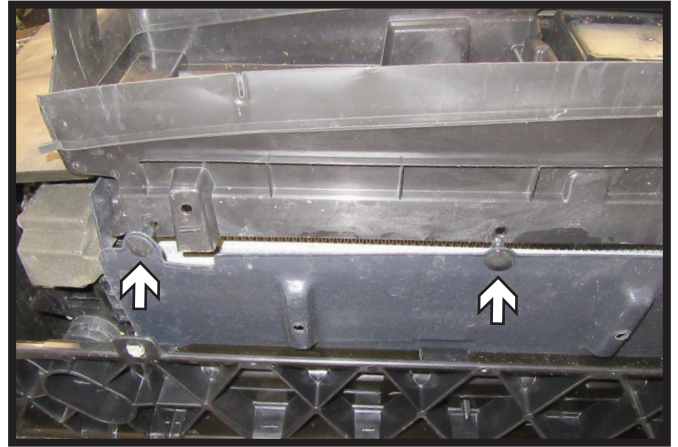

11. Remove the four (4) push pins from along the underside of the shutter housing. There are two (2) on each side. Remove plastic piece, it will not be reinstalled later.

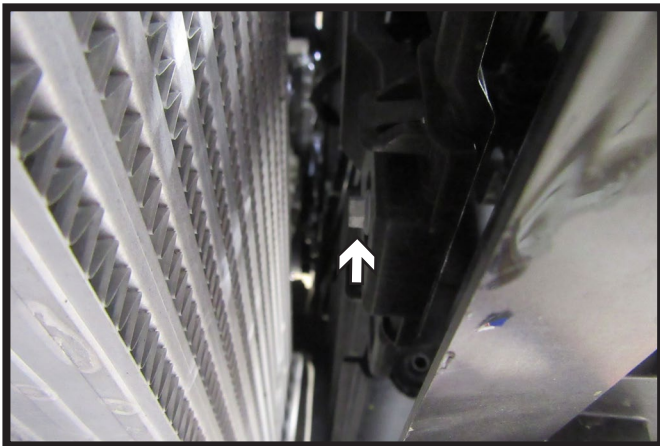

12. Using a 7MM socket, on the backside of the shutters, remove the one (1) bolt from the shutter housing.

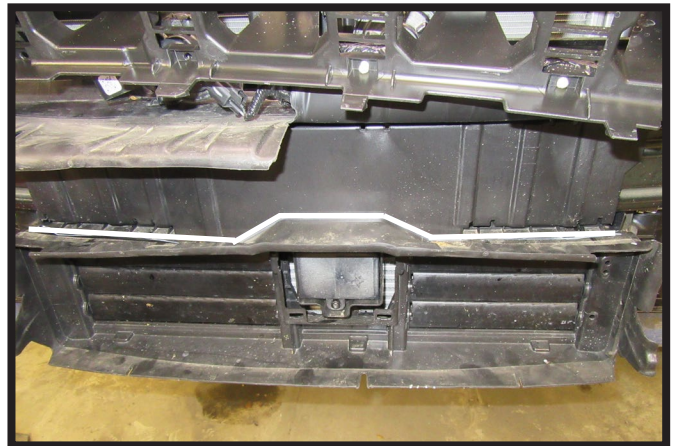

13. Unsnap the plastic piece above the shutter housing. Hold piece out of the way and mark the top of the shutter housing as indicated. Then cut shutter housing as indicate, remove shutters, and set aside. They will not be reinstalled later.

BX2680

2019-2022 Lincoln Nautilus (2.7L Only) (Includes ACC, Shutters, & Turbo)
Installation Instructions

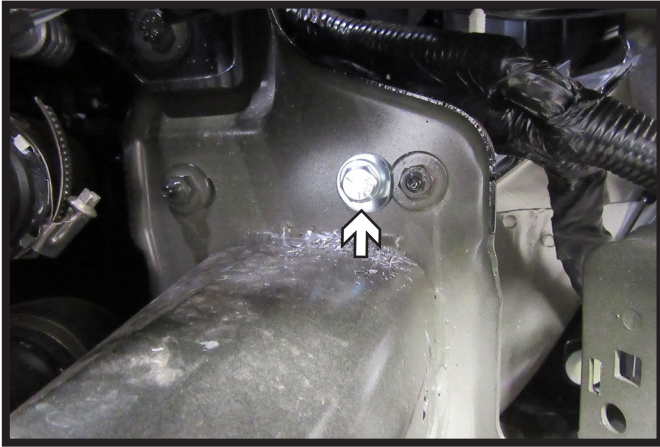

14. Using a 3/8" drill bit, drill one (1) hole as indicated on both sides of the vehicle then install the provided 3/8" hardware.

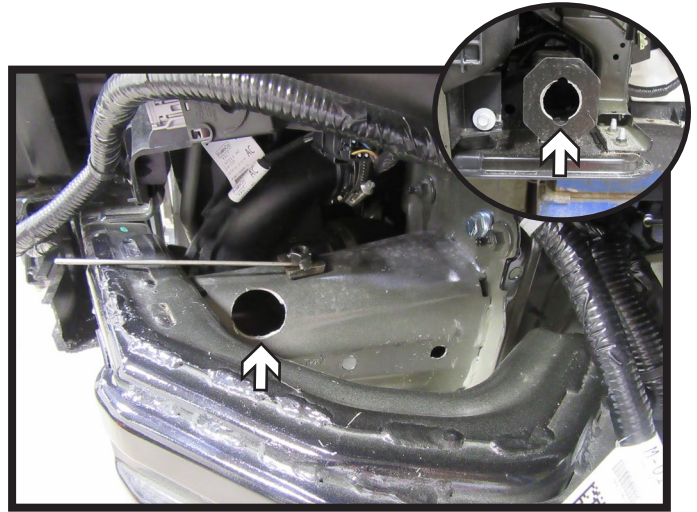

15. Using a 1-1/4" hole saw, drill access holes in the side of the frame as shown and in the face of the lower support (inset). Do this on both sides of the vehicle.

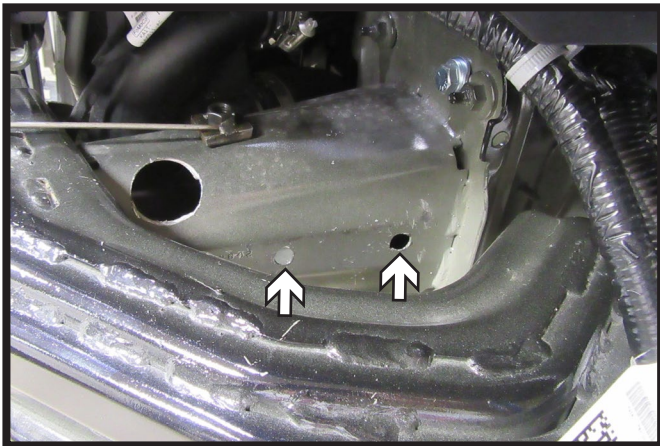

16. Using a 3/8" drill bit, ream out the two (2) existing holes on the side of the frame. Do this on both sides of the vehicle.



17. Attach the Z bracket to the back of each side plate using two (2) 3/8" bolts and hardware.

**** Use Loctite® Red on all bolt threads and tighten all bolts to the appropriate torque. ****

BX2680

2019-2022 Lincoln Nautilus (2.7L Only) (Includes ACC, Shutters, & Turbo) Installation Instructions

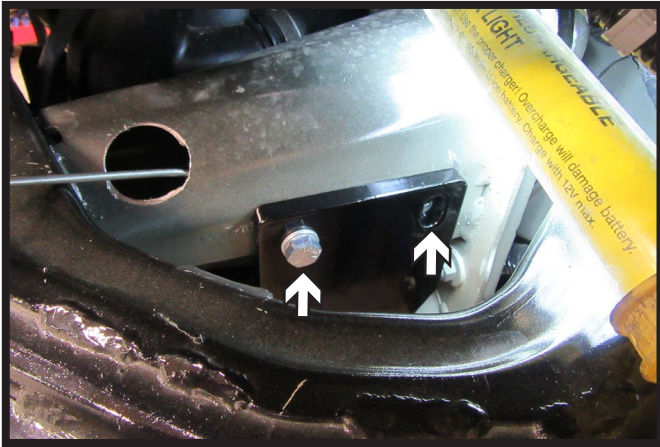

18. Install the baseplate onto the frame with the provided 3/8" hardware, making sure to not yet fully tighten the hardware. Do this on both sides of the vehicle.

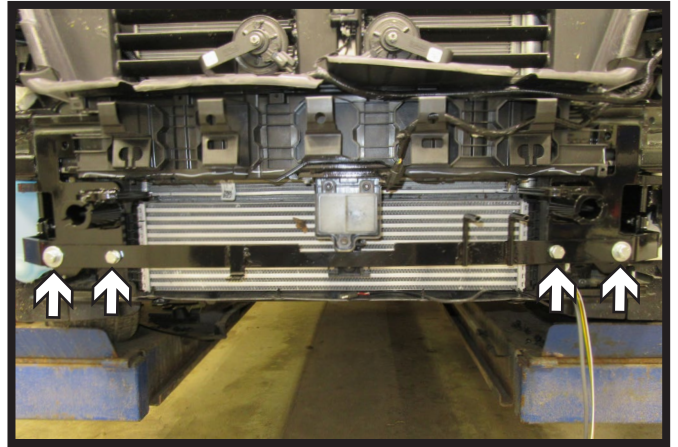

19. Install the cross-member on the front side of the side brackets with provided 1/2" hardware, making sure to not yet fully tighten the hardware. Then tighten the top two (2) bolts on both side plates followed by the bolts on the cross-member.
Note: Cross member may appear bowed once the bolts have been fully tightened.

**** Use Loctite® Red on all bolt threads and tighten all bolts to the appropriate torque. ****

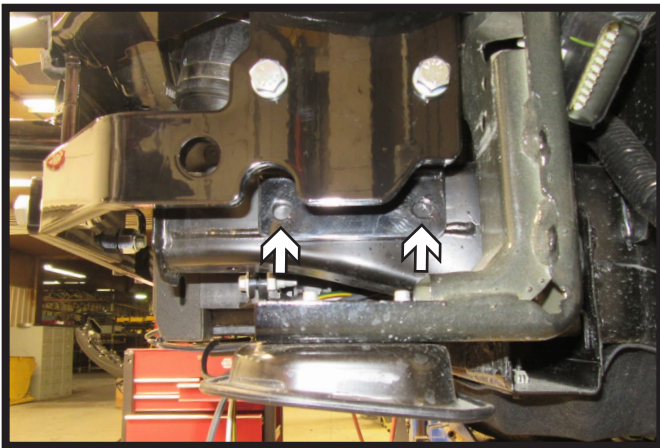

20. Using a 3/8" drill bit, drill out the bottom two (2) holes using the holes on the side plate as a guide. Install the provided 3/8" hardware. Do this on both sides of the vehicle.

**** Use Loctite® Red on all bolt threads and tighten all bolts to the appropriate torque. ****

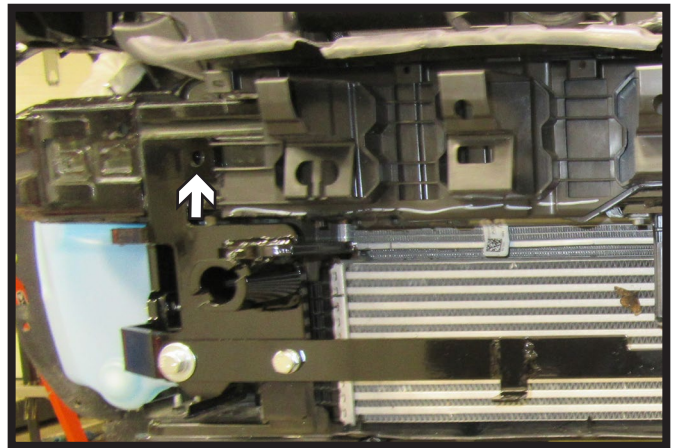

21. Using a 1/2" drill bit, drill one (1) hole as indicated on both sides of the vehicle.
Note: May need to start with a smaller drill bit and work up to the 1/2" drill bit.

BX2680

2019-2022 Lincoln Nautilus (2.7L Only) (Includes ACC, Shutters, & Turbo) Installation Instructions

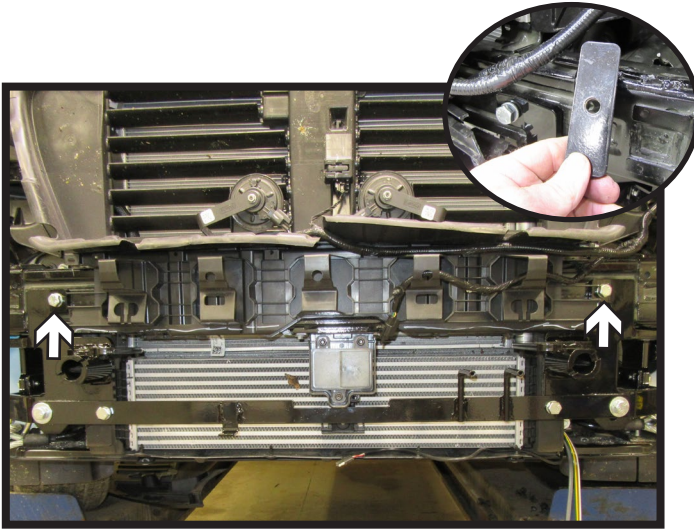

22. Install the 1/2" bolts with lock washer and a nut plate (inset) on the back side. Do this on both sides of the vehicle.

**** Use Loctite® Red on all bolt threads and tighten all bolts to the appropriate torque. ****

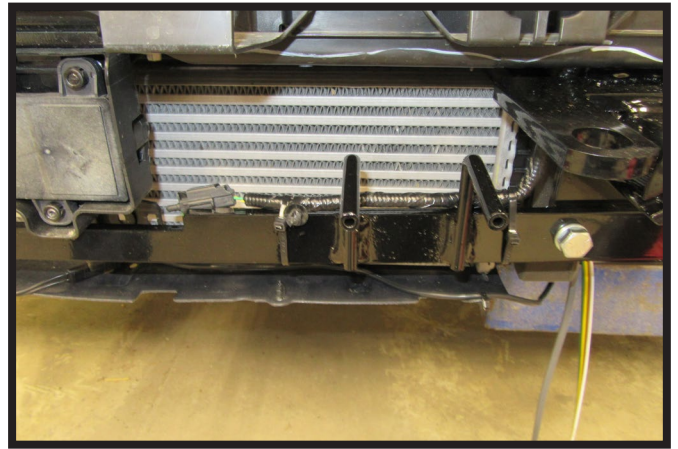

23. Using the provided zip ties, reattach the temperature sensor loom to the top of the baseplate cross member as shown.

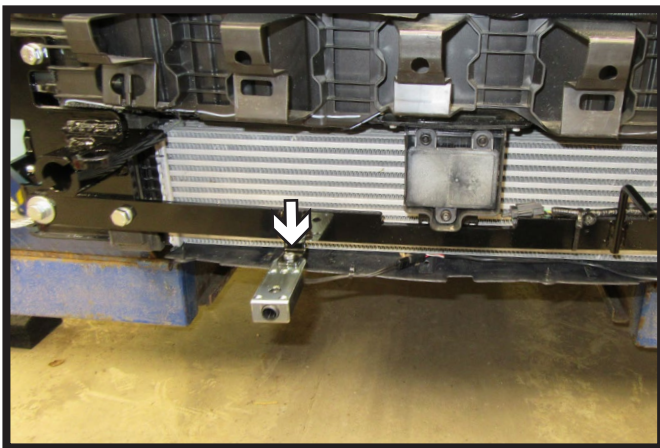

24. **Optional Breakaway:** Using the provided 1/4" hardware, attach the breakaway switch to the bracket on the baseplate as shown.

**** Use Loctite® Red on all bolt threads and tighten all bolts to the appropriate torque. ****



25. Attach the permanent baseplate safety cables to the provided convenience link on the baseplate. The photo above shows the recommended installation of the cables to frame of vehicle. Additional options may interfere with suggested mounting; in this case, secure the cables to a solid piece of the frame as described in the General Information sheet. Be sure the safety cables do not rub against any hoses or moving parts. Do this on **BOTH** sides of the vehicle.

BX2680

2019-2022 Lincoln Nautilus (2.7L Only) (Includes ACC, Shutters, & Turbo)
Installation Instructions



26. Hold the fascia as close to its original position, mark and trim the fascia around the convenience links and attachment tabs. Reinstall the fascia, belly pan, and fascia cover.

General Information

1. It is crucial to register your product(s) so that you may be alerted of product offerings, updates, upgrades, maintenance and safety bulletins, and/or recalls.
2. **It is the owner's responsibility to inspect all towing equipment for cracked welds, missing or worn parts and loose bolts before each towing trip.** Be sure to use Loctite® Red on all bolts and tighten to the recommended specifications.
3. **It is the owner's responsibility to hook up all towing equipment per manufacturer's instructions/ recommendations.**
4. Remove the attachment tabs when not in use (if applicable).

Notice To Baseplate Installer

1. It is YOUR responsibility to watch for:

- Oil cooler and air conditioner lines
- Electrical wires and hoses
- Missing parts or attaching points on the frame

** If the baseplate is improperly installed and is against a wire or hose, it could cause fluid leaks or electrical shorts some time after the actual baseplate installation.

Permanent Baseplate Safety Cable Installation

Permanent baseplate safety cables are strongly recommended when towing a vehicle with a tow bar. The principle function of the permanent baseplate safety cables is to prevent the towed vehicle from breaking loose in the event the connection between the frame of the towed vehicle and the baseplate fails or becomes disconnected. The cables must be connected from the baseplate to the frame rail or cross member of the vehicle's frame. The illustrations below show the possible arrangements recommended by Blue Ox®. Each permanent baseplate safety cable must have an adequate weight rating for the towing system. The weight rating of the two (2) cables together will not qualify.

Do not mount the permanent baseplate safety cables against wires, hoses or brake lines.

These permanent baseplate safety cables should remain installed as long as the baseplate is installed on the vehicle. Permanent baseplate safety cables are to be used in conjunction with, and NOT a replacement for legally required safety cables attaching the towed vehicle to the towing vehicle.

Option #1

(Baseplates with Convenience Link Tabs)

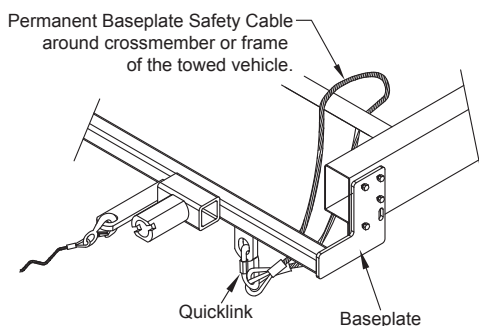

Option #2

(Baseplates with out Convenience Link Tabs)

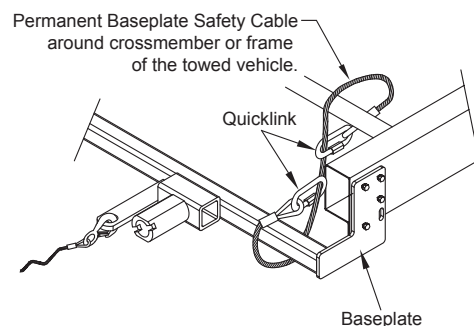

Discover other trailer hitches and towing on our website.