

BOYO[®]

VISION

USER MANUAL *VTC702R*



Before operating the Monitor, please read this manual thoroughly and retain it for future reference.

1.Attention

For your safety, please do not watch video or operate the monitor when driving.
Non-professionals please do not dismantle the machine. If the machine doesn't work, please consult customer services or send the machine to local maintenance departments.

Warning : Please install this machine in the place where laws and regulations allowed, our company take no responsibility for illegal product installation.

Notice: The machine may appear dark screen phenomenon when start up in the cold days, after power on and machine's temperature gradually rising up, the display screen would gradually return to normal.

2.Product function and application introduction

2-1. Product function

Wireless Monitor

- 7 inch digital panel
- Screen Ratio: 16: 9
- Resolution: 800*RGB*480
- 1 wireless video and audio input
- Adopt digital wireless encryption technology to code connection , have strong anti-interference capacity
- 14PCS 2.4G wireless signal frequency (2412MHz~2484MHz)
- Power Supply: DC12-24V
- Power Consumption: 6W
- Working temperature: 0℃~60℃
- Storage temperature: -10℃~70℃
- Size: 180*121*24mm

Wireless camera

- 1/4 CMOS OV7725 sensor
- 640*480 VGA resolution, 300 thousand pixel
- 100 degree viewing angle
- 10ft night viewing distance
- Built-in high sensitive microphone
- Waterproof level: IP66
- 2.4G wireless transmitting distance can reach 200ft in open area
- Power supply: DC12-24V
- Power Consumption: 6W
- Working temperature: 0℃~60℃
- Storage temperature: -10℃~70℃
- Size: 86.5mm*74.5mm*77mm

①

2-2. Product Application

This product adopted high resolution TFT color digital screen and 2.4G digital wireless technologies, which used embedded processor and embedded operating system, combined several latest technologies in the IT field, such as audio and video compression/decompression technology, special shockproof technology. It has no radiation, low power consumption, flicker-free and gorgeous vivid color and could be easily installed and widely used in various kinds of vehicles.

2-3. Product introduction

A. Front panel introduction

- Monitor Panel Introduction



1.2.4G antenna

2.Display screen

3.Metal LOGO plate

4.MENU: open or exit the menu

5.Brightness decrease: decrease the screen brightness value

6.Brightness increase: increase the screen brightness value

7.Power: Under power off state, press shortly to start up, press and hold to power off; under power on state, press shortly to close the display screen, press and hold to power off

8.Volume decrease: decrease the volume

9.Volume increase: increase the volume

10.MODE: up, down, left, right rotation

11.Remote control window

②

• Camera Introduction

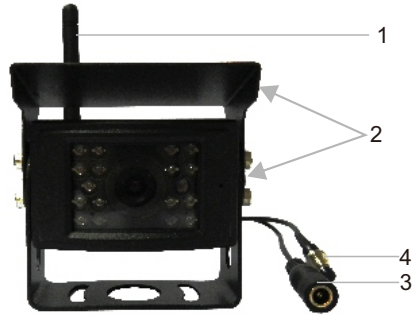

- 1. 1.2.4G antenna
- 2. U shaped bracket and sun shade
- 3. Power cable: DC 12-24V input
- 4. Pairing button

B.Menu Setup Introduction

1. Pairing setting

Press the “MENU” key on the panel or remote control to open the menu interface; then press “ ” on the panel or “VIDEO” “MODE” on remote control to switch to the “Pairing” option; and then press “ ” on the panel or “LEFT” “RIGHT” on remote control, at the same time, hold the camera pairing button to pair. There will show “Pair OK” after 2-5 seconds if pair successfully, otherwise will show “Pair fail” and need to re-pair. Press “MENU” to exit current setting. Just as shown in the following pictures.



2. Camera brightness Setting

Press “ ” on the panel or “VIDEO” “MODE” on remote control to switch to “Brightness” option, and then press “ ” on the panel or “LEFT” “RIGHT” on remote control to enter into the camera brightness setting and press them again to adjust the specific parameters. Press “MENU” to confirm the adjusted parameter and press it again to exit the current setting. Just as shown in the following pictures.



3. Camera contrast Setting

Press “ ” on the panel or “VIDEO” “MODE” on remote control to switch to “Contrast” option, and then press “ ” on the panel or “LEFT” “RIGHT” on remote control to enter into the camera contrast setting and press them again to adjust the specific parameters. Press “MENU” to confirm the adjusted parameter and press it again to exit the current setting. Just as shown in the following pictures.



4. Camera Saturation Setting

Press “” on the panel or “VIDEO” “MODE” on remote control to switch to “Saturation” option, and then press “” on the panel or “LEFT” “RIGHT” on remote control to enter into the camera saturation setting and press them again to adjust the specific parameters. Press “MENU” to confirm the adjusted parameter and press it again to exit the current setting. Just as shown in the following pictures.



5. Language setting

Press “” on the panel or “VIDEO” “MODE” on remote control to switch to “Language” option, and then press “” on the panel or “LEFT” “RIGHT” on remote control to set the language to Chinese or English display. Press “MENU” to exit the current setting. Just as shown in the following pictures.



6. Rotation Setting

Press “” on the panel or “VIDEO” “MODE” on remote control to switch to “Rotation” option, and then press “” on the panel or “LEFT” “RIGHT” on remote control to enter into rotation setting, press them again to make the image up/down/left/right rotated. Press “MENU” to exit the current setting. Just as shown in the following pictures.



7. Reversing delay setting

Press “” on the panel or “VIDEO” “MODE” on remote control to switch to “Others” option, and then press “” on the panel or “LEFT” “RIGHT” on remote control to enter into “Others” selection and press “” on the panel or “VIDEO” “MODE” on remote control again to select the delay time, press “” on the panel or “LEFT” “RIGHT” on remote control to set it. The default value is 0 sec, closed. Press “MENU” to exit the current setting. Just as shown in the following pictures.

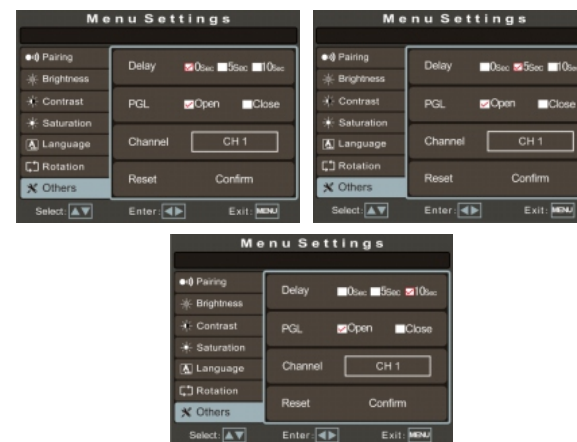

8. Parking guide line switch setting

Press “ ” on the panel or “VIDEO” “MODE” on remote control to switch to “Others” option, and then press “ ” on the panel or “LEFT” “RIGHT” on remote control to enter into “Others” selection and press “ ” on the panel or “VIDEO” “MODE” on remote control again to switch to the PGL selection, press “ ” on the panel or “LEFT” “RIGHT” on remote control to open or close it . The default state is closed. Press “MENU” to exit the current setting. Just as shown in the following pictures.

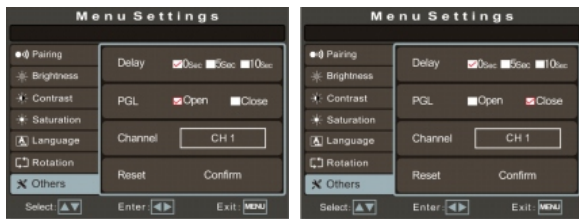

9. Wireless signal channel setting

Press “ ” on the panel or “VIDEO” “MODE” on remote control to switch to “Others” option, and then press “ ” on the panel or “LEFT” “RIGHT” on remote control to enter into “Others” selection. Press “ ” on the panel or “VIDEO” “MODE” on the remote again to switch to “Channel” selection. Press “ ” on the panel or “LEFT” “RIGHT” on remote control to set the wireless signal channel frequency. The default state is CH1 channel. There are 14PCS wireless signal channel optional (2412~2484MHZ). If there is several monitors work on the same frequency, may have signal unstable or image flicker problem, which could be improved by changing the frequency. Press “MENU” to exit the current setting. Just as shown in the following pictures.

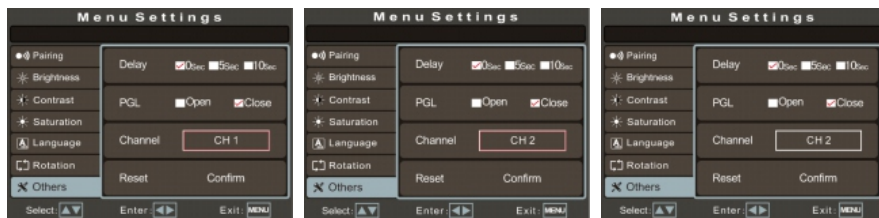

7

10. Reset Setting

Press “ ” on the panel or “VIDEO” “MODE” on remote control to switch to “Others” option, and then press “ ” on the panel or “LEFT” “RIGHT” on remote control to enter into “Others” selection. Press “ ” on the panel or “VIDEO” “MODE” on remote control again to switch to “Reset” option, and then press “ ” on the panel or “LEFT” “RIGHT” on remote control to confirm the reset setting. Press “MENU” to exit the current setting. Just as shown in the following pictures.

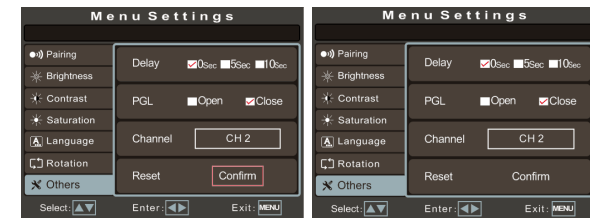

C.Connection

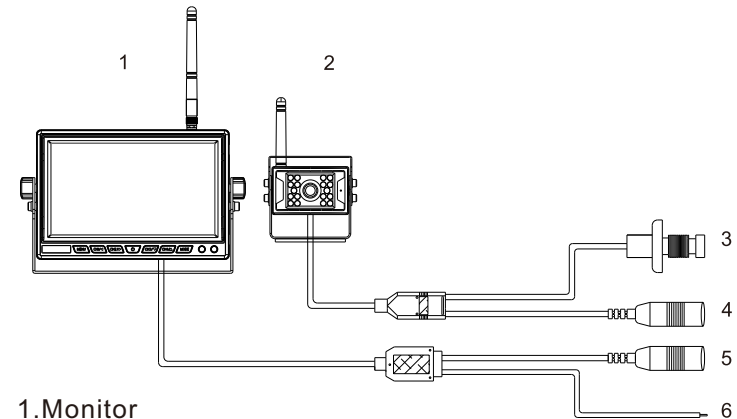

1. Monitor
2. Camera
3. Camera Pairing button
4. Camera power supply port: DC12-24V input
5. Monitor power supply port: DC12-24V input
6. Reversing trigger line

8

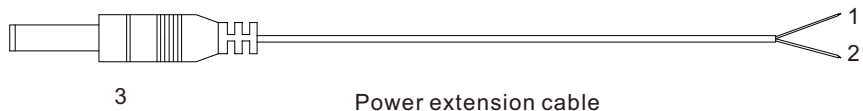

Power extension cable



- 1.Red electronic wire: DC12-24V power input
- 2.Black electronic wire: GND
- 3.DC Male connector: connect to the monitor or camera

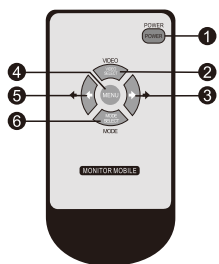





3.Remote control



- 1.POWER: open or close monitor
- 2.VIDEO: increase volume
- 3.Left direction key: decrease brightness
- 4.MENU: open or exit menu
- 5.Right direction key: increase brightness
- 6.MODE: decrease volume

4.Accessories

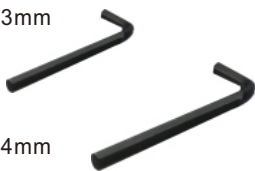
1.Power extension cable*2PCS	2. Remote control*1PC
	

<p>3.2.4G antenna*2PCS</p> 	<p>4.2.4G 3M antenna extension cable*1PC</p> 
<p>5. 2.4G wireless camera*1PC</p> 	<p>6. User Manual*1PC</p> 
<p>7.Hexagon wrench*2PCS</p> <ul style="list-style-type: none"> • 3mm • 4mm 	<p>8.Warranty card *1 PC</p> 
<p>9.Registration form* 1PC</p>	
