

User's manual

1. Parts list

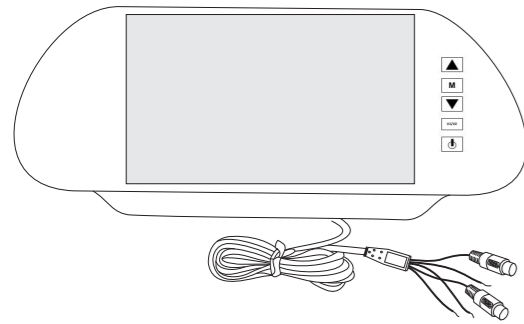

A. 7" TFT monitor ×1



B. Remote controller ×1

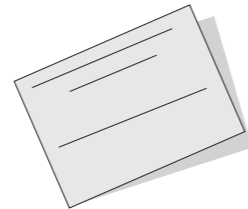

C. User's manual ×1

2. Diagram of installation

A:

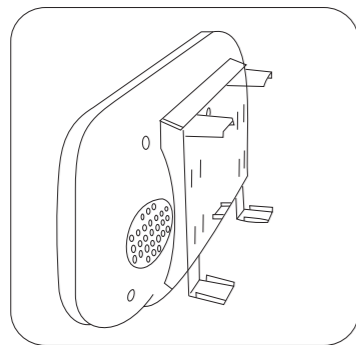

Figure (1)

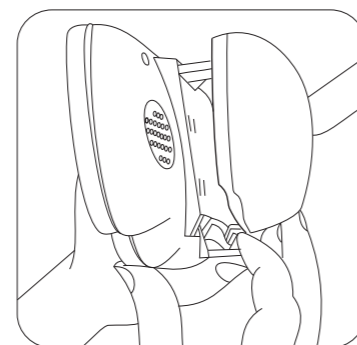
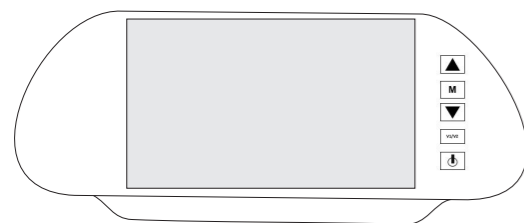

Figure (2)

B: Connection



3. Functions of Button



- ▲: Analog +/- (adjust brightness, contrast, color, pos: DN Normal (reverse image), etc.)
- Menu: menu options (press MENU to shift different menus)
- ▼: Analog +/- (adjust brightness, contrast, color, pos: DN Normal)
- V1/V2: Switch Between AV1 and AV2
- Power: Power on/off

4. Remote controller

A: operations of remote controller

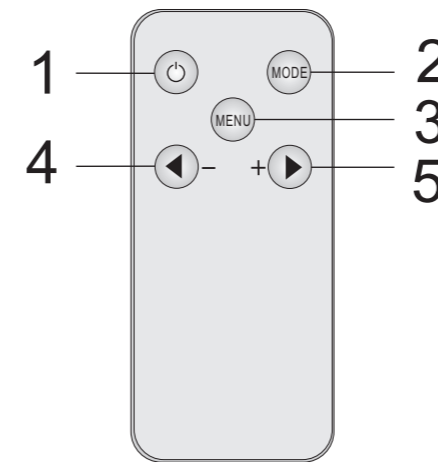

1. Power: power on/off (when the monitor is powered on, press POWER button to close menu, press and hold it for 1 second to power it off)
2. Mode: change the Av1 or Av2
3. Menu: menu options (press MENU to shift different menus)
4. ◀: Analog +/- (adjust brightness, contrast, color, pos: DN Normal (reverse image), etc.)
5. ▶: Analog +/- (adjust brightness, contrast, color, pos: DN Normal (reverse image), etc.)

B: Installation of batteries

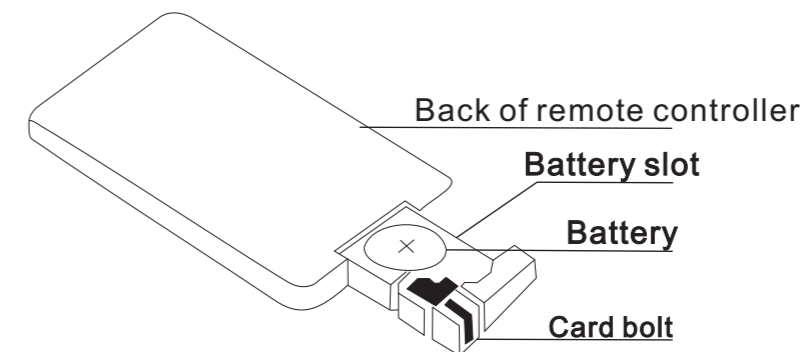

5. Specification

Model	VTM700M
Display resolution	800(W)*480(H)
System	PAL/NTSC
Power consumption	6W (MAX)
Monitor dimension	9.75"(W)*4.2"(H)*1.75"(D)
Storage temperature	-4°F ~ +149°F
Operation Voltage	DC12V

Care instruction

1. We strongly recommend have qualified technician or maintenance to install this device.
2. If this monitor does not work well, please check the connection first.
3. For your safety, please do not watch the monitor entertainment while you are driving