

BOYO[®]
VISION
Vision Tech America



VTR93M

Streaming Media Rear-View Mirror Monitor

USER MANUAL

Precautions

- Please insert the micro SD card in the right direction to avoid damage to the card or the VTR93M. If the VTR93M shows an error message, please format the micro SD card from the VTR93M menu. Please reset the VTR93M or replace the micro SD card if the error continues.

Note: All files will be deleted when formatting the micro SD card. Please backup the important files before you format. When the reset function is selected, the settings will be returned to the default setting.

- Recommended micro SD card: CLASS 10 or above micro SD card. Micro SD card specification varies from one brand to another and it may not function as expected when using with the VTR93M. Please review the micro SD's specifications before you use the micro SD card.
- The micro SD card must be formatted before using with the VTR93M. Backup recording files once a week to prevent files from being overwritten. Please format the micro SD card once every month for recording stability.
- Please make sure the straps are installed properly and firmly onto the rearview mirror to avoid any damage to the VTR93M and for better recording angle.
- The battery life-span will continuously decrease upon usage. Please charge the battery once every month to preserve the battery life.
- Please do not use the VTR93M in a wet environment as the mirror monitor is not waterproof or water resistant.
- Please do not record or take pictures in direct sunlight.
- To obtain clear images, please clean the windshield and the VTR93M cameras on a regular basis. Avoid using the VTR93M in a dusty environment.

- Please handle the VTR93M with care. Avoid using the VTR93M in a high electromagnetic environment.
- Operating temperature of the VTR93M is -4°F to 140°F. Continuous exposure to sunlight, especially when the VTR93M is mounted in a vehicle where the temperature exceeds above 158°F, the VTR93M may malfunction, screen change colors or image distortion.

Disclaimer:

This device is NOT intended to be used for illegal purposes; surveillance shall not be used in any form as evidence for claim purposes. Some countries prohibit drivers from mounting anything on the windshield, or restrict mounting to specific areas of the windshield. It is the owner's responsibility to mount the device in compliance with local laws. Errors may occur depending on the surrounding environment and the voltage of the vehicle. Company is not liable or responsible for non-recorded event, missing files and others. Company will not be liable for any damage incurred directly or indirectly from errors, omissions, or discrepancies.

Do not operate the device while driving. Using this device does not change the requirement for a driver to take full responsibility for his or her behavior. This responsibility includes observing all traffic rules and regulations in order to avoid accidents, personal injury or property damage.

1. Product Structure

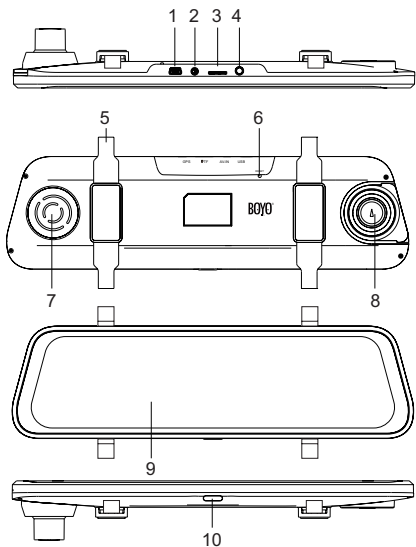

1	USB power input	6	RESET button
2	AV-IN rear camera input	7	Speaker
3	Micro SD Card slot	8	Front Camera
4	GPS antenna input	9	LCD Screen
5	Back strap mounting hook	10	ON/OFF/LCD Off

2. Function

A. Power Function

1. Power On

In the off state, long press the ON/OFF button, the VTR93M enters into video mode and starts recording automatically. Or when the VTR93M is connected with the vehicle charger in the off state, it enters video mode and starts recording automatically. When the USB charger is unplugged, the VTR93M will automatically save the current file and shut down within 10 seconds delay.

Note: LCD screen displays 'Please insert SD card' if Micro SD card not inserted.

2. Power Off

In the working state, long press ON/OFF button to power off the VTR93M.

Note: In low battery state, the VTR93M displays 'Low Battery' and will automatically saves the current file and shuts down.



B. Function Keys

VTR93M will enter into the main interface after it is powered on. (As shown below)











These are function operation keys. If no operations within 5 seconds, the keys will disappear, touch the LCD screen anywhere and the keys will appear on the screen again.

 **Video key:** Click the key in video standby mode, the VTR93M enters into video mode and starts recording and the  appears on the top left corner of the screen. Click it again, the VTR93M stops recording and the  disappears off the screen.

 **Photo key:** Click the key to take a photo with sounds prompt in the standby or video mode.

 **Record audio key:** The icon shows the record audio on. Click the key to close record audio in the standby or video mode and  appears.

 **Manual lock key:** Click the key in the recording to save the current video file from being overwritten and the  appears on the top of screen. Click it again to unlock the current file and the  disappears off the screen.

 **File management key:** In video standby mode, click the key to access the file management interface to playback/delete videos and photos.

 **System setting key:** In video standby mode, click the key to enter into system setting.

 **Screen brightness adjustment bar:** Hold the middle adjustment button and drag it left or right to adjust the brightness of the screen.



Window adjustment bar of rear camera: The icon appears after the VTR93M is powered on and connects with rear camera. Click on the top or bottom position of the adjustment bar to adjust the viewing position of rear camera's image on the screen, this allows the users to focus on the appropriate area behind the vehicle.







Front and rear camera image display switch: In the screen control interface, click any position of the screen (non-operation button) to switch between the current camera image to the other camera image.

C. File management



1. Click the  key to enter into file management interface. (As shown below)





Click  to playback the videos and click the  to view the photos; the middle window displays the files and the bottom right window displays the current page and the total number of pages of the file. Click the  or the  to change the file page.

2. Click the play icon in the middle window to play the video. (As shown below)





Click  key to play the current video, click the  key to lock or unlock the file, click the  key to delete the current file that is unlocked.

Click the  to return the last interface and Click the  to return to the main interface.

D. System setting

Click the  key to enter into the system setting menu. (As shown below)



Click  or  key to switch the menu page. When set a menu, click the menu and the setting options of the menu will be shown on the right, and then click the setting option with its color changed. The setting is completed.

E. G-Sensor

When the vehicle brakes suddenly or being hit heavily, G-sensor will activate to save and protect the current video clip from being overwritten automatically. Three grades setting (high, medium and low) to cater for different vehicle owners.

F. Parking Monitor

Parking monitor is for security monitoring when the vehicle is parked.

Please set the Parking Monitor ON in settings menu. After the vehicle engine is off, the VTR93M will power off accordingly. If the VTR93M detects vibration, it will power up to record automatically. The function only can be used in the condition of a fully charged battery.

G. Motion Detection

When motion detection is on, the camera automatically starts recording when it detects movement in the front camera field of view. The function only works when the camera is turned on. Factory default is OFF, turn on if needed.

H. Vehicle License Plate Number

Go to vehicle license plate number in the setting menu to input the license plate number.

I. GPS Tracking

1. As soon as GPS antenna is connected to the VTR93M and detects a signal, the GPS icon  will appear on the right of screen, when the VTR93M locates GPS successfully, the driving speed and compass direction can be viewed on the screen.
2. Please use a professional Dash Cam player to play video files. The current driving track, speed and coordinates will be displayed on the player.

Go to Update Time of GPS settings menu to select time zones. When the VTR93M locates GPS successfully, the VTR93M's current time will be synchronized with the GPS satellite time. GPS functions outdoors, the VTR93M may not receive GPS signal indoors.

J. USB Mode (USB cable not included)

Connect the USB cable to the computer, the VTR93M will automatically pop up the USB menu. There are three different modes to choose from:

1. Memory Mode

In this mode, you can access video files and photo files.

2. Camera Mode

Selecting this mode, the VTR93M can be used as a PC Camera.

3. Camera Recording Mode (USB cable is used as a power supply in this mode)

In this mode, you can record the video and take pictures.

Note: Incorrect operation can lead to a system crash. Please use a small hard pin to press the reset button to restart the VTR93M.

3. Specifications

Specifications may change without prior notice.

Screen	9.35" full touch screen display
Video Resolution	1920*1080P or 1280*720P (front cam); 1280*720P (rearview cam)
Cameras	170° diagonal for front camera; 120° diagonal for rearview camera
Video Format	MOV
Photo Resolution	2M
Photo Format	JPG
G-sensor	Supported
GPS Tracking	Supported
Motion Detection	Supported
Parking Monitoring	Supported
Loop Recording	Supported
Vehicle License Plate Number	Supported
Microphone/Speaker	Supported
Memory Card Capacity	Max. support 32GB (class 10 or above suggested)
Frequency	50HZ/60HZ
Power	5V/2A
USB Type	Mini USB
Language	English/Spanish/French/Chinese/ Japanese/Russian
Battery	Built-in battery

4. Accessories



Mirror Monitor/Front Camera



Rearview Camera



Mounting Straps

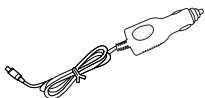

Vehicle USB Charger



GPS Antenna



User Manual