



CONTENT

1. Installation and Removal of Spark Plugs	2
2. Brisk Cylinder Head Manufacturer Spark Plug Recommendations	4
3. Spark Plug Gap Spark Plug Gap Chart	8
4. Brisk Spark Plugs Performance Racing	12
5. Spark Plugs Maintenance	13
6. Spark Plug Diagnosis	14
7. How to Change Spark Plugs Torque Spec Chart	16
9. Spark Plugs Electrical Properties	20
10. Spark Plug Cross Reference Heat Range Chart	23
11. Basic Theory of Spark Plug Operation	28
12. Spark Plugs Identification & Construction	33
13. Heat Range Cross Reference Table	43
14. Heat Range	44
15. Maintenance	49

INSTALLATION AND REMOVAL OF SPARK PLUGS

When it comes to removing and installing spark plugs, a job well done isn't always the quickest but is vital to the degree of difficulty when it comes to spark plug replacement. Anyone who has had to remove a cylinder head to retrieve a broken spark plug knows just how important it is to do things right when performing this task. Before you begin make sure that you have the correct spark plugs for the application you're working on and be sure that you verify that those spark plugs meet the dimension and gap specifications recommended for that application. All Brisk Spark Plugs come pre-gapped from the factory, however it is critical to be sure that gap specifications are met before installation.

Tools And Materials You will Need

- New set of Brisk Spark Plugs
- Spark plug socket size to fit your spark plugs
- Spark plug socket extension (if needed)
- Spark plug socket ratchet for spark plug removal
- Compressed air or "air in a can" to clean the area around the spark plugs
- Spark plug torque wrench to correctly tighten the spark plugs to specification
- Spark plug dielectric grease
- Spark plug anti-seize
- Spark plug boot removal tool
- Spark plug gap tool

You May Also Need:

- Additional tools needed to gain access to the spark plugs
- Safety glasses
- Work gloves
- Shop rags
- Parts cleaner

Spark Plug Removal

If this is your first time changing spark plugs you may want to take a picture of the engine compartment prior to beginning work on the vehicle. This will be a good tool for reference later if you are unsure about where things were when you are putting things back together. Prior to beginning work on the vehicle, be sure to allow the engine to completely cool down. This is going to greatly assist in the removal process. Remove the engine cover to gain access to the spark plugs, ignition wires and/or ignition coil (s). Most modern vehicles utilize a COP (Coil on Plug) format where the ignition coil "sits" on top of each spark plug. The ignition coil is connected to the sparkplug by a spark plug boot which is essentially something like a very short ignition wire. Older vehicles are commonly equipped with one ignition coil, a distributor and ignition wires (ignition leads) that connect to each individual spark plug. Once access is gained to the spark plugs it is a good idea to change one spark plug at a time, in order to prevent mixing up the components. Main

thing here is “Keep it simple!” To remove the spark plug wire or boot, turn the connection back and forth (clockwise and counter-clockwise) to loosen the bond. Preferably using the **spark plug boot removal tool**, gently pull as you are rotating the boot until it “breaks free” from the spark plug. If you just start pulling on boot or wire before loosening it from the spark plug, it frequently breaks and part of the spark plug boot remains on the spark plug. This instance would make spark plug removal difficult as the **spark plug socket** typically does not fit over the remaining part still attached to the top of the spark plug. Once the spark plug boot is removed the area around the spark plug should be cleaned using **compressed air** to prevent any loose debris from falling inside of the cylinder head. Sometimes there can be engine oil or engine coolant sitting around the spark plug. If this is the case, the engine valve cover gasket and/or spark plug tube seals are a common problem that cause of engine oil collecting around the spark plugs and should be replaced. If engine coolant is collecting around the spark plugs it is typically caused by leaking coolant or heater hoses, or potentially even an intake gasket (only on some vehicles). In either case, any such issue must be corrected prior to spark plug replacement as it will lead to engine misfire and damage to the spark plugs and boots. If this is not an issue then unscrew each spark plug carefully using the **spark plug socket**

Spark Plug Installation

All Brisk Spark Plugs are pre-gapped in the factory but it is crucial that you verify that gap specifications are met for your particular application so using the **spark plug gap gauge**, check the gap between the ground and center electrodes to ensure that the gap is correct. You always want to perform this task before installation unless specifically advised not to by the manufacturer. Always follow the recommendations of the spark plug manufacturer. Before installing the new spark plugs, apply a thin layer of **spark plug anti-seize** to the threads of the new spark plug. This will ensure a smooth thread installation and easy removal on your next spark plug replacement. You want to also apply a small amount of **spark plug dielectric grease** to the porcelain insulator head. This will ensure an air-tight seal between the boot or wire and the new spark plug and also prepare for an easy boot or wire removal during your next replacement. Thread one of the new spark plugs into the spark plug hole tightening it until you can no longer turn it with your fingers. Using a short piece of “snug-fitting” rubber hose can greatly assist you with the hand tightening process and will also prevent thread damage due to “cross-threading.” Then using the **spark plug torque wrench**, tighten the plug to the specification listed by the service manual or manufacturer. Be sure you do not over-tighten the spark plug during installation. Over-tightening the spark plug can cause the shell of the spark plug to stretch resulting in the loss of heat conduction and dissipation which will ultimately lead to serious spark plug and possible engine damage due to pre-ignition. Once the spark plug has been installed correctly, attach the ignition coil or spark plug wire to the new spark plug assuring the boot is fully seated on the head of the new plug. When performing a spark plug replacement, it is always recommended to change the ignition wires or boots to achieve the best ignition and engine performance. That being said, repeat this process for the remaining spark plugs.

BRISK CYLINDER HEAD MANUFACTURER SPARK PLUG RECOMMENDATIONS

CYLINDER HEAD MANUFACTURER	SPEC SHEET SPARK PLUG RECOMMENDATION	BRISK SPARK PLUG PART NUMBERS
	AIR FLOW RESEARCH	
205cc LS1 Mongoose Street Head	AC 41-974 Platinum	GR15YS, GOR15LGS, GR15ZC, GOR15YTE
225cc LS1 Mongoose Strip Head	AC 41-974 Platinum	GR15YS, GOR15LGS, GR15ZC, GOR15YTE
180cc SBC Street Head	AC FR3LS	DR15YS, DOR15LGS,DR15ZC, DOR15YTE
180cc LT1 Street Head	AC FR3LS	DR15YS, DOR15LGS,DR15ZC, DOR15YTE
195cc SBC Street Head	AC FR3LS	DR15YS, DOR15LGS,DR15ZC, DOR15YTE
195cc LT4 Street Head	AC FR3LS	DR15YS, DOR15LGS,DR15ZC, DOR15YTE
305/315/325/335/345/357cc Magnum BBC	CHA C59C,AUT 3932	D10S, DO10LGS-T (index free plug)
165/185cc SBF Outlaw Street Heads	AUT 3924	DR15YS, DOR15LGS,DR15ZC, DOR15YTE
205/224cc SBF Outlaw Race Heads	AUT 3922	DR14YS, or DR14S (non- projected tip)
165/185cc SBF Street/Strip Outlaw Heads	AUT 3924	DR15YS, DOR15LGS,DR15ZC, DOR15YTE
	BRODIX	
BBC,Big Brodie Series	NGK B9ES	gas L11SL, L10SL Alcohol
C.A.R.B. Legal Heads	CHA 14YC or AUT 3924	DR15YS, DOR15LGS,DR15ZC, DOR15YTE
	DART	
Big Chief, All	.750" reach,gasket,CHA C57C/C57YC	D08S, DO10LGS-T (index free plug)
Big M- Head	.750" reach,gasket,CHA C59C/C59YC Street RC12YC	D10S ,Street app. DR15YS

Ford 20 Degree	.750" reach,gasket,CHA C59C/C59YC	D10S, DO10LGS-T (index free plug)
Iron Eagle,308cc&345cc BBC	.750" reach,gasket,CHA C59C/C59YC Street RC12YC	D10S ,Street app. DR15YS
Iron Eagle,23 Degree,180,200,215,230cc SBC	Angle or Straight,460"Reach,Tapered Seat, CHA V59C/V59YC	H08S, HO11LGS-T (index free plug)
Iron Eagle S/S	Straight,460"Reach, Tapered Seat, CHA RV12YC/AQC R44TS	HR17YTE (stubby), HOR15LGS, HR14YS
Little Chief, 11 Degree SBC Head	CHA C57C/C57YC	D08S, DO10LGS-T (index free plug)
Pro 1, 23 Degree SBC&BBC all cc's	CHA C59C/C59YC	D10S, DO10LGS-T (index free plug)
Race Series,220cc SBC Head	CHA C59C/C59YC	D10S, DO10LGS-T (index free plug)
Race Series,18 Degree BBC Head	CHA C57C/C57YC	D08S, DO10LGS-T (index free plug)
EDELBROCK		
All Except Flathead		DR15YS, DOR15LGS,DR15ZC, DOR15YTE
FORD RACING PERFORMANCE PARTS		
GT-40 "Turbo-Swirl" Alum.Cyl Heads		DR14YS, DOR14LGS, DR14ZC
GT-40X "Turbo-Swirl" Alum Cyl Heads		DR14YS, DOR14LGS, DR14ZC
"Sportsman" Short Track Cast Iron Cyl Heads		HR14YS, HOR14LGS, HO14LGS
"Z" Aluminum Heads		DOR15LGS
Robert Yates Alum. Cyl Heads		L- style sparkplug (13/16hex, 14mm, gasket)
"High Port" Yates Head		L- style sparkplug (13/16hex, 14mm, gasket)
High Port Head for all out Performance		L- style sparkplug (13/16hex, 14mm, gasket)
Super Cobra Jet Cylinder Heads		DR14YS, DOR14LGS, DR14ZC
PRO TOPLINE		
Iron Lightning, Pro Lightning	CHA V55C,V57C	H08S, HO11LGS-T (index free plug)
Other	CHA C55C,C57C	D08S, DO10LGS-T (index free plug)
TRICK FLOW		
Track Heat Alum.Cyl. Heads for SB Ford	AC FR3LS, AUT 3924, NGK 7373	DR15YS, DOR15LGS,DR15ZC, DOR15YTE

18 Degree Alum. Heads for SB Chevy	CHA C57C, NGK R5671A-10	D08S, DO10LGS-T (index free plug)
23 Degree Alum. Heads for SB Chevy 175, 195	AC FR3LS, AUT 3924, NGK FR5, CHA RC	DR15YS, DOR15LGS, DR15ZC, DOR15YTE
R-Series Cyl. Head for BB Chevy	AUT 3922	DR14YS, DOR14LGS, DR14ZC
GenX 205, 215, 220, 225, 235, 245, 255; GM LS	NGKTR6	GR14YS, GOR14LGS, GOR14LGS-T
GenX 185, 195; GM LS		
- chamber volume M54: 54 cc (CNC-profiled)	NGKTR6	GR14YS, GOR14LGS, GOR14LGS-T
- chamber volume 10: 62 cc (Standard)	FR5	DR15YS, DOR15LGS, DR15ZC, DOR15YTE
Power Oval 280 for BB Chevy	AUT 3924	DR15YS, DOR15LGS, DR15ZC, DOR15YTE
Power Port 320, 360 for BB Chevy	AUT 3924	DR15YS, DOR15LGS, DR15ZC, DOR15YTE
Twisted Wedge 185, 195 - Ford 4.6L, 5.4L; 2 Valve	SP- 432	GR15YS, GOR15LGS, GR15ZC, GOR15YTE
Power Port Cleveland 195, 225 Ford351C, 351M/400, Clevor	AUT 3924	DR15YS, DOR15LGS, DR15ZC, DOR15YTE
Twisted Wedge Track Heat 170, 185, 205 for SB Ford	AUT 3924	DR15YS, DOR15LGS, DR15ZC, DOR15YTE
High Port 192, 225, 240 for SB Ford	AUT 3924	DR15YS, DOR15LGS, DR15ZC, DOR15YTE
Power Port 290, 325, A460 340, 360 for Ford 429/460	AUT 3924	DR15YS, DOR15LGS, DR15ZC, DOR15YTE
WORLD		
Windsor Jr		HR14YS, HOR14LGS, HO14LGS
Windsor Jr. Lite		DR15YS, DR14YS, DOR14LGS, DR14ZC
Windsor Sr. Lite		DR15YS, DR14YS, DOR14LGS, DR14ZC
Roush 200 Cast Iron		HR14YS, HOR14LGS, HO14LGS
Torquer 440 Aluminum		D10S, DO10LGS-T (index free plug), D08S
Sportsman II Lite		DR15YS, DR14YS, DOR14LGS, DR14ZC
S/R		HR17YTE (stubby), HOR15LGS, HR14YS

S/R Torquer	HR17YTE (stubby), HOR15LGS, HR14YS
Sportsman II	HR17YTE (stubby), HOR15LGS, HR14YS
Motown 205/220	HR17YTE (stubby), HOR15LGS, HR14YS
Motown 220 Lite	DR15YS, DR14YS, DOR14LGS, DR14ZC
Merlin II Oval & Rect. Port	HR17YTE (stubby), HOR15LGS, HR14YS
320cc & 345cc Merlin	DR15YS, DR14YS, DOR14LGS, DR14ZC

WARNING: Cross reference is provided for convenience only!
Prior installation please confirm spark plug recommendation
with cyl. Head manufacturer and/or
engine builder/tuner

SPARK PLUG GAP | SPARK PLUG GAP CHART

Spark Plug Gap setting is important for proper engine operation. To set the spark plug gap correctly, you need to use a spark plug gap tool. For reference, see our spark plug gap chart below, this chart converts metric measurements to standard.

How to Change Spark Plugs - Spark plug Gap setting and Gap cross reference chart

Spark Plug Gap cross reference chart - metric to standard (mm to inch)

mm	0.4	0.5	0.6	0.7	0.8	0.9	1.0	1.4	1.5	1.6	1.7
inch	.016"	.020"	.024"	.028"	.032"	.035"	.039"	.055"	.059"	.063"	.067"

The very most important rule when checking or adjusting spark plug gap is, to never pry, apply or exert any force on the spark plug center electrode, or center electrode ceramic insulator. The force should be applied ONLY on the spark plug ground electrode strap moving it closer or further away from the spark plug center electrode. The spark plug gap adjustment should not be changed more than 3 times and should not exceed .008" in either direction. Excessive changing of the spark plug gap setting will result in weakening of the spark plug ground electrode and can lead to breakage. Also, the spark plug gap should never exceed .055" unless pre-set by the manufacturer.

Most Brisk and other manufacturer sparkplugs are preset to around 0.75mm - 0.8mm. If your spark plug part number has no trailing digits then (for most part numbers) it will be preset to this specification. The exception are for example spark plug part numbers with gap that does not need to be adjusted and can not be changed, such as Brisk Premium Multi-spark plugs, Brisk Premium LGS Spark Plugs, Brisk Premium LGS-T spark plugs, Brisk Extra Turbo Spark Plugs and some others.

The "-T" indicate LGS style spark plug with a **Tighter gap** than standard LGS style spark plug and should be used on applications where the recommended gap setting is less than .032"., Brisk Extra Turbo Spark Plugs and some others. If there are trailing numbers after the part number, then the gap should be specifically set as per the manufacturer's part code designation (e.g. Brisk RR15IRY-7, gap size is 0.7 mm, Brisk GOR15YTE-3, gap size is 1.3mm NGK BKR6E-11, gap size is 1.1mm, Denso T16EPR-U15, gap size is 1.5mm, Champion RC10YC4, gap size is 1.0mm). Part numbering for Brisk, NGK and Denso spark plugs is reasonably logical with the trailing digits transposing directly into size in mm. For Champion spark plugs it is a little less logical and is as listed below:

4 = 1.0mm (e.g. RC10YC4)

5 = 1.3mm (e.g. RN16YC5)

6 = 1.5mm (e.g. RS14YC6)

Spark Plug Gap - understanding the basics

Spark plug gap is where spark plug spark discharge is designed to take place. On a conventional spark plug, it is the area between the center and the ground electrode. As the spark always follow the path of least resistance, spark gap is generally the closest point between the spark plug center electrode and the spark plug ground electrode which is sometimes formed by the spark plug shell itself. The only case when the spark will travel longer path to the ground, is when the longer path is more conductive (provides less resistance). This can be caused for example by loss of insulating property of ceramic due to conductive carbon build up from the combustion process (spark plug fouling).

Large spark plug gap setting demands higher voltage (electrical pressure) for spark to jump the large distance gap. That means that there is higher voltage build up in the ignition system (ignition coil, distributor, ignition wires) prior to the spark discharge. This is generally desired in applications with late model high output ignition coils and lower compression naturally aspirated engine applications where cylinder pressures are relatively low and easy for spark discharge to occur.

However running a large gap in high cylinder pressure application (which makes it very hard for spark to occur), will demand such a high voltage (electrical pressure) for spark to jump the spark plug gap, that the spark will find an easier way to the ground, possibly where the ignition wire is close to the ground (engine block etc...) or inside of distributor cap, inside of the ignition coil, on the outside of the spark plug (between the plug and the boot) etc... In either way the spark will not occur between the spark plug electrodes inside the combustion chamber, and engine misfire will occur.

Generally the applications with low cylinder pressures (low compression ratio) running lean A/F (Air/Fuel) mixtures have large recommended gap (around .050"), and applications with high cylinder pressures (high compression, forced induction - turbo, supercharged, nitrous applications,...) require spark plug gap smaller than .032". The dense A/F mixture is much harder for spark to penetrate, and require much higher voltage (pressure). Higher fuel concentration has the same effect (lower A/F ratio). That reason is why high power vehicles (1,000 horsepower and more) often run a spark plug gap as small as .016". Some applications such as ProMod turbo cars using M1 fuel frequently run a spark plug gap as small as .012", even though they are equipped with some of the highest output ignition systems providing in excess of 60,000 Volts high current and high mJ power output.

Sometimes customers wonder, why there is so many different spark plug gap firing configurations. The reason is, that in order to get the best possible performance, the spark plugs have to be carefully matched with the appropriate application and intended use. The like to be "experts" often say that there is no difference in spark plugs, and that the mixture either gets ignited or not. They can not be further from the truth! Even standard vehicle Modern OBD-II (On Board Diagnostic) engines can determine from a simple crankshaft position sensor the angular speed of the crankshaft. Mounted on the crankshaft is a trigger wheel that has many teeth, as the crankshaft spins, this wheel inducts a pulse when each tooth passes the sensor. If every cylinder generates exactly the same amount of power, than the time between each pulse is in the same pattern. However if one cylinder produces slightly less power, the time between the corresponding pulse is slightly increased. This is calculated as a % of misfire. Modern engines often turn the check engine light on with a misfire code (generally P03xx) with corresponding cylinder number when only as little as 10% misfire occurs, which is far before anyone will even feel that something is wrong or even think that a misfire is occurring.

There can be a lot of power gained by using an optimal spark plug for given application, as well as installing a fresh set of spark plugs. It is not uncommon to gain as much as 20 Hp just by replacing used spark plugs. Used spark plugs are hard to fire as the gaps are worn out, and insulation properties of the ceramic is compromised by solid combustion deposits and old fuel saturation.

This robs available voltage at the spark plug gap, as it "leaks" through the low resistance carbon deposits to the ground, resulting in a weak spark. Think of a worn out spark plug gap like an old leaky water hose that requires more water pressure, and is like a restricting the flow at the end with your finger. More pressure is required form the leaky hose, because more water leaks out at other places than the hose end.

There are many different spark plug gap styles available, some with low gap capacitance, some with high gap capacitance, some with low ignition voltage requirement, some with high ignition voltage requirement, some with projected tip, some with retracted tip, some with fixed gap, some with adjustable spark plug gap, some with several parallel gaps, some with several gaps in series.

For the best engine and spark plug performance, the size, style and shape of the spark plug gap should correspond with many factors. Some of them are:

- 1) Potential of the ignition system - Spark Voltage (sometimes explained as Voltage potential or electrical pressure) corresponds with the distance that spark can cross at given air pressure and environment (concentration of the A/F (Air/Fuel) mixture etc... between the spark plug gap (center electrode and ground electrode).
- 2) Pressure in the combustion chamber at time of spark discharge - Depends on compression and aspiration of the engine. High compression engines and engines with forced induction have higher combustion chamber pressures at time of spark discharge. Higher cylinder pressure requires higher voltage for the spark to occur.
- 3) Type and concentration of the fuel - for example fuels with high alcohol content requires lower A/F ratio and smaller spark plug gaps.
- 4) Engine ignition timing advance - the closer to the engine TDC (Top Dead Center) the spark occurs, the higher is the A/F mixture pressure it has to fire, and the harder for spark it is.
- 5) Engine load and intended use - when engine is under load, the pressures in the combustion chamber is higher as there is more air aspirated, making it harder for spark to occur. High RPM applications also shorten the ignition coil saturation (on time or DWEL) resulting in less available energy.
- 6) Type of Ignition system - magneto, CD (Capacitor Discharge), or Inductive. CD ignitions have very fast Voltage rise (short rise time) and therefore they also work very well with spark plugs that have high capacitance, such a spark plugs with multiple gaps and/or surface discharge spark plugs. On the other hand Inductive ignition systems generally provides longer spark duration...

Spark Plug Heat range.

Vehicles produced in series (which are not additionally modified for engine power output enhancement), whose engines are properly adjusted and in good technical condition, can be equipped according to the current application tables.

Any comparison charts of spark plugs are always for informative purposes only and they do not substitute the current application tables in full.

In the case of engine power output enhancement by means of additional modifications it is suitable to contact a producer's representative. There always applies a principle that in the case of medium modifications of the power output it is suitable to use the spark plugs "colder" by 2 degrees than those forming its original equipment (e.g. a change from 15 to 12). After driving several miles and subsequent assessment of the insulator tip appearance it is possible to decide about the most suitable equipment. This operation requires enough experience.

Proper length of the Spark Plug threaded shell

When changing the spark plugs, always ensure that the spark plug threaded portion of the shell (from the spark plug seat) is same length (or very close to) the O.E. spark plug.

If the threaded portion is slightly longer, spark plug indexing washers can be used to obtain the desired spark plug reach.

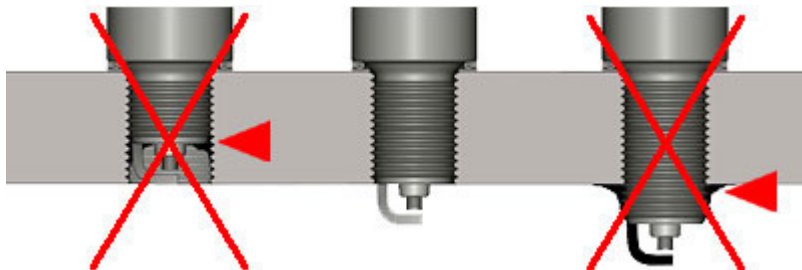

BRISK SPARK PLUGS PERFORMANCE RACING

Brisk Spark Plugs For Tuning And Race Applications

- Spark Plugs for Forced induction applications such as supercharged and turbocharged
- Spark Plugs for Nitrous Oxide applications

Performance Tuning

Car designers have to design vehicles for mass production. They are limited by continuous reductions to production costs and extending service inspection intervals. This all results in cars design where, performance and utility features are acceptable for most drivers.

There are some people, however, who are not satisfied with the uniformity of mass-produced vehicles and want to apply some degree of uniqueness. These efforts have led to an activity that is called "tuning" in the automobile industry. Tuning involves modification of appearance and shape of the body, sound of the exhaust pipe and often also engine power. There are many options for increasing engine power. One of the easiest methods is the use of a special spark plug.

Racing

BRISK manufactures special Sport Racing spark plugs for high-efficiency engines in racing cars; they have colder thermal values such as 12, 10 and 08 and are capable of dissipating more heat from the spark plug tip to combat overheating and pre-ignition. Colder heat range spark plugs are adapted to high temperatures in the combustion chamber, vibrations and, in the -T and Turbo Racing version (closer electrode distance), also extremely high cylinder pressures. It is known fact that longer spark discharge supplies more ignition energy into the combustion chamber, however increasing compression ratio, installation and/or increase of boost pressure of a supercharger or turbo, significantly increases voltage requirements of your ignition system due to higher pressure inside the combustion chamber. Your stock ignition system might not be capable of supplying required voltage to ignite dense air fuel mixture in the combustion chamber. In such case, it is necessary to upgrade your ignition system (MSD, Accel, Malory, Nology ignition), or use of a -T, Silver Racing or Turbo Racing version spark plug which has closer electrode distance and low ignition voltage requirement.

Increase in compression, forced induction (such as blowers and turbo), Nitrous Oxide and other power adders requires a use of a colder heat range spark plug; and in more radical builds, in a non-projected tip spark plug electrode configuration. If unsure of a proper thermal value (heat range) it is safer to start with a coldest spark plug and work your way up. If the spark plug heat range is too cold, spark plug will not reach it's required operating temperature and the spark plug will foul out. The result will be a misfire, instead of possible engine damage from pre-ignition or detonation caused by selecting spark plug with too high thermal value (heat range).

Equipment for racing cars is highly individualized and requires much experience in the choice of the best thermal value. Compression, boost pressure, air-fuel ratio, cooling efficiency, timing and other variables plays a major role in selection of an appropriate thermal value (heat range) of a spark plug. Wrong decision can lead to serious engine damage. Please consult unclear cases with an expert engine tuner, engine builder, or the producer. Any damages, implied or consequential caused by improper choice of spark plug cannot be claimed against the importer or producer of the spark plug.

SPARK PLUGS MAINTENANCE

Spark plugs do not require any maintenance during the replacement interval. Certain level of maintenance is, however, required by the vehicle whose part the spark plugs are. All deficiencies caused by insufficient vehicle maintenance can be reflected on the spark plug. That is why we recommend, within the framework of prevention, to check the spark plugs once a year. Their appearance reflects technical conditions of your vehicle.

Spark plugs replacement intervals are specified for a maximum mileage performance of the engine in a good technical condition. Therefore, **never exceed** the replacement intervals prescribed for a given type of spark plug. Possible spark plug replacement before the interval prescribed will not cause any problem.

SPARK PLUG DIAGNOSIS



1



2



3



4

DIAGNOSTIC OF FAILURE

Failure	Cause	Consequences	Fig.
Improperly adjusted ignition system	Spark advance (from a proper moment)	Pre - ignitions /Detonation burning	2
	Spark delay (from a proper moment)	Excessive formation of combustion deposits	1
Improper air/fuel ratio	Rich mixture	Excessive formation of combustion deposits	1
	Lean mixture	Pre - ignitions /Detonation burning	2
Low or no performance of the air filter	Dust penetration into the combustion area	Excessive deposits	3
	Filter impassability	Excessive formation of combustion deposits	1
Compression pressure	Low	Excessive formation of combustion deposits	1

Failure	Cause	Consequences	Fig.
Improperly selected spark plug	Too hot	Pre - ignitions Detonation burning	2
	Too cold	Excessive formation of combustion deposits	1
None		Perfect performance of the spark plug	4

Spark plug is like a dipstick into your engine, which will let you see what is going on inside of the combustion chamber.

The two most destructive combustion events to the engine and the Spark Plug are: PRE-IGNITION and DETONATION. These terms are commonly misunderstood and confused with each other.

Detonation occurs after normal combustion (controlled burning) was initiated from a spark between spark plug electrodes. As the flame front propagate through the combustion chamber, the pressure and heat on the remaining yet un-burnt mixture increases dramatically past the point of fuel octane rating and any hot spot (most often hot side of the piston) will detonate (explode) the remaining yet un-burnt mixture. This event takes place in a split second and cause extreme pressure shock wave, which often pits the piston surface (looks sandblasted as it compresses less dense micro-portions of the aluminum alloy) and almost always breaks ceramic insulator on the spark plug. The damage to the spark plug is a result of the events and the high frequency shock wave. Please note that detonation is a different event than pre-ignition where the mixture is ignited by usually hot spot, glowing carbon deposit or overheated ground spark plug electrode, prior to the mixture ignition by spark from spark plug. Pre-ignition is far more destructive to the engine than detonation because maximum cylinder pressure is reached far before the piston reach the TDC (top dead center). Pre-ignition will destroy the engine, put hole through the piston, or even blow it up. Detonation (can be also heard as engine knock or pinging) is not necessarily damaging to the engine if it is not prolonged and only very small amount of un-burnt mixture detonate. Modern engines in order to reach the maximum fuel economy run on the edge of pinging. They use knock sensors to "listen" for the pinging and retard the timing accordingly. However prolonged and severe detonation will hurt the engine and the spark plug, and is probably the most common cause of failure due to inconsistency of the octane rating of gasoline. Modern engines are equipped with a Knock Sensor which provides feed back to engine ECU/PCM to adjust engine ignition timing in order to prevent prolonged detonation. However engine knock sensor is often not working properly, or is purposely eliminated on some performance applications, which exposes engine and spark plug to damage from severe detonation. Spark plug is passive component with 3 basic functions. It have to: 1) stay cool enough to prevent pre-ignition 2) stay hot enough to burn off combustion deposits 3) provide spark to ignite A/F mixture. About the only time you can blame spark plug for a failure, is if too hot spark plug heat range is used and the spark plug ground electrode gets too hot and become a source of the pre-ignition.

HOW TO CHANGE SPARK PLUGS | TORQUE SPEC CHART

How to Change Spark Plugs - Spark Plugs Methods of Sealing, Spark Plugs Installation and Spark Plug Gap Chart sections of this page are here to help you better understand the most critical steps and procedures in changing spark plugs.

When replacing spark plugs, BASIC IDENTIFICATION OF SPARK PLUG - is necessary for determination of the correct spark plug installation troque.

Spark plugs are constructed by using two different manners of sealing in cylinder head.

Methods of spark plugs sealing in the engine cylinder head:

Conical seat - Spark plug is sealed in cylinder head with a conical (tapered) seat.

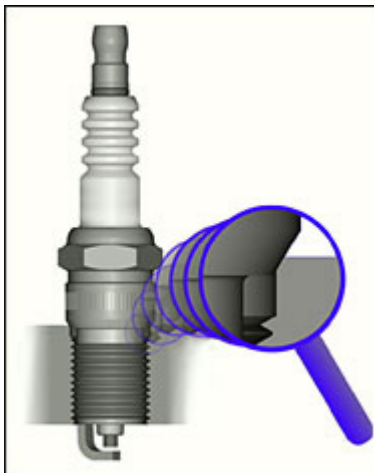

In this case no sealing washer is used. The assembly of spark plug with this kind of sealing requires an especially sensitive approach. For proper spark plug installation, it is always highly recommended to use spark plug removal and installation tool and spark plug torque wrench. Correct torque is the very most critical step of spark plug installation. If the torque is exceeded, the spark plug shell can be stretched, thermal characteristics can be lost and there may even occur a rupture of the spark plug during its assembly or dismantling in the engine... It is extremely important not to exceed the installation torque. However in order to ensure proper seating of a conical seat spark plug, it is a good idea to torque the spark plug, loosen it a 1/4 turn and torque it again. This will help ensure proper seating and adequate heat transfer. **This goes for conical seat spark plugs only!**

How to change conical (tapered) seat spark plug without torque wrench - (only if torque wrench can not be obtained)

TIGHTENING by ANGLE

When replacing spark plugs without spark plug torque wrench, spark plugs should be thread-in by spark plug removal and installation tool, or socket by hand (wihtout spark plug wrench) untill they fully seat. Then a spark plug wrench should be used to tighten the spark plug by turning an additional angle as follow:

new spark plug used spark plug

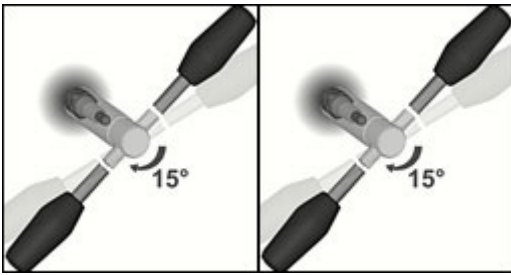

Sealing with a gasket (washer) - spark plugs can **never** be mounted into cylinder head without a sealing gasket (washer).

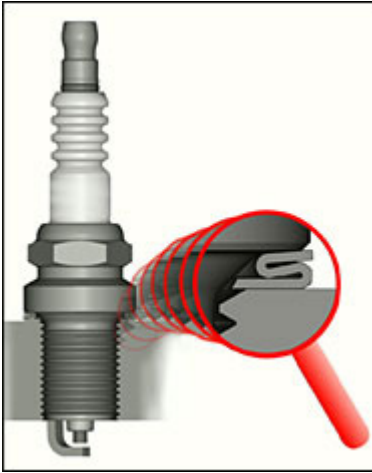

In this case sealing washer must be used (comes with new spark plugs). If gasket style spark plug is installed without sealing gasket, the combustion area **will not seal** sufficiently and heat removal (transfer of heat from the spark plug into the engine cylinder head) will not be sufficient. When replacing spark plugs, for proper spark plug installation it is always highly recommended to use spark plug removal and installation tool and spark plug torque wrench. Correct spark plug torque is the very most critical step of spark plug installation. It is extremely important to never exceed the spark plug recommended installation torque.

How to change gasket (washer) style spark plug without torque wrench - (only if torque wrench can not be obtained)

TIGHTENING by ANGLE

When replacing spark plugs without spark plug torque wrench, spark plugs should be threaded-in by spark plug removal and installation tool, or socket by hand (without spark plug wrench) until they fully seat. Then a spark plug wrench should be used to tighten the spark plug by turning an additional angle as follow:

new spark plug used spark plug

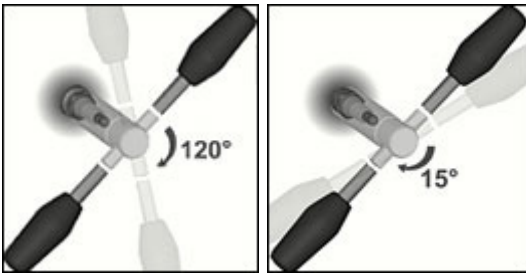

How to Change Spark Plugs - Replacing Spark Plugs using torque wrench

IMPORTANT !!! - When replacing spark plugs, the engine must be close to the ambient temperature. The area around the spark plugs should be cleaned with compressed air (or air in the can) to prevent foreign debris from falling into the combustion chamber. Spark plug and cylinder head threads need to be free of carbon build up, clean, and it is recommended, free of lubricant. If needed, cylinder head threads can be cleaned by spark plug thread chaser in the correct size thread (10mm, 12mm, 14mm). If spark plug thread lubricant (antisieze) is used when replacing spark plugs, it should be used very sparingly on the spark plug thread only and the spark plug installation torque is to be reduced by about 25% !

However, it is highly recommended to use spark plug dielectric grease in the spark plug wire cable boot, or Coil on Plug boot prior connecting to the spark plug. This ensures air tight connection which prevents spark flash-over (spark on the outside of the spark plug between the spark plug High Voltage terminal and the spark plug shell) which will cause spark plug misfire and engine hesitation. **Dielectric grease prevents misfires, keeps the moisture out, and ease the future removal of the spark plug wire or the spark plug boot.**

How to Change Spark Plugs - Spark Plug Torque Chart specs in (N.m.)

SPARK PLUG		HEAD OF ENGINE	
plug sizes	seals	cast - iron	aluminum
M 10 x 1	sealing ring	10 - 15 Nm	10 - 15 Nm
M 12 x 1,25	sealing ring	15 - 20 Nm	15 - 25 Nm
M 14 x 1,25	sealing ring	20 - 40 Nm	20 - 30 Nm
M 14 x 1,25	conical seat	10 - 20 Nm	10 - 20 Nm
M 18 x 1,5	conical seat	20 - 30 Nm	20 - 30 Nm

How to Change Spark Plugs - Spark Plug Torque Chart specs in (ft.lb)

SPARK PLUG		HEAD OF ENGINE	
plug sizes	seals	cast - iron	aluminum
M 10 x 1	sealing ring	7.2-10.8 ft.lb	7.2-8.7 ft.lb
M 12 x 1,25	sealing ring	10.8-18 ft.lb	10.8-14.5 ft.lb
M 14 x 1,25	sealing ring	18-25.3 ft.lb	18-21.6 ft.lb
M 14 x 1,25	conical seat	10.8-18 ft.lb	7.2-14.5 ft.lb
M 18 x 1,5	conical seat	14.5-21.6 ft.lb	14.5-21.6 ft.lb

How to Change Spark Plugs - Spark Plug Torque Chart specs in (in.lb)

SPARK PLUG		HEAD OF ENGINE	
------------	--	----------------	--

plug sizes	seals	cast - iron	aluminum
M 10 x 1	sealing ring	86-130 in.lb	86-104 in.lb
M 12 x 1,25	sealing ring	130-216 in.lb	130-174 in.lb
M 14 x 1,25	sealing ring	216-304 in.lb	216-259 in.lb
M 14 x 1,25	conical seat	130-216 in.lb	87-174 in.lb
M 18 x 1,5	conical seat	174-259 in.lg	174-259 in.lb

SPARK PLUGS ELECTRICAL PROPERTIES

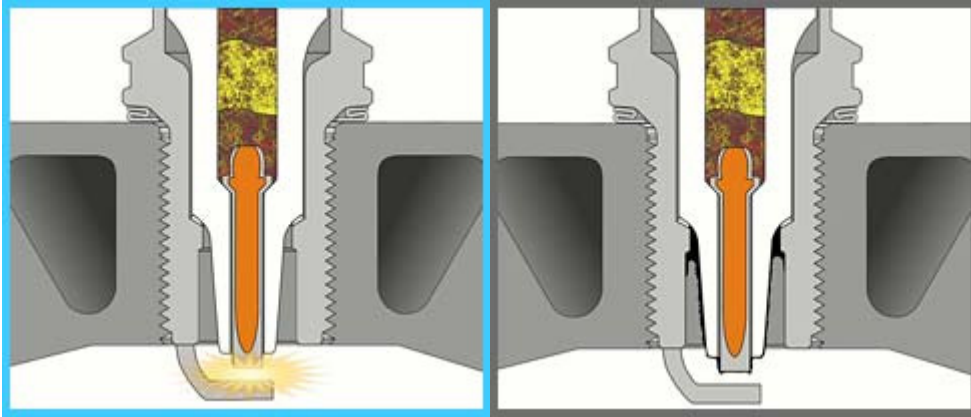

The fouling of insulator tip surface with combustion deposits reduces electrical **insulation resistance**. If the insulation resistance drops, there also occurs a drop in electrical voltage supplied to the spark plug from the ignition system. If, as a result of heavy fouling of the insulator tip, the insulation resistance decreases down to the value when the electrical voltage supplied from the ignition system is lower than the voltage required by the spark plug, there will be misfire of spark between the spark plug electrodes and a failure of the engine function.

Reduction of the insulation resistance from electric energy leakage on the insulator tip surface

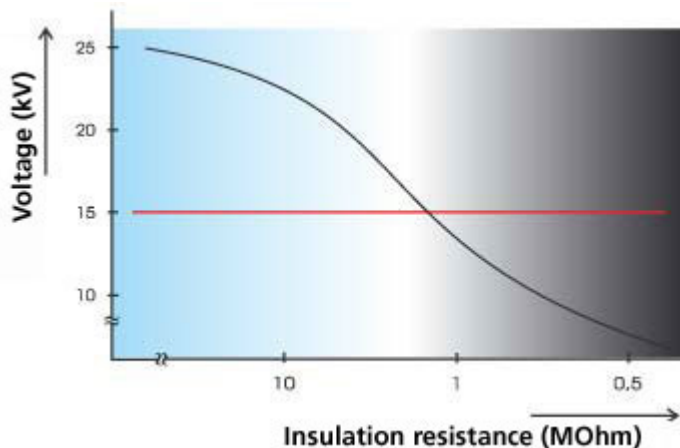

- voltage required by the spark plug
- voltage supplied by the ignition system

Voltage required by the spark plug and voltage supplied by the ignition system. In order that a discharge can occur between the spark plug electrodes, it is necessary that the ignition system can supply voltage of a certain value.

If the spark plug requirement concerning the voltage supplied by the ignition system exceeds its possibilities, there will not occur any spark jump across the spark gap. It generally applies that the spark plug voltage requirement increases if the electrode gap rises and during acceleration. The voltage supplied by the ignition system decreases at starting, low ambient temperatures and at a high speed of the engine.

Relation between voltage supplied by the ignition system and the spark plug requirement

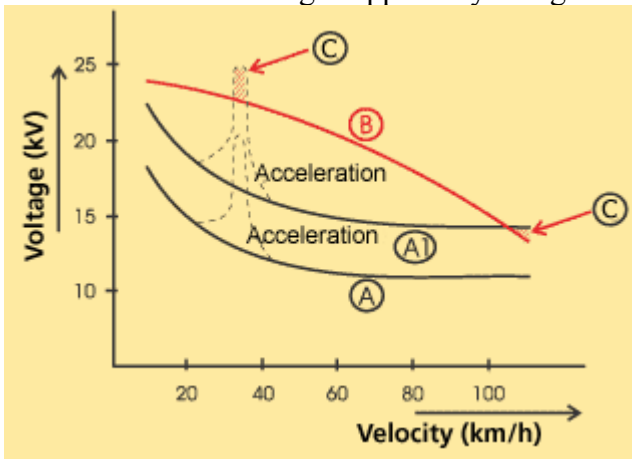

A. voltage required by the spark plug (new)
 A1. voltage required by the spark plug (used)
 B. voltage supplied by the ignition system
 C. insufficient voltage supplied by the ignition system

Relation between electrode gap and voltage

requirement of the spark plug

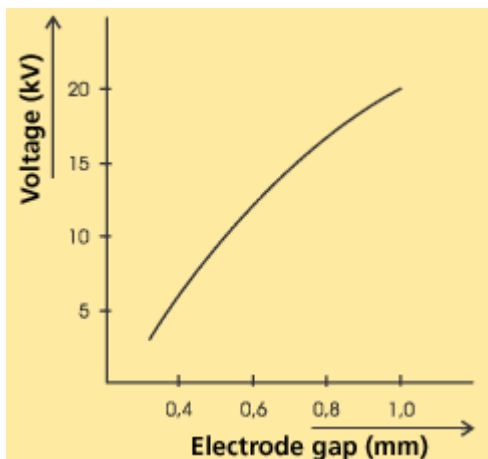

Relation between the spark plug wear and spark plug voltage requirement

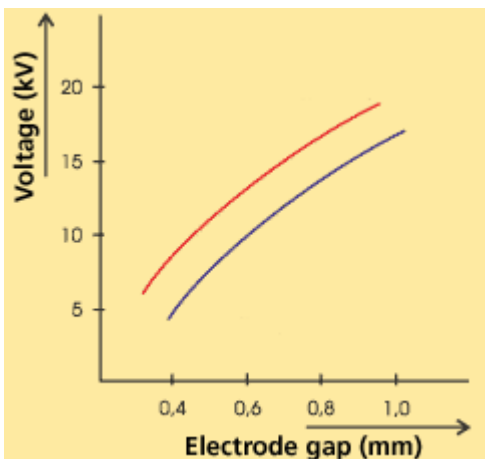

Electrical Conductivity comparison between precious metals used in Spark Plug technology. Electrical Conductivity plays a vital role in spark plug performance. The more efficient the conductivity the less strain that is put on your ignition system. This allows for a more potent / strong spark which is crucial for force induction, nitrous, high compression and hard to ignite alternative fuels.

ELECTRICAL CONDUCTIVITY MS/M

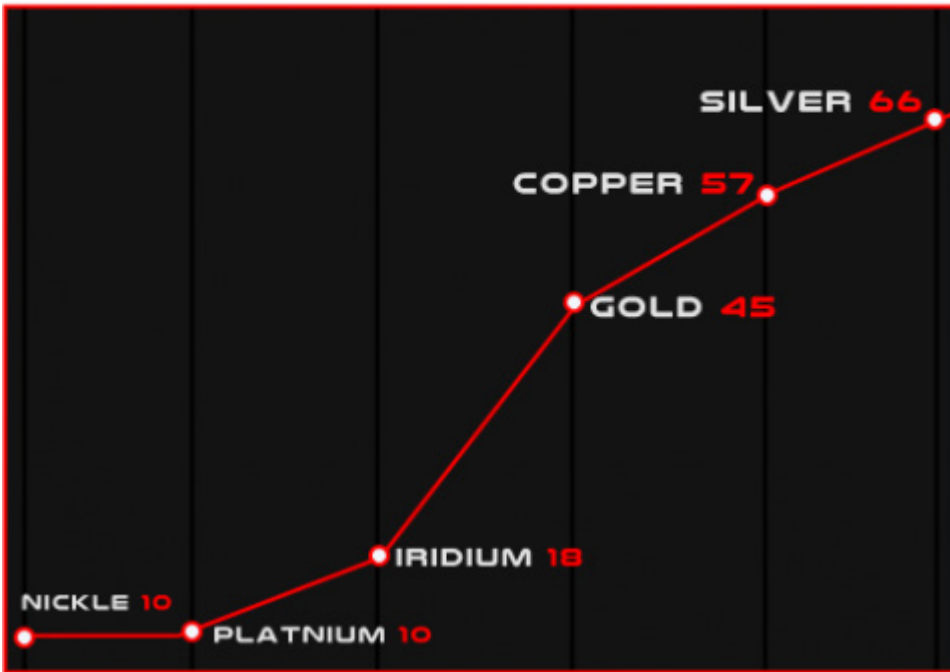

Thermal Conductivity comparison between precious metals used in Spark Plug technology. Thermal conductivity is vital to prevent pre-ignition detonation, aka "grenading", an engine and builders worst nightmare. The more efficiently a spark plug is able to dissipate the heat being accumulated, the less likely you are to occur pre-ignition detonation which can cause substantial damage to your high performance and racing engines.

THERMAL CONDUCTIVITY W/(M·K)



SPARK PLUG CROSS REFERENCE HEAT RANGE CHART

Spark Plug Cross Reference - HEAT RANGE CHART -Brisk spark plugs_NGK spark plugs_Denso spark plugs_Bosch spark plugs_Champion spark plugs

HEAT	HOT					
BRISK	8	10	12	14	15	17
NGK	10	9	8	7	6	5
DENSO	31	27	24	22	20	16
BOSCH	2, 07	3, 08	4	5	6, 7	8
CHAMPION	55, 57	4, 59	6, 61, 637, 8	9, 10	11, 12	

Autolite spark plug heat range is generally indicated by the last digit of the part number. Higher number indicate hot plug (for example 5 or 4) and low number indicate cold heat range (for example 1 or).

Spark plug heat range is the measure of how fast the spark plug tip dissipates combustion heat. **It must do this in a precise and controlled manner so the spark plug will:**

- Stay cool enough to avoid pre-ignition and/or electrode destruction due to detonation.
- Run hot enough to burn off combustion deposits that would otherwise collect on the sparkplug insulator tip and cause fouling, that leads to misfire.
- Adapt to specific engine characteristics and widely varying driving/load conditions.

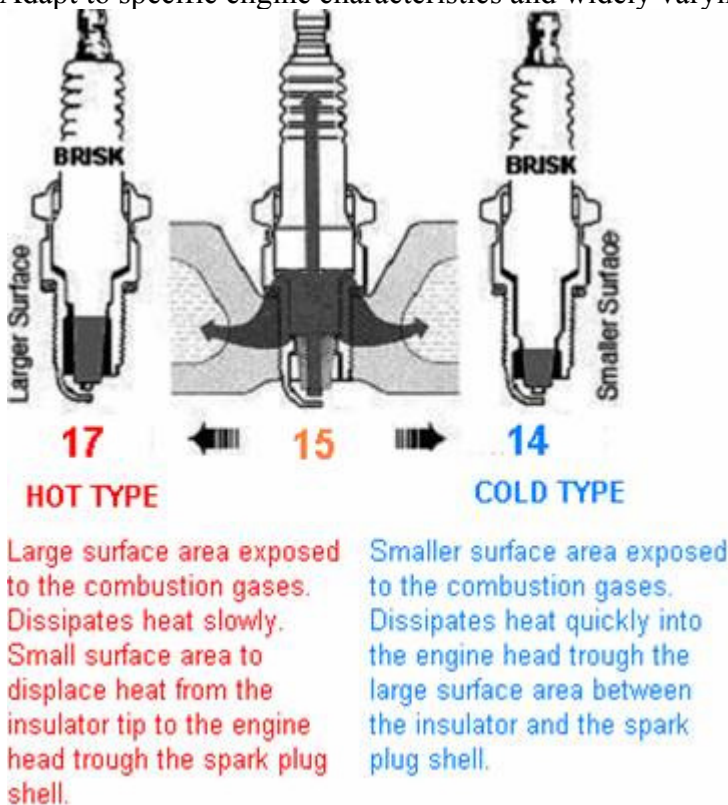

Why is Spark Plug Heat Range Critical?

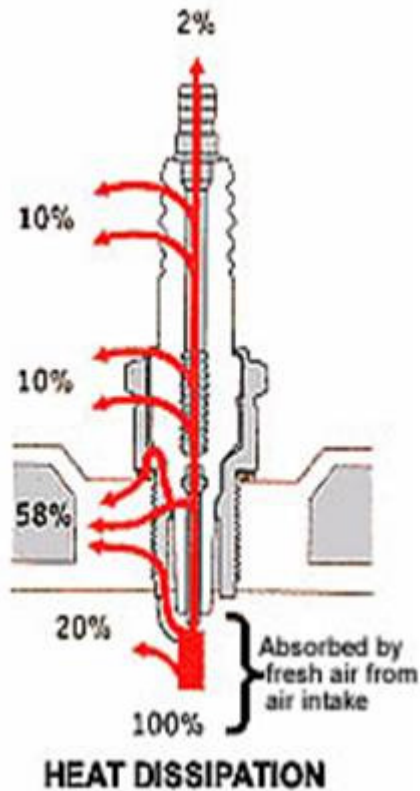

Two basic conditions for proper performance of a spark plug are given by **sufficient electrical insulation** between the center and ground electrodes, and **heat transfer** from the parts of the spark plug projected into the combustion chamber. Both conditions are directly related.

In order to ensure sufficient insulation between center and ground electrodes it is necessary, to keep the insulator tip (the part of the insulator projecting into the engine area) within an optimum temperature range. Insulator tip temperature is influenced by the proper choice of spark plug heat range. One heat range changes the spark plug insulator tip temperature by about 75 - 100 degree Celsius.

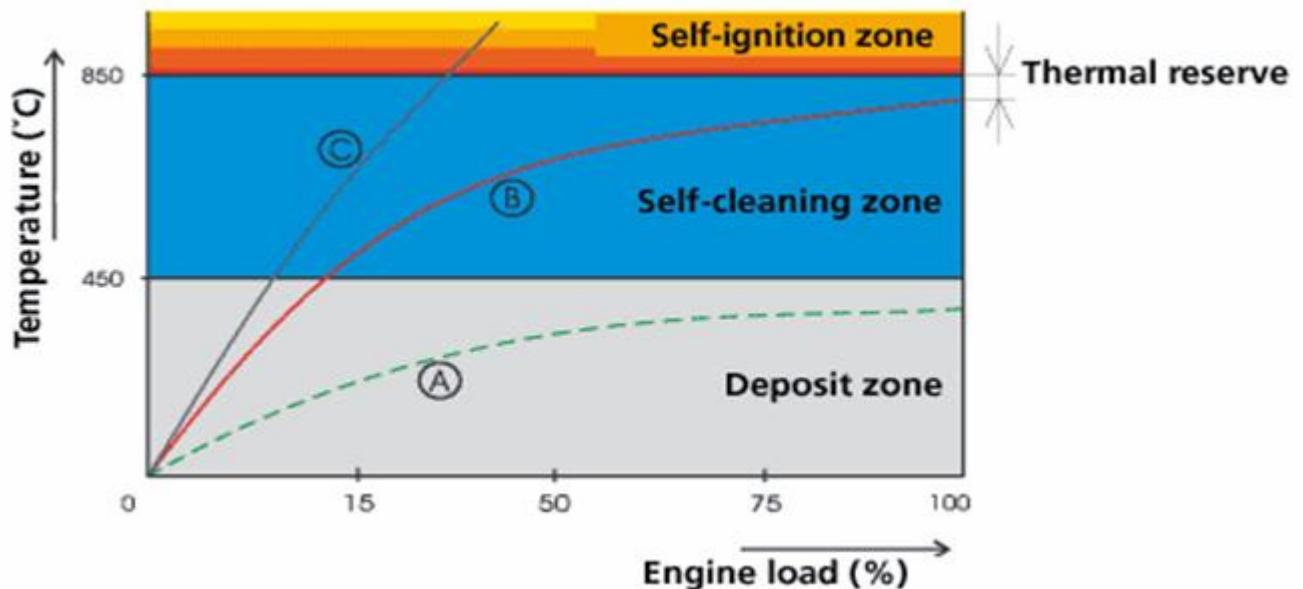

- A. Too cold spark plug for a given engine
- B. Suitable spark plug for a given engine
- C. Too hot spark plug for a given engine

If the insulator tip temperature drops into the so-called **deposit zone**, combustion deposits (carbon, non-combusted fuel, lubrication oil, impurities from the atmosphere) start to form on the insulator tip surface. A consequence of these combustion deposits on the insulator tip is **reduction in electrical insulation** resistance accompanied by failing ignitions and after a certain period of time even by a failure of the spark plug performance.

Providing a higher temperature of the insulator tip, no further combustion deposits are formed, but those already existing will not be burnt until the insulator tip temperature rises above 475 °C - the

so-called **self-cleaning zone**. In this temperature range, no new deposits are formed and those existing will be burnt. The spark plug operates in an **optimum manner**.

Too high temperature of the insulator tip is undesirable. High temperature results in pre-ignitions of the air-fuel mixture and further compression of the mixture already ignited leads to high temperature, which can cause serious damage to the engine.

In order to achieve the correct temperature of the insulator tip for a given engine, the spark plugs are produced in various thermal values. The range of thermal values for BRISK spark plugs extend from the warmest to the coldest, namely 19, 18, 17, 15, 14, 12, 10 and 08.

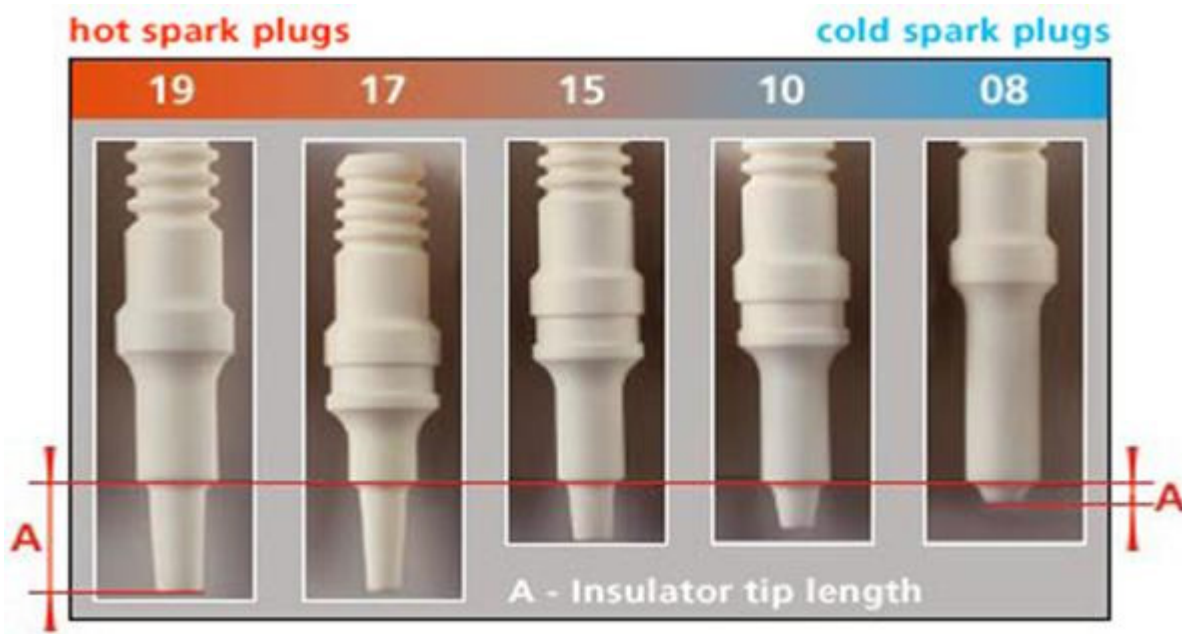

"Hot" spark plugs remove heat from the combustion area relatively slowly. They have a longer insulator tip and they achieve a temperature higher than the deposition zone relatively fast.

"Cold" spark plugs feature a relatively short insulator tip and they remove heat from the combustion area quite fast, in order to avoid advanced ignitions.

The choice of a proper heat range is very important. But even a spark plug featuring a properly selected heat range, is influenced by the processes of fouling and self-cleaning of the insulator tip. The setting of combustion deposits on the insulator tip is caused by an imperfect combustion due to a "rich" air/fuel mixture. On the other hand, the combustion deposits previously set will burn if the insulator tip temperature rises above 475 °C.

Zones of spark plug fouling and self-cleaning zone depending on the air/fuel ratio and on the spark plug insulator tip temperature.

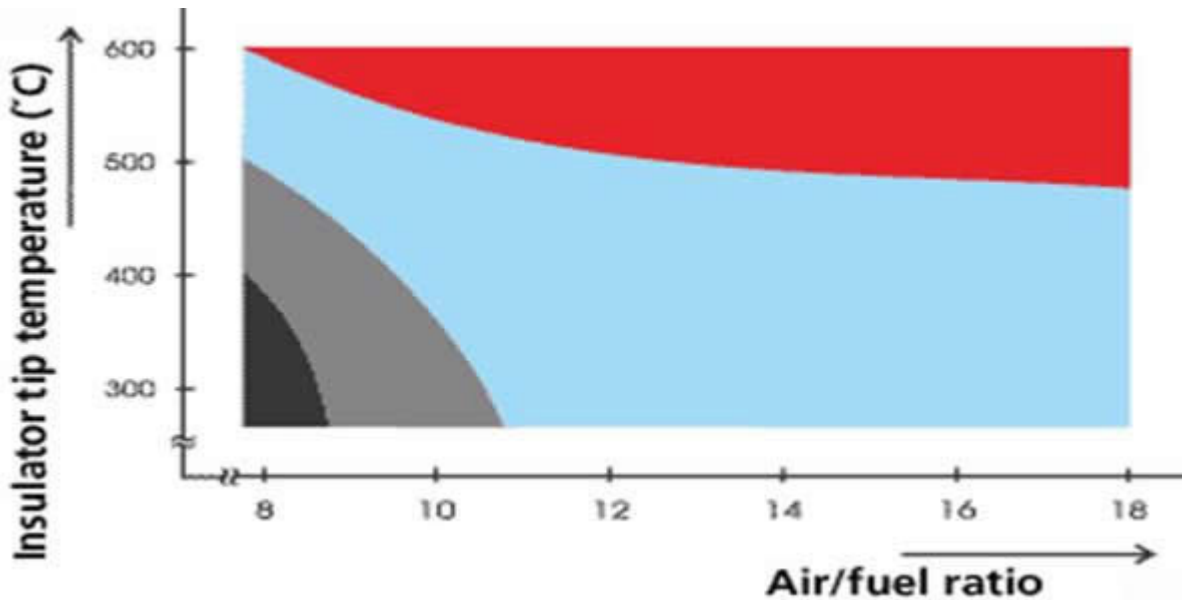

- Zone of fouling with non-evaporated fuel
- Zone of fouling with dry combustion deposits
- Inert zone
- Self-cleaning zone



Zone of fouling with non-evaporated fuel - this is the zone of the highest degree of fouling for spark plugs. The mixing ratio of fuel and air is very low in this case (rich mixture). Diffusion (atomization) of fuel is low and the fuel burns in its liquid state. Level of creation of combustion deposits is significant. In addition, the insulator tip is wet from the non-evaporated fuel. The decreasing insulation resistance of the insulator tip results in an occasional failure of ignition. Cold starts and frequent moving off from rest in cold weather will accelerate the fouling of the insulator tip.

Zone of fouling with soft deposits - vehicle engine run at idling speed or its low load can result in the setting of soft (dry) combustion deposits on the insulator tip, even if the fuel does not burn in liquid state.

Inert zone - in this zone, there does not occur any setting of combustion deposits on the insulator tip and there does not occur any self-cleaning either. No deposits set on the insulator tip surface even if the spark plug temperature drops below 500 0 C. The new spark plug does not feature any fouling and if a spark plug is fouled, it does not get cleaned.



Self-cleaning zone - The combustion deposits set in this zone on the insulator tip will burn and the insulation strength of the insulator tip will return to a common value. The shift into the self-cleaning zone generally takes place during acceleration and at higher speeds of the vehicle.

Determination of thermal value of a spark plug

While the engine is running, the spark plug is being heated to a certain temperature. The highest temperature can be detected at the insulator tip end. Thermal balance between the input and output of heat from the spark plug is determined by the value known as the spark plug heat range. An important parameter of this heat range is given by the so-called self-ignition value. It is measured by a special measuring engine by means of a gradual increase in the

supercharging pressure up to the initiation of self-ignitions of the spark plug. The self-ignitions are indicated with the help of the ionization method, than they are processed by the control system with a feedback to the engine control. The thermal load is expressed by the IMEP (Indicated Mean Effective Pressure lb/in²) units.

Determination of engine equipment with spark plugs

The equipment test of a particular engine is carried out with the help of special equipment making it possible to detect self-ignitions during an increase in spark advance in comparison with the original one, at a load of the engine. A part of the equipment tests is often formed by a starting capacity test carried out in a freezing chamber, as well as operation tests.

BASIC THEORY OF SPARK PLUG OPERATION

Basic Theory Of Spark Plug Operation



Basic function of ignition spark plug is to ignite the air and fuel mixture inside the combustion chamber. The resulting flame front expansion forces the piston from Top Dead Center to Bottom Dead Center. This process happens within 3 to 20 milliseconds depending on engine RPM. This piston movement is converted through the connecting rod and crankshaft into rotating kinetic energy. Speed and the expansion characteristic of the flame front directly effects the developed mean pressure in the combustion chamber, which acts on the piston and is converted into power. But ignition spark plug is also exposed to a very challenging environment. The temperature

inside of the combustion chamber reaches 2500 degrees Fahrenheit and the pressures reaching hundreds of MPa.

SPARK PLUG BASICS:

The spark plug has three primary functions:

Spark plug has to: Seals the combustion chamber

Spark plug has to: Ignite air/fuel mixture

Spark plug has to: Transfer heat from the combustion chamber

ELECTRICAL PERFORMANCE OF THE SPARK PLUG

Spark plugs carry electrical energy from the ignition coil and wire inside of the combustion chamber. Spark occurs between spark plug center and ground electrode- igniting the A/F mixture and turning fuel into working energy. A sufficient amount of voltage must be supplied by the ignition system and reach the spark plug in order to generate spark across the spark plug's gap. This is called "Electrical Performance" of the spark plug.

THERMAL PERFORMANCE OF THE SPARK PLUG

The temperature of the spark plug's firing end must be kept low enough to prevent pre-ignition, but high enough to prevent fouling. This is called "Thermal Performance" of the spark plug, and is determined by the spark plug heat range selected.

HEAT RANGE EXPLAINED - High Performance Brisk USA Spark Plugs

It is important to understand that the spark plugs does not create heat, they only remove heat from its tip to prevent it from getting too hot and glowing. The spark plug works as a heat exchanger by pulling unwanted thermal energy away from the tip of the spark plug, and transferring the heat to the engine's cylinder head and cooling system. The spark plug heat range is defined as a plug's ability to dissipate heat.

The rate of the spark plug heat transfer is determined by:

The spark plug ceramic insulator nose length

The spark plug gas volume around the ceramic insulator nose

The spark plug materials/construction of the center electrode and ceramic insulator

A spark plug's heat range has no relationship to the actual voltage transferred through the spark plug. Rather, the heat range is a measure of the spark plug's ability to remove heat from the spark plug center electrode and ceramic tip. The spark plug heat range measurement is determined by several factors; the length of the spark plug ceramic center insulator nose and its' ability to absorb and transfer combustion heat, the material composition of the spark plug insulator and center electrode material.

The spark plug ceramic insulator nose length is the distance from the firing tip of the ceramic insulator to the point where the spark plug ceramic insulator meets the metal spark plug shell. Since the insulator tip is the hottest part of the spark plug, the tip temperature is the primary factor in pre-ignition and fouling. Whether the spark plugs are fitted in a moped, boat, or a race car, the spark plug tip temperature must remain between 475-850°C in order to properly operate. If the spark plug tip temperature is lower than 475°C, the ceramic insulator area surrounding the center electrode will not be hot enough to burn off carbon and combustion chamber deposits which are conductive and “conduct away” some of the available voltage that is needed to generate the spark. These accumulated deposits can result in spark plug fouling leading to spark plug misfire due to insufficient voltage for spark to occur.

If the spark plug tip temperature is higher than 850°C the spark plug will overheat which may cause the ceramic around the center electrode to blister or crack and the electrodes to melt. This may lead to pre-ignition/detonation and expensive engine damage. In identical spark plug types, the difference from one heat range to the next is the ability to remove approximately 70°C to 100°C from the spark plug center electrode and ceramic tip. A projected style spark plug firing tip temperature is increased by about 15°C to 25°C.

The spark plug firing end appearance also depends on the spark plugs tip temperature. There are three basic diagnostic criteria for spark plugs: good, fouled and overheated. The temperature borderline between the fouling and optimum operating regions is 500°C. This temperature is called the spark plug self-cleaning temperature and is where the accumulated carbon and combustion deposits are burned off.

It is very important to keep in mind that the spark plug ceramic insulator nose length is a key-determining factor in the heat range of a spark plug. The longer the ceramic insulator nose is, the more ceramic nose surface area is exposed to the hot combustion gasses, and less heat is dissipated by the spark plug as the heat from the tip must travel further before it reach the spark plug metal shell and is transferred into the cylinder head water jackets. This means the plug has a higher internal temperature, and is said to be a hot spark plug. A hot spark plug maintains a higher internal operating temperature to burn off oil and carbon deposits, and has no relationship to spark quality or intensity.

Conversely, a cold spark plug has a shorter insulator nose, have less surface exposed to the hot combustion gases and dissipates more heat from the center electrode and ceramic tip as the heat from the tip does not need to travel as far to meet the metal shell and transfer into the cylinder head water jackets. This heat travels a shorter distance, and allows the plug to operate at a lower internal temperature. A colder heat range is necessary when the engine is modified for performance, subjected to heavy loads, or is run at a high rpm for a significant period of time. Colder spark plugs remove heat quicker, reducing the chance of pre-ignition/detonation. Failure

to use a cooler heat range in a modified application can lead to spark plug failure and severe engine damage.

Below is a list of external influences on a spark plug's operating temperature. The following symptoms or conditions may have an effect on the actual temperature of the spark plug. The spark plug cannot create these conditions, but it must be able to cope with the levels of heat...if not, the performance will suffer and engine damage can occur.

Air/Fuel Mixtures seriously affect engine performance and spark plug operating temperatures.

Rich air/fuel mixtures cause the spark plug tip temperature to drop, causing fouling and poor drivability

Lean air/fuel mixtures cause spark plug tip and cylinder temperature to increase, which may lead to pre-ignition, detonation, and possibly serious spark plug and engine damage

It is important to read spark plugs many times during the tuning process to achieve the optimum air/ fuel mixture

Higher Compression Ratios/Forced Induction will elevate spark plug tip and in-cylinder temperatures

Compression can be increased by performing any one of the following modifications:

a) reducing combustion chamber volume (i.e.: domed pistons, smaller chamber heads, milling heads, etc.)

b) Adding forced induction (Nitrous, Turbocharging or Supercharging)

c) camshaft change

*As compression increases, a colder heat range plug, **higher fuel octane**, and careful attention to ignition timing and air/fuel ratios are necessary. Failure to select a colder spark plug and adequate higher-octane fuel can lead to spark plug/engine damage*

Advancing Ignition Timing – dramatically increases the temperature in the combustion chamber

*Advancing ignition timing by 5-10° causes spark plug tip temperature **to increase** by approx. 70°-100° C*

Engine Speed and Load

Increases in firing-end temperature are proportional to engine speed and load. When traveling at a consistent high rate of speed, or carrying/pushing very heavy loads, a colder heat range spark plug should be installed

Ambient Air Temperature

As air temperature falls, air density/air volume becomes greater, resulting in leaner air/fuel mixtures.

This creates higher cylinder pressures/temperatures and causes an increase in the spark plug's tip temperature. So, fuel delivery should be increased.

As temperature increases, air density decreases, as does intake volume, fuel delivery should be decreased

Pre-ignition

Defined as: ignition of the air/fuel mixture before spark plug spark

Caused by hot spots in the combustion chamber...can be caused

(or amplified) by over advanced timing, low octane fuel, too hot a spark plug, lean air/fuel mixture, too high compression, or insufficient engine cooling

Pre-ignition spikes the combustion temperature dramatically and most often leads to detonation

A change to a higher-octane fuel, a colder plug, richer fuel mixture, or lower compression may be in order

You may also need to retard ignition timing, and check vehicle's cooling system

Pre-ignition usually leads to detonation; pre-ignition and detonation are two separate events

Combustion temperatures spike to over 3000°F during the combustion process (in a racing engine)

Detonation

The spark plug's worst enemy! (Besides fouling)

Can break spark plug ceramic insulators or break off ground electrodes. Most frequently caused by insufficient octane rating and hot spots in the combustion chamber.

Detonation occurs as propagating flame front further squeezes the yet unburned mixture in the combustion chamber to the point of self ignition and detonate => the unburned mixture self ignites spontaneously generally from a side of the piston which tends to be the hottest part in the combustion chamber. Sometimes the pre-ignition starts at the side of the piston and then the spark plug ignites secondary flame front. As the two flame fronts collide in the combustion chamber prior to the TDC maximum pressure and temperature occurs with the piston still trying to go up.

As the piston is being forced upward by mechanical action of the connecting rod, the pre-ignited explosion will try to force the piston downward. If the piston can't go up (because of the force of the premature explosion and or detonation) and it can't go down (because of the upward motion of the connecting rod), the piston will rattle from side to side. The resulting shock wave causes an audible pinging sound. Most of the damage than an engine sustains when "detonating" is from excessive heat and pressure.

The spark plug is damaged by both – the elevated temperatures and the accompanying shock wave, or concussion. Prolonged pre-ignition and/or detonation will burn a hole through the piston; bend rod and can completely destroy the engine.

Misfires

A spark plug is said to have misfired when enough voltage has not been delivered to light off all fuel present in the combustion chamber at the proper moment of the power stroke (a few degrees before top dead center)

A spark plug can deliver a weak spark (or no spark at all) for a variety of reasons...defective coil, too much compression with incorrect spark plug gap, dry fouled or wet fouled spark plugs, insufficient ignition timing, etc.

Slight misfires can cause a loss of performance for obvious reasons (if fuel is not lit, no energy is being created)

Some people believe that the spark plug will either ignite the mixture or will not. They believe there is nothing in between. This belief is incorrect. Most modern OBD-II engines can even calculate the % of misfire from the crankshaft position sensor by evaluating the crank angle speed million times per second. On some vehicles the check engine will illuminate with the P0300 (random misfire) code or specific cylinder misfire code P0301- P0312) if just 10% cylinder misfire is

detected which is sometimes far before average driver even notice that there is something not quite right with the engine.

Severe misfires will cause poor fuel economy, poor drivability, and if prolonged even catalytic convertor damage.

Fouling

Will occur when spark plug tip temperature is insufficient to burn off carbon, fuel, oil or other deposits

Will cause spark to leach to metal shell...no spark across plug gap will cause a misfire

Wet-fouled spark plugs must be changed...spark plugs will not fire

Dry-fouled spark plugs can sometimes be cleaned by bringing engine up to operating temperature or driving for few minutes in a low gear

Light media blasting can be also used, but only lightly on the ceramic insulator tip of the center electrode, and extreme caution should be paid to blow-off all the remaining media from the spark plug after the cleaning. Liquid cleaners of any type should not be used for cleaning spark plugs, as they tend to imbed into the ceramic insulator and hamper it's dielectric properties.

Before changing fouled spark plugs, be sure to eliminate root cause of fouling

SPARK PLUGS IDENTIFICATION & CONSTRUCTION

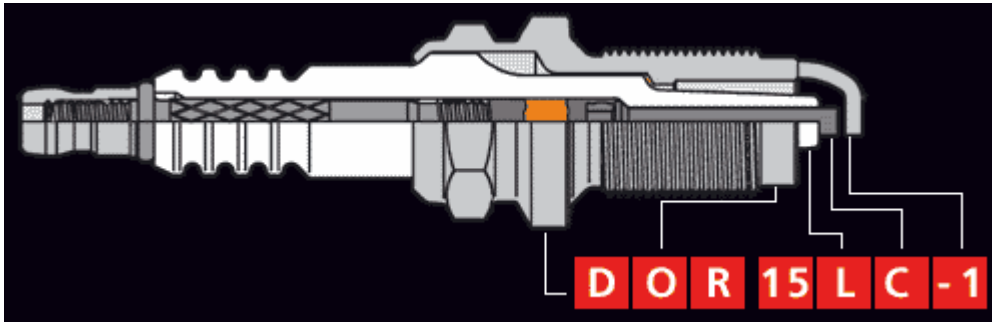

D Spark Plug Shell dimensions (the first letter of the part number)

O Metal shell projected into combustion chamber

- O** Complies with relevant ISO standard
- O** Does not comply with relevant ISO standard

R Spark Plugs Interference suppressor (resistor)

- R** No interference suppression
- R** Interference suppression
- X** Resistor reducing electrode burn-off

15 Spark Plug Heat range

Hot				Cold				
19	18	17	16	15	14	12	10	08

L Spark gap design

- Y** Not projected insulator tip
- Y** Projected insulator tip
- L** Extremely projected insulator tip
- T** Projected insulator tip and three ground electrodes EXTRA
- LG** Extremely projected insulator tip and ring-shaped spark gap PREMIUM
- Z** Two auxiliary electrodes on the insulator tip and ring-shaped electrode gap PREMIUM
- TX** One auxiliary electrode on the insulator tip and three ground electrodes PREMIUM
- LT** Extremely projected insulator tip and three ground electrodes EXTRA

C Spark Plug Elektrode material

- C** Nickel-alloy centre electrode
- C** Copper cored centre electrode SUPER
- S** Silver centre electrode SILVER
- P** Centre electrode with platinum contact PLATIN
- PP** Centre and ground electrode with platinum contact PLATIN

-1 Spark gap

- 1** 0,4 - 0,9 mm
- 05** 0,5 mm
- 1** 1,0 - 1,1 mm
- 3** 1,3 mm
- X** Special

Spark Plug Shell Dimensions

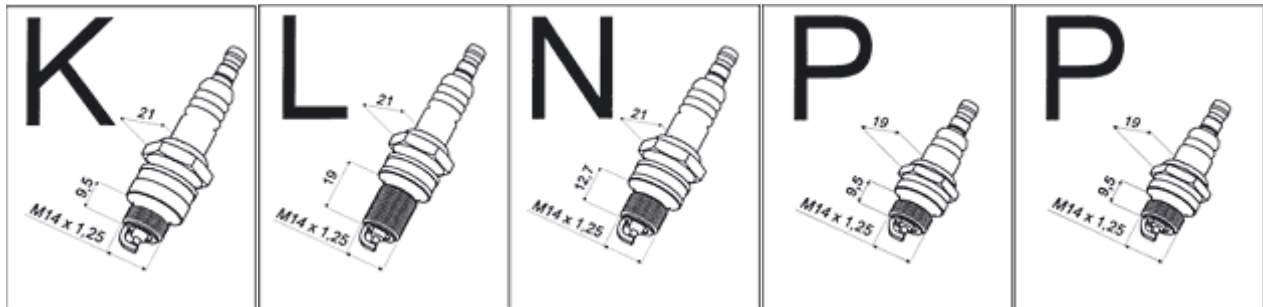
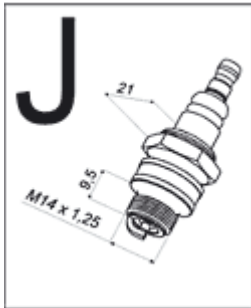
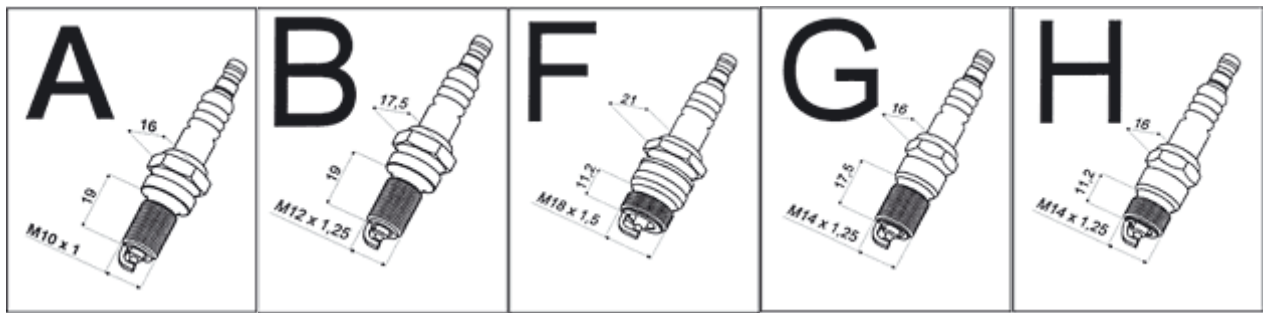

SPARK PLUGS CYLINDER HEAD APPLICATION GUIDE AND BRISK SPARK PLUG ASSORTMENT GUIDE





CYLINDER HEAD CROSS REFERENCE GUIDE









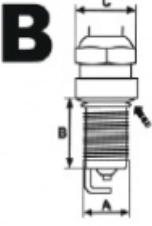

CYLINDER HEAD MANUFACTURER	SPEC SHEET RECOMMENDATION	BRISK EQUIVALENT RACING PLUGS
AIR FLOW RESEARCH		
205cc LS1 Mongoose Street Head	AC 41-974 Platinum	GR15YS, GOR15LGS, GR15ZC, GOR15YTE
225cc LS1 Mongoose Strip Head	AC 41-974 Platinum	GR15YS, GOR15LGS, GR15ZC, GOR15YTE
180cc SBC Street Head	AC FR3LS	DR15YS, DOR15LGS, DR15ZC, DOR15YTE
180cc LT1 Street Head	AC FR3LS	DR15YS, DOR15LGS, DR15ZC, DOR15YTE
195cc SBC Street Head	AC FR3LS	DR15YS, DOR15LGS, DR15ZC, DOR15YTE
195cc LT4 Street Head	AC FR3LS	DR15YS, DOR15LGS, DR15ZC, DOR15YTE
305/315/325/335/345/357cc Magnum BBC	CHA C59C/AUT 3924	D10S, DO10LGS-T (index free plug)
165/185cc SBF Outlaw Street Heads	AUT 3924	DR15YS, DOR15LGS, DR15ZC, DOR15YTE
205/224cc SBF Outlaw Race Heads	AUT 3922	DR14YS, or DR14S (non-projected tip)
165/185cc SBF Street/Strip Outlaw Heads	AUT 3924	DR15YS, DOR15LGS, DR15ZC, DOR15YTE
BRODIX		
BBC, Big Brodie Series	NGK B9ES	gas L115L, L105L Alcohol
C.A.R.B. Legal Heads	CHA 14YC or AUT 3924	DR15YS, DOR15LGS, DR15ZC, DOR15YTE
DART		
Big Chief, All	.750" reach, gasket, CHA C57C/C57YC	D08S, DO10LGS-T (index free plug)
Big M-Head	.750" reach, gasket, CHA C59C/C59YC Street RC12YC	D10S, Street app, DR15YS
Ford 20 Degree	.750" reach, gasket, CHA C59C/C59YC	D10S, DO10LGS-T (index free plug)
Iron Eagle, 308cc & 345cc BBC	.750" reach, gasket, CHA C59C/C59YC Street RC12YC	D10S, Street app, DR15YS
Iron Eagle, 23 Degree, 180, 200, 215, 230cc SBC	Angle or Straight, 460" Reach, Tapered Seat, CHA V59C/V59YC	H08S, HO11LGS-T (index free plug)
Iron Eagle S/S	Straight, 460" Reach, Tapered Seat, CHA RV12YC/AQC R44TS	HR17YTE (stubby), HOR15LGS, HR14YS
Little Chief, 11 Degree SBC Head	CHA C57C/C57YC	D08S, DO10LGS-T (index free plug)
Pro 1, 23 Degree SBC & BBC all cc's	CHA C59C/C59YC	D10S, DO10LGS-T (index free plug)
Race Series, 220cc SBC Head	CHA C59C/C59YC	D10S, DO10LGS-T (index free plug)
Race Series, 18 Degree BBC Head	CHA C57C/C57YC	D08S, DO10LGS-T (index free plug)
EDELBRÖCK		
All Except Flathead		DR15YS, DOR15LGS, DR15ZC, DOR15YTE
FORD RACING PERFORMANCE PARTS		
GT-40 "Turbo-Swirl" Alum. Cyl Heads		DR14YS, DOR14LGS, DR14ZC
GT-40X "Turbo-Swirl" Alum Cyl Heads		DR14YS, DOR14LGS, DR14ZC
"Sportsman" Short Track Cast Iron Cyl Heads		HR14YS, HOR14LGS, HO14LGS
"Z" Aluminum Heads		DOR15LGS
Robert Yates Alum. Cyl Heads		L- style sparkplug (13/16hex, 14mm, gasket)
"High Port" Yates Head		L- style sparkplug (13/16hex, 14mm, gasket)
High Port Head for all out Performance		L- style sparkplug (13/16hex, 14mm, gasket)
Super Cobra Jet Cylinder Heads		DR14YS, DOR14LGS, DR14ZC
PRO TOPLINE		
Iron Lightning, Pro Lightning	CHA V55C, V57C	H08S, HO11LGS-T (index free plug)
Other	CHA C55C, C57C	D08S, DO10LGS-T (index free plug)
TRICK FLOW		
Track Heat Alum. Cyl. Heads for SB Ford	AC FR3LS, AUT 3924, NGK 7373	DR15YS, DOR15LGS, DR15ZC, DOR15YTE
18 Degree Alum. Heads for SB Chevy	CHA C57C, NGK R5671A-10	D08S, DO10LGS-T (index free plug)
23 Degree Alum. Heads for SB Chevy	AC FR3LS, AUT 3924, NGK FR5, CHA RC	DR15YS, DOR15LGS, DR15ZC, DOR15YTE
R-Series Cyl. Head for BB Chevy	AUT 3922	DR14YS, DOR14LGS, DR14ZC
WORLD		
Windsor Jr		HR14YS, HOR14LGS, HO14LGS
Windsor Jr. Lite		DR15YS, DR14YS, DOR14LGS, DR14ZC
Windsor Sr. Lite		DR15YS, DR14YS, DOR14LGS, DR14ZC
Rough 200 Cast Iron		HR14YS, HOR14LGS, HO14LGS
Torquer 440 Aluminum		D10S, DO10LGS-T (index free plug), D08S
Sportsman II Lite		DR15YS, DR14YS, DOR14LGS, DR14ZC
S/R		HR17YTE (stubby), HOR15LGS, HR14YS
S/R Torquer		HR17YTE (stubby), HOR15LGS, HR14YS
Sportsman II		HR17YTE (stubby), HOR15LGS, HR14YS
Motown 205/220		HR17YTE (stubby), HOR15LGS, HR14YS
Motown 220 Lite		DR15YS, DR14YS, DOR14LGS, DR14ZC
Merlin II Oval & Rect. Port		HR17YTE (stubby), HOR15LGS, HR14YS
320cc & 345cc Merlin		DR15YS, DR14YS, DOR14LGS, DR14ZC





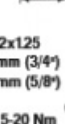

WARNING: Cross reference is provided for convenience only!
Prior installation please confirm spark plug recommendation
with cylinder head manufacturer and/or engine builder/tuner



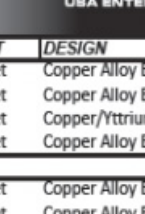

BRISK
USA ENTERPRISES, LLC











		A	GAP (mm)	MANUFACTURER HEAT RANGES									
				BRISK	10	12	14	15			17		
TYP		obj.	0.7	10	9	8	7	6	5				
			0.7	31	27	24	22	20	16				
				THREAD	REACH	HEXAGON	SEAT	DESIGN	RESISTOR	PROJECTED			
A  <p>A - M10x1.00 B - 19mm (3/4") C - 16mm (5/8")</p> <p>10-15 Nm 7-11 lb.ft.</p>	silver	.S	AR10S	1495	0.7	10mm	19mm-3/4"	16mm-5/8"	gasket	Silver Center Electrode	no	no	
		A08S	1517	0.7	10mm	19mm-3/4"	16mm-5/8"	gasket	Silver Center Electrode	no	no		
		AR10S	1517	0.7	10mm	19mm-3/4"	16mm-5/8"	gasket	Silver Center Electrode	yes	no		
		AR08S	1516	0.7	10mm	19mm-3/4"	16mm-5/8"	gasket	Silver Center Electrode	yes	no		
		.YS	A14YS		0.7	10mm	19mm-3/4"	16mm-5/8"	gasket	Silver Center Electrode	no	yes	
		A12YS		0.7	10mm	19mm-3/4"	16mm-5/8"	gasket	Silver Center Electrode	no	yes		
	AR14YS	1519	0.7	10mm	19mm-3/4"	16mm-5/8"	gasket	Silver Center Electrode	yes	yes			
	AR12YS	1518	0.7	10mm	19mm-3/4"	16mm-5/8"	gasket	Silver Center Electrode	yes	yes			
	.GS	AR08GS	1515	0.7	10mm	19mm-3/4"	16mm-5/8"	gasket	Silver-Surface Discharge	yes	no		
	premium	.LGS	AOR14LGS	3090	0.7	10mm	19mm-3/4"	16mm-5/8"	gasket	Lamborghini Design	yes	semi	
		AOR12LGS	1514	0.7	10mm	19mm-3/4"	16mm-5/8"	gasket	Lamborghini Design	yes	semi		
		AOR10LGS	1513	0.7	10mm	19mm-3/4"	16mm-5/8"	gasket	Lamborghini Design	yes	no		
.ZS		AR12ZS	1208	0.7	10mm	19mm-3/4"	16mm-5/8"	gasket	Multi-Spark	yes	yes		
AR10ZS		1181	0.7	10mm	19mm-3/4"	16mm-5/8"	gasket	Multi-Spark	yes	yes			
AR08ZS		1180	0.7	10mm	19mm-3/4"	16mm-5/8"	gasket	Multi-Spark	yes	yes			
NA  <p>A - M10x1.00 B - 12.7mm (1/2") C - 16mm (5/8")</p> <p>10-15 Nm 7-11 lb.ft.</p>	silver	.YS	NAR15YS		0.7	10mm	12.7mm-1/2"	16mm-5/8"	gasket	Silver Center El.	yes	yes	
		NAR14YS		0.7	10mm	12.7mm-1/2"	16mm-5/8"	gasket	Silver Center El.	yes	yes		
		NAR12YS		0.7	10mm	12.7mm-1/2"	16mm-5/8"	gasket	Silver Center El.	yes	yes		
	premium	NAOR.LGS	NAOR15LGS		0.7	10mm	12.7mm-1/2"	16mm-5/8"	gasket	Lamborghini Design	yes	semi	
		NAOR14LGS		0.7	10mm	12.7mm-1/2"	16mm-5/8"	gasket	Lamborghini Design	yes	semi		
		NAOR12LGS		0.7	10mm	12.7mm-1/2"	16mm-5/8"	gasket	Lamborghini Design	yes	semi		
		NAOR10LGS		0.7	10mm	12.7mm-1/2"	16mm-5/8"	gasket	Lamborghini Design	yes	no		
		NAR											



 B A - M12x125 B - 19mm (3/4") C - 16mm (5/8")  15-20 Nm  11-17 lb.ft		B		GAP (mm)		MANUFACTURER HEAT RANGES						
						 						
TYP	obj. c.	GAP (mm)		THREAD	REACH	HEXAGON	SEAT	DESIGN	RESISTOR	PROJECTED		
	super 	..C	B14C	1548	0.7	12mm	19mm-3/4"	18mm-11/16"	gasket	Copper Alloy Electrode	no	no
			B12C	1547	0.7	12mm	19mm-3/4"	18mm-11/16"	gasket	Copper Alloy Electrode	no	no
			B10C	1549	0.7	12mm	19mm-3/4"	16mm-5/8"	gasket	Copper/Yttrium Alloy El.	no	no
			B10C	1511	0.7	12mm	19mm-3/4"	18mm-11/16"	gasket	Copper Alloy Electrode	no	no
	silver 	..YC	B14YC	1487	0.6	12mm	19mm-3/4"	16mm-5/8"	gasket	Copper Alloy Electrode	no	yes
			B12YC	1469	0.7	12mm	19mm-3/4"	16mm-5/8"	gasket	Copper Alloy Electrode	no	yes
			BR15YC	1527	0.6	12mm	19mm-3/4"	16mm-5/8"	gasket	Copper Alloy Electrode	yes	yes
			BR14YC	1526	0.6	12mm	19mm-3/4"	16mm-5/8"	gasket	Copper Alloy Electrode	yes	yes
			BR14YC-9	1569	0.9	12mm	19mm-3/4"	16mm-5/8"	gasket	Copper Alloy Electrode	yes	yes
			BR12YC	1523	0.6	12mm	19mm-3/4"	16mm-5/8"	gasket	Copper Alloy Electrode	yes	yes
	platinum 	..S	B14S	1504	0.7	12mm	19mm-3/4"	16mm-5/8"	gasket	Silver Center Electrode	no	no
			B12S	1504	0.7	12mm	19mm-3/4"	16mm-5/8"	gasket	Silver Center Electrode	no	no
			B10S	1502	0.7	12mm	19mm-3/4"	16mm-5/8"	gasket	Silver Center Electrode	no	no
			B08S	1502	0.7	12mm	19mm-3/4"	16mm-5/8"	gasket	Silver Center Electrode	no	no
			BR14S	1525	0.7	12mm	19mm-3/4"	16mm-5/8"	gasket	Silver Center Electrode	yes	no
			BR12S	1522	0.7	12mm	19mm-3/4"	16mm-5/8"	gasket	Silver Center Electrode	yes	no
			BR10S	1520	0.7	12mm	19mm-3/4"	16mm-5/8"	gasket	Silver Center Electrode	yes	no
			BR10YS	1509	0.7	12mm	19mm-3/4"	16mm-5/8"	gasket	Silver Center Electrode	yes	yes
			BR10YS-9	1521	0.9	12mm	19mm-3/4"	16mm-5/8"	gasket	Silver Center Electrode	yes	yes
			BR12YC-9	1568	0.9	12mm	19mm-3/4"	16mm-5/8"	gasket	Copper Alloy Electrode	yes	yes
premium 	..YPP	BR12YPP	1524	0.7	12mm	19mm-3/4"	16mm-5/8"	gasket	Platin / Yttrium	yes	yes	
		..LGS	BOR14LGS	3093		12mm	19mm-3/4"	16mm-5/8"	gasket	Lamborghini Design	yes	semi
			BOR12LGS	3092		12mm	19mm-3/4"	16mm-5/8"	gasket	Lamborghini Design	yes	semi
			BOR10LGS	3091		12mm	19mm-3/4"	16mm-5/8"	gasket	Lamborghini Design	no	semi
..ZS	BR12ZS	1161		12mm	19mm-3/4"	16mm-5/8"	gasket	Multi-Spark	yes	yes		
	BR10ZS	1159		12mm	19mm-3/4"	16mm-5/8"	gasket	Multi-Spark	yes	yes		
	BR08ZS			12mm	19mm-3/4"	16mm-5/8"	gasket	Multi-Spark	yes	yes		
..ZC	BR14ZC	1165		12mm	19mm-3/4"	16mm-5/8"	gasket	Multi-Spark Copper	yes	yes		
	BR12ZC	1163		12mm	19mm-3/4"	16mm-5/8"	gasket	Multi-Spark Copper	yes	yes		



 C A - M10x100 B - 26.5mm (1.05") C - 14mm (9/16")  10-15 Nm  7-11 lb.ft		C		GAP (mm)		MANUFACTURER HEAT RANGES						
						 						
TYP	obj. c.	GAP (mm)		THREAD	REACH	HEXAGON	SEAT	DESIGN	RESISTOR	PROJECTED		
	..YS	CR10YS			10mm	26.5mm-1.05"	14mm-9/16"	gasket	Silver Center Electrode	yes	yes	



D		MANUFACTURER HEAT RANGES		 USA ENTERPRISES, LLC								
		BRISK	NGK								DENSO	8
TYP		obi	ç	GAP (mm)								
				THREAD	REACH	HEXAGON	SEAT	DESIGN	RESISTOR	PROJECTED		
 A - M14x1.25 B - 19mm (3/4") C - 16mm (5/8")	 super	..YC	D17YC	1359	0.7	14mm	19mm-3/4"	16mm-5/8"	gasket	Copper Alloy Electrode	no	yes
		D15YC	1358	0.7	14mm	19mm-3/4"	16mm-5/8"	gasket	Copper Alloy Electrode	no	yes	
		D15YC-1	1382	1.1	14mm	19mm-3/4"	16mm-5/8"	gasket	Copper Alloy Electrode	no	yes	
		D14YC	1357	0.7	14mm	19mm-3/4"	16mm-5/8"	gasket	Copper Alloy Electrode	no	yes	
		D12YC	1482	0.7	14mm	19mm-3/4"	16mm-5/8"	gasket	Copper Alloy Electrode	no	yes	
		DR17YC	1326	0.7	14mm	19mm-3/4"	16mm-5/8"	gasket	Copper Alloy Electrode	yes	yes	
		DR17YC-9	1571	0.9	14mm	19mm-3/4"	16mm-5/8"	gasket	Copper Alloy Electrode	yes	yes	
		DR17YC-1	1364	1.1	14mm	19mm-3/4"	16mm-5/8"	gasket	Copper Alloy Electrode	yes	yes	
		DR15YC	1327	0.7	14mm	19mm-3/4"	16mm-5/8"	gasket	Copper Alloy Electrode	yes	yes	
		DR15YC-9	1570	0.9	14mm	19mm-3/4"	16mm-5/8"	gasket	Copper Alloy Electrode	yes	yes	
		DR15YC-1	1317	1.1	14mm	19mm-3/4"	16mm-5/8"	gasket	Copper Alloy Electrode	yes	yes	
		DR14YC	1366	0.7	14mm	19mm-3/4"	16mm-5/8"	gasket	Copper Alloy Electrode	yes	yes	
DR14YC-1	1379	1.1	14mm	19mm-3/4"	16mm-5/8"	gasket	Copper Alloy Electrode	yes	yes			
DR12YC	1466	0.7	14mm	19mm-3/4"	16mm-5/8"	gasket	Copper Alloy Electrode	yes	yes			
 extra	..TC	DR17TC	1345	0.8	14mm	19mm-3/4"	16mm-5/8"	gasket	Triple Ground Electrodes	yes	yes	
	DR17TC-1	1346	1.1	14mm	19mm-3/4"	16mm-5/8"	gasket	Triple Ground Electrodes	yes	yes		
	DR15TC	1329	0.8	14mm	19mm-3/4"	16mm-5/8"	gasket	Triple Ground Electrodes	yes	yes		
	DR15TC-1	1328	1.1	14mm	19mm-3/4"	16mm-5/8"	gasket	Triple Ground Electrodes	yes	yes		
	DR14TC	1384	0.8	14mm	19mm-3/4"	16mm-5/8"	gasket	Triple Ground Electrodes	yes	yes		
	DR14TC-1	1385	1.1	14mm	19mm-3/4"	16mm-5/8"	gasket	Triple Ground Electrodes	yes	yes		
	DOR15YTE-1	1377	1.1	14mm	19mm-3/4"	16mm-5/8"	gasket	Triple Ground El. Yttrium	yes	yes		
DO15YTE	1377	1.1	14mm	19mm-3/4"	16mm-5/8"	gasket	Triple Ground El. Yttrium	no	yes			
 extra turbo	DOR..TS	DOR14TS	1363	0.6	14mm	19mm-3/4"	16mm-5/8"	gasket	Triple Ground Electrodes	yes	yes	
	DOR10TS	1363	0.6	14mm	19mm-3/4"	16mm-5/8"	gasket	Triple Ground Electrodes	yes	yes		
	DOR08TS-05	1363	0.5	14mm	19mm-3/4"	16mm-5/8"	gasket	Triple Ground Electrodes	yes	special-semi		

D		MANUFACTURER HEAT RANGES		 USA ENTERPRISES, LLC								
		BRISK	NGK								DENSO	8
TYP		obi	ç	GAP (mm)								
				THREAD	REACH	HEXAGON	SEAT	DESIGN	RESISTOR	PROJECTED		
 A - M14x1.25 B - 19mm (3/4") C - 16mm (5/8")	 extra turbo	DOR..DS	DOR14DS	1343	0.6	14mm	19mm-3/4"	16mm-5/8"	gasket	Dual Ground Electrodes	yes	yes
		DOR12DS	1343	0.6	14mm	19mm-3/4"	16mm-5/8"	gasket	Dual Ground Electrodes	yes	yes	
		DOR10DS	1343	0.6	14mm	19mm-3/4"	16mm-5/8"	gasket	Dual Ground Electrodes	yes	yes	
		DOR08DS	1343	0.6	14mm	19mm-3/4"	16mm-5/8"	gasket	Dual Ground Electrodes	yes	special-semi	
	 extra	DOX..	DOX15LE	1343	0.9	14mm	19mm-3/4"	16mm-5/8"	gasket	Yttrium Electrodes	yes	extra-projected
		DOX15LE-1	1501	1.1	14mm	19mm-3/4"	16mm-5/8"	gasket	Yttrium Electrodes	yes	extra-projected	
	 silver	..S	D12S	1143	0.7	14mm	19mm-3/4"	16mm-5/8"	gasket	Silver Center Electrode	no	no
		D10S	1143	0.7	14mm	19mm-3/4"	16mm-5/8"	gasket	Silver Center Electrode	no	no	
		D08S	1143	0.7	14mm	19mm-3/4"	16mm-5/8"	gasket	Silver Center Electrode	no	no	
		DR14S	1143	0.7	14mm	19mm-3/4"	16mm-5/8"	gasket	Silver Center Electrode	yes	no	
		DR12S	1142	0.7	14mm	19mm-3/4"	16mm-5/8"	gasket	Silver Center Electrode	yes	no	
		DR10S	1142	0.7	14mm	19mm-3/4"	16mm-5/8"	gasket	Silver Center Electrode	yes	no	
 silver	..YS	DR17YS	1351	0.7	14mm	19mm-3/4"	16mm-5/8"	gasket	Silver Center Electrode	yes	yes	
	DR17YS-9	1463	0.9	14mm	19mm-3/4"	16mm-5/8"	gasket	Silver Center Electrode	yes	yes		
	DR15YS	1334	0.7	14mm	19mm-3/4"	16mm-5/8"	gasket	Silver Center Electrode	yes	yes		
	DR15YS-9	1462	0.9	14mm	19mm-3/4"	16mm-5/8"	gasket	Silver Center Electrode	yes	yes		
	DR14YS	1352	0.7	14mm	19mm-3/4"	16mm-5/8"	gasket	Silver Center Electrode	yes	yes		
	DR14YS-9	1461	0.9	14mm	19mm-3/4"	16mm-5/8"	gasket	Silver Center Electrode	yes	yes		
 silver	DOR..YS	DR12YS	1546	0.7	14mm	19mm-3/4"	16mm-5/8"	gasket	Silver Center Electrode	yes	yes	
	DOR15YS	1302	0.7	14mm	19mm-3/4"	16mm-5/8"	gasket	Silver Center Electrode	yes	yes		
DOR12YS-1	1553	1.1	14mm	19mm-3/4"	16mm-5/8"	gasket	Silver Center Electrode	yes	yes			



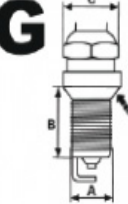

D		MANUFACTURER HEAT RANGES		BRISK USA ENTERPRISES, LLC								
		BRISK	NGK					DENSO	DENSO			
TYP		obj. č.	GAP (mm)	THREAD	REACH	HEXAGON	SEAT	DESIGN	RESISTOR	PROJECTED		
 <p>A - M14x125 B - 19mm (3/4") C - 16mm (5/8")</p> <p>20-30 Nm 14-22 lb.ft.</p>	platinum	DR17YP	1402	0.8	14mm	19mm-3/4"	16mm-5/8"	gasket	Double Platinum	yes	yes	
		DR17YP-1	1403	1.1	14mm	19mm-3/4"	16mm-5/8"	gasket	Double Platinum	yes	yes	
		DR15YP	1400	0.8	14mm	19mm-3/4"	16mm-5/8"	gasket	Double Platinum	yes	yes	
		DR15YP-1	1401	1.1	14mm	19mm-3/4"	16mm-5/8"	gasket	Double Platinum	yes	yes	
		DR14YP	1425	0.8	14mm	19mm-3/4"	16mm-5/8"	gasket	Double Platinum	yes	yes	
		DR14YP-1	1426	1.1	14mm	19mm-3/4"	16mm-5/8"	gasket	Double Platinum	yes	yes	
		DR12YP	1508	0.8	14mm	19mm-3/4"	16mm-5/8"	gasket	Double Platinum	yes	yes	
		DOR17LGS	3027		14mm	19mm-3/4"	16mm-5/8"	gasket	Lamborghini Design	yes	yes	
		DOR15LGS	3026		14mm	19mm-3/4"	16mm-5/8"	gasket	Lamborghini Design	yes	yes	
		DOR15LGS-T			14mm	19mm-3/4"	16mm-5/8"	gasket	Lambo Design small gap	yes	yes	
	DOR14LGS	3025		14mm	19mm-3/4"	16mm-5/8"	gasket	Lamborghini Design	yes	yes		
	DOR14LGS-T			14mm	19mm-3/4"	16mm-5/8"	gasket	Lambo Design small gap	yes	yes		
	DOR12LGS	3032		14mm	19mm-3/4"	16mm-5/8"	gasket	Lamborghini Design	yes	yes		
	DOR11LGS			14mm	19mm-3/4"	16mm-5/8"	gasket	Lamborghini Design	yes	no		
	DOR10LGS			14mm	19mm-3/4"	16mm-5/8"	gasket	Lamborghini Design	yes	no		
	DO 10LGS-T			14mm	19mm-3/4"	16mm-5/8"	gasket	Lambo Design small gap	no	no		
	DOR08LGS			14mm	19mm-3/4"	16mm-5/8"	gasket	Lamborghini Design	yes	no		
	premium	.ZC	DR15ZC	1126		14mm	19mm-3/4"	16mm-5/8"	gasket	Multi-Spark	yes	yes
			DR15ZC-1	1134		14mm	19mm-3/4"	16mm-5/8"	gasket	Multi-Spark	yes	yes
			DR14ZC	1124		14mm	19mm-3/4"	16mm-5/8"	gasket	Multi-Spark	yes	yes
DR14ZC-1			1232		14mm	19mm-3/4"	16mm-5/8"	gasket	Multi-Spark	yes	yes	
DR12ZC			1125		14mm	19mm-3/4"	16mm-5/8"	gasket	Multi-Spark	yes	yes	
DR12ZC-1			1133		14mm	19mm-3/4"	16mm-5/8"	gasket	Multi-Spark	yes	yes	
DR10ZC			1130		14mm	19mm-3/4"	16mm-5/8"	gasket	Multi-Spark	yes	yes	
DR10ZC-1		1135		14mm	19mm-3/4"	16mm-5/8"	gasket	Multi-Spark	yes	yes		
.ZS		DR12ZS	1204		14mm	19mm-3/4"	16mm-5/8"	gasket	Multi-Spark	yes	yes	
		DR10ZS	1203		14mm	19mm-3/4"	16mm-5/8"	gasket	Multi-Spark	yes	yes	
	DR08ZS	1202		14mm	19mm-3/4"	16mm-5/8"	gasket	Multi-Spark	yes	yes		
.GS	DR08GS			14mm	19mm-3/4"	16mm-5/8"	gasket	Surface Discharge	yes	no		
iridium	.IR	DOR15IR	1442	0.8	14mm	19mm-3/4"	16mm-5/8"	gasket	Iridium Center Electrode	yes	special-semi	
		DOR14IR	1441	0.8	14mm	19mm-3/4"	16mm-5/8"	gasket	Iridium Center Electrode	yes	special-semi	
		DOR12IR			14mm	19mm-3/4"	16mm-5/8"	gasket	Iridium Center Electrode	yes	special-semi	
		DOR10IR			14mm	19mm-3/4"	16mm-5/8"	gasket	Iridium Center Electrode	yes	special-semi	
		DOR08IR			14mm	19mm-3/4"	16mm-5/8"	gasket	Iridium Center Electrode	yes	special-semi	
		DOX12IRY			14mm	19mm-3/4"	16mm-5/8"	gasket	Iridium / Yttrium	yes	extra projected	

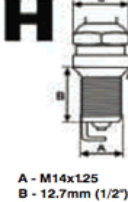

E		MANUFACTURER HEAT RANGES		BRISK USA ENTERPRISES, LLC								
		BRISK	NGK					DENSO	DENSO			
TYP		obj. č.	GAP (mm)	THREAD	REACH	HEXAGON	SEAT	DESIGN	RESISTOR	PROJECTED		
 <p>A - M14x125 B - 26.5mm (1.05") C - 16mm (5/8")</p> <p>20-30 Nm 14-22 lb.ft.</p>	super	ER15YC-1			14mm	26.5mm-1.05"	16mm-5/8"	gasket	Copper Center Electrode	yes	yes	
		silver	.S	ER14S			14mm	26.5mm-1.05"	16mm-5/8"	gasket	Silver Center Electrode	yes
	ER12S					14mm	26.5mm-1.05"	16mm-5/8"	gasket	Silver Center Electrode	yes	no
	ER10S					14mm	26.5mm-1.05"	16mm-5/8"	gasket	Silver Center Electrode	yes	no
	.YS		ER14YS			14mm	26.5mm-1.05"	16mm-5/8"	gasket	Silver Center Electrode	yes	yes
			ER15YS			14mm	26.5mm-1.05"	16mm-5/8"	gasket	Silver Center Electrode	yes	yes
	premium	.LGS	EOR15LGS			14mm	26.5mm-1.05"	16mm-5/8"	gasket	Lamborghini Design	yes	yes
			EOR14LGS			14mm	26.5mm-1.05"	16mm-5/8"	gasket	Lamborghini Design	yes	yes

G		GAP (mm)		MANUFACTURER HEAT RANGES								
		TYP	obj. c.	BRISK	NGK	DENSO	8	10			12	14
		GAP (mm)		THREAD	REACH	HEXAGON	SEAT	DESIGN	RESISTOR	PROJECTED		
		TYP	obj. c.									
 <p>A - M14x125 B - 18mm (.708") C - 16mm (5/8")</p> <p>20-30 Nm 14-22 lb.ft</p>	super	..YC	G17YC	1368	0.7	14mm	18mm-.708"	16mm-5/8"	tapered	Copper Alloy Electrode	no	yes
		G15YC	1336	0.7	14mm	18mm-.708"	16mm-5/8"	tapered	Copper Alloy Electrode	no	yes	
		G14YC	1376	0.7	14mm	18mm-.708"	16mm-5/8"	tapered	Copper Alloy Electrode	no	yes	
		G12YC	1483	0.7	14mm	18mm-.708"	16mm-5/8"	tapered	Copper Alloy Electrode	no	yes	
		GR19YC-1	1477	1.1	14mm	18mm-.708"	16mm-5/8"	tapered	Copper Alloy Electrode	yes	yes	
		GR17YC	1389	0.7	14mm	18mm-.708"	16mm-5/8"	tapered	Copper Alloy Electrode	yes	yes	
		GR17YC-1	1419	1.1	14mm	18mm-.708"	16mm-5/8"	tapered	Copper Alloy Electrode	yes	yes	
		GR15YC	1362	0.7	14mm	18mm-.708"	16mm-5/8"	tapered	Copper Alloy Electrode	yes	yes	
		GR15YC-1	1383	1.1	14mm	18mm-.708"	16mm-5/8"	tapered	Copper Alloy Electrode	yes	yes	
		GR14YC	1378	0.7	14mm	18mm-.708"	16mm-5/8"	tapered	Copper Alloy Electrode	yes	yes	
	silver	..S	G12S			14mm	18mm-.708"	16mm-5/8"	tapered	Silver Center Electrode	no	no
		G08S		14mm	18mm-.708"	16mm-5/8"	tapered	Silver Center Electrode	no	no		
		GR14S	1493	0.7	14mm	18mm-.708"	16mm-5/8"	tapered	Silver Center Electrode	yes	no	
		GR12S		14mm	18mm-.708"	16mm-5/8"	tapered	Silver Center Electrode	yes	no		
		..YS	G14YS	1492	0.7	14mm	18mm-.708"	16mm-5/8"	tapered	Silver Center Electrode	no	yes
		GR17YS		14mm	18mm-.708"	16mm-5/8"	tapered	Silver Center Electrode	yes	yes		
	platinum	..YP	GR19YP-5	1478	1.5	14mm	18mm-.708"	16mm-5/8"	tapered	Single Platin	yes	yes
		GR17YP-5	1475	1.5	14mm	18mm-.708"	16mm-5/8"	tapered	Single Platin	yes	yes	
		GR17YP-3	1474	1.5	14mm	18mm-.708"	16mm-5/8"	tapered	Single Platin	yes	yes	
		GR17LP-5	1479	1.5	14mm	18mm-.708"	16mm-5/8"	tapered	Single Platin Extra Proj.	yes	yes	
GR15YP-1			14mm	18mm-.708"	16mm-5/8"	tapered	Single Platin	yes	yes			
premium	..LGS	GOR19LGS	3083		14mm	18mm-.708"	16mm-5/8"	tapered	Lamborghini Design	yes	yes	
	GOR17LGS		14mm	18mm-.708"	16mm-5/8"	tapered	Lamborghini Design	yes	yes			
	GOR15LGS		14mm	18mm-.708"	16mm-5/8"	tapered	Lamborghini Design	yes	yes			
	GOR15LGS-T		14mm	18mm-.708"	16mm-5/8"	tapered	Lambo Design small gap	yes	yes			
	GOR14LGS	3080		14mm	18mm-.708"	16mm-5/8"	tapered	Lamborghini Design	yes	yes		
	GOR14LGS-T		14mm	18mm-.708"	16mm-5/8"	tapered	Lambo Design small gap	yes	yes			
	GO11LGS-T		14mm	18mm-.708"	16mm-5/8"	tapered	Lambo Design small gap	no	no			
	..ZC	GR15ZC	1155		14mm	18mm-.708"	16mm-5/8"	tapered	Multi-Spark	yes	yes	
	GR15ZC-1	1158		14mm	18mm-.708"	16mm-5/8"	tapered	Multi-Spark	yes	yes		
	GR14ZC	1153		14mm	18mm-.708"	16mm-5/8"	tapered	Multi-Spark	yes	yes		
extra	..TC	GOR15YTE-3		1.3	14mm	18mm-.708"	16mm-5/8"	tapered	Triple Ground El. Yttrium	yes	yes	
	GO15YTE-1		1.3	14mm	18mm-.708"	16mm-5/8"	tapered	Triple Ground El. Yttrium	no	yes		
	GOR14DC			14mm	18mm-.708"	16mm-5/8"	tapered	Dual Ground El. Copper	yes	yes		

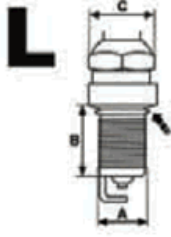

H		GAP (mm)		MANUFACTURER HEAT RANGES								
		TYP	obj. c.	BRISK	NGK	DENSO	8	10			12	14
		GAP (mm)		THREAD	REACH	HEXAGON	SEAT	DESIGN	RESISTOR	PROJECTED		
		TYP	obj. c.									
 <p>A - M14x125 B - 12.7mm (1/2") C - 16mm (5/8")</p> <p>10-20 Nm 7-14 lb.ft.</p>	extra	..YTE	HOR17YTE-1		1.0	14mm	12.7mm-1/2"	16mm-5/8"	tapered	Copper Yttrium -Stubby	yes	yes
		HR17YTE-1		1.0	14mm	12.7mm-1/2"	16mm-5/8"	tapered	Copper Yttrium -Stubby	yes	yes	
		HO15YTE-1		1.0	14mm	12.7mm-1/2"	16mm-5/8"	tapered	Copper Yttrium -Stubby	no	yes	
	silver	..YS	HR14YS			14mm	12.7mm-1/2"	16mm-5/8"	tapered	Silver Center Electrode	yes	yes
		H14YS		14mm	12.7mm-1/2"	16mm-5/8"	tapered	Silver Center Electrode	no	yes		
		H08S		14mm	12.7mm-1/2"	16mm-5/8"	tapered	Silver Center Electrode	no	no		
	premium	..LGS	HOR11LGS	3084		14mm	12.7mm-1/2"	16mm-5/8"	tapered	Lamborghini Design	yes	no
		HOR14LGS	3085		14mm	12.7mm-1/2"	16mm-5/8"	tapered	Lamborghini Design	yes	yes	
		HOR17LGS	3086		14mm	12.7mm-1/2"	16mm-5/8"	tapered	Lamborghini Design	yes	yes	
		HOR15LGS		14mm	12.7mm-1/2"	16mm-5/8"	tapered	Lamborghini Design	yes	yes		
		HOR12LGS		14mm	12.7mm-1/2"	16mm-5/8"	tapered	Lamborghini Design	yes	yes		
		HO14LGS		14mm	12.7mm-1/2"	16mm-5/8"	tapered	Lamborghini Design	no	yes		
		HO12LGS		14mm	12.7mm-1/2"	16mm-5/8"	tapered	Lamborghini Design	no	yes		
		HO11LGS-T		14mm	12.7mm-1/2"	16mm-5/8"	tapered	Lambo Design small	no	no		

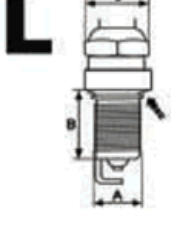
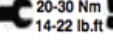

L		GAP (mm)		MANUFACTURER HEAT RANGES						
		TYP	obj. c.	BRISK	NGK	DENSO	8	10	12	14
		GAP (mm)		THREAD	REACH	HEXAGON	SEAT	DESIGN	RESISTOR	PROJECTED

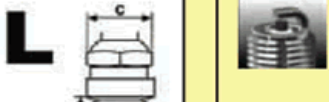
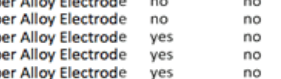
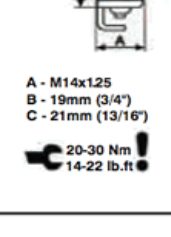
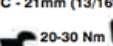

	L TYP obj. č.		GAP (mm)	MANUFACTURER HEAT RANGES										
				BRISK	8	10	12	14					15	17
				NGK	10	9	8	7					6	5
DENSO	31	27	24	22	20	16								
				THREAD	REACH	HEXAGON	SEAT	DESIGN	RESISTOR	PROJECTED				
 <p>A - M14x125 B - 19mm (3/4") C - 21mm (13/16")</p>  <p>20-30 Nm 14-22 lb.ft</p>	premium	..LGS	LOR17LGS	3030	14mm	19mm-3/4"	21mm-13/16"	gasket	Lamborghini Design	yes	yes			
		LOR15LGS	3029	14mm	19mm-3/4"	21mm-13/16"	gasket	Lamborghini Design	yes	yes				
		LOR14LGS	3028	14mm	19mm-3/4"	21mm-13/16"	gasket	Lamborghini Design	yes	yes				
		LOR12LGS	3034	14mm	19mm-3/4"	21mm-13/16"	gasket	Lamborghini Design	yes	yes				
		..ZC	LR15ZC	1129	14mm	19mm-3/4"	21mm-13/16"	gasket	Multi-Spark	yes	yes			
		LR15ZC-1	1138	1.1	14mm	19mm-3/4"	21mm-13/16"	gasket	Multi-Spark	yes	yes			
		LR14ZC	1127	14mm	19mm-3/4"	21mm-13/16"	gasket	Multi-Spark	yes	yes				
		LR14ZC-1	1136	1.1	14mm	19mm-3/4"	21mm-13/16"	gasket	Multi-Spark	yes	yes			
		LR12ZC	1128	14mm	19mm-3/4"	21mm-13/16"	gasket	Multi-Spark	yes	yes				
		LR12ZC-1	1137	1.1	14mm	19mm-3/4"	21mm-13/16"	gasket	Multi-Spark	yes	yes			
		LR10ZC	1131	14mm	19mm-3/4"	21mm-13/16"	gasket	Multi-Spark	yes	yes				
		LR10ZC-1	1139	1.1	14mm	19mm-3/4"	21mm-13/16"	gasket	Multi-Spark	yes	yes			
		..ZS	L10ZS	1207	14mm	19mm-3/4"	21mm-13/16"	gasket	Multi-Spark	no	yes			
		LR12ZS	1206	14mm	19mm-3/4"	21mm-13/16"	gasket	Multi-Spark	yes	yes				
		LR10ZS	1206	14mm	19mm-3/4"	21mm-13/16"	gasket	Multi-Spark	yes	yes				
LR08ZS	1205	14mm	19mm-3/4"	21mm-13/16"	gasket	Multi-Spark	yes	yes						

	L TYP obj. č.		GAP (mm)	MANUFACTURER HEAT RANGES										
				BRISK	8	10	12	14					15	17
				NGK	10	9	8	7					6	5
DENSO	31	27	24	22	20	16								
				THREAD	REACH	HEXAGON	SEAT	DESIGN	RESISTOR	PROJECTED				
 <p>A - M14x125 B - 19mm (3/4") C - 21mm (13/16")</p>  <p>20-30 Nm 14-22 lb.ft</p>	silver	..LTC	LR15LTC	1268	0.8	14mm	19mm-3/4"	21mm-13/16"	gasket	Copper Elect. Ext. Proj. Triple Ground Electrodes	yes	yes		
		..S	L12S		0.6	14mm	19mm-3/4"	21mm-13/16"	gasket	Silver Center Electrode	no	no		
		L11S	1530	0.6	14mm	19mm-3/4"	21mm-13/16"	gasket	Silver Center Electrode	no	no			
		L11SL	1531	0.6	14mm	19mm-3/4"	21mm-13/16"	gasket	Silver El. ISO-Length Insulator	no	no			
		L10S	1528	0.6	14mm	19mm-3/4"	21mm-13/16"	gasket	Silver Center Electrode	no	no			
		L10SL	1529	0.6	14mm	19mm-3/4"	21mm-13/16"	gasket	Silver El. ISO-Length Insulator	no	no			
		LR15S	1147	0.7	14mm	19mm-3/4"	21mm-13/16"	gasket	Silver Center Electrode	yes	no			
		LR14S	1555	0.7	14mm	19mm-3/4"	21mm-13/16"	gasket	Silver Center Electrode	yes	no			
		LR12S	1145	0.7	14mm	19mm-3/4"	21mm-13/16"	gasket	Silver Center Electrode	yes	no			
		LR12SL	1537	0.6	14mm	19mm-3/4"	21mm-13/16"	gasket	Silver El. ISO-Length Insulator	yes	no			
		LR11S	1534	0.6	14mm	19mm-3/4"	21mm-13/16"	gasket	Silver Center Electrode	yes	no			
		LR11SL	1535	0.6	14mm	19mm-3/4"	21mm-13/16"	gasket	Silver El. ISO-Length Insulator	yes	no			
		LR10S	1532	0.6	14mm	19mm-3/4"	21mm-13/16"	gasket	Silver Center Electrode	yes	no			
		LR10SL	1533	0.6	14mm	19mm-3/4"	21mm-13/16"	gasket	Silver El. ISO-Length Insulator	yes	no			
		..YS	LR17YS	1333	0.7	14mm	19mm-3/4"	21mm-13/16"	gasket	Silver Center Electrode	yes	yes		
		LR17YS-9	1465	0.9	14mm	19mm-3/4"	21mm-13/16"	gasket	Silver Center Electrode	yes	yes			
		LR15YS	1332	0.7	14mm	19mm-3/4"	21mm-13/16"	gasket	Silver Center Electrode	yes	yes			
		LR15YS-9	1464	0.9	14mm	19mm-3/4"	21mm-13/16"	gasket	Silver Center Electrode	yes	yes			
LR14YS	1353	0.7	14mm	19mm-3/4"	21mm-13/16"	gasket	Silver Center Electrode	yes	yes					
LR12YS	1458	0.7	14mm	19mm-3/4"	21mm-13/16"	gasket	Silver Center Electrode	yes	yes					

	L TYP obj. č.		GAP (mm)	MANUFACTURER HEAT RANGES										
				BRISK	8	10	12	14					15	17
				NGK	10	9	8	7					6	5
DENSO	31	27	24	22	20	16								
				THREAD	REACH	HEXAGON	SEAT	DESIGN	RESISTOR	PROJECTED				
 <p>A - M14x125 B - 19mm (3/4") C - 21mm (13/16")</p>  <p>20-30 Nm 14-22 lb.ft</p>	super	..C	L17C	1321	0.7	14mm	19mm-3/4"	21mm-13/16"	gasket	Copper Alloy Electrode	no	no		
		L15C	1468	0.7	14mm	19mm-3/4"	21mm-13/16"	gasket	Copper Alloy Electrode	no	no			
		L14C	1344	0.7	14mm	19mm-3/4"	21mm-13/16"	gasket	Copper Alloy Electrode	no	no			
		LR17C	1473	0.7	14mm	19mm-3/4"	21mm-13/16"	gasket	Copper Alloy Electrode	yes	no			
		LR15C	1472	0.7	14mm	19mm-3/4"	21mm-13/16"	gasket	Copper Alloy Electrode	yes	no			
		LR14C	1485	0.7	14mm	19mm-3/4"	21mm-13/16"	gasket	Copper Alloy Electrode	yes	no			
		LR12C	1536	0.7	14mm	19mm-3/4"	21mm-13/16"	gasket	Copper Alloy Electrode	yes	no			
		..YC	L17YC	1338	0.7	14mm	19mm-3/4"	21mm-13/16"	gasket	Copper Alloy Electrode	no	yes		
		L17YC-1	1224	1.1	14mm	19mm-3/4"	21mm-13/16"	gasket	Copper Alloy Electrode	no	yes			
		L15YC	1313	0.7	14mm	19mm-3/4"	21mm-13/16"	gasket	Copper Alloy Electrode	no	yes			
		L15YC-1	1429	1.1	14mm	19mm-3/4"	21mm-13/16"	gasket	Copper Alloy Electrode	no	yes			
		L14YC	1361	0.7	14mm	19mm-3/4"	21mm-13/16"	gasket	Copper Alloy Electrode	no	yes			
		L12YC	1484	0.7	14mm	19mm-3/4"	21mm-13/16"	gasket	Copper Alloy Electrode	no	yes			
		LR17YC	1322	0.7	14mm	19mm-3/4"	21mm-13/16"	gasket	Copper Alloy Electrode	yes	yes			
		LR17YC-1	1365	1.1	14mm	19mm-3/4"	21mm-13/16"	gasket	Copper Alloy Electrode	yes	yes			
		LR17YC-9	1573	0.9	14mm	19mm-3/4"	21mm-13/16"	gasket	Copper Alloy Electrode	yes	yes			
		LR15YC	1314	0.7	14mm	19mm-3/4"	21mm-13/16"	gasket	Copper Alloy Electrode	yes	yes			
		LR15YC-1	1315	1.1	14mm	19mm-3/4"	21mm-13/16"	gasket	Copper Alloy Electrode	yes	yes			
LR15YC-9	1572	0.9	14mm	19mm-3/4"	21mm-13/16"	gasket	Copper Alloy Electrode	yes	yes					
LR14YC	1370	0.7	14mm	19mm-3/4"	21mm-13/16"	gasket	Copper Alloy Electrode	yes	yes					
LR12YC	1413	0.7	14mm	19mm-3/4"	21mm-13/16"	gasket	Copper Alloy Electrode	yes	yes					

N		TYP		obj. č.		GAP (mm)		MANUFACTURER HEAT RANGES						
								BRISK	8	10				
N		TYP		obj. č.		GAP (mm)		BRISK	8	10	12	14	15	17
								NGK	10	9	8	7	6	5
N		TYP		obj. č.		GAP (mm)		BRISK	31	27	24	22	20	16
								DENSO	31	27	24	22	20	16
								THREAD	REACH	HEXAGON	SEAT	DESIGN	RESISTOR	PROJECTED
 <p>A - M14x125 B - 12.7mm (1/2") C - 21mm (13/16")</p> <p>20-30 Nm 14-22 lb.ft.</p>	super	..C	N19C	1363	0.7	14mm	12.7mm-1/2"	21mm-13/16"	gasket	Copper Alloy Electrode	no	no		
			N17C	1320	0.7	14mm	12.7mm-1/2"	21mm-13/16"	gasket	Copper Alloy Electrode	no	no		
			N15C	1330	0.7	14mm	12.7mm-1/2"	21mm-13/16"	gasket	Copper Alloy Electrode	no	no		
			N14C	1319	0.7	14mm	12.7mm-1/2"	21mm-13/16"	gasket	Copper Alloy Electrode	no	no		
			N12C	1467	0.7	14mm	12.7mm-1/2"	21mm-13/16"	gasket	Copper Alloy Electrode	no	no		
			NR14C	1434	0.7	14mm	12.7mm-1/2"	21mm-13/16"	gasket	Copper Alloy Electrode	yes	no		
			NR15C	1386	0.7	14mm	12.7mm-1/2"	21mm-13/16"	gasket	Copper Alloy Electrode	yes	no		
			NR17C	1371	0.7	14mm	12.7mm-1/2"	21mm-13/16"	gasket	Copper Alloy Electrode	yes	no		
			silver	..YC	N17YC	1544	0.7	14mm	12.7mm-1/2"	21mm-13/16"	gasket	Copper Alloy Electrode	no	yes
	N15YC	1341			0.7	14mm	12.7mm-1/2"	21mm-13/16"	gasket	Copper Alloy Electrode	no	yes		
	N14YC	1360			0.7	14mm	12.7mm-1/2"	21mm-13/16"	gasket	Copper Alloy Electrode	no	yes		
	N12YC	1430			0.7	14mm	12.7mm-1/2"	21mm-13/16"	gasket	Copper Alloy Electrode	no	yes		
	NR17YC	1340			0.7	14mm	12.7mm-1/2"	21mm-13/16"	gasket	Copper Alloy Electrode	yes	yes		
	NR15YC	1339			0.7	14mm	12.7mm-1/2"	21mm-13/16"	gasket	Copper Alloy Electrode	yes	yes		
	premium	LGS	NOR15LGS	3068	0.7	14mm	12.7mm-1/2"	21mm-13/16"	gasket	Lamborghini Design	yes	yes		
			NOR14LGS		0.7	14mm	12.7mm-1/2"	21mm-13/16"	gasket	Lamborghini Design	yes	yes		
			NOR12LGS		0.7	14mm	12.7mm-1/2"	21mm-13/16"	gasket	Lamborghini Design	yes	yes		
			N10S		1538	0.6	14mm	12.7mm-1/2"	21mm-13/16"	gasket	Silver Center Electrode	no	no	
N11S			1539		0.6	14mm	12.7mm-1/2"	21mm-13/16"	gasket	Silver Center Electrode	no	semi		
silver	..S	NR15S	1354	0.55	14mm	12.7mm-1/2"	21mm-13/16"	gasket	Silver Center Electrode	yes	no			
		NR14S	1432	0.55	14mm	12.7mm-1/2"	21mm-13/16"	gasket	Silver Center Electrode	yes	no			
		NR12S	1471	0.55	14mm	12.7mm-1/2"	21mm-13/16"	gasket	Silver Center Electrode	yes	no			
		NOR15LGS	3068	0.7	14mm	12.7mm-1/2"	21mm-13/16"	gasket	Lamborghini Design	yes	yes			
NOR14LGS	0.7	14mm		12.7mm-1/2"	21mm-13/16"	gasket	Lamborghini Design	yes	yes					
premium	LGS	NOR12LGS	3068	0.7	14mm	12.7mm-1/2"	21mm-13/16"	gasket	Lamborghini Design	yes	yes			
		NOR15LGS		0.7	14mm	12.7mm-1/2"	21mm-13/16"	gasket	Lamborghini Design	yes	yes			

R		TYP		obj. č.		GAP (mm)		MANUFACTURER HEAT RANGES						
								BRISK	8	10				
R		TYP		obj. č.		GAP (mm)		BRISK	8	10	12	14	15	17
								NGK	10	9	8	7	6	5
R		TYP		obj. č.		GAP (mm)		BRISK	31	27	24	22	20	16
								DENSO	31	27	24	22	20	16
								THREAD	REACH	HEXAGON	SEAT	DESIGN	RESISTOR	PROJECTED
 <p>A - M14x125 B - 25mm (1") C - 16mm (5/8")</p> <p>10-20 Nm 7-14 lb.ft.</p>	super	..YC	RR15YC-1	1437	1.1	14mm	25mm-1"	16mm-5/8"	tapered	Yttrium Alloy Electrode	yes	yes		
			RR15YPP-1		1.1	14mm	25mm-1"	16mm-5/8"	tapered	Double Platinum	yes	yes		
	silver	..S	RR14S	RR12S	RR10S	1.1	14mm	25mm-1"	16mm-5/8"	tapered	Silver Center Electrode	yes	no	
						1.1	14mm	25mm-1"	16mm-5/8"	tapered	Silver Center Electrode	yes	no	
						1.1	14mm	25mm-1"	16mm-5/8"	tapered	Silver Center Electrode	yes	no	
	silver	..YS	RR15YS	RR14YS	1.1	14mm	25mm-1"	16mm-5/8"	tapered	Silver Center Electrode	yes	yes		
					1.1	14mm	25mm-1"	16mm-5/8"	tapered	Silver Center Electrode	yes	yes		
	premium	LGS	ROR15LGS	ROR14LGS	1.1	14mm	25mm-1"	16mm-5/8"	tapered	Lamborghini Design	yes	yes		
					1.1	14mm	25mm-1"	16mm-5/8"	tapered	Lamborghini Design	yes	yes		

X		TYP		obj. č.		GAP (mm)		MANUFACTURER HEAT RANGES						
								BRISK	8	10				
X		TYP		obj. č.		GAP (mm)		BRISK	8	10	12	14	15	17
								NGK	10	9	8	7	6	5
X		TYP		obj. č.		GAP (mm)		BRISK	31	27	24	22	20	16
								DENSO	31	27	24	22	20	16
								THREAD	REACH	HEXAGON	SEAT	DESIGN	RESISTOR	PROJECTED
 <p>A - M12x125 B - 27mm (1.05") C - 14mm (9/16")</p> <p>10-12 Nm 7-9 lb.ft.</p>	silver	..YS	XOR14YS		1.0	12mm	27mm-1.05"	14mm-9/16"	tapered	Silver Center Electrode	yes	yes		
			XOR14YS-1		1.0	12mm	27mm-1.05"	14mm-9/16"	tapered	Silver Center Electrode	yes	yes		
			XOR12YS		1.0	12mm	27mm-1.05"	14mm-9/16"	tapered	Silver Center Electrode	yes	yes		
			XOR12YS-1		1.0	12mm	27mm-1.05"	14mm-9/16"	tapered	Silver Center Electrode	yes	yes		

HEAT RANGE CROSS REFERENCE TABLE

HEAT RANGE	COLD	HOT				
BRISK	8	10	12	14	15	17
NGK	10	9	8	7	6	5
DENSO	31	27	24	22	20	16

BOSCH	BRISK	BOSCH	BRISK	BOSCH	BRISK	
F6DC	DR14YS	FR7DPX	DR17YS-9 (gap 0.9mm) DOR17LGS	W8DC	LR17YS	
F6DTC		FR7LTCR		W9DC		
FR6DTC		FR7LTC		W8DTC		
FR6DC		BOSCH		BRISK		W8LTCR
F6DP		FR8LDCR		W9DTC		WR8DC
F6DSR		FR8DCX		WR8DC		WR9DC
FR6DS		FR8DPX		WR9DC		WR8DP
BOSCH	BRISK	BOSCH	BRISK	BOSCH	BRISK	
F7DC	DR14YS	W6DC	LR14YS	WR9DP	LR17YS-9 (gap 0.9mm) LOR17LGS	
FR7LDC		W6DTC		WR8DS		
F7DTC		WR6DTC		WR9DS		
FR7DTC		WR6DC		BOSCH		BRISK
FR7DC		WR6DP		W8DTC		LR17YS-9 (gap 0.9mm) LOR17LGS
FR7DP		W5CS		W8LTCR		
BOSCH	BRISK	WR8DCX				
F8DC	DR14YS	WR6DS	LR15YS	WR8DPX	NR14S	
F9DC		BOSCH		BRISK		WR9DPX
FR8LDC		W7DC		BOSCH		BRISK
FR8DC		W7DTC		W4AC		NR15S
FR9DC		WR7DTC		W5AC		
FR8DS		WR7DC		W6BC		
BOSCH		BRISK		WR7DP		NR14S
F6DTC	DR14YS-9 (gap 0.9mm) DOR14LGS	WR7DSR	BOSCH	BRISK		
F6LTCR		WR7DS	W7AC	NR15S		
FR6DCX		BOSCH	BRISK		W7BC	
BOSCH	BRISK	WR7DTC	WR7AC			
F7DCX	DR15YS-9 (gap 0.9mm) DOR15LGS	WR7DCX	LR15YS-9 (gap 0.9mm) LOR15LGS	WR7AC	NR15S	
F7LDCR		WR7DPX		WR7BC		
FR7DCX		W7LTCR				

HEAT RANGE

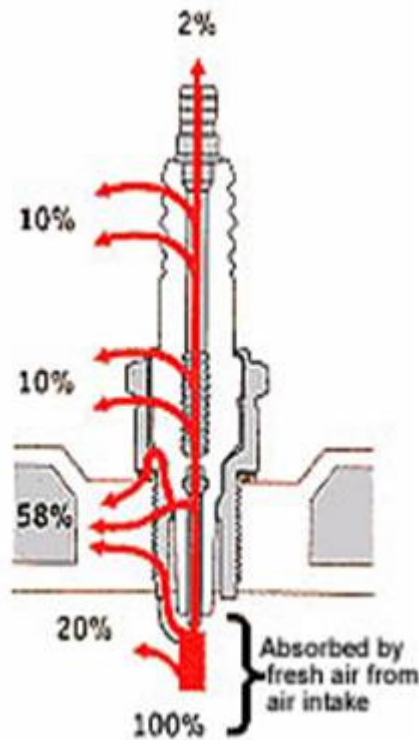

HEAT DISSIPATION

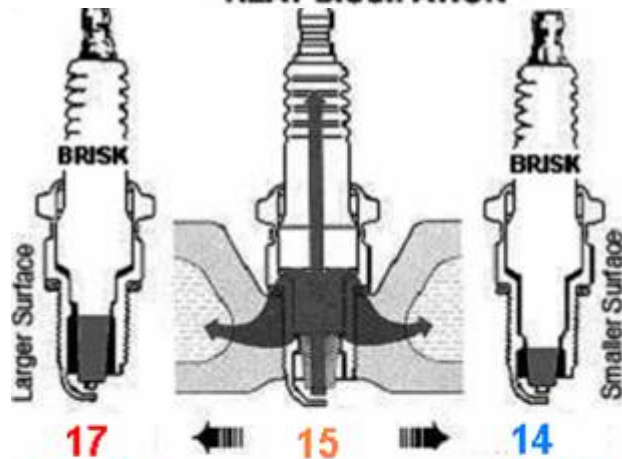

HOT TYPE

COLD TYPE

Large surface area exposed to the combustion gases. Dissipates heat slowly. Small surface area to displace heat from the insulator tip to the engine head through the spark plug shell.

Smaller surface area exposed to the combustion gases. Dissipates heat quickly into the engine head through the large surface area between the insulator and the spark plug shell.

HEAT RANGE	COLD	HOT
BRISK	8 10 12 14 15 17	
NGK	10 9 8 7 6 5	
DENSO	31 27 24 22 20 16	

Heat range is the measure of how fast the spark plug tip dissipates combustion heat. It must do this in precise and controlled manner so the spark plug will:

- Stay cool enough to avoid pre-ignition and/or electrode destruction due to detonation.
- Run hot enough to burn off combustion deposits that would otherwise collect on the insulator tip and cause fouling that results in misfire.
- Adapt to specific engine characteristics and widely varying driving/load conditions.

Why is Heat Range Critical?

Two basic conditions for proper performance of a spark plug are given by **sufficient electrical insulation** between the center and ground electrodes and **heat transfer** from the parts of the spark plug projected into the combustion chamber. Both conditions are directly related.

In order to ensure sufficient insulation between center and ground electrodes it is necessary, during operation, to keep the insulator tip (the part of the insulator projecting into the engine area) within an optimum temperature range.

Insulator tip temperature influence on the proper choice of spark plug heat range

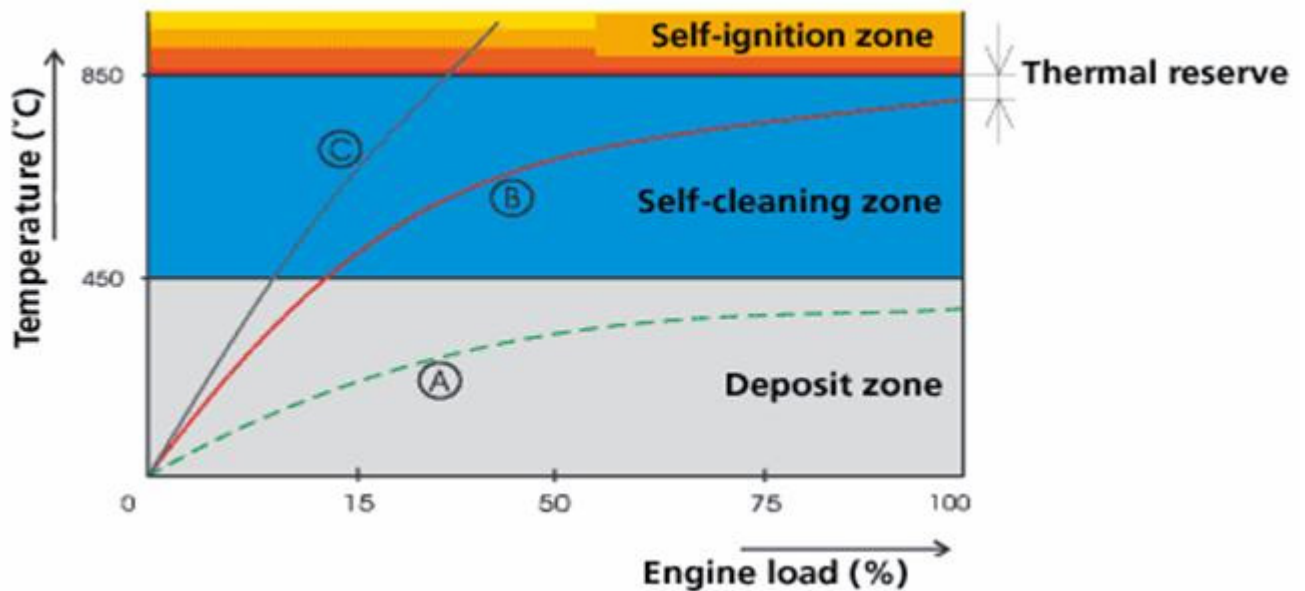

- A. Too cold spark plug for a given engine
- B. Suitable spark plug for a given engine
- C. Too hot spark plug for a given engine

If the insulator tip temperature drops into the so-called **deposit zone**, combustion deposits (carbon, non-combusted fuel, lubrication oil, impurities from the atmosphere) start to form on the insulator tip surface. A consequence of these combustion deposits on the insulator tip is **reduction in electrical insulation** resistance accompanied by failing ignitions and after a certain period of time even by a failure of the spark plug performance.

Providing a higher temperature of the insulator tip, no further combustion deposits are formed, but those already existing will not be burnt until the insulator tip temperature rises above 500 °C - the so-called **self-cleaning zone**. In this temperature range, no new deposits are formed and those existing will be burnt. The spark plug operates in an **optimum manner**.

Too high temperature of the insulator tip is undesirable. High temperature results in pre-ignitions of the air-fuel mixture and further compression of the mixture already ignited leads to high temperature, which can cause serious damage to the engine.

In order to achieve the correct temperature of the insulator tip for a given engine, the spark plugs are produced in various thermal values. The range of thermal values for BRISK spark plugs extend from the warmest to the coldest, namely 19, 18, 17, 15, 14, 12, 10 and 08.

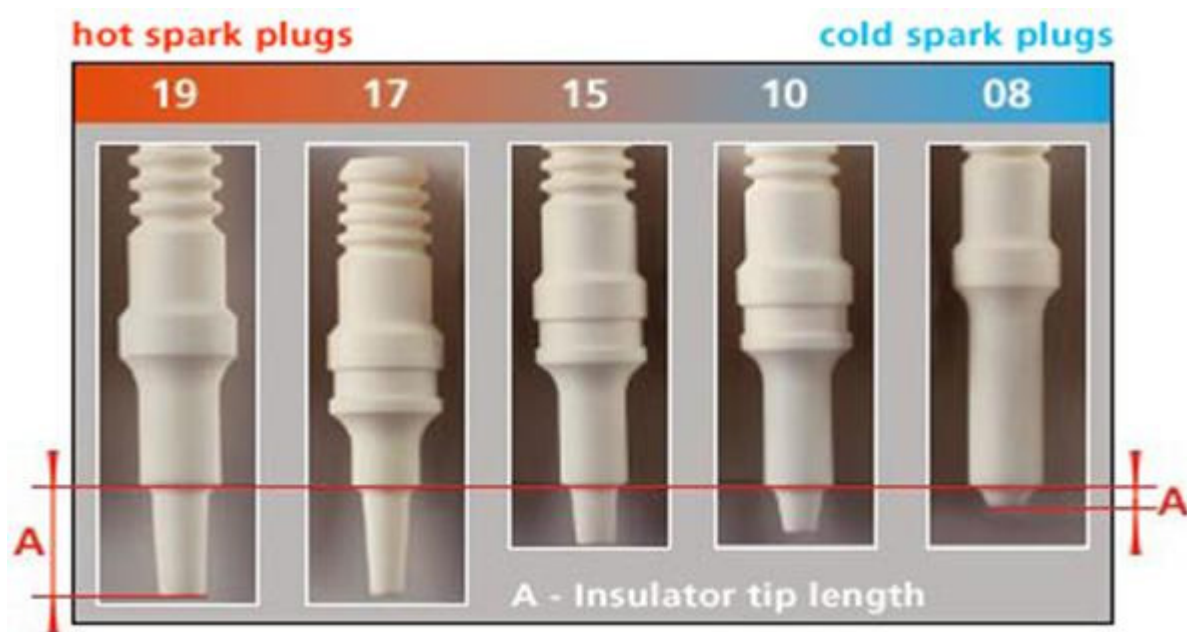

"Hot" spark plugs remove heat from the combustion area relatively slowly. They have a longer insulator tip and they achieve a temperature higher than the deposition zone relatively fast.

"Cold" spark plugs feature a relatively short insulator tip and they remove heat from the combustion area quite fast, in order to avoid advanced ignitions.

The choice of a proper heat range is very important. But even a spark plug featuring a properly selected heat range, is influenced by the processes of fouling and self-cleaning of the insulator tip. The setting of combustion deposits on the insulator tip is caused by an imperfect combustion due to a "rich" air/fuel mixture. On the other hand, the combustion deposits previously set will burn if the insulator tip temperature rises above 500 °C.

Zones of fouling and self-cleaning zone depending on the air/fuel ratio and on the insulator tip temperature

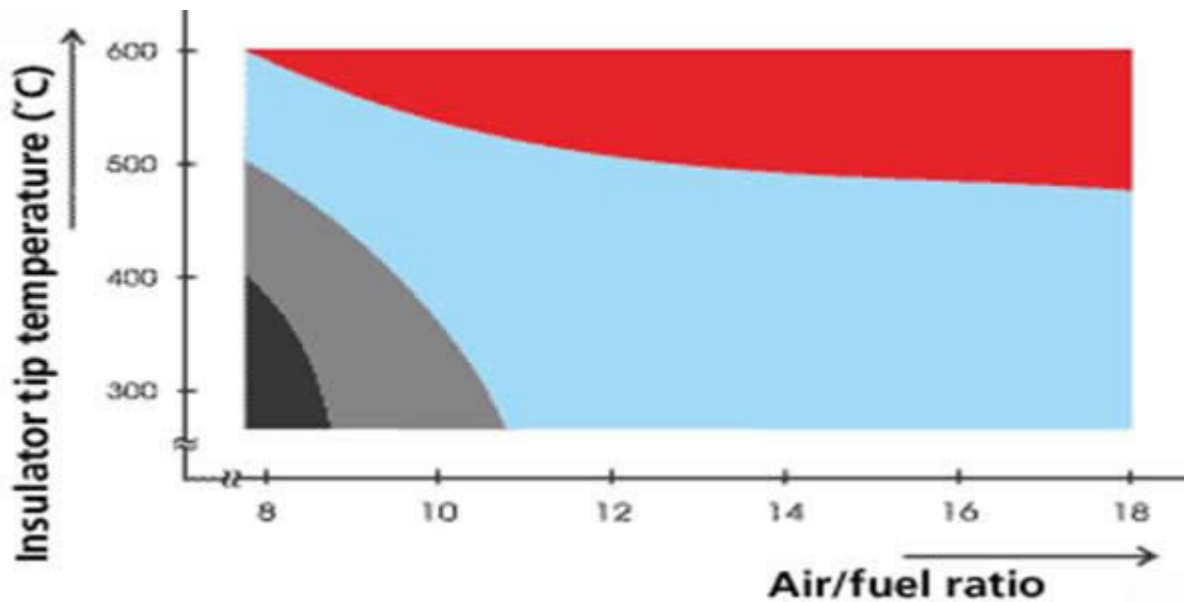

- Zone of fouling with non-evaporated fuel
- Zone of fouling with dry combustion deposits
- Inert zone
- Self-cleaning zone

Zone of fouling with non-evaporated fuel - this is the zone of the highest degree of fouling for spark plugs. The mixing ratio of fuel and air is very low in this case (rich mixture). Diffusion (atomization) of fuel is low and the fuel burns in its liquid state. Level of creation of combustion deposits is significant. In addition, the insulator tip is wet from the non-evaporated fuel. The decreasing insulation resistance of the insulator tip results in an occasional failure of ignition. Cold starts and frequent moving off from rest in cold weather will accelerate the fouling of the insulator tip.

Zone of fouling with soft deposits - vehicle engine run at idling speed or its low load can result in the setting of soft (dry) combustion deposits on the insulator tip, even if the fuel does not burn in liquid state.

Inert zone - in this zone, there does not occur any setting of combustion deposits on the insulator tip and there does not occur any self-cleaning either. No deposits set on the insulator tip surface even if the spark plug temperature drops below 500 0 C. The new spark plug does not feature any fouling and if a spark plug is fouled, it does not get cleaned.

Self-cleaning zone - The combustion deposits set in this zone on the insulator tip will burn and the insulation strength of the insulator tip will return to a common value. The shift into the self-cleaning zone generally takes place during acceleration and at higher speeds of the vehicle.



Fouling with non-evaporated fuel



Fouling with dry combustion deposits



Self-cleaning

Determination of thermal value of a spark plug

While the engine is running, the spark plug is being heated to a certain temperature. The highest temperature can be detected at the insulator tip end. Thermal balance between the input and output of heat from the spark plug is determined by the value known as the spark plug heat range. An important parameter of this heat range is given by the so-called self-ignition value. It is measured by a special measuring engine by means of a gradual increase in the supercharging pressure up to the initiation of self-ignitions of the spark plug. The self-ignitions are indicated with the help of the ionization method, than they are processed by the control system with a feedback to the engine control. The thermal load is expressed by the IMEP (Indicated Mean Effective Pressure lb/in²) units.

Determination of engine equipment with spark plugs

The equipment test of a particular engine is carried out with the help of special equipment making it possible to detect self-ignitions during an increase in spark advance in comparison with the original one, at a load of the engine. A part of the equipment tests is often formed by a starting capacity test carried out in a freezing chamber, as well as operation tests.

MAINTENANCE

Spark plugs do not require any maintenance during the replacement interval. Certain level of maintenance is, however, required by the vehicle whose part the spark plugs are. All deficiencies caused by insufficient vehicle maintenance can be reflected on the spark plug. That is why we recommend, within the framework of prevention, to check the spark plugs at least once a year. Their appearance reflects technical conditions of your vehicle.

Spark plugs replacement intervals are specified for a maximum mileage performance of the engine in a good technical condition. Therefore never exceed the replacement intervals prescribed for a given type of spark plugs! Possible spark plug replacement before the interval prescribed will not cause any problem.