

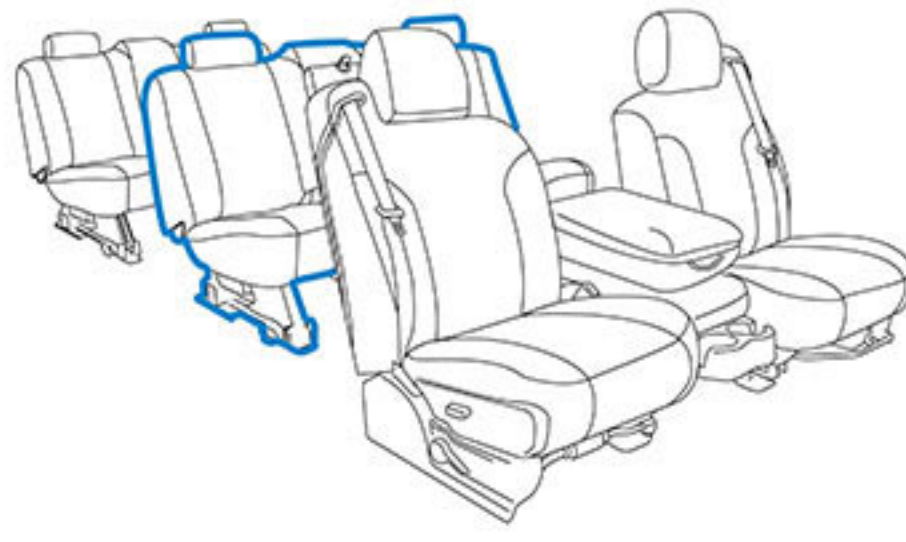

TERMS & DEFINITIONS



(F)
Front Row



(M)
Middle Row, Second Row



(R)
Rear, Third Row



bkt
Bucket

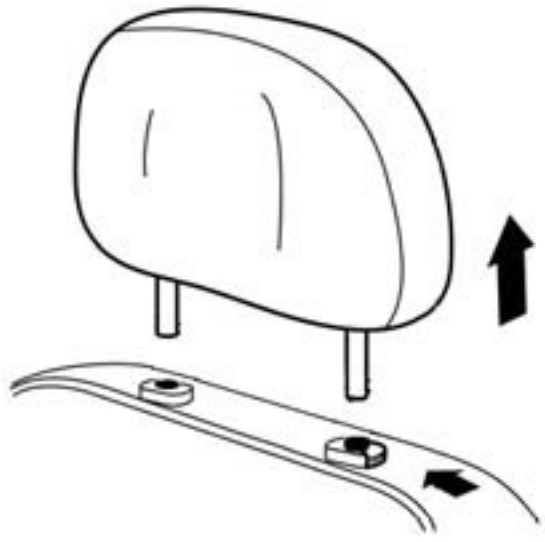

remv hdrst
Removable Headrest

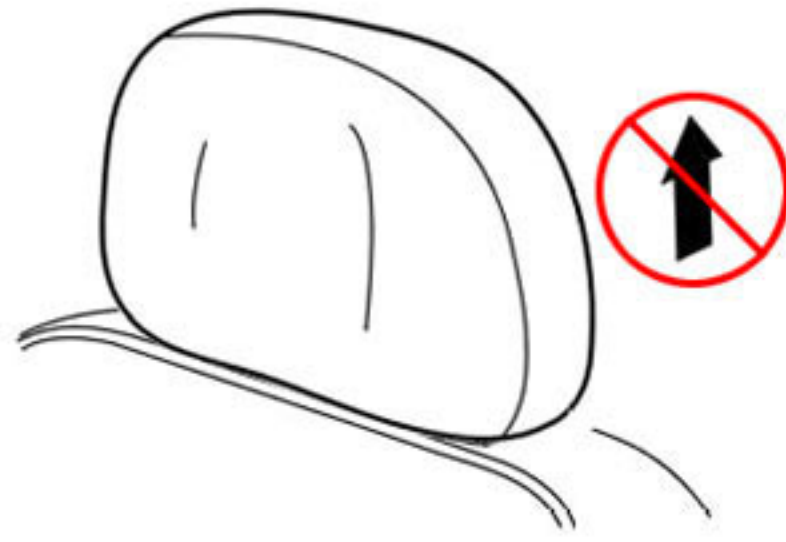

non-remov hdrst
Non-Removable Headrest

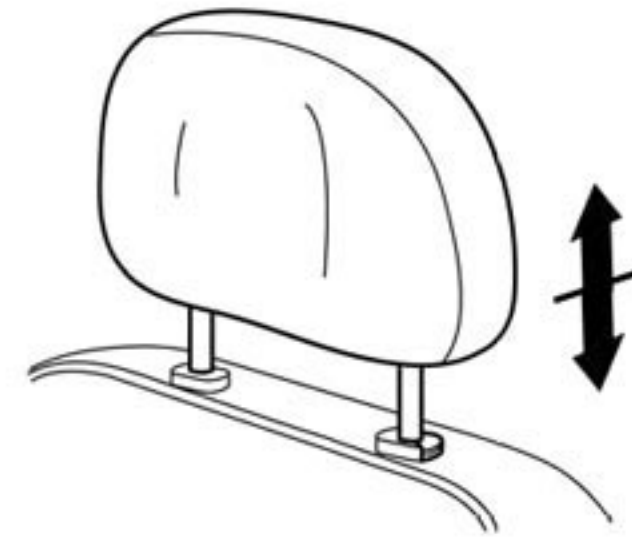

adj. non-remov hdrst
Adjustable Non-removable Headrest



armrst
Armrest

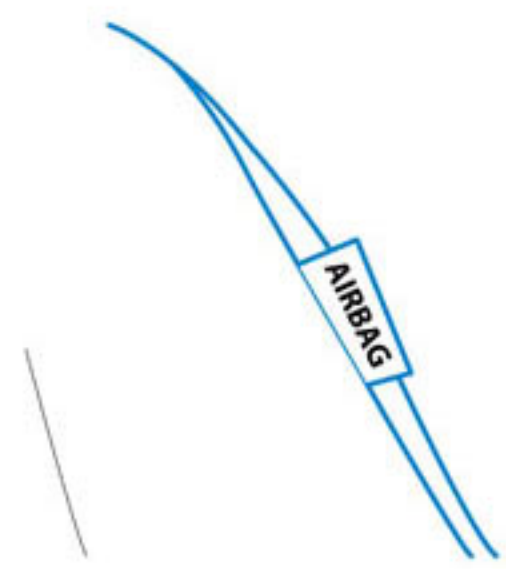

sd arbg, side arbg
Side Airbag

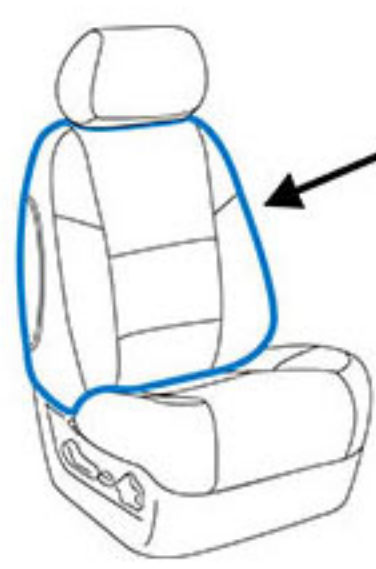

bkrst
Backrest



btm, bttm, botm
Bottom Cushion, Seat Bottom

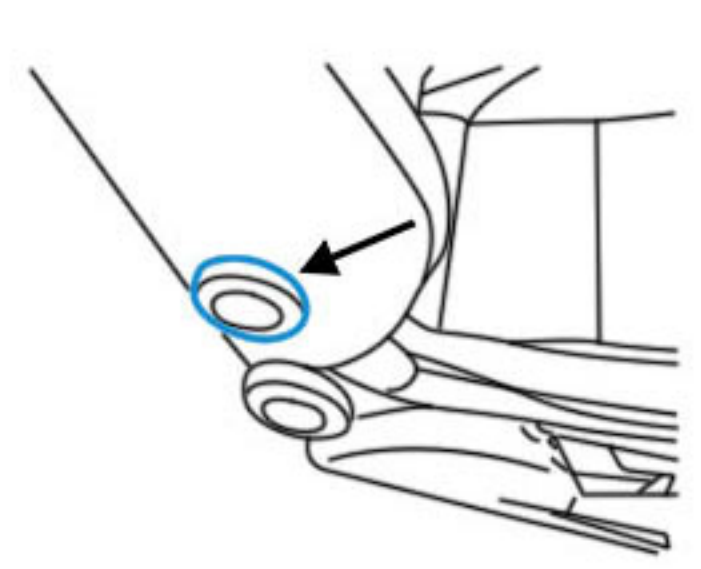

lmb, lmb lvr
Lumbar Lever or Knob

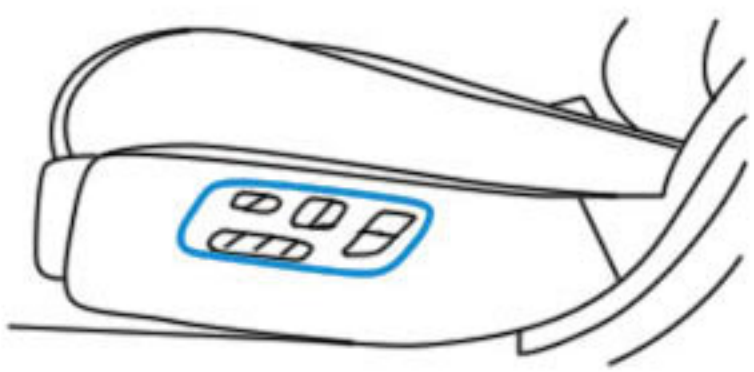

pwr dr, pwr pas
Power Driver/Passenger Seat

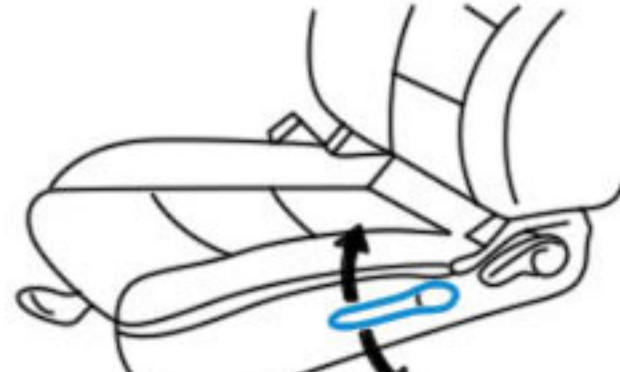

man dr, man ps
Manual Driver/Passenger Seat



blt-in hdrst
Built-in Headrest

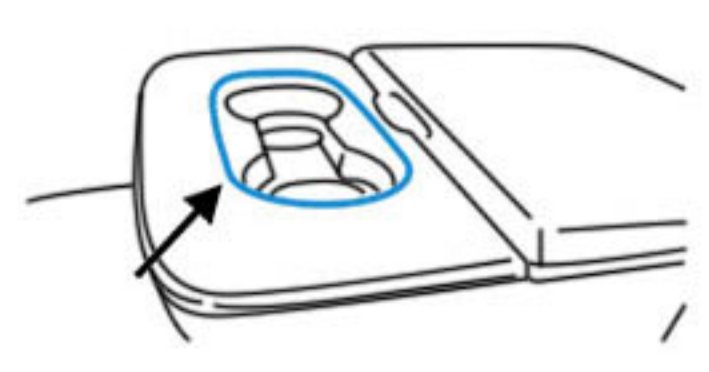

cuphldr
Cup Holder(s)

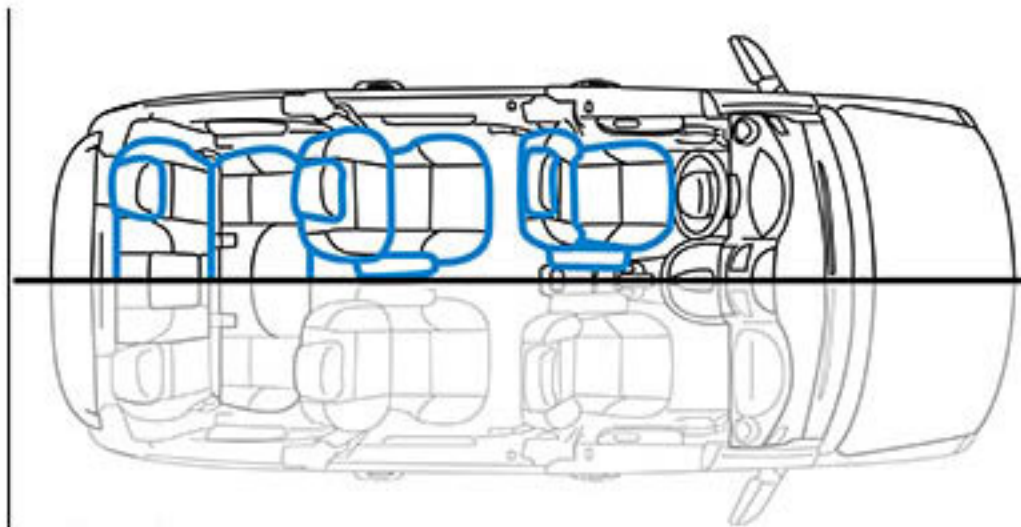

dr, drvr
Driver Side

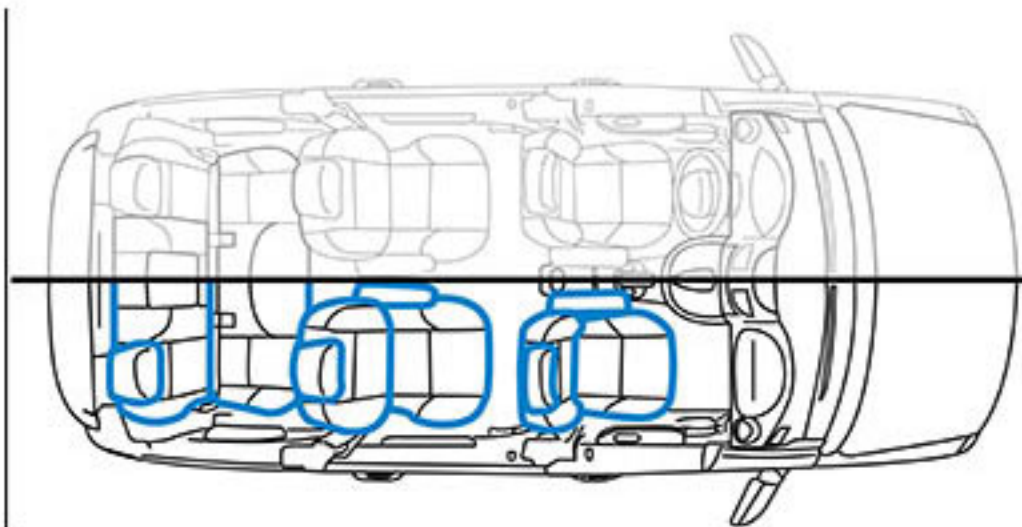

pass, pas
Passenger Side

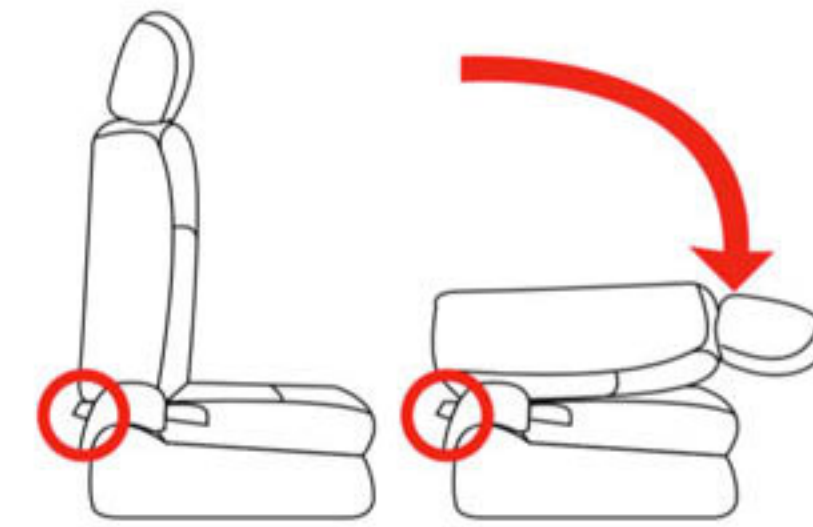

90 dg fld pass
Passenger Side



blt-in belt
Built-in Seat Belt

COMMON SEAT ROW EXAMPLES



50/50 Buckets with Removable Headrests



50/50 Buckets with Non-Removable Headrests

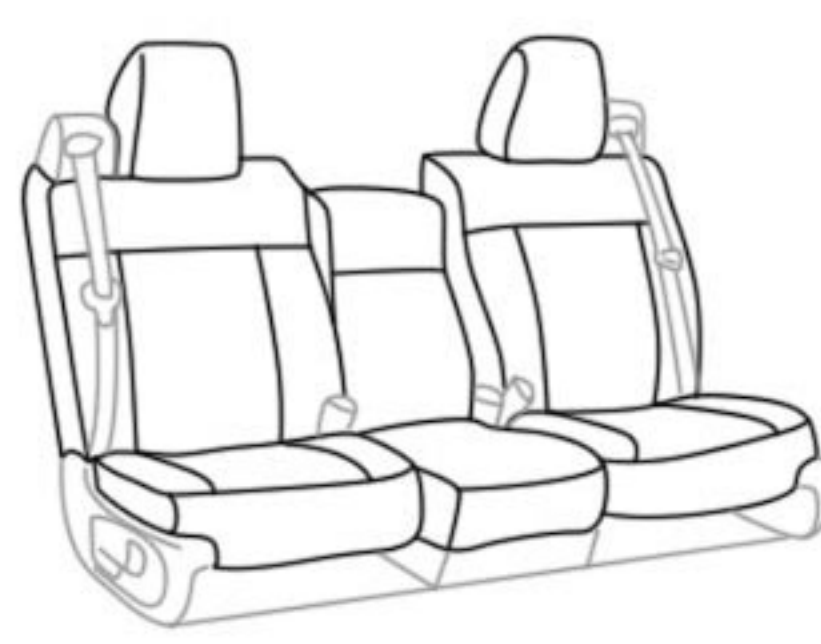

40/20/40 Split Bench with Removable Headrests & Integrated Seat Belts

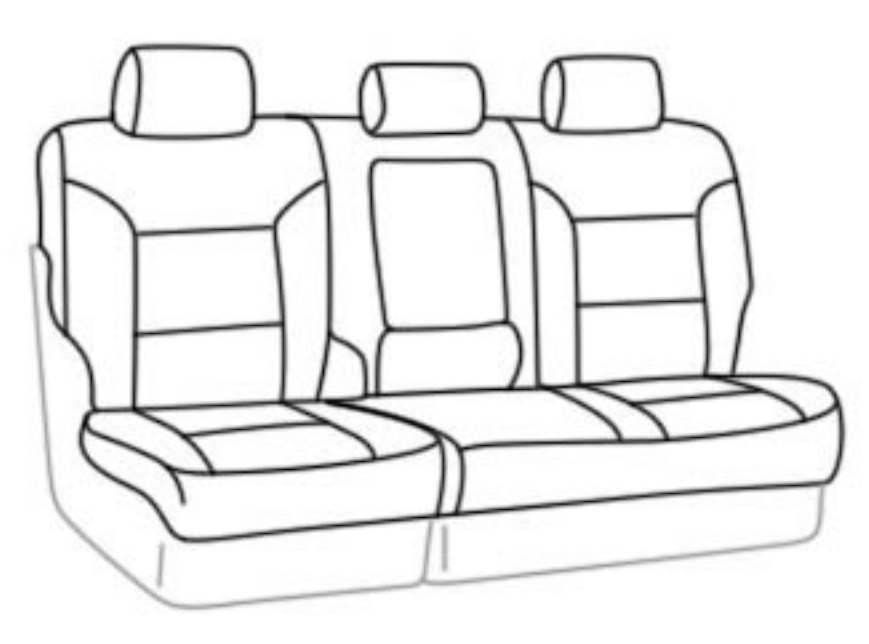

60/40 Split Bench with 3 Removable Headrests & Folding Console

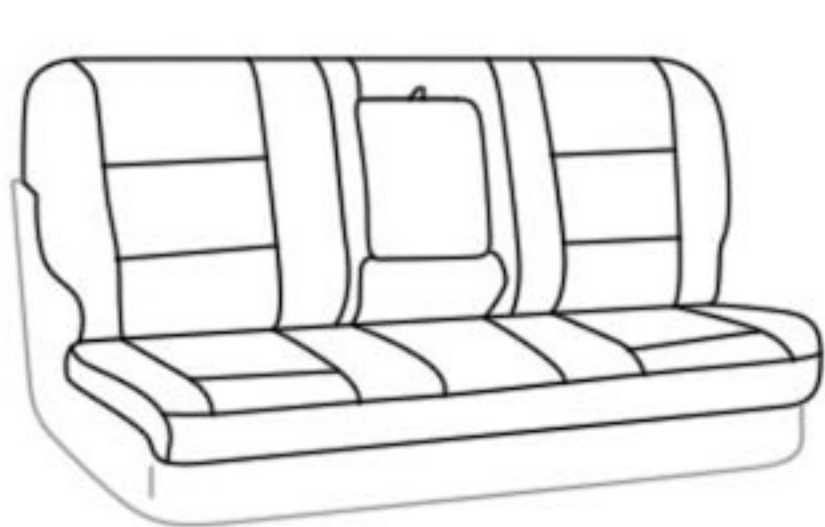

Solid Bench with Folding Console



40/20/40 Split Bench with 3 Removable Headrests & Folding Console

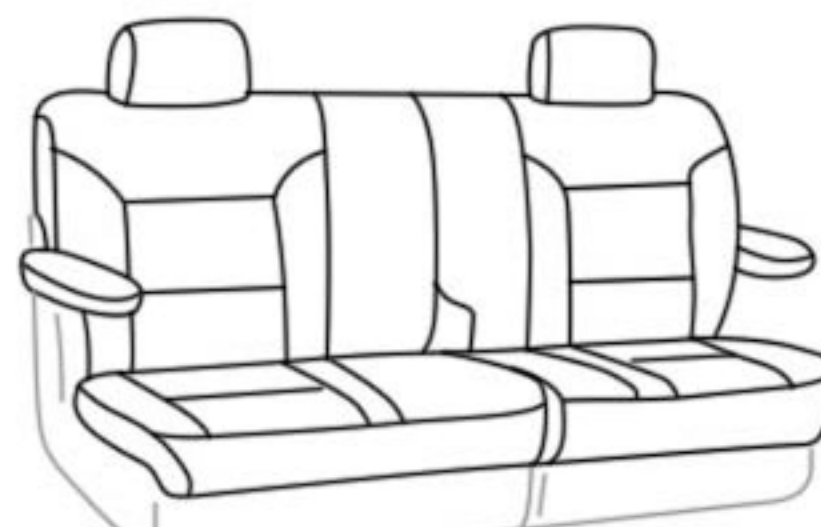

50/50 Split Bench with 2 Removable Headrests & Armrests

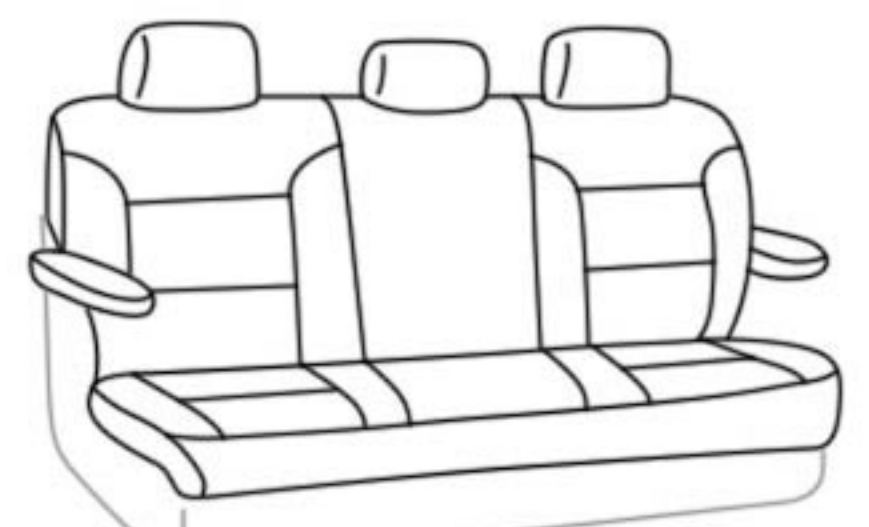

Solid Bench with 3 Removable Headrests and Armrests