

DART **LSNEXT** Iron GEN III - *Technical Notes*

Deck Height	9.240" to 9.450"
Bore	4.000 & 4.125
Main Bearing Size	LS-1 (2.558" – 2.559")
Weight	227lbs
Largest Recommended Bore	4.200"
Largest Recommended Crank Stroke	4.100"
Camshaft Bearing Diameter	55mm babbit
Stock Camshaft Position	4.885"
Cylinder Wall Thickness, min.275" @ 4.185"
Deck Thickness, min625" (5/8)

Torque Specs - Main Caps	1/2" bolts	105 ft lbs w/ CMD #3 high pressure lube.
	7/16" bolts	65 ft lbs w/ CMD # 3 high pressure lube.
	3/8" bolts	40 ft lbs w/ CMD # 3 high pressure lube.

Actual deck height will be .002" - .005" taller for additional machining requirements.
 Factory style Cloyes timing gear is required PN# 9-3658TX3. Double Row timing chains are available but block must be clearanced before use.

Note: The block is designed for a single row timing chain. When using a double roller chain set you must check for interference and block clearance accordingly.

Cam bearing OD should be deburred before installation.

When initially removing main caps, the caps & block should be deburred before reinstalling. This will insure that correct main size is maintained.

Pan rails have factory width and are shortened removing the "Y" block design.

The LS Next block requires a special modified oil pan which is available through Stef's, Moroso, Canton and others.

Dart offers billet pan rail spacers for use with factory pans. PN# 62230001

LS Next blocks have Dual Starter mounting pads. Meziere offers starters for both, For drivers side mounting Meziere P/N: TSS062.

Additional rod clearance may be necessary at bottom of cylinders.

Head stud holes are blind. They do not go into the water jacket.

Loctite # 271 is recommended when installing the head and main studs into the block.

Studs should *never* be torqued into block. They should only be lightly snugged.

Note: The tapered portion of the stud body should never contact the deck or bolt hole counter bore. If the stud body does thread too deep and makes contact with the deck surface then you should use a small ball bearing in the bottom of the bolt hole to space up the stud accordingly.

When installing the pipe plugs in the LS Next oil galleries or water drains you must use a thread sealer to eliminate internal and external leaking and thread galling. We recommend Loctite 565 or a standard PTFE pipe sealer that is available at any auto parts store.

LS Next Blocks use LSX lifter "buckets" for use with stock style lifters.

LS Next Blocks use LS2 – LS7 knock sensors

LS Next Blocks use LS3,LS7,LSX Or Moroso P/N: 25176 Valley Covers

Press-in freeze plugs are sold separate PN# 32820000B

Front cam retaining plate & Bolts included and sold separate for replacement PN# 32226000

The block uses factory style crank driven oil pumps or aftermarket external, or dry sump systems.

Note: Must use remote oil filter w/-10AN O-Ring Fittings.

PRIORITY MAIN OIL SYSTEM

The oil feed (out from pump) is located on the front driver's side of the block just above the oil pan rail and is machined for -10an w/ o-ring. The supply hole AND the oil pressure pickup (in from filter) is located on the rear driver's side bottom just above the oil pan rail and is machined for -10an w/ o-ring.

Oil is directed to the main bearings first, then to the cam bearings. The lifters are oiled utilizing center oil crossovers fed from the main oil galley.

If lifter oiling is restricted, 1/8" pipe plug restrictors must be installed in the center crossovers just above the main oil galley. Our recommended starting point for restriction is .051" diameter with modified lifters. (See lifter mod sheet)

NOTE: Due to variations in lifter sizes and clearance preferences, most of our Engine Builder customers prefer the lifter bores sized on the small end of the specification. Sometimes these bores will need to be lightly honed.

SPECIAL NOTE: with a multitude of different crank, rod and piston combinations available it is important to check clearance of all moving parts (especially crankshaft counterweight to block) before attempting any type of assembly.

NOTE: If you are using aftermarket cam profiles you must use the correct components for the application.

Dart LS Next head bolt sizes: Have been upgraded to 7/16 -14 & 3/8-16 for increased strength and clamping force when using high cylinder pressure applications. Dart and ARP will have individual kits available for specific head application.

Dart LS Next Blocks: Come machined for use with 6 bolts per cylinder. & can be upgraded for use with 1/2" fasteners.

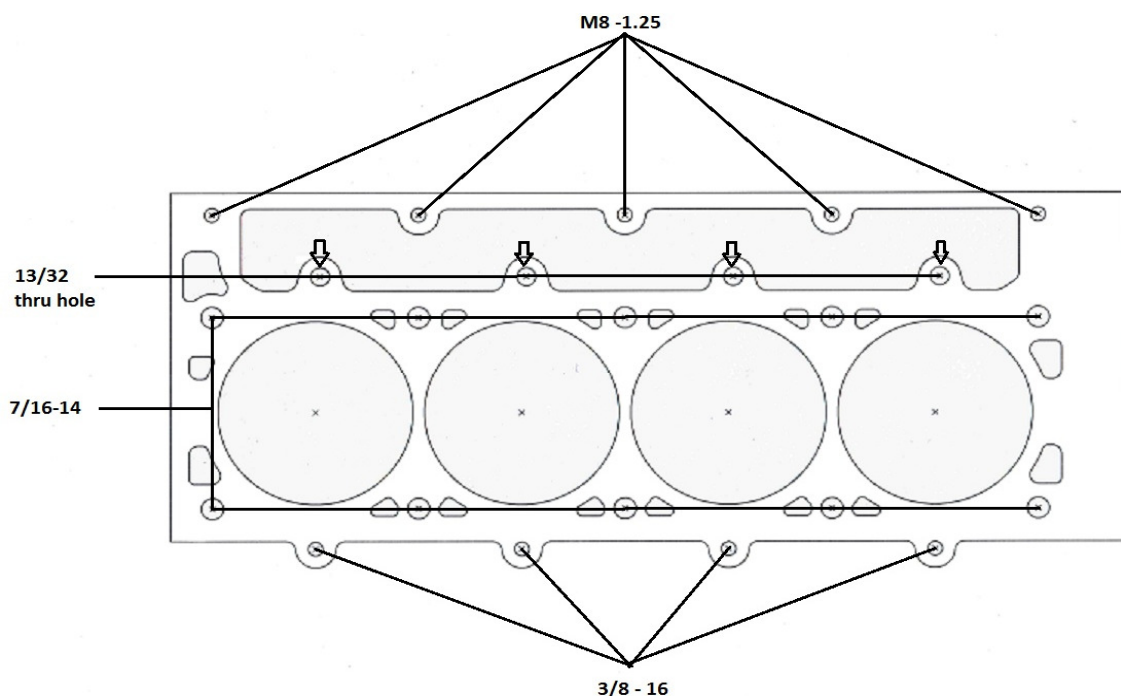

We stock parts that are unique to this block:

LS Next oil pan rail spacer kit	62230001
Head bolt kit for LS1 / LS6	66220010
Head Stud Sets (specify cylinder head type)	Call for PN#
Special main bearings for LS Next	9-MS2321H or 9-MS2321HX
Cam retaining plate w/ bolts	32226000
55mm Babbit cam bearings	32210101-5
LS Next Iron Block parts Kit	32000016
LS Next Iron Main Stud Kit	66311010
Head Stud Kit 15 bolt Iron Block	66120018
Head Stud Kit 23 bolt Iron Block	66120018B
*Optional 1/2" Head Stud Kit 15 bolt Iron Block	66130018
*Optional 1/2" Head Stud Kit 23 bolt Iron Block	66130018B

DART **LS** **NEXT** GEN III – *Technical notes*

Part Number #	31837211 – 31837211
Material:	Special RMR Iron Alloy & optional CGI upgrade
Bore:	4.000" or 4.125" w/ 4.200" max
Bore & stroke:	4.200" x 4.100" max
Cam bearing bore ID:	2.2998" – 2.3002"
Cam bearings:	55mm babbitt Dart PN# 32210101-5
Cam bearing O.S.	+.010", +.020", and +.030" available
Cam bearing press:	.002" - .003"
Camshaft position:	Stock LS cam position
Camshaft to crank Ø	4.885"
Camshaft snout:	1.565" O.D
Cam Drive:	Accepts belt drive (*machining required) or stock chain drive.
Cam retaining plate:	Dart cam retaining plate w/bolts Dart PN# 32226000
Cam Plug snap ring:	N/A
Cubic inch:	454 cubic inch max
Cylinder Wall Thickness:	.275" @ 4.185" bore
Deck Height:	9.240" – 9.450" w / extended cylinder barrels .375" at bottom.
Deck Thickness:	5/8" (.625")
Fuel Pump:	Electric pump required
Fuel Pump Pushrod:	N/A
Freeze Plugs:	1.500" diameter Dart PN# 32820000B (Qty 6)
Lifter Bores:	.8427" - .8437" up to .937" keyed w/ 1.062" dia. bushing
Main bearing size:	2.558" – 2.559" Dart PN# 9-MS2321H or 9-MS2321HX • LS Next ² 2.750" Main uses bearing 9-MS1010 or 9-MS1010HX
Main bearing bore:	2.7508" – 2.7512"
Main caps:	4 bolt billet steel w/splayed centers & center thrust
Oil system:	Low volume priority main oiling system w/ center crossover
Oil Pump:	Melling or Stock LS oil pump
Oil Filter:	Must use remote oil filter w/-10AN O-ring Fittings
Oil Pan:	Special: Moroso, Canton and Stef's or Moroso pan rail spacers
Rear Main Seal	Stock LS style with factory cover
Serial No.	Front passenger side below deck surface (XXXLSN)
Sleeve OD:	N/A
Sleeve O.S.	N/A
Sleeve thickness:	N/A
Sleeve Length:	N/A
Starter:	Factory LS starter w/ driver and passenger mounting options
Main bolts:	Inners – 7/16" x 3.600" Outer – 7/16" x 2.900"
Studs, heads:	Call for application / See Attached pg.2
Studs holes, Head:	6 bolt (per cylinder) pattern with 7/16", 3/8", and 8mm sizes
Stud length in block:	1.000" of thread depth
Timing chain/gears:	24x or 58x depending on application
Timing Cover:	2005-up Factory LS cover and front seal w/cam sensor provision
Torque Specs:	All torque specifications w/ CMD #3 High Pressure Lube 3/8" = 35 ft lbs 7/16" = 65 ft lbs 8mm = 22 ft lbs *1/2" = 105 ft lbs *1/2" available on LS Next ² upgrade
Weight:	227 lbs w/ main caps

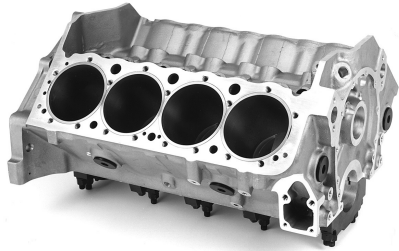

This Block should be assembled only by experienced, professional engine builders.

INSPECTION

Upon receiving this block it should be thoroughly inspected for shipping damage.

Prior to machining and assembly please inspect the following items:
Cylinder bores - Oil passages - Deck surfaces - All threads

MEASURING & MACHINING

- ❑ All initial measuring should be done before any machining has begun.
- ❑ Decks are CNC machined to standard deck heights. If you need a particular deck height always measure before machining.
- ❑ Main journals are finish line honed to the low to middle of the specification. They should be measured for your preference. If you have need for a different diameter you must realign hone this yourself.
- ❑ Crankshaft & rod clearance should always be checked before any machining is started. You need .060" clearance for rotating counterweights and rods.
- ❑ Due to variations in OD dimensions of the numerous lifter manufacturers, lifter bores are finish honed on the tight side of the tolerance to leave room for lifters that are larger than the standard.

WASHING Final washing should be very thorough, paying particular attention to all oil galleys. Use hot soapy water and rinse with hot water first, followed by cold water which helps reduce rust.



CHAMPIONSHIP ENGINE COMPONENTS

Here at Dart we are constantly improving upon our products to ensure that you are receiving the latest and most technologically advanced products in the industry. Through our extensive R&D we have found that valvetrain oil is crucial in a high performance engine. The following modification will correct oil volume to the valvetrain that may occur when using solid roller lifters in any block.

Figure 1:
Stock un-modified
solid roller lifters

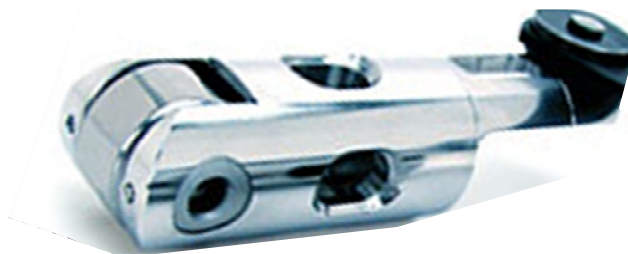

Figure 2:
Dart oil galley modification
from band to pushrod oil hole



We recommend a .020" deep x .080" radius wide groove from the pushrod feed hole to the oil band / machined feed hole in your solid lifters (**Front hole only** as shown in Figure 2 above) depending on your tooling & method. You can also do this with a cutoff wheel or a dremel. This allows you to use the restrictor provisions provided in your Dart block to tune oil volume to the lifter oil galley. This allows you to control the oil going to the pushrods, rocker arms and valve springs.

CAUTION!



The use of lifters that are heavily lightened should not be used in Dart Blocks. The lightening holes will cause lifter oil to leak into the valley instead of oiling the pushrod, rocker arm and valvespring.



- The LS Next² blocks feature Taller and wider main caps, 1/2" main studs that offer superior clamping force over a 7/16" main stud for even higher power levels.
- Available in Iron or Aluminum blocks with LS (2.560") Or Ford (2.750") mains.
- The LS Next² blocks will accept stock crankshafts. And will Accept Fully Counterweighted Crankshafts.
- The Main Torque for the 1/2" fasteners on 1-5 is 105 ft lbs. w/ CMD #3.
- 7/16" Fasteners on 1-5 is 65 ft lbs w/CMD#3.

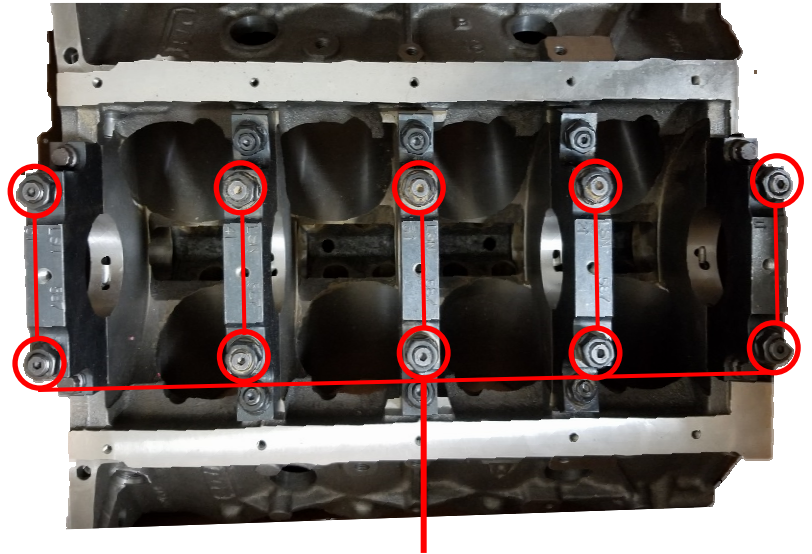

These center Main stud locations on the Iron LS NEXT² Blocks will have Ball Bearings underneath the studs in the block to keep the shoulder of the studs from contacting the counter bores in the block. They must go back in the block in these locations upon re-assembly

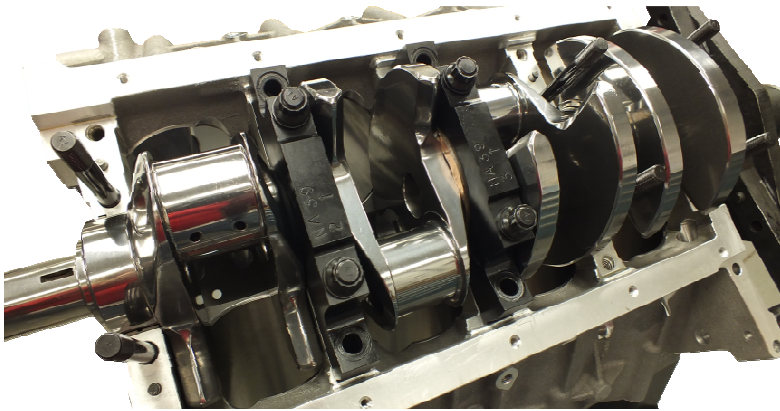

LS Next² Block with 1/2" main studs installed.

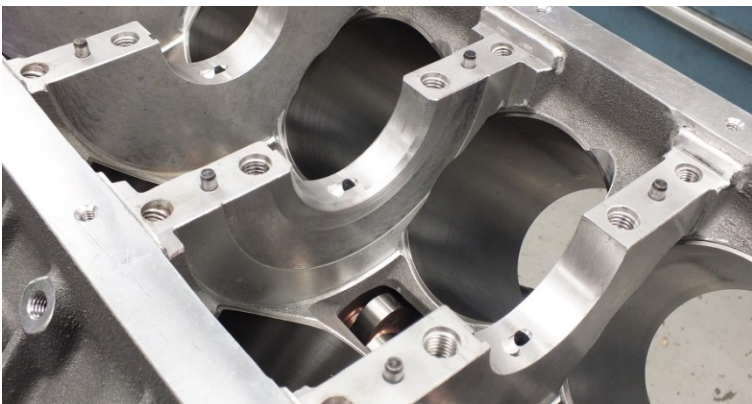

LS Next² Blocks come machined with clearance

LS NEXT

1/2" AN O-Ring plugs

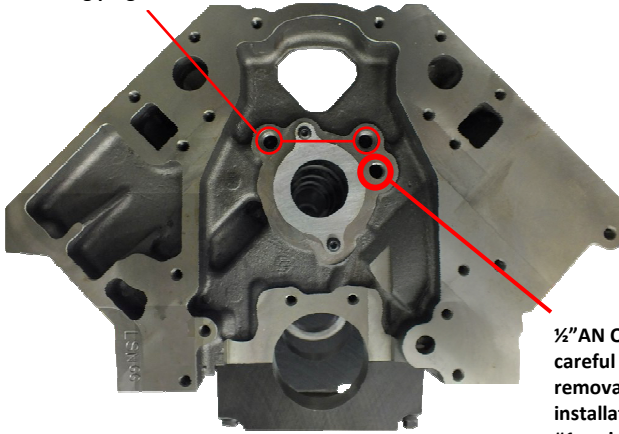

Stock LS Next Front

1/2" AN O-ring plug careful upon removal and re-installation as the #1 main feed is behind this plug

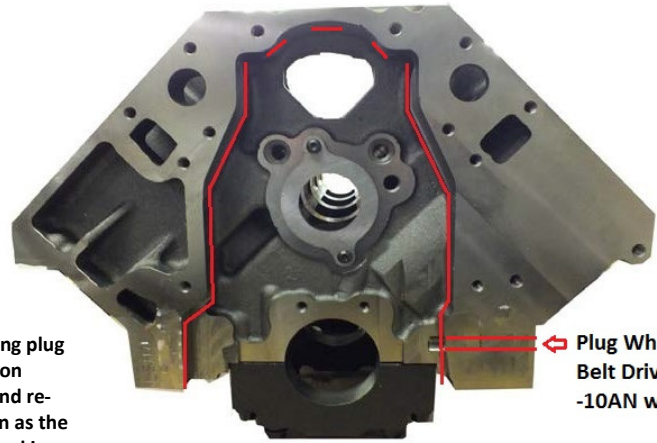

Machined for Jesel Belt Drive

Plug When Jesel Belt Drive is Used -10AN w/ O-ring

Crank Sensor 1/4" Pipe / Water Drain Knock Sensor

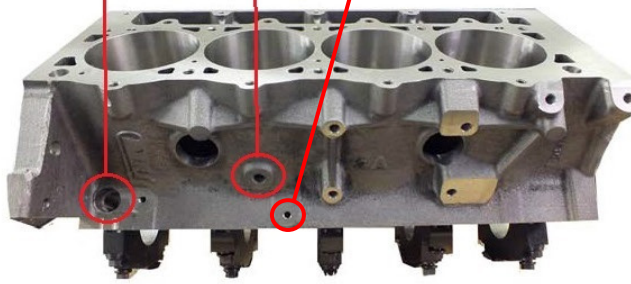

LS Next Passenger Side View

Oil Out -10AN w/ O-ring 1/4" Pipe / Water Drain Oil In -10AN w/ O-ring

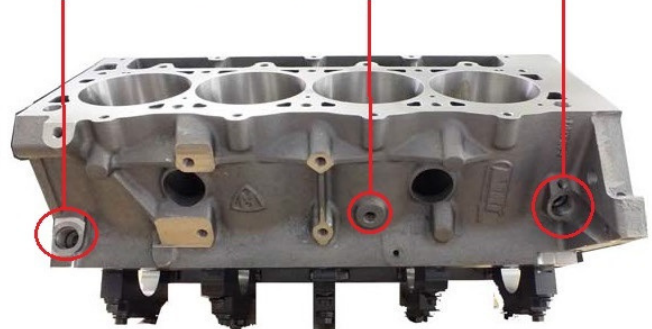

LS Next Drivers Side View

9/16" AN O-Ring Plug Location

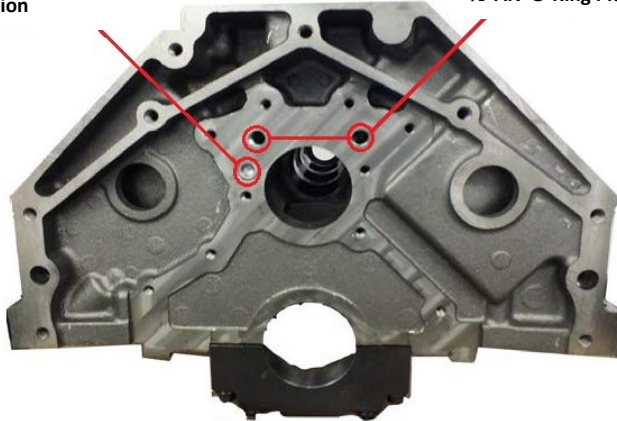

LS Next Rear View

1/2" AN O-Ring Plugs

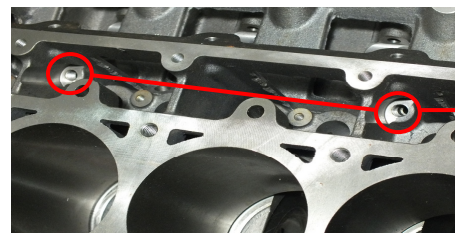

Drivers Side of Block:
The 2 crossovers in the lifter bucket area are 1/8" NPT these should be plugged.

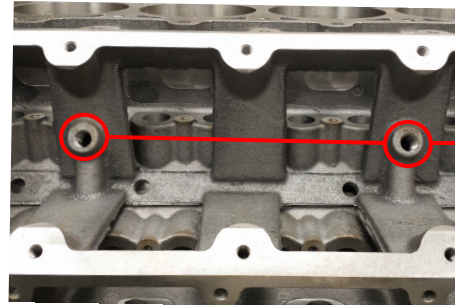

Top View of Valley Area:
The 2 crossovers in the Valley area are 1/4" NPT & are tapped internally for 1/8" NPT Restrictors would go in this location.

LS Next Crossover Locations