



OXYGEN & AIR/FUEL SENSOR



2016  
AUTOMOTIVE CATALOG

# **BUILT** WITH **DENSO**



**DOMESTIC**

**EUROPEAN**

**IMPORT**

For over **50 Years**, when the  
**Top Auto Makers World-Wide**  
build their vehicles, they rely  
on **DENSO**.

**DENSO**  
*first time fit*<sup>®</sup>

## TABLE OF CONTENTS

Company Profile . . . . . E1

### **GENERAL INFORMATION**

Oxygen and Air/Fuel Sensor  
Information . . . . . E2

Oxygen Sensor Positioning . . . . . E6

Universal Sensors and Part Number  
Information . . . . . E9

### **APPLICATION INFORMATION**

Applications by Manufacturer . . . . . 2

### **PRODUCT INFORMATION**

Lead Wire Length/  
Flange Gasket Measurement . . . . . 290

Sensor 4-Wire Color Comparison . . . . . 291

Photo Guide by Part Number . . . . . 292

Numerical Listing . . . . . 527

Cross Reference by Manufacturer . . . . . 599

Part Number/UPC Barcode  
Cross Reference . . . . . 654

New Numbers and Supersessions . . . . . 664



# ABOUT DENSO

## An OE Heritage

DENSO is one of the world's largest automotive component suppliers with over \$35.9 billion in annual sales. We supply every major auto manufacturer in the world, providing them with the quality and innovation they need to remain on the leading edge of automotive technology. In addition to our automotive customers, we also supply components to virtually all OE manufacturers worldwide. For decades we have helped all of our customers to become giants in their industries.

## Unsurpassed Quality

At DENSO we know that one of the major keys to success for our company and our customers is an unwavering commitment to quality. We strive for, and achieve, zero defects for parts manufactured in the millions in DENSO facilities that are ISO9000 and ISO14000 certified. This dedication to quality is clearly recognized by the industry as DENSO has received such prestigious awards as the Deming Award for Quality, the J.D. Power and Associates Chairman's Award and numerous supplier awards for quality from companies like Toyota, Lexus, General Motors and Chrysler.

## Bringing It All To The Aftermarket

In the 1980s, DENSO became the first to mass-produce the platinum spark plug and offer it in the aftermarket. A decade later we introduced the world's most advanced spark plug, Iridium Power®, which revolutionized the concept of the aftermarket performance plug. By the late 1990s, the world watched with great interest as DENSO unveiled a line of OE-standard premium replacement components under the First Time Fit® brand. Today, the First Time Fit line of products includes A/C compressors, cabin air filters, condensers, evaporators, radiators, receiver driers, expansion devices, starters, alternators, oxygen sensors, fuel pumps, oil and air filters, ignition wire sets, tire pressure monitoring system sensors, engine management sensors and wiper blades.

**DENSO is one of the world's largest automotive component suppliers with over \$35.9 billion in annual sales.**

## Better By Design

As you can see, we've spent decades perfecting our craft — a claim few automotive component manufacturers can make. Clearly the DENSO commitment to quality, innovation, and advanced technology is the reason our automotive and heavy-duty components truly are better by design.



# HOW TO USE THIS CATALOG

## To find a unit based on application (Application Section):

1. Locate the application on the page. Applications are sequenced by Year, Make, Model and Engine Type.
2. Find the application line that describes the vehicle options and locate the part number.

## To find a DENSO part number based on an alternate part number (Cross Reference Section):

1. Locate the part number tag on the unit.
2. Locate the Cross Reference section of this catalog.
3. Locate the Manufacturer's Name and part number.
4. The DENSO part numbers are listed on the column to the right of the unit number.

## To compare part with part number listing (Photo Guide Section):

1. Find the part number listing as described above.
2. Locate Photo Guide section in this catalog.
3. Find the DENSO part number listed in the catalog. Images are sequenced by DENSO number.
4. Compare published unit specifications with the unit from the vehicle.

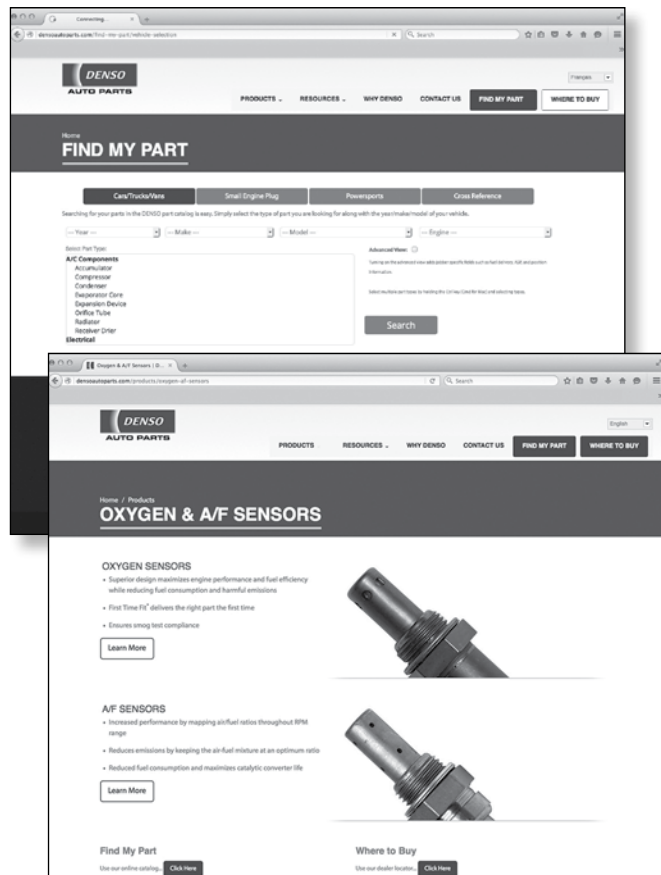

# THE CRITICAL ENGINE COMPONENT

A critical component of today's modern vehicle is the sensor measuring the exhaust gases. This sensor works with the vehicle Electronic Control Unit (ECU) to constantly maintain the operational efficiency of the engine. If the oxygen content in the exhaust gas is too high (a lean mixture) or too low (a rich mixture), the sensor is able to transmit this information back to the ECU, which then adjusts the air to fuel ratio.

Not all vehicles have sensors with the same output characteristics and these sensors are not interchangeable. It is important to confirm sensor type before making the repair.

In vehicles equipped with a heated oxygen sensor, the output voltage changes in accordance with the oxygen concentration in the exhaust gas. The ECU uses this output voltage to determine whether the present air/fuel ratio is richer or leaner than the stoichiometric air/fuel ratio (14.7:1).

Vehicles equipped with an air/fuel ratio sensor have approximately 0.4 V constantly applied to the sensor, which outputs a current that varies in accordance with the oxygen concentration in the exhaust gas. The ECU converts the changes in the output current into voltage allowing a response that is directly proportional to the input of the present air/fuel ratio in the exhaust system.

## DIFFERENCES BETWEEN AN OXYGEN SENSOR AND AN AIR/FUEL SENSOR

The exterior appearance of air/fuel sensor and oxygen sensor may be very similar but that's where the similarity stops. Using a light bulb analogy, the oxygen sensor sends voltage to the vehicle engine control unit and acts like an on/off switch turning the bulb on and off. The air/fuel sensor receives voltage from the vehicle engine control unit and acts like a dimmer switch making the bulb brighten and dim.

**Oxygen Sensor**



**Air/Fuel Sensor**

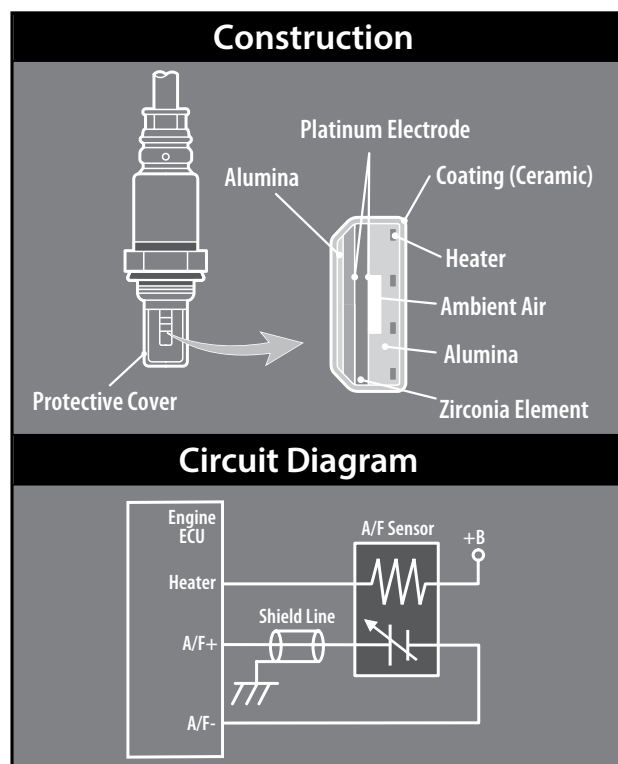
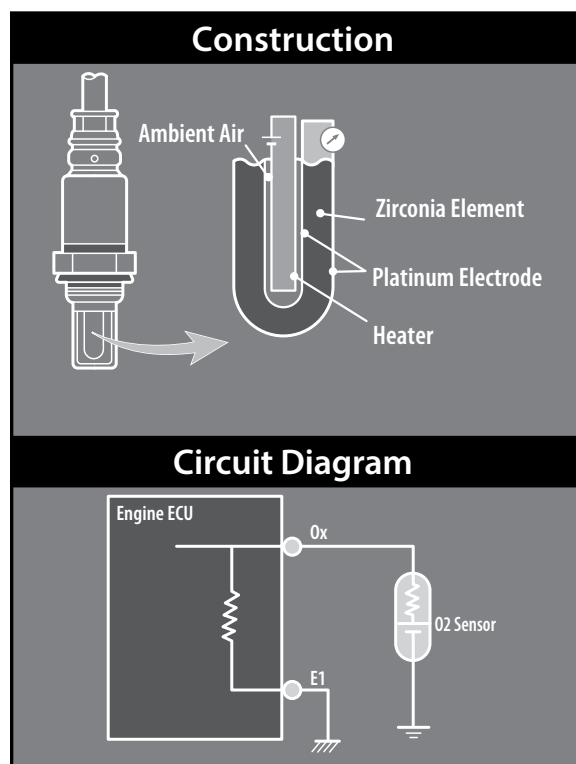

# SUPERIOR OXYGEN SENSOR TECHNOLOGY

## **SUPERIOR DESIGN**

Maximizes engine performance and fuel efficiency while reducing harmful emissions.

## **DOUBLE PROTECTION COVER**

Maintains proper unit temperature for quicker response times and protects the ceramic element against silicone and lead poisoning.

## **ALUMINUM-OXIDE TRAP LAYER**

Keeps silicone and lead outside the ceramic element through DENSO's exclusive design, preventing damage to the platinum electrode.

## **STAINLESS STEEL HOUSING**

Resists corrosion and contamination with a rugged, watertight body.

## **POROUS PTFE FILTER**

Allows atmospheric oxygen to enter the sensor without permitting water or engine contaminants to seep into the casing.



Designed with precision. Manufactured to the strictest OE standards. Subjected to rigorous safety and performance tests. These are the core building tools behind DENSO First Time Fit oxygen sensors, a new line of heated and non-heated configurations guaranteed to fit right the first time, every time. This innovative line features DENSO's exclusive aluminum-oxide trap layer, designed to protect the ceramic element from silicone and lead poisoning for improved engine performance, greater fuel efficiency and unparalleled longevity. Of course, the First Time Fit line of oxygen sensors is just one of many design innovations. DENSO First Time Fit, Better by Design.

# SUPERIOR AIR/FUEL SENSOR TECHNOLOGY

## Air/Fuel Sensor

As with the oxygen sensor, an air/fuel sensor detects the oxygen concentration in the exhaust emissions. However, vehicles equipped with this sensor, have approximately 0.4 V constantly applied to the air/fuel sensor, which outputs a current that varies in accordance with the oxygen concentration in the exhaust gas. The ECM converts the changes in the output current into voltage allowing a response that is directly proportional to the input of the present detected air/fuel ratio.

## Features and Benefits

- Quick activation of zirconia solid electrolyte  
DENSO's planar type air/fuel sensor has a zirconia solid electrolyte integrated with an alumina heater substrate, allowing it to more quickly detect oxygen concentration with a light-off time of 10 seconds.
- High-detection accuracy  
Precisely controls the amount of oxygen ions that flow in the diffusion layer to limit current flow, resulting in high-accuracy detection.

## Air/Fuel Product Types

Product Type	Heater	Light-off Time (Seconds)	Response Time (milliseconds)
Planar Type	Integrated with solid electrolyte	15	200
Thimble type	Integrated with solid electrolyte	20	200

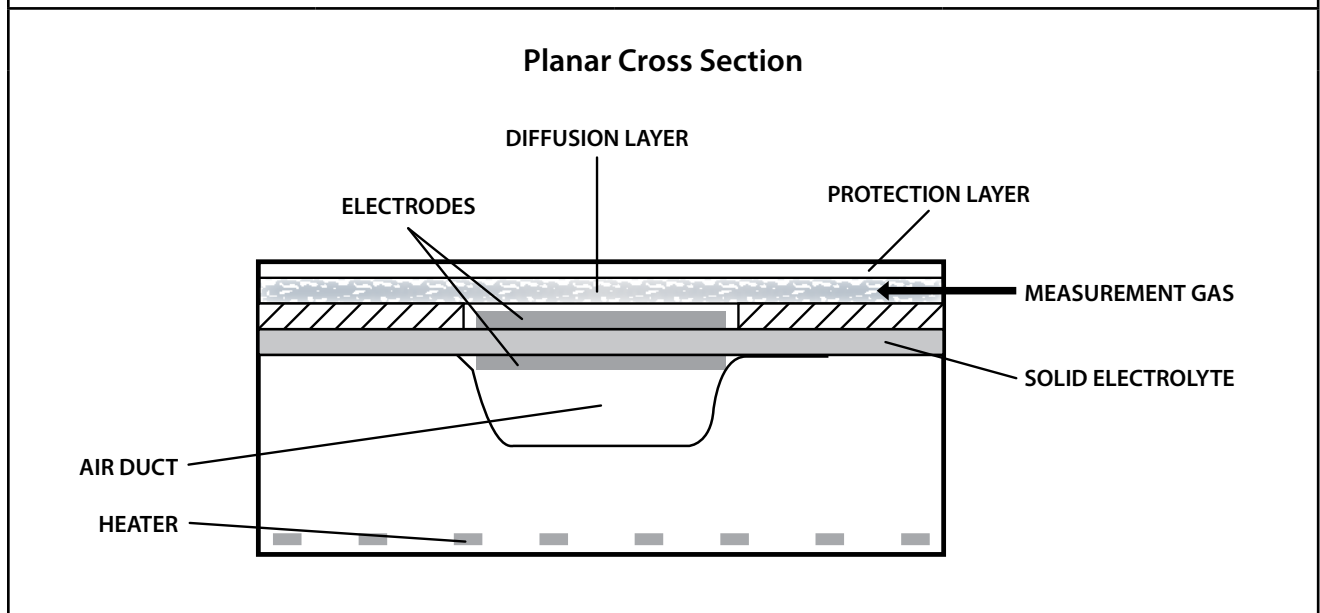



# OXYGEN SENSOR POSITIONING

Many manufacturer's catalogs identify the left and right side positioning; however, diagnostic tools refer to sensor locations by Bank and Sensor (e.g. Bank 1 Sensor 1).

As a general rule, the leading cylinder (Cylinder 1) is the designator of Bank 1.

*The longitudinal engine orientation illustrations depict rear-wheel drive. In cases of transverse engine (front wheel drive), the concepts are the same, however the mounting direction is at a 90 degree rotation left or right from longitudinal.*

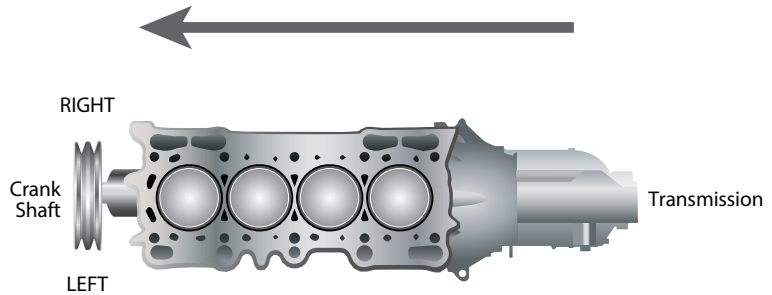

DENSO categorizes left and right sides to the engine block from the viewpoint of the transmission to the crank pulley.

## Inline Single / Split 4/5/6 Cylinder

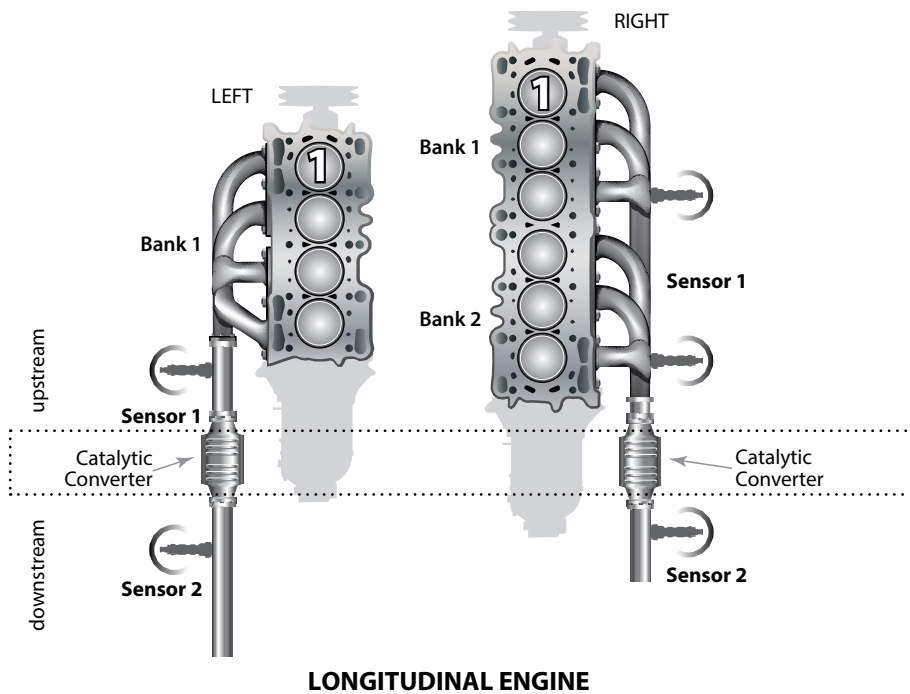

*Engine configurations will vary, please review your service manual or online technical references for accurate engine configuration.*

## V6/8/10 Type Single Exhaust

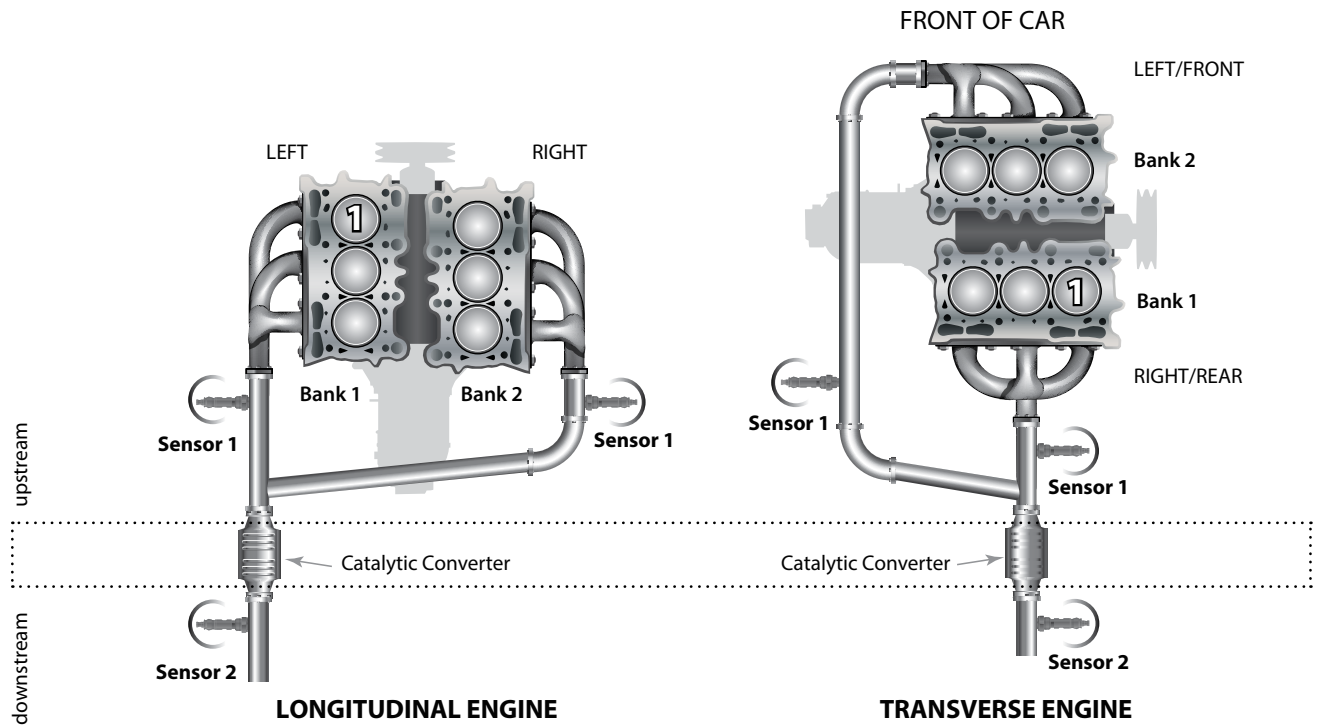

## V6/8/10 Type Dual Exhaust

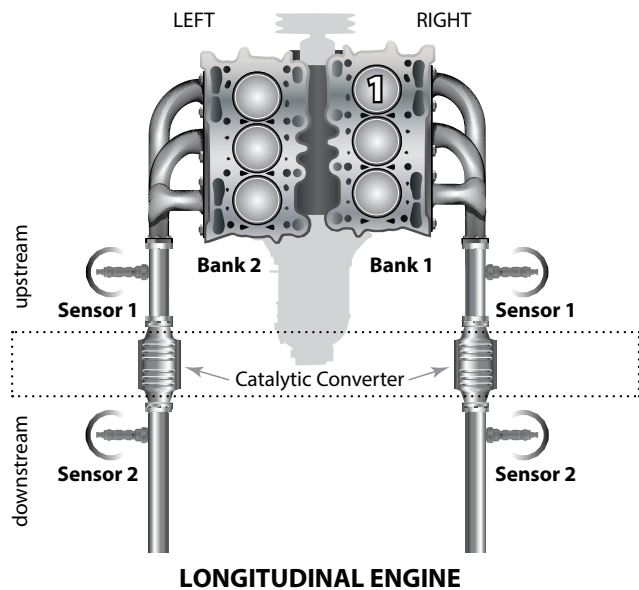

## Three-Sensor Exhaust Systems

In the case of three-sensor exhaust systems, we may have Bank 1 Sensor 1/2/3.

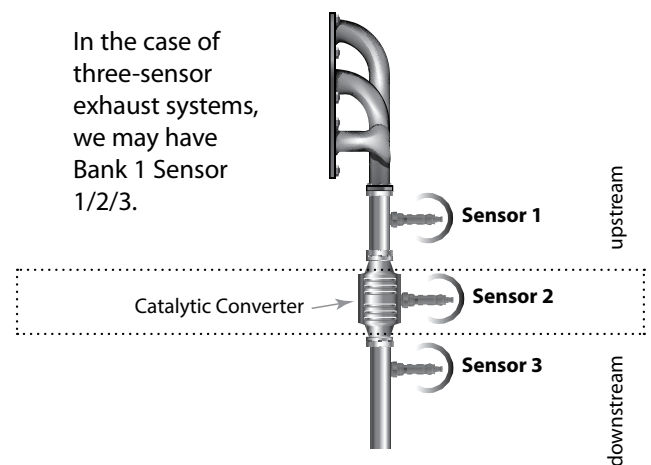

Engine configurations will vary, please review your service manual or online technical references for accurate engine configuration.

# Causes For Air/Fuel Codes

## Causes of a Rich Condition

- Plugged air filter
- Faulty ECU
- Faulty air mass meter
- Faulty air flow meter
- Faulty MAP sensor
- Faulty idle control valve
- Faulty fuel pressure regulator
- Faulty fuel injector(s)
- Restricted fuel return line
- Fouled spark plug(s)
- Faulty ignition wire(s)
- Ignition timing
- Faulty oxygen sensor
- Faulty air fuel sensor
- Faulty PCV
- Faulty EVAP
- Associated wiring
- Engine coolant temperature

## Causes of a Lean Condition

- Vacuum leak
- Faulty ECU
- Faulty air mass meter
- Faulty air flow meter
- Faulty MAP sensor
- Faulty idle control valve
- Faulty fuel pressure regulator
- Faulty fuel pump
- Restricted fuel filter (screen)
- Faulty fuel injector(s)
- Faulty PCV
- Associated wiring
- Exhaust gas leak
- Faulty oxygen sensor
- Faulty air fuel sensor
- Ignition timing
- EGR valve

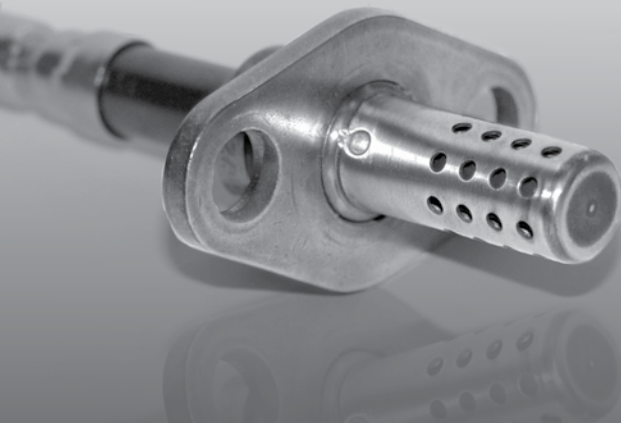

<b>UNIVERSAL &amp; UNIVERSAL FLANGE PART NUMBER INFORMATION</b>		
<b>DENSO PN</b>	<b>WIRE(S)</b>	<b>TYPE*</b>
234-1000	1-wire	Universal
234-1057	1-wire	Uni-flange 44
234-2000	2-wire	Universal
234-2050	2-wire	Uni-flange 44
234-2071	2-wire	Uni-flange 54
234-3000	3-wire	Universal
234-3050	3-wire	Uni-flange 44
234-3090	3-wire	Universal
234-4000	4-wire	Universal
234-4050	4-wire	Uni-flange 44
234-4200	4-wire	Universal
234-4201	4-wire	Universal
234-4206	4-wire	Uni-flange 44
234-4207	4-wire	Uni-flange 54
234-4208	4-wire	Uni-flange 54
234-4209	4-wire	Universal
234-4210	4-wire	Universal
234-4212	4-wire	Universal
234-4700	4-wire	Universal

\*Note: Not all universals are the same, please refer to the catalog application information for selection.

<b>PART NUMBERING SYSTEM</b>					
<b>DENSO PART NUMBER RANGES</b>					
234-1000 to 234-1999	234-2000 to 234-2999	234-3000 to 234-3999	234-4000 to 234-4999	234-5000 to 234-5999	234-9000 to 234-9999
▼	▼	▼	▼	▼	▼
1-wire Unheated	2-wire Unheated	3-wire Heated	4-wire Heated	5-wire Heated A/F	4-wire Heated A/F





## APPLICATION INFORMATION



OXYGEN & AIR/FUEL SENSOR



ENGINE MOTEUR MOTOR	YEAR ANNEE AÑO	APPLICATION INFORMATION INFORMATION D'APPLICATION INFORMACION DE APLICACION	UPSTREAM / AVANT - C.C. / ANTES DEL C.C.		DOWNSTREAM / APRS - C.C. / DESPUES DEL C.C.	
			TYPE / TIPO O.E.	UNIVERS.	TYPE / TIPO O.E.	UNIVERS.
<b>ACURA</b>						
<b>CL</b>						
L4-2.2	1997		234-4095	234-4209	234-4601	234-4209
L4-2.3	1999-1998		234-4095	234-4209	234-4601	234-4209
V6-3.0	1999-1997		234-4099	234-4209	234-4601	234-4209
V6-3.2	2003-2001		234-4727	-	234-4621	234-4209
<b>CSX</b>						
L4-2.0	2011-2006		234-9076	-	234-4358	-
<b>EL</b>						
L4-1.6	2000-1999		234-4733	-	234-4098	234-4209
L4-1.6	1998-1997		234-4099	234-4209	234-4659	234-4209
L4-1.7	2005-2004		234-9017	-	234-4220	234-4209
L4-1.7	2003-2001		234-4122	-	234-4621	234-4209
<b>ILX</b>						
L4-1.5	2014-2013		234-9117	-	234-4743	-
L4-2.0	2015		234-9119	-	234-4979	-
L4-2.0	2014-2013		234-9119	-	234-4350	-
L4-2.4	2016		234-9131	-	234-4786	-
L4-2.4	2015-2013		234-9118	-	234-4581	-
<b>INTEGRA</b>						
L4-1.6	1989-1988		234-1009	234-1000	-	-
L4-1.6	1987-1986		234-1017	234-1000	-	-
L4-1.7	1993-1992		234-4099	234-4209	-	-
L4-1.8	2001-1996		234-4011	234-4209	234-4659	234-4209
L4-1.8	1995-1994		234-4011	234-4209	-	-
L4-1.8	1993-1992		234-4099	234-4209	-	-
L4-1.8	1991		234-1017	234-1000	-	-
L4-1.8	1990		234-1009	234-1000	-	-
<b>LEGEND</b>						
V6-2.5	1987-1986		234-1009 <sup>4</sup>	234-1000 <sup>4</sup>	-	-
V6-2.5	1987-1986		234-1017 <sup>5</sup>	234-1000 <sup>5</sup>	-	-
V6-2.7	1990-1987		234-1009 <sup>4</sup>	234-1000 <sup>4</sup>	-	-
V6-2.7	1990-1987		234-1017 <sup>5</sup>	234-1000 <sup>5</sup>	-	-
V6-3.2	1995-1991		234-4093 <sup>4</sup>	234-4209 <sup>4</sup>	-	-
V6-3.2	1995-1991		234-4065 <sup>5</sup>	234-4209 <sup>5</sup>	-	-
<b>MDX</b>						
V6-3.5	2016-2014		234-5056 <sup>15</sup>	-	234-4781 <sup>15</sup>	-
V6-3.5	2016-2014		234-5056 <sup>16</sup>	-	234-4790 <sup>16</sup>	-
V6-3.5	2006-2003		234-5010 <sup>15</sup>	-	234-4355 <sup>15</sup>	-
V6-3.5	2006-2003		234-5010 <sup>16</sup>	-	234-4368 <sup>16</sup>	-
V6-3.5	2002-2001		234-4368	-	234-4601	234-4209

<sup>1</sup> 2 Required / Requis 2 / Requeridos 2 <sup>4</sup> Left Side / Côté gauche / Lado izquierdo <sup>5</sup> Right Side / Côté droit / Lado derecho <sup>15</sup> Front / Avant / Parte delantera <sup>16</sup> Rear / Arrière / Parte trasera



ENGINE MOTEUR MOTOR	YEAR ANNEE AÑO	APPLICATION INFORMATION INFORMATION D'APPLICATION INFORMACION DE APLICACION	UPSTREAM / AVANT - C.C. / ANTES DEL C.C.		DOWNSTREAM / APRS - C.C. / DESPUES DEL C.C.	
			TYPE / TIPO O.E.	UNIVERS.	TYPE / TIPO O.E.	UNIVERS.
<b>ACURA [cont]</b>						
<b>MDX [cont]</b>						
V6-3.7	2013-2010		234-5098 <sup>1</sup>	-	234-4461 <sup>1</sup>	-
V6-3.7	2009-2007		234-5053 <sup>1</sup>	-	234-4351 <sup>1</sup>	-
<b>NSX</b>						
V6-3.0	2005-2000		234-4729 <sup>15</sup>	-	234-4093 <sup>15</sup>	234-4209 <sup>15</sup>
V6-3.0	2005-2000		234-4729 <sup>16</sup>	-	234-4621 <sup>16</sup>	234-4209 <sup>16</sup>
V6-3.0	1999-1995		234-4093 <sup>15</sup>	234-4209 <sup>15</sup>	234-4099 <sup>15</sup>	234-4209 <sup>15</sup>
V6-3.0	1999-1995		234-4065 <sup>16</sup>	234-4209 <sup>16</sup>	234-4092 <sup>16</sup>	234-4209 <sup>16</sup>
V6-3.0	1994-1991		234-4093 <sup>15</sup>	234-4209 <sup>15</sup>	-	-
V6-3.0	1994-1991		234-4065 <sup>16</sup>	234-4209 <sup>16</sup>	-	-
V6-3.2	2005-2000		234-4730 <sup>15</sup>	-	234-4093 <sup>15</sup>	234-4209 <sup>15</sup>
V6-3.2	2005-2000		234-4730 <sup>16</sup>	-	234-4621 <sup>16</sup>	234-4209 <sup>16</sup>
V6-3.2	1999-1997		234-4100 <sup>15</sup>	234-4209 <sup>15</sup>	234-4099 <sup>15</sup>	234-4209 <sup>15</sup>
V6-3.2	1999-1997		234-4100 <sup>16</sup>	234-4209 <sup>16</sup>	234-4092 <sup>16</sup>	234-4209 <sup>16</sup>
<b>RDX</b>						
L4-2.3	2012-2007		234-9061	-	234-4351	-
V6-3.5	2016		234-5056 <sup>16</sup>	-	234-4790 <sup>16</sup>	-
V6-3.5	2016		234-5056 <sup>15</sup>	-	-	-
V6-3.5	2015-2013		234-5056 <sup>15</sup>	-	234-4743 <sup>15</sup>	-
V6-3.5	2015-2013		234-5056 <sup>16</sup>	-	234-4461 <sup>16</sup>	-
<b>RL</b>						
V6-3.5	2008-2005		234-5010 <sup>15</sup>	-	234-4355 <sup>15</sup>	-
V6-3.5	2008-2005		234-5010 <sup>16</sup>	-	234-4368 <sup>16</sup>	-
V6-3.5	2004		234-4443 <sup>1</sup>	-	234-4097	234-4209
V6-3.5	2003-1996		234-4093 <sup>4</sup>	234-4209 <sup>4</sup>	234-4097	234-4209
V6-3.5	2003-1996		234-4065 <sup>5</sup>	234-4209 <sup>5</sup>	-	-
V6-3.7	2012-2011		234-5098 <sup>15</sup>	-	234-4461 <sup>15</sup>	-
V6-3.7	2012-2011		234-5098 <sup>16</sup>	-	234-4351 <sup>16</sup>	-
V6-3.7	2010-2009		234-5018 <sup>15</sup>	-	234-4461 <sup>15</sup>	-
V6-3.7	2010-2009		234-5018 <sup>16</sup>	-	234-4351 <sup>16</sup>	-
<b>RLX</b>						
V6-3.5	2016		-	-	234-4790 <sup>16</sup>	-
V6-3.5	2016	Gas Engine	234-5056 <sup>15</sup>	-	234-4781 <sup>15</sup>	-
V6-3.5	2016	Hybrid Engine	234-5152 <sup>15</sup>	-	234-4781 <sup>15</sup>	-
V6-3.5	2015		234-5056 <sup>16</sup>	-	234-4790 <sup>16</sup>	-
V6-3.5	2015	AWD	234-5056 <sup>15</sup>	-	-	-
V6-3.5	2015	FWD	234-5056 <sup>15</sup>	-	234-4781 <sup>15</sup>	-
V6-3.5	2014	Gas Engine	234-5056 <sup>15</sup>	-	234-4790 <sup>15</sup>	-
V6-3.5	2014	Gas Engine	234-5056 <sup>16</sup>	-	234-4781 <sup>16</sup>	-
V6-3.5	2014	Hybrid Engine	234-5152 <sup>15</sup>	-	234-4790 <sup>15</sup>	-

<sup>1</sup> 2 Required / Requis 2 / Requeridos 2 <sup>4</sup> Left Side / Côté gauche / Lado izquierdo <sup>5</sup> Right Side / Côté droit / Lado derecho <sup>15</sup> Front / Avant / Parte delantera <sup>16</sup> Rear / Arrière / Parte trasera



ENGINE MOTEUR MOTOR	YEAR ANNEE AÑO	APPLICATION INFORMATION INFORMATION D'APPLICATION INFORMACION DE APLICACION	UPSTREAM / AVANT - C.C. / ANTES DEL C.C.		DOWNSTREAM / APRES - C.C. / DESPUES DEL C.C.	
			TYPE / TIPO O.E.	UNIVERS.	TYPE / TIPO O.E.	UNIVERS.
<b>ACURA [cont]</b>						
<b>RLX [cont]</b>						
V6-3.5	2014	Hybrid Engine	234-5152 <sup>16</sup>	-	234-4781 <sup>16</sup>	-
<b>RSX</b>						
L4-2.0	2006-2005	Auto Trans	234-9065	-	234-4354	-
L4-2.0	2006-2005	Manual Trans	234-9064	-	234-4354	-
L4-2.0	2004-2002	Exc. Type S; Auto Trans	234-9006	-	234-4122	-
L4-2.0	2004-2002	Exc. Type S; Manual Trans	234-9004	-	234-4122	-
L4-2.0	2004-2002	Type S	234-9005	-	234-4360	-
<b>SLX</b>						
V6-3.2	1997-1996		234-4012 <sup>1</sup>	234-4000 <sup>1</sup>	234-4012 <sup>1</sup>	234-4000 <sup>1</sup>
V6-3.5	1999-1998		234-4012 <sup>1</sup>	234-4000 <sup>1</sup>	234-4012 <sup>1</sup>	234-4000 <sup>1</sup>
<b>TL</b>						
L5-2.5	1998-1995		234-4726	-	234-4097	234-4209
V6-3.2	2008-2007		234-5010 <sup>1</sup>	-	234-4351 <sup>1</sup>	-
V6-3.2	2006-2004		234-5010 <sup>16</sup>	-	234-4368 <sup>16</sup>	-
V6-3.2	2006-2004	Auto Trans	234-5010 <sup>15</sup>	-	234-4355 <sup>15</sup>	-
V6-3.2	2006-2004	Manual Trans	234-5010 <sup>15</sup>	-	234-4368 <sup>15</sup>	-
V6-3.2	2003-2000		234-4727	-	234-4621	234-4209
V6-3.2	1999	Calif.	234-4065	234-4209	234-4621	234-4209
V6-3.2	1999	Exc. Calif.	234-4065	234-4209	234-4601	234-4209
V6-3.2	1998-1996		234-4093 <sup>4</sup>	234-4209 <sup>4</sup>	234-4097	234-4209
V6-3.2	1998-1996		234-4065 <sup>5</sup>	234-4209 <sup>5</sup>	-	-
V6-3.5	2014-2009		234-5098 <sup>1</sup>	-	234-4461 <sup>1</sup>	-
V6-3.5	2008-2007		234-5010 <sup>1</sup>	-	234-4351 <sup>1</sup>	-
V6-3.7	2014-2010		234-5098 <sup>16</sup>	-	234-4461 <sup>16</sup>	-
V6-3.7	2014-2010	Auto Trans	234-5098 <sup>15</sup>	-	234-4461 <sup>15</sup>	-
V6-3.7	2014-2010	Manual Trans	234-5098 <sup>15</sup>	-	234-4543 <sup>15</sup>	-
V6-3.7	2009		234-5098 <sup>1</sup>	-	234-4461 <sup>1</sup>	-
<b>TLX</b>						
L4-2.4	2015		234-9131	-	234-4786	-
V6-3.5	2015		234-5056 <sup>15</sup>	-	234-4781 <sup>15</sup>	-
V6-3.5	2015		234-5056 <sup>16</sup>	-	234-4790 <sup>16</sup>	-
<b>TSX</b>						
L4-2.4	2014-2009		234-9091	-	234-4462	-
L4-2.4	2008-2004		234-9066	-	234-4363	-
V6-3.5	2014-2010		234-5098 <sup>1</sup>	-	234-4461 <sup>1</sup>	-
<b>VIGOR</b>						
L5-2.5	1994-1992		234-4011	234-4209	-	-
<b>ZDX</b>						
V6-3.7	2013		234-5098 <sup>15</sup>	-	234-4787 <sup>15</sup>	-
V6-3.7	2013		234-5098 <sup>16</sup>	-	234-4461 <sup>16</sup>	-

<sup>1</sup> 2 Required / Requis 2 / Requeridos 2 <sup>4</sup> Left Side / Côté gauche / Lado izquierdo <sup>5</sup> Right Side / Côté droit / Lado derecho <sup>15</sup> Front / Avant / Parte delantera <sup>16</sup> Rear / Arrière / Parte trasera





ENGINE MOTEUR MOTOR	YEAR ANNEE AÑO	APPLICATION INFORMATION INFORMATION D'APPLICATION INFORMACION DE APLICACION	UPSTREAM / AVANT - C.C. / ANTES DEL C.C.		DOWNSTREAM / APRS - C.C. / DESPUES DEL C.C.	
			TYPE / TIPO O.E.	UNIVERS.	TYPE / TIPO O.E.	UNIVERS.
<b>ACURA [cont]</b>						
<b>ZDX [cont]</b>						
V6-3.7	2012-2010		234-5098 <sup>1</sup>	-	234-4461 <sup>1</sup>	-
<b>ALFA ROMEO</b>						
<b>164</b>						
V6-3.0	1994		-	234-3090	-	-
V6-3.0	1993-1991		234-3048	234-3000	-	-
<b>GTV-6</b>						
V6-2.5	1986-1983		234-3027	234-3000	-	-
V6-2.5	1982-1981		-	234-1000	-	-
<b>MILANO</b>						
V6-2.5	1989-1988		234-3048	234-3000	-	-
V6-2.5	1987		234-3027	234-3000	-	-
V6-3.0	1989-1987		234-3048	234-3000	-	-
<b>SPIDER</b>						
L4-2.0	1994-1990		234-3048	234-3000	-	-
L4-2.0	1989-1986		234-3027	234-3000	-	-
L4-2.0	1985-1982		-	234-1000	-	-
<b>AM GENERAL</b>						
<b>HUMMER</b>						
V8-5.7	1996-1995		234-1001	234-1000	-	-
<b>AMERICAN MOTORS</b>						
<b>AMX</b>						
L6-4.2	1980		234-2007	234-2000	-	-
<b>CONCORD</b>						
L4-2.5	1982	Calif.	234-2007	234-2000	-	-
L4-2.5	1982	Exc. Calif.	234-1003	234-1000	-	-
L4-2.5	1981-1980		234-2007	234-2000	-	-
L6-4.2	1983-1981		234-1003	234-1000	-	-
L6-4.2	1980		234-2007	234-2000	-	-
<b>EAGLE</b>						
L4-2.5	1984-1983		234-1003	234-1000	-	-
L4-2.5	1982	Calif.	234-2007	234-2000	-	-
L4-2.5	1982	Exc. Calif.	234-1003	234-1000	-	-
L4-2.5	1981		234-2007	234-2000	-	-
L6-4.2	1988-1981		234-1003	234-1000	-	-
L6-4.2	1980		234-2007	234-2000	-	-
<b>PACER</b>						
L6-4.2	1980		234-2007	234-2000	-	-



ENGINE MOTEUR MOTOR	YEAR ANNEE AÑO	APPLICATION INFORMATION INFORMATION D'APPLICATION INFORMACION DE APLICACION	UPSTREAM / AVANT - C.C. / ANTES DEL C.C.		DOWNSTREAM / APRS - C.C. / DESPUES DEL C.C.	
			TYPE / TIPO O.E.	UNIVERS.	TYPE / TIPO O.E.	UNIVERS.
<b>AMERICAN MOTORS [cont]</b>						
<b>SPIRIT</b>						
L4-2.5	1982	Calif.	234-2007	234-2000	-	-
L4-2.5	1982	Exc. Calif.	234-1003	234-1000	-	-
L4-2.5	1981-1980		234-2007	234-2000	-	-
L6-4.2	1983-1981		234-1003	234-1000	-	-
L6-4.2	1980		234-2007	234-2000	-	-
<b>ASUNA</b>						
<b>GT</b>						
L4-1.6	1993		234-1001	234-1000	-	-
<b>SE</b>						
L4-1.6	1993		234-1001	234-1000	-	-
<b>SUNFIRE</b>						
L4-1.8	1993		234-4062	234-4209	-	-
<b>SUNRUNNER</b>						
L4-1.6	1993	Calif.	234-4060	234-4209	-	-
L4-1.6	1993	Exc. Calif.	234-3004	234-3000	-	-
L4-1.6	1992		234-3004	234-3000	-	-
<b>AUDI</b>						
<b>80</b>						
L4-2.0	1990-1988		234-3048	234-3000	-	-
L5-2.3	1992-1991		234-3048	234-3000	-	-
<b>80 QUATTRO</b>						
L5-2.3	1992-1988		234-3048	234-3000	-	-
<b>90</b>						
L4-2.0	1988		234-3048	234-3000	-	-
L5-2.3	1991-1988		234-3048	234-3000	-	-
V6-2.8	1995-1994		234-3101 <sup>1</sup>	234-3090 <sup>1</sup>	-	-
V6-2.8	1993		234-3101	234-3090	-	-
<b>90 QUATTRO</b>						
L5-2.3	1992-1988		234-3048	234-3000	-	-
V6-2.8	1995-1993	From Chassis # 8CP-190-001	234-3101 <sup>1</sup>	234-3090 <sup>1</sup>	-	-
V6-2.8	1993	To Chassis # 8CP-190-000	234-3032	234-3000	-	-
<b>100 QUATTRO</b>						
L5-2.3	1991-1989		234-3048	234-3000	-	-
V6-2.8	1994	3 Lead Sensor	234-3101 <sup>1</sup>	234-3090 <sup>1</sup>	-	-
V6-2.8	1994	4 Lead Sensor	234-4660 <sup>1</sup>	234-4201 <sup>1</sup>	-	-
V6-2.8	1993-1992	To Chassis #4A-P-022 306	234-3032 <sup>1</sup>	234-3000 <sup>1</sup>	-	-
V6-2.8	1993	From Chassis #4A-P-022 307	234-3101 <sup>1</sup>	234-3090 <sup>1</sup>	-	-

<sup>1</sup> 2 Required / Requis 2 / Requeridos 2



ENGINE MOTEUR MOTOR	YEAR ANNEE AÑO	APPLICATION INFORMATION INFORMATION D'APPLICATION INFORMACION DE APLICACION	UPSTREAM / AVANT - C.C. / ANTES DEL C.C.		DOWNSTREAM / APRS - C.C. / DESPUES DEL C.C.	
			TYPE / TIPO O.E.	UNIVERS.	TYPE / TIPO O.E.	UNIVERS.
<b>AUDI [cont]</b>						
<b>100 SERIES</b>						
L5-2.3	1991-1989		234-3048	234-3000	-	-
V6-2.8	1994-1993	3 Lead Sensor	234-3101 <sup>1</sup>	234-3090 <sup>1</sup>	-	-
V6-2.8	1994	4 Lead Sensor	234-4660 <sup>1</sup>	234-4201 <sup>1</sup>	-	-
V6-2.8	1992		234-3032 <sup>1</sup>	234-3000 <sup>1</sup>	-	-
<b>200</b>						
L5-2.2	1991-1989		234-3048	234-3000	-	-
<b>200 QUATTRO</b>						
L5-2.2	1991-1989		234-3048	234-3000	-	-
<b>4000</b>						
L4-1.6	1980		-	234-1000	-	-
L4-1.7	1983-1981		-	234-1000	-	-
L4-1.8	1987-1985		234-3019	234-3090	-	-
L4-1.8	1984		-	234-1000	-	-
L5-2.2	1986-1980		-	234-1000	-	-
<b>4000 QUATTRO</b>						
L5-2.2	1987-1984		234-1011	234-1000	-	-
<b>5000</b>						
L5-2.2	1988-1986	Turbo	234-3048	234-3000	-	-
L5-2.2	1987-1979	Non-Turbo	-	234-1000	-	-
L5-2.2	1985-1982	Turbo	234-1011	234-1000	-	-
L5-2.3	1988-1987		234-3048	234-3000	-	-
<b>5000 QUATTRO</b>						
L5-2.2	1988-1986		234-3048	234-3000	-	-
L5-2.3	1988-1987		234-3048	234-3000	-	-
<b>A3</b>						
L4-1.8	2015		234-5143	-	-	-
L4-2.0	2015	Diesel Engine	234-5036	-	-	-
L4-2.0	2013-2010	Diesel Engine	234-5036	-	234-5116	-
L4-2.0	2013-2008	Gas Engine; CBFA Engine	234-5036	-	234-4754	-
L4-2.0	2013-2008	Gas Engine; CBFA Engine; Loc. Center	234-4829 <sup>12</sup>	-	-	-
L4-2.0	2013-2008	Gas Engine; CCTA Engine	234-5107	-	234-4754	-
L4-2.0	2008-2006	Gas Engine; BPY Engine	234-5107	-	234-4754	-
<b>A3 QUATTRO</b>						
L4-2.0	2015	Gas Engine	234-5185	-	234-4992	-
L4-2.0	2013-2010		234-5107	-	234-4754	-
L4-2.0	2009	CBFA Engine	234-5036	-	234-4754	-
L4-2.0	2009	CBFA Engine; Loc. Center	234-4829 <sup>12</sup>	-	-	-
L4-2.0	2009	CCTA Engine	234-5107	-	234-4754	-
V6-3.2	2009-2006		234-5102 <sup>4</sup>	-	234-4832 <sup>4</sup>	-

<sup>1</sup> 2 Required / Requis 2 / Requeridos 2 <sup>4</sup> Left Side / Côté gauche / Lado izquierdo <sup>5</sup> Right Side / Côté droit / Lado derecho <sup>12</sup> Loc. Center / Empl. central / Ubicación central



ENGINE MOTEUR MOTOR	YEAR ANNEE AÑO	APPLICATION INFORMATION INFORMATION D'APPLICATION INFORMACION DE APLICACION	UPSTREAM / AVANT - C.C. / ANTES DEL C.C.		DOWNSTREAM / APRES - C.C. / DESPUES DEL C.C.	
			TYPE / TIPO O.E.	UNIVERS.	TYPE / TIPO O.E.	UNIVERS.
<b>AUDI [cont]</b>						
<b>A3 QUATTRO [cont]</b>						
V6-3.2	2009-2006		234-5125 <sup>5</sup>	-	234-4849 <sup>5</sup>	-
<b>A4</b>						
L4-1.8	2006-2001		234-5115	-	234-4874	-
L4-1.8	2000		234-4874	-	234-4874	-
L4-1.8	1999-1997		234-4666	234-4201	234-4664	234-4200
L4-2.0	2015-2011		234-5019	-	234-4754	-
L4-2.0	2010-2009	CAEB Engine	234-5019	-	234-4231	-
L4-2.0	2009	BWT Engine	234-5102	-	234-4829	-
L4-2.0	2008-2005		234-5102	-	234-4829	-
V6-2.8	2001-2000		234-4812 <sup>1</sup>	-	234-4812 <sup>1</sup>	-
V6-2.8	1999-1997	AHA Engine	234-4664 <sup>1</sup>	234-4200 <sup>1</sup>	234-4661 <sup>1</sup>	234-4201 <sup>1</sup>
V6-2.8	1997-1996	AFC Engine	234-3102 <sup>1</sup>	234-3090 <sup>1</sup>	234-4661 <sup>1</sup>	234-4201 <sup>1</sup>
V6-3.0	2005		234-5028 <sup>4</sup>	-	234-4808 <sup>4</sup>	-
V6-3.0	2005		234-5028 <sup>5</sup>	-	234-4809 <sup>5</sup>	-
V6-3.0	2004-2002		234-5028 <sup>1</sup>	-	234-4874 <sup>1</sup>	-
V6-3.2	2008-2007		234-5120 <sup>4</sup>	-	234-4413 <sup>4</sup>	-
V6-3.2	2008-2007		234-5120 <sup>5</sup>	-	234-4414 <sup>5</sup>	-
V6-3.2	2006	From Chassis #8E-6-035 001	234-5120 <sup>4</sup>	-	234-4413 <sup>4</sup>	-
V6-3.2	2006	From Chassis #8E-6-035 001	234-5120 <sup>5</sup>	-	234-4414 <sup>5</sup>	-
V6-3.2	2006	To Chassis #8E-6-035 000	234-5120 <sup>4</sup>	-	234-4409 <sup>4</sup>	-
V6-3.2	2006	To Chassis #8E-6-035 000	234-5120 <sup>5</sup>	-	234-4408 <sup>5</sup>	-
<b>A4 ALLROAD</b>						
L4-2.0	2015-2013		234-5019	-	234-4754	-
<b>A4 QUATTRO</b>						
L4-1.8	2005-2001		234-5115	-	234-4874	-
L4-1.8	2000-1997	AEB Engine	234-4666	234-4201	234-4664	234-4200
L4-1.8	2000	ATW Engine	234-4874	-	234-4874	-
L4-2.0	2015-2011		234-5019	-	234-4754	-
L4-2.0	2010-2009	CAEB Engine	234-5019	-	234-4231	-
L4-2.0	2009	BWT Engine	234-5102	-	234-4829	-
L4-2.0	2008-2005		234-5102	-	234-4829	-
V6-2.8	2001-2000		234-4812 <sup>1</sup>	-	234-4812 <sup>1</sup>	-
V6-2.8	1999-1998		234-4664 <sup>1</sup>	234-4200 <sup>1</sup>	234-4661 <sup>1</sup>	234-4201 <sup>1</sup>
V6-2.8	1997-1996		234-3102 <sup>1</sup>	234-3090 <sup>1</sup>	234-4661 <sup>1</sup>	234-4201 <sup>1</sup>
V6-3.0	2006-2005		234-5028 <sup>4</sup>	-	234-4808 <sup>4</sup>	-
V6-3.0	2006-2005		234-5028 <sup>5</sup>	-	234-4809 <sup>5</sup>	-
V6-3.0	2004-2002		234-5028 <sup>1</sup>	-	234-4874 <sup>1</sup>	-
V6-3.2	2009-2007	BKH Engine	234-5120 <sup>4</sup>	-	234-4413 <sup>4</sup>	-
V6-3.2	2009-2007	BKH Engine	234-5120 <sup>5</sup>	-	234-4414 <sup>5</sup>	-
V6-3.2	2009	CALA Engine	234-5164 <sup>1</sup>	-	234-4120 <sup>1</sup>	-

<sup>1</sup> 2 Required / Requis 2 / Requeridos 2 <sup>4</sup> Left Side / Côté gauche / Lado izquierdo <sup>5</sup> Right Side / Côté droit / Lado derecho



ENGINE MOTEUR MOTOR	YEAR ANNEE AÑO	APPLICATION INFORMATION INFORMATION D'APPLICATION INFORMACION DE APLICACION	UPSTREAM / AVANT - C.C. / ANTES DEL C.C.		DOWNSTREAM / APRS - C.C. / DESPUES DEL C.C.	
			TYPE / TIPO O.E.	UNIVERS.	TYPE / TIPO O.E.	UNIVERS.
<b>AUDI [cont]</b>						
<b>A4 QUATTRO [cont]</b>						
V6-3.2	2006	From Chassis #8E-6-035 001	234-5120 <sup>4</sup>	-	234-4413 <sup>4</sup>	-
V6-3.2	2006	From Chassis #8E-6-035 001	234-5120 <sup>5</sup>	-	234-4414 <sup>5</sup>	-
V6-3.2	2006	To Chassis #8E-6-035 000	234-5120 <sup>4</sup>	-	234-4409 <sup>4</sup>	-
V6-3.2	2006	To Chassis #8E-6-035 000	234-5120 <sup>5</sup>	-	234-4408 <sup>5</sup>	-
V6-3.2	2005		234-5120 <sup>4</sup>	-	234-4409 <sup>4</sup>	-
V6-3.2	2005		234-5120 <sup>5</sup>	-	234-4408 <sup>5</sup>	-
<b>A5</b>						
L4-2.0	2014-2011		234-5019	-	234-4754	-
L4-2.0	2010		234-5019	-	234-4231	-
<b>A5 QUATTRO</b>						
L4-2.0	2015-2011		234-5019	-	234-4754	-
L4-2.0	2010		234-5019	-	234-4231	-
V6-3.2	2010-2008	LEV	234-5120 <sup>1</sup>	-	234-4120 <sup>1</sup>	-
V6-3.2	2010-2008	ULEV	234-5164 <sup>1</sup>	-	234-4120 <sup>1</sup>	-
<b>A6</b>						
L4-2.0	2015-2012		234-5019	-	234-4754	-
V6-2.8	2001-2000		234-4812 <sup>1</sup>	-	234-4812 <sup>1</sup>	-
V6-2.8	1999		234-4664 <sup>1</sup>	234-4200 <sup>1</sup>	234-4661 <sup>1</sup>	234-4201 <sup>1</sup>
V6-2.8	1998	From Serial #4B-W-000 001	234-4664 <sup>1</sup>	234-4200 <sup>1</sup>	234-4661 <sup>1</sup>	234-4201 <sup>1</sup>
V6-2.8	1998	To Serial #4A-W-005 000	234-3101 <sup>1</sup>	234-3090 <sup>1</sup>	234-4660 <sup>1</sup>	234-4201 <sup>1</sup>
V6-2.8	1997-1996		234-3101 <sup>1</sup>	234-3090 <sup>1</sup>	234-4660 <sup>1</sup>	234-4201 <sup>1</sup>
V6-2.8	1995		234-3101 <sup>1</sup>	234-3090 <sup>1</sup>	-	-
V6-3.0	2004-2002		234-5028 <sup>1</sup>	-	234-4874 <sup>1</sup>	-
V6-3.2	2011-2010	Cylinder 1,2,3	234-5164	-	234-4408	-
V6-3.2	2011-2010	Cylinder 4,5,6	234-5164	-	234-4409	-
V6-3.2	2009-2006	Cylinder 1,2,3	234-5120	-	234-4414	-
V6-3.2	2009-2006	Cylinder 4,5,6	234-5120	-	234-4413	-
<b>A6 QUATTRO</b>						
L4-2.0	2015-2013		234-5019	-	234-4754	-
V6-2.7	2004-2002		234-4859 <sup>1</sup>	-	234-4874 <sup>1</sup>	-
V6-2.7	2001-2000		234-4812 <sup>1</sup>	-	234-4812 <sup>1</sup>	-
V6-2.8	2001-2000		234-4812 <sup>1</sup>	-	234-4812 <sup>1</sup>	-
V6-2.8	1999		234-4664 <sup>1</sup>	234-4200 <sup>1</sup>	234-4661 <sup>1</sup>	234-4201 <sup>1</sup>
V6-2.8	1998	From Serial #4B-W-000 001	234-4664 <sup>1</sup>	234-4200 <sup>1</sup>	234-4661 <sup>1</sup>	234-4201 <sup>1</sup>
V6-2.8	1998	To Serial #4A-W-005 000	234-3101 <sup>1</sup>	234-3090 <sup>1</sup>	234-4662 <sup>1</sup>	234-4201 <sup>1</sup>
V6-2.8	1997-1996		234-3101 <sup>1</sup>	234-3090 <sup>1</sup>	234-4662 <sup>1</sup>	234-4201 <sup>1</sup>
V6-2.8	1995		234-3101 <sup>1</sup>	234-3090 <sup>1</sup>	-	-
V6-3.0	2015-2014	Diesel Engine	234-5036	-	-	-
V6-3.0	2015-2014	Gas Engine	234-5164 <sup>1</sup>	-	234-4120 <sup>1</sup>	-

<sup>1</sup> 2 Required / Requis 2 / Requeridos 2 <sup>4</sup> Left Side / Côté gauche / Lado izquierdo <sup>5</sup> Right Side / Côté droit / Lado derecho



ENGINE MOTEUR MOTOR	YEAR ANNEE AÑO	APPLICATION INFORMATION INFORMATION D'APPLICATION INFORMACION DE APLICACION	UPSTREAM / AVANT - C.C. / ANTES DEL C.C.		DOWNSTREAM / APRS - C.C. / DESPUES DEL C.C.	
			TYPE / TIPO O.E.	UNIVERS.	TYPE / TIPO O.E.	UNIVERS.
<b>AUDI [cont]</b>						
<b>A6 QUATTRO [cont]</b>						
V6-3.0	2013-2012		234-5164 <sup>1</sup>	-	234-4120 <sup>1</sup>	-
V6-3.0	2011-2009	CCAA Engine; Cylinder 1,2,3	234-5164	-	234-4414	-
V6-3.0	2011-2009	CCAA Engine; Cylinder 4,5,6	234-5164	-	234-4413	-
V6-3.0	2009	CAJA Engine; Cylinder 1,2,3	234-5164	-	234-4408	-
V6-3.0	2009	CAJA Engine; Cylinder 4,5,6	234-5164	-	234-4409	-
V6-3.0	2004-2002		234-5028 <sup>1</sup>	-	234-4874 <sup>1</sup>	-
V6-3.2	2008-2005	Cylinder 1,2,3	234-5120	-	234-4414	-
V6-3.2	2008-2005	Cylinder 4,5,6	234-5120	-	234-4413	-
V8-4.2	2011	Cylinder 1,2,3,4	234-5129	-	234-4485	-
V8-4.2	2011	Cylinder 5,6,7,8	234-5129	-	234-4485	-
V8-4.2	2010-2007		234-5129 <sup>4</sup>	-	234-4485 <sup>4</sup>	-
V8-4.2	2010-2007		234-5129 <sup>5</sup>	-	234-4832 <sup>5</sup>	-
V8-4.2	2006-2005		234-5129 <sup>1</sup>	-	234-4833 <sup>1</sup>	-
V8-4.2	2004-2000		234-4812 <sup>1</sup>	-	234-4812 <sup>1</sup>	-
<b>A7 QUATTRO</b>						
V6-3.0	2015-2014	Diesel Engine	234-5036	-	-	-
V6-3.0	2015-2014	Gas Engine	234-5164 <sup>1</sup>	-	234-4120 <sup>1</sup>	-
V6-3.0	2013-2012		234-5164 <sup>1</sup>	-	234-4120 <sup>1</sup>	-
<b>A8</b>						
V8-3.7	1999-1997		234-4664 <sup>1</sup>	234-4200 <sup>1</sup>	234-4662 <sup>1</sup>	234-4201 <sup>1</sup>
<b>A8 QUATTRO</b>						
V6-3.0	2015-2014	Diesel Engine	234-5036	-	-	-
V6-3.0	2015	Gas Engine; Cylinder 1,2,3	234-5183	-	234-4990	-
V6-3.0	2015	Gas Engine; Cylinder 4,5,6	234-5183	-	234-4991	-
V6-3.0	2014	Gas Engine	234-5160 <sup>1</sup>	-	234-4120 <sup>1</sup>	-
V6-3.0	2013		234-5160 <sup>1</sup>	-	234-4120 <sup>1</sup>	-
V8-4.0	2015-2013	Cylinder 1,2,3,4	234-5161	-	234-4833	-
V8-4.0	2015-2013	Cylinder 5,6,7,8	234-5162	-	234-4833	-
V8-4.2	2012-2011	Cylinder 1,2,3,4	234-5093	-	234-4485	-
V8-4.2	2012-2011	Cylinder 5,6,7,8	234-5094	-	234-4485	-
V8-4.2	2010-2007	Cylinder 1,2,3,4	234-5114	-	234-4485	-
V8-4.2	2010-2007	Cylinder 5,6,7,8	234-5114	-	234-4808	-
V8-4.2	2006-2004		234-5115 <sup>1</sup>	-	234-4874 <sup>1</sup>	-
V8-4.2	2003-2001	AUX Engine	234-4872 <sup>4</sup>	-	234-4844 <sup>4</sup>	-
V8-4.2	2003-2001	AUX Engine	234-4872 <sup>5</sup>	-	234-4812 <sup>5</sup>	-
V8-4.2	2003-2000	AKB Engine	234-4872 <sup>1</sup>	-	234-4812 <sup>1</sup>	-
V8-4.2	1999-1997		234-4664 <sup>1</sup>	234-4200 <sup>1</sup>	234-4662 <sup>1</sup>	234-4201 <sup>1</sup>
W12-6.0	2009-2008	Cylinder 1,2,3	234-5019	-	234-4809	-
W12-6.0	2009-2008	Cylinder 10,11,12	234-5008	-	234-4809	-
W12-6.0	2009-2008	Cylinder 4,5,6	234-5119	-	234-4809	-

<sup>1</sup> 2 Required / Requis 2 / Requeridos 2 <sup>4</sup> Left Side / Côté gauche / Lado izquierdo <sup>5</sup> Right Side / Côté droit / Lado derecho



ENGINE MOTEUR MOTOR	YEAR ANNEE AÑO	APPLICATION INFORMATION INFORMATION D'APPLICATION INFORMACION DE APLICACION	UPSTREAM / AVANT - C.C. / ANTES DEL C.C.		DOWNSTREAM / APRS - C.C. / DESPUES DEL C.C.	
			TYPE / TIPO O.E.	UNIVERS.	TYPE / TIPO O.E.	UNIVERS.
<b>AUDI [cont]</b>						
<b>A8 QUATTRO [cont]</b>						
W12-6.0	2009-2008	Cylinder 7,8,9	234-5103	-	234-4846	-
W12-6.0	2007	From Chassis #4E-7-017 625; Cylinder 1,2,3	234-5114	-	234-4809	-
W12-6.0	2007	From Chassis #4E-7-017 625; Cylinder 10,11,12	234-5114	-	234-4809	-
W12-6.0	2007	From Chassis #4E-7-017 625; Cylinder 4,5,6	234-5114	-	234-4809	-
W12-6.0	2007	From Chassis #4E-7-017 625; Cylinder 7,8,9	234-5103	-	234-4846	-
W12-6.0	2007	To Chassis #4E-7-017 624; Cylinder 1,2,3	234-5148	-	234-4809	-
W12-6.0	2007	To Chassis #4E-7-017 624; Cylinder 10,11,12	234-5045	-	234-4809	-
W12-6.0	2007	To Chassis #4E-7-017 624; Cylinder 4,5,6	234-5129	-	234-4809	-
W12-6.0	2007	To Chassis #4E-7-017 624; Cylinder 7,8,9	234-5045	-	234-4846	-
W12-6.0	2006-2005	Cylinder 1,2,3	234-5148	-	234-4809	-
W12-6.0	2006-2005	Cylinder 10,11,12	234-5045	-	234-4809	-
W12-6.0	2006-2005	Cylinder 4,5,6	234-5129	-	234-4809	-
W12-6.0	2006-2005	Cylinder 7,8,9	234-5045	-	234-4846	-
W12-6.3	2015	Cylinder 1,3,5	234-5102	-	234-4935	-
W12-6.3	2015	Cylinder 2,4,6	234-5009	-	234-4993	-
W12-6.3	2015	Cylinder 7,9,11	234-5019	-	234-4995	-
W12-6.3	2015	Cylinder 8,10,12	234-5102	-	234-4994	-
W12-6.3	2014-2012	Cylinder 1,3,5	234-5143	-	234-4591	-
W12-6.3	2014-2012	Cylinder 7,9,11	234-5145	-	234-4717	-
W12-6.3	2014-2012	Cylinder 8,10,12	234-5146	-	234-4737	-
W12-6.3	2014	Cylinder 2,4,6	234-5144	-	234-4591	-
W12-6.3	2013-2012	Cylinder 2,4,6	234-5144	-	234-4589	-
<b>ALLROAD</b>						
L4-2.0	2015-2013		234-5019	-	234-4754	-
<b>ALLROAD QUATTRO</b>						
V6-2.7	2005-2002		234-4859 <sup>1</sup>	-	234-4874 <sup>1</sup>	-
V6-2.7	2001		234-4812 <sup>1</sup>	-	234-4812 <sup>1</sup>	-
V8-4.2	2005-2003		234-5028 <sup>1</sup>	-	234-4874 <sup>1</sup>	-
<b>CABRIOLET</b>						
V6-2.8	1998-1994		234-3101 <sup>1</sup>	234-3090 <sup>1</sup>	234-4661 <sup>1</sup>	234-4201 <sup>1</sup>
<b>COUPE</b>						
L5-2.2	1987-1981		-	234-1000	-	-
L5-2.3	1987		234-3048	234-3000	-	-
<b>COUPE QUATTRO</b>						
L5-2.3	1991-1990		234-3048	234-3000	-	-
<b>Q3</b>						
L4-2.0	2015		234-5034	-	234-4754	-
<b>Q3 QUATTRO</b>						
L4-2.0	2015		234-5034	-	234-4754	-
<b>Q5</b>						
L4-2.0	2015-2013	Flex Fuel Engine	234-5019	-	234-4754	-

<sup>1</sup> 2 Required / Requis 2 / Requeridos 2



ENGINE MOTEUR MOTOR	YEAR ANNEE AÑO	APPLICATION INFORMATION INFORMATION D'APPLICATION INFORMACION DE APLICACION	UPSTREAM / AVANT - C.C. / ANTES DEL C.C.		DOWNSTREAM / APRS - C.C. / DESPUES DEL C.C.	
			TYPE / TIPO O.E.	UNIVERS.	TYPE / TIPO O.E.	UNIVERS.
<b>AUDI [cont]</b>						
<b>Q5 [cont]</b>						
L4-2.0	2015-2013	Hybrid Engine	234-5163	-	234-4754	-
L4-2.0	2012-2011		234-5019	-	234-4754	-
V6-3.0	2015-2014	Diesel Engine	234-5036	-	-	-
V6-3.0	2015-2014		Gas Engine	234-5164 <sup>1</sup>	-	234-4120 <sup>1</sup>
V6-3.0	2013		234-5164 <sup>1</sup>	-	234-4120 <sup>1</sup>	-
V6-3.2	2012-2010		234-5164 <sup>1</sup>	-	234-4120 <sup>1</sup>	-
V6-3.2	2009	From 02/16/2009	234-5164 <sup>1</sup>	-	234-4120 <sup>1</sup>	-
V6-3.2	2009	To 02/16/2009	234-5120 <sup>1</sup>	-	234-4120 <sup>1</sup>	-
<b>Q7</b>						
V6-3.0	2015-2011	Gas Engine	234-5092 <sup>4</sup>	-	234-4484 <sup>4</sup>	-
V6-3.0	2015-2011	Gas Engine	234-5164 <sup>5</sup>	-	234-4414 <sup>5</sup>	-
V6-3.0	2015-2009	Diesel Engine	234-5036	-	-	-
V6-3.6	2010-2007		234-5019 <sup>4</sup>	-	234-4485 <sup>4</sup>	-
V6-3.6	2010-2007		234-5125 <sup>5</sup>	-	234-4485 <sup>5</sup>	-
V8-4.2	2010-2007		234-5045 <sup>4</sup>	-	234-4843 <sup>4</sup>	-
V8-4.2	2010-2007		234-5045 <sup>5</sup>	-	234-4833 <sup>5</sup>	-
<b>QUATTRO</b>						
L5-2.2	1986-1983		234-1011	234-1000	-	-
<b>R8</b>						
V8-4.2	2015-2014	Cylinder 1,2,3,4	234-5108	-	234-4829	-
V8-4.2	2015-2014	Cylinder 5,6,7,8	234-5114	-	234-4829	-
V8-4.2	2012-2008	Cylinder 1,2,3,4	234-5108	-	234-4829	-
V8-4.2	2012-2008	Cylinder 5,6,7,8	234-5114	-	234-4829	-
V10-5.2	2015-2014	Cylinder 1,2,3,4,5	234-5019	-	234-4829	-
V10-5.2	2015-2014	Cylinder 6,7,8,9,10	234-5036	-	234-4829	-
V10-5.2	2012-2010	Cylinder 1,2,3,4,5	234-5019	-	234-4829	-
V10-5.2	2012-2010	Cylinder 6,7,8,9,10	234-5036	-	234-4829	-
<b>RS4</b>						
V8-4.2	2008-2007	Cylinder 1,2,3,4	234-5114	-	234-4849	-
V8-4.2	2008-2007	Cylinder 5,6,7,8	234-5114	-	234-4832	-
<b>RS5</b>						
V8-4.2	2015-2013		234-5093 <sup>1</sup>	-	234-4485 <sup>1</sup>	-
<b>RS6</b>						
V8-4.2	2004-2003		234-4812 <sup>1</sup>	-	234-4812 <sup>1</sup>	-
<b>RS7</b>						
V8-4.0	2015-2014	Cylinder 1,2,3,4	234-5161	-	234-4833	-
V8-4.0	2015-2014	Cylinder 5,6,7,8	234-5162	-	234-4833	-
<b>S3</b>						
L4-2.0	2015		234-5185	-	234-4992	-

<sup>1</sup> 2 Required / Requis 2 / Requeridos 2 <sup>4</sup> Left Side / Côté gauche / Lado izquierdo <sup>5</sup> Right Side / Côté droit / Lado derecho





ENGINE MOTEUR MOTOR	YEAR ANNEE AÑO	APPLICATION INFORMATION INFORMATION D'APPLICATION INFORMACION DE APLICACION	UPSTREAM / AVANT - C.C. / ANTES DEL C.C.		DOWNSTREAM / APRS - C.C. / DESPUES DEL C.C.	
			TYPE / TIPO O.E.	UNIVERS.	TYPE / TIPO O.E.	UNIVERS.
<b>AUDI [cont]</b>						
<b>S4</b>						
L5-2.2	1994-1992		234-3019	234-3090	-	-
V6-2.7	2002-2000		234-4812 <sup>1</sup>	-	234-4812 <sup>1</sup>	-
V6-3.0	2015		234-5164 <sup>1</sup>	-	-	-
V6-3.0	2014-2010		234-5164 <sup>1</sup>	-	234-4120 <sup>1</sup>	-
V8-4.2	2009-2004		234-5028 <sup>1</sup>	-	234-4874 <sup>1</sup>	-
<b>S5</b>						
V6-3.0	2015		234-5164 <sup>1</sup>	-	-	-
V6-3.0	2014-2010		234-5164 <sup>1</sup>	-	234-4120 <sup>1</sup>	-
V8-4.2	2012-2008		234-5110 <sup>1</sup>	-	234-4485 <sup>1</sup>	-
<b>S6</b>						
L5-2.2	1997-1995		234-3019	234-3090	-	-
V8-4.0	2015-2013	Cylinder 1,2,3,4	234-5161	-	234-4833	-
V8-4.0	2015-2013	Cylinder 5,6,7,8	234-5162	-	234-4833	-
V8-4.2	2003-2002		234-4812 <sup>1</sup>	-	234-4812 <sup>1</sup>	-
V10-5.2	2011-2008	Cylinder 1,2,3	234-5019	-	234-4485	-
V10-5.2	2011-2008	Cylinder 4,5	234-5009	-	234-4834	-
V10-5.2	2011-2008	Cylinder 6,7,8	234-5019	-	234-4849	-
V10-5.2	2011-2008	Cylinder 9,10	234-5036	-	234-4871	-
V10-5.2	2007	Cylinder 1,2,3	234-5110	-	234-4485	-
V10-5.2	2007	Cylinder 4,5	234-5108	-	234-4834	-
V10-5.2	2007	Cylinder 6,7,8	234-5104	-	234-4849	-
V10-5.2	2007	Cylinder 9,10	234-5118	-	234-4871	-
<b>S7</b>						
V8-4.0	2015-2013	Cylinder 1,2,3,4	234-5161	-	234-4833	-
V8-4.0	2015-2013	Cylinder 5,6,7,8	234-5162	-	234-4833	-
<b>S8</b>						
V8-4.0	2015-2013	Cylinder 1,2,3,4	234-5161	-	234-4833	-
V8-4.0	2015-2013	Cylinder 5,6,7,8	234-5162	-	234-4833	-
V8-4.2	2003-2001		234-4872 <sup>1</sup>	-	234-4812 <sup>1</sup>	-
V10-5.2	2009-2008	Cylinder 1,2,3	234-5019	-	234-4834	-
V10-5.2	2009-2008	Cylinder 4,5	234-5022	-	234-4834	-
V10-5.2	2009-2008	Cylinder 6,7,8	234-5019	-	234-4485	-
V10-5.2	2009-2008	Cylinder 9,10	234-5008	-	234-4485	-
V10-5.2	2007	Cylinder 1,2,3	234-5129	-	234-4834	-
V10-5.2	2007	Cylinder 4,5	234-5114	-	234-4834	-
V10-5.2	2007	Cylinder 6,7,8	234-5131	-	234-4485	-
V10-5.2	2007	Cylinder 9,10	234-5105	-	234-4485	-
<b>SQ5</b>						
V6-3.0	2015-2014		234-5164 <sup>1</sup>	-	234-4120 <sup>1</sup>	-

<sup>1</sup> 2 Required / Requis 2 / Requeridos 2



ENGINE MOTEUR MOTOR	YEAR ANNEE AÑO	APPLICATION INFORMATION INFORMATION D'APPLICATION INFORMACION DE APLICACION	UPSTREAM / AVANT - C.C. / ANTES DEL C.C.		DOWNSTREAM / APRS - C.C. / DESPUES DEL C.C.	
			TYPE / TIPO O.E.	UNIVERS.	TYPE / TIPO O.E.	UNIVERS.
<b>AUDI [cont]</b>						
<b>TT</b>						
L4-1.8	2006-2001	AWP Engine	234-5115	-	234-4874	-
L4-1.8	2001-2000	ATC Engine	234-4874	-	234-4859	-
L4-2.0	2009-2008		234-5107	-	234-4829	-
<b>TT QUATTRO</b>						
L4-1.8	2006-2003		234-5028	-	234-4753	-
L4-1.8	2002-2001	AWP Engine	234-5115	-	234-4753	-
L4-1.8	2002	AMU Engine	234-4753	-	234-4753	-
L4-1.8	2001	AMU Engine; From Chassis #8N-1-034-001	234-4753	-	234-4753	-
L4-1.8	2001	AMU Engine; To Chassis #8N-1-034-000	234-4753	-	234-4874	-
L4-1.8	2000	AMU Engine	234-4753	-	234-4753	-
L4-1.8	2000	ATC Engine	234-4874	-	234-4874	-
L4-2.0	2014-2009		234-5107	-	234-4829	-
L5-2.5	2013-2012		234-5009	-	234-4754	-
V6-3.2	2009-2008		234-5102 <sup>4</sup>	-	234-4836 <sup>4</sup>	-
V6-3.2	2009-2008		234-5125 <sup>5</sup>	-	234-4829 <sup>5</sup>	-
V6-3.2	2006-2004		234-5106 <sup>4</sup>	-	234-4809 <sup>4</sup>	-
V6-3.2	2006-2004		234-5045 <sup>5</sup>	-	234-4808 <sup>5</sup>	-
<b>V8 QUATTRO</b>						
V8-3.6	1991-1990	Auto Trans	234-3019	234-3090	-	-
V8-3.6	1991-1990	Manual Trans	234-3048	234-3000	-	-
V8-4.2	1994-1992		234-3048	234-3000	-	-
<b>BENTLEY</b>						
<b>CONTINENTAL</b>						
V8-4.0	2015	Cylinder 1,2,3,4	234-5162	-	234-4829	-
V8-4.0	2015	Cylinder 5,6,7,8	234-5163	-	234-4754	-
W12-6.0	2015	Cylinder 1,2,3,4,5,6	234-5102	-	234-4809	-
W12-6.0	2015	Cylinder 7,8,9,10,11,12	234-5119	-	234-4809	-
<b>MULSANNE</b>						
V8-6.8	2015		234-5143 <sup>1</sup>	-	-	-
<b>BMW</b>						
<b>1 SERIES M</b>						
L6-3.0	2011	Cylinder 1,2,3	234-5139	-	234-4876	-
L6-3.0	2011	Cylinder 4,5,6	234-5138	-	234-4892	-
<b>128I</b>						
L6-3.0	2013-2008	Cylinder 1,2,3	234-5139	-	234-4876	-
L6-3.0	2013-2008	Cylinder 4,5,6	234-5138	-	234-4892	-
<b>135I</b>						
L6-3.0	2013-2011		234-5079	-	234-4479	-

<sup>1</sup> 2 Required / Requis 2 / Requeridos 2 <sup>4</sup> Left Side / Côté gauche / Lado izquierdo <sup>5</sup> Right Side / Côté droit / Lado derecho



ENGINE MOTEUR MOTOR	YEAR ANNEE AÑO	APPLICATION INFORMATION INFORMATION D'APPLICATION INFORMACION DE APLICACION	UPSTREAM / AVANT - C.C. / ANTES DEL C.C.		DOWNSTREAM / APRS - C.C. / DESPUES DEL C.C.	
			TYPE / TIPO O.E.	UNIVERS.	TYPE / TIPO O.E.	UNIVERS.
<b>BMW [cont]</b>						
<b>135I [cont]</b>						
L6-3.0	2010-2008	Cylinder 1,2,3	234-5139	-	234-4876	-
L6-3.0	2010-2008	Cylinder 4,5,6	234-5138	-	234-4892	-
<b>135IS</b>						
L6-3.0	2013		234-5079	-	234-4479	-
<b>228I</b>						
L4-2.0	2015-2014		234-5054	-	234-4562	-
<b>228I XDRIVE</b>						
L4-2.0	2015		234-5054	-	234-4562	-
<b>318I</b>						
L4-1.8	1995-1993		234-4670	234-4200	-	-
L4-1.8	1992	Convertible	234-4674	234-4200	-	-
L4-1.8	1992	Sedan	234-4670	234-4200	-	-
L4-1.8	1991		234-4674	234-4200	-	-
L4-1.8	1985-1984	To 12/84	234-1015	234-1000	-	-
L4-1.8	1985	From 12/84	234-3060	234-3000	-	-
L4-1.9	1999-1996		234-4672	234-4201	234-4682	234-4201
<b>318IS</b>						
L4-1.8	1995-1993		234-4670	234-4200	-	-
L4-1.8	1992-1991	To 09/92	234-4674	234-4200	-	-
L4-1.8	1992	From 09/92	234-4670	234-4200	-	-
L4-1.9	1999-1996		234-4672	234-4201	234-4682	234-4201
<b>318TI</b>						
L4-1.8	1995		234-4670	234-4200	-	-
L4-1.9	1999-1996		234-4672	234-4201	234-4682	234-4201
<b>320I</b>						
L4-1.8	1983-1980		234-1015	234-1000	-	-
L4-2.0	2015-2012		234-5054	-	234-4562	-
L4-2.0	1979		234-1015	234-1000	-	-
L6-2.0	1995-1992	Auto Trans	234-4481	-	-	-
L6-2.0	1995-1992	Manual Trans	234-4482	-	-	-
L6-2.2	2005-2001		234-4672 <sup>1</sup>	234-4201 <sup>1</sup>	234-4683 <sup>1</sup>	234-4201 <sup>1</sup>
<b>320I XDRIVE</b>						
L4-2.0	2015-2013		234-5054	-	234-4562	-
<b>323CI</b>						
L6-2.5	2000		234-4672 <sup>1</sup>	234-4201 <sup>1</sup>	234-4683 <sup>1</sup>	234-4201 <sup>1</sup>
<b>323I</b>						
L6-2.5	2011-2010	Cylinder 1,2,3	234-5139	-	234-4876	-
L6-2.5	2011-2010	Cylinder 4,5,6.	234-5138	-	234-4892	-
L6-2.5	2009-2007	Cylinder 1,2,3	234-5139	-	234-4877	-
L6-2.5	2009-2007	Cylinder 4,5,6	234-5138	-	234-4892	-
L6-2.5	2006	From 11/2005; Cylinder 1,2,3	234-5139	-	234-4877	-

<sup>1</sup> 2 Required / Requis 2 / Requeridos 2



ENGINE MOTEUR MOTOR	YEAR ANNEE AÑO	APPLICATION INFORMATION INFORMATION D'APPLICATION INFORMACION DE APLICACION	UPSTREAM / AVANT - C.C. / ANTES DEL C.C.		DOWNSTREAM / APRES - C.C. / DESPUES DEL C.C.	
			TYPE / TIPO O.E.	UNIVERS.	TYPE / TIPO O.E.	UNIVERS.
<b>BMW [cont]</b>						
<b>323i [cont]</b>						
L6-2.5	2006	From 11/2005; Cylinder 4,5,6	234-5138	-	234-4892	-
L6-2.5	2006	To 11/2005; Cylinder 1,2,3	234-5135	-	234-4877	-
L6-2.5	2006	To 11/2005; Cylinder 4,5,6	234-5135	-	234-4892	-
L6-2.5	2000		234-4672 <sup>1</sup>	234-4201 <sup>1</sup>	234-4683 <sup>1</sup>	234-4201 <sup>1</sup>
L6-2.5	1999	Convertible	234-4672 <sup>1</sup>	234-4201 <sup>1</sup>	234-4683 <sup>1</sup>	234-4201 <sup>1</sup>
L6-2.5	1999	Sedan; w/ 16" Downstream Sensor	234-4789 <sup>1</sup>	-	234-4785 <sup>1</sup>	-
L6-2.5	1999	Sedan; w/ 39" Downstream Sensor	234-4789 <sup>1</sup>	-	234-4789 <sup>1</sup>	-
L6-2.5	1998	w/ 16" Downstream Sensor	234-4789 <sup>1</sup>	-	234-4785 <sup>1</sup>	-
L6-2.5	1998	w/ 39" Downstream Sensor	234-4789 <sup>1</sup>	-	234-4789 <sup>1</sup>	-
<b>323IS</b>						
L6-2.5	1999-1998	w/ 16" Downstream Sensor	234-4789 <sup>1</sup>	-	234-4785 <sup>1</sup>	-
L6-2.5	1999-1998	w/ 39" Downstream Sensor	234-4789 <sup>1</sup>	-	234-4789 <sup>1</sup>	-
<b>325</b>						
L6-2.7	1988-1986		234-3016	234-3000	-	-
<b>325CI</b>						
L6-2.5	2006-2004	M54 Engine	234-5137 <sup>1</sup>	-	234-4473 <sup>1</sup>	234-4201 <sup>1</sup>
L6-2.5	2006-2003	M56 Engine	234-5134 <sup>1</sup>	-	234-4473 <sup>1</sup>	234-4201 <sup>1</sup>
L6-2.5	2003	M54 Engine; From 3/03	234-5137 <sup>1</sup>	-	234-4473 <sup>1</sup>	234-4201 <sup>1</sup>
L6-2.5	2003	M54 Engine; To 3/03	234-4672 <sup>1</sup>	234-4201 <sup>1</sup>	234-4683 <sup>1</sup>	234-4201 <sup>1</sup>
L6-2.5	2002-2001		234-4672 <sup>1</sup>	234-4201 <sup>1</sup>	234-4683 <sup>1</sup>	234-4201 <sup>1</sup>
<b>325E</b>						
L6-2.7	1987-1984		234-3016	234-3000	-	-
<b>325ES</b>						
L6-2.7	1987-1986		234-3016	234-3000	-	-
<b>325I</b>						
L6-2.5	2005-2004	M54 Engine	234-5137 <sup>1</sup>	-	234-4473 <sup>1</sup>	234-4201 <sup>1</sup>
L6-2.5	2005-2003	M56 Engine	234-5134 <sup>1</sup>	-	234-4473 <sup>1</sup>	234-4201 <sup>1</sup>
L6-2.5	2003	M54 Engine; From 3/03	234-5137 <sup>1</sup>	-	234-4473 <sup>1</sup>	234-4201 <sup>1</sup>
L6-2.5	2003	M54 Engine; To 3/03	234-4672 <sup>1</sup>	234-4201 <sup>1</sup>	234-4683 <sup>1</sup>	234-4201 <sup>1</sup>
L6-2.5	2002-2001		234-4672 <sup>1</sup>	234-4201 <sup>1</sup>	234-4683 <sup>1</sup>	234-4201 <sup>1</sup>
L6-2.5	1995-1993	M50TU Engine; Auto Trans	234-4675	234-4200	-	-
L6-2.5	1995-1993	M50TU Engine; Manual Trans	234-4670	234-4200	-	-
L6-2.5	1993-1992	M20 Engine	234-4674	234-4200	-	-
L6-2.5	1992	M50 Engine; Auto Trans	234-4675	234-4200	-	-
L6-2.5	1992	M50 Engine; Manual Trans	234-4670	234-4200	-	-
L6-2.5	1991-1989		234-4674	234-4200	-	-
L6-2.5	1988-1987	To 09/87	234-4088	234-4000	-	-
L6-2.5	1988	From 09/87	234-4674	234-4200	-	-
L6-3.0	2006	From 11/2005; Cylinder 1,2,3	234-5139	-	234-4876	-
L6-3.0	2006	From 11/2005; Cylinder 4,5,6	234-5138	-	234-4892	-

<sup>1</sup> 2 Required / Requis 2 / Requeridos 2



ENGINE MOTEUR MOTOR	YEAR ANNEE AÑO	APPLICATION INFORMATION INFORMATION D'APPLICATION INFORMACION DE APLICACION	UPSTREAM / AVANT - C.C. / ANTES DEL C.C.		DOWNSTREAM / APRS - C.C. / DESPUES DEL C.C.	
			TYPE / TIPO O.E.	UNIVERS.	TYPE / TIPO O.E.	UNIVERS.
<b>BMW [cont]</b>						
<b>325I [cont]</b>						
L6-3.0	2006	To 11/2005; Cylinder 1,2,3	234-5135	-	234-4876	-
L6-3.0	2006	To 11/2005; Cylinder 4,5,6	234-5135	-	234-4892	-
<b>325IS</b>						
L6-2.5	1995-1993	M50TU Engine; Auto Trans	234-4675	234-4200	-	-
L6-2.5	1995-1993	M50TU Engine; Manual Trans	234-4670	234-4200	-	-
L6-2.5	1992	M50 Engine; Auto Trans	234-4675	234-4200	-	-
L6-2.5	1992	M50 Engine; Manual Trans	234-4670	234-4200	-	-
L6-2.5	1991-1989		234-4674	234-4200	-	-
L6-2.5	1988-1987	To 09/87	234-4088	234-4000	-	-
L6-2.5	1988	From 09/87	234-4674	234-4200	-	-
<b>325IX</b>						
L6-2.5	1991-1989		234-4674	234-4200	-	-
L6-2.5	1988	From 09/87	234-4674	234-4200	-	-
L6-2.5	1988	To 09/87	234-4088	234-4000	-	-
<b>325XI</b>						
L6-2.5	2005-2001		234-4672 <sup>1</sup>	234-4201 <sup>1</sup>	234-4683 <sup>1</sup>	234-4201 <sup>1</sup>
L6-3.0	2006	From 11/2005; Cylinder 1,2,3	234-5139	-	234-4876	-
L6-3.0	2006	From 11/2005; Cylinder 4,5,6	234-5138	-	234-4892	-
L6-3.0	2006	To 11/2005; Cylinder 1,2,3	234-5135	-	234-4876	-
L6-3.0	2006	To 11/2005; Cylinder 4,5,6	234-5135	-	234-4892	-
<b>328CI</b>						
L6-2.8	2000		234-4672 <sup>1</sup>	234-4201 <sup>1</sup>	234-4683 <sup>1</sup>	234-4201 <sup>1</sup>
<b>328I</b>						
L4-2.0	2015-2012		234-5054	-	234-4562	-
L6-2.8	2000-1999	Sedan	234-4672 <sup>1</sup>	234-4201 <sup>1</sup>	234-4683 <sup>1</sup>	234-4201 <sup>1</sup>
L6-2.8	1999	Convertible	234-4789 <sup>1</sup>	-	234-4789 <sup>1</sup>	-
L6-2.8	1998-1996		234-4789 <sup>1</sup>	-	234-4789 <sup>1</sup>	-
L6-3.0	2013-2007	Cylinder 1,2,3	234-5139	-	234-4876	-
L6-3.0	2013-2007	Cylinder 4,5,6	234-5138	-	234-4892	-
<b>328I GT XDRIVE</b>						
L4-2.0	2015-2014		234-5054	-	234-4562	-
<b>328IS</b>						
L6-2.8	1999-1996		234-4789 <sup>1</sup>	-	234-4789 <sup>1</sup>	-
<b>328I XDRIVE</b>						
L4-2.0	2015-2013		234-5054	-	234-4562	-
L6-3.0	2013-2009	Cylinder 1,2,3	234-5139	-	234-4876	-
L6-3.0	2013-2009	Cylinder 4,5,6	234-5138	-	234-4892	-
<b>328XI</b>						
L6-3.0	2008-2007	Cylinder 1,2,3	234-5139	-	234-4876	-
L6-3.0	2008-2007	Cylinder 4,5,6	234-5138	-	234-4892	-

<sup>1</sup> 2 Required / Requis 2 / Requeridos 2



ENGINE MOTEUR MOTOR	YEAR ANNEE AÑO	APPLICATION INFORMATION INFORMATION D'APPLICATION INFORMACION DE APLICACION	UPSTREAM / AVANT - C.C. / ANTES DEL C.C.		DOWNSTREAM / APRES - C.C. / DESPUES DEL C.C.	
			TYPE / TIPO O.E.	UNIVERS.	TYPE / TIPO O.E.	UNIVERS.
<b>BMW [cont]</b>						
<b>330CI</b>						
L6-3.0	2006-2004		234-5137 <sup>1</sup>	-	234-4473 <sup>1</sup>	234-4201 <sup>1</sup>
L6-3.0	2003	From 03/03	234-5137 <sup>1</sup>	-	234-4473 <sup>1</sup>	234-4201 <sup>1</sup>
L6-3.0	2003	To 03/03	234-4672 <sup>1</sup>	234-4201 <sup>1</sup>	234-4683 <sup>1</sup>	234-4201 <sup>1</sup>
L6-3.0	2002-2001		234-4672 <sup>1</sup>	234-4201 <sup>1</sup>	234-4683 <sup>1</sup>	234-4201 <sup>1</sup>
<b>330I</b>						
L6-3.0	2006	From 11/2005; Cylinder 1,2,3	234-5139	-	234-4876	-
L6-3.0	2006	From 11/2005; Cylinder 4,5,6	234-5138	-	234-4892	-
L6-3.0	2006	To 11/2005; Cylinder 1,2,3	234-5135	-	234-4876	-
L6-3.0	2006	To 11/2005; Cylinder 4,5,6	234-5135	-	234-4892	-
L6-3.0	2005-2004		234-5137 <sup>1</sup>	-	234-4473 <sup>1</sup>	234-4201 <sup>1</sup>
L6-3.0	2003	From 03/03	234-5137 <sup>1</sup>	-	234-4473 <sup>1</sup>	234-4201 <sup>1</sup>
L6-3.0	2003	To 03/03	234-4672 <sup>1</sup>	234-4201 <sup>1</sup>	234-4683 <sup>1</sup>	234-4201 <sup>1</sup>
L6-3.0	2002-2001		234-4672 <sup>1</sup>	234-4201 <sup>1</sup>	234-4683 <sup>1</sup>	234-4201 <sup>1</sup>
<b>330XI</b>						
L6-3.0	2006	From 11/2005; Cylinder 1,2,3	234-5139	-	234-4876	-
L6-3.0	2006	From 11/2005; Cylinder 4,5,6	234-5138	-	234-4892	-
L6-3.0	2006	To 11/2005; Cylinder 1,2,3	234-5135	-	234-4876	-
L6-3.0	2006	To 11/2005; Cylinder 4,5,6	234-5135	-	234-4892	-
L6-3.0	2005-2001		234-4672 <sup>1</sup>	234-4201 <sup>1</sup>	234-4683 <sup>1</sup>	234-4201 <sup>1</sup>
<b>335D</b>						
L6-3.0	2011-2009		234-5140	-	-	-
<b>335I</b>						
L6-3.0	2015		234-5079	-	234-4971	-
L6-3.0	2014		234-5048	-	234-4971	-
L6-3.0	2013-2011		234-5079	-	234-4479	-
L6-3.0	2010-2007	Cylinder 1,2,3	234-5139	-	234-4876	-
L6-3.0	2010-2007	Cylinder 4,5,6	234-5138	-	234-4892	-
<b>335I GT XDRIVE</b>						
L6-3.0	2015		234-5079	-	234-4971	-
L6-3.0	2014		234-5079	-	234-4479	-
<b>335IS</b>						
L6-3.0	2013-2011	Cylinder 1,2,3	234-5139	-	234-4876	-
L6-3.0	2013-2011	Cylinder 4,5,6	234-5138	-	234-4892	-
<b>335I XDRIVE</b>						
L6-3.0	2015		234-5079	-	234-4971	-
L6-3.0	2014		234-5048	-	234-4971	-
L6-3.0	2013-2011		234-5079	-	234-4480	-
L6-3.0	2010-2009	Cylinder 1,2,3	234-5139	-	234-4876	-
L6-3.0	2010-2009	Cylinder 4,5,6	234-5138	-	234-4892	-

<sup>1</sup> 2 Required / Requis 2 / Requeridos 2



ENGINE MOTEUR MOTOR	YEAR ANNEE AÑO	APPLICATION INFORMATION INFORMATION D'APPLICATION INFORMACION DE APLICACION	UPSTREAM / AVANT - C.C. / ANTES DEL C.C.		DOWNSTREAM / APRS - C.C. / DESPUES DEL C.C.	
			TYPE / TIPO O.E.	UNIVERS.	TYPE / TIPO O.E.	UNIVERS.
<b>BMW [cont]</b>						
<b>335XI</b>						
L6-3.0	2008-2007	Cylinder 1,2,3	234-5139	-	234-4876	-
L6-3.0	2008-2007	Cylinder 4,5,6	234-5138	-	234-4892	-
<b>428I</b>						
L4-2.0	2015-2014		234-5054	-	234-4562	-
<b>428I GRAN COUPE</b>						
L4-2.0	2015		234-5054	-	234-4562	-
<b>428I XDRIVE</b>						
L4-2.0	2015-2014		234-5054	-	234-4562	-
<b>428I XDRIVE GRAN COUPE</b>						
L4-2.0	2015		234-5054	-	234-4562	-
<b>435I</b>						
L6-3.0	2015-2014		234-5048	-	234-4971	-
<b>435I GRAN COUPE</b>						
L6-3.0	2015		234-5048	-	234-4971	-
<b>435I XDRIVE</b>						
L6-3.0	2015-2014		234-5048	-	234-4971	-
<b>435I XDRIVE GRAN COUPE</b>						
L6-3.0	2015		234-5048	-	234-4971	-
<b>525I</b>						
L6-2.5	2005-2004		234-5137 <sup>1</sup>	-	234-4473 <sup>1</sup>	234-4201 <sup>1</sup>
L6-2.5	2003-2001		234-4672 <sup>1</sup>	234-4201 <sup>1</sup>	234-4683 <sup>1</sup>	234-4201 <sup>1</sup>
L6-2.5	1995-1991		234-4685	234-4200	-	-
L6-2.5	1990-1989		234-4674	234-4200	-	-
L6-3.0	2007	Cylinder 1,2,3	234-5139	-	234-4877	-
L6-3.0	2007	Cylinder 4,5,6	234-5138	-	234-4892	-
L6-3.0	2006	From 11/2005; Cylinder 1,2,3	234-5139	-	234-4877	-
L6-3.0	2006	From 11/2005; Cylinder 4,5,6	234-5138	-	234-4892	-
L6-3.0	2006	To 11/2005; Cylinder 1,2,3	234-5135	-	234-4877	-
L6-3.0	2006	To 11/2005; Cylinder 4,5,6	234-5135	-	234-4892	-
<b>525IT</b>						
L6-2.5	1993		234-4685	234-4200	-	-
<b>525XI</b>						
L6-3.0	2007	Cylinder 1,2,3	234-5139	-	234-4877	-
L6-3.0	2007	Cylinder 4,5,6	234-5138	-	234-4892	-
L6-3.0	2006	From 11/2005; Cylinder 1,2,3	234-5139	-	234-4877	-
L6-3.0	2006	From 11/2005; Cylinder 4,5,6	234-5138	-	234-4892	-
L6-3.0	2006	To 11/2005; Cylinder 1,2,3	234-5135	-	234-4877	-
L6-3.0	2006	To 11/2005; Cylinder 4,5,6	234-5135	-	234-4892	-

<sup>1</sup> 2 Required / Requis 2 / Requeridos 2



ENGINE MOTEUR MOTOR	YEAR ANNEE AÑO	APPLICATION INFORMATION INFORMATION D'APPLICATION INFORMACION DE APLICACION	UPSTREAM / AVANT - C.C. / ANTES DEL C.C.		DOWNSTREAM / APRS - C.C. / DESPUES DEL C.C.	
			TYPE / TIPO O.E.	UNIVERS.	TYPE / TIPO O.E.	UNIVERS.
<b>BMW [cont]</b>						
<b>528E</b>						
L6-2.7	1988		234-4088	234-4000	-	-
L6-2.7	1987-1982		234-1015	234-1000	-	-
<b>528I</b>						
L4-2.0	2015-2012		234-5054	-	234-4562	-
L6-2.8	2000-1999		234-4672 <sup>1</sup>	234-4201 <sup>1</sup>	234-4683 <sup>1</sup>	234-4201 <sup>1</sup>
L6-2.8	1998-1997		234-4789 <sup>1</sup>	-	234-4789 <sup>1</sup>	-
L6-2.8	1981-1979		234-1015	234-1000	-	-
L6-3.0	2011	Cylinder 1,2,3	234-5138	-	234-4478	-
L6-3.0	2011	Cylinder 4,5,6	234-5027	-	234-4479	-
L6-3.0	2010-2008	Cylinder 1,2,3	234-5139	-	234-4876	-
L6-3.0	2010-2008	Cylinder 4,5,6	234-5138	-	234-4892	-
<b>528I XDRIVE</b>						
L4-2.0	2015-2012		234-5054	-	234-4562	-
L6-3.0	2010-2009	Cylinder 1,2,3	234-5139	-	234-4876	-
L6-3.0	2010-2009	Cylinder 4,5,6	234-5138	-	234-4892	-
<b>528XI</b>						
L6-3.0	2008	Cylinder 1,2,3	234-5139	-	234-4876	-
L6-3.0	2008	Cylinder 4,5,6	234-5138	-	234-4892	-
<b>530I</b>						
L6-3.0	2007	Cylinder 1,2,3	234-5139	-	234-4877	-
L6-3.0	2007	Cylinder 4,5,6	234-5138	-	234-4892	-
L6-3.0	2006	From 11/2005; Cylinder 1,2,3	234-5139	-	234-4877	-
L6-3.0	2006	From 11/2005; Cylinder 4,5,6	234-5138	-	234-4892	-
L6-3.0	2006	To 11/2005; Cylinder 1,2,3	234-5135	-	234-4877	-
L6-3.0	2006	To 11/2005; Cylinder 4,5,6	234-5135	-	234-4892	-
L6-3.0	2005-2004		234-5137 <sup>1</sup>	-	234-4473 <sup>1</sup>	234-4201 <sup>1</sup>
L6-3.0	2003-2001		234-4672 <sup>1</sup>	234-4201 <sup>1</sup>	234-4683 <sup>1</sup>	234-4201 <sup>1</sup>
V8-3.0	1995		234-4671 <sup>1</sup>	234-4200 <sup>1</sup>	-	-
V8-3.0	1994	From 06/94	234-4671 <sup>1</sup>	234-4200 <sup>1</sup>	-	-
V8-3.0	1994	To 06/94; Sedan; Auto Trans	234-4670 <sup>1</sup>	234-4200 <sup>1</sup>	-	-
V8-3.0	1994	To 06/94; Sedan; Manual Trans	234-4676 <sup>1</sup>	234-4200 <sup>1</sup>	-	-
V8-3.0	1994	To 06/94; Wagon	234-4670 <sup>1</sup>	234-4200 <sup>1</sup>	-	-
<b>530XI</b>						
L6-3.0	2007	Cylinder 1,2,3	234-5139	-	234-4877	-
L6-3.0	2007	Cylinder 4,5,6	234-5138	-	234-4892	-
L6-3.0	2006	From 11/2005; Cylinder 1,2,3	234-5139	-	234-4877	-
L6-3.0	2006	From 11/2005; Cylinder 4,5,6	234-5138	-	234-4892	-
L6-3.0	2006	To 11/2005; Cylinder 1,2,3	234-5135	-	234-4877	-
L6-3.0	2006	To 11/2005; Cylinder 4,5,6	234-5135	-	234-4892	-

<sup>1</sup> 2 Required / Requis 2 / Requeridos 2





ENGINE MOTEUR MOTOR	YEAR ANNEE AÑO	APPLICATION INFORMATION INFORMATION D'APPLICATION INFORMACION DE APLICACION	UPSTREAM / AVANT - C.C. / ANTES DEL C.C.		DOWNSTREAM / APRS - C.C. / DESPUES DEL C.C.	
			TYPE / TIPO O.E.	UNIVERS.	TYPE / TIPO O.E.	UNIVERS.
<b>BMW [cont]</b>						
<b>533I</b>						
L6-3.2	1984-1983		234-1015	234-1000	-	-
<b>535I</b>						
L6-3.0	2015-2011		234-5048	-	234-4479	-
L6-3.0	2010-2008	Cylinder 1,2,3	234-5025	-	234-4892	-
L6-3.0	2010-2008	Cylinder 4,5,6	234-5027	-	234-4876	-
L6-3.5	1993-1988		234-4707	234-4700	-	-
L6-3.5	1987		234-3034	234-3000	-	-
L6-3.5	1986-1985		234-3016	234-3000	-	-
<b>535I GT</b>						
L6-3.0	2015-2010		234-5048	-	234-4479	-
<b>535I GT XDRIVE</b>						
L6-3.0	2015-2011		234-5048	-	234-4479	-
<b>535IS</b>						
L6-3.5	1988		234-4707	234-4700	-	-
<b>535I XDRIVE</b>						
L6-3.0	2015-2014		234-5048	-	234-4479	-
L6-3.0	2013-2011		234-5080	-	234-4479	-
L6-3.0	2010-2009	Cylinder 1,2,3	234-5025	-	234-4892	-
L6-3.0	2010-2009	Cylinder 4,5,6	234-5027	-	234-4876	-
<b>535XI</b>						
L6-3.0	2008	Cylinder 1,2,3	234-5025	-	234-4892	-
L6-3.0	2008	Cylinder 4,5,6	234-5027	-	234-4876	-
<b>540I</b>						
V8-4.0	1995-1994		234-4671 <sup>1</sup>	234-4200 <sup>1</sup>	-	-
V8-4.4	2003-1997		234-4672 <sup>1</sup>	234-4201 <sup>1</sup>	234-4681 <sup>1</sup>	234-4201 <sup>1</sup>
<b>545I</b>						
V8-4.4	2005-2004		234-5133 <sup>4</sup>	-	234-4470 <sup>4</sup>	234-4201 <sup>4</sup>
V8-4.4	2005-2004	Auto Trans	234-5133 <sup>5</sup>	-	234-4470 <sup>5</sup>	234-4201 <sup>5</sup>
V8-4.4	2005-2004	Manual Trans	234-5134 <sup>5</sup>	-	234-4470 <sup>5</sup>	234-4201 <sup>5</sup>
<b>550I</b>						
V8-4.4	2015-2011		234-5026 <sup>1</sup>	-	234-4876 <sup>1</sup>	-
V8-4.8	2010-2006		234-5136 <sup>5</sup>	-	234-4877 <sup>5</sup>	-
V8-4.8	2010-2006	Auto Trans	234-5136 <sup>4</sup>	-	234-4875 <sup>4</sup>	-
V8-4.8	2010-2006	Manual Trans	234-5138 <sup>4</sup>	-	234-4875 <sup>4</sup>	-
<b>550I GT</b>						
V8-4.4	2015-2010		234-5026 <sup>1</sup>	-	234-4876 <sup>1</sup>	-
<b>550I GT XDRIVE</b>						
V8-4.4	2015-2010		234-5026 <sup>1</sup>	-	234-4876 <sup>1</sup>	-

<sup>1</sup> 2 Required / Requis 2 / Requeridos 2 <sup>4</sup> Left Side / Côté gauche / Lado izquierdo <sup>5</sup> Right Side / Côté droit / Lado derecho



ENGINE MOTEUR MOTOR	YEAR ANNEE AÑO	APPLICATION INFORMATION INFORMATION D'APPLICATION INFORMACION DE APLICACION	UPSTREAM / AVANT - C.C. / ANTES DEL C.C.		DOWNSTREAM / APRES - C.C. / DESPUES DEL C.C.	
			TYPE / TIPO O.E.	UNIVERS.	TYPE / TIPO O.E.	UNIVERS.
<b>BMW [cont]</b>						
<b>550I XDRIVE</b>						
V8-4.4	2015-2011		234-5026 <sup>1</sup>	-	234-4876 <sup>1</sup>	-
<b>633CSI</b>						
L6-3.2	1984-1980		234-1015	234-1000	-	-
<b>635CSI</b>						
L6-3.5	1989-1988		234-4707	234-4700	-	-
L6-3.5	1987		234-3034	234-3000	-	-
L6-3.5	1986-1985		234-3016	234-3000	-	-
<b>640I</b>						
L6-3.0	2015		234-5048	-	234-4971	-
L6-3.0	2014		234-5048	-	234-4479	-
L6-3.0	2013-2012		234-5080	-	234-4479	-
<b>640I GRAN COUPE</b>						
L6-3.0	2015		234-5048	-	234-4971	-
L6-3.0	2014-2013		234-5080	-	234-4479	-
<b>640I XDRIVE</b>						
L6-3.0	2015		234-5048	-	234-4971	-
L6-3.0	2014		234-5048	-	234-4479	-
<b>640I XDRIVE GRAN COUPE</b>						
L6-3.0	2015		234-5048	-	234-4971	-
L6-3.0	2014		234-5048	-	234-4479	-
<b>645CI</b>						
V8-4.4	2005-2004		234-5133 <sup>4</sup>	-	234-4470 <sup>4</sup>	234-4201 <sup>4</sup>
V8-4.4	2005-2004	Auto Trans	234-5133 <sup>5</sup>	-	234-4470 <sup>5</sup>	234-4201 <sup>5</sup>
V8-4.4	2005-2004	Manual Trans	234-5134 <sup>5</sup>	-	234-4470 <sup>5</sup>	234-4201 <sup>5</sup>
<b>650I</b>						
V8-4.4	2015-2012		234-5026 <sup>1</sup>	-	234-4876 <sup>1</sup>	-
V8-4.8	2010-2006		234-5136 <sup>5</sup>	-	234-4877 <sup>5</sup>	-
V8-4.8	2010-2006	Auto Trans	234-5136 <sup>4</sup>	-	234-4875 <sup>4</sup>	-
V8-4.8	2010-2006	Manual Trans	234-5138 <sup>4</sup>	-	234-4875 <sup>4</sup>	-
<b>650I GRAN COUPE</b>						
V8-4.4	2015-2013		234-5026 <sup>1</sup>	-	234-4876 <sup>1</sup>	-
<b>650I XDRIVE</b>						
V8-4.4	2015-2012		234-5026 <sup>1</sup>	-	234-4876 <sup>1</sup>	-
<b>650I XDRIVE GRAN COUPE</b>						
V8-4.4	2015-2013		234-5026 <sup>1</sup>	-	234-4876 <sup>1</sup>	-
<b>733I</b>						
L6-3.2	1984-1979		234-1015	234-1000	-	-
<b>735I</b>						
L6-3.5	1992-1988		234-4707	234-4700	-	-

<sup>1</sup> 2 Required / Requis 2 / Requeridos 2 <sup>4</sup> Left Side / Côté gauche / Lado izquierdo <sup>5</sup> Right Side / Côté droit / Lado derecho



ENGINE MOTEUR MOTOR	YEAR ANNEE AÑO	APPLICATION INFORMATION INFORMATION D'APPLICATION INFORMACION DE APLICACION	UPSTREAM / AVANT - C.C. / ANTES DEL C.C.		DOWNSTREAM / APRS - C.C. / DESPUES DEL C.C.	
			TYPE / TIPO O.E.	UNIVERS.	TYPE / TIPO O.E.	UNIVERS.
<b>BMW [cont]</b>						
<b>735I [cont]</b>						
L6-3.5	1987-1986		234-4023	234-4000	-	-
L6-3.5	1985		234-3016	234-3000	-	-
<b>735IL</b>						
L6-3.5	1992-1988		234-4707	234-4700	-	-
<b>740I</b>						
L6-3.0	2015-2013		234-5080	-	234-4479	-
L6-3.0	2012-2011	Cylinder 1,2,3	234-5025	-	234-4900	-
L6-3.0	2012-2011	Cylinder 4,5,6	234-5027	-	234-4891	-
V8-4.0	1995		234-4680 <sup>1</sup>	234-4200 <sup>1</sup>	-	-
V8-4.0	1994-1993		234-4671 <sup>1</sup>	234-4200 <sup>1</sup>	-	-
V8-4.4	2001-1997		234-4672 <sup>1</sup>	234-4201 <sup>1</sup>	234-4681 <sup>1</sup>	234-4201 <sup>1</sup>
<b>740IL</b>						
V8-4.0	1995		234-4680 <sup>1</sup>	234-4200 <sup>1</sup>	-	-
V8-4.0	1994-1993		234-4671 <sup>1</sup>	234-4200 <sup>1</sup>	-	-
V8-4.4	2001-1996		234-4672 <sup>1</sup>	234-4201 <sup>1</sup>	234-4681 <sup>1</sup>	234-4201 <sup>1</sup>
<b>740LI</b>						
L6-3.0	2015-2013		234-5080	-	234-4479	-
L6-3.0	2012-2011	Cylinder 1,2,3	234-5025	-	234-4900	-
L6-3.0	2012-2011	Cylinder 4,5,6	234-5027	-	234-4891	-
<b>740LI XDRIVE</b>						
L6-3.0	2015-2013		234-5080	-	234-4479	-
<b>745I</b>						
V8-4.4	2005-2004		234-5133 <sup>4</sup>	-	234-4470 <sup>4</sup>	234-4201 <sup>4</sup>
V8-4.4	2005-2003		234-5133 <sup>5</sup>	-	234-4470 <sup>5</sup>	234-4201 <sup>5</sup>
V8-4.4	2003	From 10/03	234-5133 <sup>4</sup>	-	234-4470 <sup>4</sup>	234-4201 <sup>4</sup>
V8-4.4	2003	To 10/03	234-5133 <sup>4</sup>	-	234-4470 <sup>4</sup>	234-4201 <sup>4</sup>
V8-4.4	2002		234-5133 <sup>1</sup>	-	234-4470 <sup>1</sup>	234-4201 <sup>1</sup>
<b>745LI</b>						
V8-4.4	2005-2004		234-5133 <sup>4</sup>	-	234-4470 <sup>4</sup>	234-4201 <sup>4</sup>
V8-4.4	2005-2004		234-5133 <sup>5</sup>	-	234-4470 <sup>5</sup>	234-4201 <sup>5</sup>
V8-4.4	2003-2002	To 10/03	234-5133 <sup>1</sup>	-	234-4470 <sup>1</sup>	234-4201 <sup>1</sup>
V8-4.4	2003	From 10/03	234-5133 <sup>4</sup>	-	234-4470 <sup>4</sup>	234-4201 <sup>4</sup>
V8-4.4	2003	From 10/03	234-5133 <sup>5</sup>	-	234-4470 <sup>5</sup>	234-4201 <sup>5</sup>
<b>750I</b>						
V8-4.4	2015-2009		234-5026 <sup>1</sup>	-	234-4876 <sup>1</sup>	-
V8-4.8	2008-2006		234-5136 <sup>4</sup>	-	234-4875 <sup>4</sup>	-
V8-4.8	2008-2006		234-5136 <sup>5</sup>	-	234-4877 <sup>5</sup>	-
<b>750IL</b>						
V12-5.0	1994-1988		234-4676 <sup>1</sup>	234-4200 <sup>1</sup>	-	-

<sup>1</sup> 2 Required / Requis 2 / Requeridos 2 <sup>4</sup> Left Side / Côté gauche / Lado izquierdo <sup>5</sup> Right Side / Côté droit / Lado derecho



ENGINE MOTEUR MOTOR	YEAR ANNEE AÑO	APPLICATION INFORMATION INFORMATION D'APPLICATION INFORMACION DE APLICACION	UPSTREAM / AVANT - C.C. / ANTES DEL C.C.		DOWNSTREAM / APRS - C.C. / DESPUES DEL C.C.	
			TYPE / TIPO O.E.	UNIVERS.	TYPE / TIPO O.E.	UNIVERS.
<b>BMW [cont]</b>						
<b>750IL [cont]</b>						
V12-5.4	2001-1999		234-4672 <sup>1</sup>	234-4201 <sup>1</sup>	234-4682 <sup>1</sup>	234-4201 <sup>1</sup>
V12-5.4	1998	M73 Engine	234-4672 <sup>1</sup>	234-4201 <sup>1</sup>	234-4681 <sup>1</sup>	234-4201 <sup>1</sup>
V12-5.4	1998	M73N Engine	234-4672 <sup>1</sup>	234-4201 <sup>1</sup>	234-4682 <sup>1</sup>	234-4201 <sup>1</sup>
V12-5.4	1997-1995		234-4672 <sup>1</sup>	234-4201 <sup>1</sup>	234-4681 <sup>1</sup>	234-4201 <sup>1</sup>
<b>750I XDRIVE</b>						
V8-4.4	2015-2010		234-5026 <sup>1</sup>	-	234-4876 <sup>1</sup>	-
<b>750LI</b>						
V8-4.4	2015-2009		234-5026 <sup>1</sup>	-	234-4876 <sup>1</sup>	-
V8-4.8	2008-2006		234-5136 <sup>4</sup>	-	234-4875 <sup>4</sup>	-
V8-4.8	2008-2006		234-5136 <sup>5</sup>	-	234-4877 <sup>5</sup>	-
<b>750LI XDRIVE</b>						
V8-4.4	2015-2010		234-5026 <sup>1</sup>	-	234-4876 <sup>1</sup>	-
<b>760I</b>						
V12-6.0	2006-2004		234-5133 <sup>1</sup>	-	234-4470 <sup>1</sup>	234-4201 <sup>1</sup>
<b>760LI</b>						
V12-6.0	2015-2010		234-5037 <sup>1</sup>	-	234-4900 <sup>1</sup>	-
V12-6.0	2008-2007		234-5136 <sup>1</sup>	-	234-4875 <sup>1</sup>	-
V12-6.0	2006-2003		234-5133 <sup>1</sup>	-	234-4470 <sup>1</sup>	234-4201 <sup>1</sup>
<b>840CI</b>						
V8-4.0	1995-1994	From 05/94	234-4671 <sup>1</sup>	234-4200 <sup>1</sup>	-	-
V8-4.0	1994	To 05/94	234-4676 <sup>1</sup>	234-4200 <sup>1</sup>	-	-
V8-4.4	1997-1996		234-4672 <sup>1</sup>	234-4201 <sup>1</sup>	234-4684 <sup>1</sup>	234-4201 <sup>1</sup>
<b>850CI</b>						
V12-5.0	1994-1993		234-4676 <sup>1</sup>	234-4200 <sup>1</sup>	-	-
V12-5.4	1997-1995		234-4672 <sup>1</sup>	234-4201 <sup>1</sup>	234-4684 <sup>1</sup>	234-4201 <sup>1</sup>
<b>850CSI</b>						
V12-5.6	1995-1994		234-4674 <sup>1</sup>	234-4200 <sup>1</sup>	-	-
<b>850I</b>						
V12-5.0	1992-1991		234-4676 <sup>1</sup>	234-4200 <sup>1</sup>	-	-
<b>ACTIVEHYBRID 3</b>						
L6-3.0	2015		234-5079	-	234-4971	-
L6-3.0	2014		234-5048	-	234-4971	-
L6-3.0	2013		234-5079	-	234-4479	-
<b>ACTIVEHYBRID 5</b>						
L6-3.0	2015-2014		234-5048	-	234-4971	-
L6-3.0	2013-2012		234-5048	-	234-4479	-
<b>ACTIVEHYBRID 7</b>						
L6-3.0	2015-2013		234-5080	-	234-4479	-

<sup>1</sup> 2 Required / Requis 2 / Requeridos 2 <sup>4</sup> Left Side / Côté gauche / Lado izquierdo <sup>5</sup> Right Side / Côté droit / Lado derecho



ENGINE MOTEUR MOTOR	YEAR ANNEE AÑO	APPLICATION INFORMATION INFORMATION D'APPLICATION INFORMACION DE APLICACION	UPSTREAM / AVANT - C.C. / ANTES DEL C.C.		DOWNSTREAM / APRS - C.C. / DESPUES DEL C.C.	
			TYPE / TIPO O.E.	UNIVERS.	TYPE / TIPO O.E.	UNIVERS.
<b>BMW [cont]</b>						
<b>ALPINA B6 XDRIVE GRAN COUPE</b>						
V8-4.4	2015		234-5026 <sup>1</sup>	-	234-4876 <sup>1</sup>	-
<b>ALPINA B7</b>						
V8-4.4	2015-2011		234-5026 <sup>1</sup>	-	234-4876 <sup>1</sup>	-
V8-4.4	2008-2007		234-5133 <sup>4</sup>	-	234-4470 <sup>4</sup>	234-4201 <sup>4</sup>
V8-4.4	2008-2007		234-5133 <sup>5</sup>	-	234-4470 <sup>5</sup>	234-4201 <sup>5</sup>
<b>ALPINA B7L</b>						
V8-4.4	2015-2011		234-5026 <sup>1</sup>	-	234-4876 <sup>1</sup>	-
<b>ALPINA B7L XDRIVE</b>						
V8-4.4	2015-2011		234-5026 <sup>1</sup>	-	234-4876 <sup>1</sup>	-
<b>ALPINA B7 XDRIVE</b>						
V8-4.4	2015-2011		234-5026 <sup>1</sup>	-	234-4876 <sup>1</sup>	-
<b>I3</b>						
-2-0.6	2015-2014		234-5168	-	234-4970	-
L2-0.6	2015		234-5168	-	234-4970	-
<b>I8</b>						
L3-1.5	2015-2014		234-5167	-	234-4973	-
<b>L6</b>						
L6-3.5	1987		234-3034	234-3000	-	-
<b>L7</b>						
L6-3.5	1987-1986		234-4023	234-4000	-	-
<b>M3</b>						
L4-2.3	1991-1988		234-3060	234-3000	-	-
L6-3.0	2015		234-5165 <sup>4</sup>	-	234-4972 <sup>4</sup>	-
L6-3.0	2015		234-5048 <sup>5</sup>	-	234-4973 <sup>5</sup>	-
L6-3.0	1995-1994	Auto Trans	234-4675 <sup>1</sup>	234-4200 <sup>1</sup>	-	-
L6-3.0	1995-1994	Manual Trans	234-4670 <sup>1</sup>	234-4200 <sup>1</sup>	-	-
L6-3.2	2006-2001	Cylinder 1,2,3	234-4677	234-4201	234-4678	234-4201
L6-3.2	2006-2001	Cylinder 4,5,6	234-4180	234-4201	234-4679	234-4201
L6-3.2	1999-1996		234-4789 <sup>1</sup>	-	234-4789 <sup>1</sup>	-
V8-4.0	2013-2008		234-5135 <sup>1</sup>	-	234-4875 <sup>1</sup>	-
<b>M4</b>						
L6-3.0	2015		234-5165 <sup>4</sup>	-	234-4972 <sup>4</sup>	-
L6-3.0	2015		234-5048 <sup>5</sup>	-	234-4973 <sup>5</sup>	-
<b>M5</b>						
L6-3.5	1988		234-3034	234-3000	-	-
L6-3.6	1993-1991		234-4707	234-4700	-	-
V8-4.4	2015-2012		234-5026 <sup>1</sup>	-	234-4892 <sup>1</sup>	-
V8-5.0	2003-2000		234-4672 <sup>1</sup>	234-4201 <sup>1</sup>	234-4681 <sup>1</sup>	234-4201 <sup>1</sup>

<sup>1</sup> 2 Required / Requis 2 / Requeridos 2 <sup>4</sup> Left Side / Côté gauche / Lado izquierdo <sup>5</sup> Right Side / Côté droit / Lado derecho



ENGINE MOTEUR MOTOR	YEAR ANNEE AÑO	APPLICATION INFORMATION INFORMATION D'APPLICATION INFORMACION DE APLICACION	UPSTREAM / AVANT - C.C. / ANTES DEL C.C.		DOWNSTREAM / APRS - C.C. / DESPUES DEL C.C.	
			TYPE / TIPO O.E.	UNIVERS.	TYPE / TIPO O.E.	UNIVERS.
<b>BMW [cont]</b>						
<b>M5 [cont]</b>						
V10-5.0	2010-2006		234-5140 <sup>1</sup>	-	234-4470 <sup>1</sup>	234-4201 <sup>1</sup>
<b>M6</b>						
L6-3.5	1988-1987		234-3034 <sup>1</sup>	234-3000 <sup>1</sup>	-	-
V8-4.4	2015-2012		234-5026 <sup>1</sup>	-	234-4892 <sup>1</sup>	-
V10-5.0	2010-2006		234-5140 <sup>1</sup>	-	234-4470 <sup>1</sup>	234-4201 <sup>1</sup>
<b>M6 GRAN COUPE</b>						
V8-4.4	2015-2014		234-5026 <sup>1</sup>	-	234-4892 <sup>1</sup>	-
<b>M235I</b>						
L6-3.0	2015-2014		234-5048	-	234-4971	-
<b>M235I XDRIVE</b>						
L6-3.0	2015		234-5048	-	234-4971	-
<b>X1</b>						
L4-2.0	2015-2012		234-5054	-	234-4562	-
L6-3.0	2015-2013		234-5079	-	234-4480	-
<b>X3</b>						
L4-2.0	2015-2013		234-5054	-	234-4562	-
L6-2.5	2006-2004		234-4672 <sup>1</sup>	234-4201 <sup>1</sup>	234-4683 <sup>1</sup>	234-4201 <sup>1</sup>
L6-3.0	2015-2013		234-5080	-	234-4479	-
L6-3.0	2012-2011	xDrive35i	234-5080	-	234-4479	-
L6-3.0	2012-2010	xDrive28i; Cylinder 1,2,3	234-5138	-	234-4477	-
L6-3.0	2012-2010	xDrive28i; Cylinder 4,5,6	234-5027	-	234-4478	-
L6-3.0	2010	xDrive30i; Cylinder 1,2,3	234-5139	-	234-4876	-
L6-3.0	2010	xDrive30i; Cylinder 4,5,6	234-5138	-	234-4892	-
L6-3.0	2009-2007	Cylinder 1,2,3	234-5139	-	234-4876	-
L6-3.0	2009-2007	Cylinder 4,5,6	234-5138	-	234-4892	-
L6-3.0	2006-2004	Auto Trans	234-5137 <sup>1</sup>	-	234-4473 <sup>1</sup>	234-4201 <sup>1</sup>
L6-3.0	2006-2004	Manual Trans	234-4672 <sup>1</sup>	234-4201 <sup>1</sup>	234-4683 <sup>1</sup>	234-4201 <sup>1</sup>
<b>X4</b>						
L4-2.0	2015		234-5054	-	234-4562	-
L6-3.0	2015		234-5080	-	234-4479	-
<b>X5</b>						
L6-3.0	2015-2014	Gas Engine	234-5048	-	234-4971	-
L6-3.0	2013-2011	Gas Engine	234-5048	-	234-4479	-
L6-3.0	2012-2009	Diesel Engine	234-5140	-	-	-
L6-3.0	2010-2009	Gas Engine; Cylinder 1,2,3	234-5139	-	234-4876	-
L6-3.0	2010-2009	Gas Engine; Cylinder 4,5,6	234-5138	-	234-4892	-
L6-3.0	2008-2007	Cylinder 1,2,3	234-5139	-	234-4876	-
L6-3.0	2008-2007	Cylinder 4,5,6	234-5138	-	234-4892	-
L6-3.0	2006-2001		234-4672 <sup>1</sup>	234-4201 <sup>1</sup>	234-4683 <sup>1</sup>	234-4201 <sup>1</sup>
V8-4.4	2015-2014		234-5026 <sup>1</sup>	-	234-4876 <sup>1</sup>	-

<sup>1</sup> 2 Required / Requis 2 / Requeridos 2



ENGINE MOTEUR MOTOR	YEAR ANNEE AÑO	APPLICATION INFORMATION INFORMATION D'APPLICATION INFORMACION DE APLICACION	UPSTREAM / AVANT - C.C. / ANTES DEL C.C.		DOWNSTREAM / APRES - C.C. / DESPUES DEL C.C.	
			TYPE / TIPO O.E.	UNIVERS.	TYPE / TIPO O.E.	UNIVERS.
<b>BMW [cont]</b>						
<b>X5 [cont]</b>						
V8-4.4	2013-2011	M Model	234-5026 <sup>1</sup>	-	234-4875 <sup>1</sup>	-
V8-4.4	2013-2011	xDrive Models	234-5026 <sup>1</sup>	-	234-4876 <sup>1</sup>	-
V8-4.4	2010		234-5026 <sup>1</sup>	-	234-4875 <sup>1</sup>	-
V8-4.4	2006-2004		234-5134 <sup>4</sup>	-	234-4472 <sup>4</sup>	234-4201 <sup>4</sup>
V8-4.4	2006-2004		234-5132 <sup>5</sup>	-	234-4470 <sup>5</sup>	234-4201 <sup>5</sup>
V8-4.4	2003-2000		234-4672 <sup>1</sup>	234-4201 <sup>1</sup>	234-4682 <sup>1</sup>	234-4201 <sup>1</sup>
V8-4.6	2003-2002		234-4672 <sup>1</sup>	234-4201 <sup>1</sup>	234-4682 <sup>1</sup>	234-4201 <sup>1</sup>
V8-4.8	2010-2007		234-5138 <sup>4</sup>	-	234-4875 <sup>4</sup>	-
V8-4.8	2010-2007		234-5136 <sup>5</sup>	-	234-4875 <sup>5</sup>	-
V8-4.8	2006-2004		234-5134 <sup>4</sup>	-	234-4472 <sup>4</sup>	234-4201 <sup>4</sup>
V8-4.8	2006-2004		234-5132 <sup>5</sup>	-	234-4470 <sup>5</sup>	234-4201 <sup>5</sup>
<b>X6</b>						
L6-3.0	2015		234-5048	-	234-4971	-
L6-3.0	2014-2011		234-5048	-	234-4479	-
L6-3.0	2010-2008	Cylinder 1,2,3	234-5025	-	234-4900	-
L6-3.0	2010-2008	Cylinder 4,5,6	234-5027	-	234-4891	-
V8-4.4	2015	N63B44B Engine	234-5026 <sup>1</sup>	-	234-4876 <sup>1</sup>	-
V8-4.4	2014	Exc. M Model	234-5026 <sup>1</sup>	-	234-4876 <sup>1</sup>	-
V8-4.4	2014	M Model	234-5026 <sup>1</sup>	-	234-4875 <sup>1</sup>	-
V8-4.4	2013	N63B44B Engine	234-5026 <sup>1</sup>	-	234-4876 <sup>1</sup>	-
V8-4.4	2013	S63B44 Engine	234-5026 <sup>1</sup>	-	234-4875 <sup>1</sup>	-
V8-4.4	2013	S63B44A Engine	234-5026 <sup>1</sup>	-	234-4875 <sup>1</sup>	-
V8-4.4	2012-2010	Exc. M Model	234-5026 <sup>1</sup>	-	234-4876 <sup>1</sup>	-
V8-4.4	2012-2010	M Model	234-5026 <sup>1</sup>	-	234-4875 <sup>1</sup>	-
V8-4.4	2009-2008		234-5026 <sup>1</sup>	-	234-4876 <sup>1</sup>	-
<b>Z3</b>						
L4-1.9	1998-1996		234-4672	234-4201	234-4681	234-4201
L6-2.5	2002-1999		234-4672 <sup>1</sup>	234-4201 <sup>1</sup>	234-4683 <sup>1</sup>	234-4201 <sup>1</sup>
L6-2.8	2000-1999		234-4672 <sup>1</sup>	234-4201 <sup>1</sup>	234-4683 <sup>1</sup>	234-4201 <sup>1</sup>
L6-2.8	1998-1997	To 09/98	234-4785	-	234-4789	-
L6-2.8	1998	From 09/98	234-4672 <sup>1</sup>	234-4201 <sup>1</sup>	234-4683 <sup>1</sup>	234-4201 <sup>1</sup>
L6-3.0	2002-2001		234-4672 <sup>1</sup>	234-4201 <sup>1</sup>	234-4683 <sup>1</sup>	234-4201 <sup>1</sup>
L6-3.2	2002-2001	Cylinder 1,2,3	234-4677	234-4201	234-4678	234-4201
L6-3.2	2002-2001	Cylinder 4,5,6	234-4180	234-4201	234-4679	234-4201
L6-3.2	2000-1998		234-4789 <sup>1</sup>	-	234-4784 <sup>1</sup>	-
<b>Z4</b>						
L4-2.0	2015-2012		234-5054	-	234-4562	-
L6-2.5	2005-2003		234-4672 <sup>1</sup>	234-4201 <sup>1</sup>	234-4683 <sup>1</sup>	234-4201 <sup>1</sup>
L6-3.0	2015-2006	Cylinder 1,2,3	234-5139	-	234-4876	-

<sup>1</sup> 2 Required / Requis 2 / Requeridos 2 <sup>4</sup> Left Side / Côté gauche / Lado izquierdo <sup>5</sup> Right Side / Côté droit / Lado derecho



ENGINE MOTEUR MOTOR	YEAR ANNEE AÑO	APPLICATION INFORMATION INFORMATION D'APPLICATION INFORMACION DE APLICACION	UPSTREAM / AVANT - C.C. / ANTES DEL C.C.		DOWNSTREAM / APRES - C.C. / DESPUES DEL C.C.	
			TYPE / TIPO O.E.	UNIVERS.	TYPE / TIPO O.E.	UNIVERS.
<b>BMW [cont]</b>						
<b>Z4 [cont]</b>						
L6-3.0	2015-2006	Cylinder 4,5,6	234-5138	-	234-4892	-
L6-3.0	2005-2003		234-4672 <sup>1</sup>	234-4201 <sup>1</sup>	234-4683 <sup>1</sup>	234-4201 <sup>1</sup>
L6-3.2	2008-2006	Cylinder 1,2,3	234-5138	-	234-4678	234-4201
L6-3.2	2008-2006	Cylinder 4,5,6	234-5138	-	234-4679	234-4201
<b>Z8</b>						
V8-4.8	2003		234-4672 <sup>1</sup>	234-4201 <sup>1</sup>	234-4684 <sup>1</sup>	234-4201 <sup>1</sup>
V8-5.0	2003-2000		234-4672 <sup>1</sup>	234-4201 <sup>1</sup>	234-4684 <sup>1</sup>	234-4201 <sup>1</sup>
<b>BUICK</b>						
<b>ALLURE</b>						
L4-2.4	2010		234-4673	234-4212	234-4251	-
V6-3.0	2010		234-4815 <sup>1</sup>	-	234-4815 <sup>1</sup>	-
V6-3.6	2010		234-4815 <sup>1</sup>	-	234-4815 <sup>1</sup>	-
V6-3.6	2008-2005		234-5005	-	234-4815	-
V6-3.8	2009-2008	Calif.	234-4668	234-4212	234-4103	234-4209
V6-3.8	2009-2008	Exc. Calif.	234-4646	234-4209	234-4103	234-4209
V6-3.8	2007-2005	Calif.	234-4668	234-4212	234-4647	234-4209
V6-3.8	2007-2005	Exc. Calif.	234-4646	234-4209	234-4647	234-4209
V8-5.3	2009-2008		234-4236	-	234-4249	-
<b>CENTURY</b>						
L4-2.2	1996		234-1001	234-1000	234-4087	234-4000
L4-2.2	1995-1993		234-1001	234-1000	-	-
L4-2.5	1992-1982		234-1001	234-1000	-	-
V6-2.8	1989-1982		234-1001	234-1000	-	-
V6-3.0	1985-1982		234-1001	234-1000	-	-
V6-3.1	2005		234-4343	-	234-4647	234-4209
V6-3.1	2004-2001		234-4650	234-4209	234-4087	234-4000
V6-3.1	2000-1997		234-4018	234-4000	234-4087	234-4000
V6-3.1	1996		234-4012	234-4000	234-4087	234-4000
V6-3.1	1995-1994		234-4012	234-4000	-	-
V6-3.3	1993-1989		234-1001	234-1000	-	-
V6-3.8	1988-1984		234-1001	234-1000	-	-
V6-3.8	1981-1979		234-2001	234-2000	-	-
V8-4.3	1981-1980		234-2001	234-2000	-	-
V8-4.4	1981		234-2001	234-2000	-	-
V8-4.9	1980		234-2001	234-2000	-	-
V8-5.0	1981-1980		234-2001	234-2000	-	-
<b>ELECTRA</b>						
V6-3.0	1985		234-1001	234-1000	-	-
V6-3.8	1990-1985		234-1001	234-1000	-	-
V6-4.1	1984-1982		234-1001	234-1000	-	-

<sup>1</sup> 2 Required / Requis 2 / Requeridos 2





ENGINE MOTEUR MOTOR	YEAR ANNEE AÑO	APPLICATION INFORMATION INFORMATION D'APPLICATION INFORMACION DE APLICACION	UPSTREAM / AVANT - C.C. / ANTES DEL C.C.		DOWNSTREAM / APRES - C.C. / DESPUES DEL C.C.	
			TYPE / TIPO O.E.	UNIVERS.	TYPE / TIPO O.E.	UNIVERS.
<b>BUICK [cont]</b>						
<b>ELECTRA [cont]</b>						
V6-4.1	1981-1980		234-2001	234-2000	-	-
V8-4.9	1980		234-2001	234-2000	-	-
V8-5.0	1989-1982		234-1001	234-1000	-	-
V8-5.0	1981		234-2001	234-2000	-	-
V8-5.7	1981-1980		234-2001	234-2000	-	-
<b>ENCLAVE</b>						
V6-3.6	2015-2012		234-4565 <sup>1</sup>	-	234-4566 <sup>1</sup>	-
V6-3.6	2011-2009		234-4815 <sup>1</sup>	-	234-4816 <sup>1</sup>	-
V6-3.6	2008		234-4668 <sup>1</sup>	234-4212 <sup>1</sup>	234-4294 <sup>1</sup>	-
<b>ENCORE</b>						
L4-1.4	2015-2014		234-4780	-	234-4821	-
L4-1.4	2013	1st Design; w/ Black Sleeve	234-4529	-	234-4821	-
L4-1.4	2013	2nd Design; w/ Grey Sleeve	234-4780	-	234-4821	-
<b>ESTATE WAGON</b>						
V8-4.9	1980		234-2001	234-2000	-	-
V8-5.0	1983-1982		234-1001	234-1000	-	-
V8-5.0	1981		234-2001	234-2000	-	-
V8-5.7	1980		234-2001	234-2000	-	-
<b>LACROSSE</b>						
L4-2.4	2015		234-4673	234-4212	234-4526	-
L4-2.4	2014		234-4564	-	234-4564	-
L4-2.4	2013-2011		234-4673	234-4212	234-4526	-
L4-2.4	2010		234-4673	234-4212	234-4251	-
V6-3.0	2010		234-4815 <sup>1</sup>	-	234-4815 <sup>1</sup>	-
V6-3.6	2015-2012		234-4564 <sup>1</sup>	-	234-4564 <sup>1</sup>	-
V6-3.6	2011		234-4815 <sup>1</sup>	-	234-4816 <sup>1</sup>	-
V6-3.6	2010		234-4815 <sup>1</sup>	-	234-4815 <sup>1</sup>	-
V6-3.6	2008-2005		234-5005	-	234-4815	-
V6-3.8	2009-2008	Calif.	234-4668	234-4212	234-4103	234-4209
V6-3.8	2009-2008	Exc. Calif.	234-4646	234-4209	234-4103	234-4209
V6-3.8	2007-2005	Calif.	234-4668	234-4212	234-4647	234-4209
V6-3.8	2007-2005	Exc. Calif.	234-4646	234-4209	234-4647	234-4209
V8-5.3	2009-2008		234-4236	-	234-4249	-
<b>LESABRE</b>						
V6-3.0	1986		234-1001	234-1000	-	-
V6-3.8	2005-2004		234-4646	234-4209	234-4647	234-4209
V6-3.8	2003-1997		234-4018	234-4000	234-4087	234-4000
V6-3.8	1996		234-4012	234-4000	234-4087	234-4000
V6-3.8	1995-1994		234-4012	234-4000	-	-
V6-3.8	1993	1 Lead Sensor	234-1001	234-1000	-	-
V6-3.8	1993	3 Lead Sensor	234-3011	234-3000	-	-

<sup>1</sup> 2 Required / Requis 2 / Requeridos 2



ENGINE MOTEUR MOTOR	YEAR ANNEE AÑO	APPLICATION INFORMATION INFORMATION D'APPLICATION INFORMACION DE APLICACION	UPSTREAM / AVANT - C.C. / ANTES DEL C.C.		DOWNSTREAM / APRES - C.C. / DESPUES DEL C.C.	
			TYPE / TIPO O.E.	UNIVERS.	TYPE / TIPO O.E.	UNIVERS.
<b>BUICK [cont]</b>						
<b>LESABRE [cont]</b>						
V6-3.8	1992-1982		234-1001	234-1000	-	-
V6-3.8	1981-1979		234-2001	234-2000	-	-
V6-4.1	1984-1982		234-1001	234-1000	-	-
V6-4.1	1981-1980		234-2001	234-2000	-	-
V8-4.4	1982		234-1001	234-1000	-	-
V8-4.9	1980-1979		234-2001	234-2000	-	-
V8-5.0	1990-1982		234-1001	234-1000	-	-
V8-5.0	1981		234-2001	234-2000	-	-
V8-5.7	1980-1979		234-2001	234-2000	-	-
<b>LUCERNE</b>						
V6-3.8	2008-2007	Calif.	234-4668	234-4212	234-4647	234-4209
V6-3.8	2008-2007	Exc. Calif.	234-4646	234-4209	234-4647	234-4209
V6-3.8	2006		234-4646	234-4209	234-4647	234-4209
V6-3.9	2011-2009		234-4668	234-4212	234-4291	-
V8-4.6	2011-2006		234-4339 <sup>1</sup>	-	234-4337	-
<b>PARK AVENUE</b>						
V6-3.8	2005-2004		234-4646	234-4209	234-4647	234-4209
V6-3.8	2003-1997		234-4018	234-4000	234-4087	234-4000
V6-3.8	1996		234-4012	234-4000	234-4087	234-4000
V6-3.8	1995-1994		234-4012	234-4000	-	-
V6-3.8	1993	Exc. Supercharged	234-3011	234-3000	-	-
V6-3.8	1993	Supercharged	234-1001	234-1000	-	-
V6-3.8	1992-1991		234-1001	234-1000	-	-
<b>RAINIER</b>						
L6-4.2	2007		234-4331	-	234-4294	-
L6-4.2	2006		234-4331	-	234-4348	-
L6-4.2	2005-2004		234-4119	-	234-4285	-
V8-5.3	2007		234-4339 <sup>1</sup>	-	234-4561 <sup>1</sup>	-
V8-5.3	2006	1st Design; Square Downstream Connector	234-4339 <sup>1</sup>	-	234-4285 <sup>1</sup>	-
V8-5.3	2006	2nd Design; Triangular Downstream Connector	234-4339 <sup>1</sup>	-	234-4561 <sup>1</sup>	-
V8-5.3	2005		234-4668 <sup>1</sup>	234-4212 <sup>1</sup>	234-4651 <sup>1</sup>	234-4209 <sup>1</sup>
V8-5.3	2004		234-4650 <sup>1</sup>	234-4209 <sup>1</sup>	234-4647 <sup>1</sup>	234-4209 <sup>1</sup>
<b>REATTA</b>						
V6-3.8	1991-1988		234-1001	234-1000	-	-
<b>REGAL</b>						
L4-2.0	2015-2014		234-4763	-	234-4762	-
L4-2.0	2013-2011		234-4673	234-4212	234-4526	-
L4-2.4	2015-2011		234-4673	234-4212	234-4526	-
V6-2.8	1989-1988		234-1001	234-1000	-	-
V6-3.1	1996		234-4012 <sup>1</sup>	234-4000 <sup>1</sup>	234-4087	234-4000
V6-3.1	1995-1994		234-4012	234-4000	-	-

<sup>1</sup> 2 Required / Requis 2 / Requeridos 2



ENGINE MOTEUR MOTOR	YEAR ANNEE AÑO	APPLICATION INFORMATION INFORMATION D'APPLICATION INFORMACION DE APLICACION	UPSTREAM / AVANT - C.C. / ANTES DEL C.C.		DOWNSTREAM / APRS - C.C. / DESPUES DEL C.C.	
			TYPE / TIPO O.E.	UNIVERS.	TYPE / TIPO O.E.	UNIVERS.
<b>BUICK [cont]</b>						
<b>REGAL [cont]</b>						
V6-3.1	1993	Calif.	234-3094	234-3090	-	-
V6-3.1	1993	Exc. Calif.	234-1001	234-1000	-	-
V6-3.1	1992-1989		234-1001	234-1000	-	-
V6-3.2	1979		234-2001	234-2000	-	-
V6-3.8	2004		234-4646	234-4209	234-4647	234-4209
V6-3.8	2003-1997		234-4018	234-4000	234-4087	234-4000
V6-3.8	1996		234-4012	234-4000	234-4087	234-4000
V6-3.8	1995		234-4012	234-4000	234-4012	234-4000
V6-3.8	1994-1993	4 Lead Sensor	234-4012	234-4000	-	-
V6-3.8	1993	3 Lead Sensor	234-3011	234-3000	-	-
V6-3.8	1992-1990		234-1001	234-1000	-	-
V6-3.8	1987-1982		234-1001	234-1000	-	-
V6-3.8	1981-1979		234-2001	234-2000	-	-
V6-4.1	1984-1982		234-1001	234-1000	-	-
V8-4.3	1981-1980		234-2001	234-2000	-	-
V8-4.4	1982		234-1001	234-1000	-	-
V8-4.4	1981		234-2001	234-2000	-	-
V8-4.9	1980-1979		234-2001	234-2000	-	-
V8-5.0	1987-1982		234-1001	234-1000	-	-
V8-5.0	1980-1979		234-2001	234-2000	-	-
<b>RENDEZVOUS</b>						
V6-3.4	2005		234-4343	-	234-4647	234-4209
V6-3.4	2004-2002		234-4650	234-4209	234-4087	234-4000
V6-3.5	2007-2006		234-4668	234-4212	234-4647	234-4209
V6-3.6	2006-2005		234-5004	-	234-4815	-
V6-3.6	2004		234-5004	-	234-4821	-
<b>RIVIERA</b>						
V6-3.8	1999-1997		234-4018	234-4000	234-4087	234-4000
V6-3.8	1996		234-4012	234-4000	234-4087	234-4000
V6-3.8	1995		234-4012	234-4000	-	-
V6-3.8	1993-1982		234-1001	234-1000	-	-
V6-3.8	1981-1979		234-2001	234-2000	-	-
V6-4.1	1984-1982		234-1001	234-1000	-	-
V6-4.1	1981		234-2001	234-2000	-	-
V8-5.0	1985-1982		234-1001	234-1000	-	-
V8-5.0	1981-1980		234-2001	234-2000	-	-
V8-5.7	1980-1979		234-2001	234-2000	-	-
<b>ROADMASTER</b>						
V8-5.0	1991		234-1001	234-1000	-	-
V8-5.7	1996		234-4012 <sup>1</sup>	234-4000 <sup>1</sup>	234-4012 <sup>1</sup>	234-4000 <sup>1</sup>
V8-5.7	1995-1994		234-4012 <sup>1</sup>	234-4000 <sup>1</sup>	-	-

<sup>1</sup> 2 Required / Requis 2 / Requeridos 2



ENGINE MOTEUR MOTOR	YEAR ANNEE AÑO	APPLICATION INFORMATION INFORMATION D'APPLICATION INFORMACION DE APLICACION	UPSTREAM / AVANT - C.C. / ANTES DEL C.C.		DOWNSTREAM / APRS - C.C. / DESPUES DEL C.C.	
			TYPE / TIPO O.E.	UNIVERS.	TYPE / TIPO O.E.	UNIVERS.
<b>BUICK [cont]</b>						
<b>ROADMASTER [cont]</b>						
V8-5.7	1993-1992		234-1001	234-1000	-	-
<b>SKYHAWK</b>						
L4-1.8	1986-1983		234-1001	234-1000	-	-
L4-1.8	1982	Carbureted	234-1001	234-1000	-	-
L4-1.8	1982	Fuel Injected	234-2001	234-2000	-	-
L4-2.0	1989-1983		234-1001	234-1000	-	-
V6-3.8	1980-1979		234-2001	234-2000	-	-
<b>SKYLARK</b>						
L4-2.3	1995-1988		234-1001	234-1000	-	-
L4-2.4	1998-1996		234-1001	234-1000	234-4616	234-4000
L4-2.5	1991-1982		234-1001	234-1000	-	-
L4-2.5	1981-1980		234-2001	234-2000	-	-
V6-2.8	1985-1982		234-1001	234-1000	-	-
V6-2.8	1981-1980		234-2001	234-2000	-	-
V6-3.0	1988-1986		234-1001	234-1000	-	-
V6-3.1	1998-1997		234-4018	234-4000	234-4616	234-4000
V6-3.1	1996		234-4012	234-4000	234-4616	234-4000
V6-3.1	1995-1994		234-4012	234-4000	-	-
V6-3.3	1993-1989		234-1001	234-1000	-	-
V6-3.8	1979		234-2001	234-2000	-	-
V8-5.0	1979		234-2001	234-2000	-	-
V8-5.7	1979		234-2001	234-2000	-	-
<b>SOMERSET</b>						
L4-2.5	1987-1986		234-1001	234-1000	-	-
V6-3.0	1987-1986		234-1001	234-1000	-	-
<b>SOMERSET REGAL</b>						
L4-2.5	1985		234-1001	234-1000	-	-
V6-3.0	1985		234-1001	234-1000	-	-
<b>TERRAZA</b>						
V6-3.5	2006-2005		234-4668	234-4212	234-4647	234-4209
V6-3.9	2007-2006		234-4668	234-4212	234-4647	234-4209
<b>VERANO</b>						
L4-2.0	2016-2015		234-4673	234-4212	234-4567	-
L4-2.0	2014		234-4673	234-4212	234-4526	-
L4-2.0	2013		234-4673	234-4212	234-4567	-
L4-2.4	2016-2015		234-4673	234-4212	234-4975	-
L4-2.4	2014-2012		234-4673	234-4212	234-4567	-
<b>CADILLAC</b>						
<b>60 SPECIAL</b>						
V8-4.9	1993		234-2001	234-2000	-	-



ENGINE MOTEUR MOTOR	YEAR ANNEE AÑO	APPLICATION INFORMATION INFORMATION D'APPLICATION INFORMACION DE APLICACION	UPSTREAM / AVANT - C.C. / ANTES DEL C.C.		DOWNSTREAM / APRS - C.C. / DESPUES DEL C.C.	
			TYPE / TIPO O.E.	UNIVERS.	TYPE / TIPO O.E.	UNIVERS.
<b>CADILLAC [cont]</b>						
<b>ALLANTE</b>						
V8-4.1	1988-1987		234-2001	234-2000	-	-
V8-4.5	1992-1989		234-2001	234-2000	-	-
V8-4.6	1993		234-4006	234-4000	-	-
<b>ATS</b>						
L4-2.0	2015-2013		234-4763	-	234-4762	-
L4-2.5	2015-2013		234-4763	-	234-4762	-
V6-3.6	2015-2013		234-4441 <sup>1</sup>	-	234-4565 <sup>1</sup>	-
<b>BROUGHAM</b>						
V8-5.0	1992-1987		234-1001	234-1000	-	-
V8-5.7	1992-1990		234-1001	234-1000	-	-
<b>CATERA</b>						
V6-3.0	2001-1999		234-5006 <sup>1</sup>	-	234-4830 <sup>1</sup>	-
V6-3.0	1998-1997		234-4688 <sup>1</sup>	234-4201 <sup>1</sup>	234-4688 <sup>1</sup>	234-4201 <sup>1</sup>
<b>CIMARRON</b>						
L4-1.8	1982		234-1001	234-1000	-	-
L4-2.0	1986-1983		234-1001	234-1000	-	-
V6-2.8	1988-1985		234-1001	234-1000	-	-
<b>COMMERCIAL CHASSIS</b>						
V8-6.0	1984-1980		234-2001	234-2000	-	-
<b>CTS</b>						
L4-2.0	2015-2014		234-4763	-	234-4762	-
V6-2.8	2007-2006		234-5110 <sup>1</sup>	-	234-4818 <sup>1</sup>	-
V6-2.8	2005	1st Design; Rectangular Upstream Connector	234-5002 <sup>1</sup>	-	234-4818 <sup>1</sup>	-
V6-2.8	2005	2nd Design; Oval Upstream Connector	234-5110 <sup>1</sup>	-	234-4818 <sup>1</sup>	-
V6-3.0	2014-2012		234-4441 <sup>4</sup>	-	234-4244 <sup>4</sup>	-
V6-3.0	2014-2012		234-4441 <sup>5</sup>	-	234-4565 <sup>5</sup>	-
V6-3.0	2011-2010		234-4441 <sup>5</sup>	-	234-4818 <sup>5</sup>	-
V6-3.0	2011-2010	Auto Trans	234-4441 <sup>4</sup>	-	234-4244 <sup>4</sup>	-
V6-3.0	2011-2010	Manual Trans	234-4441 <sup>4</sup>	-	234-4818 <sup>4</sup>	-
V6-3.2	2004-2003		234-4821 <sup>1</sup>	-	234-4821 <sup>1</sup>	-
V6-3.6	2015		234-4441 <sup>1</sup>	-	234-4565 <sup>1</sup>	-
V6-3.6	2014	Non-Turbo	234-4441 <sup>5</sup>	-	234-4565 <sup>5</sup>	-
V6-3.6	2014	Non-Turbo; Exc. Luxury Model	234-4441 <sup>4</sup>	-	234-4244 <sup>4</sup>	-
V6-3.6	2014	Non-Turbo; Luxury Model	234-4441 <sup>4</sup>	-	234-4565 <sup>4</sup>	-
V6-3.6	2013-2012		234-4441 <sup>4</sup>	-	234-4244 <sup>4</sup>	-
V6-3.6	2013-2012		234-4441 <sup>5</sup>	-	234-4565 <sup>5</sup>	-
V6-3.6	2011-2008		234-4819 <sup>5</sup>	-	234-4818 <sup>5</sup>	-
V6-3.6	2011-2008	Auto Trans	234-4819 <sup>4</sup>	-	234-4244 <sup>4</sup>	-
V6-3.6	2011-2008	Manual Trans	234-4819 <sup>4</sup>	-	234-4818 <sup>4</sup>	-

<sup>1</sup> 2 Required / Requis 2 / Requeridos 2 <sup>4</sup> Left Side / Côté gauche / Lado izquierdo <sup>5</sup> Right Side / Côté droit / Lado derecho



ENGINE MOTEUR MOTOR	YEAR ANNEE AÑO	APPLICATION INFORMATION INFORMATION D'APPLICATION INFORMACION DE APLICACION	UPSTREAM / AVANT - C.C. / ANTES DEL C.C.		DOWNSTREAM / APRES - C.C. / DESPUES DEL C.C.	
			TYPE / TIPO O.E.	UNIVERS.	TYPE / TIPO O.E.	UNIVERS.
<b>CADILLAC [cont]</b>						
<b>CTS [cont]</b>						
V6-3.6	2007-2006		234-5110 <sup>1</sup>	-	234-4818 <sup>1</sup>	-
V6-3.6	2005	1st Design; Rectangular Upstream Connector	234-5002 <sup>1</sup>	-	234-4818 <sup>1</sup>	-
V6-3.6	2005	2nd Design; Oval Upstream Connector	234-5110 <sup>1</sup>	-	234-4818 <sup>1</sup>	-
V6-3.6	2004	1st Design; Rectangular Upstream Connector	234-5002 <sup>1</sup>	-	234-4816 <sup>1</sup>	-
V6-3.6	2004	2nd Design; Oval Upstream Connector	234-5110 <sup>1</sup>	-	234-4816 <sup>1</sup>	-
V8-5.7	2005-2004		234-4818 <sup>1</sup>	-	234-4651 <sup>1</sup>	234-4209 <sup>1</sup>
V8-6.0	2007		234-4236 <sup>1</sup>	-	234-4651 <sup>1</sup>	234-4209 <sup>1</sup>
V8-6.0	2006		234-4236 <sup>1</sup>	-	234-4112 <sup>1</sup>	234-4209 <sup>1</sup>
V8-6.2	2015-2009		234-4668 <sup>1</sup>	234-4212 <sup>1</sup>	234-4252 <sup>1</sup>	-
<b>DEVILLE</b>						
V6-4.1	1982	1 Lead Sensor	234-1001	234-1000	-	-
V6-4.1	1982	2 Lead Sensor	234-2001	234-2000	-	-
V6-4.1	1981-1980		234-2001	234-2000	-	-
V8-4.1	1987-1985		234-1001	234-1000	-	-
V8-4.1	1984-1983		234-2001	234-2000	-	-
V8-4.1	1982	1 Lead Sensor	234-1001	234-1000	-	-
V8-4.1	1982	2 Lead Sensor	234-2001	234-2000	-	-
V8-4.5	1990-1988		234-2001	234-2000	-	-
V8-4.6	2005-2004		234-4668 <sup>1</sup>	234-4212 <sup>1</sup>	234-4346	-
V8-4.6	2003-2000		234-4650 <sup>1</sup>	234-4209 <sup>1</sup>	234-4651	234-4209
V8-4.6	1999		234-4018 <sup>1</sup>	234-4000 <sup>1</sup>	234-4025 <sup>1</sup>	234-4000 <sup>1</sup>
V8-4.6	1998-1996	Upstream Sensor in Exhaust Pipe	234-4025 <sup>1</sup>	234-4000 <sup>1</sup>	-	-
V8-4.6	1998-1996	Upstream Sensor in Manifold	234-4018 <sup>1</sup>	234-4000 <sup>1</sup>	234-4025 <sup>1</sup>	234-4000 <sup>1</sup>
V8-4.6	1995-1994		234-4006 <sup>1</sup>	234-4000 <sup>1</sup>	-	-
V8-4.9	1995-1994		234-2001 <sup>1</sup>	234-2000 <sup>1</sup>	-	-
V8-4.9	1993-1991		234-2001	234-2000	-	-
V8-6.0	1981-1980		234-2001	234-2000	-	-
<b>DTS</b>						
V8-4.6	2011-2006		234-4339 <sup>1</sup>	-	234-4337	-
<b>ELDORADO</b>						
V6-4.1	1982	1 Lead Sensor	234-1001	234-1000	-	-
V6-4.1	1982	2 Lead Sensor	234-2001	234-2000	-	-
V6-4.1	1981		234-2001	234-2000	-	-
V8-4.1	1987		234-2001	234-2000	-	-
V8-4.1	1986-1985		234-1001	234-1000	-	-
V8-4.1	1984-1983		234-2001	234-2000	-	-
V8-4.1	1982	1 Lead Sensor	234-1001	234-1000	-	-
V8-4.1	1982	2 Lead Sensor	234-2001	234-2000	-	-
V8-4.5	1990-1988		234-2001	234-2000	-	-
V8-4.6	2002-2001		234-4650 <sup>1</sup>	234-4209 <sup>1</sup>	234-4651	234-4209

<sup>1</sup> 2 Required / Requis 2 / Requeridos 2



ENGINE MOTEUR MOTOR	YEAR ANNEE AÑO	APPLICATION INFORMATION INFORMATION D'APPLICATION INFORMACION DE APLICACION	UPSTREAM / AVANT - C.C. / ANTES DEL C.C.		DOWNSTREAM / APRS - C.C. / DESPUES DEL C.C.	
			TYPE / TIPO O.E.	UNIVERS.	TYPE / TIPO O.E.	UNIVERS.
<b>CADILLAC [cont]</b>						
<b>ELDORADO [cont]</b>						
V8-4.6	2000-1999		234-4018 <sup>1</sup>	234-4000 <sup>1</sup>	234-4025 <sup>1</sup>	234-4000 <sup>1</sup>
V8-4.6	1998-1996	Upstream Sensor in Exhaust Pipe	234-4025 <sup>1</sup>	234-4000 <sup>1</sup>	-	-
V8-4.6	1998-1996	Upstream Sensor in Manifold	234-4018 <sup>1</sup>	234-4000 <sup>1</sup>	234-4025 <sup>1</sup>	234-4000 <sup>1</sup>
V8-4.6	1995-1993		234-4006 <sup>1</sup>	234-4000 <sup>1</sup>	-	-
V8-4.9	1993-1991		234-2001 <sup>1</sup>	234-2000 <sup>1</sup>	-	-
V8-5.7	1980-1979		234-1025	234-1000	-	-
V8-6.0	1981-1980		234-2001	234-2000	-	-
<b>ELR</b>						
L4-1.4	2014		234-4529	-	234-4815	-
<b>ESCALADE</b>						
V8-5.3	2005-2003		234-4668 <sup>1</sup>	234-4212 <sup>1</sup>	234-4668 <sup>1</sup>	234-4212 <sup>1</sup>
V8-5.3	2002	Canada Built	234-4650 <sup>1</sup>	234-4209 <sup>1</sup>	234-4650 <sup>1</sup>	234-4209 <sup>1</sup>
V8-5.3	2002	Exc. Canada Built	234-4012 <sup>1</sup>	234-4000 <sup>1</sup>	234-4018 <sup>1</sup>	234-4000 <sup>1</sup>
V8-5.7	2000-1999		234-4012 <sup>1</sup>	234-4000 <sup>1</sup>	234-4018 <sup>1</sup>	234-4000 <sup>1</sup>
V8-6.0	2013-2009		234-4668 <sup>1</sup>	234-4212 <sup>1</sup>	234-4256 <sup>1</sup>	-
V8-6.0	2006-2003		234-4669 <sup>1</sup>	234-4212 <sup>1</sup>	234-4407 <sup>1</sup>	-
V8-6.0	2002		234-4103 <sup>1</sup>	234-4209 <sup>1</sup>	234-4018 <sup>1</sup>	234-4000 <sup>1</sup>
V8-6.2	2015		234-4940 <sup>1</sup>	-	234-4974 <sup>1</sup>	-
V8-6.2	2014-2008		234-4668 <sup>1</sup>	234-4212 <sup>1</sup>	234-4256 <sup>1</sup>	-
V8-6.2	2007		234-4337 <sup>1</sup>	-	234-4112 <sup>1</sup>	234-4209 <sup>1</sup>
<b>ESCALADE ESV</b>						
V8-6.0	2006-2004		234-4669 <sup>4</sup>	234-4212 <sup>4</sup>	234-4286 <sup>4</sup>	-
V8-6.0	2006-2004		234-4669 <sup>5</sup>	234-4212 <sup>5</sup>	234-4407 <sup>5</sup>	-
V8-6.0	2003	Calif.	234-4669 <sup>4</sup>	234-4212 <sup>4</sup>	234-4286 <sup>4</sup>	-
V8-6.0	2003	Calif.	234-4669 <sup>5</sup>	234-4212 <sup>5</sup>	234-4407 <sup>5</sup>	-
V8-6.0	2003	Exc. Calif.	234-4669 <sup>1</sup>	234-4212 <sup>1</sup>	234-4407 <sup>1</sup>	-
V8-6.2	2015		234-4940 <sup>1</sup>	-	234-4974 <sup>1</sup>	-
V8-6.2	2014-2008		234-4668 <sup>1</sup>	234-4212 <sup>1</sup>	234-4256 <sup>1</sup>	-
V8-6.2	2007		234-4337 <sup>1</sup>	-	234-4112 <sup>1</sup>	234-4209 <sup>1</sup>
<b>ESCALADE EXT</b>						
V8-6.0	2006-2003		234-4669 <sup>1</sup>	234-4212 <sup>1</sup>	234-4407 <sup>1</sup>	-
V8-6.0	2002		234-4103 <sup>1</sup>	234-4209 <sup>1</sup>	234-4018 <sup>1</sup>	234-4000 <sup>1</sup>
V8-6.2	2013-2008		234-4668 <sup>1</sup>	234-4212 <sup>1</sup>	234-4256 <sup>1</sup>	-
V8-6.2	2007		234-4337 <sup>1</sup>	-	234-4112 <sup>1</sup>	234-4209 <sup>1</sup>
<b>FLEETWOOD</b>						
V6-4.1	1982	1 Lead Sensor	234-1001	234-1000	-	-
V6-4.1	1982	2 Lead Sensor	234-2001	234-2000	-	-
V6-4.1	1981-1980		234-2001	234-2000	-	-
V8-4.1	1987-1986	2 Lead Sensor	234-2001	234-2000	-	-

<sup>1</sup> 2 Required / Requis 2 / Requeridos 2 <sup>4</sup> Left Side / Côté gauche / Lado izquierdo <sup>5</sup> Right Side / Côté droit / Lado derecho



ENGINE MOTEUR MOTOR	YEAR ANNEE AÑO	APPLICATION INFORMATION INFORMATION D'APPLICATION INFORMACION DE APLICACION	UPSTREAM / AVANT - C.C. / ANTES DEL C.C.		DOWNSTREAM / APRES - C.C. / DESPUES DEL C.C.	
			TYPE / TIPO O.E.	UNIVERS.	TYPE / TIPO O.E.	UNIVERS.
<b>CADILLAC [cont]</b>						
<b>FLEETWOOD [cont]</b>						
V8-4.1	1987-1985	1 Lead Sensor	234-1001	234-1000	-	-
V8-4.1	1984-1983		234-2001	234-2000	-	-
V8-4.1	1982	1 Lead Sensor	234-1001	234-1000	-	-
V8-4.1	1982	2 Lead Sensor	234-2001	234-2000	-	-
V8-4.5	1990-1988		234-2001	234-2000	-	-
V8-4.9	1992-1991		234-2001	234-2000	-	-
V8-5.0	1986		234-1001	234-1000	-	-
V8-5.7	1996		234-4012 <sup>1</sup>	234-4000 <sup>1</sup>	234-4012 <sup>1</sup>	234-4000 <sup>1</sup>
V8-5.7	1995-1994		234-4012 <sup>1</sup>	234-4000 <sup>1</sup>	-	-
V8-5.7	1993	1 Lead Sensor	234-1001	234-1000	-	-
V8-5.7	1993	4 Lead Sensor	234-4012	234-4000	-	-
V8-6.0	1984-1983		234-2001	234-2000	-	-
V8-6.0	1982	2 Lead Sensor	234-2001	234-2000	-	-
V8-6.0	1981-1980		234-2001	234-2000	-	-
<b>SEVILLE</b>						
V6-4.1	1982	1 Lead Sensor	234-1001	234-1000	-	-
V6-4.1	1982	2 Lead Sensor	234-2001	234-2000	-	-
V6-4.1	1981		234-2001	234-2000	-	-
V8-4.1	1987-1985		234-1001	234-1000	-	-
V8-4.1	1984-1983		234-2001	234-2000	-	-
V8-4.1	1982	1 Lead Sensor	234-1001	234-1000	-	-
V8-4.1	1982	2 Lead Sensor	234-2001	234-2000	-	-
V8-4.5	1990-1988		234-2001	234-2000	-	-
V8-4.6	2004		234-4668 <sup>1</sup>	234-4212 <sup>1</sup>	234-4346	-
V8-4.6	2003-2001		234-4650 <sup>1</sup>	234-4209 <sup>1</sup>	234-4651	234-4209
V8-4.6	2000-1999		234-4018 <sup>1</sup>	234-4000 <sup>1</sup>	234-4025 <sup>1</sup>	234-4000 <sup>1</sup>
V8-4.6	1998-1996	Upstream Sensor in Exhaust Pipe	234-4025 <sup>1</sup>	234-4000 <sup>1</sup>	-	-
V8-4.6	1998-1996	Upstream Sensor in Manifold	234-4018 <sup>1</sup>	234-4000 <sup>1</sup>	234-4025 <sup>1</sup>	234-4000 <sup>1</sup>
V8-4.6	1995-1993		234-4006 <sup>1</sup>	234-4000 <sup>1</sup>	-	-
V8-4.9	1993-1991		234-2001 <sup>1</sup>	234-2000 <sup>1</sup>	-	-
V8-5.7	1980-1979		234-1025	234-1000	-	-
V8-6.0	1981-1980		234-2001	234-2000	-	-
<b>SRX</b>						
V6-2.8	2011-2010		234-4821	-	234-4821	-
V6-3.0	2011-2010		234-4815 <sup>1</sup>	-	234-4815 <sup>1</sup>	-
V6-3.6	2015-2012		234-4564 <sup>1</sup>	-	234-4564 <sup>1</sup>	-
V6-3.6	2009-2007		234-4819 <sup>1</sup>	-	234-4818 <sup>1</sup>	-
V6-3.6	2006		234-5110 <sup>1</sup>	-	234-4818 <sup>1</sup>	-
V6-3.6	2005	1st Design; Rectangular Upstream Connector	234-5002 <sup>1</sup>	-	234-4818 <sup>1</sup>	-
V6-3.6	2005	2nd Design; Oval Upstream Connector	234-5110 <sup>1</sup>	-	234-4818 <sup>1</sup>	-

<sup>1</sup> 2 Required / Requis 2 / Requeridos 2





ENGINE MOTEUR MOTOR	YEAR ANNEE AÑO	APPLICATION INFORMATION INFORMATION D'APPLICATION INFORMACION DE APLICACION	UPSTREAM / AVANT - C.C. / ANTES DEL C.C.		DOWNSTREAM / APRES - C.C. / DESPUES DEL C.C.	
			TYPE / TIPO O.E.	UNIVERS.	TYPE / TIPO O.E.	UNIVERS.
<b>CADILLAC [cont]</b>						
<b>SRX [cont]</b>						
V6-3.6	2004	1st Design; Rectangular Upstream Connector	234-5002 <sup>1</sup>	-	234-4816 <sup>1</sup>	-
V6-3.6	2004	2nd Design; Oval Upstream Connector	234-5110 <sup>1</sup>	-	234-4816 <sup>1</sup>	-
V8-4.6	2009-2007		234-4673 <sup>4</sup>	234-4212 <sup>4</sup>	234-4341 <sup>4</sup>	-
V8-4.6	2009-2007		234-4673 <sup>5</sup>	234-4212 <sup>5</sup>	234-4338 <sup>5</sup>	-
V8-4.6	2006		234-5002 <sup>1</sup>	-	234-4818 <sup>1</sup>	-
V8-4.6	2005-2004	1st Design; Rectangular Upstream Connector	234-5002 <sup>1</sup>	-	234-4818 <sup>1</sup>	-
V8-4.6	2005-2004	2nd Design; Oval Upstream Connector	234-5110 <sup>1</sup>	-	234-4818 <sup>1</sup>	-
<b>STS</b>						
V6-3.6	2011-2008		234-4819 <sup>4</sup>	-	234-4244 <sup>4</sup>	-
V6-3.6	2011-2008		234-4819 <sup>5</sup>	-	234-4818 <sup>5</sup>	-
V6-3.6	2007-2006		234-5110 <sup>1</sup>	-	234-4818 <sup>1</sup>	-
V6-3.6	2005	1st Design; Rectangular Upstream Connector	234-5002 <sup>1</sup>	-	234-4818 <sup>1</sup>	-
V6-3.6	2005	2nd Design; Oval Upstream Connector	234-5110 <sup>1</sup>	-	234-4818 <sup>1</sup>	-
V8-4.4	2009-2006		234-4334 <sup>1</sup>	-	234-4341 <sup>1</sup>	-
V8-4.6	2010-2007		234-4673 <sup>4</sup>	234-4212 <sup>4</sup>	234-4341 <sup>4</sup>	-
V8-4.6	2010-2007		234-4673 <sup>5</sup>	234-4212 <sup>5</sup>	234-4338 <sup>5</sup>	-
V8-4.6	2006		234-5002 <sup>1</sup>	-	234-4818 <sup>1</sup>	-
V8-4.6	2005	1st Design; Rectangular Upstream Connector	234-5002 <sup>1</sup>	-	234-4818 <sup>1</sup>	-
V8-4.6	2005	2nd Design; Oval Upstream Connector	234-5110 <sup>1</sup>	-	234-4818 <sup>1</sup>	-
<b>XLR</b>						
V8-4.4	2009-2006		234-4335 <sup>1</sup>	-	234-4338 <sup>1</sup>	-
V8-4.6	2009-2007		234-4335 <sup>1</sup>	-	234-4338 <sup>1</sup>	-
V8-4.6	2006		234-5001 <sup>1</sup>	-	234-4817 <sup>1</sup>	-
V8-4.6	2005-2004	w/ 21" Downstream Sensor	234-5003 <sup>1</sup>	-	234-4816 <sup>1</sup>	-
V8-4.6	2005	w/ 32" Downstream Sensor	234-5001 <sup>1</sup>	-	234-4817 <sup>1</sup>	-
<b>XTS</b>						
V6-3.6	2015		234-4566 <sup>1</sup>	-	234-4566 <sup>1</sup>	-
V6-3.6	2014	Exc. Livery Model	234-4566 <sup>1</sup>	-	234-4566 <sup>1</sup>	-
V6-3.6	2013		234-4566 <sup>1</sup>	-	234-4566 <sup>1</sup>	-
<b>CHEVROLET</b>						
<b>ASTRO</b>						
L4-2.5	1990-1985		234-1001	234-1000	-	-
V6-4.3	2005-2003		234-4344 <sup>4</sup>	-	234-4345	-
V6-4.3	2005-2003		234-4345 <sup>5</sup>	-	-	-
V6-4.3	2002-2000		234-4647 <sup>4</sup>	234-4209 <sup>4</sup>	234-4650	234-4209
V6-4.3	2002-2000		234-4650 <sup>5</sup>	234-4209 <sup>5</sup>	-	-
V6-4.3	1999-1998		234-4646 <sup>1</sup>	234-4209 <sup>1</sup>	234-4646	234-4209
V6-4.3	1997-1996	Upstream Sensor in Exhaust Pipe	234-4018 <sup>17</sup>	234-4000 <sup>17</sup>	-	-

<sup>1</sup> 2 Required / Requis 2 / Requeridos 2 <sup>4</sup> Left Side / Côté gauche / Lado izquierdo <sup>5</sup> Right Side / Côté droit / Lado derecho <sup>17</sup> Location Exhaust Pipe / Empl. tuyau d'éch / Ubicación tubo de escape



ENGINE MOTEUR MOTOR	YEAR ANNEE AÑO	APPLICATION INFORMATION INFORMATION D'APPLICATION INFORMACION DE APLICACION	UPSTREAM / AVANT - C.C. / ANTES DEL C.C.		DOWNSTREAM / APRES - C.C. / DESPUES DEL C.C.		
			TYPE / TIPO O.E.	UNIVERS.	TYPE / TIPO O.E.	UNIVERS.	
<b>CHEVROLET [cont]</b>							
<b>ASTRO [cont]</b>							
V6-4.3	1997-1996	Upstream Sensor in Manifold	234-4012 <sup>1</sup>	234-4000 <sup>1</sup>	234-4018	234-4000	
V6-4.3	1995		234-3011	234-3000	-	-	
V6-4.3	1994		234-3005	234-3000	-	-	
V6-4.3	1993-1992		234-3094	234-3090	-	-	
V6-4.3	1991-1985		234-1001	234-1000	-	-	
<b>AVALANCHE</b>							
V8-5.3	2013-2008		234-4668 <sup>1</sup>	234-4212 <sup>1</sup>	234-4256 <sup>1</sup>	-	
V8-5.3	2007		234-4337 <sup>1</sup>	-	234-4112 <sup>1</sup>	234-4209 <sup>1</sup>	
V8-6.0	2009-2008		234-4668 <sup>1</sup>	234-4212 <sup>1</sup>	234-4256 <sup>1</sup>	-	
V8-6.0	2007		234-4337 <sup>1</sup>	-	234-4112 <sup>1</sup>	234-4209 <sup>1</sup>	
<b>AVALANCHE 1500</b>							
V8-5.3	2006		234-4337 <sup>1</sup>	-	234-4336 <sup>1</sup>	-	
V8-5.3	2005-2003		234-4668 <sup>1</sup>	234-4212 <sup>1</sup>	234-4668 <sup>1</sup>	234-4212 <sup>1</sup>	
V8-5.3	2002		Canada Built	234-4650 <sup>1</sup>	234-4209 <sup>1</sup>	234-4650 <sup>1</sup>	234-4209 <sup>1</sup>
V8-5.3	2002		Exc. Canada Built	234-4012 <sup>1</sup>	234-4000 <sup>1</sup>	234-4018 <sup>1</sup>	234-4000 <sup>1</sup>
<b>AVALANCHE 2500</b>							
V8-8.1	2006-2003		234-4669 <sup>4</sup>	234-4212 <sup>4</sup>	234-4673 <sup>4</sup>	234-4212 <sup>4</sup>	
V8-8.1	2006-2003		234-4669 <sup>5</sup>	234-4212 <sup>5</sup>	234-4669 <sup>5</sup>	234-4212 <sup>5</sup>	
V8-8.1	2002		234-4103 <sup>4</sup>	234-4209 <sup>4</sup>	234-4102 <sup>4</sup>	234-4209 <sup>4</sup>	
V8-8.1	2002		234-4103 <sup>5</sup>	234-4209 <sup>5</sup>	234-4103 <sup>5</sup>	234-4209 <sup>5</sup>	
<b>AVEO</b>							
L4-1.6	2011-2009		234-4290	-	234-4298	-	
L4-1.6	2008-2006		234-4293	-	234-4288	-	
L4-1.6	2005-2004		234-4284	-	234-4284	-	
<b>AVEOS</b>							
L4-1.6	2011-2009		234-4290	-	234-4298	-	
L4-1.6	2008-2006		234-4293	-	234-4288	-	
<b>BEL AIR</b>							
V8-4.4	1981	1 Lead Sensor	234-1001	234-1000	-	-	
V8-4.4	1981	2 Lead Sensor	234-2001	234-2000	-	-	
V8-5.0	1981	1 Lead Sensor	234-1001	234-1000	-	-	
V8-5.0	1981	2 Lead Sensor	234-2001	234-2000	-	-	
<b>BERETTA</b>							
L4-2.0	1989-1987		234-1001	234-1000	-	-	
L4-2.2	1996		234-1001	234-1000	234-4615	234-4000	
L4-2.2	1995-1990		234-1001	234-1000	-	-	
L4-2.3	1994-1990		234-1001	234-1000	-	-	
V6-2.8	1989-1987		234-1001	234-1000	-	-	
V6-3.1	1996		234-4012	234-4000	234-4615	234-4000	
V6-3.1	1995-1994		234-4012	234-4000	-	-	

<sup>1</sup> 2 Required / Requis 2 / Requeridos 2 <sup>4</sup> Left Side / Côté gauche / Lado izquierdo <sup>5</sup> Right Side / Côté droit / Lado derecho



ENGINE MOTEUR MOTOR	YEAR ANNEE AÑO	APPLICATION INFORMATION INFORMATION D'APPLICATION INFORMACION DE APLICACION	UPSTREAM / AVANT - C.C. / ANTES DEL C.C.		DOWNSTREAM / APRS - C.C. / DESPUES DEL C.C.	
			TYPE / TIPO O.E.	UNIVERS.	TYPE / TIPO O.E.	UNIVERS.
<b>CHEVROLET [cont]</b>						
<b>BERETTA [cont]</b>						
V6-3.1	1993-1990		234-1001	234-1000	-	-
<b>BLAZER</b>						
V6-4.3	2005-2003		234-4343 <sup>1</sup>	-	234-4343	-
V6-4.3	2002		234-4650 <sup>1</sup>	234-4209 <sup>1</sup>	234-4650	234-4209
V6-4.3	2001-1998		234-4012 <sup>1</sup>	234-4000 <sup>1</sup>	234-4012	234-4000
V6-4.3	1997-1996	Upstream Sensor in Manifold	234-4012 <sup>1</sup>	234-4000 <sup>1</sup>	234-4012	234-4000
V6-4.3	1997-1996	Upstream Sensor in Y Pipe	234-4012	234-4000	-	-
V6-4.3	1995	3 Lead Sensor	234-3005	234-3000	-	-
V6-4.3	1995	4 Lead Sensor	234-4012	234-4000	-	-
V8-5.0	1987-1983		234-1001	234-1000	-	-
V8-5.7	1994-1983	1 Lead Sensor	234-1001	234-1000	-	-
V8-5.7	1994	3 Lead Sensor	234-3005	234-3000	-	-
V8-5.7	1993-1992	3 Lead Sensor	234-3094	234-3090	-	-
<b>C10 SUBURBAN</b>						
V8-5.0	1986-1983		234-1001	234-1000	-	-
V8-5.7	1986-1983		234-1001	234-1000	-	-
<b>C10 TRUCK</b>						
L6-4.1	1984-1983		234-1001	234-1000	-	-
V6-4.3	1986-1985		234-1001	234-1000	-	-
V8-5.0	1986-1983		234-1001	234-1000	-	-
V8-5.7	1986-1983		234-1001	234-1000	-	-
<b>C20 SUBURBAN</b>						
V8-5.0	1986-1983		234-1001	234-1000	-	-
V8-5.7	1986-1983		234-1001	234-1000	-	-
V8-7.4	1986-1983		234-1001	234-1000	-	-
<b>C20 TRUCK</b>						
L6-4.1	1984-1983		234-1001	234-1000	-	-
L6-4.8	1986-1983		234-1001	234-1000	-	-
V6-4.3	1986-1985		234-1001	234-1000	-	-
V8-5.0	1986-1983		234-1001	234-1000	-	-
V8-5.7	1986-1983		234-1001	234-1000	-	-
V8-7.4	1986-1983		234-1001	234-1000	-	-
<b>C30 TRUCK</b>						
L6-4.8	1986-1983		234-1001	234-1000	-	-
V8-5.0	1986		234-1001	234-1000	-	-
V8-5.7	1986-1983		234-1001	234-1000	-	-
V8-7.4	1986-1983		234-1001	234-1000	-	-
<b>C1500 SUBURBAN</b>						
V8-5.7	1999-1996	Trans Code 4L60E	234-4012 <sup>1</sup>	234-4000 <sup>1</sup>	234-4018 <sup>1</sup>	234-4000 <sup>1</sup>
V8-5.7	1999-1996	Trans Code 4L80E	234-4019 <sup>1</sup>	234-4000 <sup>1</sup>	234-4018 <sup>1</sup>	234-4000 <sup>1</sup>
V8-5.7	1995-1992	1 Lead Sensor	234-1001	234-1000	-	-

<sup>1</sup> 2 Required / Requis 2 / Requeridos 2



ENGINE MOTEUR MOTOR	YEAR ANNEE AÑO	APPLICATION INFORMATION INFORMATION D'APPLICATION INFORMACION DE APLICACION	UPSTREAM / AVANT - C.C. / ANTES DEL C.C.		DOWNSTREAM / APRS - C.C. / DESPUES DEL C.C.	
			TYPE / TIPO O.E.	UNIVERS.	TYPE / TIPO O.E.	UNIVERS.
<b>CHEVROLET [cont]</b>						
<b>C1500 SUBURBAN [cont]</b>						
V8-5.7	1995	3 Lead Sensor	234-3011	234-3000	-	-
V8-5.7	1994	3 Lead Sensor	234-3005	234-3000	-	-
V8-5.7	1993-1992	3 Lead Sensor	234-3094	234-3090	-	-
<b>C1500 TRUCK</b>						
V6-4.3	1998		234-4012 <sup>1</sup>	234-4000 <sup>1</sup>	234-4018	234-4000
V6-4.3	1997-1996	Upstream Sensor in Manifold	234-4012 <sup>1</sup>	234-4000 <sup>1</sup>	234-4018	234-4000
V6-4.3	1997-1996	Upstream Sensor in Y Pipe	234-4018	234-4000	-	-
V6-4.3	1995		234-3011 <sup>1</sup>	234-3000 <sup>1</sup>	-	-
V6-4.3	1994		234-3005	234-3000	-	-
V6-4.3	1993-1992	3 Lead Sensor	234-3094	234-3090	-	-
V6-4.3	1993-1988	1 Lead Sensor	234-1001	234-1000	-	-
V8-5.0	1999		234-4012 <sup>1</sup>	234-4000 <sup>1</sup>	234-4018	234-4000
V8-5.0	1998	Auto Trans	234-4012 <sup>1</sup>	234-4000 <sup>1</sup>	234-4018	234-4000
V8-5.0	1998	Manual Trans	234-4019 <sup>1</sup>	234-4000 <sup>1</sup>	234-4018	234-4000
V8-5.0	1997-1996	Auto Trans; Upstream Sensor in Manifold	234-4012 <sup>1</sup>	234-4000 <sup>1</sup>	234-4018	234-4000
V8-5.0	1997-1996	Auto Trans; Upstream Sensor in Y Pipe	234-4018	234-4000	-	-
V8-5.0	1997-1996	Manual Trans; Upstream Sensor in Manifold	234-4019 <sup>1</sup>	234-4000 <sup>1</sup>	234-4018	234-4000
V8-5.0	1997-1996	Manual Trans; Upstream Sensor in Y Pipe	234-4018	234-4000	-	-
V8-5.0	1995-1988	1 Lead Sensor	234-1001	234-1000	-	-
V8-5.0	1995	3 Lead Sensor	234-3011	234-3000	-	-
V8-5.0	1994	3 Lead Sensor	234-3005	234-3000	-	-
V8-5.0	1993-1992	3 Lead Sensor	234-3094	234-3090	-	-
V8-5.7	1999	Trans Code 4L60E	234-4012 <sup>1</sup>	234-4000 <sup>1</sup>	234-4018 <sup>1</sup>	234-4000 <sup>1</sup>
V8-5.7	1999	Trans Code 4L80E	234-4019 <sup>1</sup>	234-4000 <sup>1</sup>	234-4018 <sup>1</sup>	234-4000 <sup>1</sup>
V8-5.7	1998-1996	Manual Trans	234-4019 <sup>1</sup>	234-4000 <sup>1</sup>	234-4018 <sup>1</sup>	234-4000 <sup>1</sup>
V8-5.7	1998	Auto Trans; Trans Code 4L60E	234-4019 <sup>1</sup>	234-4000 <sup>1</sup>	234-4018 <sup>1</sup>	234-4000 <sup>1</sup>
V8-5.7	1998	Auto Trans; Trans Code 4L80E	234-4012 <sup>1</sup>	234-4000 <sup>1</sup>	234-4018 <sup>1</sup>	234-4000 <sup>1</sup>
V8-5.7	1997-1996	Auto Trans; Trans Code 4L60E	234-4012 <sup>1</sup>	234-4000 <sup>1</sup>	234-4018 <sup>1</sup>	234-4000 <sup>1</sup>
V8-5.7	1997-1996	Auto Trans; Trans Code 4L80E	234-4019 <sup>1</sup>	234-4000 <sup>1</sup>	234-4018 <sup>1</sup>	234-4000 <sup>1</sup>
V8-5.7	1995-1988	1 Lead Sensor	234-1001	234-1000	-	-
V8-5.7	1995	3 Lead Sensor	234-3011	234-3000	-	-
V8-5.7	1994	3 Lead Sensor	234-3005	234-3000	-	-
V8-5.7	1993-1992	3 Lead Sensor	234-3094	234-3090	-	-
V8-7.4	1993-1990		234-1001	234-1000	-	-
<b>C2500 SUBURBAN</b>						
V8-5.7	1999-1997		234-4019 <sup>1</sup>	234-4000 <sup>1</sup>	234-4018 <sup>1</sup>	234-4000 <sup>1</sup>
V8-5.7	1996	Trans Code 4L60E	234-4012 <sup>1</sup>	234-4000 <sup>1</sup>	234-4018 <sup>1</sup>	234-4000 <sup>1</sup>
V8-5.7	1996	Trans Code 4L80E	234-4019 <sup>1</sup>	234-4000 <sup>1</sup>	234-4018 <sup>1</sup>	234-4000 <sup>1</sup>
V8-5.7	1995-1992	1 Lead Sensor	234-1001	234-1000	-	-
V8-5.7	1995	3 Lead Sensor	234-3011	234-3000	-	-

<sup>1</sup> 2 Required / Requis 2 / Requeridos 2



ENGINE MOTEUR MOTOR	YEAR ANNEE AÑO	APPLICATION INFORMATION INFORMATION D'APPLICATION INFORMACION DE APLICACION	UPSTREAM / AVANT - C.C. / ANTES DEL C.C.		DOWNSTREAM / APRS - C.C. / DESPUES DEL C.C.	
			TYPE / TIPO O.E.	UNIVERS.	TYPE / TIPO O.E.	UNIVERS.
<b>CHEVROLET [cont]</b>						
<b>C2500 SUBURBAN [cont]</b>						
V8-5.7	1994	3 Lead Sensor	234-3005	234-3000	-	-
V8-5.7	1993-1992	3 Lead Sensor	234-3094	234-3090	-	-
V8-7.4	1999-1996		234-4019 <sup>1</sup>	234-4000 <sup>1</sup>	234-4018 <sup>1</sup>	234-4000 <sup>1</sup>
V8-7.4	1995-1992		234-1001	234-1000	-	-
<b>C2500 TRUCK</b>						
V6-4.3	1995		234-3011 <sup>1</sup>	234-3000 <sup>1</sup>	-	-
V6-4.3	1994		234-3005	234-3000	-	-
V6-4.3	1993-1992	3 Lead Sensor	234-3094	234-3090	-	-
V6-4.3	1993-1988	1 Lead Sensor	234-1001	234-1000	-	-
V8-5.0	1998	Auto Trans	234-4012 <sup>1</sup>	234-4000 <sup>1</sup>	234-4018	234-4000
V8-5.0	1998	Manual Trans	234-4019 <sup>1</sup>	234-4000 <sup>1</sup>	234-4018	234-4000
V8-5.0	1997-1996	Auto Trans; Upstream Sensor in Manifold	234-4012 <sup>1</sup>	234-4000 <sup>1</sup>	234-4018	234-4000
V8-5.0	1997-1996	Auto Trans; Upstream Sensor in Y Pipe	234-4018	234-4000	-	-
V8-5.0	1997-1996	Manual Trans; Upstream Sensor in Manifold	234-4019 <sup>1</sup>	234-4000 <sup>1</sup>	234-4018	234-4000
V8-5.0	1997-1996	Manual Trans; Upstream Sensor in Y Pipe	234-4018	234-4000	-	-
V8-5.0	1995-1988	1 Lead Sensor	234-1001	234-1000	-	-
V8-5.0	1995	3 Lead Sensor	234-3011	234-3000	-	-
V8-5.0	1994	3 Lead Sensor	234-3005	234-3000	-	-
V8-5.0	1993-1992	3 Lead Sensor	234-3094	234-3090	-	-
V8-5.7	2000-1999		234-4019 <sup>1</sup>	234-4000 <sup>1</sup>	234-4018 <sup>1</sup>	234-4000 <sup>1</sup>
V8-5.7	1998-1996	Auto Trans; Trans Code 4L60E	234-4012 <sup>1</sup>	234-4000 <sup>1</sup>	234-4018 <sup>1</sup>	234-4000 <sup>1</sup>
V8-5.7	1998-1996	Auto Trans; Trans Code 4L80E	234-4019 <sup>1</sup>	234-4000 <sup>1</sup>	234-4018 <sup>1</sup>	234-4000 <sup>1</sup>
V8-5.7	1998-1996	Manual Trans	234-4019 <sup>1</sup>	234-4000 <sup>1</sup>	234-4018 <sup>1</sup>	234-4000 <sup>1</sup>
V8-5.7	1995-1988	1 Lead Sensor	234-1001	234-1000	-	-
V8-5.7	1995	3 Lead Sensor	234-3011	234-3000	-	-
V8-5.7	1994	3 Lead Sensor	234-3005	234-3000	-	-
V8-5.7	1993-1992	3 Lead Sensor	234-3094	234-3090	-	-
V8-7.4	2000	Calif.	234-4103 <sup>1</sup>	234-4209 <sup>1</sup>	234-4103 <sup>1</sup>	234-4209 <sup>1</sup>
V8-7.4	2000	Exc. Calif.	234-4103 <sup>1</sup>	234-4209 <sup>1</sup>	234-4018 <sup>1</sup>	234-4000 <sup>1</sup>
V8-7.4	1999-1996		234-4019 <sup>1</sup>	234-4000 <sup>1</sup>	234-4018 <sup>1</sup>	234-4000 <sup>1</sup>
V8-7.4	1995-1991		234-1001	234-1000	-	-
<b>C3500 TRUCK</b>						
V8-5.7	2000-1996		234-4019 <sup>1</sup>	234-4000 <sup>1</sup>	234-4018 <sup>1</sup>	234-4000 <sup>1</sup>
V8-5.7	1995-1988	1 Lead Sensor	234-1001	234-1000	-	-
V8-5.7	1995	3 Lead Sensor	234-3011	234-3000	-	-
V8-5.7	1994	3 Lead Sensor	234-3005	234-3000	-	-
V8-5.7	1993-1992	3 Lead Sensor	234-3094	234-3090	-	-
V8-7.4	2000	Calif.	234-4103 <sup>1</sup>	234-4209 <sup>1</sup>	234-4103 <sup>1</sup>	234-4209 <sup>1</sup>
V8-7.4	2000	Exc. Calif.	234-4103 <sup>1</sup>	234-4209 <sup>1</sup>	234-4018 <sup>1</sup>	234-4000 <sup>1</sup>
V8-7.4	1999-1996		234-4019 <sup>1</sup>	234-4000 <sup>1</sup>	234-4018 <sup>1</sup>	234-4000 <sup>1</sup>

<sup>1</sup> 2 Required / Requis 2 / Requeridos 2



ENGINE MOTEUR MOTOR	YEAR ANNEE AÑO	APPLICATION INFORMATION INFORMATION D'APPLICATION INFORMACION DE APLICACION	UPSTREAM / AVANT - C.C. / ANTES DEL C.C.		DOWNSTREAM / APRES - C.C. / DESPUES DEL C.C.	
			TYPE / TIPO O.E.	UNIVERS.	TYPE / TIPO O.E.	UNIVERS.
<b>CHEVROLET [cont]</b>						
<b>C3500 TRUCK [cont]</b>						
V8-7.4	1995-1988		234-1001	234-1000	-	-
<b>CAMARO</b>						
L4-2.5	1986-1982		234-1001	234-1000	-	-
V6-2.8	1989-1982		234-1001	234-1000	-	-
V6-3.1	1992-1990		234-1001	234-1000	-	-
V6-3.4	1995-1993		234-1001 <sup>1</sup>	234-1000 <sup>1</sup>	-	-
V6-3.6	2015-2013		234-4441 <sup>5</sup>	-	234-4566 <sup>5</sup>	-
V6-3.6	2015-2013	Auto Trans	234-4441 <sup>4</sup>	-	234-4244 <sup>4</sup>	-
V6-3.6	2015-2013	Manual Trans	234-4441 <sup>4</sup>	-	234-4566 <sup>4</sup>	-
V6-3.6	2012		234-4441 <sup>4</sup>	-	234-4244 <sup>4</sup>	-
V6-3.6	2012		234-4441 <sup>5</sup>	-	234-4565 <sup>5</sup>	-
V6-3.6	2011-2010	Auto Trans	234-4441 <sup>4</sup>	-	234-4244 <sup>4</sup>	-
V6-3.6	2011-2010	Auto Trans	234-4441 <sup>5</sup>	-	234-4818 <sup>5</sup>	-
V6-3.6	2011-2010	Manual Trans	234-4441 <sup>1</sup>	-	234-4818 <sup>1</sup>	-
V6-3.8	2002-2001	Upstream Sensor in Manifold	234-4018 <sup>1</sup>	234-4000 <sup>1</sup>	234-4087	234-4000
V6-3.8	2002-1996	Upstream Sensor in Exhaust Pipe	234-4087 <sup>17</sup>	234-4000 <sup>17</sup>	-	-
V6-3.8	2000-1998	2 Lead Upstream Sensor in Manifold	234-2013 <sup>1</sup>	234-2000 <sup>1</sup>	234-4087	234-4000
V6-3.8	2000-1998	4 Lead Upstream Sensor in Manifold	234-4018 <sup>1</sup>	234-4000 <sup>1</sup>	234-4087	234-4000
V6-3.8	1997	Upstream Sensor in Manifold	234-4018 <sup>1</sup>	234-4000 <sup>1</sup>	234-4087	234-4000
V6-3.8	1996	Upstream Sensor in Manifold	234-4012 <sup>1</sup>	234-4000 <sup>1</sup>	234-4087	234-4000
V6-3.8	1995		234-4012 <sup>1</sup>	234-4000 <sup>1</sup>	234-4012 <sup>1</sup>	234-4000 <sup>1</sup>
V6-3.8	1981-1980	1 Lead Sensor	234-1001	234-1000	-	-
V6-3.8	1981-1980	2 Lead Sensor	234-2001	234-2000	-	-
V8-4.4	1981-1980	1 Lead Sensor	234-1001	234-1000	-	-
V8-4.4	1981-1980	2 Lead Sensor	234-2001	234-2000	-	-
V8-5.0	1992-1980	1 Lead Sensor	234-1001	234-1000	-	-
V8-5.0	1981-1980	2 Lead Sensor	234-2001	234-2000	-	-
V8-5.7	2002-2000		234-4087 <sup>5</sup>	234-4000 <sup>5</sup>	234-4025 <sup>5</sup>	234-4000 <sup>5</sup>
V8-5.7	2002-1998		234-4025 <sup>4</sup>	234-4000 <sup>4</sup>	234-4025 <sup>4</sup>	234-4000 <sup>4</sup>
V8-5.7	1999-1998		234-4087 <sup>5</sup>	234-4000 <sup>5</sup>	234-4087 <sup>5</sup>	234-4000 <sup>5</sup>
V8-5.7	1997-1996	Upstream Sensor in Exhaust Pipe	234-4087 <sup>17</sup>	234-4000 <sup>17</sup>	-	-
V8-5.7	1997-1996	Upstream Sensor in Manifold	234-4012 <sup>1</sup>	234-4000 <sup>1</sup>	234-4087	234-4000
V8-5.7	1995-1994		234-4012 <sup>1</sup>	234-4000 <sup>1</sup>	-	-
V8-5.7	1993		234-1001 <sup>1</sup>	234-1000 <sup>1</sup>	-	-
V8-5.7	1992-1987		234-1001	234-1000	-	-
V8-5.7	1981-1980	1 Lead Sensor	234-1001	234-1000	-	-
V8-5.7	1981-1980	2 Lead Sensor	234-2001	234-2000	-	-
V8-6.2	2015-2010		234-4669 <sup>1</sup>	234-4212 <sup>1</sup>	234-4256 <sup>1</sup>	-
V8-7.0	2015-2014		234-4669 <sup>1</sup>	234-4212 <sup>1</sup>	234-4256 <sup>1</sup>	-

<sup>1</sup> 2 Required / Requis 2 / Requeridos 2 <sup>4</sup> Left Side / Côté gauche / Lado izquierdo <sup>5</sup> Right Side / Côté droit / Lado derecho <sup>17</sup> Location Exhaust Pipe / Empl. tuyau d'éch / Ubicación tubo de escape



ENGINE MOTEUR MOTOR	YEAR ANNEE AÑO	APPLICATION INFORMATION INFORMATION D'APPLICATION INFORMACION DE APLICACION	UPSTREAM / AVANT - C.C. / ANTES DEL C.C.		DOWNSTREAM / APRS - C.C. / DESPUES DEL C.C.	
			TYPE / TIPO O.E.	UNIVERS.	TYPE / TIPO O.E.	UNIVERS.
<b>CHEVROLET [cont]</b>						
<b>CAPRICE</b>						
V6-3.6	2015-2012		234-4565 <sup>1</sup>	-	234-4565 <sup>1</sup>	-
V6-3.8	1985-1980	1 Lead Sensor	234-1001	234-1000	-	-
V6-3.8	1981-1980	2 Lead Sensor	234-2001	234-2000	-	-
V6-4.3	1993-1992		234-3094	234-3090	-	-
V6-4.3	1990-1986		234-1001	234-1000	-	-
V6-4.3	1985		234-3074	234-3090	-	-
V8-4.3	1996		234-4012 <sup>1</sup>	234-4000 <sup>1</sup>	234-4012 <sup>1</sup>	234-4000 <sup>1</sup>
V8-4.3	1995-1994		234-4012 <sup>1</sup>	234-4000 <sup>1</sup>	-	-
V8-4.4	1982-1980	1 Lead Sensor	234-1001	234-1000	-	-
V8-4.4	1981-1980	2 Lead Sensor	234-2001	234-2000	-	-
V8-5.0	1993-1980	1 Lead Sensor	234-1001	234-1000	-	-
V8-5.0	1981-1980	2 Lead Sensor	234-2001	234-2000	-	-
V8-5.7	1996		234-4012 <sup>1</sup>	234-4000 <sup>1</sup>	234-4012 <sup>1</sup>	234-4000 <sup>1</sup>
V8-5.7	1995-1994		234-4012 <sup>1</sup>	234-4000 <sup>1</sup>	-	-
V8-5.7	1993-1985		234-1001	234-1000	-	-
V8-5.7	1980	1 Lead Sensor	234-1001	234-1000	-	-
V8-5.7	1980	2 Lead Sensor	234-2001	234-2000	-	-
V8-6.0	2015		234-4669 <sup>1</sup>	234-4212 <sup>1</sup>	234-4256 <sup>1</sup>	-
V8-6.0	2014		234-4669 <sup>1</sup>	234-4212 <sup>1</sup>	234-4253 <sup>1</sup>	-
V8-6.0	2013-2011		234-4668 <sup>1</sup>	234-4212 <sup>1</sup>	234-4253 <sup>1</sup>	-
<b>CAPTIVA SPORT</b>						
L4-2.4	2015-2012		234-4242	-	234-4530	-
V6-3.0	2012		234-4564 <sup>1</sup>	-	234-4564 <sup>1</sup>	-
<b>CAVALIER</b>						
L4-1.8	1982		234-1001	234-1000	-	-
L4-2.0	1989-1983		234-1001	234-1000	-	-
L4-2.2	2005-2002		234-4646	234-4209	234-4108	234-4209
L4-2.2	2001-2000		234-2060	234-2000	234-4089	234-4000
L4-2.2	1999		234-1023	234-1000	234-4089	234-4000
L4-2.2	1998-1996		234-1001	234-1000	234-4616	234-4000
L4-2.2	1995-1990		234-1001	234-1000	-	-
L4-2.3	1995	Auto Trans	234-1001	234-1000	234-4616	234-4000
L4-2.3	1995	Manual Trans	234-1001	234-1000	-	-
L4-2.4	2002-2000		234-2060	234-2000	234-4616	234-4000
L4-2.4	1999		234-1023	234-1000	234-4616	234-4000
L4-2.4	1998-1996		234-1001	234-1000	234-4616	234-4000
V6-2.8	1989-1985		234-1001	234-1000	-	-
V6-3.1	1994-1990		234-1001	234-1000	-	-
<b>CELEBRITY</b>						
L4-2.5	1990-1982		234-1001	234-1000	-	-

<sup>1</sup> 2 Required / Requis 2 / Requeridos 2



ENGINE MOTEUR MOTOR	YEAR ANNEE AÑO	APPLICATION INFORMATION INFORMATION D'APPLICATION INFORMACION DE APLICACION	UPSTREAM / AVANT - C.C. / ANTES DEL C.C.		DOWNSTREAM / APRS - C.C. / DESPUES DEL C.C.	
			TYPE / TIPO O.E.	UNIVERS.	TYPE / TIPO O.E.	UNIVERS.
<b>CHEVROLET [cont]</b>						
<b>CELEBRITY [cont]</b>						
V6-2.8	1989-1982		234-1001	234-1000	-	-
V6-3.1	1990		234-1001	234-1000	-	-
<b>CHEVETTE</b>						
L4-1.6	1987-1980	1 Lead Sensor	234-1001	234-1000	-	-
L4-1.6	1981-1980	2 Lead Sensor	234-2001	234-2000	-	-
<b>CITATION</b>						
L4-2.5	1983-1980	1 Lead Sensor	234-1001	234-1000	-	-
L4-2.5	1981-1980	2 Lead Sensor	234-2001	234-2000	-	-
V6-2.8	1983-1980	1 Lead Sensor	234-1001	234-1000	-	-
V6-2.8	1981-1980	2 Lead Sensor	234-2001	234-2000	-	-
<b>CITATION II</b>						
L4-2.5	1985-1984		234-1001	234-1000	-	-
V6-2.8	1985-1984		234-1001	234-1000	-	-
<b>CLASSIC</b>						
L4-2.2	2005-2004		234-4646	234-4209	234-4104	234-4209
<b>COBALT</b>						
L4-2.0	2010-2008		234-5007	-	234-4245	-
L4-2.0	2007-2005		234-4646	234-4209	234-4066	234-4209
L4-2.2	2010-2007		234-4668	234-4212	234-4066	234-4209
L4-2.2	2006-2005		234-4342	-	234-4066	234-4209
L4-2.4	2008-2006		234-4342	-	234-4066	234-4209
<b>COLORADO</b>						
L4-2.8	2006		234-4331	-	234-4348	-
L4-2.8	2005-2004		234-4119	-	234-4285	-
L4-2.9	2012-2007		234-4331	-	234-4294	-
L5-3.5	2006		234-4331	-	234-4348	-
L5-3.5	2005-2004		234-4119	-	234-4285	-
L5-3.7	2012-2007		234-4331	-	234-4294	-
V8-5.3	2012-2009		234-4337 <sup>1</sup>	-	234-4243 <sup>1</sup>	-
<b>CORSICA</b>						
L4-2.0	1989-1987		234-1001	234-1000	-	-
L4-2.2	1996		234-1001	234-1000	234-4615	234-4000
L4-2.2	1995-1990		234-1001	234-1000	-	-
V6-2.8	1989-1987		234-1001	234-1000	-	-
V6-3.1	1996		234-4012	234-4000	234-4615	234-4000
V6-3.1	1995-1994		234-4012	234-4000	-	-
V6-3.1	1993-1990		234-1001	234-1000	-	-
<b>CORVETTE</b>						
V8-5.0	1980		234-2001	234-2000	-	-
V8-5.7	2004		234-4668 <sup>1</sup>	234-4212 <sup>1</sup>	234-4104 <sup>1</sup>	234-4209 <sup>1</sup>
V8-5.7	2003-1997		234-4012 <sup>1</sup>	234-4000 <sup>1</sup>	234-4617 <sup>1</sup>	234-4000 <sup>1</sup>

<sup>1</sup> 2 Required / Requis 2 / Requeridos 2





ENGINE MOTEUR MOTOR	YEAR ANNEE AÑO	APPLICATION INFORMATION INFORMATION D'APPLICATION INFORMACION DE APLICACION	UPSTREAM / AVANT - C.C. / ANTES DEL C.C.		DOWNSTREAM / APRS - C.C. / DESPUES DEL C.C.	
			TYPE / TIPO O.E.	UNIVERS.	TYPE / TIPO O.E.	UNIVERS.
<b>CHEVROLET [cont]</b>						
<b>CORVETTE [cont]</b>						
V8-5.7	1996		234-4012 <sup>1</sup>	234-4000 <sup>1</sup>	234-4012 <sup>1</sup>	234-4000 <sup>1</sup>
V8-5.7	1995-1994	Exc. ZR-1	234-4012 <sup>1</sup>	234-4000 <sup>1</sup>	-	-
V8-5.7	1995-1993	ZR-1	234-3005 <sup>1</sup>	234-3000 <sup>1</sup>	-	-
V8-5.7	1993-1990	Exc. ZR-1	234-1001 <sup>1</sup>	234-1000 <sup>1</sup>	-	-
V8-5.7	1992-1990	ZR-1; w/ 14" Sensor	234-3094 <sup>1</sup>	234-3090 <sup>1</sup>	-	-
V8-5.7	1992	ZR-1; w/ 9" Sensor	234-3005 <sup>1</sup>	234-3000 <sup>1</sup>	-	-
V8-5.7	1989-1984		234-1001	234-1000	-	-
V8-5.7	1982		234-1001	234-1000	-	-
V8-5.7	1981-1980		234-2001	234-2000	-	-
V8-6.0	2007-2005		234-4332 <sup>1</sup>	-	234-4647 <sup>1</sup>	234-4209 <sup>1</sup>
V8-6.2	2015-2014		234-4763 <sup>1</sup>	-	234-4974 <sup>1</sup>	-
V8-6.2	2013-2009	Non-Supercharged	234-4332 <sup>1</sup>	-	234-4256 <sup>1</sup>	-
V8-6.2	2013-2009	Supercharged	234-4669 <sup>1</sup>	234-4212 <sup>1</sup>	234-4256 <sup>1</sup>	-
V8-6.2	2008		234-4332 <sup>1</sup>	-	234-4256 <sup>1</sup>	-
V8-7.0	2013-2010		234-4669 <sup>1</sup>	234-4212 <sup>1</sup>	234-4256 <sup>1</sup>	-
V8-7.0	2009-2008		234-4332 <sup>1</sup>	-	234-4256 <sup>1</sup>	-
V8-7.0	2007-2006		234-4332 <sup>1</sup>	-	234-4647 <sup>1</sup>	234-4209 <sup>1</sup>
<b>CRUZE</b>						
L4-1.4	2015-2011		234-4529	-	234-4528	-
L4-1.8	2015-2011		234-4527	-	234-4528	-
L4-2.0	2015		234-5169	-	234-5169	-
<b>EL CAMINO</b>						
V6-3.8	1984-1980	1 Lead Sensor	234-1001	234-1000	-	-
V6-3.8	1981-1979	2 Lead Sensor	234-2001	234-2000	-	-
V6-4.3	1987-1986		234-1001	234-1000	-	-
V6-4.3	1985		234-3074	234-3090	-	-
V8-4.4	1982-1980	1 Lead Sensor	234-1001	234-1000	-	-
V8-4.4	1981-1980	2 Lead Sensor	234-2001	234-2000	-	-
V8-5.0	1987-1980	1 Lead Sensor	234-1001	234-1000	-	-
V8-5.0	1981-1980	2 Lead Sensor	234-2001	234-2000	-	-
<b>EPICA</b>						
L6-2.5	2006	w/ 14" Downstream Sensor	234-4420 <sup>1</sup>	-	234-4426 <sup>1</sup>	-
L6-2.5	2006	w/ 19" Downstream Sensor	234-4420 <sup>1</sup>	-	234-4425 <sup>1</sup>	-
L6-2.5	2005-2004		234-4422 <sup>1</sup>	-	234-4421 <sup>1</sup>	-
<b>EQUINOX</b>						
L4-2.4	2015		234-4242	-	234-4530	-
L4-2.4	2014		234-4242	-	234-4242	-
L4-2.4	2013-2011		234-4242	-	234-4530	-
L4-2.4	2010		234-4242	-	234-4251	-
V6-3.0	2012-2010		234-4815 <sup>1</sup>	-	234-4815 <sup>1</sup>	-

<sup>1</sup> 2 Required / Requis 2 / Requeridos 2



ENGINE MOTEUR MOTOR	YEAR ANNEE AÑO	APPLICATION INFORMATION INFORMATION D'APPLICATION INFORMACION DE APLICACION	UPSTREAM / AVANT - C.C. / ANTES DEL C.C.		DOWNSTREAM / APRES - C.C. / DESPUES DEL C.C.	
			TYPE / TIPO O.E.	UNIVERS.	TYPE / TIPO O.E.	UNIVERS.
<b>CHEVROLET [cont]</b>						
<b>EQUINOX [cont]</b>						
V6-3.4	2009-2008		234-4668	234-4212	234-4255	-
V6-3.4	2007-2005		234-4668	234-4212	234-4647	234-4209
V6-3.6	2015-2013		234-4564 <sup>1</sup>	-	234-4564 <sup>1</sup>	-
V6-3.6	2009-2008		234-4819 <sup>1</sup>	-	234-4840 <sup>1</sup>	-
<b>EXPRESS 1500</b>						
V6-4.3	2014-2008		234-4336 <sup>1</sup>	-	234-4243 <sup>1</sup>	-
V6-4.3	2007		234-4336 <sup>1</sup>	-	234-4561 <sup>1</sup>	-
V6-4.3	2006-2004		234-4285 <sup>5</sup>	-	234-4285 <sup>5</sup>	-
V6-4.3	2006-2003		234-4407 <sup>4</sup>	-	234-4407 <sup>4</sup>	-
V6-4.3	2003	w/ 13" Right Sensors	234-4285 <sup>5</sup>	-	234-4285 <sup>5</sup>	-
V6-4.3	2003	w/ 14.8" Right Sensors	234-4407 <sup>5</sup>	-	234-4407 <sup>5</sup>	-
V6-4.3	2002-1998	GVW Under 8,500 Lbs.	234-4012 <sup>1</sup>	234-4000 <sup>1</sup>	234-4018	234-4000
V6-4.3	2002-1996	GVW Over 8,500 Lbs.	234-4019 <sup>1</sup>	234-4000 <sup>1</sup>	234-4018	234-4000
V6-4.3	1997-1996	GVW Under 8,500 Lbs.; Upstream Sensor in Manifold	234-4012 <sup>1</sup>	234-4000 <sup>1</sup>	234-4018	234-4000
V6-4.3	1997-1996	GVW Under 8,500 Lbs.; Upstream Sensor in Y Pipe	234-4018	234-4000	-	-
V8-5.0	2002-1998		234-4012 <sup>1</sup>	234-4000 <sup>1</sup>	234-4018	234-4000
V8-5.0	1997-1996	Upstream Sensor in Manifold	234-4012 <sup>1</sup>	234-4000 <sup>1</sup>	234-4018	234-4000
V8-5.0	1997-1996	Upstream Sensor in Y Pipe	234-4018	234-4000	-	-
V8-5.3	2014-2008		234-4336 <sup>1</sup>	-	234-4243 <sup>1</sup>	-
V8-5.3	2007	Calif.	234-4336 <sup>1</sup>	-	234-4561 <sup>1</sup>	-
V8-5.3	2007	Exc. Calif.	234-4407 <sup>4</sup>	-	234-4407 <sup>4</sup>	-
V8-5.3	2007	Exc. Calif.	234-4285 <sup>5</sup>	-	234-4285 <sup>5</sup>	-
V8-5.3	2006-2004		234-4285 <sup>5</sup>	-	234-4285 <sup>5</sup>	-
V8-5.3	2006-2003		234-4407 <sup>4</sup>	-	234-4407 <sup>4</sup>	-
V8-5.3	2003	w/ 13" Right Sensors	234-4285 <sup>5</sup>	-	234-4285 <sup>5</sup>	-
V8-5.3	2003	w/ 14.8" Right Sensors	234-4407 <sup>5</sup>	-	234-4407 <sup>5</sup>	-
V8-5.7	2002-1996	GVW Over 8,500 Lbs.	234-4019 <sup>1</sup>	234-4000 <sup>1</sup>	234-4018 <sup>1</sup>	234-4000 <sup>1</sup>
V8-5.7	2002-1996	GVW Under 8,500 Lbs.	234-4012 <sup>1</sup>	234-4000 <sup>1</sup>	234-4018 <sup>1</sup>	234-4000 <sup>1</sup>
<b>EXPRESS 2500</b>						
V6-4.3	2005-2004		234-4285 <sup>5</sup>	-	234-4285 <sup>5</sup>	-
V6-4.3	2005-2003		234-4407 <sup>4</sup>	-	234-4407 <sup>4</sup>	-
V6-4.3	2003	w/ 13" Right Sensors	234-4285 <sup>5</sup>	-	234-4285 <sup>5</sup>	-
V6-4.3	2003	w/ 14.8" Right Sensors	234-4407 <sup>5</sup>	-	234-4407 <sup>5</sup>	-
V6-4.3	2002-1998	GVW Under 8,500 Lbs.	234-4012 <sup>1</sup>	234-4000 <sup>1</sup>	234-4018	234-4000
V6-4.3	2002-1996	GVW Over 8,500 Lbs.	234-4019 <sup>1</sup>	234-4000 <sup>1</sup>	234-4018	234-4000
V6-4.3	1997-1996	GVW Under 8,500 Lbs.; Upstream Sensor in Manifold	234-4012 <sup>1</sup>	234-4000 <sup>1</sup>	234-4018	234-4000
V6-4.3	1997-1996	GVW Under 8,500 Lbs.; Upstream Sensor in Y Pipe	234-4018	234-4000	-	-
V8-4.8	2015-2008		234-4336 <sup>1</sup>	-	234-4243 <sup>1</sup>	-
V8-4.8	2007-2004		234-4285 <sup>5</sup>	-	234-4285 <sup>5</sup>	-

<sup>1</sup> 2 Required / Requis 2 / Requeridos 2 <sup>4</sup> Left Side / Côté gauche / Lado izquierdo <sup>5</sup> Right Side / Côté droit / Lado derecho



ENGINE MOTEUR MOTOR	YEAR ANNEE AÑO	APPLICATION INFORMATION INFORMATION D'APPLICATION INFORMACION DE APLICACION	UPSTREAM / AVANT - C.C. / ANTES DEL C.C.		DOWNSTREAM / APRS - C.C. / DESPUES DEL C.C.	
			TYPE / TIPO O.E.	UNIVERS.	TYPE / TIPO O.E.	UNIVERS.
<b>CHEVROLET [cont]</b>						
<b>EXPRESS 2500 [cont]</b>						
V8-4.8	2007-2003		234-4407 <sup>4</sup>	-	234-4407 <sup>4</sup>	-
V8-4.8	2003	w/ 13" Right Sensors	234-4285 <sup>5</sup>	-	234-4285 <sup>5</sup>	-
V8-4.8	2003	w/ 14.8" Right Sensors	234-4407 <sup>5</sup>	-	234-4407 <sup>5</sup>	-
V8-5.0	2002-1998		234-4012 <sup>1</sup>	234-4000 <sup>1</sup>	234-4018	234-4000
V8-5.0	1997-1996	Upstream Sensor in Manifold	234-4012 <sup>1</sup>	234-4000 <sup>1</sup>	234-4018	234-4000
V8-5.0	1997-1996	Upstream Sensor in Y Pipe	234-4018	234-4000	-	-
V8-5.3	2005-2004		234-4285 <sup>5</sup>	-	234-4285 <sup>5</sup>	-
V8-5.3	2005-2003		234-4407 <sup>4</sup>	-	234-4407 <sup>4</sup>	-
V8-5.3	2003	w/ 13" Right Sensors	234-4285 <sup>5</sup>	-	234-4285 <sup>5</sup>	-
V8-5.3	2003	w/ 14.8" Right Sensors	234-4407 <sup>5</sup>	-	234-4407 <sup>5</sup>	-
V8-5.7	2002-1996	GVW Over 8,500 Lbs.	234-4019 <sup>1</sup>	234-4000 <sup>1</sup>	234-4018 <sup>1</sup>	234-4000 <sup>1</sup>
V8-5.7	2002-1996	GVW Under 8,500 Lbs.	234-4012 <sup>1</sup>	234-4000 <sup>1</sup>	234-4018 <sup>1</sup>	234-4000 <sup>1</sup>
V8-6.0	2015-2013		234-4336 <sup>1</sup>	-	234-4243 <sup>1</sup>	-
V8-6.0	2012-2011		234-4257 <sup>1</sup>	-	234-4243 <sup>1</sup>	-
V8-6.0	2010-2008		234-4336 <sup>1</sup>	-	234-4243 <sup>1</sup>	-
V8-6.0	2007-2004		234-4285 <sup>5</sup>	-	234-4285 <sup>5</sup>	-
V8-6.0	2007-2003		234-4407 <sup>4</sup>	-	234-4407 <sup>4</sup>	-
V8-6.0	2003	w/ 13" Right Sensors	234-4285 <sup>5</sup>	-	234-4285 <sup>5</sup>	-
V8-6.0	2003	w/ 14.8" Right Sensors	234-4407 <sup>5</sup>	-	234-4407 <sup>5</sup>	-
<b>EXPRESS 3500</b>						
V8-4.8	2015-2008		234-4336 <sup>1</sup>	-	234-4243 <sup>1</sup>	-
V8-4.8	2007-2005		234-4407 <sup>4</sup>	-	234-4407 <sup>4</sup>	-
V8-4.8	2007-2005		234-4285 <sup>5</sup>	-	234-4285 <sup>5</sup>	-
V8-5.7	2002-1996	GVW Over 8,500 Lbs.	234-4019 <sup>1</sup>	234-4000 <sup>1</sup>	234-4018 <sup>1</sup>	234-4000 <sup>1</sup>
V8-5.7	2002-1996	GVW Under 8,500 Lbs.	234-4012 <sup>1</sup>	234-4000 <sup>1</sup>	234-4018 <sup>1</sup>	234-4000 <sup>1</sup>
V8-6.0	2015-2013		234-4336 <sup>1</sup>	-	234-4243 <sup>1</sup>	-
V8-6.0	2012-2011		234-4257 <sup>1</sup>	-	234-4243 <sup>1</sup>	-
V8-6.0	2010-2008	Cutaway Van	234-4257 <sup>1</sup>	-	234-4243 <sup>1</sup>	-
V8-6.0	2010-2008	Passenger & Cargo Vans	234-4336 <sup>1</sup>	-	234-4243 <sup>1</sup>	-
V8-6.0	2007-2004		234-4285 <sup>5</sup>	-	234-4285 <sup>5</sup>	-
V8-6.0	2007-2003		234-4407 <sup>4</sup>	-	234-4407 <sup>4</sup>	-
V8-6.0	2003	w/ 13" Right Sensors	234-4285 <sup>5</sup>	-	234-4285 <sup>5</sup>	-
V8-6.0	2003	w/ 14.8" Right Sensors	234-4407 <sup>5</sup>	-	234-4407 <sup>5</sup>	-
V8-7.4	2000-1996		234-4019 <sup>1</sup>	234-4000 <sup>1</sup>	234-4018 <sup>1</sup>	234-4000 <sup>1</sup>
V8-8.1	2002-2001		234-4103 <sup>1</sup>	234-4209 <sup>1</sup>	234-4103 <sup>1</sup>	234-4209 <sup>1</sup>
<b>G10 VAN</b>						
L6-4.1	1984-1980		234-1001	234-1000	-	-
V6-4.3	1995		234-3011	234-3000	-	-
V6-4.3	1994		234-3005	234-3000	-	-

<sup>1</sup> 2 Required / Requis 2 / Requeridos 2 <sup>4</sup> Left Side / Côté gauche / Lado izquierdo <sup>5</sup> Right Side / Côté droit / Lado derecho



ENGINE MOTEUR MOTOR	YEAR ANNEE AÑO	APPLICATION INFORMATION INFORMATION D'APPLICATION INFORMACION DE APLICACION	UPSTREAM / AVANT - C.C. / ANTES DEL C.C.		DOWNSTREAM / APRS - C.C. / DESPUES DEL C.C.	
			TYPE / TIPO O.E.	UNIVERS.	TYPE / TIPO O.E.	UNIVERS.
<b>CHEVROLET [cont]</b>						
<b>G10 VAN [cont]</b>						
V6-4.3	1993-1992	3 Lead Sensor	234-3094	234-3090	-	-
V6-4.3	1993-1985	1 Lead Sensor	234-1001	234-1000	-	-
V8-5.0	1995-1980		234-1001	234-1000	-	-
V8-5.7	1993-1980		234-1001	234-1000	-	-
<b>G20 VAN</b>						
L6-4.1	1984-1980		234-1001	234-1000	-	-
V6-4.3	1995		234-3011	234-3000	-	-
V6-4.3	1994		234-3005	234-3000	-	-
V6-4.3	1993-1992	3 Lead Sensor	234-3094	234-3090	-	-
V6-4.3	1993-1985	1 Lead Sensor	234-1001	234-1000	-	-
V8-5.0	1995-1980		234-1001	234-1000	-	-
V8-5.7	1995-1980		234-1001	234-1000	-	-
<b>G30 VAN</b>						
L6-4.1	1984-1981		234-1001	234-1000	-	-
V6-4.3	1996-1995		234-3011	234-3000	-	-
V6-4.3	1994		234-3005	234-3000	-	-
V6-4.3	1993-1992	3 Lead Sensor	234-3094	234-3090	-	-
V6-4.3	1993-1985	1 Lead Sensor	234-1001	234-1000	-	-
V8-5.0	1985		234-1001	234-1000	-	-
V8-5.0	1982		234-1001	234-1000	-	-
V8-5.7	1996	GVW Over 8,500 Lbs.	234-4019 <sup>1</sup>	234-4000 <sup>1</sup>	234-4018 <sup>1</sup>	234-4000 <sup>1</sup>
V8-5.7	1996	GVW Under 8,500 Lbs.	234-4012 <sup>1</sup>	234-4000 <sup>1</sup>	234-4018 <sup>1</sup>	234-4000 <sup>1</sup>
V8-5.7	1995-1980		234-1001	234-1000	-	-
V8-7.4	1996		234-4019 <sup>1</sup>	234-4000 <sup>1</sup>	234-4018 <sup>1</sup>	234-4000 <sup>1</sup>
V8-7.4	1995-1988		234-1001	234-1000	-	-
<b>HHR</b>						
L4-2.0	2010-2008		234-5007	-	234-4245	-
L4-2.2	2011-2007		234-4668	234-4212	234-4066	234-4209
L4-2.2	2006		234-4342	-	234-4066	234-4209
L4-2.4	2011-2009		234-4668	234-4212	234-4066	234-4209
L4-2.4	2008		234-4242	-	234-4066	234-4209
L4-2.4	2007-2006		234-4332	-	234-4066	234-4209
<b>IMPALA</b>						
L4-2.4	2014		234-4673	234-4212	234-4526	-
L4-2.5	2015-2014		234-4763	-	234-4762	-
V6-3.4	2005		234-4343	-	234-4647	234-4209
V6-3.4	2004-2001		234-4650	234-4209	234-4087	234-4000
V6-3.4	2000		234-4018	234-4000	234-4087	234-4000
V6-3.5	2011-2008		234-4668 <sup>1</sup>	234-4212 <sup>1</sup>	234-4254	-
V6-3.5	2007-2006		234-4668 <sup>1</sup>	234-4212 <sup>1</sup>	234-4647	234-4209
V6-3.6	2015		234-4566 <sup>1</sup>	-	234-4566 <sup>1</sup>	-

<sup>1</sup> 2 Required / Requis 2 / Requeridos 2



ENGINE MOTEUR MOTOR	YEAR ANNEE AÑO	APPLICATION INFORMATION INFORMATION D'APPLICATION INFORMACION DE APLICACION	UPSTREAM / AVANT - C.C. / ANTES DEL C.C.		DOWNSTREAM / APRES - C.C. / DESPUES DEL C.C.	
			TYPE / TIPO O.E.	UNIVERS.	TYPE / TIPO O.E.	UNIVERS.
<b>CHEVROLET [cont]</b>						
<b>IMPALA [cont]</b>						
V6-3.6	2014-2012		234-4564 <sup>1</sup>	-	234-4564 <sup>1</sup>	-
V6-3.8	2005-2004		234-4646	234-4209	234-4647	234-4209
V6-3.8	2003-2000		234-4018	234-4000	234-4087	234-4000
V6-3.8	1985-1980	1 Lead Sensor	234-1001	234-1000	-	-
V6-3.8	1981-1980	2 Lead Sensor	234-2001	234-2000	-	-
V6-3.9	2011-2008		234-4668 <sup>1</sup>	234-4212 <sup>1</sup>	234-4254	-
V6-3.9	2007-2006		234-4668 <sup>1</sup>	234-4212 <sup>1</sup>	234-4647	234-4209
V6-4.3	1985		234-3074	234-3090	-	-
V8-4.4	1982-1980	1 Lead Sensor	234-1001	234-1000	-	-
V8-4.4	1981-1980	2 Lead Sensor	234-2001	234-2000	-	-
V8-5.0	1985-1980	1 Lead Sensor	234-1001	234-1000	-	-
V8-5.0	1981-1980	2 Lead Sensor	234-2001	234-2000	-	-
V8-5.3	2009-2008		234-4236	-	234-4249	-
V8-5.3	2007-2006		234-4236	-	234-4647	234-4209
V8-5.7	1996		234-4012 <sup>1</sup>	234-4000 <sup>1</sup>	234-4012 <sup>1</sup>	234-4000 <sup>1</sup>
V8-5.7	1995-1994		234-4012 <sup>1</sup>	234-4000 <sup>1</sup>	-	-
V8-5.7	1985-1980	1 Lead Sensor	234-1001	234-1000	-	-
V8-5.7	1981-1980	2 Lead Sensor	234-2001	234-2000	-	-
<b>IMPALA LIMITED</b>						
V6-3.6	2015-2014		234-4564 <sup>1</sup>	-	234-4564 <sup>1</sup>	-
<b>K10 SUBURBAN</b>						
V8-5.0	1986-1983		234-1001	234-1000	-	-
V8-5.7	1986-1983		234-1001	234-1000	-	-
<b>K10 TRUCK</b>						
L6-4.1	1984-1983		234-1001	234-1000	-	-
V6-4.3	1986-1985		234-1001	234-1000	-	-
V8-5.0	1986-1983		234-1001	234-1000	-	-
V8-5.7	1986-1983		234-1001	234-1000	-	-
<b>K20 SUBURBAN</b>						
V8-5.0	1986-1985		234-1001	234-1000	-	-
V8-5.7	1986-1983		234-1001	234-1000	-	-
V8-7.4	1985		234-1001	234-1000	-	-
<b>K20 TRUCK</b>						
L6-4.8	1986-1983		234-1001	234-1000	-	-
V6-4.3	1985		234-1001	234-1000	-	-
V8-5.0	1985		234-1001	234-1000	-	-
V8-5.7	1986-1983		234-1001	234-1000	-	-
<b>K30 TRUCK</b>						
L6-4.8	1986-1983		234-1001	234-1000	-	-
V8-5.7	1986-1983		234-1001	234-1000	-	-
V8-7.4	1986-1983		234-1001	234-1000	-	-

<sup>1</sup> 2 Required / Requis 2 / Requeridos 2



ENGINE MOTEUR MOTOR	YEAR ANNEE AÑO	APPLICATION INFORMATION INFORMATION D'APPLICATION INFORMACION DE APLICACION	UPSTREAM / AVANT - C.C. / ANTES DEL C.C.		DOWNSTREAM / APRS - C.C. / DESPUES DEL C.C.	
			TYPE / TIPO O.E.	UNIVERS.	TYPE / TIPO O.E.	UNIVERS.
<b>CHEVROLET [cont]</b>						
<b>K1500 SUBURBAN</b>						
V8-5.7	1999-1996	Trans Code 4L60E	234-4012 <sup>1</sup>	234-4000 <sup>1</sup>	234-4018 <sup>1</sup>	234-4000 <sup>1</sup>
V8-5.7	1999-1996	Trans Code 4L80E	234-4019 <sup>1</sup>	234-4000 <sup>1</sup>	234-4018 <sup>1</sup>	234-4000 <sup>1</sup>
V8-5.7	1995-1992	1 Lead Sensor	234-1001	234-1000	-	-
V8-5.7	1995	3 Lead Sensor	234-3011	234-3000	-	-
V8-5.7	1994	3 Lead Sensor	234-3005	234-3000	-	-
V8-5.7	1993-1992	3 Lead Sensor	234-3094	234-3090	-	-
<b>K1500 TRUCK</b>						
V6-4.3	1998		234-4012 <sup>1</sup>	234-4000 <sup>1</sup>	234-4018	234-4000
V6-4.3	1997-1996	Upstream Sensor in Manifold	234-4012 <sup>1</sup>	234-4000 <sup>1</sup>	234-4018	234-4000
V6-4.3	1997-1996	Upstream Sensor in Y Pipe	234-4018	234-4000	-	-
V6-4.3	1995		234-3011 <sup>1</sup>	234-3000 <sup>1</sup>	-	-
V6-4.3	1994		234-3005	234-3000	-	-
V6-4.3	1993-1992	3 Lead Sensor	234-3094	234-3090	-	-
V6-4.3	1993-1988	1 Lead Sensor	234-1001	234-1000	-	-
V8-5.0	1999		234-4012 <sup>1</sup>	234-4000 <sup>1</sup>	234-4018	234-4000
V8-5.0	1998	Auto Trans	234-4012 <sup>1</sup>	234-4000 <sup>1</sup>	234-4018	234-4000
V8-5.0	1998	Manual Trans	234-4019 <sup>1</sup>	234-4000 <sup>1</sup>	234-4018	234-4000
V8-5.0	1997-1996	Auto Trans; Upstream Sensor in Manifold	234-4012 <sup>1</sup>	234-4000 <sup>1</sup>	234-4018	234-4000
V8-5.0	1997-1996	Auto Trans; Upstream Sensor in Y Pipe	234-4018	234-4000	-	-
V8-5.0	1997-1996	Manual Trans; Upstream Sensor in Manifold	234-4019 <sup>1</sup>	234-4000 <sup>1</sup>	234-4018	234-4000
V8-5.0	1997-1996	Manual Trans; Upstream Sensor in Y Pipe	234-4018	234-4000	-	-
V8-5.0	1995-1988	1 Lead Sensor	234-1001	234-1000	-	-
V8-5.0	1995	3 Lead Sensor	234-3011	234-3000	-	-
V8-5.0	1994	3 Lead Sensor	234-3005	234-3000	-	-
V8-5.0	1993-1992	3 Lead Sensor	234-3094	234-3090	-	-
V8-5.7	1999-1996	Auto Trans; Trans Code 4L60E	234-4012 <sup>1</sup>	234-4000 <sup>1</sup>	234-4018 <sup>1</sup>	234-4000 <sup>1</sup>
V8-5.7	1999-1996	Auto Trans; Trans Code 4L80E	234-4019 <sup>1</sup>	234-4000 <sup>1</sup>	234-4018 <sup>1</sup>	234-4000 <sup>1</sup>
V8-5.7	1998-1996	Manual Trans	234-4019 <sup>1</sup>	234-4000 <sup>1</sup>	234-4018 <sup>1</sup>	234-4000 <sup>1</sup>
V8-5.7	1995-1988	1 Lead Sensor	234-1001	234-1000	-	-
V8-5.7	1995	3 Lead Sensor	234-3011	234-3000	-	-
V8-5.7	1994	3 Lead Sensor	234-3005	234-3000	-	-
V8-5.7	1993-1992	3 Lead Sensor	234-3094	234-3090	-	-
<b>K2500 SUBURBAN</b>						
V8-5.7	1999-1997		234-4019 <sup>1</sup>	234-4000 <sup>1</sup>	234-4018 <sup>1</sup>	234-4000 <sup>1</sup>
V8-5.7	1996	Trans Code 4L60E	234-4012 <sup>1</sup>	234-4000 <sup>1</sup>	234-4018 <sup>1</sup>	234-4000 <sup>1</sup>
V8-5.7	1996	Trans Code 4L80E	234-4019 <sup>1</sup>	234-4000 <sup>1</sup>	234-4018 <sup>1</sup>	234-4000 <sup>1</sup>
V8-5.7	1995-1992	1 Lead Sensor	234-1001	234-1000	-	-
V8-5.7	1995	3 Lead Sensor	234-3011	234-3000	-	-
V8-5.7	1994	3 Lead Sensor	234-3005	234-3000	-	-

<sup>1</sup> 2 Required / Requis 2 / Requeridos 2



ENGINE MOTEUR MOTOR	YEAR ANNEE AÑO	APPLICATION INFORMATION INFORMATION D'APPLICATION INFORMACION DE APLICACION	UPSTREAM / AVANT - C.C. / ANTES DEL C.C.		DOWNSTREAM / APRS - C.C. / DESPUES DEL C.C.	
			TYPE / TIPO O.E.	UNIVERS.	TYPE / TIPO O.E.	UNIVERS.
<b>CHEVROLET [cont]</b>						
<b>K2500 SUBURBAN [cont]</b>						
V8-5.7	1993-1992	3 Lead Sensor	234-3094	234-3090	-	-
V8-7.4	1999-1996		234-4019 <sup>1</sup>	234-4000 <sup>1</sup>	234-4018 <sup>1</sup>	234-4000 <sup>1</sup>
V8-7.4	1995-1992		234-1001	234-1000	-	-
<b>K2500 TRUCK</b>						
V6-4.3	1995		234-3011 <sup>1</sup>	234-3000 <sup>1</sup>	-	-
V6-4.3	1994		234-3005	234-3000	-	-
V6-4.3	1993-1992	3 Lead Sensor	234-3094	234-3090	-	-
V6-4.3	1993-1988	1 Lead Sensor	234-1001	234-1000	-	-
V8-5.0	1998	Auto Trans	234-4012 <sup>1</sup>	234-4000 <sup>1</sup>	234-4018	234-4000
V8-5.0	1998	Manual Trans	234-4019 <sup>1</sup>	234-4000 <sup>1</sup>	234-4018	234-4000
V8-5.0	1997	Auto Trans; Upstream Sensor in Manifold	234-4012 <sup>1</sup>	234-4000 <sup>1</sup>	234-4018	234-4000
V8-5.0	1997	Auto Trans; Upstream Sensor in Y Pipe	234-4018	234-4000	-	-
V8-5.0	1997	Manual Trans; Upstream Sensor in Manifold	234-4019 <sup>1</sup>	234-4000 <sup>1</sup>	234-4018	234-4000
V8-5.0	1997	Manual Trans; Upstream Sensor in Y Pipe	234-4018	234-4000	-	-
V8-5.0	1995-1988	1 Lead Sensor	234-1001	234-1000	-	-
V8-5.0	1995	3 Lead Sensor	234-3011	234-3000	-	-
V8-5.0	1994	3 Lead Sensor	234-3005	234-3000	-	-
V8-5.0	1993-1992	3 Lead Sensor	234-3094	234-3090	-	-
V8-5.7	2000-1999		234-4019 <sup>1</sup>	234-4000 <sup>1</sup>	234-4018 <sup>1</sup>	234-4000 <sup>1</sup>
V8-5.7	1998-1996	Auto Trans; Trans Code 4L60E	234-4012 <sup>1</sup>	234-4000 <sup>1</sup>	234-4018 <sup>1</sup>	234-4000 <sup>1</sup>
V8-5.7	1998-1996	Auto Trans; Trans Code 4L80E	234-4019 <sup>1</sup>	234-4000 <sup>1</sup>	234-4018 <sup>1</sup>	234-4000 <sup>1</sup>
V8-5.7	1998-1996	Manual Trans	234-4019 <sup>1</sup>	234-4000 <sup>1</sup>	234-4018 <sup>1</sup>	234-4000 <sup>1</sup>
V8-5.7	1995-1988	1 Lead Sensor	234-1001	234-1000	-	-
V8-5.7	1995	3 Lead Sensor	234-3011	234-3000	-	-
V8-5.7	1994	3 Lead Sensor	234-3005	234-3000	-	-
V8-5.7	1993-1992	3 Lead Sensor	234-3094	234-3090	-	-
V8-7.4	2000	Calif.	234-4103 <sup>1</sup>	234-4209 <sup>1</sup>	234-4103 <sup>1</sup>	234-4209 <sup>1</sup>
V8-7.4	2000	Exc. Calif.	234-4103 <sup>1</sup>	234-4209 <sup>1</sup>	234-4018 <sup>1</sup>	234-4000 <sup>1</sup>
V8-7.4	1999-1996		234-4019 <sup>1</sup>	234-4000 <sup>1</sup>	234-4018 <sup>1</sup>	234-4000 <sup>1</sup>
V8-7.4	1995		234-1001 <sup>1</sup>	234-1000 <sup>1</sup>	-	-
V8-7.4	1994-1991		234-1001	234-1000	-	-
<b>K3500 TRUCK</b>						
V8-5.7	2000-1996		234-4019 <sup>1</sup>	234-4000 <sup>1</sup>	234-4018 <sup>1</sup>	234-4000 <sup>1</sup>
V8-5.7	1995-1988	1 Lead Sensor	234-1001	234-1000	-	-
V8-5.7	1995	3 Lead Sensor	234-3011	234-3000	-	-
V8-5.7	1994	3 Lead Sensor	234-3005	234-3000	-	-
V8-5.7	1993-1992	3 Lead Sensor	234-3094	234-3090	-	-
V8-7.4	2000	Calif.	234-4103 <sup>1</sup>	234-4209 <sup>1</sup>	234-4103 <sup>1</sup>	234-4209 <sup>1</sup>
V8-7.4	2000	Exc. Calif.	234-4103 <sup>1</sup>	234-4209 <sup>1</sup>	234-4018 <sup>1</sup>	234-4000 <sup>1</sup>
V8-7.4	1999-1996		234-4019 <sup>1</sup>	234-4000 <sup>1</sup>	234-4018 <sup>1</sup>	234-4000 <sup>1</sup>

<sup>1</sup> 2 Required / Requis 2 / Requeridos 2



ENGINE MOTEUR MOTOR	YEAR ANNEE AÑO	APPLICATION INFORMATION INFORMATION D'APPLICATION INFORMACION DE APLICACION	UPSTREAM / AVANT - C.C. / ANTES DEL C.C.		DOWNSTREAM / APRES - C.C. / DESPUES DEL C.C.	
			TYPE / TIPO O.E.	UNIVERS.	TYPE / TIPO O.E.	UNIVERS.
<b>CHEVROLET [cont]</b>						
<b>K3500 TRUCK [cont]</b>						
V8-7.4	1995-1988		234-1001	234-1000	-	-
<b>LLV</b>						
L4-2.2	1995-1994		234-1001	234-1000	-	-
L4-2.5	1993-1987		234-1001	234-1000	-	-
<b>LUMINA</b>						
L4-2.2	1993		234-1001	234-1000	-	-
L4-2.5	1992-1990		234-1001	234-1000	-	-
V6-3.1	2001-1997		234-4018	234-4000	234-4087	234-4000
V6-3.1	1996		234-4012 <sup>1</sup>	234-4000 <sup>1</sup>	234-4087	234-4000
V6-3.1	1995		234-4012 <sup>1</sup>	234-4000 <sup>1</sup>	-	-
V6-3.1	1994		234-1001	234-1000	-	-
V6-3.1	1993	Calif.	234-3094	234-3090	-	-
V6-3.1	1993	Exc. Calif.	234-1001	234-1000	-	-
V6-3.1	1992-1990		234-1001	234-1000	-	-
V6-3.4	1997		234-4018	234-4000	234-4087	234-4000
V6-3.4	1996		234-4012	234-4000	234-4087	234-4000
V6-3.4	1995		234-4012 <sup>1</sup>	234-4000 <sup>1</sup>	-	-
V6-3.4	1994		234-4012	234-4000	-	-
V6-3.4	1993-1991		234-1001	234-1000	-	-
V6-3.8	1999-1998		234-4018	234-4000	234-4087	234-4000
<b>LUMINA APV</b>						
V6-3.1	1995-1990		234-1001	234-1000	-	-
V6-3.4	1996		234-4012	234-4000	234-4087	234-4000
V6-3.8	1995-1994		234-4012	234-4000	-	-
V6-3.8	1993		234-3011	234-3000	-	-
V6-3.8	1992		234-1001	234-1000	-	-
<b>LUV</b>						
L4-1.8	1982-1980	1 Lead Sensor	234-1001	234-1000	-	-
L4-1.8	1981-1980	2 Lead Sensor	234-2001	234-2000	-	-
<b>MALIBU</b>						
L4-2.0	2015-2013		234-4763	-	234-4762	-
L4-2.2	2008-2007		234-4342	-	234-4285	-
L4-2.2	2006		234-4287	-	234-4285	-
L4-2.2	2005-2004	Classic Body Style; N-Body	234-4646	234-4209	234-4104	234-4209
L4-2.2	2005-2004	New Style; Z-Body	234-4287	-	234-4285	-
L4-2.4	2014-2013		234-4673	234-4212	234-4526	-
L4-2.4	2012-2011		234-4673	234-4212	234-4251	-
L4-2.4	2010-2009	Gas Engine; 4 Speed Auto Trans	234-4242	-	234-4250	-
L4-2.4	2010-2009	Gas Engine; 6 Speed Auto Trans	234-4673	234-4212	234-4251	-
L4-2.4	2010-2009	Hybrid Engine	234-4242	-	234-4250	-
L4-2.4	2010	Flex Fuel Engine; 4 Speed Auto Trans	234-4242	-	234-4250	-

<sup>1</sup> 2 Required / Requis 2 / Requeridos 2





ENGINE MOTEUR MOTOR	YEAR ANNEE AÑO	APPLICATION INFORMATION INFORMATION D'APPLICATION INFORMACION DE APLICACION	UPSTREAM / AVANT - C.C. / ANTES DEL C.C.		DOWNSTREAM / APRS - C.C. / DESPUES DEL C.C.	
			TYPE / TIPO O.E.	UNIVERS.	TYPE / TIPO O.E.	UNIVERS.
<b>CHEVROLET [cont]</b>						
<b>MALIBU [cont]</b>						
L4-2.4	2010	Flex Fuel Engine; 6 Speed Auto Trans	234-4673	234-4212	234-4251	-
L4-2.4	2008	1st Design; Gas Engine; Downstream Sensor Marked 12597947	234-4242	-	234-4294	-
L4-2.4	2008	1st Design; Hybrid Engine; Downstream Sensor Marked 12615904	234-4242	-	234-4251	-
L4-2.4	2008	2nd Design; Downstream Sensor Marked 12617907	234-4242	-	234-4250	-
L4-2.4	1999	Exc. RC9 Option Code	234-1001	234-1000	234-4617	234-4000
L4-2.4	1999	RC9 Option Code	234-1023	234-1000	234-4617	234-4000
L4-2.4	1998-1997		234-1001	234-1000	234-4617	234-4000
L4-2.5	2015-2013		234-4763	-	234-4762	-
V6-3.1	2003-2001		234-4650	234-4209	234-4617	234-4000
V6-3.1	2000-1999	VIN J	234-4018	234-4000	234-4617	234-4000
V6-3.1	1999	VIN M	234-4018 <sup>1</sup>	234-4000 <sup>1</sup>	234-4617	234-4000
V6-3.1	1998-1997		234-4018 <sup>1</sup>	234-4000 <sup>1</sup>	234-4617	234-4000
V6-3.5	2010-2008		234-4668 <sup>1</sup>	234-4212 <sup>1</sup>	234-4255 <sup>1</sup>	-
V6-3.5	2007-2004		234-4668 <sup>1</sup>	234-4212 <sup>1</sup>	234-4651 <sup>1</sup>	234-4209 <sup>1</sup>
V6-3.6	2012-2008		234-4668 <sup>4</sup>	234-4212 <sup>4</sup>	234-4254 <sup>4</sup>	-
V6-3.6	2012-2008		234-4668 <sup>5</sup>	234-4212 <sup>5</sup>	234-4341 <sup>5</sup>	-
V6-3.8	1983-1980	1 Lead Sensor	234-1001	234-1000	-	-
V6-3.8	1981-1979	2 Lead Sensor	234-2001	234-2000	-	-
V6-3.9	2007-2006		234-4668 <sup>4</sup>	234-4212 <sup>4</sup>	234-4651 <sup>4</sup>	234-4209 <sup>4</sup>
V6-3.9	2007-2006		234-4668 <sup>5</sup>	234-4212 <sup>5</sup>	234-4647 <sup>5</sup>	234-4209 <sup>5</sup>
V8-4.4	1982-1980	1 Lead Sensor	234-1001	234-1000	-	-
V8-4.4	1981-1980	2 Lead Sensor	234-2001	234-2000	-	-
V8-5.0	1983-1980	1 Lead Sensor	234-1001	234-1000	-	-
V8-5.0	1981-1980	2 Lead Sensor	234-2001	234-2000	-	-
V8-5.7	1981-1980	1 Lead Sensor	234-1001	234-1000	-	-
V8-5.7	1981-1980	2 Lead Sensor	234-2001	234-2000	-	-
<b>METRO</b>						
L3-1.0	2000-1998		234-4049	234-4209	234-4648	234-4209
L4-1.3	2001-1998		234-4049	234-4209	234-4648	234-4209
L4-1.3	1992		234-1001	234-1000	-	-
<b>MONTE CARLO</b>						
V6-3.1	1999-1997		234-4018	234-4000	234-4087	234-4000
V6-3.1	1996		234-4012 <sup>1</sup>	234-4000 <sup>1</sup>	234-4087	234-4000
V6-3.1	1995		234-4012 <sup>1</sup>	234-4000 <sup>1</sup>	-	-
V6-3.4	2005		234-4343	-	234-4647	234-4209
V6-3.4	2004-2001		234-4650	234-4209	234-4087	234-4000
V6-3.4	2000		234-4018	234-4000	234-4087	234-4000
V6-3.4	1997		234-4018	234-4000	234-4087	234-4000
V6-3.4	1996		234-4012	234-4000	234-4087	234-4000
V6-3.4	1995		234-4012 <sup>1</sup>	234-4000 <sup>1</sup>	-	-

<sup>1</sup> 2 Required / Requis 2 / Requeridos 2 <sup>4</sup> Left Side / Côté gauche / Lado izquierdo <sup>5</sup> Right Side / Côté droit / Lado derecho



ENGINE MOTEUR MOTOR	YEAR ANNEE AÑO	APPLICATION INFORMATION INFORMATION D'APPLICATION INFORMACION DE APLICACION	UPSTREAM / AVANT - C.C. / ANTES DEL C.C.		DOWNSTREAM / APRES - C.C. / DESPUES DEL C.C.	
			TYPE / TIPO O.E.	UNIVERS.	TYPE / TIPO O.E.	UNIVERS.
<b>CHEVROLET [cont]</b>						
<b>MONTE CARLO [cont]</b>						
V6-3.5	2007-2006		234-4668 <sup>1</sup>	234-4212 <sup>1</sup>	234-4647	234-4209
V6-3.8	2005-2004		234-4646	234-4209	234-4647	234-4209
V6-3.8	2003-1998		234-4018	234-4000	234-4087	234-4000
V6-3.8	1987-1980	1 Lead Sensor	234-1001	234-1000	-	-
V6-3.8	1981-1979	2 Lead Sensor	234-2001	234-2000	-	-
V6-3.9	2006		234-4668 <sup>1</sup>	234-4212 <sup>1</sup>	234-4647	234-4209
V6-4.3	1988-1986		234-1001	234-1000	-	-
V6-4.3	1985		234-3074	234-3090	-	-
V8-4.4	1982-1980	1 Lead Sensor	234-1001	234-1000	-	-
V8-4.4	1981-1980	2 Lead Sensor	234-2001	234-2000	-	-
V8-5.0	1988-1980	1 Lead Sensor	234-1001	234-1000	-	-
V8-5.0	1981-1980	2 Lead Sensor	234-2001	234-2000	-	-
V8-5.3	2007-2006		234-4236	-	234-4647	234-4209
<b>MONZA</b>						
L4-2.5	1980	1 Lead Sensor	234-1001	234-1000	-	-
L4-2.5	1980	2 Lead Sensor	234-2001	234-2000	-	-
V6-3.8	1980-1979	2 Lead Sensor	234-2001	234-2000	-	-
V6-3.8	1980	1 Lead Sensor	234-1001	234-1000	-	-
<b>NOVA</b>						
L4-1.6	1988-1985	Carbureted	234-1056	234-1057	-	-
L4-1.6	1988	Fuel Injected	234-4150	234-4050	-	-
<b>OPTRA</b>						
L4-2.0	2007-2006		-	-	234-4423	-
<b>ORLANDO</b>						
L4-2.4	2013-2012		234-4673	234-4212	-	-
<b>P20 VAN</b>						
L6-4.8	1989-1983		234-1001	234-1000	-	-
V8-5.7	1989-1983		234-1001	234-1000	-	-
<b>P30 VAN</b>						
L6-4.8	1989-1983		234-1001	234-1000	-	-
V6-4.3	1999-1996		234-4019 <sup>1</sup>	234-4000 <sup>1</sup>	234-4018	234-4000
V6-4.3	1995		234-4012	234-4000	-	-
V6-4.3	1994-1992	3 Lead Sensor	234-3094	234-3090	-	-
V6-4.3	1993-1990	1 Lead Sensor	234-1001	234-1000	-	-
V8-5.7	1999-1996		234-4019 <sup>1</sup>	234-4000 <sup>1</sup>	234-4018 <sup>1</sup>	234-4000 <sup>1</sup>
V8-5.7	1995-1983		234-1001	234-1000	-	-
V8-7.4	1999-1996		234-4019 <sup>1</sup>	234-4000 <sup>1</sup>	234-4018 <sup>1</sup>	234-4000 <sup>1</sup>
V8-7.4	1995-1983		234-1001	234-1000	-	-
<b>PRIZM</b>						
L4-1.8	2002-1998		234-4205	234-4207	234-4061	234-4209

<sup>1</sup> 2 Required / Requis 2 / Requeridos 2



ENGINE MOTEUR MOTOR	YEAR ANNEE AÑO	APPLICATION INFORMATION INFORMATION D'APPLICATION INFORMACION DE APLICACION	UPSTREAM / AVANT - C.C. / ANTES DEL C.C.		DOWNSTREAM / APRS - C.C. / DESPUES DEL C.C.	
			TYPE / TIPO O.E.	UNIVERS.	TYPE / TIPO O.E.	UNIVERS.
<b>CHEVROLET [cont]</b>						
<b>R10 SUBURBAN</b>						
V8-5.0	1987		234-1001	234-1000	-	-
V8-5.7	1988-1987		234-1001	234-1000	-	-
<b>R10 TRUCK</b>						
V6-4.3	1987		234-1001	234-1000	-	-
V8-5.0	1987		234-1001	234-1000	-	-
V8-5.7	1987		234-1001	234-1000	-	-
<b>R20 SUBURBAN</b>						
V8-5.7	1988-1987		234-1001	234-1000	-	-
V8-7.4	1988-1987		234-1001	234-1000	-	-
<b>R20 TRUCK</b>						
L6-4.8	1988-1987		234-1001	234-1000	-	-
V6-4.3	1987		234-1001	234-1000	-	-
V8-5.0	1987		234-1001	234-1000	-	-
V8-5.7	1988-1987		234-1001	234-1000	-	-
V8-7.4	1988-1987		234-1001	234-1000	-	-
<b>R30 TRUCK</b>						
L6-4.8	1988-1987		234-1001	234-1000	-	-
V8-5.7	1988-1987		234-1001	234-1000	-	-
V8-7.4	1988-1987		234-1001	234-1000	-	-
<b>R1500 SUBURBAN</b>						
V8-5.7	1991-1989		234-1001	234-1000	-	-
<b>R2500 SUBURBAN</b>						
V8-5.7	1991-1989		234-1001	234-1000	-	-
V8-7.4	1991-1989		234-1001	234-1000	-	-
<b>R2500 TRUCK</b>						
V8-5.7	1989		234-1001	234-1000	-	-
V8-7.4	1989		234-1001	234-1000	-	-
<b>R3500 TRUCK</b>						
V8-5.7	1991-1989		234-1001	234-1000	-	-
V8-7.4	1991-1989		234-1001	234-1000	-	-
<b>S10</b>						
L4-1.9	1985-1982		234-1001	234-1000	-	-
L4-2.0	1984-1983		234-1001	234-1000	-	-
L4-2.2	2003-2001		234-2060	234-2000	234-4087	234-4000
L4-2.2	2000-1999	Gas Engine	234-1023	234-1000	234-4087	234-4000
L4-2.2	2000	Flex Fuel Engine	234-2060	234-2000	234-4087	234-4000
L4-2.2	1998-1997		234-1001	234-1000	234-4087	234-4000
L4-2.2	1996		234-1001	234-1000	234-4012	234-4000
L4-2.2	1995-1994		234-1001	234-1000	-	-
L4-2.5	1993-1985		234-1001	234-1000	-	-



ENGINE MOTEUR MOTOR	YEAR ANNEE AÑO	APPLICATION INFORMATION INFORMATION D'APPLICATION INFORMACION DE APLICACION	UPSTREAM / AVANT - C.C. / ANTES DEL C.C.		DOWNSTREAM / APRS - C.C. / DESPUES DEL C.C.	
			TYPE / TIPO O.E.	UNIVERS.	TYPE / TIPO O.E.	UNIVERS.
<b>CHEVROLET [cont]</b>						
<b>S10 [cont]</b>						
V6-2.8	1993-1982		234-1001	234-1000	-	-
V6-4.3	2004-2003		234-4343 <sup>1</sup>	-	234-4343	-
V6-4.3	2002		234-4650 <sup>1</sup>	234-4209 <sup>1</sup>	234-4650	234-4209
V6-4.3	2001-1998		234-4012 <sup>1</sup>	234-4000 <sup>1</sup>	234-4012	234-4000
V6-4.3	1997-1996	Upstream Sensor in Manifold	234-4012 <sup>1</sup>	234-4000 <sup>1</sup>	234-4012	234-4000
V6-4.3	1997-1996	Upstream Sensor in Y Pipe	234-4012	234-4000	-	-
V6-4.3	1995-1994	3 Lead Sensor	234-3005	234-3000	-	-
V6-4.3	1995-1994	4 Lead Sensor	234-4012	234-4000	-	-
V6-4.3	1993-1992		234-3094	234-3090	-	-
V6-4.3	1991-1988		234-1001	234-1000	-	-
<b>S10 BLAZER</b>						
L4-1.9	1984-1983		234-1001	234-1000	-	-
L4-2.0	1984-1983		234-1001	234-1000	-	-
L4-2.5	1988-1985		234-1001	234-1000	-	-
V6-2.8	1989-1983		234-1001	234-1000	-	-
V6-4.3	1994	3 Lead Sensor	234-3005	234-3000	-	-
V6-4.3	1994	4 Lead Sensor	234-4012	234-4000	-	-
V6-4.3	1993-1992		234-3094	234-3090	-	-
V6-4.3	1991-1988		234-1001	234-1000	-	-
<b>SILVERADO 1500</b>						
V6-4.3	2015-2014		234-4940 <sup>1</sup>	-	234-4974 <sup>1</sup>	-
V6-4.3	2013-2008		234-4337 <sup>1</sup>	-	234-4258 <sup>1</sup>	-
V6-4.3	2007		234-4337 <sup>1</sup>	-	234-4112 <sup>1</sup>	234-4209 <sup>1</sup>
V6-4.3	2006-2003		234-4407 <sup>1</sup>	-	234-4407 <sup>1</sup>	-
V6-4.3	2002-1999	VIN W	234-4012 <sup>1</sup>	234-4000 <sup>1</sup>	234-4018 <sup>1</sup>	234-4000 <sup>1</sup>
V6-4.3	2002	VIN X	234-4650 <sup>1</sup>	234-4209 <sup>1</sup>	234-4650 <sup>1</sup>	234-4209 <sup>1</sup>
V8-4.8	2013-2008		234-4668 <sup>1</sup>	234-4212 <sup>1</sup>	234-4256 <sup>1</sup>	-
V8-4.8	2007		234-4337 <sup>1</sup>	-	234-4651 <sup>1</sup>	234-4209 <sup>1</sup>
V8-4.8	2006		234-4337 <sup>1</sup>	-	234-4112 <sup>1</sup>	234-4209 <sup>1</sup>
V8-4.8	2005-2003		234-4407 <sup>1</sup>	-	234-4407 <sup>1</sup>	-
V8-4.8	2002-2000	Canada Built	234-4650 <sup>1</sup>	234-4209 <sup>1</sup>	234-4650 <sup>1</sup>	234-4209 <sup>1</sup>
V8-4.8	2002-2000	Exc. Canada Built	234-4012 <sup>1</sup>	234-4000 <sup>1</sup>	234-4018 <sup>1</sup>	234-4000 <sup>1</sup>
V8-4.8	1999		234-4012 <sup>1</sup>	234-4000 <sup>1</sup>	234-4018 <sup>1</sup>	234-4000 <sup>1</sup>
V8-5.3	2015-2014		234-4940 <sup>1</sup>	-	234-4974 <sup>1</sup>	-
V8-5.3	2013-2008		234-4668 <sup>1</sup>	234-4212 <sup>1</sup>	234-4256 <sup>1</sup>	-
V8-5.3	2007		234-4668 <sup>1</sup>	234-4212 <sup>1</sup>	234-4651 <sup>1</sup>	234-4209 <sup>1</sup>
V8-5.3	2006		234-4337 <sup>1</sup>	-	234-4336 <sup>1</sup>	-
V8-5.3	2005-2003		234-4668 <sup>1</sup>	234-4212 <sup>1</sup>	234-4668 <sup>1</sup>	234-4212 <sup>1</sup>
V8-5.3	2002-2000	Canada Built	234-4650 <sup>1</sup>	234-4209 <sup>1</sup>	234-4650 <sup>1</sup>	234-4209 <sup>1</sup>
V8-5.3	2002-2000	Exc. Canada Built	234-4012 <sup>1</sup>	234-4000 <sup>1</sup>	234-4018 <sup>1</sup>	234-4000 <sup>1</sup>

<sup>1</sup> 2 Required / Requis 2 / Requeridos 2



ENGINE MOTEUR MOTOR	YEAR ANNEE AÑO	APPLICATION INFORMATION INFORMATION D'APPLICATION INFORMACION DE APLICACION	UPSTREAM / AVANT - C.C. / ANTES DEL C.C.		DOWNSTREAM / APRS - C.C. / DESPUES DEL C.C.	
			TYPE / TIPO O.E.	UNIVERS.	TYPE / TIPO O.E.	UNIVERS.
<b>CHEVROLET [cont]</b>						
<b>SILVERADO 1500 [cont]</b>						
V8-5.3	1999		234-4012 <sup>1</sup>	234-4000 <sup>1</sup>	234-4018 <sup>1</sup>	234-4000 <sup>1</sup>
V8-6.0	2013-2008		234-4668 <sup>1</sup>	234-4212 <sup>1</sup>	234-4256 <sup>1</sup>	-
V8-6.0	2007		234-4668 <sup>1</sup>	234-4212 <sup>1</sup>	234-4651 <sup>1</sup>	234-4209 <sup>1</sup>
V8-6.0	2006-2003		234-4669 <sup>1</sup>	234-4212 <sup>1</sup>	234-4407 <sup>1</sup>	-
V8-6.2	2015-2014		234-4940 <sup>1</sup>	-	234-4974 <sup>1</sup>	-
V8-6.2	2013-2009		234-4668 <sup>1</sup>	234-4212 <sup>1</sup>	234-4256 <sup>1</sup>	-
<b>SILVERADO 1500 CLASSIC</b>						
V6-4.3	2007		234-4337 <sup>1</sup>	-	234-4112 <sup>1</sup>	234-4209 <sup>1</sup>
V8-4.8	2007		234-4337 <sup>1</sup>	-	234-4112 <sup>1</sup>	234-4209 <sup>1</sup>
V8-5.3	2007		234-4337 <sup>1</sup>	-	234-4336 <sup>1</sup>	-
V8-6.0	2007		234-4669 <sup>4</sup>	234-4212 <sup>4</sup>	234-4286 <sup>4</sup>	-
V8-6.0	2007		234-4669 <sup>5</sup>	234-4212 <sup>5</sup>	234-4407 <sup>5</sup>	-
<b>SILVERADO 1500 HD</b>						
V8-6.0	2006-2005		234-4669 <sup>4</sup>	234-4212 <sup>4</sup>	234-4286 <sup>4</sup>	-
V8-6.0	2006-2005		234-4669 <sup>5</sup>	234-4212 <sup>5</sup>	234-4407 <sup>5</sup>	-
V8-6.0	2003		234-4669 <sup>4</sup>	234-4212 <sup>4</sup>	234-4286 <sup>4</sup>	-
V8-6.0	2003		234-4669 <sup>5</sup>	234-4212 <sup>5</sup>	234-4407 <sup>5</sup>	-
V8-6.0	2002		234-4103 <sup>4</sup>	234-4209 <sup>4</sup>	234-4286 <sup>4</sup>	-
V8-6.0	2002		234-4103 <sup>5</sup>	234-4209 <sup>5</sup>	234-4407 <sup>5</sup>	-
V8-6.0	2001		234-4103 <sup>4</sup>	234-4209 <sup>4</sup>	234-4024 <sup>4</sup>	234-4000 <sup>4</sup>
V8-6.0	2001		234-4103 <sup>5</sup>	234-4209 <sup>5</sup>	234-4018 <sup>5</sup>	234-4000 <sup>5</sup>
<b>SILVERADO 1500 HD CLASSIC</b>						
V8-6.0	2007		234-4669 <sup>4</sup>	234-4212 <sup>4</sup>	234-4286 <sup>4</sup>	-
V8-6.0	2007		234-4669 <sup>5</sup>	234-4212 <sup>5</sup>	234-4407 <sup>5</sup>	-
<b>SILVERADO 2500</b>						
V8-5.3	2000	Canada Built	234-4650 <sup>1</sup>	234-4209 <sup>1</sup>	234-4650 <sup>1</sup>	234-4209 <sup>1</sup>
V8-5.3	2000	Exc. Canada Built	234-4012 <sup>1</sup>	234-4000 <sup>1</sup>	234-4018 <sup>1</sup>	234-4000 <sup>1</sup>
V8-5.3	1999		234-4012 <sup>1</sup>	234-4000 <sup>1</sup>	234-4018 <sup>1</sup>	234-4000 <sup>1</sup>
V8-6.0	2004-2003		234-4669 <sup>4</sup>	234-4212 <sup>4</sup>	234-4286 <sup>4</sup>	-
V8-6.0	2004-2003		234-4669 <sup>5</sup>	234-4212 <sup>5</sup>	234-4407 <sup>5</sup>	-
V8-6.0	2002		234-4103 <sup>4</sup>	234-4209 <sup>4</sup>	234-4286 <sup>4</sup>	-
V8-6.0	2002		234-4103 <sup>5</sup>	234-4209 <sup>5</sup>	234-4407 <sup>5</sup>	-
V8-6.0	2001		234-4103 <sup>4</sup>	234-4209 <sup>4</sup>	234-4024 <sup>4</sup>	234-4000 <sup>4</sup>
V8-6.0	2001		234-4103 <sup>5</sup>	234-4209 <sup>5</sup>	234-4018 <sup>5</sup>	234-4000 <sup>5</sup>
V8-6.0	2000-1999		234-4019 <sup>4</sup>	234-4000 <sup>4</sup>	234-4024 <sup>4</sup>	234-4000 <sup>4</sup>
V8-6.0	2000-1999		234-4019 <sup>5</sup>	234-4000 <sup>5</sup>	234-4018 <sup>5</sup>	234-4000 <sup>5</sup>
<b>SILVERADO 2500 HD</b>						
V8-6.0	2015-2013		234-4563 <sup>1</sup>	-	234-4256 <sup>1</sup>	-
V8-6.0	2012-2011	Cab & Chassis	234-4669 <sup>1</sup>	234-4212 <sup>1</sup>	234-4256 <sup>1</sup>	-

<sup>1</sup> 2 Required / Requis 2 / Requeridos 2 <sup>4</sup> Left Side / Côté gauche / Lado izquierdo <sup>5</sup> Right Side / Côté droit / Lado derecho



ENGINE MOTEUR MOTOR	YEAR ANNEE AÑO	APPLICATION INFORMATION INFORMATION D'APPLICATION INFORMACION DE APLICACION	UPSTREAM / AVANT - C.C. / ANTES DEL C.C.		DOWNSTREAM / APRES - C.C. / DESPUES DEL C.C.	
			TYPE / TIPO O.E.	UNIVERS.	TYPE / TIPO O.E.	UNIVERS.
<b>CHEVROLET [cont]</b>						
<b>SILVERADO 2500 HD [cont]</b>						
V8-6.0	2012	Pickup; Flex Fuel Engine	234-4669 <sup>1</sup>	-	234-4256 <sup>1</sup>	-
V8-6.0	2012	Pickup; Gas Engine	234-4563 <sup>1</sup>	-	234-4256 <sup>1</sup>	-
V8-6.0	2011-2008	Pickup	234-4668 <sup>1</sup>	234-4212 <sup>1</sup>	234-4256 <sup>1</sup>	-
V8-6.0	2010-2008	Cab & Chassis	234-4669 <sup>4</sup>	234-4212 <sup>4</sup>	234-4252 <sup>4</sup>	-
V8-6.0	2010-2008	Cab & Chassis	234-4669 <sup>5</sup>	234-4212 <sup>5</sup>	234-4256 <sup>5</sup>	-
V8-6.0	2007	VIN K; Cab & Chassis	234-4669 <sup>4</sup>	234-4212 <sup>4</sup>	234-4286 <sup>4</sup>	-
V8-6.0	2007	VIN K; Cab & Chassis	234-4669 <sup>5</sup>	234-4212 <sup>5</sup>	234-4407 <sup>5</sup>	-
V8-6.0	2007	VIN K; Pickup	234-4668 <sup>1</sup>	234-4212 <sup>1</sup>	234-4651 <sup>1</sup>	234-4209 <sup>1</sup>
V8-6.0	2006-2003	VIN U	234-4669 <sup>4</sup>	234-4212 <sup>4</sup>	234-4286 <sup>4</sup>	-
V8-6.0	2006-2003	VIN U	234-4669 <sup>5</sup>	234-4212 <sup>5</sup>	234-4407 <sup>5</sup>	-
V8-6.0	2002		234-4103 <sup>4</sup>	234-4209 <sup>4</sup>	234-4286 <sup>4</sup>	-
V8-6.0	2002		234-4103 <sup>5</sup>	234-4209 <sup>5</sup>	234-4407 <sup>5</sup>	-
V8-6.0	2001		234-4103 <sup>4</sup>	234-4209 <sup>4</sup>	234-4024 <sup>4</sup>	234-4000 <sup>4</sup>
V8-6.0	2001		234-4103 <sup>5</sup>	234-4209 <sup>5</sup>	234-4018 <sup>5</sup>	234-4000 <sup>5</sup>
V8-8.1	2006-2003		234-4669 <sup>4</sup>	234-4212 <sup>4</sup>	234-4673 <sup>4</sup>	234-4212 <sup>4</sup>
V8-8.1	2006-2003		234-4669 <sup>5</sup>	234-4212 <sup>5</sup>	234-4669 <sup>5</sup>	234-4212 <sup>5</sup>
V8-8.1	2002-2001		234-4103 <sup>4</sup>	234-4209 <sup>4</sup>	234-4102 <sup>4</sup>	234-4209 <sup>4</sup>
V8-8.1	2002-2001		234-4103 <sup>5</sup>	234-4209 <sup>5</sup>	234-4103 <sup>5</sup>	234-4209 <sup>5</sup>
<b>SILVERADO 2500 HD CLASSIC</b>						
V8-6.0	2007		234-4669 <sup>4</sup>	234-4212 <sup>4</sup>	234-4286 <sup>4</sup>	-
V8-6.0	2007		234-4669 <sup>5</sup>	234-4212 <sup>5</sup>	234-4407 <sup>5</sup>	-
V8-8.1	2007		234-4669 <sup>4</sup>	234-4212 <sup>4</sup>	234-4673 <sup>4</sup>	234-4212 <sup>4</sup>
V8-8.1	2007		234-4669 <sup>5</sup>	234-4212 <sup>5</sup>	234-4669 <sup>5</sup>	234-4212 <sup>5</sup>
<b>SILVERADO 3500</b>						
V8-6.0	2006-2003		234-4669 <sup>4</sup>	234-4212 <sup>4</sup>	234-4286 <sup>4</sup>	-
V8-6.0	2006-2003		234-4669 <sup>5</sup>	234-4212 <sup>5</sup>	234-4407 <sup>5</sup>	-
V8-6.0	2002		234-4103 <sup>4</sup>	234-4209 <sup>4</sup>	234-4286 <sup>4</sup>	-
V8-6.0	2002		234-4103 <sup>5</sup>	234-4209 <sup>5</sup>	234-4407 <sup>5</sup>	-
V8-6.0	2001		234-4103 <sup>4</sup>	234-4209 <sup>4</sup>	234-4024 <sup>4</sup>	234-4000 <sup>4</sup>
V8-6.0	2001		234-4103 <sup>5</sup>	234-4209 <sup>5</sup>	234-4018 <sup>5</sup>	234-4000 <sup>5</sup>
V8-8.1	2006-2003		234-4669 <sup>4</sup>	234-4212 <sup>4</sup>	234-4673 <sup>4</sup>	234-4212 <sup>4</sup>
V8-8.1	2006-2003		234-4669 <sup>5</sup>	234-4212 <sup>5</sup>	234-4669 <sup>5</sup>	234-4212 <sup>5</sup>
V8-8.1	2002-2001		234-4103 <sup>4</sup>	234-4209 <sup>4</sup>	234-4102 <sup>4</sup>	234-4209 <sup>4</sup>
V8-8.1	2002-2001		234-4103 <sup>5</sup>	234-4209 <sup>5</sup>	234-4103 <sup>5</sup>	234-4209 <sup>5</sup>
<b>SILVERADO 3500 CLASSIC</b>						
V8-6.0	2007		234-4669 <sup>4</sup>	234-4212 <sup>4</sup>	234-4286 <sup>4</sup>	-
V8-6.0	2007		234-4669 <sup>5</sup>	234-4212 <sup>5</sup>	234-4407 <sup>5</sup>	-
V8-8.1	2007		234-4669 <sup>4</sup>	234-4212 <sup>4</sup>	234-4673 <sup>4</sup>	234-4212 <sup>4</sup>
V8-8.1	2007		234-4669 <sup>5</sup>	234-4212 <sup>5</sup>	234-4669 <sup>5</sup>	234-4212 <sup>5</sup>

<sup>1</sup> 2 Required / Requis 2 / Requeridos 2 <sup>4</sup> Left Side / Côté gauche / Lado izquierdo <sup>5</sup> Right Side / Côté droit / Lado derecho



ENGINE MOTEUR MOTOR	YEAR ANNEE AÑO	APPLICATION INFORMATION INFORMATION D'APPLICATION INFORMACION DE APLICACION	UPSTREAM / AVANT - C.C. / ANTES DEL C.C.		DOWNSTREAM / APRS - C.C. / DESPUES DEL C.C.	
			TYPE / TIPO O.E.	UNIVERS.	TYPE / TIPO O.E.	UNIVERS.
<b>CHEVROLET [cont]</b>						
<b>SILVERADO 3500 HD</b>						
V8-6.0	2015		234-4563 <sup>1</sup>	-	234-4256 <sup>1</sup>	-
V8-6.0	2014-2012	Pickup	234-4563 <sup>1</sup>	-	234-4256 <sup>1</sup>	-
V8-6.0	2014-2011	Cab & Chassis	234-4669 <sup>1</sup>	234-4212 <sup>1</sup>	234-4256 <sup>1</sup>	-
V8-6.0	2011-2008	Pickup	234-4668 <sup>1</sup>	234-4212 <sup>1</sup>	234-4256 <sup>1</sup>	-
V8-6.0	2010-2008	Cab & Chassis	234-4669 <sup>4</sup>	234-4212 <sup>4</sup>	234-4252 <sup>4</sup>	-
V8-6.0	2010-2008	Cab & Chassis	234-4669 <sup>5</sup>	234-4212 <sup>5</sup>	234-4256 <sup>5</sup>	-
V8-6.0	2007	Cab & Chassis	234-4669 <sup>4</sup>	234-4212 <sup>4</sup>	234-4286 <sup>4</sup>	-
V8-6.0	2007	Cab & Chassis	234-4669 <sup>5</sup>	234-4212 <sup>5</sup>	234-4407 <sup>5</sup>	-
V8-6.0	2007	Pickup	234-4668 <sup>1</sup>	234-4212 <sup>1</sup>	234-4651 <sup>1</sup>	234-4209 <sup>1</sup>
<b>SONIC</b>						
L4-1.4	2015		234-4527	-	234-4528	-
L4-1.4	2014		234-4780	-	234-4528	-
L4-1.4	2013	1st Design; Upstream Sensor w/ Black Sleeve	234-4529	-	234-4528	-
L4-1.4	2013	2nd Design; Upstream Sensor w/ Grey Sleeve	234-4780	-	234-4528	-
L4-1.4	2012		234-4529	-	234-4528	-
L4-1.8	2015-2012		234-4527	-	234-4528	-
<b>SPARK</b>						
L4-1.2	2015-2013	Auto Trans	234-4765	-	234-4773	-
L4-1.2	2015-2013	Manual Trans	234-4765	-	234-4774	-
<b>SPECTRUM</b>						
L4-1.5	1988-1985		234-1001	234-1000	-	-
<b>SPRINT</b>						
L3-1.0	1992-1987		234-1001	234-1000	-	-
L3-1.0	1986-1985		234-1009	234-1000	-	-
<b>SS</b>						
V8-6.2	2015-2014		234-4669 <sup>1</sup>	234-4212 <sup>1</sup>	234-4256 <sup>1</sup>	-
<b>SSR</b>						
V8-5.3	2004-2003		234-4650 <sup>1</sup>	234-4209 <sup>1</sup>	234-4647 <sup>1</sup>	234-4209 <sup>1</sup>
V8-6.0	2006	1st Design; Square Downstream Connector	234-4339 <sup>1</sup>	-	234-4285 <sup>1</sup>	-
V8-6.0	2006	2nd Design; Triangular Downstream Connector	234-4339 <sup>1</sup>	-	234-4561 <sup>1</sup>	-
V8-6.0	2005		234-4668 <sup>1</sup>	234-4212 <sup>1</sup>	234-4651 <sup>1</sup>	234-4209 <sup>1</sup>
<b>SUBURBAN</b>						
V8-5.3	2015		234-4940 <sup>1</sup>	-	234-4974 <sup>1</sup>	-
<b>SUBURBAN 1500</b>						
V8-5.3	2014-2008		234-4668 <sup>1</sup>	234-4212 <sup>1</sup>	234-4256 <sup>1</sup>	-
V8-5.3	2007		234-4337 <sup>1</sup>	-	234-4112 <sup>1</sup>	234-4209 <sup>1</sup>
V8-5.3	2006		234-4337 <sup>1</sup>	-	234-4336 <sup>1</sup>	-
V8-5.3	2005-2003		234-4668 <sup>1</sup>	234-4212 <sup>1</sup>	234-4668 <sup>1</sup>	234-4212 <sup>1</sup>

<sup>1</sup> 2 Required / Requis 2 / Requeridos 2 <sup>4</sup> Left Side / Côté gauche / Lado izquierdo <sup>5</sup> Right Side / Côté droit / Lado derecho



ENGINE MOTEUR MOTOR	YEAR ANNEE AÑO	APPLICATION INFORMATION INFORMATION D'APPLICATION INFORMACION DE APLICACION	UPSTREAM / AVANT - C.C. / ANTES DEL C.C.		DOWNSTREAM / APRS - C.C. / DESPUES DEL C.C.	
			TYPE / TIPO O.E.	UNIVERS.	TYPE / TIPO O.E.	UNIVERS.
<b>CHEVROLET [cont]</b>						
<b>SUBURBAN 1500 [cont]</b>						
V8-5.3	2002-2000	Canada Built	234-4650 <sup>1</sup>	234-4209 <sup>1</sup>	234-4650 <sup>1</sup>	234-4209 <sup>1</sup>
V8-5.3	2002-2000	Exc. Canada Built	234-4012 <sup>1</sup>	234-4000 <sup>1</sup>	234-4018 <sup>1</sup>	234-4000 <sup>1</sup>
V8-6.0	2009-2008		234-4668 <sup>1</sup>	234-4212 <sup>1</sup>	234-4256 <sup>1</sup>	-
V8-6.0	2007		234-4337 <sup>1</sup>	-	234-4112 <sup>1</sup>	234-4209 <sup>1</sup>
V8-6.0	2006		234-4669 <sup>1</sup>	234-4212 <sup>1</sup>	234-4407 <sup>1</sup>	-
<b>SUBURBAN 2500</b>						
V8-6.0	2013		234-4668 <sup>1</sup>	234-4212 <sup>1</sup>	234-4256 <sup>1</sup>	-
V8-6.0	2012		234-4563 <sup>1</sup>	-	234-4256 <sup>1</sup>	-
V8-6.0	2011-2008		234-4668 <sup>1</sup>	234-4212 <sup>1</sup>	234-4256 <sup>1</sup>	-
V8-6.0	2007		234-4337 <sup>1</sup>	-	234-4112 <sup>1</sup>	234-4209 <sup>1</sup>
V8-6.0	2006-2004		234-4669 <sup>4</sup>	234-4212 <sup>4</sup>	234-4286 <sup>4</sup>	-
V8-6.0	2006-2004		234-4669 <sup>5</sup>	234-4212 <sup>5</sup>	234-4407 <sup>5</sup>	-
V8-6.0	2003	Calif.	234-4669 <sup>4</sup>	234-4212 <sup>4</sup>	234-4286 <sup>4</sup>	-
V8-6.0	2003	Calif.	234-4669 <sup>5</sup>	234-4212 <sup>5</sup>	234-4407 <sup>5</sup>	-
V8-6.0	2003	Exc. Calif.	234-4669 <sup>1</sup>	234-4212 <sup>1</sup>	234-4407 <sup>1</sup>	-
V8-6.0	2002		234-4103 <sup>4</sup>	234-4209 <sup>4</sup>	234-4286 <sup>4</sup>	-
V8-6.0	2002		234-4103 <sup>5</sup>	234-4209 <sup>5</sup>	234-4407 <sup>5</sup>	-
V8-6.0	2001		234-4103 <sup>4</sup>	234-4209 <sup>4</sup>	234-4024 <sup>4</sup>	234-4000 <sup>4</sup>
V8-6.0	2001		234-4103 <sup>5</sup>	234-4209 <sup>5</sup>	234-4018 <sup>5</sup>	234-4000 <sup>5</sup>
V8-6.0	2000		234-4019 <sup>4</sup>	234-4000 <sup>4</sup>	234-4024 <sup>4</sup>	234-4000 <sup>4</sup>
V8-6.0	2000		234-4019 <sup>5</sup>	234-4000 <sup>5</sup>	234-4018 <sup>5</sup>	234-4000 <sup>5</sup>
V8-8.1	2006-2003		234-4669 <sup>4</sup>	234-4212 <sup>4</sup>	234-4673 <sup>4</sup>	234-4212 <sup>4</sup>
V8-8.1	2006-2003		234-4669 <sup>5</sup>	234-4212 <sup>5</sup>	234-4669 <sup>5</sup>	234-4212 <sup>5</sup>
V8-8.1	2002-2001		234-4103 <sup>4</sup>	234-4209 <sup>4</sup>	234-4102 <sup>4</sup>	234-4209 <sup>4</sup>
V8-8.1	2002-2001		234-4103 <sup>5</sup>	234-4209 <sup>5</sup>	234-4103 <sup>5</sup>	234-4209 <sup>5</sup>
<b>TAHOE</b>						
V8-4.8	2009-2008		234-4668 <sup>1</sup>	234-4212 <sup>1</sup>	234-4256 <sup>1</sup>	-
V8-4.8	2007-2006		234-4337 <sup>1</sup>	-	234-4112 <sup>1</sup>	234-4209 <sup>1</sup>
V8-4.8	2005-2003		234-4407 <sup>1</sup>	-	234-4407 <sup>1</sup>	-
V8-4.8	2002-2000	Canada Built	234-4650 <sup>1</sup>	234-4209 <sup>1</sup>	234-4650 <sup>1</sup>	234-4209 <sup>1</sup>
V8-4.8	2002-2000	Exc. Canada Built	234-4012 <sup>1</sup>	234-4000 <sup>1</sup>	234-4018 <sup>1</sup>	234-4000 <sup>1</sup>
V8-5.3	2015		234-4940 <sup>1</sup>	-	234-4974 <sup>1</sup>	-
V8-5.3	2014-2008		234-4668 <sup>1</sup>	234-4212 <sup>1</sup>	234-4256 <sup>1</sup>	-
V8-5.3	2007		234-4337 <sup>1</sup>	-	234-4112 <sup>1</sup>	234-4209 <sup>1</sup>
V8-5.3	2006		234-4337 <sup>1</sup>	-	234-4336 <sup>1</sup>	-
V8-5.3	2005-2003		234-4668 <sup>1</sup>	234-4212 <sup>1</sup>	234-4668 <sup>1</sup>	234-4212 <sup>1</sup>
V8-5.3	2002-2000	Canada Built	234-4650 <sup>1</sup>	234-4209 <sup>1</sup>	234-4650 <sup>1</sup>	234-4209 <sup>1</sup>
V8-5.3	2002-2000	Exc. Canada Built	234-4012 <sup>1</sup>	234-4000 <sup>1</sup>	234-4018 <sup>1</sup>	234-4000 <sup>1</sup>
V8-5.7	2000		234-4012 <sup>1</sup>	234-4000 <sup>1</sup>	234-4018 <sup>1</sup>	234-4000 <sup>1</sup>

<sup>1</sup> 2 Required / Requis 2 / Requeridos 2 <sup>4</sup> Left Side / Côté gauche / Lado izquierdo <sup>5</sup> Right Side / Côté droit / Lado derecho





ENGINE MOTEUR MOTOR	YEAR ANNEE AÑO	APPLICATION INFORMATION INFORMATION D'APPLICATION INFORMACION DE APLICACION	UPSTREAM / AVANT - C.C. / ANTES DEL C.C.		DOWNSTREAM / APRES - C.C. / DESPUES DEL C.C.	
			TYPE / TIPO O.E.	UNIVERS.	TYPE / TIPO O.E.	UNIVERS.
<b>CHEVROLET [cont]</b>						
<b>TAHOE [cont]</b>						
V8-5.7	1999-1997	Trans Code 4L60E	234-4012 <sup>1</sup>	234-4000 <sup>1</sup>	234-4018 <sup>1</sup>	234-4000 <sup>1</sup>
V8-5.7	1999-1997	Trans Code 4L80E	234-4019 <sup>1</sup>	234-4000 <sup>1</sup>	234-4018 <sup>1</sup>	234-4000 <sup>1</sup>
V8-5.7	1996	Auto Trans; Trans Code 4L60E	234-4012 <sup>1</sup>	234-4000 <sup>1</sup>	234-4018 <sup>1</sup>	234-4000 <sup>1</sup>
V8-5.7	1996	Auto Trans; Trans Code 4L80E	234-4019 <sup>1</sup>	234-4000 <sup>1</sup>	234-4018 <sup>1</sup>	234-4000 <sup>1</sup>
V8-5.7	1996	Manual Trans	234-4019 <sup>1</sup>	234-4000 <sup>1</sup>	234-4018 <sup>1</sup>	234-4000 <sup>1</sup>
V8-5.7	1995	1 Lead Sensor	234-1001	234-1000	-	-
V8-5.7	1995	3 Lead Sensor	234-3011	234-3000	-	-
V8-6.0	2013-2008		234-4668 <sup>1</sup>	234-4212 <sup>1</sup>	234-4256 <sup>1</sup>	-
V8-6.2	2009-2008		234-4668 <sup>1</sup>	234-4212 <sup>1</sup>	234-4256 <sup>1</sup>	-
<b>TRACKER</b>						
L4-1.6	2002-2001		234-4731	-	234-4222	234-4209
L4-1.6	2000-1999	Calif.	234-4129	234-4212	234-4648	234-4209
L4-1.6	2000-1999	Exc. Calif.	234-4049	234-4209	234-4649	234-4209
L4-1.6	1998		234-4060	234-4209	234-4649	234-4209
L4-1.6	1991		234-3004	234-3000	-	-
L4-1.6	1990-1989		234-1009	234-1000	-	-
L4-2.0	2003-2001		234-4731	-	234-4222	234-4209
L4-2.0	2000-1999	Calif.	234-4129	234-4212	234-4648	234-4209
L4-2.0	2000-1999	Exc. Calif.	234-4049	234-4209	234-4649	234-4209
V6-2.5	2004-2001		234-4105 <sup>1</sup>	-	234-4080 <sup>1</sup>	234-4210 <sup>1</sup>
<b>TRAILBLAZER</b>						
L6-4.2	2009-2007		234-4331	-	234-4294	-
L6-4.2	2006		234-4331	-	234-4348	-
L6-4.2	2005-2004		234-4119	-	234-4285	-
L6-4.2	2003-2002		234-4112	234-4209	234-4285	-
V8-5.3	2008		234-4339 <sup>4</sup>	-	234-4246 <sup>4</sup>	-
V8-5.3	2008		234-4339 <sup>5</sup>	-	234-4243 <sup>5</sup>	-
V8-5.3	2007		234-4339 <sup>1</sup>	-	234-4561 <sup>1</sup>	-
V8-5.3	2006	1st Design; Square Downstream Connector	234-4339 <sup>1</sup>	-	234-4285 <sup>1</sup>	-
V8-5.3	2006	2nd Design; Triangular Downstream Connector	234-4339 <sup>1</sup>	-	234-4561 <sup>1</sup>	-
V8-6.0	2009-2008		234-4339 <sup>4</sup>	-	234-4246 <sup>4</sup>	-
V8-6.0	2009-2008		234-4339 <sup>5</sup>	-	234-4243 <sup>5</sup>	-
V8-6.0	2007		234-4339 <sup>1</sup>	-	234-4561 <sup>1</sup>	-
V8-6.0	2006	1st Design; Square Downstream Connector	234-4339 <sup>1</sup>	-	234-4285 <sup>1</sup>	-
V8-6.0	2006	2nd Design; Triangular Downstream Connector	234-4339 <sup>1</sup>	-	234-4561 <sup>1</sup>	-
<b>TRAILBLAZER EXT</b>						
L6-4.2	2006		234-4331	-	234-4348	-
L6-4.2	2005-2004		234-4119	-	234-4285	-
L6-4.2	2003-2002		234-4112	234-4209	234-4285	-
V8-5.3	2006	1st Design; Downstream OE PN 19209805	234-4339 <sup>1</sup>	-	234-4285 <sup>1</sup>	-

<sup>1</sup> 2 Required / Requis 2 / Requeridos 2 <sup>4</sup> Left Side / Côté gauche / Lado izquierdo <sup>5</sup> Right Side / Côté droit / Lado derecho



ENGINE MOTEUR MOTOR	YEAR ANNEE AÑO	APPLICATION INFORMATION INFORMATION D'APPLICATION INFORMACION DE APLICACION	UPSTREAM / AVANT - C.C. / ANTES DEL C.C.		DOWNSTREAM / APRS - C.C. / DESPUES DEL C.C.	
			TYPE / TIPO O.E.	UNIVERS.	TYPE / TIPO O.E.	UNIVERS.
<b>CHEVROLET [cont]</b>						
<b>TRAILBLAZER EXT [cont]</b>						
V8-5.3	2006	2nd Design; Downstream OE PN 19209816	234-4339 <sup>1</sup>	-	234-4561 <sup>1</sup>	-
V8-5.3	2005		234-4668 <sup>1</sup>	234-4212 <sup>1</sup>	234-4651 <sup>1</sup>	234-4209 <sup>1</sup>
V8-5.3	2004-2003		234-4650 <sup>1</sup>	234-4209 <sup>1</sup>	234-4647 <sup>1</sup>	234-4209 <sup>1</sup>
<b>TRAVERSE</b>						
V6-3.6	2015-2012		234-4565 <sup>1</sup>	-	234-4566 <sup>1</sup>	-
V6-3.6	2011-2009		234-4815 <sup>1</sup>	-	234-4816 <sup>1</sup>	-
<b>TRAX</b>						
L4-1.4	2015		234-4780	-	234-4821	-
L4-1.4	2014		234-4780	-	234-4528	-
L4-1.4	2013	1st Design; Upstream Sensor w/ Black Sleeve	234-4529	-	234-4528	-
L4-1.4	2013	2nd Design; Upstream Sensor w/ Grey Sleeve	234-4780	-	234-4528	-
<b>UPLANDER</b>						
V6-3.5	2006-2005		234-4668	234-4212	234-4647	234-4209
V6-3.9	2009-2008		234-4668	234-4212	234-4255	-
V6-3.9	2007-2006		234-4668	234-4212	234-4647	234-4209
<b>V10 SUBURBAN</b>						
V8-5.7	1988-1987		234-1001	234-1000	-	-
<b>V10 TRUCK</b>						
V6-4.3	1987		234-1001	234-1000	-	-
V8-5.0	1987		234-1001	234-1000	-	-
V8-5.7	1987		234-1001	234-1000	-	-
<b>V20 SUBURBAN</b>						
V8-5.7	1988-1987		234-1001	234-1000	-	-
V8-7.4	1988-1987		234-1001	234-1000	-	-
<b>V20 TRUCK</b>						
L6-4.8	1987		234-1001	234-1000	-	-
V8-5.7	1987		234-1001	234-1000	-	-
<b>V30 TRUCK</b>						
L6-4.8	1988-1987		234-1001	234-1000	-	-
V8-5.7	1988-1987		234-1001	234-1000	-	-
V8-7.4	1988-1987		234-1001	234-1000	-	-
<b>V1500 SUBURBAN</b>						
V8-5.7	1991-1989		234-1001	234-1000	-	-
<b>V2500 SUBURBAN</b>						
V8-5.7	1991-1989		234-1001	234-1000	-	-
V8-7.4	1990		234-1001	234-1000	-	-
<b>V3500 TRUCK</b>						
V8-5.7	1991-1989		234-1001	234-1000	-	-
V8-7.4	1991-1989		234-1001	234-1000	-	-

<sup>1</sup> 2 Required / Requis 2 / Requeridos 2



ENGINE MOTEUR MOTOR	YEAR ANNEE AÑO	APPLICATION INFORMATION INFORMATION D'APPLICATION INFORMACION DE APLICACION	UPSTREAM / AVANT - C.C. / ANTES DEL C.C.		DOWNSTREAM / APRS - C.C. / DESPUES DEL C.C.	
			TYPE / TIPO O.E.	UNIVERS.	TYPE / TIPO O.E.	UNIVERS.
<b>CHEVROLET [cont]</b>						
<b>VENTURE</b>						
V6-3.4	2005		234-4343	-	234-4647	234-4209
V6-3.4	2004-2001		234-4650	234-4209	234-4087	234-4000
V6-3.4	2000-1997		234-4018	234-4000	234-4087	234-4000
<b>VOLT</b>						
L4-1.4	2015-2011		234-4529	-	234-4815	-
<b>CHRYSLER</b>						
<b>200</b>						
L4-2.4	2015		234-5150	-	234-4545	-
L4-2.4	2014-2011		234-4547	-	234-4547	-
V6-3.6	2015		234-4547 <sup>1</sup>	-	234-4545 <sup>1</sup>	-
V6-3.6	2014-2012		234-4545 <sup>4</sup>	-	234-4547 <sup>4</sup>	-
V6-3.6	2014-2012		234-4545 <sup>5</sup>	-	234-4545 <sup>5</sup>	-
V6-3.6	2011		234-4545 <sup>1</sup>	-	234-4545 <sup>1</sup>	-
<b>300</b>						
V6-2.7	2010-2007		234-4587 <sup>4</sup>	-	234-4587 <sup>4</sup>	-
V6-2.7	2010-2007		234-4587 <sup>5</sup>	-	234-4588 <sup>5</sup>	-
V6-2.7	2006-2005		234-4587 <sup>1</sup>	-	234-4587 <sup>1</sup>	-
V6-3.5	2010-2009		234-4587 <sup>4</sup>	-	234-4587 <sup>4</sup>	-
V6-3.5	2010-2009		234-4587 <sup>5</sup>	-	234-4588 <sup>5</sup>	-
V6-3.5	2008		234-4587 <sup>1</sup>	-	234-4587 <sup>1</sup>	-
V6-3.5	2007	Calif.	234-4587 <sup>4</sup>	-	234-4587 <sup>4</sup>	-
V6-3.5	2007	Calif.	234-4587 <sup>5</sup>	-	234-4588 <sup>5</sup>	-
V6-3.5	2007	Exc. Calif.	234-4587 <sup>1</sup>	-	234-4587 <sup>1</sup>	-
V6-3.5	2006-2005		234-4587 <sup>1</sup>	-	234-4587 <sup>1</sup>	-
V6-3.6	2014		234-4545 <sup>4</sup>	-	234-4545 <sup>4</sup>	-
V6-3.6	2014		234-4545 <sup>5</sup>	-	234-4547 <sup>5</sup>	-
V6-3.6	2013-2011		234-4545 <sup>1</sup>	-	234-4545 <sup>1</sup>	-
V8-5.7	2014-2013		234-4545 <sup>1</sup>	-	234-4545 <sup>1</sup>	-
V8-5.7	2012	Flex Fuel Engine	234-4545 <sup>1</sup>	-	234-4545 <sup>1</sup>	-
V8-5.7	2012	Gas Engine	234-4587 <sup>1</sup>	-	234-4587 <sup>1</sup>	-
V8-5.7	2011-2008		234-4587 <sup>1</sup>	-	234-4587 <sup>1</sup>	-
V8-5.7	2007	From 07/28/06	234-4418 <sup>4</sup>	-	234-4587 <sup>4</sup>	-
V8-5.7	2007	From 07/28/06	234-4418 <sup>5</sup>	-	234-4588 <sup>5</sup>	-
V8-5.7	2007	To 07/28/06	234-4587 <sup>4</sup>	-	234-4587 <sup>4</sup>	-
V8-5.7	2007	To 07/28/06	234-4587 <sup>5</sup>	-	234-4588 <sup>5</sup>	-
V8-5.7	2006-2005		234-4593 <sup>4</sup>	-	234-4587 <sup>4</sup>	-
V8-5.7	2006-2005		234-4593 <sup>5</sup>	-	234-4588 <sup>5</sup>	-

<sup>1</sup> 2 Required / Requis 2 / Requeridos 2 <sup>4</sup> Left Side / Côté gauche / Lado izquierdo <sup>5</sup> Right Side / Côté droit / Lado derecho



ENGINE MOTEUR MOTOR	YEAR ANNEE AÑO	APPLICATION INFORMATION INFORMATION D'APPLICATION INFORMACION DE APLICACION	UPSTREAM / AVANT - C.C. / ANTES DEL C.C.		DOWNSTREAM / APRES - C.C. / DESPUES DEL C.C.	
			TYPE / TIPO O.E.	UNIVERS.	TYPE / TIPO O.E.	UNIVERS.
<b>CHRYSLER [cont]</b>						
<b>300 [cont]</b>						
V8-6.1	2010-2008		234-4587 <sup>1</sup>	-	234-4587 <sup>1</sup>	-
V8-6.1	2007	From 07/28/06	234-4418 <sup>4</sup>	-	234-4587 <sup>4</sup>	-
V8-6.1	2007	From 07/28/06	234-4418 <sup>5</sup>	-	234-4588 <sup>5</sup>	-
V8-6.1	2007	To 07/28/06	234-4587 <sup>4</sup>	-	234-4587 <sup>4</sup>	-
V8-6.1	2007	To 07/28/06	234-4587 <sup>5</sup>	-	234-4588 <sup>5</sup>	-
V8-6.1	2006-2005		234-4593 <sup>4</sup>	-	234-4587 <sup>4</sup>	-
V8-6.1	2006-2005		234-4593 <sup>5</sup>	-	234-4588 <sup>5</sup>	-
V8-6.4	2014-2013		234-4545 <sup>1</sup>	-	234-4545 <sup>1</sup>	-
V8-6.4	2012		234-4587 <sup>1</sup>	-	234-4587 <sup>1</sup>	-
<b>300M</b>						
V6-3.5	2004-2002		234-4592 <sup>1</sup>	-	234-4078 <sup>1</sup>	234-4210 <sup>1</sup>
V6-3.5	2001-1999		234-4078 <sup>1</sup>	234-4210 <sup>1</sup>	234-4078 <sup>1</sup>	234-4210 <sup>1</sup>
<b>ASPEN</b>						
V8-4.7	2009-2008		234-4587 <sup>1</sup>	-	234-4588 <sup>1</sup>	-
V8-4.7	2007		234-4744 <sup>1</sup>	234-4212 <sup>1</sup>	234-4756 <sup>1</sup>	234-4212 <sup>1</sup>
V8-5.7	2009	Gas Engine	234-4587 <sup>1</sup>	-	234-4587 <sup>1</sup>	-
V8-5.7	2009	Hybrid Engine	234-4588 <sup>1</sup>	-	234-4588 <sup>1</sup>	-
V8-5.7	2008-2007		234-4587 <sup>1</sup>	-	234-4587 <sup>1</sup>	-
<b>CIRRUS</b>						
L4-2.0	2000		234-4078	234-4210	234-4079	234-4210
L4-2.4	2000-1999		234-4078	234-4210	234-4079	234-4210
L4-2.4	1997		234-4077	234-4210	234-4002	234-4210
L4-2.4	1996-1995		234-4004	234-4210	234-4002	234-4210
V6-2.5	2000-1998		234-4079	234-4210	234-4079	234-4210
V6-2.5	1997		234-4005	234-4210	234-4002	234-4210
V6-2.5	1996-1995		234-4002	234-4210	234-4002	234-4210
<b>CONCORDE</b>						
V6-2.7	2004-2002		234-4592 <sup>1</sup>	-	234-4078 <sup>1</sup>	234-4210 <sup>1</sup>
V6-2.7	2001-1998		234-4078 <sup>1</sup>	234-4210 <sup>1</sup>	234-4078 <sup>1</sup>	234-4210 <sup>1</sup>
V6-3.2	2001-1998		234-4078 <sup>1</sup>	234-4210 <sup>1</sup>	234-4078 <sup>1</sup>	234-4210 <sup>1</sup>
V6-3.3	1996	w/ 17" Downstream Sensor	234-4077	234-4210	234-4002	234-4210
V6-3.3	1996	w/ 22" Downstream Sensor	234-4077	234-4210	234-4003	234-4210
V6-3.3	1995-1993		234-4004	234-4210	-	-
V6-3.5	2004-2002		234-4592 <sup>1</sup>	-	234-4078 <sup>1</sup>	234-4210 <sup>1</sup>
V6-3.5	1997-1996	w/ 17" Downstream Sensor	234-4077 <sup>1</sup>	234-4210 <sup>1</sup>	234-4002 <sup>1</sup>	234-4210 <sup>1</sup>
V6-3.5	1997-1996	w/ 22" Downstream Sensor	234-4077 <sup>1</sup>	234-4210 <sup>1</sup>	234-4003 <sup>1</sup>	234-4210 <sup>1</sup>
V6-3.5	1995-1994	Square Connector	234-4004	234-4210	-	-
V6-3.5	1995-1993	Round Connector	234-4077	234-4210	-	-
<b>CONQUEST</b>						
L4-2.6	1989-1987		234-1052	234-1057	-	-

<sup>1</sup> 2 Required / Requis 2 / Requeridos 2 <sup>4</sup> Left Side / Côté gauche / Lado izquierdo <sup>5</sup> Right Side / Côté droit / Lado derecho



ENGINE MOTEUR MOTOR	YEAR ANNEE AÑO	APPLICATION INFORMATION INFORMATION D'APPLICATION INFORMACION DE APLICACION	UPSTREAM / AVANT - C.C. / ANTES DEL C.C.		DOWNSTREAM / APRS - C.C. / DESPUES DEL C.C.	
			TYPE / TIPO O.E.	UNIVERS.	TYPE / TIPO O.E.	UNIVERS.
<b>CHRYSLER [cont]</b>						
<b>CORDOBA</b>						
L6-3.7	1983-1980		234-1002	234-1000	-	-
V8-5.2	1983-1980		234-1002	234-1000	-	-
V8-5.9	1980		234-1002	234-1000	-	-
<b>CROSSFIRE</b>						
V6-3.2	2008-2004		234-4883 <sup>4</sup>	-	234-4884 <sup>4</sup>	-
V6-3.2	2008-2004		234-4883 <sup>5</sup>	-	234-4902 <sup>5</sup>	-
<b>DAYTONA</b>						
L4-2.2	1993-1992		234-4004	234-4210	-	-
L4-2.2	1990-1989		234-4004	234-4210	-	-
L4-2.2	1988-1987		234-3003	234-3000	-	-
L4-2.2	1986-1984		234-1002	234-1000	-	-
L4-2.5	1993-1989		234-4004	234-4210	-	-
L4-2.5	1988-1987		234-3003	234-3000	-	-
V6-3.0	1993-1990		234-4004	234-4210	-	-
<b>DYNASTY</b>						
L4-2.5	1993-1988		234-4004	234-4210	-	-
V6-3.0	1990-1988		234-4004	234-4210	-	-
V6-3.3	1993-1990		234-4004	234-4210	-	-
<b>E CLASS</b>						
L4-2.2	1984-1983		234-1002	234-1000	-	-
L4-2.6	1984		234-1005	234-1000	-	-
L4-2.6	1983		234-1002	234-1000	-	-
<b>EXECUTIVE LIMOUSINE</b>						
L4-2.2	1986		234-1002	234-1000	-	-
L4-2.5	1986		234-1002	234-1000	-	-
L4-2.6	1985		234-1005	234-1000	-	-
<b>EXECUTIVE SEDAN</b>						
L4-2.6	1984		234-1005	234-1000	-	-
L4-2.6	1983		234-1002	234-1000	-	-
<b>FIFTH AVENUE</b>						
L6-3.7	1983		234-1002	234-1000	-	-
V8-5.2	1989-1983		234-1002	234-1000	-	-
<b>GRAND VOYAGER</b>						
V6-3.0	2000	Exc. TLEV	234-4077	234-4210	234-4021	234-4210
V6-3.0	2000	TLEV	234-4077	234-4210	234-4082	234-4210
V6-3.3	2000	Exc. TLEV	234-4077	234-4210	234-4021	234-4210
V6-3.3	2000	TLEV	234-4077	234-4210	234-4082	234-4210
<b>IMPERIAL</b>						
V6-3.3	1991-1990		234-4004	234-4210	-	-
V6-3.8	1993-1991		234-4004	234-4210	-	-

<sup>4</sup> Left Side / Côté gauche / Lado izquierdo <sup>5</sup> Right Side / Côté droit / Lado derecho



ENGINE MOTEUR MOTOR	YEAR ANNEE AÑO	APPLICATION INFORMATION INFORMATION D'APPLICATION INFORMACION DE APLICACION	UPSTREAM / AVANT - C.C. / ANTES DEL C.C.		DOWNSTREAM / APRS - C.C. / DESPUES DEL C.C.	
			TYPE / TIPO O.E.	UNIVERS.	TYPE / TIPO O.E.	UNIVERS.
<b>CHRYSLER [cont]</b>						
<b>IMPERIAL [cont]</b>						
V8-5.2	1983-1981		234-1002	234-1000	-	-
<b>INTREPID</b>						
V6-2.7	2004-2002		234-4592 <sup>1</sup>	-	234-4078 <sup>1</sup>	234-4210 <sup>1</sup>
V6-2.7	2001-1998		234-4078 <sup>1</sup>	234-4210 <sup>1</sup>	234-4078 <sup>1</sup>	234-4210 <sup>1</sup>
V6-3.2	2001-1998		234-4078 <sup>1</sup>	234-4210 <sup>1</sup>	234-4078 <sup>1</sup>	234-4210 <sup>1</sup>
V6-3.3	1997-1996	w/ 17" Downstream Sensor	234-4077	234-4210	234-4002	234-4210
V6-3.3	1997-1996	w/ 22" Downstream Sensor	234-4077	234-4210	234-4003	234-4210
V6-3.3	1995-1993		234-4004	234-4210	-	-
V6-3.5	2004-2002		234-4592 <sup>1</sup>	-	234-4078 <sup>1</sup>	234-4210 <sup>1</sup>
V6-3.5	2001-2000		234-4078 <sup>1</sup>	234-4210 <sup>1</sup>	234-4078 <sup>1</sup>	234-4210 <sup>1</sup>
V6-3.5	1997-1996	w/ 17" Downstream Sensor	234-4077 <sup>1</sup>	234-4210 <sup>1</sup>	234-4002 <sup>1</sup>	234-4210 <sup>1</sup>
V6-3.5	1997-1996	w/ 22" Downstream Sensor	234-4077 <sup>1</sup>	234-4210 <sup>1</sup>	234-4003 <sup>1</sup>	234-4210 <sup>1</sup>
V6-3.5	1995-1994	Square Connector	234-4004	234-4210	-	-
V6-3.5	1995-1993	Round Connector	234-4077	234-4210	-	-
<b>LASER</b>						
L4-2.2	1986-1984		234-1002	234-1000	-	-
L4-2.5	1986		234-1002	234-1000	-	-
<b>LEBARON</b>						
L4-2.2	1990-1989		234-4004	234-4210	-	-
L4-2.2	1988-1987		234-3003	234-3000	-	-
L4-2.2	1986-1982		234-1002	234-1000	-	-
L4-2.5	1994-1989		234-4004	234-4210	-	-
L4-2.5	1988-1987		234-3003	234-3000	-	-
L4-2.5	1986		234-1002	234-1000	-	-
L4-2.6	1985-1984		234-1005	234-1000	-	-
L4-2.6	1983-1982		234-1002	234-1000	-	-
L6-3.7	1981-1979		234-1002	234-1000	-	-
V6-3.0	1995-1990		234-4004	234-4210	-	-
V8-5.2	1981-1980		234-1002	234-1000	-	-
<b>LHS</b>						
V6-3.5	2001-1999		234-4078 <sup>1</sup>	234-4210 <sup>1</sup>	234-4078 <sup>1</sup>	234-4210 <sup>1</sup>
V6-3.5	1997-1996	w/ 17" Downstream Sensor	234-4077 <sup>1</sup>	234-4210 <sup>1</sup>	234-4002 <sup>1</sup>	234-4210 <sup>1</sup>
V6-3.5	1997-1996	w/ 22" Downstream Sensor	234-4077 <sup>1</sup>	234-4210 <sup>1</sup>	234-4003 <sup>1</sup>	234-4210 <sup>1</sup>
V6-3.5	1995-1994	Round Connector	234-4077	234-4210	-	-
V6-3.5	1995-1994	Square Connector	234-4004	234-4210	-	-
<b>NEON</b>						
L4-2.0	2002-2001	Calif.	234-4882	-	234-4078	234-4210
L4-2.0	2002-2001	Exc. Calif.	234-4882	-	234-4008	234-4210
L4-2.0	2000	Exc. ULEV	234-4115	-	234-4614	234-4210
L4-2.0	2000	ULEV	234-4882	-	234-4078	234-4210

<sup>1</sup> 2 Required / Requis 2 / Requeridos 2



ENGINE MOTEUR MOTOR	YEAR ANNEE AÑO	APPLICATION INFORMATION INFORMATION D'APPLICATION INFORMACION DE APLICACION	UPSTREAM / AVANT - C.C. / ANTES DEL C.C.		DOWNSTREAM / APRS - C.C. / DESPUES DEL C.C.	
			TYPE / TIPO O.E.	UNIVERS.	TYPE / TIPO O.E.	UNIVERS.
<b>CHRYSLER [cont]</b>						
<b>NEWPORT</b>						
L6-3.7	1981-1979		234-1002	234-1000	-	-
V8-5.2	1981-1980		234-1002	234-1000	-	-
V8-5.9	1980		234-1002	234-1000	-	-
<b>NEW YORKER</b>						
L4-2.2	1988-1987		234-3003	234-3000	-	-
L4-2.2	1986-1983		234-1002	234-1000	-	-
L4-2.5	1987		234-3003	234-3000	-	-
L4-2.5	1986		234-1002	234-1000	-	-
L4-2.6	1985-1984		234-1005	234-1000	-	-
L4-2.6	1983		234-1002	234-1000	-	-
L6-3.7	1982		234-1002	234-1000	-	-
V6-3.0	1989		234-4004	234-4210	-	-
V6-3.0	1988		234-3003	234-3000	-	-
V6-3.3	1993-1990		234-4004	234-4210	-	-
V6-3.5	1996	w/ 17" Downstream Sensor	234-4077 <sup>1</sup>	234-4210 <sup>1</sup>	234-4002 <sup>1</sup>	234-4210 <sup>1</sup>
V6-3.5	1996	w/ 22" Downstream Sensor	234-4077 <sup>1</sup>	234-4210 <sup>1</sup>	234-4003 <sup>1</sup>	234-4210 <sup>1</sup>
V6-3.5	1995-1994	Round Connector	234-4077	234-4210	-	-
V6-3.5	1995-1994	Square Connector	234-4004	234-4210	-	-
V6-3.8	1993-1991		234-4004	234-4210	-	-
V8-5.2	1982-1980		234-1002	234-1000	-	-
V8-5.9	1980		234-1002	234-1000	-	-
<b>PACIFICA</b>						
V6-3.5	2006-2005		234-4756	234-4212	234-4744	234-4212
V6-3.5	2004		234-4411	-	234-4412	-
V6-3.8	2008-2006		234-4880	-	234-4588	-
V6-3.8	2005	From 07/09/04	234-4880	-	234-4588	-
V6-3.8	2005	To 07/08/04	234-4410	-	234-4588	-
V6-4.0	2008-2007		234-4587 <sup>1</sup>	-	234-4587 <sup>1</sup>	-
<b>PROWLER</b>						
V6-3.5	2002-2001		234-4078 <sup>1</sup>	234-4210 <sup>1</sup>	234-4078 <sup>1</sup>	234-4210 <sup>1</sup>
<b>PT CRUISER</b>						
L4-2.4	2010		234-4588	-	234-4587	-
L4-2.4	2009-2004	Non-Turbo	234-4588	-	234-4587	-
L4-2.4	2009-2004	Turbo	234-4587	-	234-4587	-
L4-2.4	2003		234-4587	-	234-4232	234-4212
L4-2.4	2002-2001		234-4115	-	234-4008	234-4210
<b>SEBRING</b>						
L4-2.0	1999-1997		234-4076	234-4210	234-4083	234-4210
L4-2.0	1996-1995		234-4003	234-4210	234-4083	234-4210
L4-2.4	2010-2008		234-4881	-	234-4881	-

<sup>1</sup> 2 Required / Requis 2 / Requeridos 2



ENGINE MOTEUR MOTOR	YEAR ANNEE AÑO	APPLICATION INFORMATION INFORMATION D'APPLICATION INFORMACION DE APLICACION	UPSTREAM / AVANT - C.C. / ANTES DEL C.C.		DOWNSTREAM / APRS - C.C. / DESPUES DEL C.C.	
			TYPE / TIPO O.E.	UNIVERS.	TYPE / TIPO O.E.	UNIVERS.
<b>CHRYSLER [cont]</b>						
<b>SEBRING [cont]</b>						
L4-2.4	2007-2006		234-4588	-	234-4587	-
L4-2.4	2005-2004	DOHC; Square Downstream Connector	234-4588	-	234-4587	-
L4-2.4	2005-2001	SOHC	234-4738	-	234-4652	234-4209
L4-2.4	2004-2001	DOHC; Round Downstream Connector	234-4596	-	234-4079	234-4210
L4-2.4	1998		234-4078	234-4210	234-4028	234-4210
L4-2.4	1997		234-4077	234-4210	234-4028	234-4210
L4-2.4	1996		234-4004	234-4210	234-4028	234-4210
V6-2.5	2000-1998	Convertible	234-4079	234-4210	234-4028	234-4210
V6-2.5	2000-1998	Coupe; Calif.	234-4077 <sup>4</sup>	234-4210 <sup>4</sup>	234-4597 <sup>4</sup>	-
V6-2.5	2000-1998	Coupe; Calif.	234-4614 <sup>5</sup>	234-4210 <sup>5</sup>	234-4597 <sup>5</sup>	-
V6-2.5	2000-1998	Coupe; Exc. Calif.	234-4076 <sup>1</sup>	234-4210 <sup>1</sup>	234-4075 <sup>1</sup>	234-4210 <sup>1</sup>
V6-2.5	1997-1996	Convertible	234-4005	234-4210	234-4028	234-4210
V6-2.5	1997	Coupe	234-4003 <sup>1</sup>	234-4210 <sup>1</sup>	234-4075 <sup>1</sup>	234-4210 <sup>1</sup>
V6-2.5	1996	Coupe	234-4003 <sup>1</sup>	234-4210 <sup>1</sup>	234-4075	234-4210
V6-2.5	1995		234-4003	234-4210	234-4003	234-4210
V6-2.7	2010-2004	Square Connector	234-4587 <sup>1</sup>	-	234-4587 <sup>1</sup>	-
V6-2.7	2004-2001	Round Connector	234-4078 <sup>1</sup>	234-4210 <sup>1</sup>	234-4078 <sup>1</sup>	234-4210 <sup>1</sup>
V6-3.0	2005-2004		234-4739 <sup>4</sup>	-	234-4656 <sup>4</sup>	234-4209 <sup>4</sup>
V6-3.0	2005-2004		234-4738 <sup>5</sup>	-	234-4656 <sup>5</sup>	234-4209 <sup>5</sup>
V6-3.0	2003-2001		234-4738 <sup>4</sup>	-	234-4656 <sup>4</sup>	234-4209 <sup>4</sup>
V6-3.0	2003-2001		234-4739 <sup>5</sup>	-	234-4656 <sup>5</sup>	234-4209 <sup>5</sup>
V6-3.5	2010-2007		234-4587 <sup>1</sup>	-	234-4587 <sup>1</sup>	-
<b>TC MASERATI</b>						
L4-2.2	1990		234-3003	234-3000	-	-
L4-2.2	1989		234-4004	234-4210	-	-
V6-3.0	1991-1990		234-4004	234-4210	-	-
<b>TOWN &amp; COUNTRY</b>						
L4-2.2	1988-1987		234-3003	234-3000	-	-
L4-2.2	1986-1982		234-1002	234-1000	-	-
L4-2.5	1988-1987		234-3003	234-3000	-	-
L4-2.5	1986		234-1002	234-1000	-	-
L4-2.6	1985-1982		234-1005	234-1000	-	-
L6-3.7	1981-1980		234-1002	234-1000	-	-
V6-3.3	2010-2008	Flex Fuel Engine	234-4881	-	234-4588	-
V6-3.3	2008-2006	Gas Engine	234-4880	-	234-4588	-
V6-3.3	2005	From 07/09/04; XZZ Option Code	234-4880	-	234-4588	-
V6-3.3	2005	To 07/08/04; Exc. XZZ Option Code	234-4410	-	234-4588	-
V6-3.3	2004		234-4410	-	234-4588	-
V6-3.3	2003-2001		234-4216	-	234-4010	234-4210
V6-3.3	2000-1996	Exc. TLEV	234-4077	234-4210	234-4021	234-4210

<sup>1</sup> 2 Required / Requis 2 / Requeridos 2 <sup>4</sup> Left Side / Côté gauche / Lado izquierdo <sup>5</sup> Right Side / Côté droit / Lado derecho





ENGINE MOTEUR MOTOR	YEAR ANNEE AÑO	APPLICATION INFORMATION INFORMATION D'APPLICATION INFORMACION DE APLICACION	UPSTREAM / AVANT - C.C. / ANTES DEL C.C.		DOWNSTREAM / APRS - C.C. / DESPUES DEL C.C.	
			TYPE / TIPO O.E.	UNIVERS.	TYPE / TIPO O.E.	UNIVERS.
<b>CHRYSLER [cont]</b>						
<b>TOWN &amp; COUNTRY [cont]</b>						
V6-3.3	2000-1996	TLEV	234-4077	234-4210	234-4082	234-4210
V6-3.3	1993-1990		234-4004	234-4210	-	-
V6-3.6	2015-2011		234-4545 <sup>4</sup>	-	234-4545 <sup>4</sup>	-
V6-3.6	2015-2011		234-4545 <sup>5</sup>	-	234-4547 <sup>5</sup>	-
V6-3.8	2010-2008		234-4881	-	234-4588	-
V6-3.8	2007-2006		234-4880	-	234-4588	-
V6-3.8	2005	From 07/09/04; XZZ Option Code	234-4880	-	234-4588	-
V6-3.8	2005	To 07/08/04; Exc. XZZ Option Code	234-4410	-	234-4588	-
V6-3.8	2004		234-4410	-	234-4588	-
V6-3.8	2003-2001		234-4216	-	234-4010	234-4210
V6-3.8	2000-1996	Exc. TLEV	234-4077	234-4210	234-4021	234-4210
V6-3.8	2000-1996	TLEV	234-4077	234-4210	234-4082	234-4210
V6-3.8	1995		234-4077	234-4210	-	-
V6-3.8	1994		234-4004	234-4210	-	-
V6-4.0	2010-2008		234-4587 <sup>1</sup>	-	234-4587 <sup>1</sup>	-
V8-5.2	1981-1980		234-1002	234-1000	-	-
<b>VOYAGER</b>						
L4-2.4	2003		234-4590	-	234-4010	234-4210
L4-2.4	2002-2001		234-4022	234-4210	234-4010	234-4210
L4-2.4	2000	Exc. TLEV	234-4005	234-4210	234-4021	234-4210
L4-2.4	2000	TLEV	234-4005	234-4210	234-4082	234-4210
V6-3.0	2000	Exc. TLEV	234-4077	234-4210	234-4021	234-4210
V6-3.0	2000	TLEV	234-4077	234-4210	234-4082	234-4210
V6-3.3	2003-2001		234-4216	-	234-4010	234-4210
V6-3.3	2000	Exc. TLEV	234-4077	234-4210	234-4021	234-4210
V6-3.3	2000	TLEV	234-4077	234-4210	234-4082	234-4210
<b>DAEWOO</b>						
<b>LANOS</b>						
L4-1.5	2002-1999		234-2001	234-2000	234-4012	234-4000
L4-1.6	2002-1999		234-2001	234-2000	234-4012	234-4000
<b>LEGANZA</b>						
L4-2.2	2002-1999		234-2001	234-2000	234-4012	234-4000
<b>NUBIRA</b>						
L4-2.0	2002-1999		234-2001	234-2000	234-4221	234-4000
<b>DAIHATSU</b>						
<b>CHARADE</b>						
L3-1.0	1992-1988		234-1008	234-1000	-	-
L4-1.3	1992-1989		234-1008	234-1000	-	-

<sup>1</sup> 2 Required / Requis 2 / Requeridos 2 <sup>4</sup> Left Side / Côté gauche / Lado izquierdo <sup>5</sup> Right Side / Côté droit / Lado derecho



ENGINE MOTEUR MOTOR	YEAR ANNEE AÑO	APPLICATION INFORMATION INFORMATION D'APPLICATION INFORMACION DE APLICACION	UPSTREAM / AVANT - C.C. / ANTES DEL C.C.		DOWNSTREAM / APRES - C.C. / DESPUES DEL C.C.	
			TYPE / TIPO O.E.	UNIVERS.	TYPE / TIPO O.E.	UNIVERS.
<b>DAIHATSU [cont]</b>						
<b>ROCKY</b>						
L4-1.6	1992-1990		234-1008	234-1000	-	-
<b>DELOREAN</b>						
<b>DMC 12</b>						
V6-2.9	1983-1981		234-1011	234-1000	-	-
<b>DODGE</b>						
<b>400</b>						
L4-2.2	1983-1982		234-1002	234-1000	-	-
L4-2.6	1983-1982		234-1002	234-1000	-	-
<b>600</b>						
L4-2.2	1988-1987		234-3003	234-3000	-	-
L4-2.2	1986-1983		234-1002	234-1000	-	-
L4-2.5	1988-1987		234-3003	234-3000	-	-
L4-2.5	1986		234-1002	234-1000	-	-
L4-2.6	1985-1984		234-1005	234-1000	-	-
L4-2.6	1983		234-1002	234-1000	-	-
<b>2000 GTX</b>						
L4-2.0	1990-1989	VIN R	234-4644	234-4209	-	-
L4-2.0	1990-1989	VIN V	234-1005	234-1000	-	-
<b>ARIES</b>						
L4-2.2	1989		234-4004	234-4210	-	-
L4-2.2	1988-1987		234-3003	234-3000	-	-
L4-2.2	1986-1981		234-1002	234-1000	-	-
L4-2.5	1989		234-4004	234-4210	-	-
L4-2.5	1988-1987		234-3003	234-3000	-	-
L4-2.5	1986		234-1002	234-1000	-	-
L4-2.6	1985-1984		234-1005	234-1000	-	-
L4-2.6	1983-1981		234-1002	234-1000	-	-
<b>ASPEN</b>						
L6-3.7	1980-1979		234-1002	234-1000	-	-
V8-5.2	1980		234-1002	234-1000	-	-
V8-5.9	1980		234-1002	234-1000	-	-
<b>AVENGER</b>						
L4-2.0	1999-1997		234-4076	234-4210	234-4083	234-4210
L4-2.0	1996-1995		234-4003	234-4210	234-4083	234-4210
L4-2.4	2014-2011		234-4547	-	234-4547	-
L4-2.4	2010-2008		234-4881	-	234-4881	-
V6-2.5	2000-1998	Calif.	234-4077 <sup>4</sup>	234-4210 <sup>4</sup>	234-4597 <sup>4</sup>	-
V6-2.5	2000-1998	Calif.	234-4614 <sup>5</sup>	234-4210 <sup>5</sup>	234-4597 <sup>5</sup>	-

<sup>1</sup> 2 Required / Requis 2 / Requeridos 2 <sup>4</sup> Left Side / Côté gauche / Lado izquierdo <sup>5</sup> Right Side / Côté droit / Lado derecho



ENGINE MOTEUR MOTOR	YEAR ANNEE AÑO	APPLICATION INFORMATION INFORMATION D'APPLICATION INFORMACION DE APLICACION	UPSTREAM / AVANT - C.C. / ANTES DEL C.C.		DOWNSTREAM / APRS - C.C. / DESPUES DEL C.C.		
			TYPE / TIPO O.E.	UNIVERS.	TYPE / TIPO O.E.	UNIVERS.	
<b>DODGE [cont]</b>							
<b>AVENGER [cont]</b>							
V6-2.5	2000-1998	Exc. Calif.	234-4076 <sup>1</sup>	234-4210 <sup>1</sup>	234-4075 <sup>1</sup>	234-4210 <sup>1</sup>	
V6-2.5	1997		234-4003 <sup>1</sup>	234-4210 <sup>1</sup>	234-4075 <sup>1</sup>	234-4210 <sup>1</sup>	
V6-2.5	1996		234-4003	234-4210	234-4083	234-4210	
V6-2.5	1995		234-4003	234-4210	234-4003	234-4210	
V6-2.7	2010-2008		234-4587 <sup>1</sup>	-	234-4587 <sup>1</sup>	-	
V6-3.5	2010-2008		234-4587 <sup>1</sup>	-	234-4587 <sup>1</sup>	-	
V6-3.6	2014-2012		234-4545 <sup>4</sup>	-	234-4547 <sup>4</sup>	-	
V6-3.6	2014-2012		234-4545 <sup>5</sup>	-	234-4545 <sup>5</sup>	-	
V6-3.6	2011		234-4545 <sup>1</sup>	-	234-4545 <sup>1</sup>	-	
<b>B100 VAN</b>							
L6-3.7	1980-1979		234-1002	234-1000	-	-	
V8-5.2	1980		234-1002	234-1000	-	-	
<b>B150 VAN</b>							
L6-3.7	1987-1981		234-1002	234-1000	-	-	
V6-3.9	1994-1992		234-4003	234-4210	-	-	
V6-3.9	1991		234-4004	234-4210	-	-	
V6-3.9	1990		234-4003	234-4210	-	-	
V6-3.9	1989-1988		234-4014	234-4210	-	-	
V8-5.2	1994-1990		234-4003	234-4210	-	-	
V8-5.2	1989		234-4004	234-4210	-	-	
V8-5.2	1988		234-3003	234-3000	-	-	
V8-5.2	1987-1981		234-1002	234-1000	-	-	
<b>B200 VAN</b>							
L6-3.7	1980-1979		234-1002	234-1000	-	-	
V8-5.2	1980		234-1002	234-1000	-	-	
V8-5.9	1980		234-1002	234-1000	-	-	
<b>B250 VAN</b>							
L6-3.7	1987-1981		234-1002	234-1000	-	-	
V6-3.9	1994-1992		234-4003	234-4210	-	-	
V6-3.9	1991		234-4004	234-4210	-	-	
V6-3.9	1990		234-4003	234-4210	-	-	
V6-3.9	1989-1988		234-4014	234-4210	-	-	
V8-5.2	1994-1990		234-4003	234-4210	-	-	
V8-5.2	1989		234-4004	234-4210	-	-	
V8-5.2	1988		234-3003	234-3000	-	-	
V8-5.2	1987-1981		234-1002	234-1000	-	-	
V8-5.9	1994		234-4003	234-4210	-	-	
V8-5.9	1993-1988		234-4004	234-4210	-	-	
V8-5.9	1987-1984		234-1002	234-1000	-	-	
V8-5.9	1981		234-1002	234-1000	-	-	

<sup>1</sup> 2 Required / Requis 2 / Requeridos 2 <sup>4</sup> Left Side / Côté gauche / Lado izquierdo <sup>5</sup> Right Side / Côté droit / Lado derecho



ENGINE MOTEUR MOTOR	YEAR ANNEE AÑO	APPLICATION INFORMATION INFORMATION D'APPLICATION INFORMACION DE APLICACION	UPSTREAM / AVANT - C.C. / ANTES DEL C.C.		DOWNSTREAM / APRS - C.C. / DESPUES DEL C.C.	
			TYPE / TIPO O.E.	UNIVERS.	TYPE / TIPO O.E.	UNIVERS.
<b>DODGE [cont]</b>						
<b>B300 VAN</b>						
L6-3.7	1980-1979		234-1002	234-1000	-	-
V8-5.2	1980		234-1002	234-1000	-	-
V8-5.9	1980		234-1002	234-1000	-	-
<b>B350 VAN</b>						
V8-5.2	1994-1990		234-4003	234-4210	-	-
V8-5.2	1989		234-4004	234-4210	-	-
V8-5.2	1988		234-3003	234-3000	-	-
V8-5.2	1987-1981		234-1002	234-1000	-	-
V8-5.9	1994		234-4003	234-4210	-	-
V8-5.9	1993-1988		234-4004	234-4210	-	-
V8-5.9	1987-1981		234-1002	234-1000	-	-
<b>B1500 VAN</b>						
V6-3.9	1998		234-4077	234-4210	234-4079	234-4210
V6-3.9	1997		234-4077	234-4210	234-4078	234-4210
V6-3.9	1996		234-4077	234-4210	234-4079	234-4210
V6-3.9	1995		234-4003	234-4210	-	-
V8-5.2	1998		234-4077	234-4210	234-4079	234-4210
V8-5.2	1997		234-4077	234-4210	234-4078	234-4210
V8-5.2	1996		234-4077	234-4210	234-4079	234-4210
V8-5.2	1995		234-4003	234-4210	-	-
V8-5.9	1998		234-4077	234-4210	234-4079	234-4210
<b>B2500 VAN</b>						
V6-3.9	1997		234-4077	234-4210	234-4078	234-4210
V6-3.9	1996		234-4077	234-4210	234-4079	234-4210
V6-3.9	1995		234-4003	234-4210	-	-
V8-5.2	1998		234-4077	234-4210	234-4079	234-4210
V8-5.2	1997		234-4077	234-4210	234-4078	234-4210
V8-5.2	1996		234-4077	234-4210	234-4079	234-4210
V8-5.2	1995		234-4003	234-4210	-	-
V8-5.9	1998		234-4077	234-4210	234-4079	234-4210
V8-5.9	1997		234-4077	234-4210	234-4078	234-4210
V8-5.9	1996		234-4077	234-4210	234-4079	234-4210
V8-5.9	1995		234-4003	234-4210	-	-
<b>B3500 VAN</b>						
V8-5.2	1998		234-4077	234-4210	234-4079	234-4210
V8-5.2	1997	CNG Engine	234-4077	234-4210	234-4079	234-4210
V8-5.2	1997	Gas Engine	234-4077	234-4210	234-4078	234-4210
V8-5.2	1996	CNG Engine	234-4077	234-4210	234-4078	234-4210
V8-5.2	1996	Gas Engine	234-4077	234-4210	234-4079	234-4210
V8-5.2	1995		234-4003	234-4210	-	-



ENGINE MOTEUR MOTOR	YEAR ANNEE AÑO	APPLICATION INFORMATION INFORMATION D'APPLICATION INFORMACION DE APLICACION	UPSTREAM / AVANT - C.C. / ANTES DEL C.C.		DOWNSTREAM / APRS - C.C. / DESPUES DEL C.C.	
			TYPE / TIPO O.E.	UNIVERS.	TYPE / TIPO O.E.	UNIVERS.
<b>DODGE [cont]</b>						
<b>B3500 VAN [cont]</b>						
V8-5.9	1998		234-4077	234-4210	234-4079	234-4210
V8-5.9	1997		234-4077	234-4210	234-4078	234-4210
V8-5.9	1996		234-4077	234-4210	234-4079	234-4210
V8-5.9	1995		234-4003	234-4210	-	-
<b>CALIBER</b>						
L4-1.8	2009-2007		234-4881	-	234-4881	-
L4-2.0	2012-2011		234-4547	-	234-4547	-
L4-2.0	2010-2007		234-4881	-	234-4881	-
L4-2.4	2011		234-4547	-	234-4547	-
L4-2.4	2010-2009		234-4881	-	234-4881	-
L4-2.4	2008-2007	Non-Turbo	234-4881	-	234-4881	-
L4-2.4	2008	Turbo	234-4881	-	234-4880	-
<b>CARAVAN</b>						
L4-2.2	1987-1984		234-1002	234-1000	-	-
L4-2.4	2007-2004		234-4587	-	234-4588	-
L4-2.4	2003		234-4590	-	234-4010	234-4210
L4-2.4	2002-2001		234-4022	234-4210	234-4010	234-4210
L4-2.4	2000-1999	Exc. TLEV	234-4005	234-4210	234-4021	234-4210
L4-2.4	2000-1999	TLEV	234-4005	234-4210	234-4082	234-4210
L4-2.4	1998		234-4002	234-4210	234-4021	234-4210
L4-2.4	1997		234-4005	234-4210	234-4021	234-4210
L4-2.4	1996		234-4077	234-4210	234-4076	234-4210
L4-2.5	1995-1989		234-4004	234-4210	-	-
L4-2.5	1988		234-3003	234-3000	-	-
L4-2.6	1987-1984		234-1005	234-1000	-	-
V6-3.0	2000	Exc. TLEV	234-4077	234-4210	234-4021	234-4210
V6-3.0	2000	TLEV	234-4077	234-4210	234-4082	234-4210
V6-3.0	1999		234-4077	234-4210	234-4021	234-4210
V6-3.0	1998-1996	Exc. TLEV	234-4077	234-4210	234-4021	234-4210
V6-3.0	1998-1996	TLEV	234-4077	234-4210	234-4082	234-4210
V6-3.0	1995		234-4077	234-4210	-	-
V6-3.0	1994-1989		234-4004	234-4210	-	-
V6-3.0	1988-1987		234-3003	234-3000	-	-
V6-3.3	2007-2006		234-4880	-	234-4588	-
V6-3.3	2005	From 07/09/04; XZZ Option Code	234-4880	-	234-4588	-
V6-3.3	2005	To 07/08/04; Exc. XZZ Option Code	234-4410	-	234-4588	-
V6-3.3	2004		234-4410	-	234-4588	-
V6-3.3	2003-2001		234-4216	-	234-4010	234-4210
V6-3.3	2000-1996	Exc. TLEV	234-4077	234-4210	234-4021	234-4210
V6-3.3	2000-1996	TLEV	234-4077	234-4210	234-4082	234-4210
V6-3.3	1995		234-4077	234-4210	-	-



ENGINE MOTEUR MOTOR	YEAR ANNEE AÑO	APPLICATION INFORMATION INFORMATION D'APPLICATION INFORMACION DE APLICACION	UPSTREAM / AVANT - C.C. / ANTES DEL C.C.		DOWNSTREAM / APRS - C.C. / DESPUES DEL C.C.	
			TYPE / TIPO O.E.	UNIVERS.	TYPE / TIPO O.E.	UNIVERS.
<b>DODGE [cont]</b>						
<b>CARAVAN [cont]</b>						
V6-3.3	1994-1990		234-4004	234-4210	-	-
V6-3.8	1999-1996	Exc. TLEV	234-4077	234-4210	234-4021	234-4210
V6-3.8	1999-1996	TLEV	234-4077	234-4210	234-4082	234-4210
<b>CB300</b>						
L6-3.7	1979		234-1002	234-1000	-	-
V8-5.2	1980		234-1002	234-1000	-	-
V8-5.9	1980		234-1002	234-1000	-	-
<b>CHALLENGER</b>						
L4-2.6	1983-1980		234-1002	234-1000	-	-
V6-3.5	2010	Calif.	234-4587 <sup>4</sup>	-	234-4587 <sup>4</sup>	-
V6-3.5	2010	Calif.	234-4587 <sup>5</sup>	-	234-4588 <sup>5</sup>	-
V6-3.5	2010	Exc. Calif.	234-4587 <sup>1</sup>	-	234-4587 <sup>1</sup>	-
V6-3.5	2009		234-4587 <sup>4</sup>	-	234-4587 <sup>4</sup>	-
V6-3.5	2009		234-4587 <sup>5</sup>	-	234-4588 <sup>5</sup>	-
V6-3.6	2015-2014		234-4545 <sup>4</sup>	-	234-4545 <sup>4</sup>	-
V6-3.6	2015-2014		234-4545 <sup>5</sup>	-	234-4545 <sup>5</sup>	-
V6-3.6	2013-2011		234-4545 <sup>1</sup>	-	234-4545 <sup>1</sup>	-
V8-5.7	2015-2013		234-4545 <sup>1</sup>	-	234-4545 <sup>1</sup>	-
V8-5.7	2012-2009		234-4587 <sup>1</sup>	-	234-4587 <sup>1</sup>	-
V8-6.1	2010-2008		234-4587 <sup>1</sup>	-	234-4587 <sup>1</sup>	-
V8-6.2	2015		234-4545 <sup>1</sup>	-	234-4545 <sup>1</sup>	-
V8-6.4	2015-2013		234-4545 <sup>1</sup>	-	234-4545 <sup>1</sup>	-
V8-6.4	2012-2011		234-4587 <sup>1</sup>	-	234-4587 <sup>1</sup>	-
<b>CHARGER</b>						
L4-1.6	1986-1983		234-1002	234-1000	-	-
L4-1.7	1983		234-1002	234-1000	-	-
L4-2.2	1987	Non-Turbo	234-1002	234-1000	-	-
L4-2.2	1987	Turbo	234-3003	234-3000	-	-
L4-2.2	1986-1983		234-1002	234-1000	-	-
V6-2.7	2010-2007		234-4587 <sup>4</sup>	-	234-4587 <sup>4</sup>	-
V6-2.7	2010-2007		234-4587 <sup>5</sup>	-	234-4588 <sup>5</sup>	-
V6-2.7	2006		234-4587 <sup>1</sup>	-	234-4587 <sup>1</sup>	-
V6-3.5	2010		234-4587 <sup>1</sup>	-	234-4587 <sup>1</sup>	-
V6-3.5	2009		234-4587 <sup>4</sup>	-	234-4587 <sup>4</sup>	-
V6-3.5	2009		234-4587 <sup>5</sup>	-	234-4588 <sup>5</sup>	-
V6-3.5	2008		234-4587 <sup>1</sup>	-	234-4587 <sup>1</sup>	-
V6-3.5	2007	Calif.	234-4587 <sup>4</sup>	-	234-4587 <sup>4</sup>	-
V6-3.5	2007	Calif.	234-4587 <sup>5</sup>	-	234-4588 <sup>5</sup>	-
V6-3.5	2007	Exc. Calif.	234-4587 <sup>1</sup>	-	234-4587 <sup>1</sup>	-

<sup>1</sup> 2 Required / Requis 2 / Requeridos 2 <sup>4</sup> Left Side / Côté gauche / Lado izquierdo <sup>5</sup> Right Side / Côté droit / Lado derecho



ENGINE MOTEUR MOTOR	YEAR ANNEE AÑO	APPLICATION INFORMATION INFORMATION D'APPLICATION INFORMACION DE APLICACION	UPSTREAM / AVANT - C.C. / ANTES DEL C.C.		DOWNSTREAM / APRES - C.C. / DESPUES DEL C.C.	
			TYPE / TIPO O.E.	UNIVERS.	TYPE / TIPO O.E.	UNIVERS.
<b>DODGE [cont]</b>						
<b>CHARGER [cont]</b>						
V6-3.5	2006		234-4587 <sup>1</sup>	-	234-4587 <sup>1</sup>	-
V6-3.6	2014		234-4545 <sup>4</sup>	-	234-4545 <sup>4</sup>	-
V6-3.6	2014	5 Speed Trans	234-4545 <sup>5</sup>	-	234-4545 <sup>5</sup>	-
V6-3.6	2014	8 Speed Trans	234-4545 <sup>5</sup>	-	234-4547 <sup>5</sup>	-
V6-3.6	2013-2011		234-4545 <sup>1</sup>	-	234-4545 <sup>1</sup>	-
V8-5.7	2014-2013		234-4545 <sup>1</sup>	-	234-4545 <sup>1</sup>	-
V8-5.7	2012	Flex Fuel Engine	234-4545 <sup>1</sup>	-	234-4545 <sup>1</sup>	-
V8-5.7	2012	Gas Engine	234-4587 <sup>1</sup>	-	234-4587 <sup>1</sup>	-
V8-5.7	2011-2008		234-4587 <sup>1</sup>	-	234-4587 <sup>1</sup>	-
V8-5.7	2007	From 07/28/06	234-4418 <sup>4</sup>	-	234-4587 <sup>4</sup>	-
V8-5.7	2007	From 07/28/06	234-4418 <sup>5</sup>	-	234-4588 <sup>5</sup>	-
V8-5.7	2007	To 07/28/06	234-4587 <sup>4</sup>	-	234-4587 <sup>4</sup>	-
V8-5.7	2007	To 07/28/06	234-4587 <sup>5</sup>	-	234-4588 <sup>5</sup>	-
V8-5.7	2006		234-4593 <sup>4</sup>	-	234-4587 <sup>4</sup>	-
V8-5.7	2006		234-4593 <sup>5</sup>	-	234-4588 <sup>5</sup>	-
V8-6.1	2010-2008		234-4587 <sup>1</sup>	-	234-4587 <sup>1</sup>	-
V8-6.1	2007	From 07/28/06	234-4418 <sup>4</sup>	-	234-4587 <sup>4</sup>	-
V8-6.1	2007	From 07/28/06	234-4418 <sup>5</sup>	-	234-4588 <sup>5</sup>	-
V8-6.1	2007	To 07/28/06	234-4587 <sup>4</sup>	-	234-4587 <sup>4</sup>	-
V8-6.1	2007	To 07/28/06	234-4587 <sup>5</sup>	-	234-4588 <sup>5</sup>	-
V8-6.1	2006		234-4593 <sup>4</sup>	-	234-4587 <sup>4</sup>	-
V8-6.1	2006		234-4593 <sup>5</sup>	-	234-4588 <sup>5</sup>	-
V8-6.4	2014-2013		234-4545 <sup>1</sup>	-	234-4545 <sup>1</sup>	-
V8-6.4	2012		234-4587 <sup>1</sup>	-	234-4587 <sup>1</sup>	-
<b>COLT</b>						
L4-1.4	1984		234-1005	234-1000	-	-
L4-1.4	1983-1980		234-1002	234-1000	-	-
L4-1.5	1995		234-4020 <sup>15</sup>	234-4210 <sup>15</sup>	234-4081	234-4210
L4-1.5	1995		234-4032 <sup>16</sup>	234-4210 <sup>16</sup>	-	-
L4-1.5	1994-1993	Calif.	234-4020	234-4210	234-4081	234-4210
L4-1.5	1994-1993	Exc. Calif.	234-2066	234-2000	-	-
L4-1.5	1992		234-2066	234-2000	-	-
L4-1.5	1991	Auto Trans	234-2066	234-2000	-	-
L4-1.5	1991	Manual Trans	234-2002	234-2000	-	-
L4-1.5	1990-1989	2 Lead Sensor	234-2002	234-2000	-	-
L4-1.5	1990-1987	1 Lead Sensor	234-1007	234-1000	-	-
L4-1.5	1986-1985		234-1005	234-1000	-	-
L4-1.6	1990-1989	VIN F	234-1007	234-1000	-	-
L4-1.6	1990-1989	VIN Y, Calif.	234-2002	234-2000	-	-
L4-1.6	1990-1989	VIN Y, Exc. Calif.	234-1007	234-1000	-	-

<sup>1</sup> 2 Required / Requis 2 / Requeridos 2 <sup>4</sup> Left Side / Côté gauche / Lado izquierdo <sup>5</sup> Right Side / Côté droit / Lado derecho <sup>15</sup> Front / Avant / Parte delantera <sup>16</sup> Rear / Arrière / Parte trasera



ENGINE MOTEUR MOTOR	YEAR ANNEE AÑO	APPLICATION INFORMATION INFORMATION D'APPLICATION INFORMACION DE APLICACION	UPSTREAM / AVANT - C.C. / ANTES DEL C.C.		DOWNSTREAM / APRS - C.C. / DESPUES DEL C.C.	
			TYPE / TIPO O.E.	UNIVERS.	TYPE / TIPO O.E.	UNIVERS.
<b>DODGE [cont]</b>						
<b>COLT [cont]</b>						
L4-1.6	1989	VIN Z	234-4643	234-4209	-	-
L4-1.6	1988-1987		234-1007	234-1000	-	-
L4-1.6	1986-1984		234-1005	234-1000	-	-
L4-1.6	1983-1980		234-1002	234-1000	-	-
L4-1.8	1994-1993	Calif.	234-4641	234-4209	234-4638	234-4209
L4-1.8	1994-1993	Exc. Calif.	234-2014	234-2000	-	-
L4-1.8	1992		234-2014	234-2000	-	-
L4-1.8	1990-1989		234-1007	234-1000	-	-
L4-2.0	1991-1989	Calif.	234-2002	234-2000	-	-
L4-2.0	1991-1989	Exc. Calif.	234-1021	234-1000	-	-
L4-2.0	1988-1987	From 10/86	234-1007	234-1000	-	-
L4-2.0	1987	To 10/86	234-1005	234-1000	-	-
L4-2.0	1986-1984		234-1005	234-1000	-	-
L4-2.4	1994		234-4638	234-4209	234-4017	234-4209
L4-2.4	1993	Calif.; AWD	-	-	234-4017	234-4209
L4-2.4	1993	Calif.; FWD	234-4638	234-4209	234-4027	234-4210
L4-2.4	1993	Exc. Calif.	234-2014	234-2000	-	-
L4-2.6	1980		234-1002	234-1000	-	-
<b>CONQUEST</b>						
L4-2.6	1986-1984		234-1052	234-1057	-	-
<b>D50</b>						
L4-2.0	1982-1980		234-1002	234-1000	-	-
L4-2.6	1982-1980		234-1002	234-1000	-	-
<b>D100 PICKUP</b>						
L6-3.7	1987-1984		234-1002	234-1000	-	-
L6-3.7	1979		234-1002	234-1000	-	-
V6-3.9	1989-1988		234-4013	234-4210	-	-
V8-5.2	1989		234-4004	234-4210	-	-
V8-5.2	1988		234-3003	234-3000	-	-
V8-5.2	1987-1984		234-1002	234-1000	-	-
V8-5.9	1988		234-4004	234-4210	-	-
V8-5.9	1987-1984		234-1002	234-1000	-	-
<b>D150 PICKUP</b>						
L6-3.7	1987-1979		234-1002	234-1000	-	-
V6-3.9	1993-1990		234-4003	234-4210	-	-
V6-3.9	1989-1988		234-4013	234-4210	-	-
V8-5.2	1993-1990		234-4003	234-4210	-	-
V8-5.2	1989		234-4004	234-4210	-	-
V8-5.2	1988		234-3003	234-3000	-	-
V8-5.2	1987-1980		234-1002	234-1000	-	-
V8-5.9	1993		234-4004	234-4210	-	-





ENGINE MOTEUR MOTOR	YEAR ANNEE AÑO	APPLICATION INFORMATION INFORMATION D'APPLICATION INFORMACION DE APLICACION	UPSTREAM / AVANT - C.C. / ANTES DEL C.C.		DOWNSTREAM / APRS - C.C. / DESPUES DEL C.C.	
			TYPE / TIPO O.E.	UNIVERS.	TYPE / TIPO O.E.	UNIVERS.
<b>DODGE [cont]</b>						
<b>D150 PICKUP [cont]</b>						
V8-5.9	1991-1988		234-4004	234-4210	-	-
V8-5.9	1987-1984		234-1002	234-1000	-	-
V8-5.9	1982-1980		234-1002	234-1000	-	-
<b>D200 PICKUP</b>						
L6-3.7	1980-1979		234-1002	234-1000	-	-
V8-5.2	1980		234-1002	234-1000	-	-
V8-5.9	1980		234-1002	234-1000	-	-
<b>D250 PICKUP</b>						
L6-3.7	1987-1981		234-1002	234-1000	-	-
L6-5.9	1993-1989		234-4004	234-4210	-	-
V6-3.9	1993-1990		234-4003	234-4210	-	-
V6-3.9	1989-1988		234-4013	234-4210	-	-
V8-5.2	1993-1990		234-4003	234-4210	-	-
V8-5.2	1989		234-4004	234-4210	-	-
V8-5.2	1988		234-3003	234-3000	-	-
V8-5.2	1987-1981		234-1002	234-1000	-	-
V8-5.9	1993-1988		234-4004	234-4210	-	-
V8-5.9	1987-1984		234-1002	234-1000	-	-
V8-5.9	1982-1981		234-1002	234-1000	-	-
<b>D300 PICKUP</b>						
V8-5.2	1980		234-1002	234-1000	-	-
V8-5.9	1980		234-1002	234-1000	-	-
<b>D350 PICKUP</b>						
L6-5.9	1993-1989		234-4004	234-4210	-	-
V8-5.2	1983-1981		234-1002	234-1000	-	-
V8-5.9	1993-1988		234-4004	234-4210	-	-
V8-5.9	1987-1981		234-1002	234-1000	-	-
<b>D400 PICKUP</b>						
V8-5.9	1981-1980		-	234-1000	-	-
<b>D450 PICKUP</b>						
V8-5.9	1981-1980		-	234-1000	-	-
<b>DAKOTA</b>						
L4-2.2	1988-1987		234-3003	234-3000	-	-
L4-2.5	2002-2001		234-4030	234-4210	234-4772	234-4210
L4-2.5	2000-1998		234-4077	234-4210	234-4078	234-4210
L4-2.5	1997	w/ 12" Downstream Sensor	234-4077	234-4210	234-4078	234-4210
L4-2.5	1997	w/ 18" Downstream Sensor	234-4077	234-4210	234-4079	234-4210
L4-2.5	1996		234-4004	234-4210	234-4079	234-4210
L4-2.5	1995-1989		234-4004	234-4210	-	-
V6-3.7	2010-2007		234-4587 <sup>4</sup>	-	234-4588 <sup>4</sup>	-
V6-3.7	2010-2007		234-4588 <sup>5</sup>	-	234-4588 <sup>5</sup>	-

<sup>4</sup> Left Side / Côté gauche / Lado izquierdo <sup>5</sup> Right Side / Côté droit / Lado derecho



ENGINE MOTEUR MOTOR	YEAR ANNEE AÑO	APPLICATION INFORMATION INFORMATION D'APPLICATION INFORMACION DE APLICACION	UPSTREAM / AVANT - C.C. / ANTES DEL C.C.		DOWNSTREAM / APRS - C.C. / DESPUES DEL C.C.	
			TYPE / TIPO O.E.	UNIVERS.	TYPE / TIPO O.E.	UNIVERS.
<b>DODGE [cont]</b>						
<b>DAKOTA [cont]</b>						
V6-3.7	2006-2005		234-4593 <sup>4</sup>	-	234-4588 <sup>4</sup>	-
V6-3.7	2006		234-4598 <sup>5</sup>	-	234-4587 <sup>5</sup>	-
V6-3.7	2005		234-4593 <sup>5</sup>	-	234-4587 <sup>5</sup>	-
V6-3.7	2004		234-4587 <sup>4</sup>	-	234-4767 <sup>4</sup>	234-4210 <sup>4</sup>
V6-3.7	2004		234-4587 <sup>5</sup>	-	234-4771 <sup>5</sup>	234-4210 <sup>5</sup>
V6-3.9	2003-2002	Exc. Quad Cab	234-4766 <sup>4</sup>	-	234-4767 <sup>4</sup>	234-4210 <sup>4</sup>
V6-3.9	2003-2002	Exc. Quad Cab	234-4770 <sup>5</sup>	-	234-4771 <sup>5</sup>	234-4210 <sup>5</sup>
V6-3.9	2003	Quad Cab	234-4030 <sup>1</sup>	234-4210 <sup>1</sup>	234-4772	234-4210
V6-3.9	2002	Quad Cab; Calif.	234-4766 <sup>4</sup>	-	234-4767 <sup>4</sup>	234-4210 <sup>4</sup>
V6-3.9	2002	Quad Cab; Calif.	234-4770 <sup>5</sup>	-	234-4771 <sup>5</sup>	234-4210 <sup>5</sup>
V6-3.9	2002	Quad Cab; Exc. Calif.	234-4030	234-4210	234-4772	234-4210
V6-3.9	2001		234-4766 <sup>4</sup>	-	234-4767 <sup>4</sup>	234-4210 <sup>4</sup>
V6-3.9	2001		234-4770 <sup>5</sup>	-	234-4771 <sup>5</sup>	234-4210 <sup>5</sup>
V6-3.9	2000-1998		234-4077	234-4210	234-4078	234-4210
V6-3.9	1997	w/ 12" Downstream Sensor	234-4077	234-4210	234-4078	234-4210
V6-3.9	1997	w/ 18" Downstream Sensor	234-4077	234-4210	234-4079	234-4210
V6-3.9	1996		234-4077	234-4210	234-4079	234-4210
V6-3.9	1995-1994		234-4003	234-4210	-	-
V6-3.9	1993-1990	w/ 18" Sensor	234-4003	234-4210	-	-
V6-3.9	1993-1990	w/ 34" Sensor	234-4013	234-4210	-	-
V6-3.9	1989-1988		234-4013	234-4210	-	-
V6-3.9	1987		234-1002	234-1000	-	-
V8-4.7	2010-2008		234-4587 <sup>4</sup>	-	234-4588 <sup>4</sup>	-
V8-4.7	2010-2008		234-4588 <sup>5</sup>	-	234-4588 <sup>5</sup>	-
V8-4.7	2007-2006		234-4744 <sup>1</sup>	234-4212 <sup>1</sup>	234-4756 <sup>1</sup>	234-4212 <sup>1</sup>
V8-4.7	2005		234-4744 <sup>4</sup>	234-4212 <sup>4</sup>	234-4756 <sup>4</sup>	234-4212 <sup>4</sup>
V8-4.7	2005		234-4744 <sup>5</sup>	234-4212 <sup>5</sup>	234-4744 <sup>5</sup>	234-4212 <sup>5</sup>
V8-4.7	2004		234-4718 <sup>4</sup>	234-4212 <sup>4</sup>	234-4745 <sup>4</sup>	234-4212 <sup>4</sup>
V8-4.7	2004		234-4718 <sup>5</sup>	234-4212 <sup>5</sup>	234-4718 <sup>5</sup>	234-4212 <sup>5</sup>
V8-4.7	2003	Auto Trans	234-4718 <sup>4</sup>	234-4212 <sup>4</sup>	234-4719 <sup>4</sup>	234-4212 <sup>4</sup>
V8-4.7	2003	Auto Trans	234-4718 <sup>5</sup>	234-4212 <sup>5</sup>	234-4718 <sup>5</sup>	234-4212 <sup>5</sup>
V8-4.7	2003	Manual Trans	234-4718 <sup>1</sup>	234-4212 <sup>1</sup>	234-4718 <sup>1</sup>	234-4212 <sup>1</sup>
V8-4.7	2002-2001	Auto Trans	234-4654 <sup>4</sup>	234-4209 <sup>4</sup>	234-4749 <sup>4</sup>	234-4209 <sup>4</sup>
V8-4.7	2002-2001	Auto Trans	234-4654 <sup>5</sup>	234-4209 <sup>5</sup>	234-4764 <sup>5</sup>	234-4209 <sup>5</sup>
V8-4.7	2002-2001	Manual Trans	234-4654 <sup>1</sup>	234-4209 <sup>1</sup>	234-4764 <sup>1</sup>	234-4209 <sup>1</sup>
V8-4.7	2000	Calif.; Auto Trans	234-4634 <sup>1</sup>	234-4209 <sup>1</sup>	234-4761 <sup>1</sup>	234-4209 <sup>1</sup>
V8-4.7	2000	Calif.; Manual Trans	234-4634 <sup>1</sup>	234-4209 <sup>1</sup>	234-4602 <sup>1</sup>	234-4209 <sup>1</sup>
V8-4.7	2000	Exc. Calif.	234-4634 <sup>1</sup>	234-4209 <sup>1</sup>	234-4602	234-4209
V8-5.2	1999-1997	w/ 12" Downstream Sensor	234-4077	234-4210	234-4078	234-4210

<sup>1</sup> 2 Required / Requis 2 / Requeridos 2 <sup>4</sup> Left Side / Côté gauche / Lado izquierdo <sup>5</sup> Right Side / Côté droit / Lado derecho



ENGINE MOTEUR MOTOR	YEAR ANNEE AÑO	APPLICATION INFORMATION INFORMATION D'APPLICATION INFORMACION DE APLICACION	UPSTREAM / AVANT - C.C. / ANTES DEL C.C.		DOWNSTREAM / APRS - C.C. / DESPUES DEL C.C.	
			TYPE / TIPO O.E.	UNIVERS.	TYPE / TIPO O.E.	UNIVERS.
<b>DODGE [cont]</b>						
<b>DAKOTA [cont]</b>						
V8-5.2	1997-1996	w/ 18" Downstream Sensor	234-4077	234-4210	234-4079	234-4210
V8-5.2	1995-1990	w/ 18" Sensor	234-4003	234-4210	-	-
V8-5.2	1993-1990	w/ 34" Sensor	234-4013	234-4210	-	-
V8-5.2	1989		234-4004	234-4210	-	-
V8-5.9	2003-2002	Exc. Quad Cab	234-4766 <sup>4</sup>	-	234-4767 <sup>4</sup>	234-4210 <sup>4</sup>
V8-5.9	2003-2002	Exc. Quad Cab	234-4770 <sup>5</sup>	-	234-4771 <sup>5</sup>	234-4210 <sup>5</sup>
V8-5.9	2003-2002	Quad Cab; Calif.	234-4766 <sup>4</sup>	-	234-4767 <sup>4</sup>	234-4210 <sup>4</sup>
V8-5.9	2003-2002	Quad Cab; Calif.	234-4770 <sup>5</sup>	-	234-4771 <sup>5</sup>	234-4210 <sup>5</sup>
V8-5.9	2003	Quad Cab; Exc. Calif.	234-4030 <sup>1</sup>	234-4210 <sup>1</sup>	234-4772 <sup>1</sup>	234-4210 <sup>1</sup>
V8-5.9	2002	Quad Cab; Exc. Calif.	234-4030	234-4210	234-4772	234-4210
V8-5.9	2001		234-4766 <sup>4</sup>	-	234-4767 <sup>4</sup>	234-4210 <sup>4</sup>
V8-5.9	2001		234-4770 <sup>5</sup>	-	234-4771 <sup>5</sup>	234-4210 <sup>5</sup>
V8-5.9	2000		234-4077	234-4210	234-4078	234-4210
V8-5.9	1999-1998	Club Cab	234-4077 <sup>4</sup>	234-4210 <sup>4</sup>	234-4079	234-4210
V8-5.9	1999-1998	Club Cab	234-4076 <sup>5</sup>	234-4210 <sup>5</sup>	-	-
V8-5.9	1999-1998	Regular Cab	234-4077 <sup>4</sup>	234-4210 <sup>4</sup>	234-4078	234-4210
V8-5.9	1999-1998	Regular Cab	234-4076 <sup>5</sup>	234-4210 <sup>5</sup>	-	-
<b>DART</b>						
L4-1.4	2015-2013		234-5075	-	234-4748	-
L4-2.0	2015-2013		234-4579	-	234-4545	-
L4-2.4	2015-2013		234-5150	-	234-4545	-
<b>DAYTONA</b>						
L4-2.2	1993-1992		234-4004	234-4210	-	-
L4-2.2	1990-1989		234-4004	234-4210	-	-
L4-2.2	1988-1987		234-3003	234-3000	-	-
L4-2.2	1986-1984		234-1002	234-1000	-	-
L4-2.5	1993-1989		234-4004	234-4210	-	-
L4-2.5	1988-1987		234-3003	234-3000	-	-
L4-2.5	1986		234-1002	234-1000	-	-
V6-3.0	1993-1990		234-4004	234-4210	-	-
<b>DIPLOMAT</b>						
L6-3.7	1983-1979		234-1002	234-1000	-	-
V8-5.2	1989-1980		234-1002	234-1000	-	-
<b>DURANGO</b>						
V6-3.6	2014-2012		234-4545 <sup>5</sup>	-	234-4545 <sup>5</sup>	-
V6-3.6	2014		234-4547 <sup>4</sup>	-	234-4547 <sup>4</sup>	-
V6-3.6	2013-2012		234-4547 <sup>4</sup>	-	234-4545 <sup>4</sup>	-
V6-3.6	2011		234-4545 <sup>1</sup>	-	234-4545 <sup>1</sup>	-
V6-3.7	2009-2007		234-4587 <sup>1</sup>	-	234-4588 <sup>1</sup>	-
V6-3.7	2006		234-4593 <sup>1</sup>	-	234-4587 <sup>1</sup>	-

<sup>1</sup> 2 Required / Requis 2 / Requeridos 2 <sup>4</sup> Left Side / Côté gauche / Lado izquierdo <sup>5</sup> Right Side / Côté droit / Lado derecho



ENGINE MOTEUR MOTOR	YEAR ANNEE AÑO	APPLICATION INFORMATION INFORMATION D'APPLICATION INFORMACION DE APLICACION	UPSTREAM / AVANT - C.C. / ANTES DEL C.C.		DOWNSTREAM / APRS - C.C. / DESPUES DEL C.C.	
			TYPE / TIPO O.E.	UNIVERS.	TYPE / TIPO O.E.	UNIVERS.
<b>DODGE [cont]</b>						
<b>DURANGO [cont]</b>						
V6-3.7	2005		234-4593 <sup>4</sup>	-	234-4588 <sup>4</sup>	-
V6-3.7	2005		234-4593 <sup>5</sup>	-	234-4587 <sup>5</sup>	-
V6-3.7	2004		234-4587 <sup>4</sup>	-	234-4767 <sup>4</sup>	234-4210 <sup>4</sup>
V6-3.7	2004		234-4587 <sup>5</sup>	-	234-4771 <sup>5</sup>	234-4210 <sup>5</sup>
V6-3.9	1999-1998		234-4077	234-4210	234-4078	234-4210
V8-4.7	2009-2008		234-4587 <sup>1</sup>	-	234-4588 <sup>1</sup>	-
V8-4.7	2007		234-4744 <sup>1</sup>	234-4212 <sup>1</sup>	234-4756 <sup>1</sup>	234-4212 <sup>1</sup>
V8-4.7	2006-2005		234-4744 <sup>4</sup>	234-4212 <sup>4</sup>	234-4756 <sup>4</sup>	234-4212 <sup>4</sup>
V8-4.7	2006-2005		234-4744 <sup>5</sup>	234-4212 <sup>5</sup>	234-4744 <sup>5</sup>	234-4212 <sup>5</sup>
V8-4.7	2004		234-4718 <sup>4</sup>	234-4212 <sup>4</sup>	234-4745 <sup>4</sup>	234-4212 <sup>4</sup>
V8-4.7	2004		234-4718 <sup>5</sup>	234-4212 <sup>5</sup>	234-4718 <sup>5</sup>	234-4212 <sup>5</sup>
V8-4.7	2003	Calif.	234-4718 <sup>4</sup>	234-4212 <sup>4</sup>	234-4719 <sup>4</sup>	234-4212 <sup>4</sup>
V8-4.7	2003	Calif.	234-4718 <sup>5</sup>	234-4212 <sup>5</sup>	234-4718 <sup>5</sup>	234-4212 <sup>5</sup>
V8-4.7	2003	Exc. Calif.	234-4718	234-4212	234-4718	234-4212
V8-4.7	2002	Calif.; Current Generation Engine Controller	234-4654 <sup>4</sup>	234-4209 <sup>4</sup>	234-4749 <sup>4</sup>	234-4209 <sup>4</sup>
V8-4.7	2002	Calif.; Current Generation Engine Controller	234-4654 <sup>5</sup>	234-4209 <sup>5</sup>	234-4764 <sup>5</sup>	234-4209 <sup>5</sup>
V8-4.7	2002	Calif.; Next Generation Engine Controller	234-4718 <sup>4</sup>	234-4212 <sup>4</sup>	234-4749 <sup>4</sup>	234-4209 <sup>4</sup>
V8-4.7	2002	Calif.; Next Generation Engine Controller	234-4718 <sup>5</sup>	234-4212 <sup>5</sup>	234-4764 <sup>5</sup>	234-4209 <sup>5</sup>
V8-4.7	2002	Exc. Calif.; Current Generation Engine Controller	234-4654	234-4209	234-4764	234-4209
V8-4.7	2002	Exc. Calif.; Next Generation Engine Controller	234-4718	234-4212	234-4764	234-4209
V8-4.7	2001	Calif.	234-4654 <sup>4</sup>	234-4209 <sup>4</sup>	234-4749 <sup>4</sup>	234-4209 <sup>4</sup>
V8-4.7	2001	Calif.	234-4654 <sup>5</sup>	234-4209 <sup>5</sup>	234-4764 <sup>5</sup>	234-4209 <sup>5</sup>
V8-4.7	2001	Exc. Calif.	234-4654	234-4209	234-4764	234-4209
V8-4.7	2000		234-4634 <sup>4</sup>	234-4209 <sup>4</sup>	234-4761 <sup>4</sup>	234-4209 <sup>4</sup>
V8-4.7	2000		234-4634 <sup>5</sup>	234-4209 <sup>5</sup>	234-4602 <sup>5</sup>	234-4209 <sup>5</sup>
V8-5.2	2000-1998		234-4077	234-4210	234-4078	234-4210
V8-5.7	2014-2012		234-4545 <sup>1</sup>	-	234-4545 <sup>1</sup>	-
V8-5.7	2011		234-4417 <sup>1</sup>	-	234-4417 <sup>1</sup>	-
V8-5.7	2009	Gas Engine	234-4587 <sup>1</sup>	-	234-4587 <sup>1</sup>	-
V8-5.7	2009	Hybrid Engine	234-4588 <sup>1</sup>	-	234-4588 <sup>1</sup>	-
V8-5.7	2008-2007		234-4587 <sup>1</sup>	-	234-4587 <sup>1</sup>	-
V8-5.7	2006-2005		234-4593 <sup>5</sup>	-	234-4587 <sup>5</sup>	-
V8-5.7	2006		234-4593 <sup>4</sup>	-	234-4587 <sup>4</sup>	-
V8-5.7	2005		234-4593 <sup>4</sup>	-	234-4588 <sup>4</sup>	-
V8-5.7	2004		234-4587 <sup>4</sup>	-	234-4767 <sup>4</sup>	234-4210 <sup>4</sup>
V8-5.7	2004		234-4587 <sup>5</sup>	-	234-4771 <sup>5</sup>	234-4210 <sup>5</sup>
V8-5.9	2003-2002	Exc. Calif.	234-4030	234-4210	234-4772	234-4210
V8-5.9	2003-2001	Calif.	234-4766 <sup>4</sup>	-	234-4767 <sup>4</sup>	234-4210 <sup>4</sup>
V8-5.9	2003-2001	Calif.	234-4770 <sup>5</sup>	-	234-4771 <sup>5</sup>	234-4210 <sup>5</sup>

<sup>1</sup> 2 Required / Requis 2 / Requeridos 2 <sup>4</sup> Left Side / Côté gauche / Lado izquierdo <sup>5</sup> Right Side / Côté droit / Lado derecho



ENGINE MOTEUR MOTOR	YEAR ANNEE AÑO	APPLICATION INFORMATION INFORMATION D'APPLICATION INFORMACION DE APLICACION	UPSTREAM / AVANT - C.C. / ANTES DEL C.C.		DOWNSTREAM / APRS - C.C. / DESPUES DEL C.C.	
			TYPE / TIPO O.E.	UNIVERS.	TYPE / TIPO O.E.	UNIVERS.
<b>DODGE [cont]</b>						
<b>DURANGO [cont]</b>						
V8-5.9	2001	Exc. Calif.	234-4654	234-4209	234-4772	234-4210
V8-5.9	2000-1998		234-4077	234-4210	234-4078	234-4210
<b>DYNASTY</b>						
L4-2.5	1993-1989		234-4004	234-4210	-	-
L4-2.5	1988		234-3003	234-3000	-	-
V6-3.0	1993-1989		234-4004	234-4210	-	-
V6-3.0	1988		234-3003	234-3000	-	-
V6-3.3	1993-1990		234-4004	234-4210	-	-
<b>GRAND CARAVAN</b>						
L4-2.4	1997		234-4005	234-4210	234-4021	234-4210
L4-2.4	1996		234-4077	234-4210	234-4076	234-4210
L4-2.5	1989		234-4004	234-4210	-	-
L4-2.5	1988-1987		234-3003	234-3000	-	-
V6-3.0	2000	Exc. TLEV	234-4077	234-4210	234-4021	234-4210
V6-3.0	2000	TLEV	234-4077	234-4210	234-4082	234-4210
V6-3.0	1999		234-4077	234-4210	234-4021	234-4210
V6-3.0	1998-1996	Exc. TLEV	234-4077	234-4210	234-4021	234-4210
V6-3.0	1998-1996	TLEV	234-4077	234-4210	234-4082	234-4210
V6-3.0	1995		234-4077	234-4210	-	-
V6-3.0	1994-1992		234-4004	234-4210	-	-
V6-3.0	1989		234-4004	234-4210	-	-
V6-3.0	1988-1987		234-3003	234-3000	-	-
V6-3.3	2010-2008		234-4881	-	234-4588	-
V6-3.3	2007-2006		234-4880	-	234-4588	-
V6-3.3	2005	From 07/09/04; XZZ Option Code	234-4880	-	234-4588	-
V6-3.3	2005	To 07/08/04; Exc. XZZ Option Code	234-4410	-	234-4588	-
V6-3.3	2004		234-4410	-	234-4588	-
V6-3.3	2003-2001		234-4216	-	234-4010	234-4210
V6-3.3	2000-1996	Exc. TLEV	234-4077	234-4210	234-4021	234-4210
V6-3.3	2000-1996	TLEV	234-4077	234-4210	234-4082	234-4210
V6-3.3	1995		234-4077	234-4210	-	-
V6-3.3	1994-1990		234-4004	234-4210	-	-
V6-3.6	2015-2011		234-4545 <sup>4</sup>	-	234-4545 <sup>4</sup>	-
V6-3.6	2015-2011		234-4545 <sup>5</sup>	-	234-4547 <sup>5</sup>	-
V6-3.8	2010-2008		234-4881	-	234-4588	-
V6-3.8	2007-2006		234-4880	-	234-4588	-
V6-3.8	2005	From 07/09/04; XZZ Option Code	234-4880	-	234-4588	-
V6-3.8	2005	To 07/08/04; Exc. XZZ Option Code	234-4410	-	234-4588	-
V6-3.8	2004		234-4410	-	234-4588	-
V6-3.8	2003-2001		234-4216	-	234-4010	234-4210
V6-3.8	2000-1996	Exc. TLEV	234-4077	234-4210	234-4021	234-4210

<sup>4</sup> Left Side / Côté gauche / Lado izquierdo <sup>5</sup> Right Side / Côté droit / Lado derecho



ENGINE MOTEUR MOTOR	YEAR ANNEE AÑO	APPLICATION INFORMATION INFORMATION D'APPLICATION INFORMACION DE APLICACION	UPSTREAM / AVANT - C.C. / ANTES DEL C.C.		DOWNSTREAM / APRES - C.C. / DESPUES DEL C.C.	
			TYPE / TIPO O.E.	UNIVERS.	TYPE / TIPO O.E.	UNIVERS.
<b>DODGE [cont]</b>						
<b>GRAND CARAVAN [cont]</b>						
V6-3.8	2000-1996	TLEV	234-4077	234-4210	234-4082	234-4210
V6-3.8	1995		234-4077	234-4210	-	-
V6-3.8	1994		234-4004	234-4210	-	-
V6-4.0	2010-2008		234-4587 <sup>1</sup>	-	234-4587 <sup>1</sup>	-
<b>INTREPID</b>						
V6-2.7	2004-2002		234-4592 <sup>1</sup>	-	234-4078 <sup>1</sup>	234-4210 <sup>1</sup>
V6-2.7	2001-1998		234-4078 <sup>1</sup>	234-4210 <sup>1</sup>	234-4078 <sup>1</sup>	234-4210 <sup>1</sup>
V6-3.2	2001-1998		234-4078 <sup>1</sup>	234-4210 <sup>1</sup>	234-4078 <sup>1</sup>	234-4210 <sup>1</sup>
V6-3.3	1997-1996	w/ 17" Downstream Sensor	234-4077	234-4210	234-4002	234-4210
V6-3.3	1997-1996	w/ 22" Downstream Sensor	234-4077	234-4210	234-4003	234-4210
V6-3.3	1995-1993		234-4004	234-4210	-	-
V6-3.5	2004-2002		234-4592 <sup>1</sup>	-	234-4078 <sup>1</sup>	234-4210 <sup>1</sup>
V6-3.5	2001-2000		234-4078 <sup>1</sup>	234-4210 <sup>1</sup>	234-4078 <sup>1</sup>	234-4210 <sup>1</sup>
V6-3.5	1997-1996	w/ 17" Downstream Sensor	234-4077 <sup>1</sup>	234-4210 <sup>1</sup>	234-4002 <sup>1</sup>	234-4210 <sup>1</sup>
V6-3.5	1997-1996	w/ 22" Downstream Sensor	234-4077 <sup>1</sup>	234-4210 <sup>1</sup>	234-4003 <sup>1</sup>	234-4210 <sup>1</sup>
V6-3.5	1995-1994	Square Connector	234-4004	234-4210	-	-
V6-3.5	1995-1993	Round Connector	234-4077	234-4210	-	-
<b>JOURNEY</b>						
L4-2.4	2014-2011		234-4547	-	234-4547	-
L4-2.4	2010-2009		234-4881	-	234-4881	-
V6-3.5	2010-2009		234-4587 <sup>1</sup>	-	234-4587 <sup>1</sup>	-
V6-3.6	2014-2012		234-4545 <sup>4</sup>	-	234-4547 <sup>4</sup>	-
V6-3.6	2014-2012		234-4545 <sup>5</sup>	-	234-4545 <sup>5</sup>	-
V6-3.6	2011		234-4545 <sup>1</sup>	-	234-4545 <sup>1</sup>	-
<b>LANCER</b>						
L4-2.2	1989		234-4004	234-4210	-	-
L4-2.2	1988-1987		234-3003	234-3000	-	-
L4-2.2	1986-1985		234-1002	234-1000	-	-
L4-2.5	1989		234-4004	234-4210	-	-
L4-2.5	1988-1987		234-3003	234-3000	-	-
L4-2.5	1986		234-1002	234-1000	-	-
<b>MAGNUM</b>						
V6-2.7	2008-2007		234-4587 <sup>4</sup>	-	234-4587 <sup>4</sup>	-
V6-2.7	2008-2007		234-4587 <sup>5</sup>	-	234-4588 <sup>5</sup>	-
V6-2.7	2006-2005		234-4587 <sup>1</sup>	-	234-4587 <sup>1</sup>	-
V6-3.5	2008		234-4587 <sup>1</sup>	-	234-4587 <sup>1</sup>	-
V6-3.5	2007	Calif.	234-4587 <sup>4</sup>	-	234-4587 <sup>4</sup>	-
V6-3.5	2007	Calif.	234-4587 <sup>5</sup>	-	234-4588 <sup>5</sup>	-
V6-3.5	2007	Exc. Calif.	234-4587 <sup>1</sup>	-	234-4587 <sup>1</sup>	-
V6-3.5	2006-2005		234-4587 <sup>1</sup>	-	234-4587 <sup>1</sup>	-

<sup>1</sup> 2 Required / Requis 2 / Requeridos 2 <sup>4</sup> Left Side / Côté gauche / Lado izquierdo <sup>5</sup> Right Side / Côté droit / Lado derecho



ENGINE MOTEUR MOTOR	YEAR ANNEE AÑO	APPLICATION INFORMATION INFORMATION D'APPLICATION INFORMACION DE APLICACION	UPSTREAM / AVANT - C.C. / ANTES DEL C.C.		DOWNSTREAM / APRS - C.C. / DESPUES DEL C.C.	
			TYPE / TIPO O.E.	UNIVERS.	TYPE / TIPO O.E.	UNIVERS.
<b>DODGE [cont]</b>						
<b>MAGNUM [cont]</b>						
V8-5.7	2008		234-4587 <sup>1</sup>	-	234-4587 <sup>1</sup>	-
V8-5.7	2007	From 07/28/06	234-4418 <sup>4</sup>	-	234-4587 <sup>4</sup>	-
V8-5.7	2007	From 07/28/06	234-4418 <sup>5</sup>	-	234-4588 <sup>5</sup>	-
V8-5.7	2007	To 07/28/06	234-4587 <sup>4</sup>	-	234-4587 <sup>4</sup>	-
V8-5.7	2007	To 07/28/06	234-4587 <sup>5</sup>	-	234-4588 <sup>5</sup>	-
V8-5.7	2006-2005		234-4593 <sup>4</sup>	-	234-4587 <sup>4</sup>	-
V8-5.7	2006-2005		234-4593 <sup>5</sup>	-	234-4588 <sup>5</sup>	-
V8-6.1	2008		234-4587 <sup>1</sup>	-	234-4587 <sup>1</sup>	-
V8-6.1	2007	From 07/28/06	234-4418 <sup>4</sup>	-	234-4587 <sup>4</sup>	-
V8-6.1	2007	From 07/28/06	234-4418 <sup>5</sup>	-	234-4588 <sup>5</sup>	-
V8-6.1	2007	To 07/28/06	234-4587 <sup>4</sup>	-	234-4587 <sup>4</sup>	-
V8-6.1	2007	To 07/28/06	234-4587 <sup>5</sup>	-	234-4588 <sup>5</sup>	-
V8-6.1	2006		234-4593 <sup>4</sup>	-	234-4587 <sup>4</sup>	-
V8-6.1	2006		234-4593 <sup>5</sup>	-	234-4588 <sup>5</sup>	-
<b>MINI RAM</b>						
L4-2.2	1988		234-3003	234-3000	-	-
L4-2.2	1987-1984		234-1002	234-1000	-	-
L4-2.5	1988-1987		234-3003	234-3000	-	-
L4-2.6	1988		234-3003	234-3000	-	-
L4-2.6	1987-1984		234-1005	234-1000	-	-
V6-3.0	1988-1987		234-3003	234-3000	-	-
<b>MIRADA</b>						
L6-3.7	1983-1980		234-1002	234-1000	-	-
V8-5.2	1983-1980		234-1002	234-1000	-	-
V8-5.9	1980		234-1002	234-1000	-	-
<b>MONACO</b>						
V6-3.0	1992-1991		234-4013	234-4210	-	-
<b>NEON</b>						
L4-2.0	2005	w/ 11" Downstream Sensor	234-4588	-	234-4232	234-4212
L4-2.0	2005	w/ 24" Downstream Sensor	234-4588	-	234-4230	234-4210
L4-2.0	2004	VIN C; w/ 15" Upstream Sensor	234-4587	-	234-4232	234-4212
L4-2.0	2004	VIN C; w/ 18" Upstream Sensor	234-4588	-	234-4232	234-4212
L4-2.0	2004	VIN F	234-4588	-	234-4232	234-4212
L4-2.0	2003		234-4587	-	234-4232	234-4212
L4-2.0	2002-2001	VIN C; Calif.	234-4882	-	234-4078	234-4210
L4-2.0	2002-2001	VIN C; Exc. Calif.	234-4882	-	234-4008	234-4210
L4-2.0	2002-2001	VIN F	234-4882	-	234-4008	234-4210
L4-2.0	2000	Exc. ULEV	234-4115	-	234-4614	234-4210
L4-2.0	2000	ULEV	234-4882	-	234-4078	234-4210
L4-2.0	1999-1997		234-4077	234-4210	234-4614	234-4210

<sup>1</sup> 2 Required / Requis 2 / Requeridos 2 <sup>4</sup> Left Side / Côté gauche / Lado izquierdo <sup>5</sup> Right Side / Côté droit / Lado derecho



ENGINE MOTEUR MOTOR	YEAR ANNEE AÑO	APPLICATION INFORMATION INFORMATION D'APPLICATION INFORMACION DE APLICACION	UPSTREAM / AVANT - C.C. / ANTES DEL C.C.		DOWNSTREAM / APRES - C.C. / DESPUES DEL C.C.	
			TYPE / TIPO O.E.	UNIVERS.	TYPE / TIPO O.E.	UNIVERS.
<b>DODGE [cont]</b>						
<b>NEON [cont]</b>						
L4-2.0	1996-1995		234-4004	234-4210	234-4013	234-4210
L4-2.4	2005-2003		234-4587	-	234-4232	234-4212
<b>NITRO</b>						
V6-3.7	2011-2007		234-4587 <sup>1</sup>	-	234-4587 <sup>1</sup>	-
V6-4.0	2011-2007		234-4587 <sup>1</sup>	-	234-4587 <sup>1</sup>	-
<b>OMNI</b>						
L4-1.6	1986-1983		234-1002	234-1000	-	-
L4-1.7	1983-1980		234-1002	234-1000	-	-
L4-2.2	1990-1989		234-4004	234-4210	-	-
L4-2.2	1988		234-3003	234-3000	-	-
L4-2.2	1987		234-1002	234-1000	-	-
L4-2.2	1986	Non-Turbo	234-1002	234-1000	-	-
L4-2.2	1986	Turbo	234-3003	234-3000	-	-
L4-2.2	1985-1981		234-1002	234-1000	-	-
<b>POWER RAM 50</b>						
L4-2.0	1984		234-1005	234-1000	-	-
L4-2.0	1983		234-1002	234-1000	-	-
L4-2.6	1986-1984		234-1005	234-1000	-	-
L4-2.6	1983		234-1002	234-1000	-	-
<b>RAIDER</b>						
L4-2.6	1989-1987		234-1005	234-1000	-	-
V6-3.0	1989		234-2065	234-2000	-	-
<b>RAM 50</b>						
L4-2.0	1989-1984		234-1005	234-1000	-	-
L4-2.0	1983		234-1002	234-1000	-	-
L4-2.4	1993	Calif.; Auto Trans	234-4636	234-4209	234-4658	234-4209
L4-2.4	1993	Calif.; Manual Trans	234-4637	234-4209	234-4658	234-4209
L4-2.4	1993	Exc. Calif.	234-2067	234-2000	-	-
L4-2.4	1992-1991		234-2067	234-2000	-	-
L4-2.4	1990	Calif.	234-2067	234-2000	-	-
L4-2.4	1990	Exc. Calif.	234-1033	234-1000	-	-
L4-2.6	1989-1984		234-1005	234-1000	-	-
L4-2.6	1983		234-1002	234-1000	-	-
V6-3.0	1991-1990		234-4888	-	-	-
<b>RAM 1500 PICKUP</b>						
V6-3.7	2010-2007		234-4587 <sup>1</sup>	-	234-4587 <sup>1</sup>	-
V6-3.7	2006-2005		234-4593 <sup>1</sup>	-	234-4587 <sup>1</sup>	-
V6-3.7	2004		234-4587 <sup>1</sup>	-	234-4771 <sup>1</sup>	234-4210 <sup>1</sup>
V6-3.7	2003	Auto Trans	234-4030 <sup>1</sup>	234-4210 <sup>1</sup>	234-4772 <sup>1</sup>	234-4210 <sup>1</sup>
V6-3.7	2003	Manual Trans	234-4030 <sup>1</sup>	234-4210 <sup>1</sup>	234-4029 <sup>1</sup>	234-4210 <sup>1</sup>

<sup>1</sup> 2 Required / Requis 2 / Requeridos 2





ENGINE MOTEUR MOTOR	YEAR ANNEE AÑO	APPLICATION INFORMATION INFORMATION D'APPLICATION INFORMACION DE APLICACION	UPSTREAM / AVANT - C.C. / ANTES DEL C.C.		DOWNSTREAM / APRS - C.C. / DESPUES DEL C.C.	
			TYPE / TIPO O.E.	UNIVERS.	TYPE / TIPO O.E.	UNIVERS.
<b>DODGE [cont]</b>						
<b>RAM 1500 PICKUP [cont]</b>						
V6-3.7	2002		234-4030 <sup>1</sup>	234-4210 <sup>1</sup>	234-4029 <sup>1</sup>	234-4210 <sup>1</sup>
V6-3.9	2001		234-4769 <sup>1</sup>	234-4210 <sup>1</sup>	234-4029	234-4210
V6-3.9	2000		234-4077 <sup>1</sup>	234-4210 <sup>1</sup>	234-4079	234-4210
V6-3.9	1999		234-4077 <sup>4</sup>	234-4210 <sup>4</sup>	234-4079	234-4210
V6-3.9	1999		234-4076 <sup>5</sup>	234-4210 <sup>5</sup>	-	-
V6-3.9	1998-1997	w/ 12" Upstream Sensor	234-4077	234-4210	234-4079	234-4210
V6-3.9	1998-1997	w/ 18" Upstream Sensor	234-4076	234-4210	234-4079	234-4210
V6-3.9	1996		234-4077 <sup>4</sup>	234-4210 <sup>4</sup>	234-4079	234-4210
V6-3.9	1996		234-4079 <sup>5</sup>	234-4210 <sup>5</sup>	-	-
V6-3.9	1995	Round Connector	234-4076	234-4210	-	-
V6-3.9	1995	Square Connector	234-4004	234-4210	-	-
V6-3.9	1994		234-4003	234-4210	-	-
V8-4.7	2010-2008		234-4587 <sup>1</sup>	-	234-4587 <sup>1</sup>	-
V8-4.7	2007-2005		234-4744 <sup>1</sup>	234-4212 <sup>1</sup>	234-4744 <sup>1</sup>	234-4212 <sup>1</sup>
V8-4.7	2004		234-4718 <sup>1</sup>	234-4212 <sup>1</sup>	234-4718 <sup>1</sup>	234-4212 <sup>1</sup>
V8-4.7	2003	Calif.	234-4718 <sup>1</sup>	234-4212 <sup>1</sup>	234-4718 <sup>1</sup>	234-4212 <sup>1</sup>
V8-4.7	2003	Exc. Calif.	234-4718 <sup>1</sup>	234-4212 <sup>1</sup>	234-4719 <sup>1</sup>	234-4212 <sup>1</sup>
V8-4.7	2002	Auto Trans, Exc. Calif.	234-4654	234-4209	234-4749	234-4209
V8-4.7	2002	Calif.	234-4654 <sup>4</sup>	234-4209 <sup>4</sup>	234-4749 <sup>4</sup>	234-4209 <sup>4</sup>
V8-4.7	2002	Calif.	234-4654 <sup>5</sup>	234-4209 <sup>5</sup>	234-4764 <sup>5</sup>	234-4209 <sup>5</sup>
V8-4.7	2002	Manual Trans, Exc. Calif.	234-4653	234-4209	234-4749	234-4209
V8-5.2	2001	Auto Trans; Calif.	234-4077 <sup>1</sup>	234-4210 <sup>1</sup>	234-4029	234-4210
V8-5.2	2001	Auto Trans; Exc. Calif.	234-4769 <sup>1</sup>	234-4210 <sup>1</sup>	234-4029	234-4210
V8-5.2	2001	Manual Trans	234-4030 <sup>1</sup>	234-4210 <sup>1</sup>	234-4029	234-4210
V8-5.2	2000-1999		234-4077 <sup>4</sup>	234-4210 <sup>4</sup>	234-4079	234-4210
V8-5.2	2000		234-4079 <sup>5</sup>	234-4210 <sup>5</sup>	-	-
V8-5.2	1999		234-4076 <sup>5</sup>	234-4210 <sup>5</sup>	-	-
V8-5.2	1998-1997	w/ 12" Upstream Sensor	234-4077	234-4210	234-4079	234-4210
V8-5.2	1998-1997	w/ 18" Upstream Sensor	234-4076	234-4210	234-4079	234-4210
V8-5.2	1996		234-4077 <sup>4</sup>	234-4210 <sup>4</sup>	234-4079	234-4210
V8-5.2	1996		234-4079 <sup>5</sup>	234-4210 <sup>5</sup>	-	-
V8-5.2	1995	Round Connector	234-4076	234-4210	-	-
V8-5.2	1995	Square Connector	234-4004	234-4210	-	-
V8-5.2	1994	w/ 12" Sensor	234-4004	234-4210	-	-
V8-5.2	1994	w/ 18" Sensor	234-4003	234-4210	-	-
V8-5.7	2009		234-4587 <sup>4</sup>	-	234-4587 <sup>4</sup>	-
V8-5.7	2009		234-4588 <sup>5</sup>	-	234-4588 <sup>5</sup>	-
V8-5.7	2008-2007		234-4587 <sup>1</sup>	-	234-4587 <sup>1</sup>	-
V8-5.7	2006-2005		234-4593 <sup>1</sup>	-	234-4587 <sup>1</sup>	-
V8-5.7	2004		234-4587 <sup>1</sup>	-	234-4767 <sup>1</sup>	234-4210 <sup>1</sup>

<sup>1</sup> 2 Required / Requis 2 / Requeridos 2 <sup>4</sup> Left Side / Côté gauche / Lado izquierdo <sup>5</sup> Right Side / Côté droit / Lado derecho



ENGINE MOTEUR MOTOR	YEAR ANNEE AÑO	APPLICATION INFORMATION INFORMATION D'APPLICATION INFORMACION DE APLICACION	UPSTREAM / AVANT - C.C. / ANTES DEL C.C.		DOWNSTREAM / APRS - C.C. / DESPUES DEL C.C.	
			TYPE / TIPO O.E.	UNIVERS.	TYPE / TIPO O.E.	UNIVERS.
<b>DODGE [cont]</b>						
<b>RAM 1500 PICKUP [cont]</b>						
V8-5.7	2003		234-4770 <sup>1</sup>	-	234-4767 <sup>1</sup>	234-4210 <sup>1</sup>
V8-5.9	2003		234-4769 <sup>1</sup>	234-4210 <sup>1</sup>	234-4029 <sup>1</sup>	234-4210 <sup>1</sup>
V8-5.9	2002-2001	Manual Trans; Exc. Calif.	234-4030 <sup>1</sup>	234-4210 <sup>1</sup>	234-4029	234-4210
V8-5.9	2002	Auto Trans; Calif.	234-4770 <sup>1</sup>	-	234-4767 <sup>1</sup>	234-4210 <sup>1</sup>
V8-5.9	2002	Auto Trans; Exc. Calif.	234-4769 <sup>1</sup>	234-4210 <sup>1</sup>	234-4029	234-4210
V8-5.9	2002	Manual Trans; Calif.	234-4030 <sup>1</sup>	234-4210 <sup>1</sup>	234-4767 <sup>1</sup>	234-4210 <sup>1</sup>
V8-5.9	2001	Auto Trans; Calif.	234-4770 <sup>1</sup>	-	234-4767	234-4210
V8-5.9	2001	Auto Trans; Exc. Calif.	234-4769 <sup>1</sup>	234-4210 <sup>1</sup>	234-4767	234-4210
V8-5.9	2001	Manual Trans; Calif.	234-4077 <sup>1</sup>	234-4210 <sup>1</sup>	234-4029	234-4210
V8-5.9	2000		234-4077 <sup>1</sup>	234-4210 <sup>1</sup>	234-4079	234-4210
V8-5.9	1999		234-4077 <sup>4</sup>	234-4210 <sup>4</sup>	234-4079	234-4210
V8-5.9	1999		234-4076 <sup>5</sup>	234-4210 <sup>5</sup>	-	-
V8-5.9	1998-1997	w/ 12" Upstream Sensors	234-4077 <sup>1</sup>	234-4210 <sup>1</sup>	234-4079	234-4210
V8-5.9	1998-1997	w/ 18" Upstream Sensors	234-4076 <sup>1</sup>	234-4210 <sup>1</sup>	234-4079	234-4210
V8-5.9	1996		234-4077 <sup>4</sup>	234-4210 <sup>4</sup>	234-4079	234-4210
V8-5.9	1996		234-4079 <sup>5</sup>	234-4210 <sup>5</sup>	-	-
V8-5.9	1995	Round Connector	234-4076	234-4210	-	-
V8-5.9	1995	Square Connector	234-4004	234-4210	-	-
V8-5.9	1994		234-4003	234-4210	-	-
V10-8.3	2006-2004		234-4587 <sup>4</sup>	-	234-4767 <sup>4</sup>	234-4210 <sup>4</sup>
V10-8.3	2006-2004		234-4588 <sup>5</sup>	-	234-4771 <sup>5</sup>	234-4210 <sup>5</sup>
<b>RAM 1500 VAN</b>						
V6-3.9	2003-2001		234-4030	234-4210	234-4029	234-4210
V6-3.9	2000-1999		234-4077	234-4210	234-4079	234-4210
V8-5.2	2003-2001		234-4030	234-4210	234-4029	234-4210
V8-5.2	2000-1999		234-4077	234-4210	234-4079	234-4210
V8-5.7	2010		234-4587 <sup>4</sup>	-	234-4587 <sup>4</sup>	-
V8-5.7	2010		234-4588 <sup>5</sup>	-	234-4588 <sup>5</sup>	-
V8-5.9	2003		234-4030	234-4210	234-4029	234-4210
V8-5.9	2002-2001	Calif.	234-4770 <sup>1</sup>	-	234-4771	234-4210
V8-5.9	2002-2001	Exc. Calif.	234-4030	234-4210	234-4029	234-4210
V8-5.9	2000-1999		234-4077	234-4210	234-4079	234-4210
<b>RAM 2500 PICKUP</b>						
L6-5.9	2002-2001	Manual Trans; Exc. Calif.	234-4030 <sup>1</sup>	234-4210 <sup>1</sup>	234-4029	234-4210
L6-5.9	2002	Auto Trans; Calif.	234-4770 <sup>1</sup>	-	234-4767 <sup>1</sup>	234-4210 <sup>1</sup>
L6-5.9	2002	Auto Trans; Exc. Calif.	234-4769 <sup>1</sup>	234-4210 <sup>1</sup>	234-4029	234-4210
L6-5.9	2002	Manual Trans; Calif.	234-4030 <sup>1</sup>	234-4210 <sup>1</sup>	234-4767 <sup>1</sup>	234-4210 <sup>1</sup>
L6-5.9	2001	Auto Trans; Calif.	234-4770 <sup>1</sup>	-	234-4767	234-4210
L6-5.9	2001	Auto Trans; Exc. Calif.	234-4769 <sup>1</sup>	234-4210 <sup>1</sup>	234-4767	234-4210

<sup>1</sup> 2 Required / Requis 2 / Requeridos 2 <sup>4</sup> Left Side / Côté gauche / Lado izquierdo <sup>5</sup> Right Side / Côté droit / Lado derecho



ENGINE MOTEUR MOTOR	YEAR ANNEE AÑO	APPLICATION INFORMATION INFORMATION D'APPLICATION INFORMACION DE APLICACION	UPSTREAM / AVANT - C.C. / ANTES DEL C.C.		DOWNSTREAM / APRS - C.C. / DESPUES DEL C.C.	
			TYPE / TIPO O.E.	UNIVERS.	TYPE / TIPO O.E.	UNIVERS.
<b>DODGE [cont]</b>						
<b>RAM 2500 PICKUP [cont]</b>						
L6-5.9	2001	Manual Trans; Calif.	234-4077 <sup>1</sup>	234-4210 <sup>1</sup>	234-4029	234-4210
L6-5.9	2000		234-4077 <sup>1</sup>	234-4210 <sup>1</sup>	234-4079	234-4210
L6-5.9	1999		234-4077 <sup>4</sup>	234-4210 <sup>4</sup>	234-4079	234-4210
L6-5.9	1999		234-4076 <sup>5</sup>	234-4210 <sup>5</sup>	-	-
L6-5.9	1998-1997	w/ 12" Upstream Sensor	234-4077 <sup>1</sup>	234-4210 <sup>1</sup>	234-4079	234-4210
L6-5.9	1998-1997	w/ 18" Upstream Sensor	234-4076 <sup>1</sup>	234-4210 <sup>1</sup>	234-4079	234-4210
L6-5.9	1996		234-4077 <sup>4</sup>	234-4210 <sup>4</sup>	234-4079	234-4210
L6-5.9	1996		234-4079 <sup>5</sup>	234-4210 <sup>5</sup>	-	-
L6-5.9	1995	Round Connector	234-4076	234-4210	-	-
L6-5.9	1995	Square Connector	234-4004	234-4210	-	-
L6-5.9	1994		234-4003	234-4210	-	-
L6-6.7	2009-2007		234-5090	-	234-5090	-
V8-5.2	1996		234-4077 <sup>4</sup>	234-4210 <sup>4</sup>	234-4079	234-4210
V8-5.2	1996		234-4079 <sup>5</sup>	234-4210 <sup>5</sup>	-	-
V8-5.2	1995	Round Connector	234-4076	234-4210	-	-
V8-5.2	1995	Square Connector	234-4004	234-4210	-	-
V8-5.2	1994	w/ 12" Sensor	234-4004	234-4210	-	-
V8-5.2	1994	w/ 18" Sensor	234-4003	234-4210	-	-
V8-5.7	2009-2007		234-4587 <sup>1</sup>	-	234-4588 <sup>1</sup>	-
V8-5.7	2006-2005		234-4593 <sup>1</sup>	-	234-4588 <sup>1</sup>	-
V8-5.7	2004		234-4587 <sup>1</sup>	-	234-4767 <sup>1</sup>	234-4210 <sup>1</sup>
V8-5.7	2003		234-4770 <sup>1</sup>	-	234-4771 <sup>1</sup>	234-4210 <sup>1</sup>
V8-5.9	2002-2001	Manual Trans; Exc. Calif.	234-4030 <sup>1</sup>	234-4210 <sup>1</sup>	234-4029	234-4210
V8-5.9	2002	Auto Trans; Calif.	234-4770 <sup>1</sup>	-	234-4767 <sup>1</sup>	234-4210 <sup>1</sup>
V8-5.9	2002	Auto Trans; Exc. Calif.	234-4769 <sup>1</sup>	234-4210 <sup>1</sup>	234-4029	234-4210
V8-5.9	2002	Manual Trans; Calif.	234-4030 <sup>1</sup>	234-4210 <sup>1</sup>	234-4767 <sup>1</sup>	234-4210 <sup>1</sup>
V8-5.9	2001	Auto Trans; Calif.	234-4770 <sup>1</sup>	-	234-4767	234-4210
V8-5.9	2001	Auto Trans; Exc. Calif.	234-4769 <sup>1</sup>	234-4210 <sup>1</sup>	234-4767	234-4210
V8-5.9	2001	Manual Trans; Calif.	234-4077 <sup>1</sup>	234-4210 <sup>1</sup>	234-4029	234-4210
V8-5.9	2000		234-4077 <sup>1</sup>	234-4210 <sup>1</sup>	234-4079	234-4210
V8-5.9	1999		234-4077 <sup>4</sup>	234-4210 <sup>4</sup>	234-4079	234-4210
V8-5.9	1999		234-4076 <sup>5</sup>	234-4210 <sup>5</sup>	-	-
V8-5.9	1998-1997	w/ 12" Upstream Sensor	234-4077 <sup>1</sup>	234-4210 <sup>1</sup>	234-4079	234-4210
V8-5.9	1998-1997	w/ 18" Upstream Sensor	234-4076 <sup>1</sup>	234-4210 <sup>1</sup>	234-4079	234-4210
V8-5.9	1996		234-4077 <sup>4</sup>	234-4210 <sup>4</sup>	234-4079	234-4210
V8-5.9	1996		234-4079 <sup>5</sup>	234-4210 <sup>5</sup>	-	-
V8-5.9	1995	Round Connector	234-4076	234-4210	-	-
V8-5.9	1995	Square Connector	234-4004	234-4210	-	-
V8-5.9	1994		234-4003	234-4210	-	-

<sup>1</sup> 2 Required / Requis 2 / Requeridos 2 <sup>4</sup> Left Side / Côté gauche / Lado izquierdo <sup>5</sup> Right Side / Côté droit / Lado derecho



ENGINE MOTEUR MOTOR	YEAR ANNEE AÑO	APPLICATION INFORMATION INFORMATION D'APPLICATION INFORMACION DE APLICACION	UPSTREAM / AVANT - C.C. / ANTES DEL C.C.		DOWNSTREAM / APRES - C.C. / DESPUES DEL C.C.	
			TYPE / TIPO O.E.	UNIVERS.	TYPE / TIPO O.E.	UNIVERS.
<b>DODGE [cont]</b>						
<b>RAM 2500 PICKUP [cont]</b>						
V10-8.0	2003		234-4766 <sup>4</sup>	-	234-4771 <sup>4</sup>	234-4210 <sup>4</sup>
V10-8.0	2003		234-4587 <sup>5</sup>	-	234-4771 <sup>5</sup>	234-4210 <sup>5</sup>
V10-8.0	2002		234-4769 <sup>1</sup>	234-4210 <sup>1</sup>	234-4029 <sup>1</sup>	234-4210 <sup>1</sup>
V10-8.0	2001		234-4769 <sup>5</sup>	234-4210 <sup>5</sup>	-	-
V10-8.0	2001		234-4077 <sup>4</sup>	234-4210 <sup>4</sup>	234-4079	234-4210
V10-8.0	2000-1999		234-4077 <sup>4</sup>	234-4210 <sup>4</sup>	234-4079	234-4210
V10-8.0	2000-1999		234-4076 <sup>5</sup>	234-4210 <sup>5</sup>	-	-
V10-8.0	1998-1997	w/ 12" Upstream Sensor	234-4077 <sup>1</sup>	234-4210 <sup>1</sup>	234-4079	234-4210
V10-8.0	1998-1997	w/ 18" Upstream Sensor	234-4076 <sup>1</sup>	234-4210 <sup>1</sup>	234-4079	234-4210
V10-8.0	1996		234-4077 <sup>4</sup>	234-4210 <sup>4</sup>	234-4079	234-4210
V10-8.0	1996		234-4079 <sup>5</sup>	234-4210 <sup>5</sup>	-	-
V10-8.0	1995-1994		234-4004	234-4210	-	-
<b>RAM 2500 VAN</b>						
L6-6.7	2010		234-5090	-	234-5090	-
V6-3.9	2001		234-4030	234-4210	234-4029	234-4210
V8-5.2	2003-2001		234-4030	234-4210	234-4029	234-4210
V8-5.2	2000-1999		234-4077	234-4210	234-4079	234-4210
V8-5.7	2010		234-4587 <sup>1</sup>	-	234-4588 <sup>1</sup>	-
V8-5.9	2003		234-4030	234-4210	234-4029	234-4210
V8-5.9	2002-2001	Calif.	234-4770 <sup>1</sup>	-	234-4771	234-4210
V8-5.9	2002-2001	Exc. Calif.	234-4030	234-4210	234-4029	234-4210
V8-5.9	2000-1999		234-4077	234-4210	234-4079	234-4210
<b>RAM 3500 PICKUP</b>						
L6-5.9	2000		234-4077 <sup>1</sup>	234-4210 <sup>1</sup>	234-4079	234-4210
L6-5.9	1999		234-4077 <sup>4</sup>	234-4210 <sup>4</sup>	234-4079	234-4210
L6-5.9	1999		234-4076 <sup>5</sup>	234-4210 <sup>5</sup>	-	-
L6-5.9	1998-1997	w/ 12" Upstream Sensor	234-4077 <sup>1</sup>	234-4210 <sup>1</sup>	234-4079	234-4210
L6-5.9	1998-1997	w/ 18" Upstream Sensor	234-4076 <sup>1</sup>	234-4210 <sup>1</sup>	234-4079	234-4210
L6-5.9	1996		234-4077 <sup>4</sup>	234-4210 <sup>4</sup>	234-4079	234-4210
L6-5.9	1996		234-4079 <sup>5</sup>	234-4210 <sup>5</sup>	-	-
L6-5.9	1995	Round Connector	234-4076	234-4210	-	-
L6-5.9	1995	Square Connector	234-4004	234-4210	-	-
L6-5.9	1994		234-4003	234-4210	-	-
L6-6.7	2009-2007		234-5090	-	234-5090	-
V8-5.7	2009-2007		234-4587 <sup>1</sup>	-	234-4588 <sup>1</sup>	-
V8-5.7	2006-2005		234-4593 <sup>1</sup>	-	234-4588 <sup>1</sup>	-
V8-5.7	2004		234-4587 <sup>1</sup>	-	234-4767 <sup>1</sup>	234-4210 <sup>1</sup>
V8-5.7	2003		234-4770 <sup>1</sup>	-	234-4771 <sup>1</sup>	234-4210 <sup>1</sup>
V8-5.9	2002-2001	VIN Z; Manual Trans; Exc. Calif.	234-4030 <sup>1</sup>	234-4210 <sup>1</sup>	234-4029	234-4210

<sup>1</sup> 2 Required / Requis 2 / Requeridos 2 <sup>4</sup> Left Side / Côté gauche / Lado izquierdo <sup>5</sup> Right Side / Côté droit / Lado derecho



ENGINE MOTEUR MOTOR	YEAR ANNEE AÑO	APPLICATION INFORMATION INFORMATION D'APPLICATION INFORMACION DE APLICACION	UPSTREAM / AVANT - C.C. / ANTES DEL C.C.		DOWNSTREAM / APRS - C.C. / DESPUES DEL C.C.	
			TYPE / TIPO O.E.	UNIVERS.	TYPE / TIPO O.E.	UNIVERS.
<b>DODGE [cont]</b>						
<b>RAM 3500 PICKUP [cont]</b>						
V8-5.9	2002	VIN 5; Calif.	234-4769 <sup>1</sup>	234-4210 <sup>1</sup>	234-4767 <sup>1</sup>	234-4210 <sup>1</sup>
V8-5.9	2002	VIN 5; Exc. Calif.	234-4769 <sup>1</sup>	234-4210 <sup>1</sup>	234-4029	234-4210
V8-5.9	2002	VIN Z; Auto Trans; Calif.	234-4770 <sup>1</sup>	-	234-4767 <sup>1</sup>	234-4210 <sup>1</sup>
V8-5.9	2002	VIN Z; Auto Trans; Exc. Calif.	234-4769 <sup>1</sup>	234-4210 <sup>1</sup>	234-4029	234-4210
V8-5.9	2002	VIN Z; Manual Trans; Calif.	234-4030 <sup>1</sup>	234-4210 <sup>1</sup>	234-4767 <sup>1</sup>	234-4210 <sup>1</sup>
V8-5.9	2001	VIN 5	234-4079 <sup>1</sup>	234-4210 <sup>1</sup>	234-4079	234-4210
V8-5.9	2001	VIN Z; Auto Trans; Calif.	234-4770 <sup>1</sup>	-	234-4767	234-4210
V8-5.9	2001	VIN Z; Auto Trans; Exc. Calif.	234-4769 <sup>1</sup>	234-4210 <sup>1</sup>	234-4767	234-4210
V8-5.9	2001	VIN Z; Manual Trans; Calif.	234-4077 <sup>1</sup>	234-4210 <sup>1</sup>	234-4029	234-4210
V8-5.9	2000		234-4077 <sup>1</sup>	234-4210 <sup>1</sup>	234-4079	234-4210
V8-5.9	1999		234-4077 <sup>4</sup>	234-4210 <sup>4</sup>	234-4079	234-4210
V8-5.9	1999		234-4076 <sup>5</sup>	234-4210 <sup>5</sup>	-	-
V8-5.9	1998-1997	w/ 12" Upstream Sensor	234-4077 <sup>1</sup>	234-4210 <sup>1</sup>	234-4079	234-4210
V8-5.9	1998-1997	w/ 18" Upstream Sensor	234-4076 <sup>1</sup>	234-4210 <sup>1</sup>	234-4079	234-4210
V8-5.9	1996		234-4077 <sup>4</sup>	234-4210 <sup>4</sup>	234-4079	234-4210
V8-5.9	1996		234-4079 <sup>5</sup>	234-4210 <sup>5</sup>	-	-
V8-5.9	1995	Round Connector	234-4076	234-4210	-	-
V8-5.9	1995	Square Connector	234-4004	234-4210	-	-
V8-5.9	1994		234-4003	234-4210	-	-
V10-8.0	2003		234-4766 <sup>4</sup>	-	234-4771 <sup>4</sup>	234-4210 <sup>4</sup>
V10-8.0	2003		234-4587 <sup>5</sup>	-	234-4771 <sup>5</sup>	234-4210 <sup>5</sup>
V10-8.0	2002		234-4769 <sup>1</sup>	234-4210 <sup>1</sup>	234-4029 <sup>1</sup>	234-4210 <sup>1</sup>
V10-8.0	2001-1999		234-4077 <sup>4</sup>	234-4210 <sup>4</sup>	234-4079	234-4210
V10-8.0	2001		234-4769 <sup>5</sup>	234-4210 <sup>5</sup>	-	-
V10-8.0	2000-1999		234-4076 <sup>5</sup>	234-4210 <sup>5</sup>	-	-
V10-8.0	1998-1997	w/ 12" Upstream Sensor	234-4077 <sup>1</sup>	234-4210 <sup>1</sup>	234-4079	234-4210
V10-8.0	1998-1997	w/ 18" Upstream Sensor	234-4076 <sup>1</sup>	234-4210 <sup>1</sup>	234-4079	234-4210
V10-8.0	1996		234-4077 <sup>4</sup>	234-4210 <sup>4</sup>	234-4079	234-4210
V10-8.0	1996		234-4079 <sup>5</sup>	234-4210 <sup>5</sup>	-	-
V10-8.0	1995-1994		234-4004	234-4210	-	-
<b>RAM 3500 VAN</b>						
L6-6.7	2010		234-5090	-	234-5090	-
V8-5.2	2003-2001		234-4030	234-4210	234-4029	234-4210
V8-5.2	2000-1999		234-4077	234-4210	234-4079	234-4210
V8-5.9	2003		234-4030	234-4210	234-4029	234-4210
V8-5.9	2002-2001	Calif.	234-4770 <sup>1</sup>	-	234-4771	234-4210
V8-5.9	2002-2001	Exc. Calif.	234-4030	234-4210	234-4029	234-4210
V8-5.9	2000-1999		234-4077	234-4210	234-4079	234-4210

<sup>1</sup> 2 Required / Requis 2 / Requeridos 2 <sup>4</sup> Left Side / Côté gauche / Lado izquierdo <sup>5</sup> Right Side / Côté droit / Lado derecho



ENGINE MOTEUR MOTOR	YEAR ANNEE AÑO	APPLICATION INFORMATION INFORMATION D'APPLICATION INFORMACION DE APLICACION	UPSTREAM / AVANT - C.C. / ANTES DEL C.C.		DOWNSTREAM / APRS - C.C. / DESPUES DEL C.C.	
			TYPE / TIPO O.E.	UNIVERS.	TYPE / TIPO O.E.	UNIVERS.
<b>DODGE [cont]</b>						
<b>RAMCHARGER</b>						
L6-3.7	1980-1979		234-1002	234-1000	-	-
V8-5.2	1993-1990		234-4003	234-4210	-	-
V8-5.2	1989		234-4004	234-4210	-	-
V8-5.2	1988		234-3003	234-3000	-	-
V8-5.2	1987-1980		234-1002	234-1000	-	-
V8-5.9	1993-1988		234-4004	234-4210	-	-
V8-5.9	1987-1984		234-1002	234-1000	-	-
V8-5.9	1981-1980		234-1002	234-1000	-	-
<b>RAMPAGE</b>						
L4-2.2	1984-1982		234-1002	234-1000	-	-
<b>RD200</b>						
V8-5.2	1980		234-1002	234-1000	-	-
V8-5.9	1980		234-1002	234-1000	-	-
<b>ROYAL MINI RAM</b>						
L4-2.2	1987-1984		234-1002	234-1000	-	-
L4-2.6	1987-1984		234-1005	234-1000	-	-
V6-3.0	1987		234-3003	234-3000	-	-
<b>SHADOW</b>						
L4-2.2	1994-1989		234-4004	234-4210	-	-
L4-2.2	1988-1987		234-3003	234-3000	-	-
L4-2.5	1994-1989		234-4004	234-4210	-	-
L4-2.5	1988		234-3003	234-3000	-	-
V6-3.0	1994-1992		234-4004	234-4210	-	-
<b>SPIRIT</b>						
L4-2.2	1992-1991		234-4004	234-4210	-	-
L4-2.5	1995-1989		234-4004	234-4210	-	-
V6-3.0	1995-1989		234-4004	234-4210	-	-
<b>SPRINTER 2500</b>						
L5-2.7	2006-2003		234-5091	-	-	-
V6-3.0	2009-2007		234-5091	-	-	-
V6-3.5	2008-2007		234-5091 <sup>4</sup>	-	234-4073 <sup>4</sup>	-
V6-3.5	2008-2007		234-5096 <sup>5</sup>	-	234-4073 <sup>5</sup>	-
<b>SPRINTER 3500</b>						
L5-2.7	2006-2003		234-5091	-	-	-
V6-3.0	2009-2007		234-5091	-	-	-
V6-3.5	2008-2007		234-5091 <sup>4</sup>	-	234-4073 <sup>4</sup>	-
V6-3.5	2008-2007		234-5096 <sup>5</sup>	-	234-4073 <sup>5</sup>	-
<b>ST. REGIS</b>						
L6-3.7	1981-1979		234-1002	234-1000	-	-
V8-5.2	1981-1980		234-1002	234-1000	-	-

<sup>4</sup> Left Side / Côté gauche / Lado izquierdo <sup>5</sup> Right Side / Côté droit / Lado derecho



ENGINE MOTEUR MOTOR	YEAR ANNEE AÑO	APPLICATION INFORMATION INFORMATION D'APPLICATION INFORMACION DE APLICACION	UPSTREAM / AVANT - C.C. / ANTES DEL C.C.		DOWNSTREAM / APRS - C.C. / DESPUES DEL C.C.	
			TYPE / TIPO O.E.	UNIVERS.	TYPE / TIPO O.E.	UNIVERS.
<b>DODGE [cont]</b>						
<b>ST. REGIS [cont]</b>						
V8-5.9	1980		234-1002	234-1000	-	-
<b>STEALTH</b>						
V6-3.0	1996		234-4633 <sup>4</sup>	234-4209 <sup>4</sup>	234-4633 <sup>4</sup>	234-4209 <sup>4</sup>
V6-3.0	1996		234-4631 <sup>5</sup>	234-4209 <sup>5</sup>	234-4655 <sup>5</sup>	234-4209 <sup>5</sup>
V6-3.0	1995-1994	Non-Turbo; Calif.	234-4633 <sup>4</sup>	234-4209 <sup>4</sup>	234-4633 <sup>4</sup>	234-4209 <sup>4</sup>
V6-3.0	1995-1994	Non-Turbo; Calif.	234-4631 <sup>5</sup>	234-4209 <sup>5</sup>	234-4655 <sup>5</sup>	234-4209 <sup>5</sup>
V6-3.0	1995-1994	Non-Turbo; Exc. Calif.	234-4640	234-4209	-	-
V6-3.0	1995-1994	Turbo	234-4633 <sup>4</sup>	234-4209 <sup>4</sup>	234-4633 <sup>4</sup>	234-4209 <sup>4</sup>
V6-3.0	1995-1994	Turbo	234-4631 <sup>5</sup>	234-4209 <sup>5</sup>	234-4655 <sup>5</sup>	234-4209 <sup>5</sup>
V6-3.0	1993	Non-Turbo	234-4640	234-4209	-	-
V6-3.0	1993	Turbo	234-4633 <sup>4</sup>	234-4209 <sup>4</sup>	-	-
V6-3.0	1993	Turbo	234-4631 <sup>5</sup>	234-4209 <sup>5</sup>	-	-
V6-3.0	1992-1991	Non-Turbo	234-4889	-	-	-
V6-3.0	1992-1991	Turbo	234-4886 <sup>4</sup>	-	-	-
V6-3.0	1992-1991	Turbo	234-4887 <sup>5</sup>	-	-	-
<b>STRATUS</b>						
L4-2.0	2000-1998		234-4078	234-4210	234-4079	234-4210
L4-2.0	1997		234-4077	234-4210	234-4002	234-4210
L4-2.0	1996-1995		234-4004	234-4210	234-4002	234-4210
L4-2.4	2006		234-4588	-	234-4587	-
L4-2.4	2005-2004	SOHC	234-4738	-	234-4652	234-4209
L4-2.4	2005	DOHC	234-4588	-	234-4587	-
L4-2.4	2004	DOHC; Current Generation Engine Controllers; Round Downstream Connector	234-4596	-	234-4079	234-4210
L4-2.4	2004	DOHC; Next Generation Engine Controllers; Square Downstream Connector	234-4588	-	234-4587	-
L4-2.4	2003-2001	DOHC; VIN X	234-4596	-	234-4079	234-4210
L4-2.4	2003-2001	SOHC; VIN G	234-4738	-	234-4652	234-4209
L4-2.4	2000-1998		234-4078	234-4210	234-4079	234-4210
L4-2.4	1997		234-4077	234-4210	234-4002	234-4210
L4-2.4	1996-1995		234-4004	234-4210	234-4002	234-4210
V6-2.5	2000-1998		234-4079	234-4210	234-4079	234-4210
V6-2.5	1997		234-4005	234-4210	234-4002	234-4210
V6-2.5	1996-1995		234-4002	234-4210	234-4002	234-4210
V6-2.7	2006-2005		234-4587 <sup>1</sup>	-	234-4587 <sup>1</sup>	-
V6-2.7	2004	Current Generation Engine Controller; Round Connector	234-4078 <sup>1</sup>	234-4210 <sup>1</sup>	234-4078 <sup>1</sup>	234-4210 <sup>1</sup>
V6-2.7	2004	Next Generation Engine Controller; Square Connector	234-4587 <sup>1</sup>	-	234-4587 <sup>1</sup>	-
V6-2.7	2003-2001		234-4078 <sup>1</sup>	234-4210 <sup>1</sup>	234-4078 <sup>1</sup>	234-4210 <sup>1</sup>
V6-3.0	2005-2004		234-4739 <sup>4</sup>	-	234-4656 <sup>4</sup>	234-4209 <sup>4</sup>
V6-3.0	2005-2004		234-4738 <sup>5</sup>	-	234-4656 <sup>5</sup>	234-4209 <sup>5</sup>
V6-3.0	2003-2001		234-4738 <sup>4</sup>	-	234-4656 <sup>4</sup>	234-4209 <sup>4</sup>
V6-3.0	2003-2001		234-4739 <sup>5</sup>	-	234-4656 <sup>5</sup>	234-4209 <sup>5</sup>

<sup>1</sup> 2 Required / Requis 2 / Requeridos 2 <sup>4</sup> Left Side / Côté gauche / Lado izquierdo <sup>5</sup> Right Side / Côté droit / Lado derecho



ENGINE MOTEUR MOTOR	YEAR ANNEE AÑO	APPLICATION INFORMATION INFORMATION D'APPLICATION INFORMACION DE APLICACION	UPSTREAM / AVANT - C.C. / ANTES DEL C.C.		DOWNSTREAM / APRS - C.C. / DESPUES DEL C.C.	
			TYPE / TIPO O.E.	UNIVERS.	TYPE / TIPO O.E.	UNIVERS.
<b>DODGE [cont]</b>						
<b>SX 2.0</b>						
L4-2.0	2005	w/ 11" Downstream Sensor	234-4588	-	234-4232	234-4212
L4-2.0	2005	w/ 24" Downstream Sensor	234-4588	-	234-4230	234-4210
L4-2.0	2004-2003	w/ 15" Upstream Sensor	234-4587	-	234-4232	234-4212
L4-2.0	2004	w/ 18" Upstream Sensor	234-4588	-	234-4232	234-4212
<b>VIPER</b>						
V10-8.0	2002-1997		234-4076 <sup>1</sup>	234-4210 <sup>1</sup>	234-4079 <sup>1</sup>	234-4210 <sup>1</sup>
V10-8.0	1996		234-4076	234-4210	234-4079	234-4210
V10-8.0	1995		234-4003	234-4210	234-4079	234-4210
V10-8.0	1994-1992		234-4003	234-4210	-	-
V10-8.3	2006-2003		234-4766 <sup>1</sup>	-	234-4767 <sup>1</sup>	234-4210 <sup>1</sup>
V10-8.4	2015		234-4545 <sup>1</sup>	-	234-4579 <sup>1</sup>	-
V10-8.4	2010-2008		234-4598 <sup>1</sup>	-	234-4588 <sup>1</sup>	-
<b>W100 PICKUP</b>						
L6-3.7	1987-1986		234-1002	234-1000	-	-
V6-3.9	1989		234-4013	234-4210	-	-
V8-5.2	1989		234-4004	234-4210	-	-
V8-5.2	1988		234-3003	234-3000	-	-
V8-5.2	1987-1986		234-1002	234-1000	-	-
V8-5.9	1988		234-4004	234-4210	-	-
V8-5.9	1987-1986		234-1002	234-1000	-	-
<b>W150 PICKUP</b>						
L6-3.7	1987-1979		234-1002	234-1000	-	-
V6-3.9	1993-1990		234-4003	234-4210	-	-
V6-3.9	1989		234-4013	234-4210	-	-
V8-5.2	1993-1990		234-4003	234-4210	-	-
V8-5.2	1989		234-4004	234-4210	-	-
V8-5.2	1988		234-3003	234-3000	-	-
V8-5.2	1987-1980		234-1002	234-1000	-	-
V8-5.9	1993		234-4004	234-4210	-	-
V8-5.9	1991-1988		234-4004	234-4210	-	-
V8-5.9	1987-1984		234-1002	234-1000	-	-
V8-5.9	1981-1980		234-1002	234-1000	-	-
<b>W200 PICKUP</b>						
L6-3.7	1980-1979		234-1002	234-1000	-	-
V8-5.2	1980		234-1002	234-1000	-	-
V8-5.9	1980		234-1002	234-1000	-	-
<b>W250 PICKUP</b>						
L6-5.9	1993-1989		234-4004	234-4210	-	-
V8-5.2	1993-1990		234-4003	234-4210	-	-
V8-5.2	1989		234-4004	234-4210	-	-

<sup>1</sup> 2 Required / Requis 2 / Requeridos 2





ENGINE MOTEUR MOTOR	YEAR ANNEE AÑO	APPLICATION INFORMATION INFORMATION D'APPLICATION INFORMACION DE APLICACION	UPSTREAM / AVANT - C.C. / ANTES DEL C.C.		DOWNSTREAM / APRS - C.C. / DESPUES DEL C.C.	
			TYPE / TIPO O.E.	UNIVERS.	TYPE / TIPO O.E.	UNIVERS.
<b>DODGE [cont]</b>						
<b>W250 PICKUP [cont]</b>						
V8-5.2	1988		234-3003	234-3000	-	-
V8-5.2	1987-1981		234-1002	234-1000	-	-
V8-5.9	1993-1988		234-4004	234-4210	-	-
V8-5.9	1987-1984		234-1002	234-1000	-	-
V8-5.9	1982-1981		234-1002	234-1000	-	-
<b>W300 PICKUP</b>						
V8-5.2	1980		234-1002	234-1000	-	-
V8-5.9	1980		234-1002	234-1000	-	-
<b>W350 PICKUP</b>						
L6-5.9	1993-1989		234-4004	234-4210	-	-
V8-5.2	1983-1982		234-1002	234-1000	-	-
V8-5.9	1993-1988		234-4004	234-4210	-	-
V8-5.9	1987-1981		234-1002	234-1000	-	-
<b>EAGLE</b>						
<b>2000 GTX</b>						
L4-2.0	1993		234-2014	234-2000	-	-
L4-2.0	1992-1991	VIN R	234-4644	234-4209	-	-
L4-2.0	1992-1991	VIN V	234-1005	234-1000	-	-
<b>MEDALLION</b>						
L4-2.2	1989-1988		234-1011	234-1000	-	-
<b>PREMIER</b>						
V6-3.0	1992-1991		234-4013	234-4210	-	-
<b>SUMMIT</b>						
L4-1.5	1996-1995		234-4020 <sup>15</sup>	234-4210 <sup>15</sup>	234-4081	234-4210
L4-1.5	1996-1995		234-4032 <sup>16</sup>	234-4210 <sup>16</sup>	-	-
L4-1.5	1994-1993	Calif.	234-4020	234-4210	234-4081	234-4210
L4-1.5	1994-1993	Exc. Calif.	234-2066	234-2000	-	-
L4-1.5	1992		234-2066	234-2000	-	-
L4-1.5	1991	Auto Trans	234-2066	234-2000	-	-
L4-1.5	1991	Manual Trans	234-2002	234-2000	-	-
L4-1.5	1990	1 Lead Sensor	234-1007	234-1000	-	-
L4-1.5	1990	2 Lead Sensor	234-2002	234-2000	-	-
L4-1.5	1989	Calif.	234-2002	234-2000	-	-
L4-1.5	1989	Exc. Calif.	234-1007	234-1000	-	-
L4-1.6	1990	Calif.	234-2002	234-2000	-	-
L4-1.6	1990	Exc. Calif.	234-1007	234-1000	-	-
L4-1.6	1989		234-1007	234-1000	-	-
L4-1.8	1996-1995	Exc. Wagon	234-4633	234-4209	234-4641	234-4209
L4-1.8	1996-1995	Exc. Wagon; Loc. Center	-	-	234-4638 <sup>12</sup>	234-4209 <sup>12</sup>
L4-1.8	1996-1995	Wagon; Calif.	234-4633	234-4209	234-4017	234-4209

<sup>12</sup> Loc. Center / Empl. central / Ubicación central <sup>15</sup> Front / Avant / Parte delantera <sup>16</sup> Rear / Arrière / Parte trasera



ENGINE MOTEUR MOTOR	YEAR ANNEE AÑO	APPLICATION INFORMATION INFORMATION D'APPLICATION INFORMACION DE APLICACION	UPSTREAM / AVANT - C.C. / ANTES DEL C.C.		DOWNSTREAM / APRES - C.C. / DESPUES DEL C.C.	
			TYPE / TIPO O.E.	UNIVERS.	TYPE / TIPO O.E.	UNIVERS.
<b>EAGLE [cont]</b>						
<b>SUMMIT [cont]</b>						
L4-1.8	1996-1995	Wagon; Calif.; Loc. Center	-	-	234-4637 <sup>12</sup>	234-4209 <sup>12</sup>
L4-1.8	1996-1995	Wagon; Exc. Calif.	234-4633	234-4209	234-4017	234-4209
L4-1.8	1996-1995	Wagon; Exc. Calif.; Loc. Center	-	-	234-4638 <sup>12</sup>	234-4209 <sup>12</sup>
L4-1.8	1994-1993	Exc. Calif.	234-2014	234-2000	-	-
L4-1.8	1994	Calif.	234-4641	234-4209	234-4638	234-4209
L4-1.8	1993	Calif.; 4WD	234-4638	234-4209	234-4017	234-4209
L4-1.8	1993	Calif.; FWD	234-4641	234-4209	234-4638	234-4209
L4-1.8	1992		234-2066	234-2000	-	-
L4-2.4	1996-1995	Calif.; 4WD	234-4633	234-4209	234-4017	234-4209
L4-2.4	1996-1995	Calif.; 4WD; Loc. Center	-	-	234-4638 <sup>12</sup>	234-4209 <sup>12</sup>
L4-2.4	1996-1995	Calif.; FWD	234-4633	234-4209	234-4017	234-4209
L4-2.4	1996-1995	Calif.; FWD; Loc. Center	-	-	234-4637 <sup>12</sup>	234-4209 <sup>12</sup>
L4-2.4	1996-1995	Exc. Calif.	234-4633	234-4209	234-4017	234-4209
L4-2.4	1996-1995	Exc. Calif.; Loc. Center	-	-	234-4638 <sup>12</sup>	234-4209 <sup>12</sup>
L4-2.4	1994		234-4638	234-4209	234-4017	234-4209
L4-2.4	1993	Calif.; 4WD	234-4638	234-4209	234-4017	234-4209
L4-2.4	1993	Calif.; FWD	234-4638	234-4209	234-4027	234-4210
L4-2.4	1993	Exc. Calif.	234-2014	234-2000	-	-
L4-2.4	1992		234-2014	234-2000	-	-
<b>TALON</b>						
L4-1.8	1994-1993		234-2002	234-2000	-	-
L4-2.0	1998-1997	Non-Turbo	234-4076	234-4210	234-4083	234-4210
L4-2.0	1998-1995	Turbo; AWD	234-4026	234-4209	234-4027	234-4210
L4-2.0	1998-1995	Turbo; FWD	234-4026	234-4209	234-4641	234-4209
L4-2.0	1996-1995	Non-Turbo	234-4003	234-4210	234-4083	234-4210
L4-2.0	1994-1991	Turbo	234-4007	234-4210	-	-
L4-2.0	1994-1990	Non-Turbo	234-4644	234-4209	-	-
L4-2.0	1990	Turbo	234-4643	234-4209	-	-
<b>VISION</b>						
V6-3.3	1997-1996	w/ 17" Downstream Sensor	234-4077	234-4210	234-4002	234-4210
V6-3.3	1997-1996	w/ 22" Downstream Sensor	234-4077	234-4210	234-4003	234-4210
V6-3.3	1995-1993		234-4004	234-4210	-	-
V6-3.5	1997-1996	w/ 17" Downstream Sensor	234-4077 <sup>1</sup>	234-4210 <sup>1</sup>	234-4002 <sup>1</sup>	234-4210 <sup>1</sup>
V6-3.5	1997-1996	w/ 22" Downstream Sensor	234-4077 <sup>1</sup>	234-4210 <sup>1</sup>	234-4003 <sup>1</sup>	234-4210 <sup>1</sup>
V6-3.5	1995-1994	Square Connector	234-4004	234-4210	-	-
V6-3.5	1995-1993	Round Connector	234-4077	234-4210	-	-
<b>VISTA</b>						
L4-1.5	1992		234-2066	234-2000	-	-
L4-1.5	1991	Auto Trans	234-2066	234-2000	-	-
L4-1.5	1991	Manual Trans	234-2002	234-2000	-	-
L4-1.5	1990-1989	2 Lead Sensor	234-2002	234-2000	-	-

<sup>1</sup> 2 Required / Requis 2 / Requeridos 2 <sup>12</sup> Loc. Center / Empl. central / Ubicación central



ENGINE MOTEUR MOTOR	YEAR ANNEE AÑO	APPLICATION INFORMATION INFORMATION D'APPLICATION INFORMACION DE APLICACION	UPSTREAM / AVANT - C.C. / ANTES DEL C.C.		DOWNSTREAM / APRS - C.C. / DESPUES DEL C.C.	
			TYPE / TIPO O.E.	UNIVERS.	TYPE / TIPO O.E.	UNIVERS.
<b>EAGLE [cont]</b>						
<b>VISTA [cont]</b>						
L4-1.5	1990-1988	1 Lead Sensor	234-1007	234-1000	-	-
L4-2.0	1991-1989	Calif.	234-2002	234-2000	-	-
L4-2.0	1991-1989	Exc. Calif.	234-1021	234-1000	-	-
<b>FIAT</b>						
<b>500</b>						
L4-1.4	2014-2012		234-5075	-	234-4483	-
<b>500L</b>						
L4-1.4	2015-2014		234-5171	-	234-4748	-
<b>FORD</b>						
<b>AEROSTAR</b>						
L4-2.3	1987		234-3002	234-3000	-	-
L4-2.3	1986		234-3001	234-3000	-	-
V6-2.8	1986		234-1003	234-1000	-	-
V6-3.0	1997-1996		234-4127 <sup>1</sup>	234-4212 <sup>1</sup>	234-4070	234-4212
V6-3.0	1995-1992		234-4071	234-4212	-	-
V6-3.0	1991-1986		234-3002	234-3000	-	-
V6-4.0	1997-1996		234-4127 <sup>1</sup>	234-4212 <sup>1</sup>	234-4070	234-4212
V6-4.0	1995-1992	OE #F4UZ-9F472-C	234-4070	234-4212	-	-
V6-4.0	1995	OE #F09Z-9F472-C	234-4611	234-4210	-	-
V6-4.0	1993	OE #F09Z-9F472-C	234-4611	234-4210	-	-
V6-4.0	1991-1990	OE #F09Z-9F472-C & F0TZ-9F472-C	234-4611	234-4210	-	-
V6-4.0	1991-1990	OE #FOUZ-9F472-C & F4UZ-9F472-C	234-4070	234-4212	-	-
<b>ASPIRE</b>						
L4-1.3	1997-1996		234-1020	234-1000	234-4037	234-4210
L4-1.3	1995-1994		234-1020	234-1000	-	-
<b>BRONCO</b>						
L6-4.9	1992-1990	w/ 10" Sensor	234-4070	234-4212	-	-
L6-4.9	1990	w/ 15" Sensor	234-4611	234-4210	-	-
L6-4.9	1989-1987	w/ 16" Sensor	234-3007	234-3000	-	-
L6-4.9	1988-1987	w/ 8" Sensor	234-3002	234-3000	-	-
L6-4.9	1986-1984	w/ 17" Sensor	234-1004	234-1000	-	-
L6-4.9	1985-1982	w/ 7" Sensor	234-1003	234-1000	-	-
V8-5.0	1996		234-4071	234-4212	234-4070	234-4212
V8-5.0	1995-1991		234-4071	234-4212	-	-
V8-5.0	1990-1987	3 Lead Sensor; w/ 16" Pigtail	234-3007	234-3000	-	-
V8-5.0	1990	3 Lead Sensor; w/ 8" Pigtail	234-3002	234-3000	-	-
V8-5.0	1990	4 Lead Sensor	234-4609	234-4210	-	-
V8-5.0	1986-1985	w/ 17" Sensor	234-1004	234-1000	-	-
V8-5.0	1985	w/ 7" Sensor	234-1003	234-1000	-	-

<sup>1</sup> 2 Required / Requis 2 / Requeridos 2



ENGINE MOTEUR MOTOR	YEAR ANNEE AÑO	APPLICATION INFORMATION INFORMATION D'APPLICATION INFORMACION DE APLICACION	UPSTREAM / AVANT - C.C. / ANTES DEL C.C.		DOWNSTREAM / APRS - C.C. / DESPUES DEL C.C.	
			TYPE / TIPO O.E.	UNIVERS.	TYPE / TIPO O.E.	UNIVERS.
<b>FORD [cont]</b>						
<b>BRONCO [cont]</b>						
V8-5.0	1984-1980		234-1003	234-1000	-	-
V8-5.8	1996		234-4071 <sup>1</sup>	234-4212 <sup>1</sup>	234-4070	234-4212
V8-5.8	1995	Calif.	234-4001	234-4212	-	-
V8-5.8	1995	Exc. Calif.	234-4071	234-4212	-	-
V8-5.8	1994-1991	w/ 11" Sensor	234-4071	234-4212	-	-
V8-5.8	1992-1991	w/ 18" Sensor	234-4609	234-4210	-	-
V8-5.8	1990		234-4609 <sup>1</sup>	234-4210 <sup>1</sup>	-	-
V8-5.8	1989-1988		234-3007	234-3000	-	-
V8-5.8	1987-1985	w/ 17" Sensor	234-1004	234-1000	-	-
V8-5.8	1987-1980	w/ 7" Sensor	234-1003	234-1000	-	-
<b>BRONCO II</b>						
V6-2.8	1985-1984		234-1003	234-1000	-	-
V6-2.9	1990-1989	3 Lead Sensor; w/ 16" Pigtail	234-3007	234-3000	-	-
V6-2.9	1990-1987	3 Lead Sensor; w/ 8" Pigtail	234-3002	234-3000	-	-
V6-2.9	1990	4 Lead Sensor	234-4609	234-4210	-	-
V6-2.9	1986		234-3001	234-3000	-	-
<b>C-MAX</b>						
L4-2.0	2014		234-5068	-	234-4578	-
L4-2.0	2013		234-5113	-	234-4578	-
<b>CONTOUR</b>						
L4-2.0	2000		234-4045	-	234-4609	234-4210
L4-2.0	1999-1996		234-4016	234-4210	234-4609	234-4210
L4-2.0	1995		234-4016	234-4210	-	-
V6-2.5	2000		234-4045 <sup>1</sup>	-	234-4610 <sup>1</sup>	234-4210 <sup>1</sup>
V6-2.5	1999	From 05/02/99; Upstream Sensor w/ Round Connector	234-4045 <sup>1</sup>	-	234-4610 <sup>1</sup>	234-4210 <sup>1</sup>
V6-2.5	1999	From 05/02/99; Upstream Sensor w/ Square Connector	234-4607 <sup>1</sup>	234-4210 <sup>1</sup>	234-4610 <sup>1</sup>	234-4210 <sup>1</sup>
V6-2.5	1999	To 05/02/99; Upstream Sensor w/ Round Connector	234-4045 <sup>1</sup>	-	234-4609 <sup>1</sup>	234-4210 <sup>1</sup>
V6-2.5	1999	To 05/02/99; Upstream Sensor w/ Square Connector	234-4607 <sup>1</sup>	234-4210 <sup>1</sup>	234-4609 <sup>1</sup>	234-4210 <sup>1</sup>
V6-2.5	1998-1996		234-4607 <sup>1</sup>	234-4210 <sup>1</sup>	234-4609 <sup>1</sup>	234-4210 <sup>1</sup>
V6-2.5	1995		234-4607 <sup>1</sup>	234-4210 <sup>1</sup>	-	-
<b>COUNTRY SQUIRE</b>						
V8-5.0	1991-1987		234-3002 <sup>1</sup>	234-3000 <sup>1</sup>	-	-
<b>COURIER</b>						
L4-2.3	1982-1979		234-1003	234-1000	-	-
<b>CROWN VICTORIA</b>						
V8-4.6	2011-2007		234-4373 <sup>1</sup>	-	234-4609 <sup>1</sup>	234-4210 <sup>1</sup>
V8-4.6	2006	From 12/05/05	234-4373 <sup>1</sup>	-	234-4609 <sup>1</sup>	234-4210 <sup>1</sup>
V8-4.6	2006	To 12/05/05	234-4045 <sup>1</sup>	-	234-4609 <sup>1</sup>	234-4210 <sup>1</sup>
V8-4.6	2005-2000		234-4045 <sup>1</sup>	-	234-4609 <sup>1</sup>	234-4210 <sup>1</sup>
V8-4.6	1999	CNG Engine	234-4046 <sup>1</sup>	-	234-4609 <sup>1</sup>	234-4210 <sup>1</sup>

<sup>1</sup> 2 Required / Requis 2 / Requeridos 2



ENGINE MOTEUR MOTOR	YEAR ANNEE AÑO	APPLICATION INFORMATION INFORMATION D'APPLICATION INFORMACION DE APLICACION	UPSTREAM / AVANT - C.C. / ANTES DEL C.C.		DOWNSTREAM / APRS - C.C. / DESPUES DEL C.C.	
			TYPE / TIPO O.E.	UNIVERS.	TYPE / TIPO O.E.	UNIVERS.
<b>FORD [cont]</b>						
<b>CROWN VICTORIA [cont]</b>						
V8-4.6	1999	Gas Engine	234-4045 <sup>1</sup>	-	234-4609 <sup>1</sup>	234-4210 <sup>1</sup>
V8-4.6	1998		234-4046 <sup>1</sup>	-	234-4609 <sup>1</sup>	234-4210 <sup>1</sup>
V8-4.6	1997-1996		234-4609	234-4210	234-4609	234-4210
V8-4.6	1995-1994	w/ 18" Sensor	234-4609 <sup>1</sup>	234-4210 <sup>1</sup>	-	-
V8-4.6	1994-1993	w/ 13" Sensor	234-4610 <sup>1</sup>	234-4210 <sup>1</sup>	-	-
V8-4.6	1992		234-4610 <sup>1</sup>	234-4210 <sup>1</sup>	-	-
<b>E-100 VAN</b>						
L6-4.9	1983-1981		234-1003	234-1000	-	-
V8-5.0	1983-1980		234-1003	234-1000	-	-
V8-5.8	1983-1981		234-1003	234-1000	-	-
<b>E-150 VAN</b>						
L6-4.9	1996		234-4071 <sup>1</sup>	234-4212 <sup>1</sup>	234-4127 <sup>1</sup>	234-4212 <sup>1</sup>
L6-4.9	1995-1991		234-4071	234-4212	-	-
L6-4.9	1990	w/ 11" Sensor	234-4070	234-4212	-	-
L6-4.9	1990	w/ 16" Sensor	234-4609	234-4210	-	-
L6-4.9	1990	w/ 19" Sensor	234-4611	234-4210	-	-
L6-4.9	1989-1987		234-3002	234-3000	-	-
L6-4.9	1986-1984		234-1004	234-1000	-	-
L6-4.9	1983-1981		234-1003	234-1000	-	-
V6-4.2	2003-2002		234-4401 <sup>1</sup>	-	234-4127 <sup>1</sup>	234-4212 <sup>1</sup>
V6-4.2	2001-2000	Calif.	234-4046 <sup>1</sup>	-	234-4127 <sup>1</sup>	234-4212 <sup>1</sup>
V6-4.2	2001-1999	Exc. Calif.	234-4071 <sup>1</sup>	234-4212 <sup>1</sup>	234-4127 <sup>1</sup>	234-4212 <sup>1</sup>
V6-4.2	1999	Calif.; Bosch OE Sensor	234-4071 <sup>1</sup>	234-4212 <sup>1</sup>	234-4127 <sup>1</sup>	234-4212 <sup>1</sup>
V6-4.2	1999	Calif.; NTK OE Sensor; Upstream OE #5C5Z9F472AA	234-4046 <sup>1</sup>	-	234-4127 <sup>1</sup>	234-4212 <sup>1</sup>
V6-4.2	1999	Calif.; NTK OE Sensor; Upstream OE #F88Z9F472AB	234-4071 <sup>1</sup>	234-4212 <sup>1</sup>	234-4127 <sup>1</sup>	234-4212 <sup>1</sup>
V6-4.2	1998-1997		234-4071 <sup>1</sup>	234-4212 <sup>1</sup>	234-4127 <sup>1</sup>	234-4212 <sup>1</sup>
V8-4.6	2014-2009		234-5113 <sup>1</sup>	-	234-4127 <sup>1</sup>	234-4212 <sup>1</sup>
V8-4.6	2008-2005		234-4374 <sup>1</sup>	-	234-4127 <sup>1</sup>	234-4212 <sup>1</sup>
V8-4.6	2004-2003		234-4045 <sup>1</sup>	-	234-4127 <sup>1</sup>	234-4212 <sup>1</sup>
V8-4.6	2002-2000		234-4046 <sup>1</sup>	-	234-4609 <sup>1</sup>	234-4210 <sup>1</sup>
V8-4.6	1999-1997		234-4127 <sup>1</sup>	234-4212 <sup>1</sup>	234-4127 <sup>1</sup>	234-4212 <sup>1</sup>
V8-5.0	1996		234-4071 <sup>1</sup>	234-4212 <sup>1</sup>	234-4070 <sup>1</sup>	234-4212 <sup>1</sup>
V8-5.0	1995-1991		234-4071	234-4212	-	-
V8-5.0	1990-1987	3 Lead Sensor; w/ 11" Pigtail	234-3002	234-3000	-	-
V8-5.0	1990	3 Lead Sensor; w/ 19" Pigtail	234-3007	234-3000	-	-
V8-5.0	1990	4 Lead Sensor	234-4609	234-4210	-	-
V8-5.0	1986		234-3001	234-3000	-	-
V8-5.0	1985-1980		234-1003	234-1000	-	-
V8-5.4	2014-2009		234-5113 <sup>1</sup>	-	234-4127 <sup>1</sup>	234-4212 <sup>1</sup>
V8-5.4	2008-2005		234-4374 <sup>1</sup>	-	234-4127 <sup>1</sup>	234-4212 <sup>1</sup>

<sup>1</sup> 2 Required / Requis 2 / Requeridos 2



ENGINE MOTEUR MOTOR	YEAR ANNEE AÑO	APPLICATION INFORMATION INFORMATION D'APPLICATION INFORMACION DE APLICACION	UPSTREAM / AVANT - C.C. / ANTES DEL C.C.		DOWNSTREAM / APRES - C.C. / DESPUES DEL C.C.	
			TYPE / TIPO O.E.	UNIVERS.	TYPE / TIPO O.E.	UNIVERS.
<b>FORD [cont]</b>						
<b>E-150 VAN [cont]</b>						
V8-5.4	2004-2002		234-4045 <sup>1</sup>	-	234-4127 <sup>1</sup>	234-4212 <sup>1</sup>
V8-5.4	2001-2000		234-4045 <sup>1</sup>	-	234-4609 <sup>1</sup>	234-4210 <sup>1</sup>
V8-5.4	1999-1998		234-4071 <sup>1</sup>	234-4212 <sup>1</sup>	234-4127 <sup>1</sup>	234-4212 <sup>1</sup>
V8-5.4	1997		234-4127 <sup>1</sup>	234-4212 <sup>1</sup>	234-4127 <sup>1</sup>	234-4212 <sup>1</sup>
V8-5.8	1996		234-4071 <sup>1</sup>	234-4212 <sup>1</sup>	234-4070 <sup>1</sup>	234-4212 <sup>1</sup>
V8-5.8	1995	Calif.	234-4001	234-4212	-	-
V8-5.8	1995	Exc. Calif.	234-4071	234-4212	-	-
V8-5.8	1994-1991		234-4071	234-4212	-	-
V8-5.8	1990		234-4070	234-4212	-	-
V8-5.8	1989-1988	w/ 16" Sensor	234-3007	234-3000	-	-
V8-5.8	1989-1988	w/ 8" Sensor	234-3002	234-3000	-	-
V8-5.8	1987-1986	3 Lead Sensor; w/ 16" Pigtail	234-3007	234-3000	-	-
V8-5.8	1987-1986	3 Lead Sensor; w/ 8" Pigtail	234-3002	234-3000	-	-
V8-5.8	1987-1984	1 Lead Sensor	234-1004	234-1000	-	-
V8-5.8	1983-1981		234-1003	234-1000	-	-
<b>E-250 SUPER DUTY</b>						
V8-5.4	2005		234-4374 <sup>1</sup>	-	234-4127 <sup>1</sup>	234-4212 <sup>1</sup>
V8-5.4	2004		234-4045 <sup>1</sup>	-	234-4127 <sup>1</sup>	234-4212 <sup>1</sup>
<b>E-250 VAN</b>						
L6-4.9	1996		234-4071 <sup>1</sup>	234-4212 <sup>1</sup>	234-4127 <sup>1</sup>	234-4212 <sup>1</sup>
L6-4.9	1995-1991		234-4071	234-4212	-	-
L6-4.9	1990	w/ 11" Sensor	234-4070	234-4212	-	-
L6-4.9	1990	w/ 16" Sensor	234-4609	234-4210	-	-
L6-4.9	1990	w/ 19" Sensor	234-4611	234-4210	-	-
L6-4.9	1989-1987		234-3002	234-3000	-	-
L6-4.9	1986-1984		234-1004	234-1000	-	-
L6-4.9	1983-1981		234-1003	234-1000	-	-
V6-4.2	2003-2002		234-4401 <sup>1</sup>	-	234-4127 <sup>1</sup>	234-4212 <sup>1</sup>
V6-4.2	2001-2000	Calif.	234-4046 <sup>1</sup>	-	234-4127 <sup>1</sup>	234-4212 <sup>1</sup>
V6-4.2	2001-1999	Exc. Calif.	234-4071 <sup>1</sup>	234-4212 <sup>1</sup>	234-4127 <sup>1</sup>	234-4212 <sup>1</sup>
V6-4.2	1999	Calif.; NTK OE Sensor; Upstream OE #5C5Z9F472AA	234-4046 <sup>1</sup>	-	234-4127 <sup>1</sup>	234-4212 <sup>1</sup>
V6-4.2	1999	Calif.; NTK OE Sensor; Upstream OE #F88Z9F472AB	234-4071 <sup>1</sup>	234-4212 <sup>1</sup>	234-4127 <sup>1</sup>	234-4212 <sup>1</sup>
V6-4.2	1998-1997		234-4071 <sup>1</sup>	234-4212 <sup>1</sup>	234-4127 <sup>1</sup>	234-4212 <sup>1</sup>
V8-4.6	2014-2009		234-5113 <sup>1</sup>	-	234-4127 <sup>1</sup>	234-4212 <sup>1</sup>
V8-4.6	2008-2005		234-4374 <sup>1</sup>	-	234-4127 <sup>1</sup>	234-4212 <sup>1</sup>
V8-4.6	2004-2003		234-4045 <sup>1</sup>	-	234-4127 <sup>1</sup>	234-4212 <sup>1</sup>
V8-5.0	1991		234-4071	234-4212	-	-
V8-5.0	1990-1987	3 Lead Sensor; w/ 11" Pigtail	234-3002	234-3000	-	-
V8-5.0	1990	3 Lead Sensor; w/ 19" Pigtail	234-3007	234-3000	-	-
V8-5.0	1990	4 Lead Sensor	234-4609	234-4210	-	-

<sup>1</sup> 2 Required / Requis 2 / Requeridos 2



ENGINE MOTEUR MOTOR	YEAR ANNEE AÑO	APPLICATION INFORMATION INFORMATION D'APPLICATION INFORMACION DE APLICACION	UPSTREAM / AVANT - C.C. / ANTES DEL C.C.		DOWNSTREAM / APRS - C.C. / DESPUES DEL C.C.	
			TYPE / TIPO O.E.	UNIVERS.	TYPE / TIPO O.E.	UNIVERS.
<b>FORD [cont]</b>						
<b>E-250 VAN [cont]</b>						
V8-5.0	1986		234-3001	234-3000	-	-
V8-5.0	1985-1980		234-1003	234-1000	-	-
V8-5.4	2014-2011		234-5113 <sup>1</sup>	-	234-4127 <sup>1</sup>	234-4212 <sup>1</sup>
V8-5.4	2010-2009	Cutaway / Stripped Chassis Cabs	234-5113 <sup>1</sup>	-	234-4127	234-4212
V8-5.4	2010-2009	Regular / Extended Vans	234-5113 <sup>1</sup>	-	234-4127 <sup>1</sup>	234-4212 <sup>1</sup>
V8-5.4	2008-2005		234-4374 <sup>1</sup>	-	234-4127 <sup>1</sup>	234-4212 <sup>1</sup>
V8-5.4	2004-2002		234-4045 <sup>1</sup>	-	234-4127 <sup>1</sup>	234-4212 <sup>1</sup>
V8-5.4	2001		234-4045 <sup>1</sup>	-	234-4609 <sup>1</sup>	234-4210 <sup>1</sup>
V8-5.4	2000	CNG Engine; Exc. Trans Code 4R100	234-4045 <sup>1</sup>	-	234-4609 <sup>1</sup>	234-4210 <sup>1</sup>
V8-5.4	2000	CNG Engine; Trans Code 4R100	234-4045 <sup>1</sup>	-	234-4610 <sup>1</sup>	234-4210 <sup>1</sup>
V8-5.4	2000	Gas Engine	234-4045 <sup>1</sup>	-	234-4609 <sup>1</sup>	234-4210 <sup>1</sup>
V8-5.4	1999-1998	Gas Engine	234-4071 <sup>1</sup>	234-4212 <sup>1</sup>	234-4127 <sup>1</sup>	234-4212 <sup>1</sup>
V8-5.4	1999-1997	CNG Engine	234-4609 <sup>1</sup>	234-4210 <sup>1</sup>	234-4127 <sup>1</sup>	234-4212 <sup>1</sup>
V8-5.4	1999	Bi-Fuel Engine; w/ 11" Upstream Sensors	234-4071 <sup>1</sup>	234-4212 <sup>1</sup>	234-4609 <sup>1</sup>	234-4210 <sup>1</sup>
V8-5.4	1999	Bi-Fuel Engine; w/ 19" Upstream Sensors	234-4045 <sup>1</sup>	-	234-4127 <sup>1</sup>	234-4212 <sup>1</sup>
V8-5.4	1998	Bi-Fuel Engine	234-4071 <sup>1</sup>	234-4212 <sup>1</sup>	234-4127 <sup>1</sup>	234-4212 <sup>1</sup>
V8-5.4	1997	Gas Engine	234-4127 <sup>1</sup>	234-4212 <sup>1</sup>	234-4127 <sup>1</sup>	234-4212 <sup>1</sup>
V8-5.8	1996		234-4071 <sup>1</sup>	234-4212 <sup>1</sup>	234-4070 <sup>1</sup>	234-4212 <sup>1</sup>
V8-5.8	1995	Calif.	234-4001	234-4212	-	-
V8-5.8	1995	Exc. Calif.	234-4071	234-4212	-	-
V8-5.8	1994-1991	GVW Over 8,500 Lbs.	234-4070	234-4212	-	-
V8-5.8	1994-1991	GVW Under 8,500 Lbs.	234-4071	234-4212	-	-
V8-5.8	1990	GVW Over 8,500 Lbs.	234-4611	234-4210	-	-
V8-5.8	1990	GVW Under 8,500 Lbs.	234-4070	234-4212	-	-
V8-5.8	1989-1988	w/ 16" Sensor	234-3007	234-3000	-	-
V8-5.8	1989-1988	w/ 8" Sensor	234-3002	234-3000	-	-
V8-5.8	1987-1986	3 Lead Sensor; w/ 16" Pigtail	234-3007	234-3000	-	-
V8-5.8	1987-1986	3 Lead Sensor; w/ 8" Pigtail	234-3002	234-3000	-	-
V8-5.8	1987-1984	1 Lead Sensor	234-1004	234-1000	-	-
V8-5.8	1983-1981		234-1003	234-1000	-	-
V8-7.5	1991	3 Lead Sensor	234-3007 <sup>1</sup>	234-3000 <sup>1</sup>	-	-
V8-7.5	1991	4 Lead Sensor; OE #F4UZ9F472C	234-4070 <sup>1</sup>	234-4212 <sup>1</sup>	-	-
V8-7.5	1991	4 Lead Sensor; OE #F09Z9F472C	234-4611 <sup>1</sup>	234-4210 <sup>1</sup>	-	-
V8-7.5	1990-1988	3 Lead Sensor	234-3007	234-3000	-	-
V8-7.5	1990	4 Lead Sensor	234-4611	234-4210	-	-
<b>E-350 SUPER DUTY</b>						
V8-5.4	2014-2011		234-5113 <sup>1</sup>	-	234-4127 <sup>1</sup>	234-4212 <sup>1</sup>
V8-5.4	2010-2009	Cutaway / Stripped Chassis Cabs	234-5113 <sup>1</sup>	-	234-4127	234-4212
V8-5.4	2010-2009	Regular / Extended Vans	234-5113 <sup>1</sup>	-	234-4127 <sup>1</sup>	234-4212 <sup>1</sup>
V8-5.4	2008-2005		234-4374 <sup>1</sup>	-	234-4127 <sup>1</sup>	234-4212 <sup>1</sup>

<sup>1</sup> 2 Required / Requis 2 / Requeridos 2



ENGINE MOTEUR MOTOR	YEAR ANNEE AÑO	APPLICATION INFORMATION INFORMATION D'APPLICATION INFORMACION DE APLICACION	UPSTREAM / AVANT - C.C. / ANTES DEL C.C.		DOWNSTREAM / APRES - C.C. / DESPUES DEL C.C.	
			TYPE / TIPO O.E.	UNIVERS.	TYPE / TIPO O.E.	UNIVERS.
<b>FORD [cont]</b>						
<b>E-350 SUPER DUTY [cont]</b>						
V8-5.4	2004-2002		234-4045 <sup>1</sup>	-	234-4127 <sup>1</sup>	234-4212 <sup>1</sup>
V8-5.4	2001		234-4045 <sup>1</sup>	-	234-4609 <sup>1</sup>	234-4210 <sup>1</sup>
V8-5.4	2000	Trans Code 4R100	234-4045 <sup>1</sup>	-	234-4610 <sup>1</sup>	234-4210 <sup>1</sup>
V8-5.4	2000	Trans Code 4R70W	234-4045 <sup>1</sup>	-	234-4609 <sup>1</sup>	234-4210 <sup>1</sup>
V8-5.4	1999	Bi-Fuel Engine; w/ 11" Upstream Sensors	234-4071 <sup>1</sup>	234-4212 <sup>1</sup>	234-4127 <sup>1</sup>	234-4212 <sup>1</sup>
V8-5.4	1999	Bi-Fuel Engine; w/ 19" Upstream Sensors	234-4045 <sup>1</sup>	-	234-4609 <sup>1</sup>	234-4210 <sup>1</sup>
V8-5.4	1999	CNG Engine	234-4609 <sup>1</sup>	234-4210 <sup>1</sup>	234-4127 <sup>1</sup>	234-4212 <sup>1</sup>
V8-5.4	1999	Gas Engine	234-4071 <sup>1</sup>	234-4212 <sup>1</sup>	234-4127 <sup>1</sup>	234-4212 <sup>1</sup>
V10-6.8	2014-2013	Ambulance	234-5113 <sup>4</sup>	-	234-4495 <sup>4</sup>	-
V10-6.8	2014-2013	Ambulance	234-5097 <sup>5</sup>	-	234-4495 <sup>5</sup>	-
V10-6.8	2014-2013	Exc. Ambulance	234-5113 <sup>4</sup>	-	234-4127 <sup>4</sup>	234-4212 <sup>4</sup>
V10-6.8	2014-2013	Exc. Ambulance	234-5097 <sup>5</sup>	-	234-4127 <sup>5</sup>	234-4212 <sup>5</sup>
V10-6.8	2012-2011	Cutaway / Stripped Chassis Cabs	234-4403 <sup>4</sup>	-	234-4495 <sup>4</sup>	-
V10-6.8	2012-2011	Cutaway / Stripped Chassis Cabs	234-4401 <sup>5</sup>	-	234-4495 <sup>5</sup>	-
V10-6.8	2012-2009	Regular / Extended Vans	234-4403 <sup>4</sup>	-	234-4127 <sup>4</sup>	234-4212 <sup>4</sup>
V10-6.8	2012-2009	Regular / Extended Vans	234-4401 <sup>5</sup>	-	234-4127 <sup>5</sup>	234-4212 <sup>5</sup>
V10-6.8	2010-2009	Cutaway / Stripped Chassis Cabs	234-4403 <sup>4</sup>	-	234-4127	234-4212
V10-6.8	2010-2009	Cutaway / Stripped Chassis Cabs	234-4401 <sup>5</sup>	-	-	-
V10-6.8	2008-2005		234-4374 <sup>1</sup>	-	234-4127 <sup>1</sup>	234-4212 <sup>1</sup>
V10-6.8	2004-2002		234-4045 <sup>1</sup>	-	234-4127 <sup>1</sup>	234-4212 <sup>1</sup>
V10-6.8	2001-2000		234-4045 <sup>1</sup>	-	234-4609 <sup>1</sup>	234-4210 <sup>1</sup>
V10-6.8	1999	w/ 10.75" Upstream Lead	234-4071 <sup>1</sup>	234-4212 <sup>1</sup>	234-4127 <sup>1</sup>	234-4212 <sup>1</sup>
V10-6.8	1999	w/ 15.5" Upstream Lead	234-4127 <sup>1</sup>	234-4212 <sup>1</sup>	234-4127 <sup>1</sup>	234-4212 <sup>1</sup>
<b>E-350 VAN</b>						
L6-4.9	1996		234-4071 <sup>1</sup>	234-4212 <sup>1</sup>	234-4127 <sup>1</sup>	234-4212 <sup>1</sup>
L6-4.9	1995-1991		234-4071	234-4212	-	-
L6-4.9	1990	w/ 11" Sensor	234-4070	234-4212	-	-
L6-4.9	1990	w/ 16" Sensor	234-4609	234-4210	-	-
L6-4.9	1990	w/ 19" Sensor	234-4611	234-4210	-	-
L6-4.9	1989-1987		234-3002	234-3000	-	-
L6-4.9	1986-1984		234-1004	234-1000	-	-
L6-4.9	1983-1981		234-1003	234-1000	-	-
V8-5.0	1982-1980		234-1003	234-1000	-	-
V8-5.4	2005		234-4374 <sup>1</sup>	-	234-4127 <sup>1</sup>	234-4212 <sup>1</sup>
V8-5.4	2004-2002		234-4045 <sup>1</sup>	-	234-4127 <sup>1</sup>	234-4212 <sup>1</sup>
V8-5.4	2001		234-4045 <sup>1</sup>	-	234-4609 <sup>1</sup>	234-4210 <sup>1</sup>
V8-5.4	2000	Trans Code 4R100	234-4045 <sup>1</sup>	-	234-4610 <sup>1</sup>	234-4210 <sup>1</sup>
V8-5.4	2000	Trans Code 4R70W	234-4045 <sup>1</sup>	-	234-4609 <sup>1</sup>	234-4210 <sup>1</sup>
V8-5.4	1999-1998	Gas Engine	234-4071 <sup>1</sup>	234-4212 <sup>1</sup>	234-4127 <sup>1</sup>	234-4212 <sup>1</sup>

<sup>1</sup> 2 Required / Requis 2 / Requeridos 2 <sup>4</sup> Left Side / Côté gauche / Lado izquierdo <sup>5</sup> Right Side / Côté droit / Lado derecho





ENGINE MOTEUR MOTOR	YEAR ANNEE AÑO	APPLICATION INFORMATION INFORMATION D'APPLICATION INFORMACION DE APLICACION	UPSTREAM / AVANT - C.C. / ANTES DEL C.C.		DOWNSTREAM / APRS - C.C. / DESPUES DEL C.C.	
			TYPE / TIPO O.E.	UNIVERS.	TYPE / TIPO O.E.	UNIVERS.
<b>FORD [cont]</b>						
<b>E-350 VAN [cont]</b>						
V8-5.4	1999-1997	CNG Engine	234-4609 <sup>1</sup>	234-4210 <sup>1</sup>	234-4127 <sup>1</sup>	234-4212 <sup>1</sup>
V8-5.4	1999	Bi-Fuel Engine; w/ 11" Upstream Sensors	234-4071 <sup>1</sup>	234-4212 <sup>1</sup>	234-4127 <sup>1</sup>	234-4212 <sup>1</sup>
V8-5.4	1999	Bi-Fuel Engine; w/ 19" Upstream Sensors	234-4045 <sup>1</sup>	-	234-4609 <sup>1</sup>	234-4210 <sup>1</sup>
V8-5.4	1998	Bi-Fuel Engine	234-4071 <sup>1</sup>	234-4212 <sup>1</sup>	234-4127 <sup>1</sup>	234-4212 <sup>1</sup>
V8-5.4	1997	Gas Engine	234-4127 <sup>1</sup>	234-4212 <sup>1</sup>	234-4127 <sup>1</sup>	234-4212 <sup>1</sup>
V8-5.8	1996		234-4071 <sup>1</sup>	234-4212 <sup>1</sup>	234-4070 <sup>1</sup>	234-4212 <sup>1</sup>
V8-5.8	1995	Calif.	234-4001	234-4212	-	-
V8-5.8	1995	Exc. Calif.	234-4070	234-4212	-	-
V8-5.8	1994-1991		234-4070	234-4212	-	-
V8-5.8	1990		234-4611	234-4210	-	-
V8-5.8	1989-1986	3 Lead Sensor; w/ 16" Pigtail	234-3007	234-3000	-	-
V8-5.8	1989-1986	3 Lead Sensor; w/ 8" Pigtail	234-3002	234-3000	-	-
V8-5.8	1987-1984	1 Lead Sensor	234-1004	234-1000	-	-
V8-5.8	1983-1981		234-1003	234-1000	-	-
V8-7.5	1996	w/ 10" Upstream Sensor	234-4071 <sup>1</sup>	234-4212 <sup>1</sup>	234-4070	234-4212
V8-7.5	1996	w/ 15" Upstream Sensor	234-4127 <sup>1</sup>	234-4212 <sup>1</sup>	234-4070	234-4212
V8-7.5	1995-1994		234-4127 <sup>1</sup>	234-4212 <sup>1</sup>	-	-
V8-7.5	1993		234-4070 <sup>1</sup>	234-4212 <sup>1</sup>	-	-
V8-7.5	1992-1991	3 Lead Sensor	234-3007 <sup>1</sup>	234-3000 <sup>1</sup>	-	-
V8-7.5	1992-1991	4 Lead Sensor; OE #F4UZ9F472C	234-4070 <sup>1</sup>	234-4212 <sup>1</sup>	-	-
V8-7.5	1992-1991	4 Lead Sensor; OE #F09Z9F472C	234-4611 <sup>1</sup>	234-4210 <sup>1</sup>	-	-
V8-7.5	1990-1987	3 Lead Sensor	234-3007	234-3000	-	-
V8-7.5	1990	4 Lead Sensor	234-4611	234-4210	-	-
V10-6.8	2005		234-4374 <sup>1</sup>	-	234-4127 <sup>1</sup>	234-4212 <sup>1</sup>
V10-6.8	2003-2002		234-4045 <sup>1</sup>	-	234-4127 <sup>1</sup>	234-4212 <sup>1</sup>
V10-6.8	2001-2000		234-4045 <sup>1</sup>	-	234-4609 <sup>1</sup>	234-4210 <sup>1</sup>
V10-6.8	1999-1998	w/ 11" Upstream Sensor	234-4071 <sup>1</sup>	234-4212 <sup>1</sup>	234-4127 <sup>1</sup>	234-4212 <sup>1</sup>
V10-6.8	1999	w/ 16" Upstream Sensor	234-4127 <sup>1</sup>	234-4212 <sup>1</sup>	234-4127 <sup>1</sup>	234-4212 <sup>1</sup>
V10-6.8	1997		234-4127 <sup>1</sup>	234-4212 <sup>1</sup>	234-4127 <sup>1</sup>	234-4212 <sup>1</sup>
<b>E-450 ECONOLINE SUPER DUTY</b>						
V8-5.4	2002		234-4045 <sup>1</sup>	-	234-4127 <sup>1</sup>	234-4212 <sup>1</sup>
V8-5.4	2001		234-4045 <sup>1</sup>	-	234-4609 <sup>1</sup>	234-4210 <sup>1</sup>
V8-5.4	2000	CNG Engine; Exc. Trans Code 4R100	234-4045 <sup>1</sup>	-	234-4609 <sup>1</sup>	234-4210 <sup>1</sup>
V8-5.4	2000	CNG Engine; Trans Code 4R100	234-4045 <sup>1</sup>	-	234-4610 <sup>1</sup>	234-4210 <sup>1</sup>
V8-5.4	2000	Gas Engine; Trans Code 4R70W	234-4045 <sup>1</sup>	-	234-4609 <sup>1</sup>	234-4210 <sup>1</sup>
V10-6.8	2002		234-4045 <sup>1</sup>	-	234-4127 <sup>1</sup>	234-4212 <sup>1</sup>
V10-6.8	2001-2000		234-4045 <sup>1</sup>	-	234-4609 <sup>1</sup>	234-4210 <sup>1</sup>
<b>ECONOLINE SUPER DUTY</b>						
V8-5.4	1999		234-4609 <sup>1</sup>	234-4210 <sup>1</sup>	234-4127 <sup>1</sup>	234-4212 <sup>1</sup>

<sup>1</sup> 2 Required / Requis 2 / Requeridos 2



ENGINE MOTEUR MOTOR	YEAR ANNEE AÑO	APPLICATION INFORMATION INFORMATION D'APPLICATION INFORMACION DE APLICACION	UPSTREAM / AVANT - C.C. / ANTES DEL C.C.		DOWNSTREAM / APRS - C.C. / DESPUES DEL C.C.	
			TYPE / TIPO O.E.	UNIVERS.	TYPE / TIPO O.E.	UNIVERS.
<b>FORD [cont]</b>						
<b>ECONOLINE SUPER DUTY [cont]</b>						
V8-5.4	1998		234-4071 <sup>1</sup>	234-4212 <sup>1</sup>	234-4127 <sup>1</sup>	234-4212 <sup>1</sup>
V8-5.4	1997		234-4127 <sup>1</sup>	234-4212 <sup>1</sup>	234-4127 <sup>1</sup>	234-4212 <sup>1</sup>
V8-5.8	1996		234-4071 <sup>1</sup>	234-4212 <sup>1</sup>	234-4070 <sup>1</sup>	234-4212 <sup>1</sup>
V8-7.5	1996	w/ 11" Upstream Sensor	234-4071 <sup>1</sup>	234-4212 <sup>1</sup>	234-4070	234-4212
V8-7.5	1996	w/ 16" Upstream Sensor	234-4127 <sup>1</sup>	234-4212 <sup>1</sup>	234-4070	234-4212
V10-6.8	1999-1998	w/ 11" Upstream Sensor	234-4071 <sup>1</sup>	234-4212 <sup>1</sup>	234-4127 <sup>1</sup>	234-4212 <sup>1</sup>
V10-6.8	1999	w/ 16" Upstream Sensor	234-4127 <sup>1</sup>	234-4212 <sup>1</sup>	234-4127 <sup>1</sup>	234-4212 <sup>1</sup>
V10-6.8	1997		234-4127 <sup>1</sup>	234-4212 <sup>1</sup>	234-4127 <sup>1</sup>	234-4212 <sup>1</sup>
<b>EDGE</b>						
L4-2.0	2014-2013		234-5097	-	234-4575	-
L4-2.0	2012		234-5097 <sup>1</sup>	-	234-4575 <sup>1</sup>	-
V6-3.5	2014-2011		234-5038 <sup>1</sup>	-	234-4489 <sup>1</sup>	-
V6-3.5	2010		234-5097 <sup>1</sup>	-	234-4610 <sup>1</sup>	234-4210 <sup>1</sup>
V6-3.5	2009-2007		234-4372 <sup>1</sup>	-	234-4610 <sup>1</sup>	234-4210 <sup>1</sup>
V6-3.7	2014-2011		234-5038 <sup>1</sup>	-	234-4489 <sup>1</sup>	-
<b>ESCAPE</b>						
L4-1.6	2015-2013		234-5068	-	234-4577	-
L4-2.0	2015-2013		234-5097	-	234-4575	-
L4-2.0	2004-2001		234-4045	-	234-4608	234-4210
L4-2.3	2008-2005		234-4374	-	234-4609	234-4210
L4-2.5	2015-2014		234-5176	-	234-4578	-
L4-2.5	2013		234-5039	-	234-4578	-
L4-2.5	2012-2011	Gas Engine; Auto Trans	234-5039	-	234-4490	-
L4-2.5	2012-2011	Gas Engine; Manual Trans	234-4740	-	234-4490	-
L4-2.5	2012-2011	Hybrid Engine	234-5113	-	234-4490	-
L4-2.5	2010-2009	Hybrid Engine	234-5113	-	234-4609	234-4210
L4-2.5	2010	Gas Engine; Auto Trans	234-5039	-	234-4609	234-4210
L4-2.5	2010	Gas Engine; Manual Trans	234-4374	-	234-4609	234-4210
L4-2.5	2009	Gas Engine	234-4374	-	234-4609	234-4210
V6-3.0	2012-2011		234-5038 <sup>15</sup>	-	234-4490 <sup>15</sup>	-
V6-3.0	2012-2011		234-5038 <sup>16</sup>	-	234-4490 <sup>16</sup>	-
V6-3.0	2010		234-5038 <sup>1</sup>	-	234-4609 <sup>1</sup>	234-4210 <sup>1</sup>
V6-3.0	2009		234-4106 <sup>1</sup>	-	234-4609 <sup>1</sup>	234-4210 <sup>1</sup>
V6-3.0	2008-2007		234-4046 <sup>1</sup>	-	234-4609 <sup>1</sup>	234-4210 <sup>1</sup>
V6-3.0	2006-2001		234-4045 <sup>15</sup>	-	234-4609 <sup>15</sup>	234-4210 <sup>15</sup>
V6-3.0	2006-2001		234-4046 <sup>16</sup>	-	234-4609 <sup>16</sup>	234-4210 <sup>16</sup>
<b>ESCORT</b>						
L4-1.6	1985-1983		234-1003	234-1000	-	-
L4-1.8	1996		234-4606	234-4209	234-4605	234-4209
L4-1.8	1995		234-4606	234-4209	-	-

<sup>1</sup> 2 Required / Requis 2 / Requeridos 2 <sup>15</sup> Front / Avant / Parte delantera <sup>16</sup> Rear / Arrière / Parte trasera



ENGINE MOTEUR MOTOR	YEAR ANNEE AÑO	APPLICATION INFORMATION INFORMATION D'APPLICATION INFORMACION DE APLICACION	UPSTREAM / AVANT - C.C. / ANTES DEL C.C.		DOWNSTREAM / APRS - C.C. / DESPUES DEL C.C.	
			TYPE / TIPO O.E.	UNIVERS.	TYPE / TIPO O.E.	UNIVERS.
<b>FORD [cont]</b>						
<b>ESCORT [cont]</b>						
L4-1.8	1994-1991		234-1010	234-1000	-	-
L4-1.9	1996		234-4610	234-4210	234-4611	234-4210
L4-1.9	1995-1994		234-4610	234-4210	-	-
L4-1.9	1993-1992		234-4070	234-4212	-	-
L4-1.9	1991-1987		234-3002	234-3000	-	-
L4-1.9	1986-1985		234-3001	234-3000	-	-
L4-2.0	2003		234-4045	-	234-4611	234-4210
L4-2.0	2002-2001	VIN 3	234-4045	-	234-4611	234-4210
L4-2.0	2002-2000	VIN P	234-4610	234-4210	234-4611	234-4210
L4-2.0	2000	VIN 3	234-4046	-	234-4611	234-4210
L4-2.0	1999-1997		234-4610	234-4210	234-4611	234-4210
<b>EXCURSION</b>						
V8-5.4	2005-2000		234-4045 <sup>1</sup>	-	234-4610 <sup>1</sup>	234-4210 <sup>1</sup>
V10-6.8	2005-2000		234-4045 <sup>1</sup>	-	234-4610 <sup>1</sup>	234-4210 <sup>1</sup>
<b>EXP</b>						
L4-1.6	1985-1983		234-1003	234-1000	-	-
L4-1.9	1988-1987		234-3002	234-3000	-	-
L4-1.9	1986		234-3001	234-3000	-	-
<b>EXPEDITION</b>						
V8-4.6	2004-1999		234-4046 <sup>1</sup>	-	234-4127 <sup>1</sup>	234-4212 <sup>1</sup>
V8-4.6	1998-1997		234-4071 <sup>1</sup>	234-4212 <sup>1</sup>	234-4127 <sup>1</sup>	234-4212 <sup>1</sup>
V8-5.4	2014-2012		234-5076 <sup>4</sup>	-	234-4576 <sup>4</sup>	-
V8-5.4	2014-2012		234-5113 <sup>5</sup>	-	234-4576 <sup>5</sup>	-
V8-5.4	2011		234-5113 <sup>5</sup>	-	234-4127 <sup>5</sup>	234-4212 <sup>5</sup>
V8-5.4	2011	From 12/17/2010	234-5076 <sup>4</sup>	-	234-4127 <sup>4</sup>	234-4212 <sup>4</sup>
V8-5.4	2011	To 12/17/2010	234-5108 <sup>4</sup>	-	234-4127 <sup>4</sup>	234-4212 <sup>4</sup>
V8-5.4	2010-2009		234-5108 <sup>4</sup>	-	234-4127 <sup>4</sup>	234-4212 <sup>4</sup>
V8-5.4	2010-2009		234-5113 <sup>5</sup>	-	234-4127 <sup>5</sup>	234-4212 <sup>5</sup>
V8-5.4	2008-2007		234-4403 <sup>4</sup>	-	234-4127 <sup>4</sup>	234-4212 <sup>4</sup>
V8-5.4	2008-2007		234-4401 <sup>5</sup>	-	234-4127 <sup>5</sup>	234-4212 <sup>5</sup>
V8-5.4	2006-2005		234-4401 <sup>1</sup>	-	234-4127 <sup>1</sup>	234-4212 <sup>1</sup>
V8-5.4	2004-2003		234-4046 <sup>1</sup>	-	234-4127 <sup>1</sup>	234-4212 <sup>1</sup>
V8-5.4	2002-2001		234-4401 <sup>1</sup>	-	234-4127 <sup>1</sup>	234-4212 <sup>1</sup>
V8-5.4	2000-1999		234-4046 <sup>1</sup>	-	234-4127 <sup>1</sup>	234-4212 <sup>1</sup>
V8-5.4	1998-1997		234-4071 <sup>1</sup>	234-4212 <sup>1</sup>	234-4127 <sup>1</sup>	234-4212 <sup>1</sup>
<b>EXPLORER</b>						
L4-2.0	2015-2012		234-5097	-	234-4575	-
V6-3.5	2015-2014	Non-Turbo	234-5038 <sup>1</sup>	-	234-4490 <sup>1</sup>	-
V6-3.5	2015	Turbo	234-5113 <sup>4</sup>	-	234-4491 <sup>4</sup>	-
V6-3.5	2015	Turbo	234-5113 <sup>5</sup>	-	234-4489 <sup>5</sup>	-

<sup>1</sup> 2 Required / Requis 2 / Requeridos 2 <sup>4</sup> Left Side / Côté gauche / Lado izquierdo <sup>5</sup> Right Side / Côté droit / Lado derecho



ENGINE MOTEUR MOTOR	YEAR ANNEE AÑO	APPLICATION INFORMATION INFORMATION D'APPLICATION INFORMACION DE APLICACION	UPSTREAM / AVANT - C.C. / ANTES DEL C.C.		DOWNSTREAM / APRS - C.C. / DESPUES DEL C.C.	
			TYPE / TIPO O.E.	UNIVERS.	TYPE / TIPO O.E.	UNIVERS.
<b>FORD [cont]</b>						
<b>EXPLORER [cont]</b>						
V6-3.5	2014	Turbo	234-5113 <sup>4</sup>	-	234-4489 <sup>4</sup>	-
V6-3.5	2014	Turbo	234-5113 <sup>5</sup>	-	234-4491 <sup>5</sup>	-
V6-3.5	2013	Non-Turbo	234-5038 <sup>15</sup>	-	234-4491 <sup>15</sup>	-
V6-3.5	2013	Non-Turbo	234-5038 <sup>16</sup>	-	234-4490 <sup>16</sup>	-
V6-3.5	2013	Turbo	234-5113 <sup>15</sup>	-	234-4489 <sup>15</sup>	-
V6-3.5	2013	Turbo	234-5113 <sup>16</sup>	-	234-4491 <sup>16</sup>	-
V6-3.5	2012-2011		234-5038 <sup>1</sup>	-	234-4489 <sup>1</sup>	-
V6-4.0	2010-2004	w/ 15" Downstream Sensor	234-4401 <sup>1</sup>	-	234-4127 <sup>1</sup>	234-4212 <sup>1</sup>
V6-4.0	2005-2004	w/ 11" Downstream Sensor	234-4401 <sup>1</sup>	-	234-4071 <sup>1</sup>	234-4212 <sup>1</sup>
V6-4.0	2003-2001	VIN K	234-4046 <sup>4</sup>	-	234-4610 <sup>4</sup>	234-4210 <sup>4</sup>
V6-4.0	2003-2001	VIN K	234-4046 <sup>5</sup>	-	234-4609 <sup>5</sup>	234-4210 <sup>5</sup>
V6-4.0	2003-1999	VIN E	234-4403 <sup>1</sup>	-	234-4071 <sup>1</sup>	234-4212 <sup>1</sup>
V6-4.0	2000-1999	VIN X	234-4401 <sup>4</sup>	-	234-4070	234-4212
V6-4.0	2000-1999	VIN X	234-4403 <sup>5</sup>	-	-	-
V6-4.0	1998	VIN E	234-4070 <sup>4</sup>	234-4212 <sup>4</sup>	234-4071 <sup>4</sup>	234-4212 <sup>4</sup>
V6-4.0	1998	VIN E	234-4127 <sup>5</sup>	234-4212 <sup>5</sup>	234-4071 <sup>5</sup>	234-4212 <sup>5</sup>
V6-4.0	1998	VIN X	234-4071 <sup>4</sup>	234-4212 <sup>4</sup>	234-4070	234-4212
V6-4.0	1998	VIN X	234-4127 <sup>5</sup>	234-4212 <sup>5</sup>	-	-
V6-4.0	1997	VIN E	234-4070 <sup>1</sup>	234-4212 <sup>1</sup>	234-4071 <sup>1</sup>	234-4212 <sup>1</sup>
V6-4.0	1997	VIN X	234-4127 <sup>1</sup>	234-4212 <sup>1</sup>	234-4070	234-4212
V6-4.0	1996		234-4127 <sup>1</sup>	234-4212 <sup>1</sup>	234-4070	234-4212
V6-4.0	1995		234-4127 <sup>1</sup>	234-4212 <sup>1</sup>	-	-
V6-4.0	1994-1992		234-4070	234-4212	-	-
V6-4.0	1991		234-4611	234-4210	-	-
V8-4.6	2010-2004	w/ 15" Downstream Sensor	234-4401 <sup>1</sup>	-	234-4127 <sup>1</sup>	234-4212 <sup>1</sup>
V8-4.6	2005-2004	w/ 11" Downstream Sensor	234-4401 <sup>1</sup>	-	234-4071 <sup>1</sup>	234-4212 <sup>1</sup>
V8-4.6	2003-2002		234-4046 <sup>4</sup>	-	234-4609 <sup>4</sup>	234-4210 <sup>4</sup>
V8-4.6	2003-2002		234-4046 <sup>5</sup>	-	234-4610 <sup>5</sup>	234-4210 <sup>5</sup>
V8-5.0	2001-1999		234-4401 <sup>4</sup>	-	234-4071 <sup>4</sup>	234-4212 <sup>4</sup>
V8-5.0	2001-1999		234-4403 <sup>5</sup>	-	234-4071 <sup>5</sup>	234-4212 <sup>5</sup>
V8-5.0	1998-1996		234-4071 <sup>4</sup>	234-4212 <sup>4</sup>	234-4071 <sup>4</sup>	234-4212 <sup>4</sup>
V8-5.0	1998-1996		234-4127 <sup>5</sup>	234-4212 <sup>5</sup>	234-4071 <sup>5</sup>	234-4212 <sup>5</sup>
<b>EXPLORER SPORT TRAC</b>						
V6-4.0	2010-2007		234-4401 <sup>1</sup>	-	234-4127 <sup>1</sup>	234-4212 <sup>1</sup>
V6-4.0	2005-2004		234-4403 <sup>1</sup>	-	234-4401 <sup>1</sup>	-
V6-4.0	2003-2001		234-4403 <sup>1</sup>	-	234-4071 <sup>1</sup>	234-4212 <sup>1</sup>
V8-4.6	2010-2007		234-4401 <sup>1</sup>	-	234-4127 <sup>1</sup>	234-4212 <sup>1</sup>
<b>F-100</b>						
L6-4.9	1983-1980		234-1003	234-1000	-	-

<sup>1</sup> 2 Required / Requis 2 / Requeridos 2 <sup>4</sup> Left Side / Côté gauche / Lado izquierdo <sup>5</sup> Right Side / Côté droit / Lado derecho <sup>15</sup> Front / Avant / Parte delantera <sup>16</sup> Rear / Arrière / Parte trasera



ENGINE MOTEUR MOTOR	YEAR ANNEE AÑO	APPLICATION INFORMATION INFORMATION D'APPLICATION INFORMACION DE APLICACION	UPSTREAM / AVANT - C.C. / ANTES DEL C.C.		DOWNSTREAM / APRES - C.C. / DESPUES DEL C.C.	
			TYPE / TIPO O.E.	UNIVERS.	TYPE / TIPO O.E.	UNIVERS.
<b>FORD [cont]</b>						
<b>F-100 [cont]</b>						
V6-3.8	1983-1982		234-1003	234-1000	-	-
V8-4.2	1982-1981		234-1003	234-1000	-	-
V8-5.0	1983-1980		234-1003	234-1000	-	-
V8-5.8	1981		234-1003	234-1000	-	-
<b>F-150</b>						
L6-4.9	1996		234-4071 <sup>1</sup>	234-4212 <sup>1</sup>	234-4070	234-4212
L6-4.9	1995	Auto Trans; Calif.	234-4071	234-4212	-	-
L6-4.9	1995	Auto Trans; Exc. Calif.	234-4070	234-4212	-	-
L6-4.9	1995	Manual Trans	234-4070	234-4212	-	-
L6-4.9	1994-1990	w/ 10" Sensor	234-4070	234-4212	-	-
L6-4.9	1990	w/ 15" Sensor	234-4611	234-4210	-	-
L6-4.9	1989-1987	w/ 16" Sensor	234-3007	234-3000	-	-
L6-4.9	1989-1987	w/ 8" Sensor	234-3002	234-3000	-	-
L6-4.9	1986-1984		234-1004	234-1000	-	-
L6-4.9	1983-1980		234-1003	234-1000	-	-
V6-2.7	2015		234-5174 <sup>4</sup>	-	234-4968 <sup>4</sup>	-
V6-2.7	2015		234-5173 <sup>5</sup>	-	234-4968 <sup>5</sup>	-
V6-3.5	2015	Flex Fuel Engine	234-5176 <sup>1</sup>	-	234-4968 <sup>1</sup>	-
V6-3.5	2015	Gas Engine	234-5076 <sup>4</sup>	-	234-4961 <sup>4</sup>	-
V6-3.5	2015	Gas Engine	234-5113 <sup>5</sup>	-	234-4961 <sup>5</sup>	-
V6-3.5	2014-2011		234-5076 <sup>4</sup>	-	234-4490 <sup>4</sup>	-
V6-3.5	2014-2011		234-5113 <sup>5</sup>	-	234-4490 <sup>5</sup>	-
V6-3.7	2014-2011		234-5038 <sup>1</sup>	-	234-4490 <sup>1</sup>	-
V6-4.2	2008-2005		234-4401 <sup>1</sup>	-	234-4401 <sup>1</sup>	-
V6-4.2	2003-2002		234-4401 <sup>1</sup>	-	234-4127 <sup>1</sup>	234-4212 <sup>1</sup>
V6-4.2	2001		234-4046 <sup>1</sup>	-	234-4127 <sup>1</sup>	234-4212 <sup>1</sup>
V6-4.2	2000-1999	Calif.	234-4046 <sup>1</sup>	-	234-4127 <sup>1</sup>	234-4212 <sup>1</sup>
V6-4.2	2000-1999	Exc. Calif.	234-4071 <sup>1</sup>	234-4212 <sup>1</sup>	234-4127 <sup>1</sup>	234-4212 <sup>1</sup>
V6-4.2	1998-1997		234-4071 <sup>1</sup>	234-4212 <sup>1</sup>	234-4127 <sup>1</sup>	234-4212 <sup>1</sup>
V8-4.6	2010-2009	VIN W	234-5113 <sup>1</sup>	-	234-4127 <sup>1</sup>	234-4212 <sup>1</sup>
V8-4.6	2010	VIN 8.	234-5113 <sup>5</sup>	-	234-4127 <sup>5</sup>	234-4212 <sup>5</sup>
V8-4.6	2010	VIN 8; From 02/01/10	234-5076 <sup>4</sup>	-	234-4127 <sup>4</sup>	234-4212 <sup>4</sup>
V8-4.6	2010	VIN 8; To 01/31/10	234-5108 <sup>4</sup>	-	234-4127 <sup>4</sup>	234-4212 <sup>4</sup>
V8-4.6	2009	VIN 8	234-5108 <sup>4</sup>	-	234-4127 <sup>4</sup>	234-4212 <sup>4</sup>
V8-4.6	2009	VIN 8	234-5113 <sup>5</sup>	-	234-4127 <sup>5</sup>	234-4212 <sup>5</sup>
V8-4.6	2008-2004		234-4401 <sup>1</sup>	-	234-4401 <sup>1</sup>	-
V8-4.6	2003-1999		234-4046 <sup>1</sup>	-	234-4127 <sup>1</sup>	234-4212 <sup>1</sup>
V8-4.6	1998-1997		234-4071 <sup>1</sup>	234-4212 <sup>1</sup>	234-4127 <sup>1</sup>	234-4212 <sup>1</sup>
V8-5.0	2015		234-5177 <sup>4</sup>	-	234-4968 <sup>4</sup>	-
V8-5.0	2015		234-5176 <sup>5</sup>	-	234-4968 <sup>5</sup>	-

<sup>1</sup> 2 Required / Requis 2 / Requeridos 2 <sup>4</sup> Left Side / Côté gauche / Lado izquierdo <sup>5</sup> Right Side / Côté droit / Lado derecho



ENGINE MOTEUR MOTOR	YEAR ANNEE AÑO	APPLICATION INFORMATION INFORMATION D'APPLICATION INFORMACION DE APLICACION	UPSTREAM / AVANT - C.C. / ANTES DEL C.C.		DOWNSTREAM / APRES - C.C. / DESPUES DEL C.C.	
			TYPE / TIPO O.E.	UNIVERS.	TYPE / TIPO O.E.	UNIVERS.
<b>FORD [cont]</b>						
<b>F-150 [cont]</b>						
V8-5.0	2014-2011		234-5076 <sup>4</sup>	-	234-4494 <sup>4</sup>	-
V8-5.0	2014-2011		234-5113 <sup>5</sup>	-	234-4494 <sup>5</sup>	-
V8-5.0	1996		234-4071 <sup>1</sup>	234-4212 <sup>1</sup>	234-4070	234-4212
V8-5.0	1995-1991		234-4071	234-4212	-	-
V8-5.0	1990-1987	3 Lead Sensor; w/ 19" Pigtail	234-3007	234-3000	-	-
V8-5.0	1990	3 Lead Sensor; w/ 11" Pigtail	234-3002	234-3000	-	-
V8-5.0	1990	4 Lead Sensor	234-4609	234-4210	-	-
V8-5.0	1986-1985	w/ 17" Sensor	234-1004	234-1000	-	-
V8-5.0	1985-1980	w/ 7" Sensor	234-1003	234-1000	-	-
V8-5.4	2010-2009		234-5113 <sup>5</sup>	-	234-4127 <sup>5</sup>	234-4212 <sup>5</sup>
V8-5.4	2010	From 02/01/10	234-5076 <sup>4</sup>	-	234-4127 <sup>4</sup>	234-4212 <sup>4</sup>
V8-5.4	2010	To 01/31/10	234-5108 <sup>4</sup>	-	234-4127 <sup>4</sup>	234-4212 <sup>4</sup>
V8-5.4	2009		234-5108 <sup>4</sup>	-	234-4127 <sup>4</sup>	234-4212 <sup>4</sup>
V8-5.4	2008-2004		234-4401 <sup>1</sup>	-	234-4401 <sup>1</sup>	-
V8-5.4	2003		234-4401 <sup>1</sup>	-	234-4127 <sup>1</sup>	234-4212 <sup>1</sup>
V8-5.4	2002-2001	VIN 3 & Z	234-4401 <sup>1</sup>	-	234-4127 <sup>1</sup>	234-4212 <sup>1</sup>
V8-5.4	2002	VIN L	234-4401 <sup>1</sup>	-	234-4127 <sup>1</sup>	234-4212 <sup>1</sup>
V8-5.4	2002	VIN M	234-4045 <sup>1</sup>	-	234-4610 <sup>1</sup>	234-4210 <sup>1</sup>
V8-5.4	2001-2000	VIN M	234-4045 <sup>1</sup>	-	234-4127 <sup>1</sup>	234-4212 <sup>1</sup>
V8-5.4	2001	VIN L; Trans Code 4R100	234-4401 <sup>1</sup>	-	234-4127 <sup>1</sup>	234-4212 <sup>1</sup>
V8-5.4	2001	VIN L; Trans Code 4R70W; Upstream OE #5C5Z9F472AA	234-4046 <sup>1</sup>	-	234-4127 <sup>1</sup>	234-4212 <sup>1</sup>
V8-5.4	2001	VIN L; Trans Code 4R70W; Upstream OE #XL3Z9F472AA	234-4401 <sup>1</sup>	-	234-4127 <sup>1</sup>	234-4212 <sup>1</sup>
V8-5.4	2000	VIN 3; Exc. Calif.	234-4401 <sup>1</sup>	-	234-4127 <sup>1</sup>	234-4212 <sup>1</sup>
V8-5.4	2000	VIN L & VIN 3; Calif.	234-4046 <sup>1</sup>	-	234-4127 <sup>1</sup>	234-4212 <sup>1</sup>
V8-5.4	2000	VIN L; Exc. Calif.	234-4071 <sup>1</sup>	234-4212 <sup>1</sup>	234-4127 <sup>1</sup>	234-4212 <sup>1</sup>
V8-5.4	2000	VIN Z	234-4046 <sup>1</sup>	-	234-4127 <sup>1</sup>	234-4212 <sup>1</sup>
V8-5.4	1999	Non-Supercharged; Calif.	234-4046 <sup>1</sup>	-	234-4127 <sup>1</sup>	234-4212 <sup>1</sup>
V8-5.4	1999	Non-Supercharged; Exc. Calif.	234-4071 <sup>1</sup>	234-4212 <sup>1</sup>	234-4127 <sup>1</sup>	234-4212 <sup>1</sup>
V8-5.4	1999	Supercharged	234-4046 <sup>1</sup>	-	234-4127 <sup>1</sup>	234-4212 <sup>1</sup>
V8-5.4	1998	CNG Engine	234-4609 <sup>1</sup>	234-4210 <sup>1</sup>	234-4127 <sup>1</sup>	234-4212 <sup>1</sup>
V8-5.4	1998	Gas & Bi-Fuel Engine	234-4071 <sup>1</sup>	234-4212 <sup>1</sup>	234-4127 <sup>1</sup>	234-4212 <sup>1</sup>
V8-5.4	1997		234-4071 <sup>1</sup>	234-4212 <sup>1</sup>	234-4127 <sup>1</sup>	234-4212 <sup>1</sup>
V8-5.8	1996		234-4071 <sup>1</sup>	234-4212 <sup>1</sup>	234-4070	234-4212
V8-5.8	1995-1993	VIN R	234-4127 <sup>1</sup>	234-4212 <sup>1</sup>	-	-
V8-5.8	1995	VIN H; Calif.	234-4001 <sup>1</sup>	234-4212 <sup>1</sup>	-	-
V8-5.8	1995	VIN H; Exc. Calif.	234-4071 <sup>1</sup>	234-4212 <sup>1</sup>	-	-
V8-5.8	1994-1993	VIN H	234-4071 <sup>1</sup>	234-4212 <sup>1</sup>	-	-
V8-5.8	1992-1991	w/ 11" Sensor	234-4071 <sup>1</sup>	234-4212 <sup>1</sup>	-	-
V8-5.8	1992-1990	w/ 18" Sensor	234-4609 <sup>1</sup>	234-4210 <sup>1</sup>	-	-

<sup>1</sup> 2 Required / Requis 2 / Requeridos 2 <sup>4</sup> Left Side / Côté gauche / Lado izquierdo <sup>5</sup> Right Side / Côté droit / Lado derecho



ENGINE MOTEUR MOTOR	YEAR ANNEE AÑO	APPLICATION INFORMATION INFORMATION D'APPLICATION INFORMACION DE APLICACION	UPSTREAM / AVANT - C.C. / ANTES DEL C.C.		DOWNSTREAM / APRS - C.C. / DESPUES DEL C.C.	
			TYPE / TIPO O.E.	UNIVERS.	TYPE / TIPO O.E.	UNIVERS.
<b>FORD [cont]</b>						
<b>F-150 [cont]</b>						
V8-5.8	1989-1988		234-3007	234-3000	-	-
V8-5.8	1985-1980		234-1003	234-1000	-	-
V8-6.2	2014-2011		234-5076 <sup>4</sup>	-	234-4494 <sup>4</sup>	-
V8-6.2	2014-2011		234-5113 <sup>5</sup>	-	234-4494 <sup>5</sup>	-
V8-6.2	2010		234-5108 <sup>4</sup>	-	234-4127 <sup>4</sup>	234-4212 <sup>4</sup>
V8-6.2	2010		234-5113 <sup>5</sup>	-	234-4127 <sup>5</sup>	234-4212 <sup>5</sup>
<b>F-150 HERITAGE</b>						
V6-4.2	2004		234-4046 <sup>1</sup>	-	234-4127 <sup>1</sup>	234-4212 <sup>1</sup>
V8-4.6	2004		234-4046 <sup>1</sup>	-	234-4127 <sup>1</sup>	234-4212 <sup>1</sup>
V8-5.4	2004		234-4401 <sup>1</sup>	-	234-4127 <sup>1</sup>	234-4212 <sup>1</sup>
<b>F-250</b>						
L6-4.9	1996		234-4071 <sup>1</sup>	234-4212 <sup>1</sup>	234-4070	234-4212
L6-4.9	1995	Auto Trans; Trans Code C6	234-4070	234-4212	-	-
L6-4.9	1995	Auto Trans; Trans Code E40D; Calif.	234-4071	234-4212	-	-
L6-4.9	1995	Auto Trans; Trans Code E40D; Exc. Calif.	234-4070	234-4212	-	-
L6-4.9	1995	Manual Trans	234-4070	234-4212	-	-
L6-4.9	1994-1990	w/ 10" Sensor	234-4070	234-4212	-	-
L6-4.9	1990	w/ 15" Sensor	234-4611	234-4210	-	-
L6-4.9	1989-1987	w/ 16" Sensor	234-3007	234-3000	-	-
L6-4.9	1989-1987	w/ 8" Sensor	234-3002	234-3000	-	-
L6-4.9	1986-1984		234-1004	234-1000	-	-
L6-4.9	1983-1980		234-1003	234-1000	-	-
V8-4.6	1999		234-4046 <sup>1</sup>	-	234-4127 <sup>1</sup>	234-4212 <sup>1</sup>
V8-4.6	1998-1997		234-4071 <sup>1</sup>	234-4212 <sup>1</sup>	234-4127 <sup>1</sup>	234-4212 <sup>1</sup>
V8-4.9	1995	Manual Trans	234-4070	234-4212	-	-
V8-5.0	1996		234-4071 <sup>1</sup>	234-4212 <sup>1</sup>	234-4070	234-4212
V8-5.0	1995-1991		234-4071	234-4212	-	-
V8-5.0	1990-1987	3 Lead Sensor; w/ 19" Pigtail	234-3007	234-3000	-	-
V8-5.0	1990	3 Lead Sensor; w/ 11" Pigtail	234-3002	234-3000	-	-
V8-5.0	1990	4 Lead Sensor	234-4609	234-4210	-	-
V8-5.0	1986-1985	w/ 17" Sensor	234-1004	234-1000	-	-
V8-5.0	1985-1980	w/ 7" Sensor	234-1003	234-1000	-	-
V8-5.4	1999-1997	CNG Engine	234-4609 <sup>1</sup>	234-4210 <sup>1</sup>	234-4127 <sup>1</sup>	234-4212 <sup>1</sup>
V8-5.4	1999	Gas & Bi-Fuel Engine; Calif.	234-4046 <sup>1</sup>	-	234-4127 <sup>1</sup>	234-4212 <sup>1</sup>
V8-5.4	1999	Gas & Bi-Fuel Engine; Exc. Calif.	234-4071 <sup>1</sup>	234-4212 <sup>1</sup>	234-4127 <sup>1</sup>	234-4212 <sup>1</sup>
V8-5.4	1998	Gas & Bi-Fuel Engine	234-4071 <sup>1</sup>	234-4212 <sup>1</sup>	234-4127 <sup>1</sup>	234-4212 <sup>1</sup>
V8-5.4	1997	Gas Engine	234-4071 <sup>1</sup>	234-4212 <sup>1</sup>	234-4127 <sup>1</sup>	234-4212 <sup>1</sup>
V8-5.8	1997		234-4071 <sup>1</sup>	234-4212 <sup>1</sup>	234-4070	234-4212
V8-5.8	1996	GVW Over 8,500 Lbs.; Auto Trans; Calif.	234-4071 <sup>1</sup>	234-4212 <sup>1</sup>	234-4070	234-4212
V8-5.8	1996	GVW Over 8,500 Lbs.; Auto Trans; Exc. Calif.	234-4070 <sup>1</sup>	234-4212 <sup>1</sup>	234-4070	234-4212

<sup>1</sup> 2 Required / Requis 2 / Requeridos 2 <sup>4</sup> Left Side / Côté gauche / Lado izquierdo <sup>5</sup> Right Side / Côté droit / Lado derecho



ENGINE MOTEUR MOTOR	YEAR ANNEE AÑO	APPLICATION INFORMATION INFORMATION D'APPLICATION INFORMACION DE APLICACION	UPSTREAM / AVANT - C.C. / ANTES DEL C.C.		DOWNSTREAM / APRES - C.C. / DESPUES DEL C.C.	
			TYPE / TIPO O.E.	UNIVERS.	TYPE / TIPO O.E.	UNIVERS.
<b>FORD [cont]</b>						
<b>F-250 [cont]</b>						
V8-5.8	1996	GVW Over 8,500 Lbs.; Manual Trans	234-4070 <sup>1</sup>	234-4212 <sup>1</sup>	234-4070	234-4212
V8-5.8	1996	GVW Under 8,500 Lbs.	234-4071 <sup>1</sup>	234-4212 <sup>1</sup>	234-4070	234-4212
V8-5.8	1995	Auto Trans; Trans Code C6	234-4070 <sup>1</sup>	234-4212 <sup>1</sup>	-	-
V8-5.8	1995	Auto Trans; Trans Code E40D; Calif.	234-4001 <sup>1</sup>	234-4212 <sup>1</sup>	-	-
V8-5.8	1995	Auto Trans; Trans Code E40D; Exc. Calif.; Over 8,500 Lb. GVW	234-4070 <sup>1</sup>	234-4212 <sup>1</sup>	-	-
V8-5.8	1995	Auto Trans; Trans Code E40D; Exc. Calif.; Under 8,500 Lb. GVW	234-4071 <sup>1</sup>	234-4212 <sup>1</sup>	-	-
V8-5.8	1995	Manual Trans	234-4070 <sup>1</sup>	234-4212 <sup>1</sup>	-	-
V8-5.8	1994-1993	GVW Over 8,500 Lbs.	234-4070	234-4212	-	-
V8-5.8	1994-1993	GVW Under 8,500 Lbs.	234-4071 <sup>1</sup>	234-4212 <sup>1</sup>	-	-
V8-5.8	1992-1991	GVW Over 8,500 Lbs.; OE #F4UZ9F472C	234-4070	234-4212	-	-
V8-5.8	1992-1991	GVW Over 8,500 Lbs.; OE #FOTZ9F472C	234-4611	234-4210	-	-
V8-5.8	1992-1991	GVW Under 8,500 Lbs.; w/ 11" Upstream Sensor	234-4071 <sup>1</sup>	234-4212 <sup>1</sup>	-	-
V8-5.8	1992-1991	GVW Under 8,500 Lbs.; w/ 18" Upstream Sensor	234-4609 <sup>1</sup>	234-4210 <sup>1</sup>	-	-
V8-5.8	1990	GVW Over 8,500 Lbs.	234-4611	234-4210	-	-
V8-5.8	1990	GVW Under 8,500 Lbs.	234-4609 <sup>1</sup>	234-4210 <sup>1</sup>	-	-
V8-5.8	1989-1988		234-3007	234-3000	-	-
V8-5.8	1985-1980		234-1003	234-1000	-	-
V8-7.5	1997-1996	Calif.	234-4127 <sup>4</sup>	234-4212 <sup>4</sup>	234-4070	234-4212
V8-7.5	1997-1996	Calif.; Auto Trans	234-4070 <sup>5</sup>	234-4212 <sup>5</sup>	-	-
V8-7.5	1997-1996	Calif.; Manual Trans	234-4071 <sup>5</sup>	234-4212 <sup>5</sup>	-	-
V8-7.5	1997-1996	Exc. Calif.	234-4127 <sup>1</sup>	234-4212 <sup>1</sup>	234-4127	234-4212
V8-7.5	1995-1994		234-4127 <sup>1</sup>	234-4212 <sup>1</sup>	-	-
V8-7.5	1993		234-4070	234-4212	-	-
V8-7.5	1992-1991	4 Lead Sensor; OE #F4UZ9F472C	234-4070	234-4212	-	-
V8-7.5	1992-1991	4 Lead Sensor; OE #FOTZ8F472C	234-4611	234-4210	-	-
V8-7.5	1992-1988	3 Lead Sensor	234-3007	234-3000	-	-
V8-7.5	1990	4 Lead Sensor	234-4611	234-4210	-	-
<b>F-250 SUPER DUTY</b>						
V8-5.4	2010		234-4106 <sup>1</sup>	-	234-4127 <sup>1</sup>	234-4212 <sup>1</sup>
V8-5.4	2009-2008	Mexico Built	234-4374 <sup>1</sup>	-	234-4127 <sup>1</sup>	234-4212 <sup>1</sup>
V8-5.4	2009-2008	USA Built	234-4106 <sup>1</sup>	-	234-4127 <sup>1</sup>	234-4212 <sup>1</sup>
V8-5.4	2007-2005		234-4374 <sup>1</sup>	-	234-4127 <sup>1</sup>	234-4212 <sup>1</sup>
V8-5.4	2004-2000		234-4045 <sup>1</sup>	-	234-4610 <sup>1</sup>	234-4210 <sup>1</sup>
V8-5.4	1999		234-4127 <sup>1</sup>	234-4212 <sup>1</sup>	234-4071 <sup>1</sup>	234-4212 <sup>1</sup>
V8-6.2	2015-2013		234-5097 <sup>1</sup>	-	234-4576 <sup>1</sup>	-
V8-6.2	2012-2011		234-5097 <sup>1</sup>	-	234-4127 <sup>1</sup>	234-4212 <sup>1</sup>
V10-6.8	2010		234-4106 <sup>1</sup>	-	234-4127 <sup>1</sup>	234-4212 <sup>1</sup>
V10-6.8	2009-2008	Mexico Built	234-4374 <sup>1</sup>	-	234-4127 <sup>1</sup>	234-4212 <sup>1</sup>
V10-6.8	2009-2008	USA Built	234-4106 <sup>1</sup>	-	234-4127 <sup>1</sup>	234-4212 <sup>1</sup>

<sup>1</sup> 2 Required / Requis 2 / Requeridos 2 <sup>4</sup> Left Side / Côté gauche / Lado izquierdo <sup>5</sup> Right Side / Côté droit / Lado derecho





ENGINE MOTEUR MOTOR	YEAR ANNEE AÑO	APPLICATION INFORMATION INFORMATION D'APPLICATION INFORMACION DE APLICACION	UPSTREAM / AVANT - C.C. / ANTES DEL C.C.		DOWNSTREAM / APRS - C.C. / DESPUES DEL C.C.	
			TYPE / TIPO O.E.	UNIVERS.	TYPE / TIPO O.E.	UNIVERS.
<b>FORD [cont]</b>						
<b>F-250 SUPER DUTY [cont]</b>						
V10-6.8	2007-2005		234-4374 <sup>1</sup>	-	234-4127 <sup>1</sup>	234-4212 <sup>1</sup>
V10-6.8	2004-2000		234-4045 <sup>1</sup>	-	234-4610 <sup>1</sup>	234-4210 <sup>1</sup>
V10-6.8	1999		234-4127 <sup>1</sup>	234-4212 <sup>1</sup>	234-4610 <sup>1</sup>	234-4210 <sup>1</sup>
<b>F-350</b>						
L6-4.9	1996		234-4071 <sup>1</sup>	234-4212 <sup>1</sup>	234-4070	234-4212
L6-4.9	1995-1990	w/ 10" Sensor	234-4070	234-4212	-	-
L6-4.9	1990	w/ 15" Sensor	234-4611	234-4210	-	-
L6-4.9	1989-1987	w/ 16" Sensor	234-3007	234-3000	-	-
L6-4.9	1989-1987	w/ 8" Sensor	234-3002	234-3000	-	-
L6-4.9	1986-1984		234-1004	234-1000	-	-
L6-4.9	1983-1980		234-1003	234-1000	-	-
V8-5.0	1980		234-1003	234-1000	-	-
V8-5.8	1997		234-4071 <sup>1</sup>	234-4212 <sup>1</sup>	234-4070	234-4212
V8-5.8	1996	Auto Trans; Calif.	234-4071 <sup>1</sup>	234-4212 <sup>1</sup>	234-4070	234-4212
V8-5.8	1996	Auto Trans; Exc. Calif.	234-4070 <sup>1</sup>	234-4212 <sup>1</sup>	234-4070	234-4212
V8-5.8	1996	Manual Trans	234-4070 <sup>1</sup>	234-4212 <sup>1</sup>	234-4070	234-4212
V8-5.8	1995	Auto Trans; Trans Code C6	234-4070 <sup>1</sup>	234-4212 <sup>1</sup>	-	-
V8-5.8	1995	Auto Trans; Trans Code E40D	234-4001 <sup>1</sup>	234-4212 <sup>1</sup>	-	-
V8-5.8	1995	Manual Trans	234-4070 <sup>1</sup>	234-4212 <sup>1</sup>	-	-
V8-5.8	1994-1993		234-4070	234-4212	-	-
V8-5.8	1992-1991	OE #F4UZ-9F472- C	234-4070	234-4212	-	-
V8-5.8	1992-1991	OE #FOTZ-9F472-C	234-4611	234-4210	-	-
V8-5.8	1990		234-4611	234-4210	-	-
V8-5.8	1989-1988		234-3007	234-3000	-	-
V8-5.8	1985-1980		234-1003	234-1000	-	-
V8-7.5	1997-1996	Calif.	234-4127 <sup>4</sup>	234-4212 <sup>4</sup>	234-4070	234-4212
V8-7.5	1997-1996	Calif.; Auto Trans	234-4070 <sup>5</sup>	234-4212 <sup>5</sup>	-	-
V8-7.5	1997-1996	Calif.; Manual Trans	234-4071 <sup>5</sup>	234-4212 <sup>5</sup>	-	-
V8-7.5	1997-1996	Exc. Calif.	234-4127 <sup>1</sup>	234-4212 <sup>1</sup>	234-4127	234-4212
V8-7.5	1995-1994		234-4127 <sup>1</sup>	234-4212 <sup>1</sup>	-	-
V8-7.5	1993		234-4070	234-4212	-	-
V8-7.5	1992-1991	4 Lead Sensor, OE #F4UZ9F472C	234-4070	234-4212	-	-
V8-7.5	1992-1991	4 Lead Sensor, OE #FOTZ9F472C	234-4611	234-4210	-	-
V8-7.5	1992-1988	3 Lead Sensor	234-3007	234-3000	-	-
V8-7.5	1990	4 Lead Sensor	234-4611	234-4210	-	-
<b>F-350 SUPER DUTY</b>						
V8-5.4	2010		234-4106 <sup>1</sup>	-	234-4127 <sup>1</sup>	234-4212 <sup>1</sup>
V8-5.4	2009-2008	Mexico Built	234-4374 <sup>1</sup>	-	234-4127 <sup>1</sup>	234-4212 <sup>1</sup>
V8-5.4	2009-2008	USA Built	234-4106 <sup>1</sup>	-	234-4127 <sup>1</sup>	234-4212 <sup>1</sup>
V8-5.4	2007-2005		234-4374 <sup>1</sup>	-	234-4127 <sup>1</sup>	234-4212 <sup>1</sup>

<sup>1</sup> 2 Required / Requis 2 / Requeridos 2 <sup>4</sup> Left Side / Côté gauche / Lado izquierdo <sup>5</sup> Right Side / Côté droit / Lado derecho



ENGINE MOTEUR MOTOR	YEAR ANNEE AÑO	APPLICATION INFORMATION INFORMATION D'APPLICATION INFORMACION DE APLICACION	UPSTREAM / AVANT - C.C. / ANTES DEL C.C.		DOWNSTREAM / APRES - C.C. / DESPUES DEL C.C.	
			TYPE / TIPO O.E.	UNIVERS.	TYPE / TIPO O.E.	UNIVERS.
<b>FORD [cont]</b>						
<b>F-350 SUPER DUTY [cont]</b>						
V8-5.4	2004-2000		234-4045 <sup>1</sup>	-	234-4610 <sup>1</sup>	234-4210 <sup>1</sup>
V8-5.4	1999		234-4127 <sup>1</sup>	234-4212 <sup>1</sup>	234-4071 <sup>1</sup>	234-4212 <sup>1</sup>
V8-6.2	2015-2012		234-5097 <sup>1</sup>	-	234-4576 <sup>1</sup>	-
V8-6.2	2011		234-5097 <sup>1</sup>	-	234-4127 <sup>1</sup>	234-4212 <sup>1</sup>
V10-6.8	2010		234-4106 <sup>1</sup>	-	234-4127 <sup>1</sup>	234-4212 <sup>1</sup>
V10-6.8	2009-2008	Mexico Built	234-4374 <sup>1</sup>	-	234-4127 <sup>1</sup>	234-4212 <sup>1</sup>
V10-6.8	2009-2008	USA Built	234-4106 <sup>1</sup>	-	234-4127 <sup>1</sup>	234-4212 <sup>1</sup>
V10-6.8	2007-2005		234-4374 <sup>1</sup>	-	234-4127 <sup>1</sup>	234-4212 <sup>1</sup>
V10-6.8	2004-2000		234-4045 <sup>1</sup>	-	234-4610 <sup>1</sup>	234-4210 <sup>1</sup>
V10-6.8	1999		234-4127 <sup>1</sup>	234-4212 <sup>1</sup>	234-4610 <sup>1</sup>	234-4210 <sup>1</sup>
<b>FAIRMONT</b>						
L4-2.3	1983-1979		234-1003	234-1000	-	-
L6-3.3	1983-1980		234-1003	234-1000	-	-
V8-4.2	1982-1980		234-1003	234-1000	-	-
<b>FESTIVA</b>						
L4-1.3	1993-1990		234-1010	234-1000	-	-
L4-1.3	1989-1988		234-1019	234-1000	-	-
<b>FIESTA</b>						
L3-1.0	2015-2014		234-5076	-	234-4963	-
L4-1.6	2015-2014	Turbo	234-5113	-	234-4962	-
L4-1.6	2015	Non-Turbo	234-4493	-	234-4555	-
L4-1.6	2014	Non-Turbo; 4-Wire Upstream Sensor	234-4493	-	234-4555	-
L4-1.6	2014	Non-Turbo; 5-Wire Upstream Sensor	234-5113	-	234-4555	-
L4-1.6	2013-2011	Manual Trans	234-4493	-	234-4555	-
L4-1.6	2013	Auto Trans; From 12/03/2012	234-4493	-	234-4555	-
L4-1.6	2013	Auto Trans; To 12/03/2012	234-4493	-	234-4493	-
L4-1.6	2012-2011	Auto Trans	234-4493	-	234-4493	-
<b>FIVE HUNDRED</b>						
V6-3.0	2007-2005		234-4045 <sup>4</sup>	-	234-4610 <sup>4</sup>	234-4210 <sup>4</sup>
V6-3.0	2007-2005		234-4046 <sup>5</sup>	-	234-4609 <sup>5</sup>	234-4210 <sup>5</sup>
<b>FLEX</b>						
V6-3.5	2015-2014	Non-Turbo	234-5038 <sup>1</sup>	-	234-4490 <sup>1</sup>	-
V6-3.5	2015-2011	Turbo	234-5113 <sup>4</sup>	-	234-4489 <sup>4</sup>	-
V6-3.5	2015-2011	Turbo	234-5113 <sup>5</sup>	-	234-4491 <sup>5</sup>	-
V6-3.5	2013	Non-Turbo	234-5038 <sup>4</sup>	-	234-4490 <sup>4</sup>	-
V6-3.5	2013	Non-Turbo	234-5038 <sup>5</sup>	-	234-4491 <sup>5</sup>	-
V6-3.5	2012-2011	Non-Turbo	234-5097 <sup>1</sup>	-	234-4489 <sup>1</sup>	-
V6-3.5	2010	Non-Turbo	234-5097 <sup>1</sup>	-	234-4610 <sup>1</sup>	234-4210 <sup>1</sup>
V6-3.5	2010	Turbo	234-5113 <sup>4</sup>	-	234-4610 <sup>4</sup>	234-4210 <sup>4</sup>
V6-3.5	2010	Turbo	234-5113 <sup>5</sup>	-	234-4609 <sup>5</sup>	234-4210 <sup>5</sup>

<sup>1</sup> 2 Required / Requis 2 / Requeridos 2 <sup>4</sup> Left Side / Côté gauche / Lado izquierdo <sup>5</sup> Right Side / Côté droit / Lado derecho



ENGINE MOTEUR MOTOR	YEAR ANNEE AÑO	APPLICATION INFORMATION INFORMATION D'APPLICATION INFORMACION DE APLICACION	UPSTREAM / AVANT - C.C. / ANTES DEL C.C.		DOWNSTREAM / APRS - C.C. / DESPUES DEL C.C.	
			TYPE / TIPO O.E.	UNIVERS.	TYPE / TIPO O.E.	UNIVERS.
<b>FORD [cont]</b>						
<b>FLEX [cont]</b>						
V6-3.5	2009		234-5097 <sup>1</sup>	-	234-4610 <sup>1</sup>	234-4210 <sup>1</sup>
<b>FOCUS</b>						
L4-2.0	2014	VIN 2	234-5113	-	234-4575	-
L4-2.0	2014	VIN 9	234-5097	-	234-4575	-
L4-2.0	2013	Non-Turbo	234-5113	-	234-4575	-
L4-2.0	2013	Turbo	234-5097	-	234-4575	-
L4-2.0	2012		234-5113	-	234-4575	-
L4-2.0	2011-2008		234-4107	-	234-4370	-
L4-2.0	2007		234-4107 <sup>11</sup>	-	234-4371	-
L4-2.0	2007	Loc. Center	-	-	234-4370 <sup>12</sup>	-
L4-2.0	2006	Exc. PZEV	234-4107 <sup>11</sup>	-	234-4371	-
L4-2.0	2006	Exc. PZEV; Loc. Center	-	-	234-4370 <sup>12</sup>	-
L4-2.0	2006	PZEV	234-4375 <sup>11</sup>	-	234-4371	-
L4-2.0	2006	PZEV; Loc. Center	-	-	234-4370 <sup>12</sup>	-
L4-2.0	2005		234-4375 <sup>11</sup>	-	234-4371	-
L4-2.0	2005	Loc. Center	-	-	234-4370 <sup>12</sup>	-
L4-2.0	2004		234-4045	-	234-4609	234-4210
L4-2.0	2003-2001	DOHC	234-4045	-	234-4608	234-4210
L4-2.0	2003-2001	SOHC	234-4045	-	234-4609	234-4210
L4-2.0	2000		234-4045	-	234-4609	234-4210
L4-2.3	2007-2003	Loc. Center	-	-	234-4370 <sup>12</sup>	-
L4-2.3	2007		234-4107 <sup>11</sup>	-	234-4371	-
L4-2.3	2006-2003		234-4375 <sup>11</sup>	-	234-4371	-
<b>FREESTAR</b>						
V6-3.9	2007-2004		234-4401 <sup>1</sup>	-	234-4610 <sup>1</sup>	234-4210 <sup>1</sup>
V6-4.2	2007-2004		234-4401 <sup>1</sup>	-	234-4610 <sup>1</sup>	234-4210 <sup>1</sup>
<b>FREESTYLE</b>						
V6-3.0	2007-2005		234-4045 <sup>4</sup>	-	234-4610 <sup>4</sup>	234-4210 <sup>4</sup>
V6-3.0	2007-2005		234-4046 <sup>5</sup>	-	234-4609 <sup>5</sup>	234-4210 <sup>5</sup>
<b>FUSION</b>						
L4-1.5	2015-2014		234-5172	-	234-4960	-
L4-1.6	2015-2013		234-5113	-	234-4575	-
L4-2.0	2015-2013	Gas Engine	234-5097	-	234-4575	-
L4-2.0	2015-2013	Hybrid Engine	234-5068	-	234-4578	-
L4-2.3	2009-2006		234-4374	-	234-4609	234-4210
L4-2.5	2015-2014		234-5176	-	234-4578	-
L4-2.5	2013		234-5151	-	234-4578	-
L4-2.5	2012-2011	Gas Engine; Auto Trans	234-5039	-	234-4490	-
L4-2.5	2012-2011	Gas Engine; Manual Trans	234-4740	-	234-4490	-
L4-2.5	2012-2011	Hybrid Engine	234-5113	-	234-4490	-

<sup>1</sup> 2 Required / Requis 2 / Requeridos 2 <sup>4</sup> Left Side / Côté gauche / Lado izquierdo <sup>5</sup> Right Side / Côté droit / Lado derecho <sup>11</sup> Loc. Manifold / Empl. collecteur / Ubicación collector <sup>12</sup> Loc. Center / Empl. central / Ubicación central



ENGINE MOTEUR MOTOR	YEAR ANNEE AÑO	APPLICATION INFORMATION INFORMATION D'APPLICATION INFORMACION DE APLICACION	UPSTREAM / AVANT - C.C. / ANTES DEL C.C.		DOWNSTREAM / APRES - C.C. / DESPUES DEL C.C.	
			TYPE / TIPO O.E.	UNIVERS.	TYPE / TIPO O.E.	UNIVERS.
<b>FORD [cont]</b>						
<b>FUSION [cont]</b>						
L4-2.5	2010	Gas Engine; Auto Trans	234-5039	-	234-4609	234-4210
L4-2.5	2010	Gas Engine; Manual Trans	234-4374	-	234-4609	234-4210
L4-2.5	2010	Hybrid Engine	234-5113	-	234-4609	234-4210
V6-3.0	2012-2011		234-5038 <sup>15</sup>	-	234-4490 <sup>15</sup>	-
V6-3.0	2012-2011		234-5038 <sup>16</sup>	-	234-4489 <sup>16</sup>	-
V6-3.0	2010	From 08/03/09	234-5038 <sup>4</sup>	-	234-4609 <sup>4</sup>	234-4210 <sup>4</sup>
V6-3.0	2010	From 08/03/09	234-5038 <sup>5</sup>	-	234-4610 <sup>5</sup>	234-4210 <sup>5</sup>
V6-3.0	2010	To 08/03/09	234-5032 <sup>4</sup>	-	234-4609 <sup>4</sup>	234-4210 <sup>4</sup>
V6-3.0	2010	To 08/03/09	234-5032 <sup>5</sup>	-	234-4610 <sup>5</sup>	234-4210 <sup>5</sup>
V6-3.0	2009-2008		234-4106 <sup>4</sup>	-	234-4610 <sup>4</sup>	234-4210 <sup>4</sup>
V6-3.0	2009-2008	FWD	234-4374 <sup>5</sup>	-	234-4609 <sup>5</sup>	234-4210 <sup>5</sup>
V6-3.0	2009-2007	AWD	234-4106 <sup>5</sup>	-	234-4609 <sup>5</sup>	234-4210 <sup>5</sup>
V6-3.0	2007	AWD	234-4106 <sup>4</sup>	-	234-4610 <sup>4</sup>	234-4210 <sup>4</sup>
V6-3.0	2007	FWD; From 09/04/06	234-4106 <sup>4</sup>	-	234-4610 <sup>4</sup>	234-4210 <sup>4</sup>
V6-3.0	2007	FWD; From 09/04/06	234-4106 <sup>5</sup>	-	234-4609 <sup>5</sup>	234-4210 <sup>5</sup>
V6-3.0	2007	FWD; To 09/04/06	234-4374 <sup>1</sup>	-	234-4610 <sup>1</sup>	234-4210 <sup>1</sup>
V6-3.0	2006		234-4374 <sup>1</sup>	-	234-4610 <sup>1</sup>	234-4210 <sup>1</sup>
V6-3.5	2012-2011		234-5097 <sup>1</sup>	-	234-4489 <sup>1</sup>	-
V6-3.5	2010		234-4372 <sup>1</sup>	-	234-4610 <sup>1</sup>	234-4210 <sup>1</sup>
<b>GRANADA</b>						
L4-2.3	1982-1981		234-1003	234-1000	-	-
L6-3.3	1982-1981		234-1003	234-1000	-	-
V6-3.8	1982		234-1003	234-1000	-	-
V8-4.2	1981-1980		234-1003	234-1000	-	-
V8-5.0	1980		234-1003	234-1000	-	-
<b>GT</b>						
V8-5.4	2006-2005		234-4045 <sup>1</sup>	-	234-4610 <sup>1</sup>	234-4210 <sup>1</sup>
<b>LTD</b>						
L4-2.3	1986-1983		234-1003	234-1000	-	-
L6-3.3	1983		234-1003	234-1000	-	-
V6-3.8	1986-1983		234-1003	234-1000	-	-
V8-4.2	1982-1981		234-1003	234-1000	-	-
V8-5.0	1986		234-3001	234-3000	-	-
V8-5.0	1985-1980		234-1003	234-1000	-	-
V8-5.8	1986-1979		234-1003	234-1000	-	-
<b>LTD CROWN VICTORIA</b>						
V8-5.0	1991-1987		234-3002 <sup>1</sup>	234-3000 <sup>1</sup>	-	-
V8-5.8	1991-1987	3 Lead Sensor	234-3002 <sup>1</sup>	234-3000 <sup>1</sup>	-	-
V8-5.8	1987	1 Lead Sensor	234-1003	234-1000	-	-

<sup>1</sup> 2 Required / Requis 2 / Requeridos 2 <sup>4</sup> Left Side / Côté gauche / Lado izquierdo <sup>5</sup> Right Side / Côté droit / Lado derecho <sup>15</sup> Front / Avant / Parte delantera <sup>16</sup> Rear / Arrière / Parte trasera



ENGINE MOTEUR MOTOR	YEAR ANNEE AÑO	APPLICATION INFORMATION INFORMATION D'APPLICATION INFORMACION DE APLICACION	UPSTREAM / AVANT - C.C. / ANTES DEL C.C.		DOWNSTREAM / APRS - C.C. / DESPUES DEL C.C.	
			TYPE / TIPO O.E.	UNIVERS.	TYPE / TIPO O.E.	UNIVERS.
<b>FORD [cont]</b>						
<b>LTD II</b>						
V8-5.8	1979		234-1003	234-1000	-	-
<b>MUSTANG</b>						
L4-2.3	2015		234-5173	-	234-4961	-
L4-2.3	1993-1991		234-4610	234-4210	-	-
L4-2.3	1990	Calif.	234-4609	234-4210	-	-
L4-2.3	1990	Exc. Calif.	234-3002	234-3000	-	-
L4-2.3	1989-1987		234-3002	234-3000	-	-
L4-2.3	1986-1984	Non-Turbo	234-1003	234-1000	-	-
L4-2.3	1986-1984	Turbo	234-3001	234-3000	-	-
L4-2.3	1983-1979		234-1003	234-1000	-	-
L6-3.3	1982-1980		234-1003	234-1000	-	-
V6-3.7	2015		234-5175 <sup>1</sup>	-	234-4968 <sup>1</sup>	-
V6-3.7	2014-2011		234-5038 <sup>1</sup>	-	234-4490 <sup>1</sup>	-
V6-3.8	2004-2002		234-4046 <sup>1</sup>	-	234-4610 <sup>1</sup>	234-4210 <sup>1</sup>
V6-3.8	2001		234-4046 <sup>4</sup>	-	234-4610 <sup>4</sup>	234-4210 <sup>4</sup>
V6-3.8	2001		234-4046 <sup>5</sup>	-	234-4071 <sup>5</sup>	234-4212 <sup>5</sup>
V6-3.8	2000-1999		234-4046 <sup>1</sup>	-	234-4610 <sup>1</sup>	234-4210 <sup>1</sup>
V6-3.8	1998-1996		234-4610	234-4210	234-4610	234-4210
V6-3.8	1995-1994		234-4001 <sup>1</sup>	234-4212 <sup>1</sup>	234-4127 <sup>1</sup>	234-4212 <sup>1</sup>
V6-3.8	1986-1983		234-1003	234-1000	-	-
V6-3.9	2004		234-4046 <sup>1</sup>	-	234-4610 <sup>1</sup>	234-4210 <sup>1</sup>
V6-4.0	2010-2005		234-4046 <sup>1</sup>	-	234-4610 <sup>1</sup>	234-4210 <sup>1</sup>
V8-4.2	1982-1980		234-1003	234-1000	-	-
V8-4.6	2010-2002		234-4046 <sup>1</sup>	-	234-4610 <sup>1</sup>	234-4210 <sup>1</sup>
V8-4.6	2001-1999	VIN X	234-4046 <sup>1</sup>	-	234-4610 <sup>1</sup>	234-4210 <sup>1</sup>
V8-4.6	2001	VIN V	234-4046 <sup>4</sup>	-	234-4610 <sup>4</sup>	234-4210 <sup>4</sup>
V8-4.6	2001	VIN V	234-4046 <sup>5</sup>	-	234-4071 <sup>5</sup>	234-4212 <sup>5</sup>
V8-4.6	1999	VIN V	234-4046 <sup>4</sup>	-	234-4610 <sup>4</sup>	234-4210 <sup>4</sup>
V8-4.6	1999	VIN V	234-4046 <sup>5</sup>	-	234-4071 <sup>5</sup>	234-4212 <sup>5</sup>
V8-4.6	1998-1996		234-4610 <sup>1</sup>	234-4210 <sup>1</sup>	234-4610 <sup>1</sup>	234-4210 <sup>1</sup>
V8-5.0	2015	Auto Trans	234-5176 <sup>1</sup>	-	234-4967 <sup>1</sup>	-
V8-5.0	2015	Manual Trans	234-5176 <sup>1</sup>	-	234-4966 <sup>1</sup>	-
V8-5.0	2014		234-5113	-	234-4490	-
V8-5.0	2013-2012		234-5113 <sup>1</sup>	-	234-4490 <sup>1</sup>	-
V8-5.0	2011		234-5097 <sup>1</sup>	-	234-4490 <sup>1</sup>	-
V8-5.0	1995		234-4001 <sup>1</sup>	234-4212 <sup>1</sup>	234-4127 <sup>1</sup>	234-4212 <sup>1</sup>
V8-5.0	1994		234-4001 <sup>1</sup>	234-4212 <sup>1</sup>	-	-
V8-5.0	1993-1987		234-3002 <sup>1</sup>	234-3000 <sup>1</sup>	-	-
V8-5.0	1986		234-3001 <sup>1</sup>	234-3000 <sup>1</sup>	-	-

<sup>1</sup> 2 Required / Requis 2 / Requeridos 2 <sup>4</sup> Left Side / Côté gauche / Lado izquierdo <sup>5</sup> Right Side / Côté droit / Lado derecho



ENGINE MOTEUR MOTOR	YEAR ANNEE AÑO	APPLICATION INFORMATION INFORMATION D'APPLICATION INFORMACION DE APLICACION	UPSTREAM / AVANT - C.C. / ANTES DEL C.C.		DOWNSTREAM / APRS - C.C. / DESPUES DEL C.C.	
			TYPE / TIPO O.E.	UNIVERS.	TYPE / TIPO O.E.	UNIVERS.
<b>FORD [cont]</b>						
<b>MUSTANG [cont]</b>						
V8-5.0	1985-1984	VIN F	234-3001	234-3000	-	-
V8-5.0	1985-1984	VIN M	234-1003	234-1000	-	-
V8-5.0	1983-1982		234-1003	234-1000	-	-
V8-5.4	2012-2011		234-5097 <sup>1</sup>	-	234-4490 <sup>1</sup>	-
V8-5.4	2010-2007		234-4046 <sup>1</sup>	-	234-4610 <sup>1</sup>	234-4210 <sup>1</sup>
V8-5.8	2014-2013		234-5097 <sup>1</sup>	-	234-4490 <sup>1</sup>	-
V8-5.8	1995		234-4001 <sup>1</sup>	234-4212 <sup>1</sup>	-	-
<b>PINTO</b>						
L4-2.3	1980-1979		234-1003	234-1000	-	-
<b>POLICE INTERCEPTOR SEDAN</b>						
V6-3.5	2014-2013	Turbo	234-5113 <sup>4</sup>	-	234-4489 <sup>4</sup>	-
V6-3.5	2014-2013	Turbo	234-5113 <sup>5</sup>	-	234-4491 <sup>5</sup>	-
V6-3.5	2014	Non-Turbo	234-5038 <sup>1</sup>	-	234-4490 <sup>1</sup>	-
V6-3.5	2013	Non-Turbo	234-5038 <sup>4</sup>	-	234-4490 <sup>4</sup>	-
V6-3.5	2013	Non-Turbo	234-5038 <sup>5</sup>	-	234-4491 <sup>5</sup>	-
V6-3.7	2014		234-5038 <sup>1</sup>	-	234-4490 <sup>1</sup>	-
V6-3.7	2013		234-5038 <sup>4</sup>	-	234-4490 <sup>4</sup>	-
V6-3.7	2013		234-5038 <sup>5</sup>	-	234-4490 <sup>5</sup>	-
<b>POLICE INTERCEPTOR UTILITY</b>						
V6-3.7	2014		234-5038 <sup>1</sup>	-	234-4490 <sup>1</sup>	-
V6-3.7	2013		234-5038 <sup>4</sup>	-	234-4490 <sup>4</sup>	-
V6-3.7	2013		234-5038 <sup>5</sup>	-	234-4490 <sup>5</sup>	-
<b>PROBE</b>						
L4-2.0	1997-1996	Auto Trans	234-4041	234-4210	234-4067	234-4210
L4-2.0	1997-1996	Manual Trans	234-4067	234-4210	234-4067	234-4210
L4-2.0	1995-1993		234-4068	234-4210	-	-
L4-2.2	1992-1990		234-1020	234-1000	-	-
L4-2.2	1989		234-1019	234-1000	-	-
V6-2.5	1997	Upstream Sensor in Exhaust Pipe	234-4628 <sup>17</sup>	234-4210 <sup>17</sup>	-	-
V6-2.5	1997	Upstream Sensor in Manifold	234-3084 <sup>1</sup>	234-3000 <sup>1</sup>	234-4627	234-4210
V6-2.5	1996	Canada Model	234-4068 <sup>15</sup>	234-4210 <sup>15</sup>	-	-
V6-2.5	1996	Canada Model	234-4067 <sup>16</sup>	234-4210 <sup>16</sup>	-	-
V6-2.5	1996	USA Model	234-3084 <sup>15</sup>	234-3000 <sup>15</sup>	234-4628 <sup>15</sup>	234-4210 <sup>15</sup>
V6-2.5	1996	USA Model	234-3084 <sup>16</sup>	234-3000 <sup>16</sup>	234-4627 <sup>16</sup>	234-4210 <sup>16</sup>
V6-2.5	1995-1994	Calif.	234-3042 <sup>1</sup>	234-3000 <sup>1</sup>	-	-
V6-2.5	1995-1994	Exc. Calif.	234-4068 <sup>15</sup>	234-4210 <sup>15</sup>	-	-
V6-2.5	1995-1994	Exc. Calif.	234-4067 <sup>16</sup>	234-4210 <sup>16</sup>	-	-
V6-2.5	1993		234-4068 <sup>15</sup>	234-4210 <sup>15</sup>	-	-
V6-2.5	1993		234-4067 <sup>16</sup>	234-4210 <sup>16</sup>	-	-

<sup>1</sup> 2 Required / Requis 2 / Requeridos 2 <sup>4</sup> Left Side / Côté gauche / Lado izquierdo <sup>5</sup> Right Side / Côté droit / Lado derecho <sup>15</sup> Front / Avant / Parte delantera <sup>16</sup> Rear / Arrière / Parte trasera <sup>17</sup> Location Exhaust Pipe / Empl. tuyau d'éch / Ubicación tubo de escape



ENGINE MOTEUR MOTOR	YEAR ANNEE AÑO	APPLICATION INFORMATION INFORMATION D'APPLICATION INFORMACION DE APLICACION	UPSTREAM / AVANT - C.C. / ANTES DEL C.C.		DOWNSTREAM / APRS - C.C. / DESPUES DEL C.C.	
			TYPE / TIPO O.E.	UNIVERS.	TYPE / TIPO O.E.	UNIVERS.
<b>FORD [cont]</b>						
<b>PROBE [cont]</b>						
V6-3.0	1992-1990		234-3002	234-3000	-	-
<b>RANCHERO</b>						
V8-5.8	1979		234-1003	234-1000	-	-
<b>RANGER</b>						
L4-2.0	1984-1983		234-1003	234-1000	-	-
L4-2.3	2011-2004	w/ 19" Downstream Sensor	234-4401	-	234-4127	234-4212
L4-2.3	2011-2004	w/ 24" Downstream Sensor	234-4401	-	234-4070	234-4212
L4-2.3	2011-2001	w/ 11" Downstream Sensor	234-4401	-	234-4071	234-4212
L4-2.3	1997-1995		234-4609	234-4210	234-4611	234-4210
L4-2.3	1994	Calif.	234-4610	234-4210	-	-
L4-2.3	1994	Exc. Calif.	234-3002	234-3000	-	-
L4-2.3	1993-1991		234-4610	234-4210	-	-
L4-2.3	1990	Calif.	234-4610	234-4210	-	-
L4-2.3	1990	Exc. Calif.	234-3002	234-3000	-	-
L4-2.3	1989-1987	3 Lead Sensor	234-3002	234-3000	-	-
L4-2.3	1989	4 Lead Sensor	234-4609	234-4210	-	-
L4-2.3	1986-1985		234-3001	234-3000	-	-
L4-2.3	1984-1983		234-1003	234-1000	-	-
L4-2.5	2001-1999		234-4071	234-4212	234-4070	234-4212
L4-2.5	1998		234-4127	234-4212	234-4070	234-4212
V6-2.8	1985-1983		234-1003	234-1000	-	-
V6-2.9	1992-1990	4 Lead Sensor; OE #FOTZ9F472C & F09Z9F472C	234-4611	234-4210	-	-
V6-2.9	1992-1990	4 Lead Sensor; OE #FOUZ9F472C & F4UZ9F472C	234-4070	234-4212	-	-
V6-2.9	1992-1989	3 Lead Sensor; w/ 19" Pigtail	234-3007	234-3000	-	-
V6-2.9	1992-1987	3 Lead Sensor; w/ 11" Pigtail	234-3002	234-3000	-	-
V6-2.9	1986		234-3001	234-3000	-	-
V6-3.0	2008-2007		234-4403 <sup>4</sup>	-	234-4071 <sup>4</sup>	234-4212 <sup>4</sup>
V6-3.0	2008-2007		234-4401 <sup>5</sup>	-	234-4127 <sup>5</sup>	234-4212 <sup>5</sup>
V6-3.0	2006-2004	w/ 11" Downstream Sensor	234-4401 <sup>1</sup>	-	234-4071	234-4212
V6-3.0	2006-2004	w/ 19" Downstream Sensor	234-4401 <sup>1</sup>	-	234-4127	234-4212
V6-3.0	2006-2004	w/ 24" Downstream Sensor	234-4401 <sup>1</sup>	-	234-4070	234-4212
V6-3.0	2003-2001	w/ 10" Downstream Sensor	234-4401 <sup>1</sup>	-	234-4071	234-4212
V6-3.0	2003-2001	w/ 21" Downstream Sensor	234-4401 <sup>1</sup>	-	234-4070	234-4212
V6-3.0	2000-1997		234-4071 <sup>4</sup>	234-4212 <sup>4</sup>	234-4070	234-4212
V6-3.0	2000-1997		234-4127 <sup>5</sup>	234-4212 <sup>5</sup>	-	-
V6-3.0	1996		234-4609 <sup>1</sup>	234-4210 <sup>1</sup>	234-4070	234-4212
V6-3.0	1995		234-4127 <sup>1</sup>	234-4212 <sup>1</sup>	234-4070	234-4212
V6-3.0	1994-1991		234-4070 <sup>1</sup>	234-4212 <sup>1</sup>	-	-
V6-4.0	2011-2007		234-4403 <sup>4</sup>	-	234-4071 <sup>4</sup>	234-4212 <sup>4</sup>
V6-4.0	2011-2007		234-4403 <sup>5</sup>	-	234-4127 <sup>5</sup>	234-4212 <sup>5</sup>

<sup>1</sup> 2 Required / Requis 2 / Requeridos 2 <sup>4</sup> Left Side / Côté gauche / Lado izquierdo <sup>5</sup> Right Side / Côté droit / Lado derecho



ENGINE MOTEUR MOTOR	YEAR ANNEE AÑO	APPLICATION INFORMATION INFORMATION D'APPLICATION INFORMACION DE APLICACION	UPSTREAM / AVANT - C.C. / ANTES DEL C.C.		DOWNSTREAM / APRS - C.C. / DESPUES DEL C.C.	
			TYPE / TIPO O.E.	UNIVERS.	TYPE / TIPO O.E.	UNIVERS.
<b>FORD [cont]</b>						
<b>RANGER [cont]</b>						
V6-4.0	2006-2004	w/ 11" Downstream Sensor	234-4403 <sup>1</sup>	-	234-4071 <sup>1</sup>	234-4212 <sup>1</sup>
V6-4.0	2006-2004	w/ 19" Downstream Sensor	234-4403 <sup>1</sup>	-	234-4127 <sup>1</sup>	234-4212 <sup>1</sup>
V6-4.0	2006-2004	w/ 24" Downstream Sensor	234-4403 <sup>1</sup>	-	234-4070 <sup>1</sup>	234-4212 <sup>1</sup>
V6-4.0	2003-2001	w/ 11" Downstream Sensor	234-4403 <sup>1</sup>	-	234-4071	234-4212
V6-4.0	2003-2001	w/ 22" Downstream Sensor	234-4403 <sup>1</sup>	-	234-4070	234-4212
V6-4.0	2000-1997		234-4071 <sup>4</sup>	234-4212 <sup>4</sup>	234-4070	234-4212
V6-4.0	2000-1997		234-4127 <sup>5</sup>	234-4212 <sup>5</sup>	-	-
V6-4.0	1996		234-4609 <sup>1</sup>	234-4210 <sup>1</sup>	234-4070 <sup>1</sup>	234-4212 <sup>1</sup>
V6-4.0	1995		234-4127 <sup>1</sup>	234-4212 <sup>1</sup>	234-4070 <sup>1</sup>	234-4212 <sup>1</sup>
V6-4.0	1994-1993		234-4070 <sup>1</sup>	234-4212 <sup>1</sup>	-	-
V6-4.0	1992		234-4070	234-4212	-	-
V6-4.0	1991-1990	OE #F4UZ-9F472-C	234-4070	234-4212	-	-
V6-4.0	1991-1990	OE #F09Z-9F472-C	234-4611	234-4210	-	-
V6-4.0	1991-1990	OE #FOTZ-9F472-C	234-4611	234-4210	-	-
V6-4.0	1991-1990	OE #FOUZ-9F472-C	234-4070	234-4212	-	-
<b>TAURUS</b>						
L4-2.0	2014-2013		234-5097	-	234-4575	-
L4-2.5	1991		234-4610	234-4210	-	-
L4-2.5	1990-1989	w/ 8" Sensor	234-3002	234-3000	-	-
L4-2.5	1990-1987	w/ 16" Sensor	234-3007	234-3000	-	-
L4-2.5	1986		234-1004	234-1000	-	-
V6-3.0	2007-2005	w/ 15" Upstream Sensor	234-4045 <sup>1</sup>	-	234-4610 <sup>1</sup>	234-4210 <sup>1</sup>
V6-3.0	2007-2001	w/ 11" Upstream Sensor	234-4046 <sup>1</sup>	-	234-4610 <sup>1</sup>	234-4210 <sup>1</sup>
V6-3.0	2000		234-4045 <sup>1</sup>	-	234-4610 <sup>1</sup>	234-4210 <sup>1</sup>
V6-3.0	1999	Flex Fuel Engine	234-4609 <sup>1</sup>	234-4210 <sup>1</sup>	234-4609 <sup>1</sup>	234-4210 <sup>1</sup>
V6-3.0	1999	Gas Engine; Calif.	234-4045 <sup>1</sup>	-	234-4609 <sup>1</sup>	234-4210 <sup>1</sup>
V6-3.0	1999	Gas Engine; Exc. Calif.	234-4609 <sup>1</sup>	234-4210 <sup>1</sup>	234-4609 <sup>1</sup>	234-4210 <sup>1</sup>
V6-3.0	1998-1996	Flex Fuel Engine	234-4127 <sup>1</sup>	234-4212 <sup>1</sup>	234-4609 <sup>1</sup>	234-4210 <sup>1</sup>
V6-3.0	1998-1996	Gas Engine	234-4609 <sup>1</sup>	234-4210 <sup>1</sup>	234-4609 <sup>1</sup>	234-4210 <sup>1</sup>
V6-3.0	1995-1993	VIN 1	234-4127 <sup>1</sup>	234-4212 <sup>1</sup>	-	-
V6-3.0	1995-1991	VIN Y	234-3002 <sup>1</sup>	234-3000 <sup>1</sup>	-	-
V6-3.0	1995	VIN U	234-4609 <sup>1</sup>	234-4210 <sup>1</sup>	-	-
V6-3.0	1994-1991	VIN U; w/ 11" Sensor	234-4610 <sup>1</sup>	234-4210 <sup>1</sup>	-	-
V6-3.0	1994-1991	VIN U; w/ 15" Sensor	234-4609 <sup>1</sup>	234-4210 <sup>1</sup>	-	-
V6-3.0	1990-1987		234-3002	234-3000	-	-
V6-3.0	1986		234-3001	234-3000	-	-
V6-3.2	1995-1993		234-4610 <sup>1</sup>	234-4210 <sup>1</sup>	-	-
V6-3.5	2015-2014	Non-Turbo	234-5038 <sup>1</sup>	-	234-4490 <sup>1</sup>	-
V6-3.5	2015	Turbo	234-5113 <sup>4</sup>	-	234-4491 <sup>4</sup>	-

<sup>1</sup> 2 Required / Requis 2 / Requeridos 2 <sup>4</sup> Left Side / Côté gauche / Lado izquierdo <sup>5</sup> Right Side / Côté droit / Lado derecho





ENGINE MOTEUR MOTOR	YEAR ANNEE AÑO	APPLICATION INFORMATION INFORMATION D'APPLICATION INFORMACION DE APLICACION	UPSTREAM / AVANT - C.C. / ANTES DEL C.C.		DOWNSTREAM / APRS - C.C. / DESPUES DEL C.C.	
			TYPE / TIPO O.E.	UNIVERS.	TYPE / TIPO O.E.	UNIVERS.
<b>FORD [cont]</b>						
<b>TAURUS [cont]</b>						
V6-3.5	2015	Turbo	234-5113 <sup>5</sup>	-	234-4489 <sup>5</sup>	-
V6-3.5	2014-2011	Turbo	234-5113 <sup>4</sup>	-	234-4489 <sup>4</sup>	-
V6-3.5	2014-2011	Turbo	234-5113 <sup>5</sup>	-	234-4491 <sup>5</sup>	-
V6-3.5	2013	Non-Turbo	234-5038 <sup>4</sup>	-	234-4490 <sup>4</sup>	-
V6-3.5	2013	Non-Turbo	234-5038 <sup>5</sup>	-	234-4491 <sup>5</sup>	-
V6-3.5	2012-2011	Non-Turbo	234-5097 <sup>1</sup>	-	234-4489 <sup>1</sup>	-
V6-3.5	2010	Non-Turbo	234-5097 <sup>1</sup>	-	234-4610 <sup>1</sup>	234-4210 <sup>1</sup>
V6-3.5	2010	Turbo	234-5113 <sup>4</sup>	-	234-4610 <sup>4</sup>	234-4210 <sup>4</sup>
V6-3.5	2010	Turbo	234-5113 <sup>5</sup>	-	234-4609 <sup>5</sup>	234-4210 <sup>5</sup>
V6-3.5	2009-2008	Calif.	234-5097 <sup>1</sup>	-	234-4610 <sup>1</sup>	234-4210 <sup>1</sup>
V6-3.5	2009-2008	Exc. Calif.	234-4372 <sup>1</sup>	-	234-4610 <sup>1</sup>	234-4210 <sup>1</sup>
V6-3.8	1995-1992	w/ 15" Sensor	234-4609 <sup>1</sup>	234-4210 <sup>1</sup>	-	-
V6-3.8	1995-1991	w/ 11" Sensor	234-4610 <sup>1</sup>	234-4210 <sup>1</sup>	-	-
V6-3.8	1990-1988		234-3002 <sup>1</sup>	234-3000 <sup>1</sup>	-	-
V8-3.4	1999-1996		234-4609 <sup>1</sup>	234-4210 <sup>1</sup>	234-4609 <sup>1</sup>	234-4210 <sup>1</sup>
<b>TAURUS X</b>						
V6-3.5	2009-2008	Calif.	234-5097 <sup>1</sup>	-	234-4610 <sup>1</sup>	234-4210 <sup>1</sup>
V6-3.5	2009-2008	Exc. Calif.	234-4372 <sup>1</sup>	-	234-4610 <sup>1</sup>	234-4210 <sup>1</sup>
<b>TEMPO</b>						
L4-2.3	1994-1992		234-4609	234-4210	-	-
L4-2.3	1991-1987		234-3007	234-3000	-	-
L4-2.3	1986-1984		234-1004	234-1000	-	-
V6-3.0	1994-1992		234-4610 <sup>1</sup>	234-4210 <sup>1</sup>	-	-
<b>THUNDERBIRD</b>						
L4-2.3	1988-1987		234-3002	234-3000	-	-
L4-2.3	1986-1985		234-1003	234-1000	-	-
L4-2.3	1984		234-3001	234-3000	-	-
L4-2.3	1983		234-1003	234-1000	-	-
L6-3.3	1982		234-1003	234-1000	-	-
L6-3.3	1980		234-1003	234-1000	-	-
V6-3.8	1997-1996		234-4609	234-4210	234-4610	234-4210
V6-3.8	1995-1994		234-4001 <sup>1</sup>	234-4212 <sup>1</sup>	-	-
V6-3.8	1993-1991		234-4610 <sup>1</sup>	234-4210 <sup>1</sup>	-	-
V6-3.8	1990-1989		234-3002 <sup>1</sup>	234-3000 <sup>1</sup>	-	-
V6-3.8	1988		234-3002	234-3000	-	-
V6-3.8	1987-1982		234-1003	234-1000	-	-
V8-3.9	2005-2002		234-4046 <sup>1</sup>	-	234-4610 <sup>1</sup>	234-4210 <sup>1</sup>
V8-4.2	1982-1980		234-1003	234-1000	-	-
V8-4.6	1997-1996		234-4610	234-4210	234-4610	234-4210
V8-4.6	1995-1994		234-4001 <sup>1</sup>	234-4212 <sup>1</sup>	-	-

<sup>1</sup> 2 Required / Requis 2 / Requeridos 2 <sup>4</sup> Left Side / Côté gauche / Lado izquierdo <sup>5</sup> Right Side / Côté droit / Lado derecho



ENGINE MOTEUR MOTOR	YEAR ANNEE AÑO	APPLICATION INFORMATION INFORMATION D'APPLICATION INFORMACION DE APLICACION	UPSTREAM / AVANT - C.C. / ANTES DEL C.C.		DOWNSTREAM / APRS - C.C. / DESPUES DEL C.C.	
			TYPE / TIPO O.E.	UNIVERS.	TYPE / TIPO O.E.	UNIVERS.
<b>FORD [cont]</b>						
<b>THUNDERBIRD [cont]</b>						
V8-5.0	1993-1991		234-4610 <sup>1</sup>	234-4210 <sup>1</sup>	-	-
V8-5.0	1988-1987		234-3002 <sup>1</sup>	234-3000 <sup>1</sup>	-	-
V8-5.0	1986		234-3001	234-3000	-	-
V8-5.0	1985-1983		234-1003	234-1000	-	-
V8-5.0	1981-1980		234-1003	234-1000	-	-
V8-5.8	1979		234-1003	234-1000	-	-
<b>TRANSIT-150</b>						
V6-3.5	2015		234-5076 <sup>4</sup>	-	234-4965 <sup>4</sup>	-
V6-3.5	2015		234-5097 <sup>5</sup>	-	234-4964 <sup>5</sup>	-
V6-3.7	2015		234-5151 <sup>4</sup>	-	234-4490 <sup>4</sup>	-
V6-3.7	2015		234-5038 <sup>5</sup>	-	234-4489 <sup>5</sup>	-
<b>TRANSIT-250</b>						
V6-3.5	2015		234-5076 <sup>4</sup>	-	234-4965 <sup>4</sup>	-
V6-3.5	2015		234-5097 <sup>5</sup>	-	234-4964 <sup>5</sup>	-
V6-3.7	2015		234-5151 <sup>4</sup>	-	234-4490 <sup>4</sup>	-
V6-3.7	2015		234-5038 <sup>5</sup>	-	234-4489 <sup>5</sup>	-
<b>TRANSIT-350</b>						
V6-3.5	2015		234-5076 <sup>4</sup>	-	234-4965 <sup>4</sup>	-
V6-3.5	2015		234-5097 <sup>5</sup>	-	234-4964 <sup>5</sup>	-
V6-3.7	2015		234-5151 <sup>4</sup>	-	234-4490 <sup>4</sup>	-
V6-3.7	2015		234-5038 <sup>5</sup>	-	234-4489 <sup>5</sup>	-
<b>TRANSIT CONNECT</b>						
L4-1.6	2015-2014		234-5113	-	234-4577	-
L4-2.0	2013-2010		234-4107	-	234-4419	-
L4-2.5	2015-2014		234-5176	-	234-4578	-
<b>WINDSTAR</b>						
V6-3.0	2000-1995		234-4071 <sup>1</sup>	234-4212 <sup>1</sup>	234-4071 <sup>1</sup>	234-4212 <sup>1</sup>
V6-3.8	2003-1999		234-4401 <sup>1</sup>	-	234-4071 <sup>1</sup>	234-4212 <sup>1</sup>
V6-3.8	1998-1995		234-4071 <sup>1</sup>	234-4212 <sup>1</sup>	234-4071 <sup>1</sup>	234-4212 <sup>1</sup>
<b>FREIGHTLINER</b>						
<b>SPRINTER 2500</b>						
L4-2.1	2015-2014		234-5046	-	-	-
L5-2.7	2006-2002		234-5091	-	-	-
V6-3.0	2015-2010		234-5084	-	-	-
V6-3.0	2009-2007		234-5091	-	-	-
V6-3.5	2008-2007		234-5091 <sup>4</sup>	-	234-4073 <sup>4</sup>	-
V6-3.5	2008-2007		234-5096 <sup>5</sup>	-	234-4073 <sup>5</sup>	-
<b>SPRINTER 3500</b>						
L4-2.1	2015-2014		234-5046	-	-	-

<sup>1</sup> 2 Required / Requis 2 / Requeridos 2 <sup>4</sup> Left Side / Côté gauche / Lado izquierdo <sup>5</sup> Right Side / Côté droit / Lado derecho



ENGINE MOTEUR MOTOR	YEAR ANNEE AÑO	APPLICATION INFORMATION INFORMATION D'APPLICATION INFORMACION DE APLICACION	UPSTREAM / AVANT - C.C. / ANTES DEL C.C.		DOWNSTREAM / APRS - C.C. / DESPUES DEL C.C.	
			TYPE / TIPO O.E.	UNIVERS.	TYPE / TIPO O.E.	UNIVERS.
<b>FREIGHTLINER [cont]</b>						
<b>SPRINTER 3500 [cont]</b>						
L5-2.7	2006-2002		234-5091	-	-	-
V6-3.0	2015-2010		234-5084	-	-	-
V6-3.0	2009-2007		234-5091	-	-	-
V6-3.5	2008-2007		234-5091 <sup>4</sup>	-	234-4073 <sup>4</sup>	-
V6-3.5	2008-2007		234-5096 <sup>5</sup>	-	234-4073 <sup>5</sup>	-
<b>GEO</b>						
<b>METRO</b>						
L3-1.0	1997-1996		234-4049	234-4209	234-4648	234-4209
L3-1.0	1995		234-4049	234-4209	-	-
L3-1.0	1994	Calif.	234-4049	234-4209	-	-
L3-1.0	1994	Exc. Calif.	234-1001	234-1000	-	-
L3-1.0	1993-1989		234-1001	234-1000	-	-
L4-1.3	1997-1996		234-4049	234-4209	234-4648	234-4209
L4-1.3	1995		234-4049	234-4209	-	-
L4-1.3	1994-1992		234-1001	234-1000	-	-
<b>PRIZM</b>						
L4-1.6	1997-1996		234-2003	234-2000	234-4061	234-4209
L4-1.6	1995-1993	Calif.	234-1053	234-1057	234-2051	234-2071
L4-1.6	1995-1993	Exc. Calif.	234-2052	234-2050	-	-
L4-1.6	1992-1991	VIN 6	234-2057	234-2050	-	-
L4-1.6	1992-1990	VIN 5; Calif.	234-4059	234-4208	234-2068	234-2000
L4-1.6	1992-1990	VIN 5; Exc. Calif.	234-4508	-	-	-
L4-1.6	1990-1989	VIN 6; From Chassis #LZ090311	234-2057	234-2050	-	-
L4-1.6	1990-1989	VIN 6; To Chassis #LZ090310	234-2062	234-2050	-	-
L4-1.8	1997-1995		234-2003	234-2000	234-4061	234-4209
L4-1.8	1994-1993	Calif.	234-1053	234-1057	234-2051	234-2071
L4-1.8	1994-1993	Exc. Calif.	234-2052	234-2050	-	-
<b>SPECTRUM</b>						
L4-1.5	1989		234-1001	234-1000	-	-
<b>STORM</b>						
L4-1.6	1993-1992		234-1001	234-1000	-	-
L4-1.6	1991-1990	VIN 5	234-3014	234-3000	-	-
L4-1.6	1991-1990	VIN 6	234-1001	234-1000	-	-
L4-1.8	1993-1992		234-4062	234-4209	-	-
<b>TRACKER</b>						
L4-1.6	1997-1996		234-4060	234-4209	234-4649	234-4209
L4-1.6	1995-1993	Calif.	234-4060	234-4209	-	-
L4-1.6	1995	Exc. Calif.	234-3014	234-3000	-	-
L4-1.6	1994-1993	Exc. Calif.	234-3004	234-3000	-	-
L4-1.6	1992-1991		234-3004	234-3000	-	-

<sup>4</sup> Left Side / Côté gauche / Lado izquierdo <sup>5</sup> Right Side / Côté droit / Lado derecho



ENGINE MOTEUR MOTOR	YEAR ANNEE AÑO	APPLICATION INFORMATION INFORMATION D'APPLICATION INFORMACION DE APLICACION	UPSTREAM / AVANT - C.C. / ANTES DEL C.C.		DOWNSTREAM / APRES - C.C. / DESPUES DEL C.C.	
			TYPE / TIPO O.E.	UNIVERS.	TYPE / TIPO O.E.	UNIVERS.
<b>GEO [cont]</b>						
<b>TRACKER [cont]</b>						
L4-1.6	1990-1989		234-1009	234-1000	-	-
<b>GMC</b>						
<b>ACADIA</b>						
V6-3.6	2015-2012		234-4565 <sup>1</sup>	-	234-4566 <sup>1</sup>	-
V6-3.6	2011-2009		234-4815 <sup>1</sup>	-	234-4816 <sup>1</sup>	-
V6-3.6	2008-2007		234-4668 <sup>1</sup>	234-4212 <sup>1</sup>	234-4294 <sup>1</sup>	-
<b>C15/C1500 PICKUP</b>						
L6-4.1	1984-1983		234-1001	234-1000	-	-
V6-4.3	1998		234-4012 <sup>1</sup>	234-4000 <sup>1</sup>	234-4018	234-4000
V6-4.3	1997-1996	Upstream Sensor in Manifold	234-4012 <sup>1</sup>	234-4000 <sup>1</sup>	234-4018	234-4000
V6-4.3	1997-1996	Upstream Sensor in Y Pipe	234-4018	234-4000	-	-
V6-4.3	1995		234-3011 <sup>1</sup>	234-3000 <sup>1</sup>	-	-
V6-4.3	1994		234-3005	234-3000	-	-
V6-4.3	1993-1992	3 Lead Sensor	234-3094	234-3090	-	-
V6-4.3	1993-1988	1 Lead Sensor	234-1001	234-1000	-	-
V6-4.3	1986-1985		234-1001	234-1000	-	-
V8-5.0	1999		234-4012 <sup>1</sup>	234-4000 <sup>1</sup>	234-4018	234-4000
V8-5.0	1998	Auto Trans	234-4012 <sup>1</sup>	234-4000 <sup>1</sup>	234-4018	234-4000
V8-5.0	1998	Manual Trans	234-4019 <sup>1</sup>	234-4000 <sup>1</sup>	234-4018	234-4000
V8-5.0	1997-1996	Auto Trans; Upstream Sensor in Manifold	234-4012 <sup>1</sup>	234-4000 <sup>1</sup>	234-4018	234-4000
V8-5.0	1997-1996	Auto Trans; Upstream Sensor in Y Pipe	234-4018	234-4000	-	-
V8-5.0	1997-1996	Manual Trans; Upstream Sensor in Manifold	234-4019 <sup>1</sup>	234-4000 <sup>1</sup>	234-4018	234-4000
V8-5.0	1997-1996	Manual Trans; Upstream Sensor in Y Pipe	234-4018	234-4000	-	-
V8-5.0	1995-1988	1 Lead Sensor	234-1001	234-1000	-	-
V8-5.0	1995	3 Lead Sensor	234-3011	234-3000	-	-
V8-5.0	1994	3 Lead Sensor	234-3005	234-3000	-	-
V8-5.0	1993-1992	3 Lead Sensor	234-3094	234-3090	-	-
V8-5.0	1986-1983		234-1001	234-1000	-	-
V8-5.7	1999	Trans Code 4L60E	234-4012 <sup>1</sup>	234-4000 <sup>1</sup>	234-4018 <sup>1</sup>	234-4000 <sup>1</sup>
V8-5.7	1999	Trans Code 4L80E	234-4019 <sup>1</sup>	234-4000 <sup>1</sup>	234-4018 <sup>1</sup>	234-4000 <sup>1</sup>
V8-5.7	1998-1996	Auto Trans; Trans Code 4L60E	234-4012 <sup>1</sup>	234-4000 <sup>1</sup>	234-4018 <sup>1</sup>	234-4000 <sup>1</sup>
V8-5.7	1998-1996	Auto Trans; Trans Code 4L80E	234-4019 <sup>1</sup>	234-4000 <sup>1</sup>	234-4018 <sup>1</sup>	234-4000 <sup>1</sup>
V8-5.7	1998-1996	Manual Trans	234-4019 <sup>1</sup>	234-4000 <sup>1</sup>	234-4018 <sup>1</sup>	234-4000 <sup>1</sup>
V8-5.7	1995-1988	1 Lead Sensor	234-1001	234-1000	-	-
V8-5.7	1995	3 Lead Sensor	234-3011	234-3000	-	-
V8-5.7	1994	3 Lead Sensor	234-3005	234-3000	-	-
V8-5.7	1993-1992	3 Lead Sensor	234-3094	234-3090	-	-
V8-5.7	1986-1983		234-1001	234-1000	-	-

<sup>1</sup> 2 Required / Requis 2 / Requeridos 2



ENGINE MOTEUR MOTOR	YEAR ANNEE AÑO	APPLICATION INFORMATION INFORMATION D'APPLICATION INFORMACION DE APLICACION	UPSTREAM / AVANT - C.C. / ANTES DEL C.C.		DOWNSTREAM / APRES - C.C. / DESPUES DEL C.C.	
			TYPE / TIPO O.E.	UNIVERS.	TYPE / TIPO O.E.	UNIVERS.
<b>GMC [cont]</b>						
<b>C15/C1500 SUBURBAN</b>						
V8-5.0	1986-1983		234-1001	234-1000	-	-
V8-5.7	1999-1996	Trans Code 4L60E	234-4012 <sup>1</sup>	234-4000 <sup>1</sup>	234-4018 <sup>1</sup>	234-4000 <sup>1</sup>
V8-5.7	1999-1996	Trans Code 4L80E	234-4019 <sup>1</sup>	234-4000 <sup>1</sup>	234-4018 <sup>1</sup>	234-4000 <sup>1</sup>
V8-5.7	1995-1992	1 Lead Sensor	234-1001	234-1000	-	-
V8-5.7	1995	3 Lead Sensor	234-3011	234-3000	-	-
V8-5.7	1994	3 Lead Sensor	234-3005	234-3000	-	-
V8-5.7	1993-1992	3 Lead Sensor	234-3094	234-3090	-	-
V8-5.7	1986-1983		234-1001	234-1000	-	-
<b>C25/C2500 PICKUP</b>						
L6-4.1	1984-1983		234-1001	234-1000	-	-
L6-4.8	1986-1983		234-1001	234-1000	-	-
V6-4.3	1995		234-3011 <sup>1</sup>	234-3000 <sup>1</sup>	-	-
V6-4.3	1994		234-3005	234-3000	-	-
V6-4.3	1993-1992	3 Lead Sensor	234-3094	234-3090	-	-
V6-4.3	1993-1988	1 Lead Sensor	234-1001	234-1000	-	-
V6-4.3	1986-1985		234-1001	234-1000	-	-
V8-5.0	1998	Auto Trans	234-4012 <sup>1</sup>	234-4000 <sup>1</sup>	234-4018	234-4000
V8-5.0	1998	Manual Trans	234-4019 <sup>1</sup>	234-4000 <sup>1</sup>	234-4018	234-4000
V8-5.0	1997-1996	Auto Trans; Upstream Sensor in Manifold	234-4012 <sup>1</sup>	234-4000 <sup>1</sup>	234-4018	234-4000
V8-5.0	1997-1996	Auto Trans; Upstream Sensor in Y Pipe	234-4018	234-4000	-	-
V8-5.0	1997-1996	Manual Trans; Upstream Sensor in Manifold	234-4019 <sup>1</sup>	234-4000 <sup>1</sup>	234-4018	234-4000
V8-5.0	1997-1996	Manual Trans; Upstream Sensor in Y Pipe	234-4018	234-4000	-	-
V8-5.0	1995-1988	1 Lead Sensor	234-1001	234-1000	-	-
V8-5.0	1995	3 Lead Sensor	234-3011	234-3000	-	-
V8-5.0	1994	3 Lead Sensor	234-3005	234-3000	-	-
V8-5.0	1993-1992	3 Lead Sensor	234-3094	234-3090	-	-
V8-5.0	1986-1983		234-1001	234-1000	-	-
V8-5.7	2000-1999		234-4019 <sup>1</sup>	234-4000 <sup>1</sup>	234-4018 <sup>1</sup>	234-4000 <sup>1</sup>
V8-5.7	1998-1996	Auto Trans; Trans Code 4L60E	234-4012 <sup>1</sup>	234-4000 <sup>1</sup>	234-4018 <sup>1</sup>	234-4000 <sup>1</sup>
V8-5.7	1998-1996	Auto Trans; Trans Code 4L80E	234-4019 <sup>1</sup>	234-4000 <sup>1</sup>	234-4018 <sup>1</sup>	234-4000 <sup>1</sup>
V8-5.7	1998-1996	Manual Trans	234-4019 <sup>1</sup>	234-4000 <sup>1</sup>	234-4018 <sup>1</sup>	234-4000 <sup>1</sup>
V8-5.7	1995-1988	1 Lead Sensor	234-1001	234-1000	-	-
V8-5.7	1995	3 Lead Sensor	234-3011	234-3000	-	-
V8-5.7	1994	3 Lead Sensor	234-3005	234-3000	-	-
V8-5.7	1993-1992	3 Lead Sensor	234-3094	234-3090	-	-
V8-5.7	1986-1983		234-1001	234-1000	-	-
V8-7.4	2000	Calif.	234-4103 <sup>1</sup>	234-4209 <sup>1</sup>	234-4103 <sup>1</sup>	234-4209 <sup>1</sup>
V8-7.4	2000	Exc. Calif.	234-4103 <sup>1</sup>	234-4209 <sup>1</sup>	234-4018 <sup>1</sup>	234-4000 <sup>1</sup>
V8-7.4	1999-1996		234-4019 <sup>1</sup>	234-4000 <sup>1</sup>	234-4018 <sup>1</sup>	234-4000 <sup>1</sup>

<sup>1</sup> 2 Required / Requis 2 / Requeridos 2



ENGINE MOTEUR MOTOR	YEAR ANNEE AÑO	APPLICATION INFORMATION INFORMATION D'APPLICATION INFORMACION DE APLICACION	UPSTREAM / AVANT - C.C. / ANTES DEL C.C.		DOWNSTREAM / APRS - C.C. / DESPUES DEL C.C.	
			TYPE / TIPO O.E.	UNIVERS.	TYPE / TIPO O.E.	UNIVERS.
<b>GMC [cont]</b>						
<b>C25/C2500 PICKUP [cont]</b>						
V8-7.4	1995-1992	1 Lead Sensor	234-1001	234-1000	-	-
V8-7.4	1991		234-1001	234-1000	-	-
V8-7.4	1986-1983		234-1001	234-1000	-	-
<b>C25/C2500 SUBURBAN</b>						
L6-4.8	1984		234-1001	234-1000	-	-
V8-5.0	1986-1983		234-1001	234-1000	-	-
V8-5.7	1999-1997		234-4019 <sup>1</sup>	234-4000 <sup>1</sup>	234-4018 <sup>1</sup>	234-4000 <sup>1</sup>
V8-5.7	1996	Trans Code 4L60E	234-4012 <sup>1</sup>	234-4000 <sup>1</sup>	234-4018 <sup>1</sup>	234-4000 <sup>1</sup>
V8-5.7	1996	Trans Code 4L80E	234-4019 <sup>1</sup>	234-4000 <sup>1</sup>	234-4018 <sup>1</sup>	234-4000 <sup>1</sup>
V8-5.7	1995-1992	1 Lead Sensor	234-1001	234-1000	-	-
V8-5.7	1995	3 Lead Sensor	234-3011	234-3000	-	-
V8-5.7	1994	3 Lead Sensor	234-3005	234-3000	-	-
V8-5.7	1993-1992	3 Lead Sensor	234-3094	234-3090	-	-
V8-5.7	1986-1983		234-1001	234-1000	-	-
V8-7.4	1999-1996		234-4019 <sup>1</sup>	234-4000 <sup>1</sup>	234-4018 <sup>1</sup>	234-4000 <sup>1</sup>
V8-7.4	1995-1992		234-1001	234-1000	-	-
V8-7.4	1986-1983		234-1001	234-1000	-	-
<b>C35/C3500 PICKUP</b>						
L6-4.8	1986-1983		234-1001	234-1000	-	-
V8-5.0	1986		234-1001	234-1000	-	-
V8-5.7	2000-1996		234-4019 <sup>1</sup>	234-4000 <sup>1</sup>	234-4018 <sup>1</sup>	234-4000 <sup>1</sup>
V8-5.7	1995-1988	1 Lead Sensor	234-1001	234-1000	-	-
V8-5.7	1995	3 Lead Sensor	234-3011	234-3000	-	-
V8-5.7	1994	3 Lead Sensor	234-3005	234-3000	-	-
V8-5.7	1993-1992	3 Lead Sensor	234-3094	234-3090	-	-
V8-5.7	1986-1983		234-1001	234-1000	-	-
V8-7.4	2000	Calif.	234-4103 <sup>1</sup>	234-4209 <sup>1</sup>	234-4103 <sup>1</sup>	234-4209 <sup>1</sup>
V8-7.4	2000	Exc. Calif.	234-4103 <sup>1</sup>	234-4209 <sup>1</sup>	234-4018 <sup>1</sup>	234-4000 <sup>1</sup>
V8-7.4	1999-1996		234-4019 <sup>1</sup>	234-4000 <sup>1</sup>	234-4018 <sup>1</sup>	234-4000 <sup>1</sup>
V8-7.4	1995-1988		234-1001	234-1000	-	-
V8-7.4	1986-1983		234-1001	234-1000	-	-
<b>CABALLERO</b>						
V6-3.3	1979	1 Lead Sensor	234-1001	234-1000	-	-
V6-3.3	1979	2 Lead Sensor	234-2001	234-2000	-	-
V6-3.8	1984-1982		234-1001	234-1000	-	-
V6-3.8	1981-1979	1 Lead Sensor	234-1001	234-1000	-	-
V6-3.8	1981-1979	2 Lead Sensor	234-2001	234-2000	-	-
V6-4.3	1987-1986		234-1001	234-1000	-	-
V6-4.3	1985		234-3074	234-3090	-	-
V8-4.4	1982-1979	1 Lead Sensor	234-1001	234-1000	-	-
V8-4.4	1981-1979	2 Lead Sensor	234-2001	234-2000	-	-

<sup>1</sup> 2 Required / Requis 2 / Requeridos 2



ENGINE MOTEUR MOTOR	YEAR ANNEE AÑO	APPLICATION INFORMATION INFORMATION D'APPLICATION INFORMACION DE APLICACION	UPSTREAM / AVANT - C.C. / ANTES DEL C.C.		DOWNSTREAM / APRS - C.C. / DESPUES DEL C.C.	
			TYPE / TIPO O.E.	UNIVERS.	TYPE / TIPO O.E.	UNIVERS.
<b>GMC [cont]</b>						
<b>CABALLERO [cont]</b>						
V8-5.0	1987-1979	1 Lead Sensor	234-1001	234-1000	-	-
V8-5.0	1981-1979	2 Lead Sensor	234-2001	234-2000	-	-
V8-5.7	1979	1 Lead Sensor	234-1001	234-1000	-	-
V8-5.7	1979	2 Lead Sensor	234-2001	234-2000	-	-
<b>CANYON</b>						
L4-2.8	2006		234-4331	-	234-4348	-
L4-2.8	2005-2004		234-4119	-	234-4285	-
L4-2.9	2012-2007		234-4331	-	234-4294	-
L5-3.5	2006		234-4331	-	234-4348	-
L5-3.5	2005-2004		234-4119	-	234-4285	-
L5-3.7	2012-2007		234-4331	-	234-4294	-
V8-5.3	2012-2009		234-4337 <sup>1</sup>	-	234-4243 <sup>1</sup>	-
<b>ENVOY</b>						
L6-4.2	2009-2007		234-4331	-	234-4294	-
L6-4.2	2006		234-4331	-	234-4348	-
L6-4.2	2005-2004		234-4119	-	234-4285	-
L6-4.2	2003-2002		234-4112	234-4209	234-4285	-
V8-5.3	2009-2008		234-4339 <sup>4</sup>	-	234-4246 <sup>4</sup>	-
V8-5.3	2009-2008		234-4339 <sup>5</sup>	-	234-4243 <sup>5</sup>	-
V8-5.3	2007		234-4339 <sup>1</sup>	-	234-4561 <sup>1</sup>	-
V8-5.3	2006	1st Design; Square Downstream Connector	234-4339 <sup>1</sup>	-	234-4285 <sup>1</sup>	-
V8-5.3	2006	2nd Design; Triangular Downstream Connector	234-4339 <sup>1</sup>	-	234-4561 <sup>1</sup>	-
V8-5.3	2005		234-4668 <sup>1</sup>	234-4212 <sup>1</sup>	234-4651 <sup>1</sup>	234-4209 <sup>1</sup>
<b>ENVOY XL</b>						
L6-4.2	2006		234-4331	-	234-4348	-
L6-4.2	2005-2004		234-4119	-	234-4285	-
L6-4.2	2003-2002		234-4112	234-4209	234-4285	-
V8-5.3	2006	1st Design; Downstream OE PN 19209805	234-4339 <sup>1</sup>	-	234-4285 <sup>1</sup>	-
V8-5.3	2006	2nd Design; Downstream OE PN 19209816	234-4339 <sup>1</sup>	-	234-4561 <sup>1</sup>	-
V8-5.3	2005		234-4668 <sup>1</sup>	234-4212 <sup>1</sup>	234-4651 <sup>1</sup>	234-4209 <sup>1</sup>
V8-5.3	2004-2003		234-4650 <sup>1</sup>	234-4209 <sup>1</sup>	234-4647 <sup>1</sup>	234-4209 <sup>1</sup>
<b>ENVOY XUV</b>						
L6-4.2	2005-2004		234-4119	-	234-4285	-
V8-5.3	2005		234-4668 <sup>1</sup>	234-4212 <sup>1</sup>	234-4651 <sup>1</sup>	234-4209 <sup>1</sup>
V8-5.3	2004		234-4650 <sup>1</sup>	234-4209 <sup>1</sup>	234-4647 <sup>1</sup>	234-4209 <sup>1</sup>
<b>G15/G1500 VAN</b>						
L6-4.1	1984-1980		234-1001	234-1000	-	-
V6-4.3	1995		234-3011	234-3000	-	-
V6-4.3	1994		234-3005	234-3000	-	-
V6-4.3	1993-1992	3 Lead Sensor	234-3094	234-3090	-	-

<sup>1</sup> 2 Required / Requis 2 / Requeridos 2 <sup>4</sup> Left Side / Côté gauche / Lado izquierdo <sup>5</sup> Right Side / Côté droit / Lado derecho



ENGINE MOTEUR MOTOR	YEAR ANNEE AÑO	APPLICATION INFORMATION INFORMATION D'APPLICATION INFORMACION DE APLICACION	UPSTREAM / AVANT - C.C. / ANTES DEL C.C.		DOWNSTREAM / APRS - C.C. / DESPUES DEL C.C.	
			TYPE / TIPO O.E.	UNIVERS.	TYPE / TIPO O.E.	UNIVERS.
<b>GMC [cont]</b>						
<b>G15/G1500 VAN [cont]</b>						
V6-4.3	1993-1985	1 Lead Sensor	234-1001	234-1000	-	-
V8-5.0	1995-1980		234-1001	234-1000	-	-
V8-5.7	1993-1980		234-1001	234-1000	-	-
<b>G25/G2500 VAN</b>						
L6-4.1	1984-1980		234-1001	234-1000	-	-
V6-4.3	1995		234-3011	234-3000	-	-
V6-4.3	1994		234-3005	234-3000	-	-
V6-4.3	1993-1992	3 Lead Sensor	234-3094	234-3090	-	-
V6-4.3	1993-1985	1 Lead Sensor	234-1001	234-1000	-	-
V8-5.0	1995-1980		234-1001	234-1000	-	-
V8-5.7	1995-1980		234-1001	234-1000	-	-
<b>G35/G3500 VAN</b>						
L6-4.1	1984-1982		234-1001	234-1000	-	-
V6-4.3	1995		234-3011	234-3000	-	-
V6-4.3	1994		234-3005	234-3000	-	-
V6-4.3	1993-1992	3 Lead Sensor	234-3094	234-3090	-	-
V6-4.3	1993-1985	1 Lead Sensor	234-1001	234-1000	-	-
V8-5.0	1981		234-1001	234-1000	-	-
V8-5.7	1996	GVW Over 8,500 Lbs.	234-4019 <sup>1</sup>	234-4000 <sup>1</sup>	234-4018 <sup>1</sup>	234-4000 <sup>1</sup>
V8-5.7	1996	GVW Under 8,500 Lbs.	234-4012 <sup>1</sup>	234-4000 <sup>1</sup>	234-4018 <sup>1</sup>	234-4000 <sup>1</sup>
V8-5.7	1995-1980		234-1001	234-1000	-	-
V8-7.4	1996		234-4019 <sup>1</sup>	234-4000 <sup>1</sup>	234-4018 <sup>1</sup>	234-4000 <sup>1</sup>
V8-7.4	1995-1988		234-1001	234-1000	-	-
<b>JIMMY</b>						
V6-4.3	2005-2003		234-4343 <sup>1</sup>	-	234-4343	-
V6-4.3	2002		234-4650 <sup>1</sup>	234-4209 <sup>1</sup>	234-4650	234-4209
V6-4.3	2001-1998		234-4012 <sup>1</sup>	234-4000 <sup>1</sup>	234-4012	234-4000
V6-4.3	1997-1996	Upstream Sensor in Manifold	234-4012 <sup>1</sup>	234-4000 <sup>1</sup>	234-4012	234-4000
V6-4.3	1997-1996	Upstream Sensor in Y Pipe	234-4012	234-4000	-	-
V6-4.3	1995-1994	3 Lead Sensor	234-3005	234-3000	-	-
V6-4.3	1995-1994	4 Lead Sensor	234-4012	234-4000	-	-
V6-4.3	1993-1992		234-3094	234-3090	-	-
V8-5.0	1987-1983		234-1001	234-1000	-	-
V8-5.7	1991-1983		234-1001	234-1000	-	-
<b>K15/K1500 SUBURBAN</b>						
V8-5.0	1985-1983		234-1001	234-1000	-	-
V8-5.7	1999-1996	Trans Code 4L60E	234-4012 <sup>1</sup>	234-4000 <sup>1</sup>	234-4018 <sup>1</sup>	234-4000 <sup>1</sup>
V8-5.7	1999-1996	Trans Code 4L80E	234-4019 <sup>1</sup>	234-4000 <sup>1</sup>	234-4018 <sup>1</sup>	234-4000 <sup>1</sup>
V8-5.7	1995-1992	1 Lead Sensor	234-1001	234-1000	-	-
V8-5.7	1995	3 Lead Sensor	234-3011	234-3000	-	-
V8-5.7	1994	3 Lead Sensor	234-3005	234-3000	-	-

<sup>1</sup> 2 Required / Requis 2 / Requeridos 2





ENGINE MOTEUR MOTOR	YEAR ANNEE AÑO	APPLICATION INFORMATION INFORMATION D'APPLICATION INFORMACION DE APLICACION	UPSTREAM / AVANT - C.C. / ANTES DEL C.C.		DOWNSTREAM / APRS - C.C. / DESPUES DEL C.C.	
			TYPE / TIPO O.E.	UNIVERS.	TYPE / TIPO O.E.	UNIVERS.
<b>GMC [cont]</b>						
<b>K15/K1500 SUBURBAN [cont]</b>						
V8-5.7	1993-1992	3 Lead Sensor	234-3094	234-3090	-	-
V8-5.7	1986-1983		234-1001	234-1000	-	-
<b>K15/K1500 TRUCK</b>						
L6-4.1	1984-1983		234-1001	234-1000	-	-
V6-4.3	1998		234-4012 <sup>1</sup>	234-4000 <sup>1</sup>	234-4018	234-4000
V6-4.3	1997-1996	Upstream Sensor in Manifold	234-4012 <sup>1</sup>	234-4000 <sup>1</sup>	234-4018	234-4000
V6-4.3	1997-1996	Upstream Sensor in Y Pipe	234-4018	234-4000	-	-
V6-4.3	1995		234-3011 <sup>1</sup>	234-3000 <sup>1</sup>	-	-
V6-4.3	1994		234-3005	234-3000	-	-
V6-4.3	1993-1992	3 Lead Sensor	234-3094	234-3090	-	-
V6-4.3	1993-1988	1 Lead Sensor	234-1001	234-1000	-	-
V6-4.3	1986-1985		234-1001	234-1000	-	-
V8-5.0	1999		234-4012 <sup>1</sup>	234-4000 <sup>1</sup>	234-4018	234-4000
V8-5.0	1998	Auto Trans	234-4012 <sup>1</sup>	234-4000 <sup>1</sup>	234-4018	234-4000
V8-5.0	1998	Manual Trans	234-4019 <sup>1</sup>	234-4000 <sup>1</sup>	234-4018	234-4000
V8-5.0	1997-1996	Auto Trans; Upstream Sensor in Manifold	234-4012 <sup>1</sup>	234-4000 <sup>1</sup>	234-4018	234-4000
V8-5.0	1997-1996	Auto Trans; Upstream Sensor in Y Pipe	234-4018	234-4000	-	-
V8-5.0	1997-1996	Manual Trans; Upstream Sensor in Manifold	234-4019 <sup>1</sup>	234-4000 <sup>1</sup>	234-4018	234-4000
V8-5.0	1997-1996	Manual Trans; Upstream Sensor in Y Pipe	234-4018	234-4000	-	-
V8-5.0	1995-1988	1 Lead Sensor	234-1001	234-1000	-	-
V8-5.0	1995	3 Lead Sensor	234-3011	234-3000	-	-
V8-5.0	1994	3 Lead Sensor	234-3005	234-3000	-	-
V8-5.0	1993-1992	3 Lead Sensor	234-3094	234-3090	-	-
V8-5.0	1986-1983		234-1001	234-1000	-	-
V8-5.7	1999	Trans Code 4L60E	234-4012 <sup>1</sup>	234-4000 <sup>1</sup>	234-4018 <sup>1</sup>	234-4000 <sup>1</sup>
V8-5.7	1999	Trans Code 4L80E	234-4019 <sup>1</sup>	234-4000 <sup>1</sup>	234-4018 <sup>1</sup>	234-4000 <sup>1</sup>
V8-5.7	1998-1996	Auto Trans; Trans Code 4L60E	234-4012 <sup>1</sup>	234-4000 <sup>1</sup>	234-4018 <sup>1</sup>	234-4000 <sup>1</sup>
V8-5.7	1998-1996	Auto Trans; Trans Code 4L80E	234-4019 <sup>1</sup>	234-4000 <sup>1</sup>	234-4018 <sup>1</sup>	234-4000 <sup>1</sup>
V8-5.7	1998-1996	Manual Trans	234-4019 <sup>1</sup>	234-4000 <sup>1</sup>	234-4018 <sup>1</sup>	234-4000 <sup>1</sup>
V8-5.7	1995-1988	1 Lead Sensor	234-1001	234-1000	-	-
V8-5.7	1995	3 Lead Sensor	234-3011	234-3000	-	-
V8-5.7	1994	3 Lead Sensor	234-3005	234-3000	-	-
V8-5.7	1993-1992	3 Lead Sensor	234-3094	234-3090	-	-
V8-5.7	1986-1983		234-1001	234-1000	-	-
<b>K25/K2500 SUBURBAN</b>						
L6-4.8	1984		234-1001	234-1000	-	-
V8-5.7	1999-1997		234-4019 <sup>1</sup>	234-4000 <sup>1</sup>	234-4018 <sup>1</sup>	234-4000 <sup>1</sup>
V8-5.7	1996	Trans Code 4L60E	234-4012 <sup>1</sup>	234-4000 <sup>1</sup>	234-4018 <sup>1</sup>	234-4000 <sup>1</sup>
V8-5.7	1996	Trans Code 4L80E	234-4019 <sup>1</sup>	234-4000 <sup>1</sup>	234-4018 <sup>1</sup>	234-4000 <sup>1</sup>
V8-5.7	1995-1992	1 Lead Sensor	234-1001	234-1000	-	-

<sup>1</sup> 2 Required / Requis 2 / Requeridos 2



ENGINE MOTEUR MOTOR	YEAR ANNEE AÑO	APPLICATION INFORMATION INFORMATION D'APPLICATION INFORMACION DE APLICACION	UPSTREAM / AVANT - C.C. / ANTES DEL C.C.		DOWNSTREAM / APRES - C.C. / DESPUES DEL C.C.	
			TYPE / TIPO O.E.	UNIVERS.	TYPE / TIPO O.E.	UNIVERS.
<b>GMC [cont]</b>						
<b>K25/K2500 SUBURBAN [cont]</b>						
V8-5.7	1995	3 Lead Sensor	234-3011	234-3000	-	-
V8-5.7	1994	3 Lead Sensor	234-3005	234-3000	-	-
V8-5.7	1993-1992	3 Lead Sensor	234-3094	234-3090	-	-
V8-5.7	1986-1983		234-1001	234-1000	-	-
V8-7.4	1999-1996		234-4019 <sup>1</sup>	234-4000 <sup>1</sup>	234-4018 <sup>1</sup>	234-4000 <sup>1</sup>
V8-7.4	1995-1992		234-1001	234-1000	-	-
<b>K25/K2500 TRUCK</b>						
L6-4.8	1986-1983		234-1001	234-1000	-	-
V6-4.3	1995		234-3011 <sup>1</sup>	234-3000 <sup>1</sup>	-	-
V6-4.3	1994		234-3005	234-3000	-	-
V6-4.3	1993-1992	3 Lead Sensor	234-3094	234-3090	-	-
V6-4.3	1993-1988	1 Lead Sensor	234-1001	234-1000	-	-
V6-4.3	1985		234-1001	234-1000	-	-
V8-5.0	1998	Auto Trans	234-4012 <sup>1</sup>	234-4000 <sup>1</sup>	234-4018	234-4000
V8-5.0	1998	Manual Trans	234-4019 <sup>1</sup>	234-4000 <sup>1</sup>	234-4018	234-4000
V8-5.0	1995-1988	1 Lead Sensor	234-1001	234-1000	-	-
V8-5.0	1995	3 Lead Sensor	234-3011	234-3000	-	-
V8-5.0	1994	3 Lead Sensor	234-3005	234-3000	-	-
V8-5.0	1993-1992	3 Lead Sensor	234-3094	234-3090	-	-
V8-5.7	2000-1999		234-4019 <sup>1</sup>	234-4000 <sup>1</sup>	234-4018 <sup>1</sup>	234-4000 <sup>1</sup>
V8-5.7	1998-1996	Auto Trans; Trans Code 4L60E	234-4012 <sup>1</sup>	234-4000 <sup>1</sup>	234-4018 <sup>1</sup>	234-4000 <sup>1</sup>
V8-5.7	1998-1996	Auto Trans; Trans Code 4L80E	234-4019 <sup>1</sup>	234-4000 <sup>1</sup>	234-4018 <sup>1</sup>	234-4000 <sup>1</sup>
V8-5.7	1998-1996	Manual Trans	234-4019 <sup>1</sup>	234-4000 <sup>1</sup>	234-4018 <sup>1</sup>	234-4000 <sup>1</sup>
V8-5.7	1995-1988	1 Lead Sensor	234-1001	234-1000	-	-
V8-5.7	1995	3 Lead Sensor	234-3011	234-3000	-	-
V8-5.7	1994	3 Lead Sensor	234-3005	234-3000	-	-
V8-5.7	1993-1992	3 Lead Sensor	234-3094	234-3090	-	-
V8-5.7	1986-1983		234-1001	234-1000	-	-
V8-7.4	2000	Calif.	234-4103 <sup>1</sup>	234-4209 <sup>1</sup>	234-4103 <sup>1</sup>	234-4209 <sup>1</sup>
V8-7.4	2000	Exc. Calif.	234-4103 <sup>1</sup>	234-4209 <sup>1</sup>	234-4018 <sup>1</sup>	234-4000 <sup>1</sup>
V8-7.4	1999-1996		234-4019 <sup>1</sup>	234-4000 <sup>1</sup>	234-4018 <sup>1</sup>	234-4000 <sup>1</sup>
V8-7.4	1995-1991		234-1001	234-1000	-	-
<b>K35/K3500 TRUCK</b>						
L6-4.8	1986-1983		234-1001	234-1000	-	-
V8-5.7	2000-1996		234-4019 <sup>1</sup>	234-4000 <sup>1</sup>	234-4018 <sup>1</sup>	234-4000 <sup>1</sup>
V8-5.7	1995-1988	1 Lead Sensor	234-1001	234-1000	-	-
V8-5.7	1995	3 Lead Sensor	234-3011	234-3000	-	-
V8-5.7	1994	3 Lead Sensor	234-3005	234-3000	-	-
V8-5.7	1993-1992	3 Lead Sensor	234-3094	234-3090	-	-
V8-5.7	1986-1983		234-1001	234-1000	-	-

<sup>1</sup> 2 Required / Requis 2 / Requeridos 2



ENGINE MOTEUR MOTOR	YEAR ANNEE AÑO	APPLICATION INFORMATION INFORMATION D'APPLICATION INFORMACION DE APLICACION	UPSTREAM / AVANT - C.C. / ANTES DEL C.C.		DOWNSTREAM / APRS - C.C. / DESPUES DEL C.C.	
			TYPE / TIPO O.E.	UNIVERS.	TYPE / TIPO O.E.	UNIVERS.
<b>GMC [cont]</b>						
<b>K35/K3500 TRUCK [cont]</b>						
V8-7.4	2000	Calif.	234-4103 <sup>1</sup>	234-4209 <sup>1</sup>	234-4103 <sup>1</sup>	234-4209 <sup>1</sup>
V8-7.4	2000	Exc. Calif.	234-4103 <sup>1</sup>	234-4209 <sup>1</sup>	234-4018 <sup>1</sup>	234-4000 <sup>1</sup>
V8-7.4	1999-1996		234-4019 <sup>1</sup>	234-4000 <sup>1</sup>	234-4018 <sup>1</sup>	234-4000 <sup>1</sup>
V8-7.4	1995-1988		234-1001	234-1000	-	-
V8-7.4	1986-1983		234-1001	234-1000	-	-
<b>P25/P2500 VAN</b>						
L6-4.8	1989		234-1001	234-1000	-	-
L6-4.8	1987-1983		234-1001	234-1000	-	-
V8-5.7	1989-1983		234-1001	234-1000	-	-
<b>P35/P3500 VAN</b>						
L6-4.8	1989-1983		234-1001	234-1000	-	-
V6-4.3	1999-1996		234-4019 <sup>1</sup>	234-4000 <sup>1</sup>	234-4018	234-4000
V6-4.3	1995		234-4012	234-4000	-	-
V6-4.3	1994-1992	3 Lead Sensor	234-3094	234-3090	-	-
V6-4.3	1993-1990	1 Lead Sensor	234-1001	234-1000	-	-
V8-5.7	1999-1996		234-4019 <sup>1</sup>	234-4000 <sup>1</sup>	234-4018 <sup>1</sup>	234-4000 <sup>1</sup>
V8-5.7	1995-1983		234-1001	234-1000	-	-
V8-7.4	1999-1996		234-4019 <sup>1</sup>	234-4000 <sup>1</sup>	234-4018 <sup>1</sup>	234-4000 <sup>1</sup>
V8-7.4	1995-1983		234-1001	234-1000	-	-
<b>R1500 SUBURBAN</b>						
V8-5.0	1987		234-1001	234-1000	-	-
V8-5.7	1991-1987		234-1001	234-1000	-	-
<b>R1500 TRUCK</b>						
V6-4.3	1987		234-1001	234-1000	-	-
V8-5.0	1987		234-1001	234-1000	-	-
V8-5.7	1987		234-1001	234-1000	-	-
<b>R2500 SUBURBAN</b>						
V8-5.7	1991-1987		234-1001	234-1000	-	-
V8-7.4	1991-1987		234-1001	234-1000	-	-
<b>R2500 TRUCK</b>						
L6-4.8	1988-1987		234-1001	234-1000	-	-
V6-4.3	1987		234-1001	234-1000	-	-
V8-5.0	1987		234-1001	234-1000	-	-
V8-5.7	1989-1987		234-1001	234-1000	-	-
V8-7.4	1989-1987		234-1001	234-1000	-	-
<b>R3500 TRUCK</b>						
L6-4.8	1988-1987		234-1001	234-1000	-	-
V8-5.7	1991-1987		234-1001	234-1000	-	-
V8-7.4	1991-1987		234-1001	234-1000	-	-

<sup>1</sup> 2 Required / Requis 2 / Requeridos 2



ENGINE MOTEUR MOTOR	YEAR ANNEE AÑO	APPLICATION INFORMATION INFORMATION D'APPLICATION INFORMACION DE APLICACION	UPSTREAM / AVANT - C.C. / ANTES DEL C.C.		DOWNSTREAM / APRES - C.C. / DESPUES DEL C.C.	
			TYPE / TIPO O.E.	UNIVERS.	TYPE / TIPO O.E.	UNIVERS.
<b>GMC [cont]</b>						
<b>S15</b>						
L4-1.9	1985-1982		234-1001	234-1000	-	-
L4-2.0	1984-1983		234-1001	234-1000	-	-
L4-2.5	1990-1985		234-1001	234-1000	-	-
V6-2.8	1990-1982		234-1001	234-1000	-	-
V6-4.3	1990-1988		234-1001	234-1000	-	-
<b>S15 JIMMY</b>						
L4-1.9	1984-1983		234-1001	234-1000	-	-
L4-2.0	1984-1983		234-1001	234-1000	-	-
L4-2.5	1988-1985		234-1001	234-1000	-	-
V6-2.8	1989-1983		234-1001	234-1000	-	-
V6-4.3	1991-1988		234-1001	234-1000	-	-
<b>SAFARI</b>						
L4-2.5	1990-1985		234-1001	234-1000	-	-
V6-4.3	2005-2003		234-4344 <sup>4</sup>	-	234-4345	-
V6-4.3	2005-2003		234-4345 <sup>5</sup>	-	-	-
V6-4.3	2002-2000		234-4647 <sup>4</sup>	234-4209 <sup>4</sup>	234-4650	234-4209
V6-4.3	2002-2000		234-4650 <sup>5</sup>	234-4209 <sup>5</sup>	-	-
V6-4.3	1999-1998		234-4646 <sup>1</sup>	234-4209 <sup>1</sup>	234-4646	234-4209
V6-4.3	1997-1996	Upstream Sensor in Exhaust Pipe	234-4018 <sup>17</sup>	234-4000 <sup>17</sup>	-	-
V6-4.3	1997-1996	Upstream Sensor in Manifold	234-4012 <sup>1</sup>	234-4000 <sup>1</sup>	234-4018	234-4000
V6-4.3	1995		234-3011	234-3000	-	-
V6-4.3	1994		234-3005	234-3000	-	-
V6-4.3	1993-1992		234-3094	234-3090	-	-
V6-4.3	1991-1985		234-1001	234-1000	-	-
<b>SAVANA 1500</b>						
V6-4.3	2014-2008		234-4336 <sup>1</sup>	-	234-4243 <sup>1</sup>	-
V6-4.3	2007		234-4336 <sup>1</sup>	-	234-4561 <sup>1</sup>	-
V6-4.3	2006-2004		234-4285 <sup>5</sup>	-	234-4285 <sup>5</sup>	-
V6-4.3	2006-2003		234-4407 <sup>4</sup>	-	234-4407 <sup>4</sup>	-
V6-4.3	2003	w/ 13" Right Sensors	234-4285 <sup>5</sup>	-	234-4285 <sup>5</sup>	-
V6-4.3	2003	w/ 14.8" Right Sensors	234-4407 <sup>5</sup>	-	234-4407 <sup>5</sup>	-
V6-4.3	2002-1998	GVW Under 8,500 Lbs.	234-4012 <sup>1</sup>	234-4000 <sup>1</sup>	234-4018	234-4000
V6-4.3	2002-1996	GVW Over 8,500 Lbs.	234-4019 <sup>1</sup>	234-4000 <sup>1</sup>	234-4018	234-4000
V6-4.3	1997-1996	GVW Under 8,500 Lbs.; Upstream Sensor in Manifold	234-4012 <sup>1</sup>	234-4000 <sup>1</sup>	234-4018	234-4000
V6-4.3	1997-1996	GVW Under 8,500 Lbs.; Upstream Sensor in Y Pipe	234-4018	234-4000	-	-
V8-5.0	2002-1998		234-4012 <sup>1</sup>	234-4000 <sup>1</sup>	234-4018	234-4000
V8-5.0	1997-1996	Upstream Sensor in Manifold	234-4012 <sup>1</sup>	234-4000 <sup>1</sup>	234-4018	234-4000
V8-5.0	1997-1996	Upstream Sensor in Y Pipe	234-4018	234-4000	-	-
V8-5.3	2014-2008		234-4336 <sup>1</sup>	-	234-4243 <sup>1</sup>	-

<sup>1</sup> 2 Required / Requis 2 / Requeridos 2 <sup>4</sup> Left Side / Côté gauche / Lado izquierdo <sup>5</sup> Right Side / Côté droit / Lado derecho <sup>17</sup> Location Exhaust Pipe / Empl. tuyau d'éch / Ubicación tubo de escape



ENGINE MOTEUR MOTOR	YEAR ANNEE AÑO	APPLICATION INFORMATION INFORMATION D'APPLICATION INFORMACION DE APLICACION	UPSTREAM / AVANT - C.C. / ANTES DEL C.C.		DOWNSTREAM / APRS - C.C. / DESPUES DEL C.C.	
			TYPE / TIPO O.E.	UNIVERS.	TYPE / TIPO O.E.	UNIVERS.
<b>GMC [cont]</b>						
<b>SAVANA 1500 [cont]</b>						
V8-5.3	2007	Calif.	234-4336 <sup>1</sup>	-	234-4561 <sup>1</sup>	-
V8-5.3	2007	Exc. Calif.	234-4407 <sup>4</sup>	-	234-4407 <sup>4</sup>	-
V8-5.3	2007	Exc. Calif.	234-4285 <sup>5</sup>	-	234-4285 <sup>5</sup>	-
V8-5.3	2006-2004		234-4285 <sup>5</sup>	-	234-4285 <sup>5</sup>	-
V8-5.3	2006-2003		234-4407 <sup>4</sup>	-	234-4407 <sup>4</sup>	-
V8-5.3	2003	w/ 13" Right Sensors	234-4285 <sup>5</sup>	-	234-4285 <sup>5</sup>	-
V8-5.3	2003	w/ 14.8" Right Sensors	234-4407 <sup>5</sup>	-	234-4407 <sup>5</sup>	-
V8-5.7	2002-1996	GVW Over 8,500 Lbs.	234-4019 <sup>1</sup>	234-4000 <sup>1</sup>	234-4018 <sup>1</sup>	234-4000 <sup>1</sup>
V8-5.7	2002-1996	GVW Under 8,500 Lbs.	234-4012 <sup>1</sup>	234-4000 <sup>1</sup>	234-4018 <sup>1</sup>	234-4000 <sup>1</sup>
<b>SAVANA 2500</b>						
V6-4.3	2005-2004		234-4285 <sup>5</sup>	-	234-4285 <sup>5</sup>	-
V6-4.3	2005-2003		234-4407 <sup>4</sup>	-	234-4407 <sup>4</sup>	-
V6-4.3	2003	w/ 13" Right Sensors	234-4285 <sup>5</sup>	-	234-4285 <sup>5</sup>	-
V6-4.3	2003	w/ 14.8" Right Sensors	234-4407 <sup>5</sup>	-	234-4407 <sup>5</sup>	-
V6-4.3	2002-1998	GVW Under 8,500 Lbs.	234-4012 <sup>1</sup>	234-4000 <sup>1</sup>	234-4018	234-4000
V6-4.3	2002-1996	GVW Over 8,500 Lbs.	234-4019 <sup>1</sup>	234-4000 <sup>1</sup>	234-4018	234-4000
V6-4.3	1997-1996	GVW Under 8,500 Lbs.; Upstream Sensor in Manifold	234-4012 <sup>1</sup>	234-4000 <sup>1</sup>	234-4018	234-4000
V6-4.3	1997-1996	GVW Under 8,500 Lbs.; Upstream Sensor in Y Pipe	234-4018	234-4000	-	-
V8-4.8	2015-2008		234-4336 <sup>1</sup>	-	234-4243 <sup>1</sup>	-
V8-4.8	2007-2004		234-4285 <sup>5</sup>	-	234-4285 <sup>5</sup>	-
V8-4.8	2007-2003		234-4407 <sup>4</sup>	-	234-4407 <sup>4</sup>	-
V8-4.8	2003	w/ 13" Right Sensors	234-4285 <sup>5</sup>	-	234-4285 <sup>5</sup>	-
V8-4.8	2003	w/ 14.8" Right Sensors	234-4407 <sup>5</sup>	-	234-4407 <sup>5</sup>	-
V8-5.0	2002-1998		234-4012 <sup>1</sup>	234-4000 <sup>1</sup>	234-4018	234-4000
V8-5.0	1997-1996	Upstream Sensor in Manifold	234-4012 <sup>1</sup>	234-4000 <sup>1</sup>	234-4018	234-4000
V8-5.0	1997-1996	Upstream Sensor in Y Pipe	234-4018	234-4000	-	-
V8-5.3	2005-2004		234-4285 <sup>5</sup>	-	234-4285 <sup>5</sup>	-
V8-5.3	2005-2003		234-4407 <sup>4</sup>	-	234-4407 <sup>4</sup>	-
V8-5.3	2003	w/ 13" Right Sensors	234-4285 <sup>5</sup>	-	234-4285 <sup>5</sup>	-
V8-5.3	2003	w/ 14.8" Right Sensors	234-4407 <sup>5</sup>	-	234-4407 <sup>5</sup>	-
V8-5.7	2002-1996	GVW Over 8,500 Lbs.	234-4019 <sup>1</sup>	234-4000 <sup>1</sup>	234-4018 <sup>1</sup>	234-4000 <sup>1</sup>
V8-5.7	2002-1996	GVW Under 8,500 Lbs.	234-4012 <sup>1</sup>	234-4000 <sup>1</sup>	234-4018 <sup>1</sup>	234-4000 <sup>1</sup>
V8-6.0	2015-2013		234-4336 <sup>1</sup>	-	234-4243 <sup>1</sup>	-
V8-6.0	2012-2011		234-4257 <sup>1</sup>	-	234-4243 <sup>1</sup>	-
V8-6.0	2010-2008		234-4336 <sup>1</sup>	-	234-4243 <sup>1</sup>	-
V8-6.0	2007-2004		234-4285 <sup>5</sup>	-	234-4285 <sup>5</sup>	-
V8-6.0	2007-2003		234-4407 <sup>4</sup>	-	234-4407 <sup>4</sup>	-
V8-6.0	2003	w/ 13" Right Sensors	234-4285 <sup>5</sup>	-	234-4285 <sup>5</sup>	-
V8-6.0	2003	w/ 14.8" Right Sensors	234-4407 <sup>5</sup>	-	234-4407 <sup>5</sup>	-

<sup>1</sup> 2 Required / Requis 2 / Requeridos 2 <sup>4</sup> Left Side / Côté gauche / Lado izquierdo <sup>5</sup> Right Side / Côté droit / Lado derecho



ENGINE MOTEUR MOTOR	YEAR ANNEE AÑO	APPLICATION INFORMATION INFORMATION D'APPLICATION INFORMACION DE APLICACION	UPSTREAM / AVANT - C.C. / ANTES DEL C.C.		DOWNSTREAM / APRS - C.C. / DESPUES DEL C.C.	
			TYPE / TIPO O.E.	UNIVERS.	TYPE / TIPO O.E.	UNIVERS.
<b>GMC [cont]</b>						
<b>SAVANA 3500</b>						
V8-4.8	2015-2008		234-4336 <sup>1</sup>	-	234-4243 <sup>1</sup>	-
V8-4.8	2007-2004		234-4285 <sup>5</sup>	-	234-4285 <sup>5</sup>	-
V8-4.8	2007-2003		234-4407 <sup>4</sup>	-	234-4407 <sup>4</sup>	-
V8-4.8	2003	1st Design; OE #25333812	234-4407 <sup>5</sup>	-	234-4407 <sup>5</sup>	-
V8-4.8	2003	2nd Design; OE #12581346	234-4285 <sup>5</sup>	-	234-4285 <sup>5</sup>	-
V8-5.7	2002-1996	GVW Over 8,500 Lbs.	234-4019 <sup>1</sup>	234-4000 <sup>1</sup>	234-4018 <sup>1</sup>	234-4000 <sup>1</sup>
V8-5.7	2002-1996	GVW Under 8,500 Lbs.	234-4012 <sup>1</sup>	234-4000 <sup>1</sup>	234-4018 <sup>1</sup>	234-4000 <sup>1</sup>
V8-6.0	2015-2013		234-4336 <sup>1</sup>	-	234-4243 <sup>1</sup>	-
V8-6.0	2012-2011		234-4257 <sup>1</sup>	-	234-4243 <sup>1</sup>	-
V8-6.0	2010-2008	Cutaway Van	234-4257 <sup>1</sup>	-	234-4243 <sup>1</sup>	-
V8-6.0	2010-2008	Passenger & Cargo Van	234-4336 <sup>1</sup>	-	234-4243 <sup>1</sup>	-
V8-6.0	2007-2004		234-4285 <sup>5</sup>	-	234-4285 <sup>5</sup>	-
V8-6.0	2007-2003		234-4407 <sup>4</sup>	-	234-4407 <sup>4</sup>	-
V8-6.0	2003	w/ 13" Right Sensors	234-4285 <sup>5</sup>	-	234-4285 <sup>5</sup>	-
V8-6.0	2003	w/ 14.8" Right Sensors	234-4407 <sup>5</sup>	-	234-4407 <sup>5</sup>	-
V8-7.4	2000-1996		234-4019 <sup>1</sup>	234-4000 <sup>1</sup>	234-4018 <sup>1</sup>	234-4000 <sup>1</sup>
V8-8.1	2002-2001		234-4103 <sup>1</sup>	234-4209 <sup>1</sup>	234-4103 <sup>1</sup>	234-4209 <sup>1</sup>
<b>SIERRA 1500</b>						
V6-4.3	2015-2014		234-4940 <sup>1</sup>	-	234-4974 <sup>1</sup>	-
V6-4.3	2013-2008		234-4337 <sup>1</sup>	-	234-4258 <sup>1</sup>	-
V6-4.3	2007		234-4337 <sup>1</sup>	-	234-4112 <sup>1</sup>	234-4209 <sup>1</sup>
V6-4.3	2006-2003		234-4407 <sup>1</sup>	-	234-4407 <sup>1</sup>	-
V6-4.3	2002	VIN W	234-4012 <sup>1</sup>	234-4000 <sup>1</sup>	234-4018 <sup>1</sup>	234-4000 <sup>1</sup>
V6-4.3	2002	VIN X	234-4650 <sup>1</sup>	234-4209 <sup>1</sup>	234-4650 <sup>1</sup>	234-4209 <sup>1</sup>
V6-4.3	2001-1999		234-4012 <sup>1</sup>	234-4000 <sup>1</sup>	234-4018 <sup>1</sup>	234-4000 <sup>1</sup>
V8-4.8	2013-2008		234-4668 <sup>1</sup>	234-4212 <sup>1</sup>	234-4256 <sup>1</sup>	-
V8-4.8	2007		234-4337 <sup>1</sup>	-	234-4651 <sup>1</sup>	234-4209 <sup>1</sup>
V8-4.8	2006		234-4337 <sup>1</sup>	-	234-4112 <sup>1</sup>	234-4209 <sup>1</sup>
V8-4.8	2005-2003		234-4407 <sup>1</sup>	-	234-4407 <sup>1</sup>	-
V8-4.8	2002-2000	Canada Built	234-4650 <sup>1</sup>	234-4209 <sup>1</sup>	234-4650 <sup>1</sup>	234-4209 <sup>1</sup>
V8-4.8	2002-2000	Exc. Canada Built	234-4012 <sup>1</sup>	234-4000 <sup>1</sup>	234-4018 <sup>1</sup>	234-4000 <sup>1</sup>
V8-4.8	1999		234-4012 <sup>1</sup>	234-4000 <sup>1</sup>	234-4018 <sup>1</sup>	234-4000 <sup>1</sup>
V8-5.3	2015-2014		234-4940 <sup>1</sup>	-	234-4974 <sup>1</sup>	-
V8-5.3	2013-2008		234-4668 <sup>1</sup>	234-4212 <sup>1</sup>	234-4256 <sup>1</sup>	-
V8-5.3	2007		234-4668 <sup>1</sup>	234-4212 <sup>1</sup>	234-4651 <sup>1</sup>	234-4209 <sup>1</sup>
V8-5.3	2006		234-4337 <sup>1</sup>	-	234-4336 <sup>1</sup>	-
V8-5.3	2005-2003		234-4668 <sup>1</sup>	234-4212 <sup>1</sup>	234-4668 <sup>1</sup>	234-4212 <sup>1</sup>
V8-5.3	2002-2000	Canada Built	234-4650 <sup>1</sup>	234-4209 <sup>1</sup>	234-4650 <sup>1</sup>	234-4209 <sup>1</sup>

<sup>1</sup> 2 Required / Requis 2 / Requeridos 2 <sup>4</sup> Left Side / Côté gauche / Lado izquierdo <sup>5</sup> Right Side / Côté droit / Lado derecho



ENGINE MOTEUR MOTOR	YEAR ANNEE AÑO	APPLICATION INFORMATION INFORMATION D'APPLICATION INFORMACION DE APLICACION	UPSTREAM / AVANT - C.C. / ANTES DEL C.C.		DOWNSTREAM / APRS - C.C. / DESPUES DEL C.C.		
			TYPE / TIPO O.E.	UNIVERS.	TYPE / TIPO O.E.	UNIVERS.	
<b>GMC [cont]</b>							
<b>SIERRA 1500 [cont]</b>							
V8-5.3	2002-2000	Exc. Canada Built	234-4012 <sup>1</sup>	234-4000 <sup>1</sup>	234-4018 <sup>1</sup>	234-4000 <sup>1</sup>	
V8-5.3	1999		234-4012 <sup>1</sup>	234-4000 <sup>1</sup>	234-4018 <sup>1</sup>	234-4000 <sup>1</sup>	
V8-6.0	2013-2008		234-4668 <sup>1</sup>	234-4212 <sup>1</sup>	234-4256 <sup>1</sup>	-	
V8-6.0	2007		234-4668 <sup>1</sup>	234-4212 <sup>1</sup>	234-4651 <sup>1</sup>	234-4209 <sup>1</sup>	
V8-6.0	2006-2005		234-4669 <sup>4</sup>	234-4212 <sup>4</sup>	234-4407 <sup>4</sup>	-	
V8-6.0	2006-2005		234-4669 <sup>5</sup>	234-4212 <sup>5</sup>	234-4407 <sup>5</sup>	-	
V8-6.0	2004-2003		234-4669 <sup>1</sup>	234-4212 <sup>1</sup>	234-4407 <sup>1</sup>	-	
V8-6.0	2002		234-4103 <sup>4</sup>	234-4209 <sup>4</sup>	234-4286 <sup>4</sup>	-	
V8-6.0	2002		234-4103 <sup>5</sup>	234-4209 <sup>5</sup>	234-4407 <sup>5</sup>	-	
V8-6.0	2001		234-4103 <sup>4</sup>	234-4209 <sup>4</sup>	234-4024 <sup>4</sup>	234-4000 <sup>4</sup>	
V8-6.0	2001		234-4103 <sup>5</sup>	234-4209 <sup>5</sup>	234-4018 <sup>5</sup>	234-4000 <sup>5</sup>	
V8-6.2	2015-2014		234-4940 <sup>1</sup>	-	234-4974 <sup>1</sup>	-	
V8-6.2	2013-2008		234-4668 <sup>1</sup>	234-4212 <sup>1</sup>	234-4256 <sup>1</sup>	-	
V8-6.2	2007		234-4668 <sup>1</sup>	234-4212 <sup>1</sup>	234-4651 <sup>1</sup>	234-4209 <sup>1</sup>	
<b>SIERRA 1500 CLASSIC</b>							
V6-4.3	2007			234-4337 <sup>1</sup>	-	234-4112 <sup>1</sup>	234-4209 <sup>1</sup>
V8-4.8	2007		234-4337 <sup>1</sup>	-	234-4112 <sup>1</sup>	234-4209 <sup>1</sup>	
V8-5.3	2007		234-4337 <sup>1</sup>	-	234-4336 <sup>1</sup>	-	
V8-6.0	2007		234-4669 <sup>4</sup>	234-4212 <sup>4</sup>	234-4407 <sup>4</sup>	-	
V8-6.0	2007		234-4669 <sup>5</sup>	234-4212 <sup>5</sup>	234-4407 <sup>5</sup>	-	
<b>SIERRA 1500 HD</b>							
V8-6.0	2006-2005		234-4669 <sup>4</sup>	234-4212 <sup>4</sup>	234-4286 <sup>4</sup>	-	
V8-6.0	2006-2005		234-4669 <sup>5</sup>	234-4212 <sup>5</sup>	234-4407 <sup>5</sup>	-	
V8-6.0	2003		234-4669 <sup>4</sup>	234-4212 <sup>4</sup>	234-4286 <sup>4</sup>	-	
V8-6.0	2003		234-4669 <sup>5</sup>	234-4212 <sup>5</sup>	234-4407 <sup>5</sup>	-	
V8-6.0	2002		234-4103 <sup>4</sup>	234-4209 <sup>4</sup>	234-4286 <sup>4</sup>	-	
V8-6.0	2002		234-4103 <sup>5</sup>	234-4209 <sup>5</sup>	234-4407 <sup>5</sup>	-	
V8-6.0	2001		234-4103 <sup>4</sup>	234-4209 <sup>4</sup>	234-4024 <sup>4</sup>	234-4000 <sup>4</sup>	
V8-6.0	2001		234-4103 <sup>5</sup>	234-4209 <sup>5</sup>	234-4018 <sup>5</sup>	234-4000 <sup>5</sup>	
<b>SIERRA 1500 HD CLASSIC</b>							
V8-6.0	2007		234-4669 <sup>4</sup>	234-4212 <sup>4</sup>	234-4286 <sup>4</sup>	-	
V8-6.0	2007		234-4669 <sup>5</sup>	234-4212 <sup>5</sup>	234-4407 <sup>5</sup>	-	
<b>SIERRA 2500</b>							
V8-5.3	2000	Canada Built	234-4650 <sup>1</sup>	234-4209 <sup>1</sup>	234-4650 <sup>1</sup>	234-4209 <sup>1</sup>	
V8-5.3	2000	Exc. Canada Built	234-4012 <sup>1</sup>	234-4000 <sup>1</sup>	234-4018 <sup>1</sup>	234-4000 <sup>1</sup>	
V8-5.3	1999		234-4012 <sup>1</sup>	234-4000 <sup>1</sup>	234-4018 <sup>1</sup>	234-4000 <sup>1</sup>	
V8-6.0	2004-2003		234-4669 <sup>4</sup>	234-4212 <sup>4</sup>	234-4286 <sup>4</sup>	-	
V8-6.0	2004-2003		234-4669 <sup>5</sup>	234-4212 <sup>5</sup>	234-4407 <sup>5</sup>	-	
V8-6.0	2002		234-4103 <sup>4</sup>	234-4209 <sup>4</sup>	234-4286 <sup>4</sup>	-	

<sup>1</sup> 2 Required / Requis 2 / Requeridos 2 <sup>4</sup> Left Side / Côté gauche / Lado izquierdo <sup>5</sup> Right Side / Côté droit / Lado derecho



ENGINE MOTEUR MOTOR	YEAR ANNEE AÑO	APPLICATION INFORMATION INFORMATION D'APPLICATION INFORMACION DE APLICACION	UPSTREAM / AVANT - C.C. / ANTES DEL C.C.		DOWNSTREAM / APRES - C.C. / DESPUES DEL C.C.	
			TYPE / TIPO O.E.	UNIVERS.	TYPE / TIPO O.E.	UNIVERS.
<b>GMC [cont]</b>						
<b>SIERRA 2500 [cont]</b>						
V8-6.0	2002		234-4103 <sup>5</sup>	234-4209 <sup>5</sup>	234-4407 <sup>5</sup>	-
V8-6.0	2001		234-4103 <sup>4</sup>	234-4209 <sup>4</sup>	234-4024 <sup>4</sup>	234-4000 <sup>4</sup>
V8-6.0	2001		234-4103 <sup>5</sup>	234-4209 <sup>5</sup>	234-4018 <sup>5</sup>	234-4000 <sup>5</sup>
V8-6.0	2000-1999		234-4019 <sup>4</sup>	234-4000 <sup>4</sup>	234-4024 <sup>4</sup>	234-4000 <sup>4</sup>
V8-6.0	2000-1999		234-4019 <sup>5</sup>	234-4000 <sup>5</sup>	234-4018 <sup>5</sup>	234-4000 <sup>5</sup>
<b>SIERRA 2500 HD</b>						
V8-6.0	2015-2013		234-4563 <sup>1</sup>	-	234-4256 <sup>1</sup>	-
V8-6.0	2012-2011	Cab & Chassis	234-4669 <sup>1</sup>	234-4212 <sup>1</sup>	234-4256 <sup>1</sup>	-
V8-6.0	2012	Pickup	234-4563 <sup>1</sup>	-	234-4256 <sup>1</sup>	-
V8-6.0	2011-2008	Pickup	234-4668 <sup>1</sup>	234-4212 <sup>1</sup>	234-4256 <sup>1</sup>	-
V8-6.0	2010-2008	Cab & Chassis	234-4669 <sup>4</sup>	234-4212 <sup>4</sup>	234-4252 <sup>4</sup>	-
V8-6.0	2010-2008	Cab & Chassis	234-4669 <sup>5</sup>	234-4212 <sup>5</sup>	234-4256 <sup>5</sup>	-
V8-6.0	2007	VIN K; Cab & Chassis	234-4669 <sup>4</sup>	234-4212 <sup>4</sup>	234-4286 <sup>4</sup>	-
V8-6.0	2007	VIN K; Cab & Chassis	234-4669 <sup>5</sup>	234-4212 <sup>5</sup>	234-4407 <sup>5</sup>	-
V8-6.0	2007	VIN K; Pickup	234-4668 <sup>1</sup>	234-4212 <sup>1</sup>	234-4651 <sup>1</sup>	234-4209 <sup>1</sup>
V8-6.0	2006-2003		234-4669 <sup>4</sup>	234-4212 <sup>4</sup>	234-4286 <sup>4</sup>	-
V8-6.0	2006-2003		234-4669 <sup>5</sup>	234-4212 <sup>5</sup>	234-4407 <sup>5</sup>	-
V8-6.0	2002		234-4103 <sup>4</sup>	234-4209 <sup>4</sup>	234-4286 <sup>4</sup>	-
V8-6.0	2002		234-4103 <sup>5</sup>	234-4209 <sup>5</sup>	234-4407 <sup>5</sup>	-
V8-6.0	2001		234-4103 <sup>4</sup>	234-4209 <sup>4</sup>	234-4024 <sup>4</sup>	234-4000 <sup>4</sup>
V8-6.0	2001		234-4103 <sup>5</sup>	234-4209 <sup>5</sup>	234-4018 <sup>5</sup>	234-4000 <sup>5</sup>
V8-8.1	2006-2003		234-4669 <sup>4</sup>	234-4212 <sup>4</sup>	234-4673 <sup>4</sup>	234-4212 <sup>4</sup>
V8-8.1	2006-2003		234-4669 <sup>5</sup>	234-4212 <sup>5</sup>	234-4669 <sup>5</sup>	234-4212 <sup>5</sup>
V8-8.1	2002-2001		234-4103 <sup>4</sup>	234-4209 <sup>4</sup>	234-4102 <sup>4</sup>	234-4209 <sup>4</sup>
V8-8.1	2002-2001		234-4103 <sup>5</sup>	234-4209 <sup>5</sup>	234-4103 <sup>5</sup>	234-4209 <sup>5</sup>
<b>SIERRA 2500 HD CLASSIC</b>						
V8-6.0	2007		234-4669 <sup>4</sup>	234-4212 <sup>4</sup>	234-4286 <sup>4</sup>	-
V8-6.0	2007		234-4669 <sup>5</sup>	234-4212 <sup>5</sup>	234-4407 <sup>5</sup>	-
V8-8.1	2007		234-4669 <sup>4</sup>	234-4212 <sup>4</sup>	234-4673 <sup>4</sup>	234-4212 <sup>4</sup>
V8-8.1	2007		234-4669 <sup>5</sup>	234-4212 <sup>5</sup>	234-4669 <sup>5</sup>	234-4212 <sup>5</sup>
<b>SIERRA 3500</b>						
V8-6.0	2006-2003		234-4669 <sup>4</sup>	234-4212 <sup>4</sup>	234-4286 <sup>4</sup>	-
V8-6.0	2006-2003		234-4669 <sup>5</sup>	234-4212 <sup>5</sup>	234-4407 <sup>5</sup>	-
V8-6.0	2002		234-4103 <sup>4</sup>	234-4209 <sup>4</sup>	234-4286 <sup>4</sup>	-
V8-6.0	2002		234-4103 <sup>5</sup>	234-4209 <sup>5</sup>	234-4407 <sup>5</sup>	-
V8-6.0	2001		234-4103 <sup>4</sup>	234-4209 <sup>4</sup>	234-4024 <sup>4</sup>	234-4000 <sup>4</sup>
V8-6.0	2001		234-4103 <sup>5</sup>	234-4209 <sup>5</sup>	234-4018 <sup>5</sup>	234-4000 <sup>5</sup>
V8-8.1	2006-2003		234-4669 <sup>4</sup>	234-4212 <sup>4</sup>	234-4673 <sup>4</sup>	234-4212 <sup>4</sup>
V8-8.1	2006-2003		234-4669 <sup>5</sup>	234-4212 <sup>5</sup>	234-4669 <sup>5</sup>	234-4212 <sup>5</sup>

<sup>1</sup> 2 Required / Requis 2 / Requeridos 2 <sup>4</sup> Left Side / Côté gauche / Lado izquierdo <sup>5</sup> Right Side / Côté droit / Lado derecho





ENGINE MOTEUR MOTOR	YEAR ANNEE AÑO	APPLICATION INFORMATION INFORMATION D'APPLICATION INFORMACION DE APLICACION	UPSTREAM / AVANT - C.C. / ANTES DEL C.C.		DOWNSTREAM / APRS - C.C. / DESPUES DEL C.C.	
			TYPE / TIPO O.E.	UNIVERS.	TYPE / TIPO O.E.	UNIVERS.
<b>GMC [cont]</b>						
<b>SIERRA 3500 [cont]</b>						
V8-8.1	2002-2001		234-4103 <sup>4</sup>	234-4209 <sup>4</sup>	234-4102 <sup>4</sup>	234-4209 <sup>4</sup>
V8-8.1	2002-2001		234-4103 <sup>5</sup>	234-4209 <sup>5</sup>	234-4103 <sup>5</sup>	234-4209 <sup>5</sup>
<b>SIERRA 3500 CLASSIC</b>						
V8-6.0	2007		234-4669 <sup>4</sup>	234-4212 <sup>4</sup>	234-4286 <sup>4</sup>	-
V8-6.0	2007		234-4669 <sup>5</sup>	234-4212 <sup>5</sup>	234-4407 <sup>5</sup>	-
V8-8.1	2007		234-4669 <sup>4</sup>	234-4212 <sup>4</sup>	234-4673 <sup>4</sup>	234-4212 <sup>4</sup>
V8-8.1	2007		234-4669 <sup>5</sup>	234-4212 <sup>5</sup>	234-4669 <sup>5</sup>	234-4212 <sup>5</sup>
<b>SIERRA 3500 HD</b>						
V8-6.0	2015		234-4563 <sup>1</sup>	-	234-4256 <sup>1</sup>	-
V8-6.0	2014-2012	Pickup	234-4563 <sup>1</sup>	-	234-4256 <sup>1</sup>	-
V8-6.0	2014-2011	Cab & Chassis	234-4669 <sup>1</sup>	234-4212 <sup>1</sup>	234-4256 <sup>1</sup>	-
V8-6.0	2011-2008	Pickup	234-4668 <sup>1</sup>	234-4212 <sup>1</sup>	234-4256 <sup>1</sup>	-
V8-6.0	2010-2008	Cab & Chassis	234-4669 <sup>4</sup>	234-4212 <sup>4</sup>	234-4252 <sup>4</sup>	-
V8-6.0	2010-2008	Cab & Chassis	234-4669 <sup>5</sup>	234-4212 <sup>5</sup>	234-4256 <sup>5</sup>	-
V8-6.0	2007	Cab & Chassis	234-4669 <sup>4</sup>	234-4212 <sup>4</sup>	234-4286 <sup>4</sup>	-
V8-6.0	2007	Cab & Chassis	234-4669 <sup>5</sup>	234-4212 <sup>5</sup>	234-4407 <sup>5</sup>	-
V8-6.0	2007	Pickup	234-4668 <sup>1</sup>	234-4212 <sup>1</sup>	234-4651 <sup>1</sup>	234-4209 <sup>1</sup>
<b>SONOMA</b>						
L4-2.2	2003-2001		234-2060	234-2000	234-4087	234-4000
L4-2.2	2000	Flex Fuel Engine	234-2060	234-2000	234-4087	234-4000
L4-2.2	2000	Gas Engine	234-1023	234-1000	234-4087	234-4000
L4-2.2	1999		234-1023	234-1000	234-4087	234-4000
L4-2.2	1998-1997		234-1001	234-1000	234-4087	234-4000
L4-2.2	1996		234-1001	234-1000	234-4012	234-4000
L4-2.2	1995-1994		234-1001	234-1000	-	-
L4-2.5	1993-1991		234-1001	234-1000	-	-
V6-2.8	1993-1991		234-1001	234-1000	-	-
V6-4.3	2004-2003		234-4343 <sup>1</sup>	-	234-4343 <sup>1</sup>	-
V6-4.3	2002		234-4650 <sup>1</sup>	234-4209 <sup>1</sup>	234-4650 <sup>1</sup>	234-4209 <sup>1</sup>
V6-4.3	2001-1998		234-4012 <sup>1</sup>	234-4000 <sup>1</sup>	234-4012	234-4000
V6-4.3	1997-1996	Upstream Sensor in Manifold	234-4012 <sup>1</sup>	234-4000 <sup>1</sup>	234-4012	234-4000
V6-4.3	1997-1996	Upstream Sensor in Y Pipe	234-4012	234-4000	-	-
V6-4.3	1995-1994	3 Lead Sensor	234-3005	234-3000	-	-
V6-4.3	1995-1994	4 Lead Sensor	234-4012	234-4000	-	-
V6-4.3	1993-1992		234-3094	234-3090	-	-
V6-4.3	1991		234-1001	234-1000	-	-
<b>SYCLONE</b>						
V6-4.3	1991		234-3094	234-3090	-	-
<b>TERRAIN</b>						
L4-2.4	2015-2011		234-4242	-	234-4530	-

<sup>1</sup> 2 Required / Requis 2 / Requeridos 2 <sup>4</sup> Left Side / Côté gauche / Lado izquierdo <sup>5</sup> Right Side / Côté droit / Lado derecho



ENGINE MOTEUR MOTOR	YEAR ANNEE AÑO	APPLICATION INFORMATION INFORMATION D'APPLICATION INFORMACION DE APLICACION	UPSTREAM / AVANT - C.C. / ANTES DEL C.C.		DOWNSTREAM / APRS - C.C. / DESPUES DEL C.C.	
			TYPE / TIPO O.E.	UNIVERS.	TYPE / TIPO O.E.	UNIVERS.
<b>GMC [cont]</b>						
<b>TERRAIN [cont]</b>						
L4-2.4	2010		234-4242	-	234-4251	-
V6-3.0	2012		234-4564 <sup>1</sup>	-	234-4564 <sup>1</sup>	-
V6-3.0	2011-2010		234-4815 <sup>1</sup>	-	234-4815 <sup>1</sup>	-
V6-3.6	2015-2013		234-4564 <sup>1</sup>	-	234-4564 <sup>1</sup>	-
<b>TRACKER</b>						
L4-1.6	1991		234-3004	234-3000	-	-
L4-1.6	1990-1989		234-1009	234-1000	-	-
<b>TYPHOON</b>						
V6-4.3	1993-1992		234-3094	234-3090	-	-
<b>V1500 SUBURBAN</b>						
V8-5.7	1991-1987		234-1001	234-1000	-	-
<b>V1500 TRUCK</b>						
V6-4.3	1987		234-1001	234-1000	-	-
V8-5.0	1987		234-1001	234-1000	-	-
V8-5.7	1987		234-1001	234-1000	-	-
<b>V2500 SUBURBAN</b>						
V8-5.7	1991-1987		234-1001	234-1000	-	-
<b>V2500 TRUCK</b>						
L6-4.8	1987		234-1001	234-1000	-	-
V8-5.7	1987		234-1001	234-1000	-	-
<b>V3500 TRUCK</b>						
L6-4.8	1988-1987		234-1001	234-1000	-	-
V8-5.7	1991-1987		234-1001	234-1000	-	-
V8-7.4	1991-1987		234-1001	234-1000	-	-
<b>YUKON</b>						
V8-4.8	2009-2008		234-4668 <sup>1</sup>	234-4212 <sup>1</sup>	234-4256 <sup>1</sup>	-
V8-4.8	2007-2006		234-4337 <sup>1</sup>	-	234-4112 <sup>1</sup>	234-4209 <sup>1</sup>
V8-4.8	2005-2003		234-4407 <sup>1</sup>	-	234-4407 <sup>1</sup>	-
V8-4.8	2002-2000	Canada Built	234-4650 <sup>1</sup>	234-4209 <sup>1</sup>	234-4650 <sup>1</sup>	234-4209 <sup>1</sup>
V8-4.8	2002-2000	Exc. Canada Built	234-4012 <sup>1</sup>	234-4000 <sup>1</sup>	234-4018 <sup>1</sup>	234-4000 <sup>1</sup>
V8-5.3	2015		234-4940 <sup>1</sup>	-	234-4974 <sup>1</sup>	-
V8-5.3	2014-2008		234-4668 <sup>1</sup>	234-4212 <sup>1</sup>	234-4256 <sup>1</sup>	-
V8-5.3	2007		234-4337 <sup>1</sup>	-	234-4112 <sup>1</sup>	234-4209 <sup>1</sup>
V8-5.3	2006		234-4337 <sup>1</sup>	-	234-4336 <sup>1</sup>	-
V8-5.3	2005-2003		234-4668 <sup>1</sup>	234-4212 <sup>1</sup>	234-4668 <sup>1</sup>	234-4212 <sup>1</sup>
V8-5.3	2002-2000	Canada Built	234-4650 <sup>1</sup>	234-4209 <sup>1</sup>	234-4650 <sup>1</sup>	234-4209 <sup>1</sup>
V8-5.3	2002-2000	Exc. Canada Built	234-4012 <sup>1</sup>	234-4000 <sup>1</sup>	234-4018 <sup>1</sup>	234-4000 <sup>1</sup>
V8-5.7	2000-1999		234-4012 <sup>1</sup>	234-4000 <sup>1</sup>	234-4018 <sup>1</sup>	234-4000 <sup>1</sup>
V8-5.7	1998-1997	Trans Code 4L60E	234-4012 <sup>1</sup>	234-4000 <sup>1</sup>	234-4018 <sup>1</sup>	234-4000 <sup>1</sup>
V8-5.7	1998-1997	Trans Code 4L80E	234-4019 <sup>1</sup>	234-4000 <sup>1</sup>	234-4018 <sup>1</sup>	234-4000 <sup>1</sup>

<sup>1</sup> 2 Required / Requis 2 / Requeridos 2



ENGINE MOTEUR MOTOR	YEAR ANNEE AÑO	APPLICATION INFORMATION INFORMATION D'APPLICATION INFORMACION DE APLICACION	UPSTREAM / AVANT - C.C. / ANTES DEL C.C.		DOWNSTREAM / APRES - C.C. / DESPUES DEL C.C.	
			TYPE / TIPO O.E.	UNIVERS.	TYPE / TIPO O.E.	UNIVERS.
<b>GMC [cont]</b>						
<b>YUKON [cont]</b>						
V8-5.7	1996	Auto Trans; Trans Code 4L60E	234-4012 <sup>1</sup>	234-4000 <sup>1</sup>	234-4018 <sup>1</sup>	234-4000 <sup>1</sup>
V8-5.7	1996	Auto Trans; Trans Code 4L80E	234-4019 <sup>1</sup>	234-4000 <sup>1</sup>	234-4018 <sup>1</sup>	234-4000 <sup>1</sup>
V8-5.7	1996	Manual Trans	234-4019 <sup>1</sup>	234-4000 <sup>1</sup>	234-4018 <sup>1</sup>	234-4000 <sup>1</sup>
V8-5.7	1995-1992	1 Lead Sensor	234-1001	234-1000	-	-
V8-5.7	1995	3 Lead Sensor	234-3011	234-3000	-	-
V8-5.7	1994	3 Lead Sensor	234-3005	234-3000	-	-
V8-5.7	1993-1992	3 Lead Sensor	234-3094	234-3090	-	-
V8-6.0	2013-2008		234-4668 <sup>1</sup>	234-4212 <sup>1</sup>	234-4256 <sup>1</sup>	-
V8-6.0	2006-2003		234-4669 <sup>1</sup>	234-4212 <sup>1</sup>	234-4407 <sup>1</sup>	-
V8-6.0	2002-2001		234-4103 <sup>1</sup>	234-4209 <sup>1</sup>	234-4018 <sup>1</sup>	234-4000 <sup>1</sup>
V8-6.2	2015		234-4940 <sup>1</sup>	-	234-4974 <sup>1</sup>	-
V8-6.2	2014-2008		234-4668 <sup>1</sup>	234-4212 <sup>1</sup>	234-4256 <sup>1</sup>	-
V8-6.2	2007		234-4337 <sup>1</sup>	-	234-4112 <sup>1</sup>	234-4209 <sup>1</sup>
<b>YUKON XL</b>						
V8-5.3	2015		234-4940 <sup>1</sup>	-	234-4974 <sup>1</sup>	-
V8-6.2	2015		234-4940 <sup>1</sup>	-	234-4974 <sup>1</sup>	-
<b>YUKON XL 1500</b>						
V8-5.3	2014-2008		234-4668 <sup>1</sup>	234-4212 <sup>1</sup>	234-4256 <sup>1</sup>	-
V8-5.3	2007		234-4337 <sup>1</sup>	-	234-4112 <sup>1</sup>	234-4209 <sup>1</sup>
V8-5.3	2006		234-4337 <sup>1</sup>	-	234-4336 <sup>1</sup>	-
V8-5.3	2005-2003		234-4668 <sup>1</sup>	234-4212 <sup>1</sup>	234-4668 <sup>1</sup>	234-4212 <sup>1</sup>
V8-5.3	2002-2000	Canada Built	234-4650 <sup>1</sup>	234-4209 <sup>1</sup>	234-4650 <sup>1</sup>	234-4209 <sup>1</sup>
V8-5.3	2002-2000	Exc. Canada Built	234-4012 <sup>1</sup>	234-4000 <sup>1</sup>	234-4018 <sup>1</sup>	234-4000 <sup>1</sup>
V8-6.0	2009-2008		234-4668 <sup>1</sup>	234-4212 <sup>1</sup>	234-4256 <sup>1</sup>	-
V8-6.0	2007		234-4337 <sup>1</sup>	-	234-4112 <sup>1</sup>	234-4209 <sup>1</sup>
V8-6.0	2006-2004		234-4669 <sup>4</sup>	234-4212 <sup>4</sup>	234-4286 <sup>4</sup>	-
V8-6.0	2006-2004		234-4669 <sup>5</sup>	234-4212 <sup>5</sup>	234-4407 <sup>5</sup>	-
V8-6.0	2003	Calif.	234-4669 <sup>4</sup>	234-4212 <sup>4</sup>	234-4286 <sup>4</sup>	-
V8-6.0	2003	Calif.	234-4669 <sup>5</sup>	234-4212 <sup>5</sup>	234-4407 <sup>5</sup>	-
V8-6.0	2003	Exc. Calif.	234-4669 <sup>1</sup>	234-4212 <sup>1</sup>	234-4407 <sup>1</sup>	-
V8-6.0	2002		234-4103 <sup>4</sup>	234-4209 <sup>4</sup>	234-4286 <sup>4</sup>	-
V8-6.0	2002		234-4103 <sup>5</sup>	234-4209 <sup>5</sup>	234-4407 <sup>5</sup>	-
V8-6.0	2001		234-4103 <sup>4</sup>	234-4209 <sup>4</sup>	234-4024 <sup>4</sup>	234-4000 <sup>4</sup>
V8-6.0	2001		234-4103 <sup>5</sup>	234-4209 <sup>5</sup>	234-4018 <sup>5</sup>	234-4000 <sup>5</sup>
V8-6.2	2014-2008		234-4668 <sup>1</sup>	234-4212 <sup>1</sup>	234-4256 <sup>1</sup>	-
V8-6.2	2007		234-4337 <sup>1</sup>	-	234-4112 <sup>1</sup>	234-4209 <sup>1</sup>
<b>YUKON XL 2500</b>						
V8-6.0	2013-2008		234-4668 <sup>1</sup>	234-4212 <sup>1</sup>	234-4256 <sup>1</sup>	-
V8-6.0	2007		234-4337 <sup>1</sup>	-	234-4112 <sup>1</sup>	234-4209 <sup>1</sup>

<sup>1</sup> 2 Required / Requis 2 / Requeridos 2 <sup>4</sup> Left Side / Côté gauche / Lado izquierdo <sup>5</sup> Right Side / Côté droit / Lado derecho



ENGINE MOTEUR MOTOR	YEAR ANNEE AÑO	APPLICATION INFORMATION INFORMATION D'APPLICATION INFORMACION DE APLICACION	UPSTREAM / AVANT - C.C. / ANTES DEL C.C.		DOWNSTREAM / APRS - C.C. / DESPUES DEL C.C.	
			TYPE / TIPO O.E.	UNIVERS.	TYPE / TIPO O.E.	UNIVERS.
<b>GMC [cont]</b>						
<b>YUKON XL 2500 [cont]</b>						
V8-6.0	2006-2004		234-4669 <sup>4</sup>	234-4212 <sup>4</sup>	234-4286 <sup>4</sup>	-
V8-6.0	2006-2004		234-4669 <sup>5</sup>	234-4212 <sup>5</sup>	234-4407 <sup>5</sup>	-
V8-6.0	2003	Calif.	234-4669 <sup>4</sup>	234-4212 <sup>4</sup>	234-4286 <sup>4</sup>	-
V8-6.0	2003	Calif.	234-4669 <sup>5</sup>	234-4212 <sup>5</sup>	234-4407 <sup>5</sup>	-
V8-6.0	2003	Exc. Calif.	234-4669 <sup>1</sup>	234-4212 <sup>1</sup>	234-4407 <sup>1</sup>	-
V8-6.0	2002		234-4103 <sup>4</sup>	234-4209 <sup>4</sup>	234-4286 <sup>4</sup>	-
V8-6.0	2002		234-4103 <sup>5</sup>	234-4209 <sup>5</sup>	234-4407 <sup>5</sup>	-
V8-6.0	2001		234-4103 <sup>4</sup>	234-4209 <sup>4</sup>	234-4024 <sup>4</sup>	234-4000 <sup>4</sup>
V8-6.0	2001		234-4103 <sup>5</sup>	234-4209 <sup>5</sup>	234-4018 <sup>5</sup>	234-4000 <sup>5</sup>
V8-6.0	2000		234-4019 <sup>4</sup>	234-4000 <sup>4</sup>	234-4024 <sup>4</sup>	234-4000 <sup>4</sup>
V8-6.0	2000		234-4019 <sup>5</sup>	234-4000 <sup>5</sup>	234-4018 <sup>5</sup>	234-4000 <sup>5</sup>
V8-8.1	2006-2003		234-4669 <sup>4</sup>	234-4212 <sup>4</sup>	234-4673 <sup>4</sup>	234-4212 <sup>4</sup>
V8-8.1	2006-2003		234-4669 <sup>5</sup>	234-4212 <sup>5</sup>	234-4669 <sup>5</sup>	234-4212 <sup>5</sup>
V8-8.1	2002-2001		234-4103 <sup>4</sup>	234-4209 <sup>4</sup>	234-4102 <sup>4</sup>	234-4209 <sup>4</sup>
V8-8.1	2002-2001		234-4103 <sup>5</sup>	234-4209 <sup>5</sup>	234-4103 <sup>5</sup>	234-4209 <sup>5</sup>
<b>HONDA</b>						
<b>ACCORD</b>						
L4-1.8	1985-1984		234-1009	234-1000	-	-
L4-2.0	2015-2014		234-9119	-	234-4786	-
L4-2.0	1989-1988	Carbureted	234-1009	234-1000	-	-
L4-2.0	1989-1988	Fuel Injected; Calif.	234-1017 <sup>1</sup>	234-1000 <sup>1</sup>	-	-
L4-2.0	1989-1986	Fuel Injected; Exc. Calif.	234-1009 <sup>1</sup>	234-1000 <sup>1</sup>	-	-
L4-2.0	1987-1986	Carbureted; Calif.	234-1009	234-1000	-	-
L4-2.0	1987-1986	Carbureted; Exc. Calif.; w/ 14" Sensor	234-1017	234-1000	-	-
L4-2.0	1987-1986	Carbureted; Exc. Calif.; w/ 19" Sensor	234-1009	234-1000	-	-
L4-2.0	1987-1986	Fuel Injected; Calif.	234-1017 <sup>4</sup>	234-1000 <sup>4</sup>	-	-
L4-2.0	1987-1986	Fuel Injected; Calif.	234-1009 <sup>5</sup>	234-1000 <sup>5</sup>	-	-
L4-2.2	1997-1996	F22B1 Engine	234-4095	234-4209	234-4601	234-4209
L4-2.2	1997-1996	F22B2 Engine	234-4620	234-4209	234-4601	234-4209
L4-2.2	1995-1994	Female Connector	234-4620	234-4209	-	-
L4-2.2	1995-1990	Male Connector	234-4095	234-4209	-	-
L4-2.2	1993-1990	Female Connector	234-4621	234-4209	-	-
L4-2.3	2002-2001	F23A4 Engine; SULEV	234-9014	-	234-4122	-
L4-2.3	2002-2001	F23A4 Engine; ULEV	234-9014	-	234-4621	234-4209
L4-2.3	2002-1998	F23A1 & F23A5 Engine	234-4620	234-4209	234-4621	234-4209
L4-2.3	2000	F23A4 Engine; SULEV.	234-9014	-	234-4122	-
L4-2.3	2000	F23A4 Engine; ULEV	234-9025	-	234-4621	234-4209
L4-2.3	1999-1998	F23A4 Engine	234-9025	-	234-4621	234-4209
L4-2.4	2015-2013		234-9131	-	234-4786	-

<sup>1</sup> 2 Required / Requis 2 / Requeridos 2 <sup>4</sup> Left Side / Côté gauche / Lado izquierdo <sup>5</sup> Right Side / Côté droit / Lado derecho



ENGINE MOTEUR MOTOR	YEAR ANNEE AÑO	APPLICATION INFORMATION INFORMATION D'APPLICATION INFORMACION DE APLICACION	UPSTREAM / AVANT - C.C. / ANTES DEL C.C.		DOWNSTREAM / APRS - C.C. / DESPUES DEL C.C.	
			TYPE / TIPO O.E.	UNIVERS.	TYPE / TIPO O.E.	UNIVERS.
<b>HONDA [cont]</b>						
<b>ACCORD [cont]</b>						
L4-2.4	2012-2008		234-9091	-	234-4462	-
L4-2.4	2007-2004	Calif.	234-9040	-	234-4363	-
L4-2.4	2007-2004	Exc. Calif.	234-9040	-	234-4797	-
L4-2.4	2003	Coupe	234-9040	-	234-4797	-
L4-2.4	2003	Sedan; Calif.	234-9040	-	234-4363	-
L4-2.4	2003	Sedan; Exc. Calif.	234-9040	-	234-4797	-
V6-2.7	1997-1995		234-4065	234-4209	234-4601	234-4209
V6-3.0	2007-2003	Auto Trans	234-5010 <sup>15</sup>	-	234-4355 <sup>15</sup>	-
V6-3.0	2007-2003	Auto Trans	234-5010 <sup>16</sup>	-	234-4368 <sup>16</sup>	-
V6-3.0	2007-2003	Manual Trans	234-5010 <sup>1</sup>	-	234-4368 <sup>1</sup>	-
V6-3.0	2002-2000		234-4727	-	234-4621	234-4209
V6-3.0	1999-1998	Calif.	234-4099	234-4209	234-4621	234-4209
V6-3.0	1999-1998	Exc. Calif.	234-4099	234-4209	234-4601	234-4209
V6-3.5	2015		234-5056 <sup>15</sup>	-	234-4781 <sup>15</sup>	-
V6-3.5	2015		234-5056 <sup>16</sup>	-	234-4790 <sup>16</sup>	-
V6-3.5	2014-2013	Auto Trans; Calif.	234-5152 <sup>15</sup>	-	234-4781 <sup>15</sup>	-
V6-3.5	2014-2013	Auto Trans; Calif.	234-5152 <sup>16</sup>	-	234-4790 <sup>16</sup>	-
V6-3.5	2014-2013	Auto Trans; Exc. Calif.	234-5056 <sup>15</sup>	-	234-4781 <sup>15</sup>	-
V6-3.5	2014-2013	Auto Trans; Exc. Calif.	234-5056 <sup>16</sup>	-	234-4790 <sup>16</sup>	-
V6-3.5	2014-2013	Manual Trans	234-5056 <sup>15</sup>	-	234-4782 <sup>15</sup>	-
V6-3.5	2014-2013	Manual Trans	234-5056 <sup>16</sup>	-	234-4790 <sup>16</sup>	-
V6-3.5	2012-2011		234-5098 <sup>1</sup>	-	234-4461 <sup>1</sup>	-
V6-3.5	2010-2008	Calif.; Auto Trans	234-5099 <sup>1</sup>	-	234-4461 <sup>1</sup>	-
V6-3.5	2010-2008	Calif.; Manual Trans	234-5098 <sup>1</sup>	-	234-4461 <sup>1</sup>	-
V6-3.5	2010-2008	Exc. Calif.	234-5098 <sup>1</sup>	-	234-4461 <sup>1</sup>	-
<b>ACCORD CROSSTOUR</b>						
V6-3.5	2011-2010		234-5098 <sup>15</sup>	-	234-4351 <sup>15</sup>	-
V6-3.5	2011-2010		234-5098 <sup>16</sup>	-	234-4461 <sup>16</sup>	-
<b>CIVIC</b>						
L4-1.3	2011-2006		234-9063	-	234-4350	-
L4-1.3	2005-2004	Calif.	234-9005	-	234-4352	-
L4-1.3	2005-2003	Exc. Calif.	234-9005	-	234-4613	234-4210
L4-1.3	2005-2003	Exc. Calif.; Loc. Center	-	-	234-4224 <sup>12</sup>	234-4210 <sup>12</sup>
L4-1.3	2003	Calif.; From Eng #3S020136	234-9005	-	234-4352	-
L4-1.3	2003	Calif.; To Eng #3S020135	234-9005	-	234-4355	-
L4-1.3	1987-1984		234-1008	234-1000	-	-
L4-1.5	2015-2012		234-9117	-	234-4743	-
L4-1.5	1995-1993	D15Z1 Engine; Calif.	234-4099	234-4209	-	-
L4-1.5	1995-1993	D15Z1 Engine; Exc. Calif.	234-5052	-	-	-
L4-1.5	1995-1992	D15B7 Engine	234-4099	234-4209	-	-

<sup>1</sup> 2 Required / Requis 2 / Requeridos 2 <sup>12</sup> Loc. Center / Empl. central / Ubicación central <sup>15</sup> Front / Avant / Parte delantera <sup>16</sup> Rear / Arrière / Parte trasera



ENGINE MOTEUR MOTOR	YEAR ANNEE AÑO	APPLICATION INFORMATION INFORMATION D'APPLICATION INFORMACION DE APLICACION	UPSTREAM / AVANT - C.C. / ANTES DEL C.C.		DOWNSTREAM / APRES - C.C. / DESPUES DEL C.C.	
			TYPE / TIPO O.E.	UNIVERS.	TYPE / TIPO O.E.	UNIVERS.
<b>HONDA [cont]</b>						
<b>CIVIC [cont]</b>						
L4-1.5	1995	D15B8 Engine	234-1034	234-1000	-	-
L4-1.5	1994-1993	D15B8 Engine; Calif.	234-4099	234-4209	-	-
L4-1.5	1994-1993	D15B8 Engine; Exc. Calif.	234-1034	234-1000	-	-
L4-1.5	1992	D15B8 Engine	234-1034	234-1000	-	-
L4-1.5	1992	D15Z1 Engine	234-5052	-	-	-
L4-1.5	1991-1988		234-1009	234-1000	-	-
L4-1.5	1987-1983		234-1008	234-1000	-	-
L4-1.6	2000-1999	B16A2 Engine	234-4011	234-4209	234-4098	234-4209
L4-1.6	2000-1999	D16Y8 Engine	234-4733	-	234-4098	234-4209
L4-1.6	2000-1998	D16B5 Engine	234-4074	-	234-4099	234-4209
L4-1.6	2000-1996	D16Y5 Engine; Automatic CVT Trans	234-4099	234-4209	234-4065	234-4209
L4-1.6	2000-1996	D16Y5 Engine; Manual Trans	234-5052	-	234-4065	234-4209
L4-1.6	2000-1996	D16V7 Engine	234-4099	234-4209	234-4065	234-4209
L4-1.6	1998-1996	D16Y8 Engine	234-4099	234-4209	234-4659	234-4209
L4-1.6	1995-1992		234-4099	234-4209	-	-
L4-1.6	1991-1988		234-1009	234-1000	-	-
L4-1.7	2005-2004	D17A1 Engine	234-9005	-	234-4092	234-4209
L4-1.7	2005-2004	D17A2 Engine	234-9017	-	234-4220	234-4209
L4-1.7	2005-2001	D17A6 Engine	234-9005	-	234-4613 <sup>1</sup>	234-4210 <sup>1</sup>
L4-1.7	2005-2001	D17A7 Engine	234-4123	-	234-4092	234-4209
L4-1.7	2003-2001	D17A1 Engine	234-4074	-	234-4092	234-4209
L4-1.7	2003-2001	D17A2 Engine	234-4122	-	234-4621	234-4209
L4-1.8	2015-2014	CNG Engine	234-9119	-	234-4350	-
L4-1.8	2015	Gas Engine	234-9131	-	234-4786	-
L4-1.8	2014	Gas Engine	234-9119	-	234-4979	-
L4-1.8	2013-2012		234-9119	-	234-4350	-
L4-1.8	2011-2007	Gas Engine	234-9124	-	234-4350	-
L4-1.8	2011-2006	CNG Engine	234-9069	-	234-4350	-
L4-1.8	2006	Gas Engine	234-9126	-	234-4350	-
L4-2.0	2011-2006		234-9076	-	234-4358	-
L4-2.0	2005-2002		234-9004	-	234-4122	-
L4-2.4	2015-2012		234-9118	-	234-4581	-
<b>CIVIC DEL SOL</b>						
L4-1.5	1995-1993		234-4099	234-4209	-	-
L4-1.6	1997-1996	S & SI Model	234-4099	234-4209	234-4065	234-4209
L4-1.6	1997-1996	VTEC Model	234-4011	234-4209	234-4065	234-4209
L4-1.6	1995-1994	SI Model	234-4099	234-4209	-	-
L4-1.6	1995-1994	VTEC Model	234-4011	234-4209	-	-
L4-1.6	1993		234-4099	234-4209	-	-
<b>CROSSTOUR</b>						
L4-2.4	2015-2012		234-9118	-	234-4574	-

<sup>1</sup> 2 Required / Requis 2 / Requeridos 2 <sup>15</sup> Front / Avant / Parte delantera



ENGINE MOTEUR MOTOR	YEAR ANNEE AÑO	APPLICATION INFORMATION INFORMATION D'APPLICATION INFORMACION DE APLICACION	UPSTREAM / AVANT - C.C. / ANTES DEL C.C.		DOWNSTREAM / APRS - C.C. / DESPUES DEL C.C.	
			TYPE / TIPO O.E.	UNIVERS.	TYPE / TIPO O.E.	UNIVERS.
<b>HONDA [cont]</b>						
<b>CROSSTOUR [cont]</b>						
V6-3.5	2015-2013		234-5056 <sup>15</sup>	-	234-4781 <sup>15</sup>	-
V6-3.5	2015-2013		234-5056 <sup>16</sup>	-	234-4790 <sup>16</sup>	-
V6-3.5	2012		234-5098 <sup>15</sup>	-	234-4351 <sup>15</sup>	-
V6-3.5	2012		234-5098 <sup>16</sup>	-	234-4461 <sup>16</sup>	-
<b>CR-V</b>						
L4-2.0	2001-1997		234-4011	234-4209	234-4098	234-4209
L4-2.4	2015		234-9131	-	234-4980	-
L4-2.4	2014		234-9118	-	234-4977	-
L4-2.4	2013-2012		234-9118	-	234-4743	-
L4-2.4	2011-2010		234-9091	-	234-4442	-
L4-2.4	2009-2007		234-9062	-	234-4359	-
L4-2.4	2006-2005		234-9064	-	234-4352	-
L4-2.4	2004-2002		234-9005	-	234-4125	-
<b>CRX</b>						
L4-1.5	1991-1988		234-1009	234-1000	-	-
L4-1.6	1991-1988		234-1009	234-1000	-	-
<b>CR-Z</b>						
L4-1.5	2015-2012		234-9117	-	234-4544	-
L4-1.5	2011		234-9116	-	234-4544	-
<b>ELEMENT</b>						
L4-2.4	2011-2003		234-9064	-	234-4733	-
<b>FIT</b>						
L4-1.5	2016-2015		234-9146	-	234-4978	-
L4-1.5	2014-2011		234-9117	-	234-4218	-
L4-1.5	2010-2009		234-9077	-	234-4218	-
L4-1.5	2008-2007		234-9060	-	234-4358	-
<b>HR-V</b>						
L4-1.8	2016		234-9119	-	234-4979	-
<b>INSIGHT</b>						
L3-1.0	2006-2002	Manual Trans	234-9013	-	234-4954	-
L3-1.0	2006-2002	Manual Trans	-	-	234-4955 <sup>12</sup>	-
L3-1.0	2006-2001	Automatic CVT Trans	234-9013	-	234-4361	-
L3-1.0	2001	Manual Trans	234-5050	-	234-4620	234-4209
L3-1.0	2000		234-5050	-	234-4094	234-4209
L4-1.3	2014-2012		234-9117	-	234-4544	-
L4-1.3	2011		234-9117	-	234-4219	-
L4-1.3	2010		234-9078	-	234-4219	-
<b>ODYSSEY</b>						
L4-2.2	1997-1996		234-4095	234-4209	234-4092	234-4209
L4-2.2	1995		234-4095	234-4209	-	-
L4-2.3	1998		234-4095	234-4209	234-4092	234-4209

<sup>1</sup> 2 Required / Requis 2 / Requeridos 2 <sup>12</sup> Loc.Center / Empl. central / Ubicación central <sup>15</sup> Front / Avant / Parte delantera <sup>16</sup> Rear / Arrière / Parte trasera



ENGINE MOTEUR MOTOR	YEAR ANNEE AÑO	APPLICATION INFORMATION INFORMATION D'APPLICATION INFORMACION DE APLICACION	UPSTREAM / AVANT - C.C. / ANTES DEL C.C.		DOWNSTREAM / APRS - C.C. / DESPUES DEL C.C.	
			TYPE / TIPO O.E.	UNIVERS.	TYPE / TIPO O.E.	UNIVERS.
<b>HONDA [cont]</b>						
<b>ODYSSEY [cont]</b>						
V6-3.5	2015-2014		234-5056 <sup>1</sup>	-	234-4976 <sup>1</sup>	-
V6-3.5	2013-2011		234-5098 <sup>1</sup>	-	234-4461 <sup>1</sup>	-
V6-3.5	2010-2008	J35A6 Engine	234-5053 <sup>15</sup>	-	234-4355 <sup>15</sup>	-
V6-3.5	2010-2008	J35A6 Engine	234-5053 <sup>16</sup>	-	234-4368 <sup>16</sup>	-
V6-3.5	2010-2008	J35A7 Engine	234-5053 <sup>1</sup>	-	234-4461 <sup>1</sup>	-
V6-3.5	2007		234-5053 <sup>15</sup>	-	234-4355 <sup>15</sup>	-
V6-3.5	2007		234-5053 <sup>16</sup>	-	234-4368 <sup>16</sup>	-
V6-3.5	2006-2005		234-5010 <sup>15</sup>	-	234-4355 <sup>15</sup>	-
V6-3.5	2006-2005		234-5010 <sup>16</sup>	-	234-4368 <sup>16</sup>	-
V6-3.5	2004-2001		234-4727	-	234-4094	234-4209
V6-3.5	2000-1999		234-4099	234-4209	234-4094	234-4209
<b>PASSPORT</b>						
L4-2.6	1996		234-4012	234-4000	234-4012	234-4000
L4-2.6	1995-1994		234-3074	234-3090	-	-
V6-3.2	2002		234-4650 <sup>1</sup>	234-4209 <sup>1</sup>	234-4650 <sup>1</sup>	234-4209 <sup>1</sup>
V6-3.2	2001		234-4063 <sup>1</sup>	234-4209 <sup>1</sup>	234-4063 <sup>1</sup>	234-4209 <sup>1</sup>
V6-3.2	2000-1996		234-4012 <sup>1</sup>	234-4000 <sup>1</sup>	234-4012 <sup>1</sup>	234-4000 <sup>1</sup>
V6-3.2	1995-1994		234-4062	234-4209	-	-
<b>PILOT</b>						
V6-3.5	2016		234-5056 <sup>15</sup>	-	234-4781 <sup>15</sup>	-
V6-3.5	2016		234-5056 <sup>16</sup>	-	234-4790 <sup>16</sup>	-
V6-3.5	2015-2012		234-5056 <sup>15</sup>	-	234-4580 <sup>15</sup>	-
V6-3.5	2015-2012		234-5056 <sup>16</sup>	-	234-4461 <sup>16</sup>	-
V6-3.5	2011-2009		234-5098 <sup>1</sup>	-	234-4461 <sup>1</sup>	-
V6-3.5	2008-2005		234-5010 <sup>15</sup>	-	234-4355 <sup>15</sup>	-
V6-3.5	2008-2005		234-5010 <sup>16</sup>	-	234-4368 <sup>16</sup>	-
V6-3.5	2004-2003		234-4368	-	234-4601	234-4209
<b>PRELUDE</b>						
L4-1.8	1987-1984		234-1009	234-1000	-	-
L4-2.0	1991		234-1006 <sup>4</sup>	234-1000 <sup>4</sup>	-	-
L4-2.0	1991		234-1017 <sup>5</sup>	234-1000 <sup>5</sup>	-	-
L4-2.0	1990-1988	Carbureted	234-1009	234-1000	-	-
L4-2.0	1990-1988	Fuel Injected	234-1006 <sup>4</sup>	234-1000 <sup>4</sup>	-	-
L4-2.0	1990-1988	Fuel Injected	234-1017 <sup>5</sup>	234-1000 <sup>5</sup>	-	-
L4-2.0	1987-1985		234-1009	234-1000	-	-
L4-2.1	1991-1990		234-4095	234-4209	-	-
L4-2.2	2001-1997	Base Model	234-4092	234-4209	234-4092	234-4209
L4-2.2	2001-1997	Type SH	234-4621	234-4209	234-4092	234-4209
L4-2.2	1996		234-4095	234-4209	234-4601	234-4209
L4-2.2	1995-1993	S	234-4094	234-4209	-	-

<sup>1</sup> 2 Required / Requis 2 / Requeridos 2 <sup>4</sup> Left Side / Côté gauche / Lado izquierdo <sup>5</sup> Right Side / Côté droit / Lado derecho <sup>15</sup> Front / Avant / Parte delantera <sup>16</sup> Rear / Arrière / Parte trasera





ENGINE MOTEUR MOTOR	YEAR ANNEE AÑO	APPLICATION INFORMATION INFORMATION D'APPLICATION INFORMACION DE APLICACION	UPSTREAM / AVANT - C.C. / ANTES DEL C.C.		DOWNSTREAM / APRES - C.C. / DESPUES DEL C.C.		
			TYPE / TIPO O.E.	UNIVERS.	TYPE / TIPO O.E.	UNIVERS.	
<b>HONDA [cont]</b>							
<b>PRELUDE [cont]</b>							
L4-2.2	1995-1993	VTEC Model	234-4011	234-4209	-	-	
L4-2.2	1992		234-4094	234-4209	-	-	
L4-2.3	1996		234-4095	234-4209	234-4601	234-4209	
L4-2.3	1995-1992		234-4011	234-4209	-	-	
<b>RIDGELINE</b>							
V6-3.5	2014-2012		234-5056 <sup>15</sup>	-	234-4580 <sup>15</sup>	-	
V6-3.5	2014-2012		234-5056 <sup>16</sup>	-	234-4461 <sup>16</sup>	-	
V6-3.5	2011-2009		234-5098 <sup>1</sup>	-	234-4461 <sup>1</sup>	-	
V6-3.5	2008-2006		234-5010 <sup>15</sup>	-	234-4355 <sup>15</sup>	-	
V6-3.5	2008-2006		234-5010 <sup>16</sup>	-	234-4368 <sup>16</sup>	-	
<b>S2000</b>							
L4-2.0	2003-2000		234-4124	-	234-4601	234-4209	
L4-2.2	2009-2006		234-9065	-	234-4353	-	
L4-2.2	2005-2004		234-4368	-	234-4364	-	
<b>WAGOVAN</b>							
L4-1.5	1987-1986		234-1008	234-1000	-	-	
L4-1.5	1984		234-1008	234-1000	-	-	
<b>HUMMER</b>							
<b>H2</b>							
V8-6.0	2007		234-4337 <sup>1</sup>	-	234-4112 <sup>1</sup>	234-4209 <sup>1</sup>	
V8-6.0	2006-2003		234-4669 <sup>1</sup>	234-4212 <sup>1</sup>	234-4407 <sup>1</sup>	-	
V8-6.2	2009-2008		234-4337 <sup>1</sup>	-	234-4258 <sup>1</sup>	-	
<b>H3</b>							
L5-3.5	2006		234-4331	-	234-4347	-	
L5-3.7	2010-2007		234-4331	-	234-4294	-	
V8-5.3	2010-2008		234-4337 <sup>1</sup>	-	234-4243 <sup>1</sup>	-	
<b>H3T</b>							
L5-3.7	2010-2009		234-4331	-	234-4294	-	
V8-5.3	2010-2009		234-4337 <sup>1</sup>	-	234-4243 <sup>1</sup>	-	
<b>HYUNDAI</b>							
<b>ACCENT</b>							
L4-1.5	2003-2000	DOHC	234-4851	-	234-4851	-	
L4-1.5	1999-1998		234-4690	234-4201	234-4693	234-4201	
L4-1.5	1997-1996		234-4692	234-4201	234-4691	234-4201	
L4-1.5	1997		SOHC; From 05/01/97	234-4690	234-4201	234-4693	234-4201
L4-1.5	1997		SOHC; To 05/01/97; Calif.	234-4428	234-4201	234-4692	234-4201
L4-1.5	1997		SOHC; To 05/01/97; Exc. Calif. & Canada	234-4692	234-4201	234-4691	234-4201
L4-1.5	1996		SOHC; Calif.	234-4428	234-4201	234-4692	234-4201
L4-1.5	1996		SOHC; Exc. Calif. & Canada; From 05/20/96	234-4428	234-4201	234-4691	234-4201

<sup>1</sup> 2 Required / Requis 2 / Requeridos 2 <sup>15</sup> Front / Avant / Parte delantera <sup>16</sup> Rear / Arrière / Parte trasera



ENGINE MOTEUR MOTOR	YEAR ANNEE AÑO	APPLICATION INFORMATION INFORMATION D'APPLICATION INFORMACION DE APLICACION	UPSTREAM / AVANT - C.C. / ANTES DEL C.C.		DOWNSTREAM / APRS - C.C. / DESPUES DEL C.C.	
			TYPE / TIPO O.E.	UNIVERS.	TYPE / TIPO O.E.	UNIVERS.
<b>HYUNDAI [cont]</b>						
<b>ACCENT [cont]</b>						
L4-1.5	1996	SOHC; Exc. Calif. & Canada; To 05/20/96	234-4692	234-4201	234-4691	234-4201
L4-1.5	1995	SOHC; From 07/25/95; Calif.	234-4428	234-4201	234-4692	234-4201
L4-1.5	1995	SOHC; From 07/25/95; Exc. Calif. & Canada	234-4692	234-4201	234-4691	234-4201
L4-1.5	1995	SOHC; To 07/25/95	234-3107	234-3090	-	-
L4-1.6	2014-2012		234-5055	-	234-4568	-
L4-1.6	2011-2001		234-4851	-	234-4851	-
<b>AZERA</b>						
V6-3.3	2015-2012		234-4458 <sup>4</sup>	-	234-4456 <sup>4</sup>	-
V6-3.3	2015-2012		234-4571 <sup>5</sup>	-	234-4572 <sup>5</sup>	-
V6-3.3	2011-2007		234-4854 <sup>4</sup>	-	234-4854 <sup>4</sup>	-
V6-3.3	2011-2007		234-4854 <sup>5</sup>	-	234-4855 <sup>5</sup>	-
V6-3.8	2011-2006		234-4854 <sup>4</sup>	-	234-4854 <sup>4</sup>	-
V6-3.8	2011-2006		234-4854 <sup>5</sup>	-	234-4855 <sup>5</sup>	-
<b>ELANTRA</b>						
L4-1.6	1995		234-4034	234-4210	234-4042	234-4210
L4-1.6	1994	From 07/01/94	234-4034	234-4210	234-4042	234-4210
L4-1.6	1994	To 07/01/94; Calif.	234-4034	234-4210	234-4042	234-4210
L4-1.6	1994	To 07/01/94; Exc. Calif.	234-4034	234-4210	-	-
L4-1.6	1993	From 07/01/93; Calif.	234-4034	234-4210	234-4042	234-4210
L4-1.6	1993	From 07/01/93; Exc. Calif.	234-4034	234-4210	-	-
L4-1.6	1993	To 07/01/93	234-4131	234-4212	-	-
L4-1.6	1992		234-4131	234-4212	-	-
L4-1.8	2014-2011	Calif.	234-5082	-	234-4552	-
L4-1.8	2014-2011	Exc. Calif.	234-5083	-	234-4550	-
L4-1.8	1998		234-4690	234-4201	234-4693	234-4201
L4-1.8	1997-1996		234-4692	234-4201	234-4691	234-4201
L4-1.8	1995		234-4034	234-4210	234-4042	234-4210
L4-1.8	1994	From 07/01/94	234-4034	234-4210	234-4042	234-4210
L4-1.8	1994	To 07/01/94; Calif.	234-4034	234-4210	234-4042	234-4210
L4-1.8	1994	To 07/01/94; Exc. Calif.	234-4034	234-4210	-	-
L4-1.8	1993	From 07/01/93; Calif.	234-4034	234-4210	234-4042	234-4210
L4-1.8	1993	From 07/01/93; Exc. Calif.	234-4034	234-4210	-	-
L4-1.8	1993	To 07/01/93	234-4131	234-4212	-	-
L4-2.0	2014	Calif.	234-5082	-	234-4552	-
L4-2.0	2014	Exc. Calif.	234-5083	-	234-4550	-
L4-2.0	2012-2011		234-4938	-	234-4851	-
L4-2.0	2010-2009	VIN E	234-4938	-	234-4851	-
L4-2.0	2010	VIN D	234-5047	-	234-4851	-
L4-2.0	2009	VIN D	234-5430	-	234-4851	-
L4-2.0	2008-2007		234-5430	-	234-4851	-
L4-2.0	2006-2004	SULEV	234-5430	-	234-4851	-

<sup>4</sup> Left Side / Côté gauche / Lado izquierdo <sup>5</sup> Right Side / Côté droit / Lado derecho



ENGINE MOTEUR MOTOR	YEAR ANNEE AÑO	APPLICATION INFORMATION INFORMATION D'APPLICATION INFORMACION DE APLICACION	UPSTREAM / AVANT - C.C. / ANTES DEL C.C.		DOWNSTREAM / APRES - C.C. / DESPUES DEL C.C.	
			TYPE / TIPO O.E.	UNIVERS.	TYPE / TIPO O.E.	UNIVERS.
<b>HYUNDAI [cont]</b>						
<b>ELANTRA [cont]</b>						
L4-2.0	2006-2004	ULEV	234-4852	-	234-4851	-
L4-2.0	2003	Auto Trans; Calif.	234-5430	-	234-4851	-
L4-2.0	2003	Auto Trans; Exc. Calif.	234-4852	-	234-4851	-
L4-2.0	2003	Manual Trans	234-4852	-	234-4851	-
L4-2.0	2002-2001		234-4852	-	234-4851	-
L4-2.0	2000-1999		234-4690	234-4201	234-4693	234-4201
<b>ELANTRA COUPE</b>						
L4-1.8	2013	Calif.	234-5082	-	234-4552	-
L4-1.8	2013	Exc. Calif.	234-5083	-	234-4550	-
L4-2.0	2014	Calif.	234-5082	-	234-4552	-
L4-2.0	2014	Exc. Calif.	234-5083	-	234-4550	-
<b>ELANTRA GT</b>						
L4-1.8	2013	Calif.	234-5082	-	234-4552	-
L4-1.8	2013	Exc. Calif.	234-5083	-	234-4550	-
L4-2.0	2014	Calif.	234-5082	-	234-4552	-
L4-2.0	2014	Exc. Calif.	234-5083	-	234-4550	-
<b>ENTOURAGE</b>						
V6-3.8	2010-2007		234-4854 <sup>4</sup>	-	234-4854 <sup>4</sup>	-
V6-3.8	2010-2007		234-4854 <sup>5</sup>	-	234-4855 <sup>5</sup>	-
<b>EQUUS</b>						
V8-4.6	2011		234-4262 <sup>4</sup>	-	234-4262 <sup>4</sup>	-
V8-4.6	2011		234-4239 <sup>5</sup>	-	234-4240 <sup>5</sup>	-
V8-5.0	2015-2012		234-4239 <sup>4</sup>	-	234-4262 <sup>4</sup>	-
V8-5.0	2015-2012		234-4239 <sup>5</sup>	-	234-4573 <sup>5</sup>	-
<b>EXCEL</b>						
L4-1.5	1994		234-4637	234-4209	234-4042	234-4210
L4-1.5	1993	Calif.	234-4637	234-4209	234-4042	234-4210
L4-1.5	1993	Exc. Calif.; From 07/16/93	234-4637	234-4209	234-4042	234-4210
L4-1.5	1993	Exc. Calif.; To 07/16/93	234-1018	234-1000	234-4042	234-4210
L4-1.5	1992	Calif.; From 07/01/92	234-4637	234-4209	234-4042	234-4210
L4-1.5	1992	Calif.; To 07/01/92	234-2002	234-2000	234-4042	234-4210
L4-1.5	1992	Canada Model	234-1018	234-1000	-	-
L4-1.5	1992	Exc. Calif.	234-1018	234-1000	234-4042	234-4210
L4-1.5	1991-1990	Calif.	234-2002	234-2000	-	-
L4-1.5	1991-1990	Exc. Calif. & Canada	234-1018	234-1000	-	-
L4-1.5	1989-1988		234-1005	234-1000	-	-
L4-1.5	1987	Auto Trans; From 05/87	234-1005	234-1000	-	-
L4-1.5	1987	Auto Trans; To 04/87	234-1018	234-1000	-	-
L4-1.5	1987	Manual Trans; From 06/87	234-1005	234-1000	-	-
L4-1.5	1987	Manual Trans; To 05/87	234-1018	234-1000	-	-
L4-1.5	1986		234-1018	234-1000	-	-

<sup>4</sup> Left Side / Côté gauche / Lado izquierdo <sup>5</sup> Right Side / Côté droit / Lado derecho



ENGINE MOTEUR MOTOR	YEAR ANNEE AÑO	APPLICATION INFORMATION INFORMATION D'APPLICATION INFORMACION DE APLICACION	UPSTREAM / AVANT - C.C. / ANTES DEL C.C.		DOWNSTREAM / APRS - C.C. / DESPUES DEL C.C.	
			TYPE / TIPO O.E.	UNIVERS.	TYPE / TIPO O.E.	UNIVERS.
<b>HYUNDAI [cont]</b>						
<b>GENESIS</b>						
V6-3.8	2015-2012		234-4463 <sup>4</sup>	-	234-4456 <sup>4</sup>	-
V6-3.8	2015-2012		234-4570 <sup>5</sup>	-	234-4456 <sup>5</sup>	-
V6-3.8	2011-2009		234-4263 <sup>4</sup>	-	234-4854 <sup>4</sup>	-
V6-3.8	2011-2009		234-4272 <sup>5</sup>	-	234-4854 <sup>5</sup>	-
V8-4.6	2012-2009		234-4240 <sup>4</sup>	-	234-4262 <sup>4</sup>	-
V8-4.6	2012		234-4239 <sup>5</sup>	-	234-4573 <sup>5</sup>	-
V8-4.6	2011-2009		234-4239 <sup>5</sup>	-	234-4262 <sup>5</sup>	-
V8-5.0	2015-2012		234-4239 <sup>4</sup>	-	234-4262 <sup>4</sup>	-
V8-5.0	2015-2012		234-4239 <sup>5</sup>	-	234-4573 <sup>5</sup>	-
<b>GENESIS COUPE</b>						
L4-2.0	2014-2013		234-5044	-	234-4238	-
L4-2.0	2012-2010		234-4449	-	234-4238	-
V6-3.8	2015-2013		234-4458 <sup>4</sup>	-	234-4456 <sup>4</sup>	-
V6-3.8	2015-2013		234-4571 <sup>5</sup>	-	234-4456 <sup>5</sup>	-
V6-3.8	2012-2010		234-4854 <sup>4</sup>	-	234-4854 <sup>4</sup>	-
V6-3.8	2012-2010		234-4464 <sup>5</sup>	-	234-4854 <sup>5</sup>	-
<b>SANTA FE</b>						
L4-2.0	2015-2013		234-5147	-	234-4956	-
L4-2.4	2015-2010		234-5029	-	234-4238	-
L4-2.4	2006-2001		234-4436	-	234-4434	-
V6-2.7	2009-2007		234-4438 <sup>4</sup>	-	234-4194 <sup>4</sup>	-
V6-2.7	2009-2007		234-4429 <sup>5</sup>	-	234-4437 <sup>5</sup>	-
V6-2.7	2006-2005		234-4193 <sup>4</sup>	-	234-4193 <sup>4</sup>	-
V6-2.7	2006-2005		234-4191 <sup>5</sup>	-	234-4192 <sup>5</sup>	-
V6-2.7	2004-2003		234-4191 <sup>4</sup>	-	234-4193 <sup>4</sup>	-
V6-2.7	2004-2003		234-4191 <sup>5</sup>	-	234-4192 <sup>5</sup>	-
V6-2.7	2002-2001		234-4431 <sup>4</sup>	-	234-4431 <sup>4</sup>	-
V6-2.7	2002-2001		234-4431 <sup>5</sup>	-	234-4432 <sup>5</sup>	-
V6-3.3	2015-2013		234-4458 <sup>4</sup>	-	234-4456 <sup>4</sup>	-
V6-3.3	2015-2013	AWD	234-4463 <sup>5</sup>	-	234-4455 <sup>5</sup>	-
V6-3.3	2015-2013	FWD	234-4571 <sup>5</sup>	-	234-4455 <sup>5</sup>	-
V6-3.3	2009-2007		234-4854 <sup>4</sup>	-	234-4854 <sup>4</sup>	-
V6-3.3	2009-2007		234-4903 <sup>5</sup>	-	234-4856 <sup>5</sup>	-
V6-3.5	2012-2010		234-4458 <sup>4</sup>	-	234-4456 <sup>4</sup>	-
V6-3.5	2012-2010		234-4463 <sup>5</sup>	-	234-4455 <sup>5</sup>	-
V6-3.5	2006-2003		234-4194 <sup>4</sup>	-	234-4199 <sup>4</sup>	234-4210 <sup>4</sup>
V6-3.5	2006-2003		234-4194 <sup>5</sup>	-	234-4166 <sup>5</sup>	234-4210 <sup>5</sup>

<sup>4</sup> Left Side / Côté gauche / Lado izquierdo <sup>5</sup> Right Side / Côté droit / Lado derecho



ENGINE MOTEUR MOTOR	YEAR ANNEE AÑO	APPLICATION INFORMATION INFORMATION D'APPLICATION INFORMACION DE APLICACION	UPSTREAM / AVANT - C.C. / ANTES DEL C.C.		DOWNSTREAM / APRS - C.C. / DESPUES DEL C.C.	
			TYPE / TIPO O.E.	UNIVERS.	TYPE / TIPO O.E.	UNIVERS.
<b>HYUNDAI [cont]</b>						
<b>SANTA FE XL</b>						
V6-3.3	2015-2013		234-4458 <sup>4</sup>	-	234-4456 <sup>4</sup>	-
V6-3.3	2015-2013	AWD	234-4463 <sup>5</sup>	-	234-4455 <sup>5</sup>	-
V6-3.3	2015-2013	FWD	234-4571 <sup>5</sup>	-	234-4455 <sup>5</sup>	-
<b>SCOUPE</b>						
L4-1.5	1995-1993	Non-Turbo; Calif.	234-2002	234-2000	-	-
L4-1.5	1995-1993	Non-Turbo; Exc. Calif.	234-1018	234-1000	-	-
L4-1.5	1995	Turbo; Calif.	-	-	234-3107	234-3090
L4-1.5	1995	Turbo; Exc. Calif.	234-3150	234-3090	234-3107	234-3090
L4-1.5	1994	Turbo; From 07/01/94; Calif.	-	-	234-3107	234-3090
L4-1.5	1994	Turbo; From 07/01/94; Exc. Calif.	234-3150	234-3090	234-3107	234-3090
L4-1.5	1994	Turbo; To 07/01/94	234-3150	234-3090	234-3107	234-3090
L4-1.5	1993	Turbo; From 07/01/93	234-3150	234-3090	234-3107	234-3090
L4-1.5	1993	Turbo; To 07/01/93	234-3101	234-3090	-	-
L4-1.5	1992-1991	Calif.	234-2002	234-2000	-	-
L4-1.5	1992-1991	Exc. Calif.	234-1018	234-1000	-	-
<b>SONATA</b>						
L4-2.0	2014-2012		234-5147	-	234-4551	-
L4-2.0	2011	From 11/15/2010	234-5147	-	234-4551	-
L4-2.0	2011	To 11/15/2010	234-5147	-	234-4448	-
L4-2.0	1998-1997	Calif.	234-4035	234-4210	234-4035	234-4210
L4-2.0	1998-1996	Exc. Calif.	234-4034	234-4210	234-4042	234-4210
L4-2.0	1996	Calif.; From 07/01/96	234-4035	234-4210	234-4035	234-4210
L4-2.0	1996	Calif.; To 07/01/96	234-4034	234-4210	234-4042	234-4210
L4-2.0	1995-1994	Calif.	234-4034	234-4210	234-4042	234-4210
L4-2.0	1995-1994	Exc. Calif.	234-4034	234-4210	-	-
L4-2.0	1993	Calif.	234-4131	234-4212	234-4042	234-4210
L4-2.0	1993	Exc. Calif.	234-4131	234-4212	-	-
L4-2.0	1992		234-4131	234-4212	-	-
L4-2.4	2014		234-5029	-	234-4238	-
L4-2.4	2013-2012	Gas Engine; Auto Trans; Calif.	234-5029	-	234-4551	-
L4-2.4	2013-2012	Gas Engine; Auto Trans; Exc. Calif.	234-5030	-	234-4551	-
L4-2.4	2013-2011	Hybrid Engine	234-5029	-	234-4238	-
L4-2.4	2012	Gas Engine; Manual Trans	234-5030	-	234-4551	-
L4-2.4	2011	Gas Engine; Auto Trans; Calif.	234-5029	-	234-4238	-
L4-2.4	2011	Gas Engine; Auto Trans; Exc. Calif.; From 03/21/2011	234-5030	-	234-4551	-
L4-2.4	2011	Gas Engine; Auto Trans; Exc. Calif.; To 03/21/2011	234-5030	-	234-4448	-
L4-2.4	2011	Gas Engine; Manual Trans; From 03/21/2011	234-5030	-	234-4551	-
L4-2.4	2011	Gas Engine; Manual Trans; To 03/21/2011	234-5030	-	234-4448	-
L4-2.4	2010-2009	Calif.	234-5029	-	234-4238	-
L4-2.4	2010-2009	Exc. Calif.	234-5081	-	234-4237	-

<sup>4</sup> Left Side / Côté gauche / Lado izquierdo <sup>5</sup> Right Side / Côté droit / Lado derecho



ENGINE MOTEUR MOTOR	YEAR ANNEE AÑO	APPLICATION INFORMATION INFORMATION D'APPLICATION INFORMACION DE APLICACION	UPSTREAM / AVANT - C.C. / ANTES DEL C.C.		DOWNSTREAM / APRES - C.C. / DESPUES DEL C.C.	
			TYPE / TIPO O.E.	UNIVERS.	TYPE / TIPO O.E.	UNIVERS.
<b>HYUNDAI [cont]</b>						
<b>SONATA [cont]</b>						
L4-2.4	2008-2006		234-4433	-	234-4439	-
L4-2.4	2005-1999	w/ Catalyst in Exhaust Pipe (Under Floor Plan)	234-4436	-	234-4042	234-4210
L4-2.4	2005-1999	w/ Close Coupled Catalyst (in Manifold)	234-4436	-	234-4434	-
L4-2.4	1991-1990	2 Lead Sensor	234-2002	234-2000	-	-
L4-2.4	1990	1 Lead Sensor	234-1007	234-1000	-	-
L4-2.4	1989	Calif.	234-2002	234-2000	-	-
L4-2.4	1989	Exc. Calif. & Canada	234-1007	234-1000	-	-
V6-2.5	2001-1999		234-4431 <sup>4</sup>	-	234-4431 <sup>4</sup>	-
V6-2.5	2001-1999		234-4431 <sup>5</sup>	-	234-4432 <sup>5</sup>	-
V6-2.7	2005-2003		234-4191 <sup>4</sup>	-	234-4193 <sup>4</sup>	-
V6-2.7	2005-2003		234-4191 <sup>5</sup>	-	234-4192 <sup>5</sup>	-
V6-2.7	2002	From 08/16/02	234-4191 <sup>4</sup>	-	234-4193 <sup>4</sup>	-
V6-2.7	2002	From 08/16/02	234-4191 <sup>5</sup>	-	234-4192 <sup>5</sup>	-
V6-2.7	2002	To 08/16/02	234-4431 <sup>4</sup>	-	234-4431 <sup>4</sup>	-
V6-2.7	2002	To 08/16/02	234-4431 <sup>5</sup>	-	234-4432 <sup>5</sup>	-
V6-3.0	1998-1996		234-4034	234-4210	234-4042	234-4210
V6-3.0	1995	Calif.	234-4034	234-4210	234-4042	234-4210
V6-3.0	1995	Exc. Calif.	234-4034	234-4210	-	-
V6-3.0	1994-1990		234-4644	234-4209	-	-
V6-3.3	2010-2006		234-4854 <sup>4</sup>	-	234-4854 <sup>4</sup>	-
V6-3.3	2010-2006		234-4854 <sup>5</sup>	-	234-4855 <sup>5</sup>	-
<b>TIBURON</b>						
L4-1.8	1997		234-4692	234-4201	234-4691	234-4201
L4-2.0	2008		234-4938	-	234-4851	-
L4-2.0	2007-2003		234-4852	-	234-4851	-
L4-2.0	2001-1998		234-4690	234-4201	234-4693	234-4201
L4-2.0	1997		234-4692	234-4201	234-4164	234-4201
V6-2.7	2008-2004		234-4191 <sup>4</sup>	-	234-4193 <sup>4</sup>	-
V6-2.7	2008-2004		234-4191 <sup>5</sup>	-	234-4192 <sup>5</sup>	-
V6-2.7	2003	From 01/03	234-4191 <sup>4</sup>	-	234-4193 <sup>4</sup>	-
V6-2.7	2003	From 01/03	234-4191 <sup>5</sup>	-	234-4192 <sup>5</sup>	-
V6-2.7	2003	To 01/03	234-4431 <sup>4</sup>	-	234-4193 <sup>4</sup>	-
V6-2.7	2003	To 01/03	234-4431 <sup>5</sup>	-	234-4432 <sup>5</sup>	-
<b>TUCSON</b>						
L4-2.0	2014		234-5029	-	234-4238	-
L4-2.0	2013-2011	Auto Trans; Calif.	234-5029	-	234-4238	-
L4-2.0	2013-2011	Auto Trans; Exc. Calif.	234-5044	-	234-4444	-
L4-2.0	2013-2011	Manual Trans	234-5044	-	234-4444	-
L4-2.0	2009-2005		234-4852	-	234-4851	-
L4-2.4	2014		234-5029	-	234-4238	-

<sup>4</sup> Left Side / Côté gauche / Lado izquierdo <sup>5</sup> Right Side / Côté droit / Lado derecho



ENGINE MOTEUR MOTOR	YEAR ANNEE AÑO	APPLICATION INFORMATION INFORMATION D'APPLICATION INFORMACION DE APLICACION	UPSTREAM / AVANT - C.C. / ANTES DEL C.C.		DOWNSTREAM / APRS - C.C. / DESPUES DEL C.C.		
			TYPE / TIPO O.E.	UNIVERS.	TYPE / TIPO O.E.	UNIVERS.	
<b>HYUNDAI [cont]</b>							
<b>TUCSON [cont]</b>							
L4-2.4	2013-2011	Calif.	234-5029	-	234-4238	-	
L4-2.4	2013-2011	Exc. Calif.	234-5044	-	234-4444	-	
L4-2.4	2010	Auto Trans; Calif.	234-5029	-	234-4238	-	
L4-2.4	2010	Auto Trans; Exc. Calif.	234-5044	-	234-4444	-	
L4-2.4	2010	Manual Trans	234-5044	-	234-4444	-	
V6-2.7	2009-2005		234-4193 <sup>4</sup>	-	234-4193 <sup>4</sup>	-	
V6-2.7	2009-2005		234-4191 <sup>5</sup>	-	234-4192 <sup>5</sup>	-	
<b>VELOSTER</b>							
L4-1.6	2014-2012		234-5055	-	234-4568	-	
<b>VERACRUZ</b>							
V6-3.8	2012-2007		234-4854 <sup>4</sup>	-	234-4854 <sup>4</sup>	-	
V6-3.8	2012-2007		234-4903 <sup>5</sup>	-	234-4856 <sup>5</sup>	-	
<b>XG300</b>							
V6-3.0	2001		234-4434 <sup>4</sup>	-	234-4434 <sup>4</sup>	-	
V6-3.0	2001		234-4435 <sup>5</sup>	-	234-4436 <sup>5</sup>	-	
<b>XG350</b>							
V6-3.5	2005-2004		234-4194 <sup>4</sup>	-	234-4199 <sup>4</sup>	234-4210 <sup>4</sup>	
V6-3.5	2005-2002		234-4194 <sup>5</sup>	-	234-4435 <sup>5</sup>	-	
V6-3.5	2003	From 02/03	234-4194 <sup>4</sup>	-	234-4199 <sup>4</sup>	234-4210 <sup>4</sup>	
V6-3.5	2003	To 02/03	234-4194 <sup>4</sup>	-	234-4434 <sup>4</sup>	-	
V6-3.5	2002		234-4194 <sup>4</sup>	-	234-4434 <sup>4</sup>	-	
<b>INFINITI</b>							
<b>EX35</b>							
V6-3.5	2012-2011		234-9135 <sup>1</sup>	-	234-4380 <sup>1</sup>	-	
V6-3.5	2010-2008		234-9036 <sup>1</sup>	-	234-4380 <sup>1</sup>	-	
<b>EX37</b>							
V6-3.7	2013		234-9135 <sup>1</sup>	-	234-4380 <sup>1</sup>	-	
<b>FX35</b>							
V6-3.5	2012		234-9135 <sup>1</sup>	-	234-4380 <sup>1</sup>	-	
V6-3.5	2011	From 11/2010	234-9135 <sup>1</sup>	-	234-4380 <sup>1</sup>	-	
V6-3.5	2011	To 11/2010	234-9036 <sup>1</sup>	-	234-4380 <sup>1</sup>	-	
V6-3.5	2010-2009		234-9036 <sup>1</sup>	-	234-4380 <sup>1</sup>	-	
V6-3.5	2008-2007		234-5061 <sup>1</sup>	-	234-4380 <sup>1</sup>	-	
V6-3.5	2006-2005		234-5061 <sup>4</sup>	-	234-4302 <sup>4</sup>	234-4210 <sup>4</sup>	
V6-3.5	2006-2005		234-5061 <sup>5</sup>	-	234-4312 <sup>5</sup>	234-4210 <sup>5</sup>	
V6-3.5	2004	From 10/03	234-5061 <sup>4</sup>	-	234-4302 <sup>4</sup>	234-4210 <sup>4</sup>	
V6-3.5	2004	From 10/03	234-5061 <sup>5</sup>	-	234-4312 <sup>5</sup>	234-4210 <sup>5</sup>	
V6-3.5	2004	To 10/03	234-4308 <sup>4</sup>	-	234-4302 <sup>4</sup>	234-4210 <sup>4</sup>	

<sup>1</sup> 2 Required / Requis 2 / Requeridos 2 <sup>4</sup> Left Side / Côté gauche / Lado izquierdo <sup>5</sup> Right Side / Côté droit / Lado derecho



ENGINE MOTEUR MOTOR	YEAR ANNEE AÑO	APPLICATION INFORMATION INFORMATION D'APPLICATION INFORMACION DE APLICACION	UPSTREAM / AVANT - C.C. / ANTES DEL C.C.		DOWNSTREAM / APRES - C.C. / DESPUES DEL C.C.	
			TYPE / TIPO O.E.	UNIVERS.	TYPE / TIPO O.E.	UNIVERS.
<b>INFINITI [cont]</b>						
<b>FX35 [cont]</b>						
V6-3.5	2004	To 10/03	234-4308 <sup>5</sup>	-	234-4312 <sup>5</sup>	234-4210 <sup>5</sup>
V6-3.5	2003		234-4308 <sup>4</sup>	-	234-4302 <sup>4</sup>	234-4210 <sup>4</sup>
V6-3.5	2003		234-4308 <sup>5</sup>	-	234-4312 <sup>5</sup>	234-4210 <sup>5</sup>
<b>FX37</b>						
V6-3.7	2013		234-9135 <sup>1</sup>	-	234-4380 <sup>1</sup>	-
<b>FX45</b>						
V8-4.5	2008-2006		234-5060 <sup>4</sup>	-	234-4302 <sup>4</sup>	234-4210 <sup>4</sup>
V8-4.5	2008-2006		234-5060 <sup>5</sup>	-	234-4312 <sup>5</sup>	234-4210 <sup>5</sup>
V8-4.5	2005-2003		234-4308 <sup>4</sup>	-	234-4302 <sup>4</sup>	234-4210 <sup>4</sup>
V8-4.5	2005-2003		234-4296 <sup>5</sup>	-	234-4312 <sup>5</sup>	234-4210 <sup>5</sup>
<b>FX50</b>						
V8-5.0	2013		234-9135 <sup>1</sup>	-	234-4380 <sup>1</sup>	-
V8-5.0	2012-2009		234-9079 <sup>1</sup>	-	234-4380 <sup>1</sup>	-
<b>G20</b>						
L4-2.0	2002		234-3113	234-3090	234-4302	234-4210
L4-2.0	2001-2000		234-3108	234-3090	234-4326	-
L4-2.0	1999		234-3089	234-3090	234-4716	234-4700
L4-2.0	1996-1994		234-3302	-	234-3123	-
L4-2.0	1993-1991		234-3302	-	-	-
<b>G25</b>						
V6-2.5	2012-2011		234-9104 <sup>1</sup>	-	234-4380 <sup>1</sup>	-
<b>G35</b>						
V6-3.5	2008		234-9036 <sup>1</sup>	-	234-4380 <sup>1</sup>	-
V6-3.5	2007	Coupe	234-5061 <sup>4</sup>	-	234-4302 <sup>4</sup>	234-4210 <sup>4</sup>
V6-3.5	2007	Coupe	234-5061 <sup>5</sup>	-	234-4312 <sup>5</sup>	234-4210 <sup>5</sup>
V6-3.5	2007	Sedan	234-9072 <sup>1</sup>	-	234-4380 <sup>1</sup>	-
V6-3.5	2006-2005		234-5061 <sup>4</sup>	-	234-4302 <sup>4</sup>	234-4210 <sup>4</sup>
V6-3.5	2006-2005		234-5061 <sup>5</sup>	-	234-4312 <sup>5</sup>	234-4210 <sup>5</sup>
V6-3.5	2004	AWD	234-5061 <sup>4</sup>	-	234-4302 <sup>4</sup>	234-4210 <sup>4</sup>
V6-3.5	2004	AWD	234-5061 <sup>5</sup>	-	234-4312 <sup>5</sup>	234-4210 <sup>5</sup>
V6-3.5	2004	RWD	234-4308 <sup>4</sup>	-	234-4302 <sup>4</sup>	234-4210 <sup>4</sup>
V6-3.5	2004	RWD	234-4308 <sup>5</sup>	-	234-4312 <sup>5</sup>	234-4210 <sup>5</sup>
V6-3.5	2003		234-4308 <sup>4</sup>	-	234-4302 <sup>4</sup>	234-4210 <sup>4</sup>
V6-3.5	2003		234-4308 <sup>5</sup>	-	234-4312 <sup>5</sup>	234-4210 <sup>5</sup>
<b>G37</b>						
V6-3.7	2013-2011		234-9135 <sup>1</sup>	-	234-4380 <sup>1</sup>	-
V6-3.7	2010-2009		234-9036 <sup>1</sup>	-	234-4380 <sup>1</sup>	-
V6-3.7	2008		234-9037 <sup>1</sup>	-	234-4380 <sup>1</sup>	-

<sup>1</sup> 2 Required / Requis 2 / Requeridos 2 <sup>4</sup> Left Side / Côté gauche / Lado izquierdo <sup>5</sup> Right Side / Côté droit / Lado derecho





ENGINE MOTEUR MOTOR	YEAR ANNEE AÑO	APPLICATION INFORMATION INFORMATION D'APPLICATION INFORMACION DE APLICACION	UPSTREAM / AVANT - C.C. / ANTES DEL C.C.		DOWNSTREAM / APRES - C.C. / DESPUES DEL C.C.	
			TYPE / TIPO O.E.	UNIVERS.	TYPE / TIPO O.E.	UNIVERS.
<b>INFINITI [cont]</b>						
<b>I30</b>						
V6-3.0	2001-2000		234-3109 <sup>15</sup>	234-3090 <sup>15</sup>	234-4777 <sup>15</sup>	234-4700 <sup>15</sup>
V6-3.0	2001-2000		234-3111 <sup>16</sup>	234-3090 <sup>16</sup>	234-4776 <sup>16</sup>	234-4700 <sup>16</sup>
V6-3.0	1999	Calif.	234-3095 <sup>4</sup>	234-3090 <sup>4</sup>	234-4777 <sup>4</sup>	234-4700 <sup>4</sup>
V6-3.0	1999	Calif.	234-3098 <sup>5</sup>	234-3090 <sup>5</sup>	234-4776 <sup>5</sup>	234-4700 <sup>5</sup>
V6-3.0	1999	Exc. Calif.	234-3098 <sup>1</sup>	234-3090 <sup>1</sup>	234-4716	234-4700
V6-3.0	1998-1997		234-3098 <sup>1</sup>	234-3090 <sup>1</sup>	234-4716	234-4700
V6-3.0	1996	From 07/96	234-3098 <sup>1</sup>	234-3090 <sup>1</sup>	234-4716	234-4700
V6-3.0	1996	To 07/96	234-3098 <sup>1</sup>	234-3090 <sup>1</sup>	234-3123	-
<b>I35</b>						
V6-3.5	2004-2002		234-3113 <sup>4</sup>	234-3090 <sup>4</sup>	234-4241 <sup>4</sup>	234-4700 <sup>4</sup>
V6-3.5	2004-2002		234-3113 <sup>5</sup>	234-3090 <sup>5</sup>	234-4270 <sup>5</sup>	234-4700 <sup>5</sup>
<b>J30</b>						
V6-3.0	1997-1996		234-3304 <sup>4</sup>	234-3090 <sup>4</sup>	234-4322 <sup>4</sup>	-
V6-3.0	1997-1996		234-3304 <sup>5</sup>	234-3090 <sup>5</sup>	234-4320 <sup>5</sup>	-
V6-3.0	1995-1993		234-3087 <sup>1</sup>	234-3090 <sup>1</sup>	-	-
<b>JX35</b>						
V6-3.5	2013		234-9135 <sup>4</sup>	-	234-4595 <sup>4</sup>	-
V6-3.5	2013		234-9135 <sup>5</sup>	-	234-4599 <sup>5</sup>	-
<b>M30</b>						
V6-3.0	1992-1990		234-3310	-	-	-
<b>M35</b>						
V6-3.5	2010-2009		234-9036 <sup>1</sup>	-	234-4380 <sup>1</sup>	-
V6-3.5	2008-2007		234-5061 <sup>1</sup>	-	234-4380 <sup>1</sup>	-
V6-3.5	2006		234-5061 <sup>4</sup>	-	234-4302 <sup>4</sup>	234-4210 <sup>4</sup>
V6-3.5	2006		234-5061 <sup>5</sup>	-	234-4312 <sup>5</sup>	234-4210 <sup>5</sup>
<b>M35H</b>						
V6-3.5	2013		234-9135 <sup>1</sup>	-	234-4380 <sup>1</sup>	-
V6-3.5	2012		234-9135 <sup>1</sup>	-	234-4534 <sup>1</sup>	-
<b>M37</b>						
V6-3.7	2013-2012		234-9135 <sup>1</sup>	-	234-4380 <sup>1</sup>	-
V6-3.7	2011	From 04/2011	234-9135 <sup>1</sup>	-	234-4380 <sup>1</sup>	-
V6-3.7	2011	To 04/2011	234-9036 <sup>1</sup>	-	234-4380 <sup>1</sup>	-
<b>M45</b>						
V8-4.5	2010-2006		234-5060 <sup>4</sup>	-	234-4302 <sup>4</sup>	234-4210 <sup>4</sup>
V8-4.5	2010-2006		234-5060 <sup>5</sup>	-	234-4312 <sup>5</sup>	234-4210 <sup>5</sup>
V8-4.5	2004-2003		234-4308 <sup>4</sup>	-	234-4301 <sup>4</sup>	234-4210 <sup>4</sup>
V8-4.5	2004-2003		234-4296 <sup>5</sup>	-	234-4312 <sup>5</sup>	234-4210 <sup>5</sup>

<sup>1</sup> 2 Required / Requis 2 / Requeridos 2 <sup>4</sup> Left Side / Côté gauche / Lado izquierdo <sup>5</sup> Right Side / Côté droit / Lado derecho <sup>15</sup> Front / Avant / Parte delantera <sup>16</sup> Rear / Arrière / Parte trasera



ENGINE MOTEUR MOTOR	YEAR ANNEE AÑO	APPLICATION INFORMATION INFORMATION D'APPLICATION INFORMACION DE APLICACION	UPSTREAM / AVANT - C.C. / ANTES DEL C.C.		DOWNSTREAM / APRS - C.C. / DESPUES DEL C.C.	
			TYPE / TIPO O.E.	UNIVERS.	TYPE / TIPO O.E.	UNIVERS.
<b>INFINITI [cont]</b>						
<b>M56</b>						
V8-5.6	2013-2011		234-5095 <sup>1</sup>	-	234-4380 <sup>1</sup>	-
<b>Q40</b>						
V6-3.7	2015		234-9148 <sup>1</sup>	-	234-4535 <sup>1</sup>	-
<b>Q45</b>						
V8-4.1	2001-1999		234-3087 <sup>1</sup>	234-3090 <sup>1</sup>	234-4325 <sup>1</sup>	-
V8-4.1	1998	From 01/98	234-3087 <sup>1</sup>	234-3090 <sup>1</sup>	234-4325	-
V8-4.1	1998	To 01/98	234-3087 <sup>4</sup>	234-3090 <sup>4</sup>	234-4325	-
V8-4.1	1998	To 01/98	234-3089 <sup>5</sup>	234-3090 <sup>5</sup>	-	-
V8-4.1	1997		234-3087 <sup>4</sup>	234-3090 <sup>4</sup>	234-4325	-
V8-4.1	1997		234-3089 <sup>5</sup>	234-3090 <sup>5</sup>	-	-
V8-4.5	2006	From 12/05	234-5060 <sup>4</sup>	-	234-4301 <sup>4</sup>	234-4210 <sup>4</sup>
V8-4.5	2006	From 12/05	234-5060 <sup>5</sup>	-	234-4312 <sup>5</sup>	234-4210 <sup>5</sup>
V8-4.5	2006	To 12/05	234-4308 <sup>4</sup>	-	234-4301 <sup>4</sup>	234-4210 <sup>4</sup>
V8-4.5	2006	To 12/05	234-4296 <sup>5</sup>	-	234-4312 <sup>5</sup>	234-4210 <sup>5</sup>
V8-4.5	2005-2002		234-4308 <sup>4</sup>	-	234-4301 <sup>4</sup>	234-4210 <sup>4</sup>
V8-4.5	2005-2002		234-4296 <sup>5</sup>	-	234-4312 <sup>5</sup>	234-4210 <sup>5</sup>
V8-4.5	1996		234-3087 <sup>4</sup>	234-3090 <sup>4</sup>	234-4321 <sup>4</sup>	-
V8-4.5	1996		234-3087 <sup>5</sup>	234-3090 <sup>5</sup>	234-4715 <sup>5</sup>	234-4700 <sup>5</sup>
V8-4.5	1995-1991		234-3087 <sup>1</sup>	234-3090 <sup>1</sup>	-	-
V8-4.5	1990		234-3302 <sup>5</sup>	-	-	-
V8-4.5	1990		234-3087 <sup>4</sup>	234-3090 <sup>4</sup>	-	-
<b>Q50</b>						
V6-3.5	2015-2014		234-9148 <sup>1</sup>	-	234-4534 <sup>1</sup>	-
V6-3.7	2015		234-9148 <sup>1</sup>	-	234-4535 <sup>1</sup>	-
V6-3.7	2014		234-9148 <sup>1</sup>	-	234-4534 <sup>1</sup>	-
<b>Q60</b>						
V6-3.7	2015		234-9148 <sup>1</sup>	-	234-4535 <sup>1</sup>	-
V6-3.7	2014		234-9135 <sup>1</sup>	-	234-4535 <sup>1</sup>	-
<b>Q70</b>						
V6-3.5	2015-2014		234-9148 <sup>1</sup>	-	234-4534 <sup>1</sup>	-
V6-3.7	2015-2014		234-9148 <sup>1</sup>	-	234-4535 <sup>1</sup>	-
V8-5.6	2015		234-9132 <sup>1</sup>	-	234-4380 <sup>1</sup>	-
V8-5.6	2014		234-5095 <sup>1</sup>	-	234-4380 <sup>1</sup>	-
<b>Q70L</b>						
V6-3.7	2015		234-9148 <sup>1</sup>	-	234-4535 <sup>1</sup>	-
V8-5.6	2015		234-9132 <sup>1</sup>	-	234-4380 <sup>1</sup>	-
<b>QX4</b>						
V6-3.3	2000-1997		234-3097 <sup>4</sup>	234-3090 <sup>4</sup>	234-4703 <sup>4</sup>	234-4700 <sup>4</sup>

<sup>1</sup> 2 Required / Requis 2 / Requeridos 2 <sup>4</sup> Left Side / Côté gauche / Lado izquierdo <sup>5</sup> Right Side / Côté droit / Lado derecho



ENGINE MOTEUR MOTOR	YEAR ANNEE AÑO	APPLICATION INFORMATION INFORMATION D'APPLICATION INFORMACION DE APLICACION	UPSTREAM / AVANT - C.C. / ANTES DEL C.C.		DOWNSTREAM / APRS - C.C. / DESPUES DEL C.C.	
			TYPE / TIPO O.E.	UNIVERS.	TYPE / TIPO O.E.	UNIVERS.
<b>INFINITI [cont]</b>						
<b>QX4 [cont]</b>						
V6-3.3	2000-1997		234-3087 <sup>5</sup>	234-3090 <sup>5</sup>	234-4704 <sup>5</sup>	234-4700 <sup>5</sup>
V6-3.5	2003-2002		234-3106 <sup>4</sup>	234-3090 <sup>4</sup>	234-4713 <sup>4</sup>	234-4700 <sup>4</sup>
V6-3.5	2003-2002		234-3305 <sup>5</sup>	234-3090 <sup>5</sup>	234-4713 <sup>5</sup>	234-4700 <sup>5</sup>
V6-3.5	2001		234-3306 <sup>4</sup>	234-3090 <sup>5</sup>	234-4327 <sup>4</sup>	-
V6-3.5	2001		234-3111 <sup>5</sup>	-	234-4776 <sup>5</sup>	234-4700 <sup>5</sup>
<b>QX50</b>						
V6-3.7	2015		234-9148 <sup>1</sup>	-	234-4535 <sup>1</sup>	-
V6-3.7	2014		234-9135 <sup>1</sup>	-	234-4380 <sup>1</sup>	-
<b>QX56</b>						
V8-5.6	2013-2011		234-5095 <sup>1</sup>	-	234-4381 <sup>1</sup>	-
V8-5.6	2010-2008		234-9038 <sup>1</sup>	-	234-4835 <sup>1</sup>	-
V8-5.6	2007		234-9072 <sup>1</sup>	-	234-4835 <sup>1</sup>	-
V8-5.6	2006-2004		234-5060 <sup>1</sup>	-	234-4835 <sup>1</sup>	-
<b>QX60</b>						
V6-3.5	2015		234-9148 <sup>4</sup>	-	234-4985 <sup>4</sup>	-
V6-3.5	2015		234-9148 <sup>5</sup>	-	234-4986 <sup>5</sup>	-
V6-3.5	2014		234-9135 <sup>4</sup>	-	234-4595 <sup>4</sup>	-
V6-3.5	2014		234-9135 <sup>5</sup>	-	234-4599 <sup>5</sup>	-
<b>QX70</b>						
V6-3.7	2015		234-9148 <sup>1</sup>	-	234-4535 <sup>1</sup>	-
V6-3.7	2014		234-9135 <sup>1</sup>	-	234-4380 <sup>1</sup>	-
V8-5.0	2014		234-9135 <sup>1</sup>	-	234-4380 <sup>1</sup>	-
<b>QX80</b>						
V8-5.6	2015		234-9148 <sup>1</sup>	-	234-4381 <sup>1</sup>	-
V8-5.6	2014		234-5095 <sup>1</sup>	-	234-4381 <sup>1</sup>	-
<b>ISUZU</b>						
<b>AMIGO</b>						
L4-2.2	2000-1998		234-4012	234-4000	234-4012	234-4000
L4-2.3	1993-1989		234-1001	234-1000	-	-
L4-2.6	1994-1993		234-3074	234-3090	-	-
L4-2.6	1992-1989		234-1001	234-1000	-	-
V6-3.2	2000-1998		234-4012 <sup>1</sup>	234-4000 <sup>1</sup>	234-4012 <sup>1</sup>	234-4000 <sup>1</sup>
<b>ASCENDER</b>						
L6-4.2	2008-2007		234-4331	-	234-4294	-
L6-4.2	2006		234-4331	-	234-4348	-
L6-4.2	2005-2004		234-4119	-	234-4285	-
L6-4.2	2003		234-4112	234-4209	234-4285	-
V8-5.3	2006	1st Design; Downstream O.E. # 8-12590750-0	234-4339 <sup>1</sup>	-	234-4294 <sup>1</sup>	-

<sup>1</sup> 2 Required / Requis 2 / Requeridos 2 <sup>4</sup> Left Side / Côté gauche / Lado izquierdo <sup>5</sup> Right Side / Côté droit / Lado derecho



ENGINE MOTEUR MOTOR	YEAR ANNEE AÑO	APPLICATION INFORMATION INFORMATION D'APPLICATION INFORMACION DE APLICACION	UPSTREAM / AVANT - C.C. / ANTES DEL C.C.		DOWNSTREAM / APRS - C.C. / DESPUES DEL C.C.	
			TYPE / TIPO O.E.	UNIVERS.	TYPE / TIPO O.E.	UNIVERS.
<b>ISUZU [cont]</b>						
<b>ASCENDER [cont]</b>						
V8-5.3	2006	2nd Design; Downstream O.E. # 8-12600893-0	234-4339 <sup>1</sup>	-	234-4561 <sup>1</sup>	-
V8-5.3	2005		234-4668 <sup>1</sup>	234-4212 <sup>1</sup>	234-4651 <sup>1</sup>	234-4209 <sup>1</sup>
V8-5.3	2004-2003		234-4650 <sup>1</sup>	234-4209 <sup>1</sup>	234-4647 <sup>1</sup>	234-4209 <sup>1</sup>
<b>AXIOM</b>						
V6-3.5	2004		234-4650 <sup>1</sup>	234-4209 <sup>1</sup>	234-4650 <sup>1</sup>	234-4209 <sup>1</sup>
V6-3.5	2003-2002		234-4063 <sup>1</sup>	234-4209 <sup>1</sup>	234-4063 <sup>1</sup>	234-4209 <sup>1</sup>
<b>HOMBRE</b>						
L4-2.2	2000-1999		234-1023	234-1000	234-4087	234-4000
L4-2.2	1998-1997		234-1001	234-1000	234-4087	234-4000
L4-2.2	1996		234-1001	234-1000	234-4012	234-4000
V6-4.3	2000-1997		234-4012 <sup>1</sup>	234-4000 <sup>1</sup>	234-4012 <sup>1</sup>	234-4000 <sup>1</sup>
<b>I-280</b>						
L4-2.8	2006		234-4331	-	234-4348	-
<b>I-290</b>						
L4-2.9	2008-2007		234-4331	-	234-4294	-
<b>I-350</b>						
L5-3.5	2006		234-4331	-	234-4348	-
<b>I-370</b>						
L5-3.7	2008-2007		234-4331	-	234-4294	-
<b>I-MARK</b>						
L4-1.5	1989-1985		234-1001	234-1000	-	-
L4-1.6	1989		234-1001	234-1000	-	-
L4-1.8	1985-1981		234-1001	234-1000	-	-
<b>IMPULSE</b>						
L4-1.6	1992-1990		234-3014	234-3000	-	-
L4-1.8	1992		234-4062	234-4209	-	-
L4-1.9	1987-1983		234-1001	234-1000	-	-
L4-2.0	1989-1985		234-1001	234-1000	-	-
L4-2.3	1989-1988		234-1001	234-1000	-	-
<b>OASIS</b>						
L4-2.2	1997-1996		234-4095	234-4209	234-4092	234-4209
L4-2.3	1999-1998		234-4095	234-4209	234-4092	234-4209
<b>PICKUP</b>						
L4-1.8	1982-1981		234-1001	234-1000	-	-
L4-1.9	1987-1983		234-1001	234-1000	-	-
L4-2.3	1995		234-3074	234-3090	-	-
L4-2.3	1994-1986		234-1001	234-1000	-	-
L4-2.6	1995-1994		234-3074	234-3090	-	-
L4-2.6	1993	From 10/92; 4WD	234-3074	234-3090	-	-
L4-2.6	1993	From 10/92; RWD	234-1001	234-1000	-	-

<sup>1</sup> 2 Required / Requis 2 / Requeridos 2



ENGINE MOTEUR MOTOR	YEAR ANNEE AÑO	APPLICATION INFORMATION INFORMATION D'APPLICATION INFORMACION DE APLICACION	UPSTREAM / AVANT - C.C. / ANTES DEL C.C.		DOWNSTREAM / APRS - C.C. / DESPUES DEL C.C.	
			TYPE / TIPO O.E.	UNIVERS.	TYPE / TIPO O.E.	UNIVERS.
<b>ISUZU [cont]</b>						
<b>PICKUP [cont]</b>						
L4-2.6	1993	To 09/92	234-1001	234-1000	-	-
L4-2.6	1992-1988		234-1001	234-1000	-	-
V6-3.1	1994-1991		234-1001	234-1000	-	-
<b>RODEO</b>						
L4-2.2	2003-1998		234-4012	234-4000	234-4012	234-4000
L4-2.6	1997-1996		234-4012	234-4000	234-4012	234-4000
L4-2.6	1995-1994		234-3074	234-3090	-	-
L4-2.6	1993	From 11/92	234-3074	234-3090	-	-
L4-2.6	1993	To 10/92	234-1001	234-1000	-	-
L4-2.6	1992-1991		234-1001	234-1000	-	-
V6-3.1	1992-1991		234-1001	234-1000	-	-
V6-3.2	2004-2002		234-4650 <sup>1</sup>	234-4209 <sup>1</sup>	234-4650 <sup>1</sup>	234-4209 <sup>1</sup>
V6-3.2	2001		234-4063 <sup>1</sup>	234-4209 <sup>1</sup>	234-4063 <sup>1</sup>	234-4209 <sup>1</sup>
V6-3.2	2000-1996		234-4012 <sup>1</sup>	234-4000 <sup>1</sup>	234-4012 <sup>1</sup>	234-4000 <sup>1</sup>
V6-3.2	1995-1993		234-4062	234-4209	-	-
V6-3.5	2004		234-4650 <sup>1</sup>	234-4209 <sup>1</sup>	234-4650 <sup>1</sup>	234-4209 <sup>1</sup>
<b>RODEO SPORT</b>						
L4-2.2	2003-2001		234-4012	234-4000	234-4012	234-4000
V6-3.2	2003-2002		234-4650 <sup>1</sup>	234-4209 <sup>1</sup>	234-4650 <sup>1</sup>	234-4209 <sup>1</sup>
V6-3.2	2001		234-4063 <sup>1</sup>	234-4209 <sup>1</sup>	234-4063 <sup>1</sup>	234-4209 <sup>1</sup>
<b>STYLUS</b>						
L4-1.6	1993-1992		234-1001	234-1000	-	-
L4-1.6	1991	DOHC; VIN 5	234-3014	234-3000	-	-
L4-1.6	1991	SOHC; VIN 6	234-1001	234-1000	-	-
L4-1.8	1992		234-4062	234-4209	-	-
<b>TROOPER</b>						
L4-1.9	1985-1984		234-1001	234-1000	-	-
L4-2.3	1987-1986		234-1001	234-1000	-	-
L4-2.6	1991-1988		234-1001	234-1000	-	-
V6-2.8	1991-1989		234-1001	234-1000	-	-
V6-3.2	1997-1996		234-4012 <sup>1</sup>	234-4000 <sup>1</sup>	234-4012 <sup>1</sup>	234-4000 <sup>1</sup>
V6-3.2	1995-1992		234-4062	234-4209	-	-
V6-3.5	2002-2000		234-4063 <sup>1</sup>	234-4209 <sup>1</sup>	234-4063 <sup>1</sup>	234-4209 <sup>1</sup>
V6-3.5	1999-1998		234-4012 <sup>1</sup>	234-4000 <sup>1</sup>	234-4012 <sup>1</sup>	234-4000 <sup>1</sup>
<b>VEHICROSS</b>						
V6-3.5	2001-1999		234-4012 <sup>1</sup>	234-4000 <sup>1</sup>	234-4012 <sup>1</sup>	234-4000 <sup>1</sup>
<b>JAGUAR</b>						
<b>F-TYPE</b>						
V6-3.0	2015-2014		234-5153 <sup>1</sup>	-	234-4794 <sup>1</sup>	-

<sup>1</sup> 2 Required / Requis 2 / Requeridos 2 <sup>12</sup> Loc. Center / Empl. central / Ubicación central



ENGINE MOTEUR MOTOR	YEAR ANNEE AÑO	APPLICATION INFORMATION INFORMATION D'APPLICATION INFORMACION DE APLICACION	UPSTREAM / AVANT - C.C. / ANTES DEL C.C.		DOWNSTREAM / APRS - C.C. / DESPUES DEL C.C.	
			TYPE / TIPO O.E.	UNIVERS.	TYPE / TIPO O.E.	UNIVERS.
<b>JAGUAR [cont]</b>						
<b>F-TYPE [cont]</b>						
V6-3.0	2015-2014	Loc. Center	-	-	234-4791 <sup>1,12</sup>	-
V8-5.0	2015-2014		234-5153 <sup>1</sup>	-	234-4794 <sup>1</sup>	-
V8-5.0	2015-2014	Loc. Center	-	-	234-4791 <sup>1,12</sup>	-
<b>S-TYPE</b>						
V6-3.0	2008-2006		234-9125 <sup>1</sup>	-	234-4951 <sup>1</sup>	-
V6-3.0	2005-2003		234-9030 <sup>1</sup>	-	234-4798 <sup>1</sup>	-
V6-3.0	2002-2001		234-4046 <sup>1</sup>	-	234-4001 <sup>1</sup>	234-4212 <sup>1</sup>
V6-3.0	2000		234-4046 <sup>1</sup>	-	234-4609 <sup>1</sup>	234-4210 <sup>1</sup>
V8-4.0	2002-2000		234-4046 <sup>1</sup>	-	234-4071 <sup>1</sup>	234-4212 <sup>1</sup>
V8-4.2	2008-2006		234-9125 <sup>1</sup>	-	234-4951 <sup>1</sup>	-
V8-4.2	2005-2003		234-9030 <sup>1</sup>	-	234-4798 <sup>1</sup>	-
<b>SUPER V8</b>						
V8-4.2	2009-2006		234-9125 <sup>1</sup>	-	234-4951 <sup>1</sup>	-
V8-4.2	2005		234-9030 <sup>1</sup>	-	234-4798 <sup>1</sup>	-
<b>VANDEN PLAS</b>						
L6-3.6	1989-1988		234-3048	234-3000	-	-
L6-4.0	1997-1995		234-4953 <sup>1</sup>	-	234-4953 <sup>1</sup>	-
L6-4.0	1994		234-3019	234-3090	-	-
L6-4.0	1993	From Chassis #190528	234-3019	234-3090	-	-
L6-4.0	1993	To Chassis #190527	234-3048	234-3000	-	-
L6-4.0	1992		234-3019	234-3090	-	-
L6-4.0	1991-1990		234-3048	234-3000	-	-
L6-4.2	1987-1986	1 Lead Sensor	234-1013	234-1000	-	-
L6-4.2	1987-1986	3 Lead Sensor	234-3048	234-3000	-	-
L6-4.2	1985-1982		234-1013	234-1000	-	-
V8-4.0	2003-1999		234-9016 <sup>1</sup>	-	234-4798 <sup>1</sup>	-
V8-4.0	1998		234-4720 <sup>1</sup>	-	234-2038 <sup>1</sup>	-
V8-4.2	2009-2006		234-9125 <sup>1</sup>	-	234-4951 <sup>1</sup>	-
V8-4.2	2005-2004		234-9030 <sup>1</sup>	-	234-4798 <sup>1</sup>	-
<b>XF</b>						
L4-2.0	2014-2013		234-5155	-	234-4793	-
V6-3.0	2015-2013	RWD	234-5153 <sup>1</sup>	-	234-4794 <sup>1</sup>	-
V6-3.0	2015-2013	RWD; Loc. Center	-	-	234-4791 <sup>1</sup>	-
V6-3.0	2015	AWD	234-5154 <sup>4</sup>	-	234-4792 <sup>4</sup>	-
V6-3.0	2015	AWD	234-5154 <sup>5</sup>	-	234-4794 <sup>5</sup>	-
V6-3.0	2015	AWD; Loc. Center	-	-	234-4792 <sup>4</sup>	-
V6-3.0	2015	AWD; Loc. Center	-	-	234-4794 <sup>5</sup>	-
V6-3.0	2014-2013	AWD	234-5154 <sup>1</sup>	-	234-4792 <sup>1</sup>	-
V6-3.0	2014-2013	AWD; Loc. Center	-	-	234-4794 <sup>1</sup>	-

<sup>1</sup> 2 Required / Requis 2 / Requeridos 2 <sup>4</sup> Left Side / Côté gauche / Lado izquierdo <sup>5</sup> Right Side / Côté droit / Lado derecho <sup>12</sup> Loc. Center / Empl. central / Ubicación central



ENGINE MOTEUR MOTOR	YEAR ANNEE AÑO	APPLICATION INFORMATION INFORMATION D'APPLICATION INFORMACION DE APLICACION	UPSTREAM / AVANT - C.C. / ANTES DEL C.C.		DOWNSTREAM / APRS - C.C. / DESPUES DEL C.C.	
			TYPE / TIPO O.E.	UNIVERS.	TYPE / TIPO O.E.	UNIVERS.
<b>JAGUAR [cont]</b>						
<b>XF [cont]</b>						
V8-4.2	2010-2009		234-9125 <sup>1</sup>	-	234-4951 <sup>1</sup>	-
V8-5.0	2014-2013		234-5153 <sup>1</sup>	-	234-4794 <sup>1</sup>	-
V8-5.0	2014-2013	Loc. Center	-	-	234-4791 <sup>1</sup>	-
V8-5.0	2012		234-9094 <sup>1</sup>	-	234-4450 <sup>1</sup>	-
V8-5.0	2011	From Chassis/Vin R47154	234-9094 <sup>1</sup>	-	234-4450 <sup>1</sup>	-
V8-5.0	2011	To Chassis/Vin R47153	234-9125 <sup>1</sup>	-	234-4951 <sup>1</sup>	-
V8-5.0	2010		234-9125 <sup>1</sup>	-	234-4951 <sup>1</sup>	-
<b>XFR</b>						
V8-5.0	2014-2013		234-5153 <sup>1</sup>	-	234-4794 <sup>1</sup>	-
V8-5.0	2014-2013	Loc. Center	-	-	234-4791 <sup>1</sup>	-
V8-5.0	2012		234-9094 <sup>1</sup>	-	234-4450 <sup>1</sup>	-
V8-5.0	2011	From Chassis/Vin R47154	234-9094 <sup>1</sup>	-	234-4450 <sup>1</sup>	-
V8-5.0	2011	To Chassis/Vin R47153	234-9125 <sup>1</sup>	-	234-4951 <sup>1</sup>	-
V8-5.0	2010		234-9125 <sup>1</sup>	-	234-4951 <sup>1</sup>	-
<b>XFR-S</b>						
V8-5.0	2014-2013		234-5153 <sup>1</sup>	-	234-4794 <sup>1</sup>	-
V8-5.0	2014-2013	Loc. Center	-	-	234-4791 <sup>1</sup>	-
<b>XJ</b>						
V6-3.0	2014-2013	AWD	234-5154 <sup>1</sup>	-	234-4792 <sup>1</sup>	-
V6-3.0	2014-2013	AWD; Loc. Center	-	-	234-4794 <sup>1</sup>	-
V6-3.0	2014-2013	RWD	234-5153 <sup>1</sup>	-	234-4794 <sup>1</sup>	-
V6-3.0	2014-2013	RWD; Loc. Center	-	-	234-4791 <sup>1</sup>	-
V8-5.0	2014		234-5153 <sup>1</sup>	-	234-4794 <sup>1</sup>	-
V8-5.0	2014	Loc. Center	-	-	234-4791 <sup>1</sup>	-
V8-5.0	2013	Non-Turbo	234-9094 <sup>1</sup>	-	234-4450 <sup>1</sup>	-
V8-5.0	2013	Supercharged	234-5153 <sup>1</sup>	-	234-4794 <sup>1</sup>	-
V8-5.0	2013	Supercharged; Loc. Center	-	-	234-4791 <sup>1</sup>	-
V8-5.0	2012-2010		234-9094 <sup>1</sup>	-	234-4450 <sup>1</sup>	-
<b>XJ6</b>						
L6-3.6	1989-1987		234-3048	234-3000	-	-
L6-4.0	1997-1995		234-4953 <sup>1</sup>	-	234-4953 <sup>1</sup>	-
L6-4.0	1994		234-3019	234-3090	-	-
L6-4.0	1993	From Chassis #190528	234-3019	234-3090	-	-
L6-4.0	1993	To Chassis #190527	234-3048	234-3000	-	-
L6-4.0	1992		234-3019	234-3090	-	-
L6-4.0	1991-1990		234-3048	234-3000	-	-
L6-4.2	1987-1986	1 Lead Sensor	234-1013	234-1000	-	-
L6-4.2	1987-1986	3 Lead Sensor	234-3048	234-3000	-	-
L6-4.2	1985-1979		234-1013	234-1000	-	-

<sup>1</sup> 2 Required / Requis 2 / Requeridos 2



ENGINE MOTEUR MOTOR	YEAR ANNEE AÑO	APPLICATION INFORMATION INFORMATION D'APPLICATION INFORMACION DE APLICACION	UPSTREAM / AVANT - C.C. / ANTES DEL C.C.		DOWNSTREAM / APRS - C.C. / DESPUES DEL C.C.	
			TYPE / TIPO O.E.	UNIVERS.	TYPE / TIPO O.E.	UNIVERS.
<b>JAGUAR [cont]</b>						
<b>XJ8</b>						
V8-4.0	2003-1999		234-9016 <sup>1</sup>	-	234-4798 <sup>1</sup>	-
V8-4.0	1998		234-4720 <sup>1</sup>	-	234-2038 <sup>1</sup>	-
V8-4.2	2009-2006		234-9125 <sup>1</sup>	-	234-4951 <sup>1</sup>	-
V8-4.2	2005-2004		234-9030 <sup>1</sup>	-	234-4798 <sup>1</sup>	-
<b>XJ12</b>						
V12-5.3	1992-1981		234-3048	234-3000	-	-
V12-6.0	1996-1995		234-4048 <sup>1</sup>	234-4209 <sup>1</sup>	234-4950 <sup>1</sup>	-
V12-6.0	1994		234-3019 <sup>1</sup>	234-3090 <sup>1</sup>	-	-
<b>XJR</b>						
L6-4.0	1997-1995		234-4953 <sup>1</sup>	-	234-4953 <sup>1</sup>	-
V8-4.0	2003-1999		234-9016 <sup>1</sup>	-	234-4798 <sup>1</sup>	-
V8-4.0	1998		234-4720 <sup>1</sup>	-	234-2038 <sup>1</sup>	-
V8-4.2	2009-2006		234-9125 <sup>1</sup>	-	234-4951 <sup>1</sup>	-
V8-4.2	2005-2004		234-9030 <sup>1</sup>	-	234-4798 <sup>1</sup>	-
V8-5.0	2014		234-5153 <sup>1</sup>	-	234-4794 <sup>1</sup>	-
V8-5.0	2014	Loc. Center	-	-	234-4791 <sup>1</sup>	-
<b>XJRS</b>						
V12-6.0	1993		234-3019	234-3090	-	-
<b>XJS</b>						
L6-4.0	1996		234-4953 <sup>1</sup>	-	234-4953 <sup>1</sup>	-
L6-4.0	1995	From Chassis #195696	234-4953 <sup>1</sup>	-	234-4953 <sup>1</sup>	-
L6-4.0	1995	To Chassis #195695	234-4953 <sup>1</sup>	-	-	-
L6-4.0	1994		234-3019	234-3090	-	-
L6-4.0	1993	From Chassis #190528	234-3019	234-3090	-	-
L6-4.0	1993	To Chassis #190527	234-3048	234-3000	-	-
L6-4.0	1992		234-3019	234-3090	-	-
V12-5.3	1992-1980		234-3048	234-3000	-	-
V12-6.0	1995		234-4048 <sup>1</sup>	234-4209 <sup>1</sup>	234-4950 <sup>1</sup>	-
V12-6.0	1994		234-3019 <sup>1</sup>	234-3090 <sup>1</sup>	-	-
<b>XK</b>						
V8-4.2	2009-2007		234-9125 <sup>1</sup>	-	234-4951 <sup>1</sup>	-
V8-5.0	2015-2010		234-9094 <sup>1</sup>	-	234-4450 <sup>1</sup>	-
<b>XK8</b>						
V8-4.0	2002-2000		234-9016 <sup>1</sup>	-	234-4798 <sup>1</sup>	-
V8-4.0	1999-1997		234-4720 <sup>1</sup>	-	234-2038 <sup>1</sup>	-
V8-4.2	2006		234-9125 <sup>1</sup>	-	234-4951 <sup>1</sup>	-
V8-4.2	2005-2003		234-9029 <sup>1</sup>	-	234-4798 <sup>1</sup>	-

<sup>1</sup> 2 Required / Requis 2 / Requeridos 2





ENGINE MOTEUR MOTOR	YEAR ANNEE AÑO	APPLICATION INFORMATION INFORMATION D'APPLICATION INFORMACION DE APLICACION	UPSTREAM / AVANT - C.C. / ANTES DEL C.C.		DOWNSTREAM / APRS - C.C. / DESPUES DEL C.C.	
			TYPE / TIPO O.E.	UNIVERS.	TYPE / TIPO O.E.	UNIVERS.
<b>JAGUAR [cont]</b>						
<b>XKR</b>						
V8-4.0	2002-2000		234-9016 <sup>1</sup>	-	234-4798 <sup>1</sup>	-
V8-4.2	2009-2006		234-9125 <sup>1</sup>	-	234-4951 <sup>1</sup>	-
V8-4.2	2005-2003		234-9029 <sup>1</sup>	-	234-4798 <sup>1</sup>	-
V8-5.0	2015-2010		234-9094 <sup>1</sup>	-	234-4450 <sup>1</sup>	-
<b>XKR-S</b>						
V8-5.0	2015-2012		234-9094 <sup>1</sup>	-	234-4450 <sup>1</sup>	-
<b>X-TYPE</b>						
V6-2.5	2005-2002		234-9029 <sup>1</sup>	-	234-4798 <sup>1</sup>	-
V6-3.0	2008-2002		234-9029 <sup>1</sup>	-	234-4798 <sup>1</sup>	-
<b>JEEP</b>						
<b>CHEROKEE</b>						
L4-2.4	2015-2014		234-5150	-	234-4545	-
L4-2.5	2000-1997		234-4077	234-4210	234-4078	234-4210
L4-2.5	1996		234-4004	234-4210	234-4078	234-4210
L4-2.5	1995-1991		234-4004	234-4210	-	-
L4-2.5	1990-1987		234-3005	234-3000	-	-
L4-2.5	1986-1984		234-1003	234-1000	-	-
L6-4.0	2001		234-4076 <sup>15</sup>	234-4210 <sup>15</sup>	234-4008 <sup>15</sup>	234-4210 <sup>15</sup>
L6-4.0	2001		234-4077 <sup>16</sup>	234-4210 <sup>16</sup>	234-4078 <sup>16</sup>	234-4210 <sup>16</sup>
L6-4.0	2000	Calif.	234-4076 <sup>15</sup>	234-4210 <sup>15</sup>	234-4008 <sup>15</sup>	234-4210 <sup>15</sup>
L6-4.0	2000	Calif.	234-4077 <sup>16</sup>	234-4210 <sup>16</sup>	234-4078 <sup>16</sup>	234-4210 <sup>16</sup>
L6-4.0	2000	Exc. Calif.	234-4077	234-4210	234-4078	234-4210
L6-4.0	1999-1996		234-4076	234-4210	234-4078	234-4210
L6-4.0	1995-1991		234-4003	234-4210	-	-
L6-4.2	1983-1981		234-1003	234-1000	-	-
L6-4.2	1980		234-2007	234-2000	-	-
V6-2.8	1986-1984		234-1001	234-1000	-	-
V6-3.2	2015-2014		234-4547 <sup>4</sup>	-	234-4545 <sup>4</sup>	-
V6-3.2	2015-2014		234-4545 <sup>5</sup>	-	234-4545 <sup>5</sup>	-
V8-5.9	1983-1981		234-1003	234-1000	-	-
<b>CJ5</b>						
L4-2.5	1983		234-1003	234-1000	-	-
L4-2.5	1982-1980		234-2007	234-2000	-	-
L6-4.2	1983-1981		234-1003	234-1000	-	-
L6-4.2	1980		234-2007	234-2000	-	-
<b>CJ7</b>						
L4-2.5	1986-1983		234-1003	234-1000	-	-
L4-2.5	1982-1980		234-2007	234-2000	-	-

<sup>1</sup> 2 Required / Requis 2 / Requeridos 2 <sup>4</sup> Left Side / Côté gauche / Lado izquierdo <sup>5</sup> Right Side / Côté droit / Lado derecho <sup>15</sup> Front / Avant / Parte delantera <sup>16</sup> Rear / Arrière / Parte trasera



ENGINE MOTEUR MOTOR	YEAR ANNEE AÑO	APPLICATION INFORMATION INFORMATION D'APPLICATION INFORMACION DE APLICACION	UPSTREAM / AVANT - C.C. / ANTES DEL C.C.		DOWNSTREAM / APRS - C.C. / DESPUES DEL C.C.	
			TYPE / TIPO O.E.	UNIVERS.	TYPE / TIPO O.E.	UNIVERS.
<b>JEEP [cont]</b>						
<b>CJ7 [cont]</b>						
L6-4.2	1986-1981		234-1003	234-1000	-	-
L6-4.2	1980		234-2007	234-2000	-	-
<b>COMANCHE</b>						
L4-2.5	1992-1991		234-4004	234-4210	-	-
L4-2.5	1990-1986		234-3005	234-3000	-	-
L6-4.0	1992-1991		234-4003	234-4210	-	-
V6-2.8	1986		234-1001	234-1000	-	-
<b>COMMANDER</b>						
V6-3.7	2010-2007		234-4587 <sup>1</sup>	-	234-4587 <sup>1</sup>	-
V6-3.7	2006		234-4593 <sup>1</sup>	-	234-4587 <sup>1</sup>	-
V8-4.7	2009-2008		234-4587 <sup>1</sup>	-	234-4587 <sup>1</sup>	-
V8-4.7	2007-2006		234-4744 <sup>1</sup>	234-4212 <sup>1</sup>	234-4744 <sup>1</sup>	234-4212 <sup>1</sup>
V8-5.7	2010-2007		234-4587 <sup>1</sup>	-	234-4587 <sup>1</sup>	-
V8-5.7	2006		234-4593 <sup>1</sup>	-	234-4587 <sup>1</sup>	-
<b>COMPASS</b>						
L4-2.0	2015-2011		234-4547	-	234-4547	-
L4-2.0	2010-2007		234-4881	-	234-4881	-
L4-2.4	2015-2011		234-4547	-	234-4547	-
L4-2.4	2010-2007		234-4881	-	234-4881	-
<b>GRAND CHEROKEE</b>						
L6-4.0	2004		234-4588 <sup>15</sup>	-	234-4767 <sup>15</sup>	234-4210 <sup>15</sup>
L6-4.0	2004		234-4587 <sup>16</sup>	-	234-4768 <sup>16</sup>	234-4210 <sup>16</sup>
L6-4.0	2003-2001		234-4769 <sup>15</sup>	234-4210 <sup>15</sup>	234-4029 <sup>15</sup>	234-4210 <sup>15</sup>
L6-4.0	2003-2001		234-4030 <sup>16</sup>	234-4210 <sup>16</sup>	234-4768 <sup>16</sup>	234-4210 <sup>16</sup>
L6-4.0	2000-1999	Calif.; Upstream OE #56041676AA; Downstream OE #56041212AE	234-4115	-	234-4076	234-4210
L6-4.0	2000-1999	Calif.; Upstream OE #56041676AA; Downstream OE #56041212AF	234-4115	-	234-4079	234-4210
L6-4.0	2000-1999	Exc. Calif.	234-4115	-	234-4078	234-4210
L6-4.0	2000	Calif.; Upstream OE #56041212AE; Downstream OE #56041212AE	234-4076	234-4210	234-4076	234-4210
L6-4.0	2000	Calif.; Upstream OE #56041212AE; Downstream OE #56041212AF	234-4076	234-4210	234-4079	234-4210
L6-4.0	1999	Calif.; Upstream OE #56041213AF; Downstream OE #56041212AE	234-4077	234-4210	234-4076	234-4210
L6-4.0	1999	Calif.; Upstream OE #56041213AF; Downstream OE #56041212AF	234-4077	234-4210	234-4079	234-4210
L6-4.0	1998-1996		234-4076	234-4210	234-4078	234-4210
L6-4.0	1995-1994		234-4003	234-4210	234-4078	234-4210
L6-4.0	1993		234-4003	234-4210	-	-
V6-3.6	2015		234-4547 <sup>4</sup>	-	234-4547 <sup>1</sup>	-
V6-3.6	2014-2012		234-4545 <sup>5</sup>	-	234-4545 <sup>5</sup>	-
V6-3.6	2014		234-4547 <sup>4</sup>	-	234-4547 <sup>4</sup>	-
V6-3.6	2013-2012		234-4547 <sup>4</sup>	-	234-4545 <sup>4</sup>	-
V6-3.6	2011		234-4545 <sup>1</sup>	-	234-4545 <sup>1</sup>	-
V6-3.7	2010-2007		234-4587 <sup>1</sup>	-	234-4587 <sup>1</sup>	-

<sup>1</sup> 2 Required / Requis 2 / Requeridos 2 <sup>4</sup> Left Side / Côté gauche / Lado izquierdo <sup>5</sup> Right Side / Côté droit / Lado derecho <sup>15</sup> Front / Avant / Parte delantera <sup>16</sup> Rear / Arrière / Parte trasera



ENGINE MOTEUR MOTOR	YEAR ANNEE AÑO	APPLICATION INFORMATION INFORMATION D'APPLICATION INFORMACION DE APLICACION	UPSTREAM / AVANT - C.C. / ANTES DEL C.C.		DOWNSTREAM / APRS - C.C. / DESPUES DEL C.C.	
			TYPE / TIPO O.E.	UNIVERS.	TYPE / TIPO O.E.	UNIVERS.
<b>JEEP [cont]</b>						
<b>GRAND CHEROKEE [cont]</b>						
V6-3.7	2006-2005		234-4593 <sup>1</sup>	-	234-4587 <sup>1</sup>	-
V8-4.7	2009-2008		234-4587 <sup>1</sup>	-	234-4587 <sup>1</sup>	-
V8-4.7	2007-2005		234-4744 <sup>1</sup>	234-4212 <sup>1</sup>	234-4744 <sup>1</sup>	234-4212 <sup>1</sup>
V8-4.7	2004-2001		234-4654 <sup>4</sup>	234-4209 <sup>4</sup>	234-4747 <sup>4</sup>	234-4209 <sup>4</sup>
V8-4.7	2004-2001		234-4653 <sup>5</sup>	234-4209 <sup>5</sup>	234-4746 <sup>5</sup>	234-4209 <sup>5</sup>
V8-4.7	2000-1999	Calif.; Upstream OE #56028232AA; Downstream OE #56028235AA	234-4635	234-4209	234-4602	234-4209
V8-4.7	2000-1999	Calif.; Upstream OE #56028232AA; Downstream OE #56041344AD	234-4635	234-4209	234-4078	234-4210
V8-4.7	2000-1999	Calif.; Upstream OE #56028232AA; Downstream OE #56041345AD	234-4635	234-4209	234-4602	234-4209
V8-4.7	2000-1999	Calif.; Upstream OE #56028233AA; Downstream OE #56028235AA	234-4634	234-4209	234-4602	234-4209
V8-4.7	2000-1999	Calif.; Upstream OE #56028233AA; Downstream OE #56041344AD	234-4634	234-4209	234-4078	234-4210
V8-4.7	2000-1999	Calif.; Upstream OE #56028233AA; Downstream OE #56041345AD	234-4634	234-4209	234-4602	234-4209
V8-4.7	2000-1999	Exc. Calif.; Downstream Sensor #56041344AD	234-4634	234-4209	234-4078	234-4210
V8-4.7	2000-1999	Exc. Calif.; Downstream Sensor #56041345AD	234-4634	234-4209	234-4602	234-4209
V8-5.2	1998-1996		234-4077	234-4210	234-4078	234-4210
V8-5.2	1995-1994		234-4003	234-4210	234-4003	234-4210
V8-5.2	1993		234-4003	234-4210	-	-
V8-5.7	2015-2012		234-4545 <sup>1</sup>	-	234-4545 <sup>1</sup>	-
V8-5.7	2011		234-4417 <sup>1</sup>	-	234-4417 <sup>1</sup>	-
V8-5.7	2010-2007		234-4587 <sup>1</sup>	-	234-4587 <sup>1</sup>	-
V8-5.7	2006-2005		234-4593 <sup>1</sup>	-	234-4587 <sup>1</sup>	-
V8-5.9	1998		234-4077	234-4210	234-4078	234-4210
V8-6.1	2010-2007		234-4587 <sup>1</sup>	-	234-4587 <sup>1</sup>	-
V8-6.1	2006		234-4593 <sup>1</sup>	-	234-4587 <sup>1</sup>	-
V8-6.4	2015-2014		234-4547 <sup>4</sup>	-	234-4545 <sup>4</sup>	-
V8-6.4	2015-2014		234-4547 <sup>5</sup>	-	234-4547 <sup>5</sup>	-
V8-6.4	2013-2012		234-4547 <sup>1</sup>	-	234-4547 <sup>1</sup>	-
<b>GRAND WAGONEER</b>						
L6-4.2	1986-1984		234-1003	234-1000	-	-
V8-5.2	1993		234-4003	234-4210	-	-
V8-5.9	1991-1987		234-1001	234-1000	-	-
V8-5.9	1986-1984		234-1003	234-1000	-	-
<b>J10</b>						
L6-4.2	1987		234-1001	234-1000	-	-
L6-4.2	1986-1981		234-1003	234-1000	-	-
L6-4.2	1980		234-2007	234-2000	-	-
V8-5.9	1988-1987		234-1001	234-1000	-	-
V8-5.9	1986-1981		234-1003	234-1000	-	-
<b>J20</b>						
V8-5.9	1988-1987		234-1001	234-1000	-	-
V8-5.9	1986-1981		234-1003	234-1000	-	-

<sup>1</sup> 2 Required / Requis 2 / Requeridos 2 <sup>4</sup> Left Side / Côté gauche / Lado izquierdo <sup>5</sup> Right Side / Côté droit / Lado derecho



ENGINE MOTEUR MOTOR	YEAR ANNEE AÑO	APPLICATION INFORMATION INFORMATION D'APPLICATION INFORMACION DE APLICACION	UPSTREAM / AVANT - C.C. / ANTES DEL C.C.		DOWNSTREAM / APRES - C.C. / DESPUES DEL C.C.	
			TYPE / TIPO O.E.	UNIVERS.	TYPE / TIPO O.E.	UNIVERS.
<b>JEEP [cont]</b>						
<b>LIBERTY</b>						
L4-2.4	2005		234-4587	-	234-4587	-
L4-2.4	2004		234-4587	-	234-4588	-
L4-2.4	2003-2002		234-4030	234-4210	234-4772	234-4210
V6-3.7	2012-2007		234-4587 <sup>1</sup>	-	234-4587 <sup>1</sup>	-
V6-3.7	2006-2005		234-4593 <sup>1</sup>	-	234-4587 <sup>1</sup>	-
V6-3.7	2004		234-4587 <sup>1</sup>	-	234-4771 <sup>1</sup>	234-4210 <sup>1</sup>
V6-3.7	2003-2002		234-4217 <sup>4</sup>	234-4210 <sup>4</sup>	234-4772 <sup>4</sup>	234-4210 <sup>4</sup>
V6-3.7	2003-2002		234-4228 <sup>5</sup>	234-4210 <sup>5</sup>	234-4029 <sup>5</sup>	234-4210 <sup>5</sup>
<b>PATRIOT</b>						
L4-2.0	2015-2011		234-4547	-	234-4547	-
L4-2.0	2010-2007		234-4881	-	234-4881	-
L4-2.4	2015-2011		234-4547	-	234-4547	-
L4-2.4	2010-2007		234-4881	-	234-4881	-
<b>RENEGADE</b>						
L4-2.4	2015		234-5150	-	234-4545	-
<b>SCRAMBLER</b>						
L4-2.5	1985-1983		234-1003	234-1000	-	-
L4-2.5	1982-1981		234-2007	234-2000	-	-
L6-4.2	1985-1981		234-1003	234-1000	-	-
<b>TJ</b>						
L4-2.4	2006-2005		234-4587	-	234-4587	-
L4-2.4	2003		234-4030	234-4210	234-4772	234-4210
L4-2.5	2002-2001		234-4030	234-4210	234-4772	234-4210
L4-2.5	2000		234-4077	234-4210	234-4079	234-4210
L4-2.5	1999		234-4077	234-4210	234-4078	234-4210
L4-2.5	1998		234-4076	234-4210	234-4078	234-4210
L4-2.5	1997		234-4077	234-4210	234-4078	234-4210
L6-4.0	2006-2005		234-4598 <sup>15</sup>	-	234-4587 <sup>15</sup>	-
L6-4.0	2006-2005		234-4593 <sup>16</sup>	-	234-4588 <sup>16</sup>	-
L6-4.0	2004		234-4588 <sup>15</sup>	-	234-4771 <sup>15</sup>	234-4210 <sup>15</sup>
L6-4.0	2004		234-4587 <sup>16</sup>	-	234-4768 <sup>16</sup>	234-4210 <sup>16</sup>
L6-4.0	2003-2001		234-4769 <sup>15</sup>	234-4210 <sup>15</sup>	234-4229 <sup>15</sup>	234-4210 <sup>15</sup>
L6-4.0	2003-2001		234-4030 <sup>16</sup>	234-4210 <sup>16</sup>	234-4768 <sup>16</sup>	234-4210 <sup>16</sup>
L6-4.0	2000	Calif.	234-4079 <sup>15</sup>	234-4210 <sup>15</sup>	234-4008 <sup>15</sup>	234-4210 <sup>15</sup>
L6-4.0	2000	Calif.	234-4077 <sup>16</sup>	234-4210 <sup>16</sup>	234-4078 <sup>16</sup>	234-4210 <sup>16</sup>
L6-4.0	2000	Exc. Calif.	234-4115	-	234-4078	234-4210
L6-4.0	1999-1997		234-4076	234-4210	234-4078	234-4210
<b>WAGONEER</b>						
L4-2.5	1987		234-3005	234-3000	-	-

<sup>1</sup> 2 Required / Requis 2 / Requeridos 2 <sup>4</sup> Left Side / Côté gauche / Lado izquierdo <sup>5</sup> Right Side / Côté droit / Lado derecho <sup>15</sup> Front / Avant / Parte delantera <sup>16</sup> Rear / Arrière / Parte trasera



ENGINE MOTEUR MOTOR	YEAR ANNEE AÑO	APPLICATION INFORMATION INFORMATION D'APPLICATION INFORMACION DE APLICACION	UPSTREAM / AVANT - C.C. / ANTES DEL C.C.		DOWNSTREAM / APRS - C.C. / DESPUES DEL C.C.	
			TYPE / TIPO O.E.	UNIVERS.	TYPE / TIPO O.E.	UNIVERS.
<b>JEEP [cont]</b>						
<b>WAGONEER [cont]</b>						
L4-2.5	1986-1984		234-1003	234-1000	-	-
L6-4.0	1987		234-1001	234-1000	-	-
L6-4.2	1983-1981		234-1003	234-1000	-	-
L6-4.2	1980		234-2007	234-2000	-	-
V6-2.8	1986-1984		234-1001	234-1000	-	-
V8-5.9	1983-1981		234-1003	234-1000	-	-
<b>WRANGLER</b>						
L4-2.4	2006-2005		234-4587	-	234-4587	-
L4-2.4	2004-2003		234-4030	234-4210	234-4772	234-4210
L4-2.5	2002-2001		234-4030	234-4210	234-4772	234-4210
L4-2.5	2000		234-4077	234-4210	234-4079	234-4210
L4-2.5	1999		234-4077	234-4210	234-4078	234-4210
L4-2.5	1998		234-4076	234-4210	234-4078	234-4210
L4-2.5	1997		234-4077	234-4210	234-4078	234-4210
L4-2.5	1995-1991		234-4004	234-4210	-	-
L4-2.5	1990-1987		234-3005	234-3000	-	-
L6-4.0	2006-2005		234-4598 <sup>15</sup>	-	234-4587 <sup>15</sup>	-
L6-4.0	2006-2005		234-4593 <sup>16</sup>	-	234-4588 <sup>16</sup>	-
L6-4.0	2004		234-4588 <sup>15</sup>	-	234-4771 <sup>15</sup>	234-4210 <sup>15</sup>
L6-4.0	2004		234-4587 <sup>16</sup>	-	234-4768 <sup>16</sup>	234-4210 <sup>16</sup>
L6-4.0	2003-2001		234-4769 <sup>15</sup>	234-4210 <sup>15</sup>	234-4229 <sup>15</sup>	234-4210 <sup>15</sup>
L6-4.0	2003-2001		234-4030 <sup>16</sup>	234-4210 <sup>16</sup>	234-4768 <sup>16</sup>	234-4210 <sup>16</sup>
L6-4.0	2000	Calif.	234-4079 <sup>15</sup>	234-4210 <sup>15</sup>	234-4008 <sup>15</sup>	234-4210 <sup>15</sup>
L6-4.0	2000	Calif.	234-4077 <sup>16</sup>	234-4210 <sup>16</sup>	234-4078 <sup>16</sup>	234-4210 <sup>16</sup>
L6-4.0	2000	Exc. Calif.	234-4115	-	234-4078	234-4210
L6-4.0	1999-1997		234-4076	234-4210	234-4078	234-4210
L6-4.0	1995-1991		234-4003	234-4210	-	-
L6-4.2	1990-1987		234-1001	234-1000	-	-
V6-3.6	2014-2012		234-4545 <sup>4</sup>	-	234-4547 <sup>4</sup>	-
V6-3.6	2014-2012		234-4547 <sup>5</sup>	-	234-4545 <sup>5</sup>	-
V6-3.8	2011		234-4587 <sup>4</sup>	-	234-4417 <sup>4</sup>	-
V6-3.8	2011		234-4417 <sup>5</sup>	-	234-4587 <sup>5</sup>	-
V6-3.8	2010		234-4881 <sup>4</sup>	-	234-4417 <sup>4</sup>	-
V6-3.8	2010		234-4881 <sup>5</sup>	-	234-4587 <sup>5</sup>	-
V6-3.8	2009-2008		234-4880 <sup>4</sup>	-	234-4587 <sup>4</sup>	-
V6-3.8	2009-2008		234-4881 <sup>5</sup>	-	234-4587 <sup>5</sup>	-
V6-3.8	2007	Left Hand Drive	234-4880 <sup>4</sup>	-	234-4587 <sup>4</sup>	-
V6-3.8	2007	Left Hand Drive	234-4881 <sup>5</sup>	-	234-4587 <sup>5</sup>	-
V6-3.8	2007	Right Hand Drive	234-4881 <sup>1</sup>	-	234-4587 <sup>1</sup>	-

<sup>1</sup> 2 Required / Requis 2 / Requeridos 2 <sup>4</sup> Left Side / Côté gauche / Lado izquierdo <sup>5</sup> Right Side / Côté droit / Lado derecho <sup>15</sup> Front / Avant / Parte delantera <sup>16</sup> Rear / Arrière / Parte trasera



ENGINE MOTEUR MOTOR	YEAR ANNEE AÑO	APPLICATION INFORMATION INFORMATION D'APPLICATION INFORMACION DE APLICACION	UPSTREAM / AVANT - C.C. / ANTES DEL C.C.		DOWNSTREAM / APRS - C.C. / DESPUES DEL C.C.	
			TYPE / TIPO O.E.	UNIVERS.	TYPE / TIPO O.E.	UNIVERS.
<b>KIA</b>						
<b>AMANTI</b>						
V6-3.5	2006-2004		234-4194 <sup>5</sup>	-	234-4435 <sup>5</sup>	-
V6-3.5	2006-2004		234-4194 <sup>4</sup>	-	234-4199 <sup>4</sup>	234-4210 <sup>4</sup>
V6-3.8	2009-2007		234-4854 <sup>4</sup>	-	234-4854 <sup>4</sup>	-
V6-3.8	2009-2007		234-4854 <sup>5</sup>	-	234-4855 <sup>5</sup>	-
<b>BORREGO</b>						
V6-3.8	2011-2009		234-4854 <sup>4</sup>	-	234-4854 <sup>4</sup>	-
V6-3.8	2011-2009		234-4857 <sup>5</sup>	-	234-4854 <sup>5</sup>	-
V8-4.6	2011-2009		234-4240 <sup>4</sup>	-	234-4239 <sup>4</sup>	-
V8-4.6	2011-2009		234-4239 <sup>5</sup>	-	234-4240 <sup>5</sup>	-
<b>CADENZA</b>						
V6-3.3	2015-2014		234-4458 <sup>4</sup>	-	234-4456 <sup>4</sup>	-
V6-3.3	2015-2014		234-4571 <sup>5</sup>	-	234-4572 <sup>5</sup>	-
<b>FORTE</b>						
L4-1.6	2014		234-5007	-	234-4959	-
L4-1.8	2014		234-5082 <sup>15</sup>	-	234-4552	-
L4-1.8	2014		234-5083 <sup>16</sup>	-	-	-
L4-2.0	2014		234-5082 <sup>15</sup>	-	234-4552 <sup>15</sup>	-
L4-2.0	2014		234-5083 <sup>16</sup>	-	234-4958 <sup>16</sup>	-
L4-2.0	2013-2010	Auto Trans; Calif.	234-5029	-	234-4238	-
L4-2.0	2013-2010	Auto Trans; Exc. Calif.	234-5030	-	234-4237	-
L4-2.0	2013-2010	Manual Trans	234-5030	-	234-4237	-
L4-2.4	2013-2010	Auto Trans; Calif.	234-5029	-	234-4238	-
L4-2.4	2013-2010	Auto Trans; Exc. Calif.	234-5030	-	234-4237	-
L4-2.4	2011-2010	Manual Trans	234-5030	-	234-4237	-
<b>FORTE5</b>						
L4-2.0	2013-2012	Auto Trans; Calif.	234-5029	-	234-4238	-
L4-2.0	2013-2012	Auto Trans; Exc. Calif.	234-5030	-	234-4237	-
L4-2.0	2013-2012	Manual Trans	234-5030	-	234-4237	-
L4-2.4	2013-2012	Auto Trans; Calif.	234-5029	-	234-4238	-
L4-2.4	2013-2012	Auto Trans; Exc. Calif.	234-5030	-	234-4237	-
L4-2.4	2013-2012	Manual Trans	234-5030	-	234-4237	-
<b>FORTE KOUP</b>						
L4-1.6	2014		234-5007	-	234-4959	-
L4-2.0	2014		234-5082 <sup>15</sup>	-	234-4552 <sup>15</sup>	-
L4-2.0	2014		234-5083 <sup>16</sup>	-	234-4958 <sup>16</sup>	-
L4-2.0	2013-2010	Auto Trans; Calif.	234-5029	-	234-4238	-
L4-2.0	2013-2010	Auto Trans; Exc. Calif.	234-5030	-	234-4237	-
L4-2.0	2013-2010	Manual Trans	234-5030	-	234-4237	-
L4-2.4	2013-2010	Auto Trans; Calif.	234-5029	-	234-4238	-

<sup>4</sup> Left Side / Côté gauche / Lado izquierdo <sup>5</sup> Right Side / Côté droit / Lado derecho <sup>15</sup> Front / Avant / Parte delantera <sup>16</sup> Rear / Arrière / Parte trasera



ENGINE MOTEUR MOTOR	YEAR ANNEE AÑO	APPLICATION INFORMATION INFORMATION D'APPLICATION INFORMACION DE APLICACION	UPSTREAM / AVANT - C.C. / ANTES DEL C.C.		DOWNSTREAM / APRES - C.C. / DESPUES DEL C.C.	
			TYPE / TIPO O.E.	UNIVERS.	TYPE / TIPO O.E.	UNIVERS.
<b>KIA [cont]</b>						
<b>FORTE KOUP [cont]</b>						
L4-2.4	2013-2010	Auto Trans; Exc. Calif.	234-5030	-	234-4237	-
L4-2.4	2013-2010	Manual Trans	234-5030	-	234-4237	-
<b>K900</b>						
V8-5.0	2015		234-4239 <sup>4</sup>	-	234-4262 <sup>4</sup>	-
V8-5.0	2015		234-4239 <sup>5</sup>	-	234-4573 <sup>5</sup>	-
<b>MAGENTIS</b>						
L4-2.4	2010		234-5030	-	234-4237	-
L4-2.4	2009-2007		234-4433	-	234-4439	-
L4-2.4	2006-2001		234-4436	-	234-4434	-
V6-2.5	2001		234-4431 <sup>4</sup>	-	234-4431 <sup>4</sup>	-
V6-2.5	2001		234-4431 <sup>5</sup>	-	234-4432 <sup>5</sup>	-
V6-2.7	2010-2007		234-4438 <sup>4</sup>	-	234-4194 <sup>4</sup>	-
V6-2.7	2010-2007		234-4429 <sup>5</sup>	-	234-4194 <sup>5</sup>	-
V6-2.7	2006-2003		234-4191 <sup>4</sup>	-	234-4193 <sup>4</sup>	-
V6-2.7	2006-2003		234-4191 <sup>5</sup>	-	234-4192 <sup>5</sup>	-
V6-2.7	2002	From 07/24/02	234-4191 <sup>4</sup>	-	234-4193 <sup>4</sup>	-
V6-2.7	2002	From 07/24/02	234-4191 <sup>5</sup>	-	234-4192 <sup>5</sup>	-
V6-2.7	2002	To 07/24/02	234-4431 <sup>4</sup>	-	234-4431 <sup>4</sup>	-
V6-2.7	2002	To 07/24/02	234-4431 <sup>5</sup>	-	234-4432 <sup>5</sup>	-
<b>OPTIMA</b>						
L4-2.0	2014-2011		234-5147	-	234-4448	-
L4-2.4	2015-2014		234-5029	-	234-4238	-
L4-2.4	2013-2011	Hybrid Engine	234-5029	-	234-4238	-
L4-2.4	2013	Gas Engine; Auto Trans; Calif.	234-5029	-	234-4238	-
L4-2.4	2013	Gas Engine; Auto Trans; Exc. Calif.	234-5030	-	234-4448	-
L4-2.4	2013	Gas Engine; Manual Trans	234-5030	-	234-4448	-
L4-2.4	2012-2011	Gas Engine, Auto Trans; Calif.	234-5029	-	234-4238	-
L4-2.4	2012-2011	Gas Engine, Auto Trans; Exc. Calif.	234-5030	-	234-4448	-
L4-2.4	2012-2011	Gas Engine, Manual Trans	234-5030	-	234-4448	-
L4-2.4	2010		234-5030	-	234-4237	-
L4-2.4	2009-2007		234-4433	-	234-4439	-
L4-2.4	2006	VIN 3	234-4433	-	234-4439	-
L4-2.4	2006	VIN 6	234-4436	-	234-4434	-
L4-2.4	2005-2001		234-4436	-	234-4434	-
V6-2.5	2001		234-4431 <sup>4</sup>	-	234-4431 <sup>4</sup>	-
V6-2.5	2001		234-4431 <sup>5</sup>	-	234-4432 <sup>5</sup>	-
V6-2.7	2010-2007		234-4438 <sup>4</sup>	-	234-4194 <sup>4</sup>	-
V6-2.7	2010-2007		234-4429 <sup>5</sup>	-	234-4194 <sup>5</sup>	-
V6-2.7	2006	VIN 4	234-4438 <sup>4</sup>	-	234-4194 <sup>4</sup>	-
V6-2.7	2006	VIN 4	234-4429 <sup>5</sup>	-	234-4194 <sup>5</sup>	-

<sup>4</sup> Left Side / Côté gauche / Lado izquierdo <sup>5</sup> Right Side / Côté droit / Lado derecho



ENGINE MOTEUR MOTOR	YEAR ANNEE AÑO	APPLICATION INFORMATION INFORMATION D'APPLICATION INFORMACION DE APLICACION	UPSTREAM / AVANT - C.C. / ANTES DEL C.C.		DOWNSTREAM / APRS - C.C. / DESPUES DEL C.C.	
			TYPE / TIPO O.E.	UNIVERS.	TYPE / TIPO O.E.	UNIVERS.
<b>KIA [cont]</b>						
<b>OPTIMA [cont]</b>						
V6-2.7	2006	VIN 8	234-4191 <sup>4</sup>	-	234-4193 <sup>4</sup>	-
V6-2.7	2006	VIN 8	234-4191 <sup>5</sup>	-	234-4192 <sup>5</sup>	-
V6-2.7	2005-2003		234-4191 <sup>4</sup>	-	234-4193 <sup>4</sup>	-
V6-2.7	2005-2003		234-4191 <sup>5</sup>	-	234-4192 <sup>5</sup>	-
V6-2.7	2002	From 07/24/02	234-4191 <sup>4</sup>	-	234-4193 <sup>4</sup>	-
V6-2.7	2002	From 07/24/02	234-4191 <sup>5</sup>	-	234-4192 <sup>5</sup>	-
V6-2.7	2002	To 07/24/02	234-4431 <sup>4</sup>	-	234-4431 <sup>4</sup>	-
V6-2.7	2002	To 07/24/02	234-4431 <sup>5</sup>	-	234-4432 <sup>5</sup>	-
<b>RIO</b>						
L4-1.5	2002-2001		234-4117	-	234-4121	-
L4-1.6	2014-2012		234-5055	-	234-4568	-
L4-1.6	2011-2006		234-4851	-	234-4851	-
L4-1.6	2005-2004		234-4190	-	234-4190	-
L4-1.6	2003		234-4117	-	234-4121	-
<b>RIOS</b>						
L4-1.6	2011-2006		234-4851	-	234-4851	-
<b>RONDO</b>						
L4-2.0	2015-2014		234-5083	-	-	-
L4-2.4	2012-2009	Calif.	234-5029	-	234-4238	-
L4-2.4	2012-2009	Exc. Calif.	234-5030	-	234-4237	-
L4-2.4	2008-2007		234-4433	-	234-4439	-
V6-2.7	2012-2007		234-4438 <sup>4</sup>	-	234-4194 <sup>4</sup>	-
V6-2.7	2012-2007		234-4429 <sup>5</sup>	-	234-4194 <sup>5</sup>	-
<b>SEDONA</b>						
V6-3.5	2014		234-4458 <sup>4</sup>	-	234-4456 <sup>4</sup>	-
V6-3.5	2014		234-4571 <sup>5</sup>	-	234-4957 <sup>5</sup>	-
V6-3.5	2012-2011		234-4458 <sup>4</sup>	-	234-4456 <sup>4</sup>	-
V6-3.5	2012-2011		234-4458 <sup>5</sup>	-	234-4548 <sup>5</sup>	-
V6-3.5	2005-2002		234-4194 <sup>1</sup>	-	234-4434 <sup>1</sup>	-
V6-3.8	2010-2006		234-4854 <sup>4</sup>	-	234-4854 <sup>4</sup>	-
V6-3.8	2010-2006		234-4854 <sup>5</sup>	-	234-4855 <sup>5</sup>	-
<b>SEPHIA</b>						
L4-1.6	1997-1996		234-3085	234-3000	234-4612	234-4210
L4-1.6	1995	DOHC; VIN 3	234-3085	234-3000	-	-
L4-1.6	1995	SOHC; VIN 1	234-1010	234-1000	-	-
L4-1.6	1994		234-1010	234-1000	-	-
L4-1.8	2001-2000		234-4686	234-4201	234-4687	234-4201
L4-1.8	1999-1998		234-4686	234-4201	234-4686	234-4201
L4-1.8	1997-1996		234-4606	234-4209	234-4140	234-4209
L4-1.8	1995		234-4606	234-4209	-	-

<sup>1</sup> 2 Required / Requis 2 / Requeridos 2 <sup>4</sup> Left Side / Côté gauche / Lado izquierdo <sup>5</sup> Right Side / Côté droit / Lado derecho





ENGINE MOTEUR MOTOR	YEAR ANNEE AÑO	APPLICATION INFORMATION INFORMATION D'APPLICATION INFORMACION DE APLICACION	UPSTREAM / AVANT - C.C. / ANTES DEL C.C.		DOWNSTREAM / APRS - C.C. / DESPUES DEL C.C.	
			TYPE / TIPO O.E.	UNIVERS.	TYPE / TIPO O.E.	UNIVERS.
<b>KIA [cont]</b>						
<b>SORENTO</b>						
L4-2.4	2015-2011		234-5029	-	234-4238	-
V6-3.3	2015-2014		234-4458 <sup>4</sup>	-	234-4456 <sup>4</sup>	-
V6-3.3	2015		234-4571 <sup>5</sup>	-	234-4455 <sup>5</sup>	-
V6-3.3	2014	AWD	234-4463 <sup>5</sup>	-	234-4455 <sup>5</sup>	-
V6-3.3	2014	FWD	234-4571 <sup>5</sup>	-	234-4455 <sup>5</sup>	-
V6-3.3	2009-2008		234-4854 <sup>4</sup>	-	234-4856 <sup>4</sup>	-
V6-3.3	2009-2008		234-4857 <sup>5</sup>	-	234-4855 <sup>5</sup>	-
V6-3.5	2013-2011		234-4458 <sup>4</sup>	-	234-4456 <sup>4</sup>	-
V6-3.5	2013-2011		234-4463 <sup>5</sup>	-	234-4455 <sup>5</sup>	-
V6-3.5	2006-2003		234-4194 <sup>1</sup>	-	234-4166 <sup>1</sup>	234-4210 <sup>1</sup>
V6-3.8	2009-2007		234-4854 <sup>4</sup>	-	234-4856 <sup>4</sup>	-
V6-3.8	2009-2007		234-4857 <sup>5</sup>	-	234-4855 <sup>5</sup>	-
<b>SOUL</b>						
L4-1.6	2015-2012		234-5055	-	234-4568	-
L4-1.6	2011-2010		234-4239	-	234-4549	-
L4-2.0	2015-2014		234-5083	-	234-4958	-
L4-2.0	2013-2012		234-5083	-	234-4569	-
L4-2.0	2011-2010		234-4938	-	234-4851	-
<b>SPECTRA</b>						
L4-1.8	2004-2003		234-4858	-	234-4858	-
L4-1.8	2002	From 05/22/01	234-4858	-	234-4858	-
L4-1.8	2002	To 05/22/01	234-4686	234-4201	234-4687	234-4201
L4-1.8	2001-2000		234-4686	234-4201	234-4687	234-4201
L4-2.0	2009-2004		234-5430	-	234-4851	-
<b>SPECTRAS</b>						
L4-2.0	2009-2005		234-5430	-	234-4851	-
<b>SPORTAGE</b>						
L4-2.0	2014-2011		234-5147	-	234-4444	-
L4-2.0	2010-2005		234-4852	-	234-4851	-
L4-2.0	2002-1996		234-4686	234-4201	234-4686	234-4201
L4-2.0	1995	DOHC; VIN 3	234-3100	234-3090	-	-
L4-2.0	1995	SOHC; VIN 1	234-3099	234-3090	-	-
L4-2.4	2014	Loc. Lower	234-5147	-	-	-
L4-2.4	2014	Loc. Upper	234-5029	-	234-4238	-
L4-2.4	2013-2011	Calif.	234-5029	-	234-4238	-
L4-2.4	2013-2011	Exc. Calif.	234-5044	-	234-4444	-
V6-2.7	2010-2005		234-4193 <sup>4</sup>	-	234-4193 <sup>4</sup>	-
V6-2.7	2010-2005		234-4191 <sup>5</sup>	-	234-4192 <sup>5</sup>	-

<sup>1</sup> 2 Required / Requis 2 / Requeridos 2 <sup>4</sup> Left Side / Côté gauche / Lado izquierdo <sup>5</sup> Right Side / Côté droit / Lado derecho



ENGINE MOTEUR MOTOR	YEAR ANNEE AÑO	APPLICATION INFORMATION INFORMATION D'APPLICATION INFORMACION DE APLICACION	UPSTREAM / AVANT - C.C. / ANTES DEL C.C.		DOWNSTREAM / APRS - C.C. / DESPUES DEL C.C.	
			TYPE / TIPO O.E.	UNIVERS.	TYPE / TIPO O.E.	UNIVERS.
<b>LAND ROVER</b>						
<b>DEFENDER 90</b>						
V8-3.9	1995-1994		234-3130 <sup>1</sup>	-	-	-
V8-4.0	1997	AELS	234-4783 <sup>1</sup>	-	234-4783 <sup>1</sup>	-
V8-4.0	1997	Exc. AELS	234-4788 <sup>1</sup>	-	234-4788 <sup>1</sup>	-
<b>DEFENDER 110</b>						
V8-3.9	1993	Auto Trans	234-4783 <sup>1</sup>	-	-	-
V8-3.9	1993	Manual Trans	234-3130 <sup>1</sup>	-	-	-
<b>DISCOVERY</b>						
V8-3.9	1995-1994		234-3130 <sup>1</sup>	-	-	-
V8-4.0	2002-2000		234-4694 <sup>1</sup>	234-4201 <sup>1</sup>	234-4696 <sup>1</sup>	234-4201 <sup>1</sup>
V8-4.0	1999	Exc. Series II Model; AELS	234-4783 <sup>1</sup>	-	234-4783 <sup>1</sup>	-
V8-4.0	1999	Exc. Series II Model; Exc. AELS	234-4788 <sup>1</sup>	-	234-4788 <sup>1</sup>	-
V8-4.0	1999	Series II Model	234-4694 <sup>1</sup>	234-4201 <sup>1</sup>	234-4696 <sup>1</sup>	234-4201 <sup>1</sup>
V8-4.0	1998-1996	AELS	234-4783 <sup>1</sup>	-	234-4783 <sup>1</sup>	-
V8-4.0	1998-1996	Exc. AELS	234-4788 <sup>1</sup>	-	234-4788 <sup>1</sup>	-
V8-4.6	2004-2003		234-4694 <sup>1</sup>	234-4201 <sup>1</sup>	234-4696 <sup>1</sup>	234-4201 <sup>1</sup>
<b>FREELANDER</b>						
V6-2.5	2005		234-4828 <sup>1</sup>	-	234-4696 <sup>1</sup>	234-4201 <sup>1</sup>
V6-2.5	2004-2002		234-4695 <sup>1</sup>	234-4201 <sup>1</sup>	234-4696 <sup>1</sup>	234-4201 <sup>1</sup>
<b>LR2</b>						
L4-2.0	2014-2013		234-5057	-	234-4582	-
L6-3.2	2012-2008		234-9027 <sup>1</sup>	-	234-4136 <sup>1</sup>	-
<b>LR3</b>						
V6-4.0	2009		234-9075 <sup>1</sup>	-	234-4264 <sup>1</sup>	-
V6-4.0	2008-2007		234-9075 <sup>4</sup>	-	234-4264 <sup>4</sup>	-
V6-4.0	2008-2007		234-9075 <sup>5</sup>	-	234-4264 <sup>5</sup>	-
V6-4.0	2006-2005		234-9075 <sup>4</sup>	-	234-4266 <sup>4</sup>	-
V6-4.0	2006-2005		234-9075 <sup>5</sup>	-	234-4265 <sup>5</sup>	-
V8-4.4	2009-2007		234-9075 <sup>4</sup>	-	234-4264 <sup>4</sup>	-
V8-4.4	2009-2007		234-9075 <sup>5</sup>	-	234-4264 <sup>5</sup>	-
V8-4.4	2006-2005		234-9075 <sup>4</sup>	-	234-4266 <sup>4</sup>	-
V8-4.4	2006-2005		234-9075 <sup>5</sup>	-	234-4265 <sup>5</sup>	-
<b>LR4</b>						
V6-3.0	2015-2014		234-5156 <sup>4</sup>	-	234-4981 <sup>4</sup>	-
V6-3.0	2015-2014		234-5156 <sup>5</sup>	-	234-4795 <sup>5</sup>	-
V6-3.0	2015-2014	Loc. Center	-	-	234-4795 <sup>4,12</sup>	-
V6-3.0	2015-2014	Loc. Center	-	-	234-4791 <sup>5,12</sup>	-
V8-5.0	2013-2010		234-9095 <sup>4</sup>	-	234-4454 <sup>4</sup>	-
V8-5.0	2013-2010		234-9095 <sup>5</sup>	-	234-4465 <sup>5</sup>	-

<sup>1</sup> 2 Required / Requis 2 / Requeridos 2 <sup>4</sup> Left Side / Côté gauche / Lado izquierdo <sup>5</sup> Right Side / Côté droit / Lado derecho <sup>12</sup> Loc. Center / Empl. central / Ubicación central



ENGINE MOTEUR MOTOR	YEAR ANNEE AÑO	APPLICATION INFORMATION INFORMATION D'APPLICATION INFORMACION DE APLICACION	UPSTREAM / AVANT - C.C. / ANTES DEL C.C.		DOWNSTREAM / APRS - C.C. / DESPUES DEL C.C.	
			TYPE / TIPO O.E.	UNIVERS.	TYPE / TIPO O.E.	UNIVERS.
<b>LAND ROVER [cont]</b>						
<b>RANGE ROVER</b>						
V6-3.0	2015-2014		234-5156 <sup>1</sup>	-	234-4794 <sup>1</sup>	-
V6-3.0	2015-2014	Loc. Center	-	-	234-4795 <sup>1</sup>	-
V8-3.5	1988-1987		234-3130 <sup>1</sup>	-	-	-
V8-3.9	1995-1989		234-3130 <sup>1</sup>	-	-	-
V8-4.0	2000-1999		234-4695 <sup>1</sup>	234-4201 <sup>1</sup>	234-4696 <sup>1</sup>	234-4201 <sup>1</sup>
V8-4.0	1998		234-4783 <sup>1</sup>	-	234-4783 <sup>1</sup>	-
V8-4.0	1997	From VIN #V350102	234-4783 <sup>1</sup>	-	234-4783 <sup>1</sup>	-
V8-4.0	1997	To VIN #VA350101	234-4788 <sup>1</sup>	-	234-4788 <sup>1</sup>	-
V8-4.0	1996-1995		234-4788 <sup>1</sup>	-	234-4788 <sup>1</sup>	-
V8-4.2	2009-2007	Exc. North American Vehicle	234-9074 <sup>1</sup>	-	234-4266 <sup>1</sup>	-
V8-4.2	2009-2007	North American Vehicle	234-9074 <sup>1</sup>	-	234-4265 <sup>1</sup>	-
V8-4.2	2006		234-9074 <sup>1</sup>	-	234-4266 <sup>1</sup>	-
V8-4.2	1995-1993		234-3130 <sup>1</sup>	-	-	-
V8-4.4	2009-2007	Exc. North American Vehicle	234-9074 <sup>1</sup>	-	234-4266 <sup>1</sup>	-
V8-4.4	2009-2007	North American Vehicle	234-9074 <sup>1</sup>	-	234-4265 <sup>1</sup>	-
V8-4.4	2006		234-9074 <sup>1</sup>	-	234-4266 <sup>1</sup>	-
V8-4.4	2005-2003		234-4672 <sup>1</sup>	234-4201 <sup>1</sup>	234-4683 <sup>1</sup>	234-4201 <sup>1</sup>
V8-4.6	2002-1999		234-4695 <sup>1</sup>	234-4201 <sup>1</sup>	234-4696 <sup>1</sup>	234-4201 <sup>1</sup>
V8-4.6	1998		234-4783 <sup>1</sup>	-	234-4783 <sup>1</sup>	-
V8-4.6	1997	From VIN #V350102	234-4783 <sup>1</sup>	-	234-4783 <sup>1</sup>	-
V8-4.6	1997	To VIN #VA350101	234-4788 <sup>1</sup>	-	234-4788 <sup>1</sup>	-
V8-4.6	1996		234-4788 <sup>1</sup>	-	234-4788 <sup>1</sup>	-
V8-5.0	2015-2013		234-5156 <sup>1</sup>	-	234-4794 <sup>1</sup>	-
V8-5.0	2015-2013	Loc. Center	-	-	234-4795 <sup>1</sup>	-
V8-5.0	2012-2010		234-9095 <sup>1</sup>	-	234-4465 <sup>1</sup>	-
<b>RANGE ROVER EVOQUE</b>						
L4-2.0	2015		234-4982	-	234-4582	-
L4-2.0	2014		234-5153	-	234-4981	-
L4-2.0	2013		234-5057	-	234-4582	-
L4-2.0	2012		234-5057 <sup>1</sup>	-	234-4582 <sup>1</sup>	-
<b>RANGE ROVER SPORT</b>						
V6-3.0	2015-2014		234-5156 <sup>1</sup>	-	234-4794 <sup>1</sup>	-
V6-3.0	2015-2014	Loc. Center	-	-	234-4795 <sup>1</sup>	-
V8-4.2	2009-2007		234-9075 <sup>1</sup>	-	234-4264 <sup>1</sup>	-
V8-4.2	2006		234-9075 <sup>4</sup>	-	234-4266 <sup>4</sup>	-
V8-4.2	2006		234-9075 <sup>5</sup>	-	234-4265 <sup>5</sup>	-
V8-4.4	2009-2007		234-9075 <sup>1</sup>	-	234-4264 <sup>1</sup>	-
V8-4.4	2006		234-9075 <sup>4</sup>	-	234-4266 <sup>4</sup>	-

<sup>1</sup> 2 Required / Requis 2 / Requeridos 2 <sup>4</sup> Left Side / Côté gauche / Lado izquierdo <sup>5</sup> Right Side / Côté droit / Lado derecho



ENGINE MOTEUR MOTOR	YEAR ANNEE AÑO	APPLICATION INFORMATION INFORMATION D'APPLICATION INFORMACION DE APLICACION	UPSTREAM / AVANT - C.C. / ANTES DEL C.C.		DOWNSTREAM / APRES - C.C. / DESPUES DEL C.C.	
			TYPE / TIPO O.E.	UNIVERS.	TYPE / TIPO O.E.	UNIVERS.
<b>LAND ROVER [cont]</b>						
<b>RANGE ROVER SPORT [cont]</b>						
V8-4.4	2006	Loc. Center	234-9075 <sup>5</sup>	-	234-4266 <sup>5</sup>	-
V8-5.0	2015-2014		234-5156 <sup>1</sup>	-	234-4794 <sup>1</sup>	-
V8-5.0	2015-2014		-	-	234-4795 <sup>1</sup>	-
V8-5.0	2013-2010		234-9095 <sup>4</sup>	-	234-4454 <sup>4</sup>	-
V8-5.0	2013-2010		234-9095 <sup>5</sup>	-	234-4465 <sup>5</sup>	-
<b>LEXUS</b>						
<b>CT200H</b>						
L4-1.8	2016-2015		234-9090	-	234-4400	-
L4-1.8	2014-2011		234-9112	-	234-4400	-
<b>ES250</b>						
V6-2.5	1991-1990	Calif.	234-2069	234-2000	-	-
V6-2.5	1991-1990	Exc. Calif.	234-4051	234-4050	-	-
<b>ES300</b>						
V6-3.0	2003-2002		234-9042 <sup>15</sup>	-	234-4261 <sup>15</sup>	234-4209 <sup>15</sup>
V6-3.0	2003-2002		234-9047 <sup>16</sup>	-	234-4064 <sup>16</sup>	234-4209 <sup>16</sup>
V6-3.0	2001-2000		234-9021 <sup>1</sup>	-	234-4137	234-4209
V6-3.0	1999		234-9009 <sup>15</sup>	-	234-4137	234-4209
V6-3.0	1999		234-9007 <sup>16</sup>	-	-	-
V6-3.0	1998	Calif.	234-9009 <sup>15</sup>	-	234-4137	234-4209
V6-3.0	1998	Calif.	234-9007 <sup>16</sup>	-	-	-
V6-3.0	1998	Exc. Calif.	234-4622 <sup>1</sup>	234-4209 <sup>1</sup>	234-4137	234-4209
V6-3.0	1997		234-4622 <sup>1</sup>	234-4209 <sup>1</sup>	234-4137	234-4209
V6-3.0	1996-1995		234-4622 <sup>1</sup>	234-4209 <sup>1</sup>	234-4623	234-4209
V6-3.0	1994		234-1053 <sup>1</sup>	234-1057 <sup>1</sup>	234-4623	234-4209
V6-3.0	1993-1992	Calif.	234-1053 <sup>1</sup>	234-1057 <sup>1</sup>	234-4623	234-4209
V6-3.0	1993-1992	Exc. Calif.	234-1053 <sup>1</sup>	234-1057 <sup>1</sup>	-	-
<b>ES300H</b>						
L4-2.5	2016-2013		234-9128	-	234-4757	-
<b>ES330</b>						
V6-3.3	2006-2004		234-9042 <sup>15</sup>	-	234-4261 <sup>15</sup>	234-4209 <sup>15</sup>
V6-3.3	2006-2004		234-9057 <sup>16</sup>	-	234-4064 <sup>16</sup>	234-4209 <sup>16</sup>
<b>ES350</b>						
V6-3.5	2016-2015		234-9154 <sup>4</sup>	-	234-4927 <sup>4</sup>	-
V6-3.5	2014-2012		234-9128 <sup>4</sup>	-	234-4260 <sup>4</sup>	234-4209 <sup>4</sup>
V6-3.5	2014-2012		234-9128 <sup>5</sup>	-	234-4064 <sup>5</sup>	234-4209 <sup>5</sup>
V6-3.5	2011-2008		234-9008 <sup>4</sup>	-	234-4260 <sup>4</sup>	234-4209 <sup>4</sup>
V6-3.5	2011-2008		234-9022 <sup>5</sup>	-	234-4064 <sup>5</sup>	234-4209 <sup>5</sup>
V6-3.5	2007		234-9041 <sup>4</sup>	-	234-4260 <sup>4</sup>	234-4209 <sup>4</sup>

<sup>1</sup> 2 Required / Requis 2 / Requeridos 2 <sup>4</sup> Left Side / Côté gauche / Lado izquierdo <sup>5</sup> Right Side / Côté droit / Lado derecho <sup>15</sup> Front / Avant / Parte delantera <sup>16</sup> Rear / Arrière / Parte trasera



ENGINE MOTEUR MOTOR	YEAR ANNEE AÑO	APPLICATION INFORMATION INFORMATION D'APPLICATION INFORMACION DE APLICACION	UPSTREAM / AVANT - C.C. / ANTES DEL C.C.		DOWNSTREAM / APRES - C.C. / DESPUES DEL C.C.	
			TYPE / TIPO O.E.	UNIVERS.	TYPE / TIPO O.E.	UNIVERS.
<b>LEXUS [cont]</b>						
<b>ES350 [cont]</b>						
V6-3.5	2007		234-9050 <sup>5</sup>	-	234-4064 <sup>5</sup>	234-4209 <sup>5</sup>
<b>GS300</b>						
L6-3.0	2005-1998	Cylinder 1, 2, 3	234-4048	234-4209	234-4626	234-4209
L6-3.0	2005-1998	Cylinder 4, 5, 6	234-4630	234-4209	234-4603	234-4209
L6-3.0	1997-1995		234-4624 <sup>1</sup>	234-4209 <sup>1</sup>	234-4623	234-4209
L6-3.0	1994-1993	Calif.	234-4624 <sup>1</sup>	234-4209 <sup>1</sup>	234-4623	234-4209
L6-3.0	1994-1993	Exc. Calif.	234-1055	234-1057	234-1055	234-1057
V6-3.0	2006	AWD	234-9051 <sup>4</sup>	-	234-4810 <sup>4</sup>	-
V6-3.0	2006	AWD	234-9058 <sup>5</sup>	-	234-4806 <sup>5</sup>	-
V6-3.0	2006	RWD	234-9051 <sup>1</sup>	-	234-4806 <sup>1</sup>	-
<b>GS350</b>						
V6-3.5	2015-2014		234-9140 <sup>5</sup>	-	234-4945 <sup>5</sup>	-
V6-3.5	2015-2014	AWD	234-9143 <sup>4</sup>	-	234-4930 <sup>4</sup>	-
V6-3.5	2015-2014	RWD	234-9145 <sup>4</sup>	-	234-4945 <sup>4</sup>	-
V6-3.5	2013		234-9129 <sup>4</sup>	-	234-4521 <sup>4</sup>	-
V6-3.5	2013	AWD	234-9129 <sup>5</sup>	-	234-4519 <sup>5</sup>	-
V6-3.5	2013	RWD	234-9144 <sup>5</sup>	-	234-4521 <sup>5</sup>	-
V6-3.5	2011-2009		234-9048 <sup>5</sup>	-	234-4521 <sup>5</sup>	-
V6-3.5	2011-2009	AWD	234-9068 <sup>4</sup>	-	234-4519 <sup>4</sup>	-
V6-3.5	2011-2009	RWD	234-9068 <sup>4</sup>	-	234-4521 <sup>4</sup>	-
V6-3.5	2008	AWD; From 03/08	234-9068 <sup>4</sup>	-	234-4519 <sup>4</sup>	-
V6-3.5	2008	AWD; From 03/08	234-9048 <sup>5</sup>	-	234-4521 <sup>5</sup>	-
V6-3.5	2008	AWD; To 03/08	234-9051 <sup>4</sup>	-	234-4519 <sup>4</sup>	-
V6-3.5	2008	AWD; To 03/08	234-9058 <sup>5</sup>	-	234-4521 <sup>5</sup>	-
V6-3.5	2008	RWD; From 02/08	234-9068 <sup>4</sup>	-	234-4521 <sup>4</sup>	-
V6-3.5	2008	RWD; From 02/08	234-9048 <sup>5</sup>	-	234-4521 <sup>5</sup>	-
V6-3.5	2008	RWD; To 02/08	234-9051 <sup>1</sup>	-	234-4521 <sup>1</sup>	-
V6-3.5	2007	AWD	234-9051 <sup>4</sup>	-	234-4519 <sup>4</sup>	-
V6-3.5	2007	AWD	234-9058 <sup>5</sup>	-	234-4521 <sup>5</sup>	-
V6-3.5	2007	RWD	234-9051 <sup>1</sup>	-	234-4521 <sup>1</sup>	-
<b>GS400</b>						
V8-4.0	2000-1998		234-4169 <sup>1</sup>	234-4209 <sup>1</sup>	234-4623 <sup>1</sup>	234-4209 <sup>1</sup>
<b>GS430</b>						
V8-4.3	2007-2005		234-4138 <sup>4</sup>	234-4209 <sup>4</sup>	234-4521 <sup>4</sup>	-
V8-4.3	2007-2005		234-4630 <sup>5</sup>	234-4209 <sup>5</sup>	234-4521 <sup>5</sup>	-
V8-4.3	2004-2001		234-4138 <sup>4</sup>	234-4209 <sup>4</sup>	234-4623 <sup>4</sup>	234-4209 <sup>4</sup>
V8-4.3	2004-2001		234-4630 <sup>5</sup>	234-4209 <sup>5</sup>	234-4623 <sup>5</sup>	234-4209 <sup>5</sup>
<b>GS450H</b>						
V6-3.5	2016-2015		234-9140 <sup>4</sup>	-	234-4924 <sup>4</sup>	-

<sup>1</sup> 2 Required / Requis 2 / Requeridos 2 <sup>4</sup> Left Side / Côté gauche / Lado izquierdo <sup>5</sup> Right Side / Côté droit / Lado derecho



ENGINE MOTEUR MOTOR	YEAR ANNEE AÑO	APPLICATION INFORMATION INFORMATION D'APPLICATION INFORMACION DE APLICACION	UPSTREAM / AVANT - C.C. / ANTES DEL C.C.		DOWNSTREAM / APRES - C.C. / DESPUES DEL C.C.	
			TYPE / TIPO O.E.	UNIVERS.	TYPE / TIPO O.E.	UNIVERS.
<b>LEXUS [cont]</b>						
<b>GS450H [cont]</b>						
V6-3.5	2016-2015		234-9143 <sup>5</sup>	-	234-4945 <sup>5</sup>	-
V6-3.5	2014-2013		234-9129 <sup>4</sup>	-	234-4924 <sup>4</sup>	-
V6-3.5	2014		234-9129 <sup>5</sup>	-	234-4945 <sup>5</sup>	-
V6-3.5	2013		234-9129 <sup>5</sup>	-	234-4922 <sup>5</sup>	-
V6-3.5	2011-2007		234-9058 <sup>4</sup>	-	234-4521 <sup>4</sup>	-
V6-3.5	2011-2007		234-9051 <sup>5</sup>	-	234-4521 <sup>5</sup>	-
<b>GS460</b>						
V8-4.6	2011-2008		234-9048 <sup>4</sup>	-	234-4623 <sup>4</sup>	234-4209 <sup>4</sup>
V8-4.6	2011-2008		234-9068 <sup>5</sup>	-	234-4623 <sup>5</sup>	234-4209 <sup>5</sup>
<b>GS F</b>						
V8-5.0	2016		234-9140 <sup>4</sup>	-	234-4945 <sup>4</sup>	-
V8-5.0	2016		234-9143 <sup>5</sup>	-	234-4945 <sup>5</sup>	-
<b>GX460</b>						
V8-4.6	2016		234-9145 <sup>4</sup>	-	234-4925 <sup>4</sup>	-
V8-4.6	2016		234-9145 <sup>5</sup>	-	234-4927 <sup>5</sup>	-
V8-4.6	2015-2014		234-9145 <sup>5</sup>	-	234-4925 <sup>5</sup>	-
V8-4.6	2015		234-9145 <sup>4</sup>	-	234-4927 <sup>4</sup>	-
V8-4.6	2014		234-9145 <sup>4</sup>	-	234-4758 <sup>4</sup>	-
V8-4.6	2013-2010		234-9026 <sup>4</sup>	-	234-4260 <sup>4</sup>	234-4209 <sup>4</sup>
V8-4.6	2013-2010		234-9026 <sup>5</sup>	-	234-4064 <sup>5</sup>	234-4209 <sup>5</sup>
<b>GX470</b>						
V8-4.7	2009-2005		234-9051 <sup>1</sup>	-	234-4261 <sup>1</sup>	234-4209 <sup>1</sup>
V8-4.7	2004-2003		234-4138 <sup>4</sup>	234-4209 <sup>4</sup>	234-4261 <sup>4</sup>	234-4209 <sup>4</sup>
V8-4.7	2004-2003		234-4138 <sup>5</sup>	234-4209 <sup>5</sup>	234-4260 <sup>5</sup>	234-4209 <sup>5</sup>
<b>HS250H</b>						
L4-2.4	2012-2010		234-9048	-	234-4476	-
<b>IS250</b>						
V6-2.5	2015-2014	AWD	234-9143 <sup>4</sup>	-	234-4930 <sup>4</sup>	-
V6-2.5	2015		234-9140 <sup>5</sup>	-	234-4945 <sup>5</sup>	-
V6-2.5	2015	RWD	234-9145 <sup>4</sup>	-	234-4945 <sup>4</sup>	-
V6-2.5	2014		234-9140 <sup>5</sup>	-	234-4922 <sup>5</sup>	-
V6-2.5	2014	RWD	234-9145 <sup>4</sup>	-	234-4922 <sup>4</sup>	-
V6-2.5	2013		234-9129 <sup>5</sup>	-	234-4521 <sup>5</sup>	-
V6-2.5	2013	AWD	234-9129 <sup>4</sup>	-	234-4518 <sup>4</sup>	-
V6-2.5	2013	RWD	234-9144 <sup>4</sup>	-	234-4521 <sup>4</sup>	-
V6-2.5	2012-2009	AWD	234-9068 <sup>4</sup>	-	234-4518 <sup>4</sup>	-
V6-2.5	2012-2009	RWD	234-9068 <sup>4</sup>	-	234-4521 <sup>4</sup>	-
V6-2.5	2012		234-9067 <sup>5</sup>	-	234-4521 <sup>5</sup>	-
V6-2.5	2011	Convertible	234-9067 <sup>5</sup>	-	234-4521 <sup>5</sup>	-

<sup>1</sup> 2 Required / Requis 2 / Requeridos 2 <sup>4</sup> Left Side / Côté gauche / Lado izquierdo <sup>5</sup> Right Side / Côté droit / Lado derecho



ENGINE MOTEUR MOTOR	YEAR ANNEE AÑO	APPLICATION INFORMATION INFORMATION D'APPLICATION INFORMACION DE APLICACION	UPSTREAM / AVANT - C.C. / ANTES DEL C.C.		DOWNSTREAM / APRS - C.C. / DESPUES DEL C.C.	
			TYPE / TIPO O.E.	UNIVERS.	TYPE / TIPO O.E.	UNIVERS.
<b>LEXUS [cont]</b>						
<b>IS250 [cont]</b>						
V6-2.5	2011	Sedan	234-9048 <sup>5</sup>	-	234-4521 <sup>5</sup>	-
V6-2.5	2010-2009		234-9048 <sup>5</sup>	-	234-4521 <sup>5</sup>	-
V6-2.5	2008	From 02/08	234-9048 <sup>5</sup>	-	234-4521 <sup>5</sup>	-
V6-2.5	2008	From 02/08; AWD	234-9068 <sup>4</sup>	-	234-4518 <sup>4</sup>	-
V6-2.5	2008	From 02/08; RWD	234-9068 <sup>4</sup>	-	234-4521 <sup>4</sup>	-
V6-2.5	2008	To 02/08; AWD	234-9051 <sup>4</sup>	-	234-4518 <sup>4</sup>	-
V6-2.5	2008	To 02/08; AWD	234-9058 <sup>5</sup>	-	234-4521 <sup>5</sup>	-
V6-2.5	2008	To 02/08; RWD	234-9051 <sup>1</sup>	-	234-4521 <sup>1</sup>	-
V6-2.5	2007-2006	AWD	234-9051 <sup>4</sup>	-	234-4518 <sup>4</sup>	-
V6-2.5	2007-2006	AWD	234-9058 <sup>5</sup>	-	234-4521 <sup>5</sup>	-
V6-2.5	2007-2006	RWD	234-9051 <sup>1</sup>	-	234-4521 <sup>1</sup>	-
<b>IS300</b>						
L6-3.0	2005-2001	Cylinder 1,2,3	234-4626	234-4209	234-4015	234-4209
L6-3.0	2005-2001	Cylinder 4,5,6	234-4630	234-4209	234-4517	-
V6-3.5	2016		234-9143 <sup>4</sup>	-	234-4930 <sup>4</sup>	-
V6-3.5	2016		234-9140 <sup>5</sup>	-	234-4945 <sup>5</sup>	-
<b>IS350</b>						
V6-3.5	2016-2015		234-9140 <sup>5</sup>	-	234-4945 <sup>5</sup>	-
V6-3.5	2016-2015	RWD	234-9145 <sup>4</sup>	-	234-4945 <sup>4</sup>	-
V6-3.5	2016-2014	AWD	234-9143 <sup>4</sup>	-	234-4930 <sup>4</sup>	-
V6-3.5	2014		234-9140 <sup>5</sup>	-	234-4922 <sup>5</sup>	-
V6-3.5	2014	RWD	234-9145 <sup>4</sup>	-	234-4922 <sup>4</sup>	-
V6-3.5	2013		234-9129 <sup>5</sup>	-	234-4521 <sup>5</sup>	-
V6-3.5	2013	AWD	234-9129 <sup>4</sup>	-	234-4518 <sup>4</sup>	-
V6-3.5	2013	RWD	234-9144 <sup>4</sup>	-	234-4521 <sup>4</sup>	-
V6-3.5	2012-2011	AWD	234-9068 <sup>4</sup>	-	234-4518 <sup>4</sup>	-
V6-3.5	2012-2011	RWD	234-9068 <sup>4</sup>	-	234-4521 <sup>4</sup>	-
V6-3.5	2012-2009		234-9048 <sup>5</sup>	-	234-4521 <sup>5</sup>	-
V6-3.5	2010-2009		234-9068 <sup>4</sup>	-	234-4521 <sup>4</sup>	-
V6-3.5	2008	From 02/08	234-9068 <sup>4</sup>	-	234-4521 <sup>4</sup>	-
V6-3.5	2008	From 02/08	234-9048 <sup>5</sup>	-	234-4521 <sup>5</sup>	-
V6-3.5	2008	To 02/08	234-9051 <sup>1</sup>	-	234-4521 <sup>1</sup>	-
V6-3.5	2007-2006		234-9051 <sup>1</sup>	-	234-4521 <sup>1</sup>	-
<b>IS F</b>						
V8-5.0	2014-2013		234-9058 <sup>1</sup>	-	234-4521 <sup>1</sup>	-
V8-5.0	2012-2008		234-9048 <sup>1</sup>	-	234-4521 <sup>1</sup>	-
<b>LS400</b>						
V8-4.0	2000-1998		234-4169 <sup>1</sup>	234-4209 <sup>1</sup>	234-4137 <sup>1</sup>	234-4209 <sup>1</sup>
V8-4.0	1997-1995		234-4169 <sup>1</sup>	234-4209 <sup>1</sup>	234-4603 <sup>1</sup>	234-4209 <sup>1</sup>

<sup>1</sup> 2 Required / Requis 2 / Requeridos 2 <sup>4</sup> Left Side / Côté gauche / Lado izquierdo <sup>5</sup> Right Side / Côté droit / Lado derecho



ENGINE MOTEUR MOTOR	YEAR ANNEE AÑO	APPLICATION INFORMATION INFORMATION D'APPLICATION INFORMACION DE APLICACION	UPSTREAM / AVANT - C.C. / ANTES DEL C.C.		DOWNSTREAM / APRES - C.C. / DESPUES DEL C.C.	
			TYPE / TIPO O.E.	UNIVERS.	TYPE / TIPO O.E.	UNIVERS.
<b>LEXUS [cont]</b>						
<b>LS400 [cont]</b>						
V8-4.0	1994-1993		234-4211	234-4000	234-2011	234-2000
V8-4.0	1992-1990		234-4211	234-4000	234-2015	234-2000
<b>LS430</b>						
V8-4.3	2006-2001		234-4138 <sup>4</sup>	234-4209 <sup>4</sup>	234-4167 <sup>4</sup>	234-4209 <sup>4</sup>
V8-4.3	2006-2001		234-4630 <sup>5</sup>	234-4209 <sup>5</sup>	234-4167 <sup>5</sup>	234-4209 <sup>5</sup>
<b>LS460</b>						
V8-4.6	2016-2014	AWD	234-9145 <sup>4</sup>	-	234-4924 <sup>4</sup>	-
V8-4.6	2016-2014	AWD	234-9145 <sup>5</sup>	-	234-4929 <sup>5</sup>	-
V8-4.6	2016	RWD	234-9142 <sup>4</sup>	-	234-4929 <sup>4</sup>	-
V8-4.6	2016	RWD	234-9143 <sup>5</sup>	-	234-4929 <sup>5</sup>	-
V8-4.6	2015-2014	RWD	234-9143 <sup>4</sup>	-	234-4929 <sup>4</sup>	-
V8-4.6	2015-2014	RWD	234-9142 <sup>5</sup>	-	234-4929 <sup>5</sup>	-
V8-4.6	2013-2010	RWD	234-9100 <sup>4</sup>	-	234-4515 <sup>4</sup>	-
V8-4.6	2013-2010	RWD	234-9048 <sup>5</sup>	-	234-4515 <sup>5</sup>	-
V8-4.6	2013-2009	AWD	234-9051 <sup>5</sup>	-	234-4515 <sup>5</sup>	-
V8-4.6	2013-2009	AWD	234-9051 <sup>4</sup>	-	234-4149 <sup>4</sup>	234-4209 <sup>4</sup>
V8-4.6	2009	RWD	234-9052 <sup>4</sup>	-	234-4515 <sup>4</sup>	-
V8-4.6	2009	RWD	234-9058 <sup>5</sup>	-	234-4515 <sup>5</sup>	-
V8-4.6	2008-2007		234-9052 <sup>4</sup>	-	234-4515 <sup>4</sup>	-
V8-4.6	2008-2007		234-9058 <sup>5</sup>	-	234-4515 <sup>5</sup>	-
<b>LS600H</b>						
V8-5.0	2016		234-9145 <sup>1</sup>	-	-	-
V8-5.0	2015-2013		234-9068 <sup>5</sup>	-	234-4515 <sup>5</sup>	-
V8-5.0	2015-2013		234-9068 <sup>4</sup>	-	234-4169 <sup>4</sup>	234-4209 <sup>4</sup>
V8-5.0	2012-2008		234-9051 <sup>5</sup>	-	234-4515 <sup>5</sup>	-
V8-5.0	2012-2008		234-9051 <sup>4</sup>	-	234-4169 <sup>4</sup>	234-4209 <sup>4</sup>
<b>LX450</b>						
L6-4.5	1997-1996		234-4157	234-4206	234-4153	234-4206
<b>LX470</b>						
V8-4.7	2007-2006		234-9051 <sup>1</sup>	-	234-4260 <sup>1</sup>	234-4209 <sup>1</sup>
V8-4.7	2005	From 05/05	234-9051 <sup>1</sup>	-	234-4260 <sup>1</sup>	234-4209 <sup>1</sup>
V8-4.7	2005	To 05/05	234-4138 <sup>1</sup>	234-4209 <sup>1</sup>	234-4154 <sup>1</sup>	234-4206 <sup>1</sup>
V8-4.7	2004-2003		234-4138 <sup>1</sup>	234-4209 <sup>1</sup>	234-4154 <sup>1</sup>	234-4206 <sup>1</sup>
V8-4.7	2002-1998		234-4169 <sup>1</sup>	234-4209 <sup>1</sup>	234-4154 <sup>1</sup>	234-4206 <sup>1</sup>
<b>LX570</b>						
V8-5.7	2016		234-9145 <sup>4</sup>	-	234-4931 <sup>4</sup>	-
V8-5.7	2016		234-9145 <sup>5</sup>	-	234-4927 <sup>5</sup>	-
V8-5.7	2015-2014		234-9145 <sup>5</sup>	-	234-4931 <sup>5</sup>	-
V8-5.7	2015		234-9145 <sup>4</sup>	-	234-4927 <sup>4</sup>	-

<sup>1</sup> 2 Required / Requis 2 / Requeridos 2 <sup>4</sup> Left Side / Côté gauche / Lado izquierdo <sup>5</sup> Right Side / Côté droit / Lado derecho





ENGINE MOTEUR MOTOR	YEAR ANNEE AÑO	APPLICATION INFORMATION INFORMATION D'APPLICATION INFORMACION DE APLICACION	UPSTREAM / AVANT - C.C. / ANTES DEL C.C.		DOWNSTREAM / APRS - C.C. / DESPUES DEL C.C.	
			TYPE / TIPO O.E.	UNIVERS.	TYPE / TIPO O.E.	UNIVERS.
<b>LEXUS [cont]</b>						
<b>LX570 [cont]</b>						
V8-5.7	2014		234-9145 <sup>4</sup>	-	234-4758 <sup>4</sup>	-
V8-5.7	2013		234-9111 <sup>4</sup>	-	234-4260 <sup>4</sup>	234-4209 <sup>4</sup>
V8-5.7	2013		234-9111 <sup>5</sup>	-	234-4169 <sup>5</sup>	234-4209 <sup>5</sup>
V8-5.7	2011-2008		234-9026 <sup>4</sup>	-	234-4260 <sup>4</sup>	234-4209 <sup>4</sup>
V8-5.7	2011-2008		234-9026 <sup>5</sup>	-	234-4169 <sup>5</sup>	234-4209 <sup>5</sup>
<b>NX200T</b>						
L4-2.0	2016-2015		234-9143	-	234-4757	-
<b>NX300H</b>						
L4-2.5	2016-2015		234-9154	-	234-4757	-
<b>RC350</b>						
V6-3.5	2016-2015		234-9140 <sup>5</sup>	-	234-4945 <sup>5</sup>	-
V6-3.5	2016-2015	AWD	234-9143 <sup>4</sup>	-	234-4930 <sup>4</sup>	-
V6-3.5	2016-2015	RWD	234-9145 <sup>4</sup>	-	234-4945 <sup>4</sup>	-
<b>RC F</b>						
V8-5.0	2016-2015		234-9140 <sup>4</sup>	-	234-4945 <sup>4</sup>	-
V8-5.0	2016-2015		234-9143 <sup>5</sup>	-	234-4945 <sup>5</sup>	-
<b>RX300</b>						
V6-3.0	2003-1999		234-9009 <sup>1</sup>	-	234-4215	234-4206
<b>RX330</b>						
V6-3.3	2006-2004		234-9042 <sup>5</sup>	-	234-4509 <sup>5</sup>	-
V6-3.3	2006-2004		234-9042 <sup>4</sup>	-	234-4168 <sup>4</sup>	234-4209 <sup>4</sup>
<b>RX350</b>						
V6-3.5	2015		234-9154 <sup>15</sup>	-	234-4400 <sup>15</sup>	-
V6-3.5	2015		234-9155 <sup>16</sup>	-	234-4509 <sup>16</sup>	-
V6-3.5	2014-2012		234-9115 <sup>4</sup>	-	234-4400 <sup>4</sup>	-
V6-3.5	2014-2012		234-9114 <sup>5</sup>	-	234-4509 <sup>5</sup>	-
V6-3.5	2011	Japan Built	234-9041 <sup>4</sup>	-	234-4400 <sup>4</sup>	-
V6-3.5	2011	Japan Built	234-9042 <sup>5</sup>	-	234-4509 <sup>5</sup>	-
V6-3.5	2011	USA Built	234-9115 <sup>4</sup>	-	234-4400 <sup>4</sup>	-
V6-3.5	2011	USA Built	234-9114 <sup>5</sup>	-	234-4509 <sup>5</sup>	-
V6-3.5	2010		234-9041 <sup>4</sup>	-	234-4400 <sup>4</sup>	-
V6-3.5	2010		234-9042 <sup>5</sup>	-	234-4509 <sup>5</sup>	-
V6-3.5	2009-2008		234-9022 <sup>5</sup>	-	234-4509 <sup>5</sup>	-
V6-3.5	2009-2008		234-9008 <sup>4</sup>	-	234-4149 <sup>4</sup>	234-4209 <sup>4</sup>
V6-3.5	2007	Japan Built	234-9022 <sup>5</sup>	-	234-4509 <sup>5</sup>	-
V6-3.5	2007	Japan Built	234-9008 <sup>4</sup>	-	234-4149 <sup>4</sup>	234-4209 <sup>4</sup>
V6-3.5	2007	USA Built	234-9042 <sup>5</sup>	-	234-4509 <sup>5</sup>	-
V6-3.5	2007	USA Built	234-9041 <sup>4</sup>	-	234-4149 <sup>4</sup>	234-4209 <sup>4</sup>

<sup>1</sup> 2 Required / Requis 2 / Requeridos 2 <sup>4</sup> Left Side / Côté gauche / Lado izquierdo <sup>5</sup> Right Side / Côté droit / Lado derecho <sup>15</sup> Front / Avant / Parte delantera <sup>16</sup> Rear / Arrière / Parte trasera



ENGINE MOTEUR MOTOR	YEAR ANNEE AÑO	APPLICATION INFORMATION INFORMATION D'APPLICATION INFORMACION DE APLICACION	UPSTREAM / AVANT - C.C. / ANTES DEL C.C.		DOWNSTREAM / APRES - C.C. / DESPUES DEL C.C.	
			TYPE / TIPO O.E.	UNIVERS.	TYPE / TIPO O.E.	UNIVERS.
<b>LEXUS [cont]</b>						
<b>RX400H</b>						
V6-3.3	2008		234-9067 <sup>5</sup>	-	234-4502 <sup>5</sup>	-
V6-3.3	2008		234-9068 <sup>4</sup>	-	234-4149 <sup>4</sup>	234-4209 <sup>4</sup>
V6-3.3	2007-2006		234-9042 <sup>5</sup>	-	234-4502 <sup>5</sup>	-
V6-3.3	2007-2006		234-9042 <sup>4</sup>	-	234-4149 <sup>4</sup>	234-4209 <sup>4</sup>
<b>RX450H</b>						
V6-3.5	2015		234-9115 <sup>15</sup>	-	234-4400 <sup>15</sup>	-
V6-3.5	2015		234-9114 <sup>16</sup>	-	234-4928 <sup>16</sup>	-
V6-3.5	2014-2011		234-9115 <sup>4</sup>	-	234-4400 <sup>4</sup>	-
V6-3.5	2014		234-9114 <sup>5</sup>	-	234-4928 <sup>5</sup>	-
V6-3.5	2013-2011		234-9114 <sup>5</sup>	-	234-4509 <sup>5</sup>	-
V6-3.5	2010		234-9041 <sup>4</sup>	-	234-4400 <sup>4</sup>	-
V6-3.5	2010		234-9022 <sup>5</sup>	-	234-4509 <sup>5</sup>	-
<b>SC300</b>						
L6-3.0	2000-1998		234-4626 <sup>15</sup>	234-4209 <sup>15</sup>	234-4139 <sup>15</sup>	234-4209 <sup>15</sup>
L6-3.0	2000-1998		234-4630 <sup>16</sup>	234-4209 <sup>16</sup>	234-4626 <sup>16</sup>	234-4209 <sup>16</sup>
L6-3.0	1997-1996		234-4626 <sup>1</sup>	234-4209 <sup>1</sup>	234-4214	234-4206
L6-3.0	1995		234-1055 <sup>14</sup>	234-1057 <sup>14</sup>	-	-
L6-3.0	1995		234-4626 <sup>13</sup>	234-4209 <sup>13</sup>	234-4214	234-4206
L6-3.0	1994	From 01/94	234-1055 <sup>14</sup>	234-1057 <sup>14</sup>	-	-
L6-3.0	1994	From 01/94.	234-4626 <sup>13</sup>	234-4209 <sup>13</sup>	234-4214	234-4206
L6-3.0	1994	To 01/94	234-1055	234-1057	234-4214	234-4206
L6-3.0	1993-1992		234-1055	234-1057	234-4214	234-4206
<b>SC400</b>						
V8-4.0	2000-1996		234-4169 <sup>1</sup>	234-4209 <sup>1</sup>	234-4603 <sup>1</sup>	234-4209 <sup>1</sup>
V8-4.0	1995-1992		234-4211 <sup>1</sup>	234-4000 <sup>1</sup>	234-4619 <sup>1</sup>	234-4000 <sup>1</sup>
<b>SC430</b>						
V8-4.3	2010-2006		234-4138 <sup>4</sup>	234-4209 <sup>4</sup>	234-4506 <sup>4</sup>	-
V8-4.3	2010-2006		234-4630 <sup>5</sup>	234-4209 <sup>5</sup>	234-4506 <sup>5</sup>	-
V8-4.3	2005-2002		234-4138 <sup>4</sup>	234-4209 <sup>4</sup>	234-4167 <sup>4</sup>	234-4209 <sup>4</sup>
V8-4.3	2005-2002		234-4630 <sup>5</sup>	234-4209 <sup>5</sup>	234-4167 <sup>5</sup>	234-4209 <sup>5</sup>
<b>LINCOLN</b>						
<b>AVIATOR</b>						
V8-4.6	2005-2003		234-4046 <sup>1</sup>	-	234-4187 <sup>1</sup>	-
<b>BLACKWOOD</b>						
V8-5.4	2002		234-4046 <sup>1</sup>	-	234-4127 <sup>1</sup>	234-4212 <sup>1</sup>
<b>CONTINENTAL</b>						
V6-3.8	1994-1992	w/ 18" Sensor	234-4609 <sup>1</sup>	234-4210 <sup>1</sup>	-	-

<sup>1</sup> 2 Required / Requis 2 / Requeridos 2 <sup>4</sup> Left Side / Côté gauche / Lado izquierdo <sup>5</sup> Right Side / Côté droit / Lado derecho <sup>13</sup> Loc. Upper / Empl. supérieur / Ubicación superior <sup>14</sup> Loc. Lower / Empl. inférieur / Ubicación inferior <sup>15</sup> Front / Avant / Parte delantera <sup>16</sup> Rear / Arrière / Parte trasera



ENGINE MOTEUR MOTOR	YEAR ANNEE AÑO	APPLICATION INFORMATION INFORMATION D'APPLICATION INFORMACION DE APLICACION	UPSTREAM / AVANT - C.C. / ANTES DEL C.C.		DOWNSTREAM / APRS - C.C. / DESPUES DEL C.C.		
			TYPE / TIPO O.E.	UNIVERS.	TYPE / TIPO O.E.	UNIVERS.	
<b>LINCOLN [cont]</b>							
<b>CONTINENTAL [cont]</b>							
V6-3.8	1994-1991	w/ 13" Sensor	234-4610 <sup>1</sup>	234-4210 <sup>1</sup>	-	-	
V6-3.8	1990-1988		234-3002 <sup>1</sup>	234-3000 <sup>1</sup>	-	-	
V6-3.8	1982		234-1003	234-1000	-	-	
V8-4.6	2002-1998		234-4046 <sup>1</sup>	-	234-4610 <sup>1</sup>	234-4210 <sup>1</sup>	
V8-4.6	1997		234-4610 <sup>1</sup>	234-4210 <sup>1</sup>	234-4610 <sup>1</sup>	234-4210 <sup>1</sup>	
V8-4.6	1996-1995		234-4609	234-4210	-	-	
V8-5.0	1987		234-3002 <sup>1</sup>	234-3000 <sup>1</sup>	-	-	
V8-5.0	1986		234-3001	234-3000	-	-	
V8-5.0	1985-1982		234-1003	234-1000	-	-	
V8-5.0	1980		234-1003	234-1000	-	-	
V8-5.8	1980		234-1003	234-1000	-	-	
<b>LS</b>							
V6-3.0	2005-2003		234-4046 <sup>1</sup>	-	234-4610 <sup>1</sup>	234-4210 <sup>1</sup>	
V6-3.0	2002-2000	Auto Trans	234-4046 <sup>1</sup>	-	234-4609 <sup>1</sup>	234-4210 <sup>1</sup>	
V6-3.0	2002-2000	Manual Trans	234-4046 <sup>1</sup>	-	234-4610 <sup>1</sup>	234-4210 <sup>1</sup>	
V8-3.9	2006-2004		234-4046 <sup>1</sup>	-	234-4610 <sup>1</sup>	234-4210 <sup>1</sup>	
V8-3.9	2003-2000		234-4046 <sup>1</sup>	-	234-4609 <sup>1</sup>	234-4210 <sup>1</sup>	
<b>MARK LT</b>							
V8-5.4	2008-2006		234-4401 <sup>1</sup>	-	234-4401 <sup>1</sup>	-	
<b>MARK VI</b>							
V8-5.0	1983-1980		234-1003	234-1000	-	-	
V8-5.8	1980		234-1003	234-1000	-	-	
<b>MARK VII</b>							
V8-5.0	1992-1988		234-3002 <sup>1</sup>	234-3000 <sup>1</sup>	-	-	
V8-5.0	1987	VIN F	234-3002 <sup>1</sup>	234-3000 <sup>1</sup>	-	-	
V8-5.0	1987	VIN M	234-3001 <sup>1</sup>	234-3000 <sup>1</sup>	-	-	
V8-5.0	1986		234-3001	234-3000	-	-	
V8-5.0	1985-1984	Exc. LSC	234-1003	234-1000	-	-	
V8-5.0	1985	LSC	234-3001	234-3000	-	-	
<b>MARK VIII</b>							
V8-4.6	1998-1996		234-4610	234-4210	234-4610	234-4210	
V8-4.6	1995-1993	w/ 13" Sensor	234-4610 <sup>1</sup>	234-4210 <sup>1</sup>	-	-	
V8-4.6	1994-1993	w/ 18" Sensor	234-4609 <sup>1</sup>	234-4210 <sup>1</sup>	-	-	
<b>MKC</b>							
L4-2.0	2015		234-5097	-	234-4575	-	
L4-2.3	2015		234-5113	-	234-4575	-	
<b>MKS</b>							
V6-3.5	2015-2011		234-5113 <sup>5</sup>	-	234-4491 <sup>5</sup>	-	
V6-3.5	2015-2010		234-5113 <sup>4</sup>	-	234-4610 <sup>4</sup>	234-4210 <sup>4</sup>	
V6-3.5	2010		234-5113 <sup>5</sup>	-	234-4609 <sup>5</sup>	234-4210 <sup>5</sup>	

<sup>1</sup> 2 Required / Requis 2 / Requeridos 2 <sup>4</sup> Left Side / Côté gauche / Lado izquierdo <sup>5</sup> Right Side / Côté droit / Lado derecho



ENGINE MOTEUR MOTOR	YEAR ANNEE AÑO	APPLICATION INFORMATION INFORMATION D'APPLICATION INFORMACION DE APLICACION	UPSTREAM / AVANT - C.C. / ANTES DEL C.C.		DOWNSTREAM / APRES - C.C. / DESPUES DEL C.C.	
			TYPE / TIPO O.E.	UNIVERS.	TYPE / TIPO O.E.	UNIVERS.
<b>LINCOLN [cont]</b>						
<b>MKS [cont]</b>						
V6-3.7	2015		234-5151 <sup>1</sup>	-	234-4490 <sup>1</sup>	-
V6-3.7	2014-2013		234-5038 <sup>1</sup>	-	234-4490 <sup>1</sup>	-
V6-3.7	2012-2011		234-5097 <sup>1</sup>	-	234-4489 <sup>1</sup>	-
V6-3.7	2010-2009		234-5097 <sup>1</sup>	-	234-4610 <sup>1</sup>	234-4210 <sup>1</sup>
<b>MKT</b>						
L4-2.0	2014-2013		234-5097	-	234-4575	-
V6-3.5	2015-2014		234-5113 <sup>4</sup>	-	234-4489 <sup>4</sup>	-
V6-3.5	2015-2014		234-5113 <sup>5</sup>	-	234-4491 <sup>5</sup>	-
V6-3.5	2013-2011		234-5113 <sup>4</sup>	-	234-4491 <sup>4</sup>	-
V6-3.5	2013-2011		234-5113 <sup>5</sup>	-	234-4489 <sup>5</sup>	-
V6-3.5	2010		234-5113 <sup>4</sup>	-	234-4610 <sup>4</sup>	234-4210 <sup>4</sup>
V6-3.5	2010		234-5113 <sup>5</sup>	-	234-4609 <sup>5</sup>	234-4210 <sup>5</sup>
V6-3.7	2015		234-5038 <sup>1</sup>	-	234-4490 <sup>1</sup>	-
V6-3.7	2014-2013	w/ 15" Downstream Left Sensor	234-5038 <sup>4</sup>	-	234-4490 <sup>4</sup>	-
V6-3.7	2014-2013	w/ 17.5" Downstream Right Sensor	234-5038 <sup>5</sup>	-	234-4490 <sup>5</sup>	-
V6-3.7	2014-2013	w/ 31.5" Downstream Sensors	234-5038 <sup>1</sup>	-	234-4936 <sup>1</sup>	-
V6-3.7	2012-2011		234-5097 <sup>1</sup>	-	234-4489 <sup>1</sup>	-
V6-3.7	2010		234-5097 <sup>1</sup>	-	234-4610 <sup>1</sup>	234-4210 <sup>1</sup>
<b>MKX</b>						
V6-3.5	2010		234-5097 <sup>1</sup>	-	234-4610 <sup>1</sup>	234-4210 <sup>1</sup>
V6-3.5	2009-2007		234-4372 <sup>1</sup>	-	234-4610 <sup>1</sup>	234-4210 <sup>1</sup>
V6-3.7	2014-2012		234-5038 <sup>1</sup>	-	234-4489 <sup>1</sup>	-
V6-3.7	2011		234-5097 <sup>1</sup>	-	234-4489 <sup>1</sup>	-
<b>MKZ</b>						
L4-2.0	2015-2013	Gas Engine	234-5097	-	234-4575	-
L4-2.0	2015-2013	Hybrid Engine	234-5068	-	234-4578	-
L4-2.5	2012-2011		234-5113	-	234-4490	-
V6-3.5	2012-2011		234-4492 <sup>1</sup>	-	234-4489 <sup>1</sup>	-
V6-3.5	2010-2007		234-4372 <sup>1</sup>	-	234-4610 <sup>1</sup>	234-4210 <sup>1</sup>
V6-3.7	2015-2014		234-5038 <sup>1</sup>	-	234-4490 <sup>1</sup>	-
V6-3.7	2013		234-5038 <sup>4</sup>	-	234-4490 <sup>4</sup>	-
V6-3.7	2013		234-5038 <sup>5</sup>	-	234-4490 <sup>5</sup>	-
<b>NAVIGATOR</b>						
V6-3.5	2015		234-5076	-	234-4944	-
V8-5.4	2014-2012		234-5076 <sup>4</sup>	-	234-4576 <sup>4</sup>	-
V8-5.4	2014-2012		234-5113 <sup>5</sup>	-	234-4576 <sup>5</sup>	-
V8-5.4	2011-2009		234-5113 <sup>5</sup>	-	234-4127 <sup>5</sup>	234-4212 <sup>5</sup>
V8-5.4	2011	From 12/17/2010	234-5076 <sup>4</sup>	-	234-4127 <sup>4</sup>	234-4212 <sup>4</sup>
V8-5.4	2011	To 12/17/2010	234-5108 <sup>4</sup>	-	234-4127 <sup>4</sup>	234-4212 <sup>4</sup>

<sup>1</sup> 2 Required / Requis 2 / Requeridos 2 <sup>4</sup> Left Side / Côté gauche / Lado izquierdo <sup>5</sup> Right Side / Côté droit / Lado derecho



ENGINE MOTEUR MOTOR	YEAR ANNEE AÑO	APPLICATION INFORMATION INFORMATION D'APPLICATION INFORMACION DE APLICACION	UPSTREAM / AVANT - C.C. / ANTES DEL C.C.		DOWNSTREAM / APRS - C.C. / DESPUES DEL C.C.	
			TYPE / TIPO O.E.	UNIVERS.	TYPE / TIPO O.E.	UNIVERS.
<b>LINCOLN [cont]</b>						
<b>NAVIGATOR [cont]</b>						
V8-5.4	2010-2009		234-5108 <sup>4</sup>	-	234-4127 <sup>4</sup>	234-4212 <sup>4</sup>
V8-5.4	2008-2007		234-4401 <sup>5</sup>	-	234-4127 <sup>5</sup>	234-4212 <sup>5</sup>
V8-5.4	2008		234-4403 <sup>4</sup>	-	234-4127 <sup>4</sup>	234-4212 <sup>4</sup>
V8-5.4	2007	w/ 11" Upstream Left Sensor	234-4401 <sup>4</sup>	-	234-4127 <sup>4</sup>	234-4212 <sup>4</sup>
V8-5.4	2007	w/ 15" Upstream Left Sensor	234-4403 <sup>4</sup>	-	234-4127 <sup>4</sup>	234-4212 <sup>4</sup>
V8-5.4	2006-2005		234-4401 <sup>1</sup>	-	234-4127 <sup>1</sup>	234-4212 <sup>1</sup>
V8-5.4	2004-2003		234-4046 <sup>1</sup>	-	234-4127 <sup>1</sup>	234-4212 <sup>1</sup>
V8-5.4	2002-2001		234-4401 <sup>1</sup>	-	234-4127 <sup>1</sup>	234-4212 <sup>1</sup>
V8-5.4	2000-1999		234-4046 <sup>1</sup>	-	234-4127 <sup>1</sup>	234-4212 <sup>1</sup>
V8-5.4	1998		234-4071 <sup>1</sup>	234-4212 <sup>1</sup>	234-4127 <sup>1</sup>	234-4212 <sup>1</sup>
<b>TOWN CAR</b>						
V8-4.6	2011-2007		234-4373 <sup>1</sup>	-	234-4609 <sup>1</sup>	234-4210 <sup>1</sup>
V8-4.6	2006	From 12/05/05	234-4373 <sup>1</sup>	-	234-4609 <sup>1</sup>	234-4210 <sup>1</sup>
V8-4.6	2006	To 12/05/05	234-4045 <sup>1</sup>	-	234-4609 <sup>1</sup>	234-4210 <sup>1</sup>
V8-4.6	2005-2000		234-4045 <sup>1</sup>	-	234-4609 <sup>1</sup>	234-4210 <sup>1</sup>
V8-4.6	1999-1998	Calif.	234-4045 <sup>1</sup>	-	234-4609 <sup>1</sup>	234-4210 <sup>1</sup>
V8-4.6	1999-1998	Exc. Calif.	234-4046 <sup>1</sup>	-	234-4609 <sup>1</sup>	234-4210 <sup>1</sup>
V8-4.6	1997-1995		234-4609	234-4210	234-4609	234-4210
V8-4.6	1995		234-4609 <sup>1</sup>	234-4210 <sup>1</sup>	-	-
V8-4.6	1994	Calif.	234-4609 <sup>1</sup>	234-4210 <sup>1</sup>	-	-
V8-4.6	1994	Exc. Calif.	234-4610 <sup>1</sup>	234-4210 <sup>1</sup>	-	-
V8-4.6	1993-1991		234-4610 <sup>1</sup>	234-4210 <sup>1</sup>	-	-
V8-5.0	1990-1987		234-3002 <sup>1</sup>	234-3000 <sup>1</sup>	-	-
V8-5.0	1986		234-3001	234-3000	-	-
V8-5.0	1985-1981		234-1003	234-1000	-	-
<b>VERSAILLES</b>						
V8-5.0	1980		234-1003	234-1000	-	-
<b>ZEPHYR</b>						
V6-3.0	2006		234-4374 <sup>1</sup>	-	234-4610 <sup>1</sup>	234-4210 <sup>1</sup>
<b>MAZDA</b>						
<b>2</b>						
L4-1.5	2014-2011		234-9103	-	234-4329	-
<b>3</b>						
L4-2.0	2015-2014		234-5059	-	234-4939	-
L4-2.0	2013	VIN 8	234-5063	-	234-4584	-
L4-2.0	2013	VIN F	234-5058	-	234-4467	-
L4-2.0	2013	VIN G	234-5058	-	234-4467	-
L4-2.0	2012	Exc. SkyActiv Engine; VIN F & VIN G	234-5058	-	234-4467	-
L4-2.0	2012	SkyActiv Engine; VIN 8	234-5063	-	234-4584	-

<sup>1</sup> 2 Required / Requis 2 / Requeridos 2 <sup>4</sup> Left Side / Côté gauche / Lado izquierdo <sup>5</sup> Right Side / Côté droit / Lado derecho



ENGINE MOTEUR MOTOR	YEAR ANNEE AÑO	APPLICATION INFORMATION INFORMATION D'APPLICATION INFORMACION DE APLICACION	UPSTREAM / AVANT - C.C. / ANTES DEL C.C.		DOWNSTREAM / APRES - C.C. / DESPUES DEL C.C.	
			TYPE / TIPO O.E.	UNIVERS.	TYPE / TIPO O.E.	UNIVERS.
<b>MAZDA [cont]</b>						
<b>3 [cont]</b>						
L4-2.0	2011-2010	Calif.	234-5040	-	234-4467	-
L4-2.0	2011-2010	Exc. Calif.	234-5015	-	234-4467	-
L4-2.0	2009-2006	Exc. Calif. & Canada	234-5015	-	234-4392	-
L4-2.0	2009-2004	Calif.	234-9085	-	234-4329 <sup>1</sup>	-
L4-2.0	2005-2004	Exc. Calif. & Canada	234-4396	-	234-4390	-
L4-2.3	2013-2010		234-5042	-	234-4391	-
L4-2.3	2009-2007	Non-Turbo; Calif.	234-9085	-	234-4329 <sup>1</sup>	-
L4-2.3	2009-2007	Non-Turbo; Exc. Calif. & Canada	234-5015	-	234-4392	-
L4-2.3	2009-2007	Turbo	234-5013	-	234-4391	-
L4-2.3	2006	Calif.	234-9085	-	234-4329 <sup>1</sup>	-
L4-2.3	2006	Exc. Calif. & Canada	234-5015	-	234-4392	-
L4-2.3	2005-2004		234-4396	-	234-4390	-
L4-2.5	2015-2014		234-5059	-	234-4939	-
L4-2.5	2013-2012		234-5078	-	234-4505	-
L4-2.5	2011	Mexico Model	234-5041	-	234-4467	-
L4-2.5	2011	US & Canada Model	234-5078	-	234-4505	-
L4-2.5	2010		234-5041	-	234-4467	-
<b>3 SPORT</b>						
L4-2.0	2014		234-5059	-	234-4939	-
L4-2.0	2013-2012	VIN 8	234-5063	-	234-4584	-
L4-2.0	2013-2012	VIN F	234-5058	-	234-4467	-
L4-2.0	2010		234-5015	-	234-4467 <sup>1</sup>	-
L4-2.0	2009		234-5015	-	234-4392	-
L4-2.5	2014		234-5059	-	234-4939	-
L4-2.5	2013-2012		234-5078	-	234-4505	-
L4-2.5	2010		234-5041	-	234-4467 <sup>1</sup>	-
<b>5</b>						
L4-2.3	2010-2008		234-5015	-	234-4118	-
L4-2.3	2007-2006		234-4396	-	234-4390	-
L4-2.5	2014-2012		234-5077	-	234-4505	-
<b>6</b>						
L4-2.3	2008	Calif.; Auto Trans	234-9087	-	234-4329	234-4209
L4-2.3	2008	Calif.; Auto Trans.	-	-	234-4752 <sup>12</sup>	234-4209 <sup>12</sup>
L4-2.3	2008	Calif.; Manual Trans	234-5011	-	234-4394	-
L4-2.3	2008	Exc. Calif. & Canada	234-5011	-	234-4394	-
L4-2.3	2007-2006	Non-Turbo; Calif.; Auto Trans	234-9087	-	234-4329	-
L4-2.3	2007-2006	Non-Turbo; Calif.; Auto Trans.	-	-	234-4752 <sup>12</sup>	234-4209 <sup>12</sup>
L4-2.3	2007-2006	Non-Turbo; Calif.; Manual Trans	234-5011	-	234-4394	-
L4-2.3	2007-2006	Non-Turbo; Exc. Calif. & Canada	234-5011	-	234-4394	-
L4-2.3	2007-2006	Turbo	234-5014	-	234-4395	-
L4-2.3	2005	Calif.; Auto Trans	234-9086	-	234-4752	234-4209

<sup>1</sup> 2 Required / Requis 2 / Requeridos 2 <sup>12</sup> Loc. Center / Empl. central / Ubicación central



ENGINE MOTEUR MOTOR	YEAR ANNEE AÑO	APPLICATION INFORMATION INFORMATION D'APPLICATION INFORMACION DE APLICACION	UPSTREAM / AVANT - C.C. / ANTES DEL C.C.		DOWNSTREAM / APRS - C.C. / DESPUES DEL C.C.	
			TYPE / TIPO O.E.	UNIVERS.	TYPE / TIPO O.E.	UNIVERS.
<b>MAZDA [cont]</b>						
<b>6 [cont]</b>						
L4-2.3	2005	Calif.; Auto Trans	-	-	234-4376 <sup>12</sup>	-
L4-2.3	2005	Calif.; Manual Trans	234-4399	-	234-4393	-
L4-2.3	2005	Exc. Calif. & Canada	234-4399	-	234-4393	-
L4-2.3	2004-2003		234-4399	-	234-4393	-
L4-2.5	2015-2014		234-5059	-	234-4939	-
L4-2.5	2013-2009		234-5033	-	234-4279	-
V6-3.0	2008-2006		234-4398 <sup>15</sup>	-	234-4393 <sup>15</sup>	-
V6-3.0	2008-2006		234-4190 <sup>16</sup>	-	234-4393 <sup>16</sup>	-
V6-3.0	2005-2003		234-4398 <sup>15</sup>	-	234-4397 <sup>15</sup>	-
V6-3.0	2005-2003		234-4190 <sup>16</sup>	-	234-4040 <sup>16</sup>	234-4210 <sup>16</sup>
V6-3.7	2013-2011		234-5038 <sup>1</sup>	-	234-4489 <sup>1</sup>	-
V6-3.7	2010-2009		234-5032 <sup>1</sup>	-	234-4610 <sup>1</sup>	234-4210 <sup>1</sup>
<b>323</b>						
L4-1.6	1995-1990		234-1010	234-1000	-	-
L4-1.6	1989-1986		234-1019	234-1000	-	-
L4-1.8	1995	DOHC	234-4144	234-4209	-	-
L4-1.8	1995	SOHC	234-1010	234-1000	-	-
L4-1.8	1994-1993	1 Lead Sensor	234-1010	234-1000	-	-
L4-1.8	1994-1993	4 Lead Sensor	234-4144	234-4209	-	-
L4-1.8	1991-1990		234-1010	234-1000	-	-
<b>626</b>						
L4-2.0	2002-2001		234-4126	-	234-4043	234-4210
L4-2.0	2000	Calif.	234-4126	-	234-4043	234-4210
L4-2.0	2000	Exc. Calif.	234-4629	234-4210	234-4044	234-4210
L4-2.0	1999-1998	Calif.	234-3085	234-3000	234-4041	234-4210
L4-2.0	1999-1998	Exc. Calif.	234-4629	234-4210	234-4039	234-4210
L4-2.0	1997-1996	Auto Trans	234-4629	234-4210	234-4067	234-4210
L4-2.0	1997-1996	Manual Trans	234-3010	234-3000	234-4067	234-4210
L4-2.0	1995-1993		234-4068	234-4210	-	-
L4-2.0	1987-1983	w/ 13" Sensor	234-1012	234-1000	-	-
L4-2.0	1985-1983	w/ 21" Sensor	234-1019	234-1000	-	-
L4-2.2	1992-1990		234-1020	234-1000	-	-
L4-2.2	1989-1988		234-1019	234-1000	-	-
V6-2.5	2002-2001		234-4148 <sup>15</sup>	-	234-4044 <sup>15</sup>	234-4210 <sup>15</sup>
V6-2.5	2002-2001		234-4117 <sup>16</sup>	-	234-4040 <sup>16</sup>	234-4210 <sup>16</sup>
V6-2.5	2000	Calif.	234-4148 <sup>15</sup>	-	234-4044 <sup>15</sup>	234-4210 <sup>15</sup>
V6-2.5	2000	Calif.	234-4117 <sup>16</sup>	-	234-4040 <sup>16</sup>	234-4210 <sup>16</sup>
V6-2.5	2000	Exc. Calif. & Canada; Upstream Sensor in Exhaust Pipe	234-4068 <sup>17</sup>	234-4210 <sup>17</sup>	234-4039 <sup>17</sup>	234-4210 <sup>17</sup>
V6-2.5	2000	Exc. Calif. & Canada; Upstream Sensor in Manifold	234-4041 <sup>15</sup>	234-4210 <sup>15</sup>	-	-
V6-2.5	2000	Exc. Calif. & Canada; Upstream Sensor in Manifold	234-4067 <sup>16</sup>	234-4210 <sup>16</sup>	-	-

<sup>1</sup> 2 Required / Requis 2 / Requeridos 2 <sup>15</sup> Front / Avant / Parte delantera <sup>16</sup> Rear / Arrière / Parte trasera <sup>17</sup> Location Exhaust Pipe / Empl. tuyau d'éch / Ubicación tubo de escape



ENGINE MOTEUR MOTOR	YEAR ANNEE AÑO	APPLICATION INFORMATION INFORMATION D'APPLICATION INFORMACION DE APLICACION	UPSTREAM / AVANT - C.C. / ANTES DEL C.C.		DOWNSTREAM / APRS - C.C. / DESPUES DEL C.C.	
			TYPE / TIPO O.E.	UNIVERS.	TYPE / TIPO O.E.	UNIVERS.
<b>MAZDA [cont]</b>						
<b>626 [cont]</b>						
V6-2.5	1999-1998	Upstream Sensor in Exhaust Pipe	234-4068 <sup>17</sup>	234-4210 <sup>17</sup>	234-4039 <sup>17</sup>	234-4210 <sup>17</sup>
V6-2.5	1999-1998	Upstream Sensor in Manifold	234-4041 <sup>15</sup>	234-4210 <sup>15</sup>	-	-
V6-2.5	1999-1998	Upstream Sensor in Manifold	234-4067 <sup>16</sup>	234-4210 <sup>16</sup>	-	-
V6-2.5	1997	Upstream Sensor in Exhaust Pipe	234-4068 <sup>17</sup>	234-4210 <sup>17</sup>	-	-
V6-2.5	1997	Upstream Sensor in Manifold	234-3084 <sup>1</sup>	234-3000 <sup>1</sup>	234-4039	234-4210
V6-2.5	1996	Canada Model	234-4068 <sup>15</sup>	234-4210 <sup>15</sup>	-	-
V6-2.5	1996	Canada Model	234-4067 <sup>16</sup>	234-4210 <sup>16</sup>	-	-
V6-2.5	1996	USA Model	234-3084 <sup>15</sup>	234-3000 <sup>15</sup>	234-4628 <sup>15</sup>	234-4210 <sup>15</sup>
V6-2.5	1996	USA Model	234-3084 <sup>16</sup>	234-3000 <sup>16</sup>	234-4627 <sup>16</sup>	234-4210 <sup>16</sup>
V6-2.5	1995-1994	Calif.	234-3042 <sup>1</sup>	234-3000 <sup>1</sup>	-	-
V6-2.5	1995-1994	Exc. Calif. & Canada	234-4068 <sup>15</sup>	234-4210 <sup>15</sup>	-	-
V6-2.5	1995-1994	Exc. Calif. & Canada	234-4067 <sup>16</sup>	234-4210 <sup>16</sup>	-	-
V6-2.5	1993		234-4068 <sup>15</sup>	234-4210 <sup>15</sup>	-	-
V6-2.5	1993		234-4067 <sup>16</sup>	234-4210 <sup>16</sup>	-	-
<b>929</b>						
V6-3.0	1995-1992		234-4067 <sup>4</sup>	234-4210 <sup>4</sup>	-	-
V6-3.0	1995-1992		234-4068 <sup>5</sup>	234-4210 <sup>5</sup>	-	-
V6-3.0	1991-1990	DOHC	234-4086	234-4210	-	-
V6-3.0	1991-1990	SOHC	234-3086	234-3000	-	-
V6-3.0	1989-1988		234-3086	234-3000	-	-
<b>B2000</b>						
L4-2.0	1987-1986		234-1014	234-1000	-	-
<b>B2200</b>						
L4-2.2	1993-1990	Carbureted	234-1014	234-1000	-	-
L4-2.2	1993-1990	Fuel Injected	234-2004	234-2000	-	-
L4-2.2	1989-1987		234-1014	234-1000	-	-
<b>B2300</b>						
L4-2.3	2010-2004	w/ 11" Downstream Sensor	234-4401	-	234-4071	234-4212
L4-2.3	2010-2004	w/ 19" Downstream Sensor	234-4401	-	234-4127	234-4212
L4-2.3	2010-2004	w/ 24" Downstream Sensor	234-4401	-	234-4070	234-4212
L4-2.3	2003-2001		234-4401	-	234-4071	234-4212
L4-2.3	1997-1995		234-4127	234-4212	234-4611	234-4210
L4-2.3	1994	Calif.	234-4001	234-4212	-	-
L4-2.3	1994	Exc. Calif.	234-3002	234-3000	-	-
<b>B2500</b>						
L4-2.5	2001-1999		234-4071	234-4212	234-4070	234-4212
L4-2.5	1998		234-4127	234-4212	234-4070	234-4212
<b>B2600</b>						
L4-2.6	1993-1989		234-2004	234-2000	-	-
L4-2.6	1988-1987		234-1012	234-1000	-	-

<sup>1</sup> 2 Required / Requis 2 / Requeridos 2 <sup>4</sup> Left Side / Côté gauche / Lado izquierdo <sup>5</sup> Right Side / Côté droit / Lado derecho <sup>15</sup> Front / Avant / Parte delantera <sup>16</sup> Rear / Arrière / Parte trasera <sup>17</sup> Location Exhaust Pipe / Empl. tuyau d'éch / Ubicación tubo de escape





ENGINE MOTEUR MOTOR	YEAR ANNEE AÑO	APPLICATION INFORMATION INFORMATION D'APPLICATION INFORMACION DE APLICACION	UPSTREAM / AVANT - C.C. / ANTES DEL C.C.		DOWNSTREAM / APRES - C.C. / DESPUES DEL C.C.	
			TYPE / TIPO O.E.	UNIVERS.	TYPE / TIPO O.E.	UNIVERS.
<b>MAZDA [cont]</b>						
<b>B3000</b>						
V6-3.0	2008-2007		234-4403 <sup>4</sup>	-	234-4071 <sup>4</sup>	234-4212 <sup>4</sup>
V6-3.0	2008-2007		234-4401 <sup>5</sup>	-	234-4127 <sup>5</sup>	234-4212 <sup>5</sup>
V6-3.0	2006-2004	w/ 19" Downstream Sensor	234-4401 <sup>1</sup>	-	234-4127	234-4212
V6-3.0	2006-2001	w/ 11" Downstream Sensor	234-4401 <sup>1</sup>	-	234-4071	234-4212
V6-3.0	2006-2001	w/ 24" Downstream Sensor	234-4401 <sup>1</sup>	-	234-4070	234-4212
V6-3.0	2000-1998		234-4071 <sup>4</sup>	234-4212 <sup>4</sup>	234-4070	234-4212
V6-3.0	2000-1998		234-4127 <sup>5</sup>	234-4212 <sup>5</sup>	-	-
V6-3.0	1997-1995		234-4127 <sup>1</sup>	234-4212 <sup>1</sup>	234-4070	234-4212
V6-3.0	1994		234-4070 <sup>1</sup>	234-4212 <sup>1</sup>	-	-
<b>B4000</b>						
V6-4.0	2010-2007		234-4403 <sup>4</sup>	-	234-4071 <sup>4</sup>	234-4212 <sup>4</sup>
V6-4.0	2010-2007		234-4403 <sup>5</sup>	-	234-4127 <sup>5</sup>	234-4212 <sup>5</sup>
V6-4.0	2006-2004	w/ 11" Downstream Sensor	234-4403 <sup>1</sup>	-	234-4071 <sup>1</sup>	234-4212 <sup>1</sup>
V6-4.0	2006-2004	w/ 19" Downstream Sensor	234-4403 <sup>1</sup>	-	234-4127 <sup>1</sup>	234-4212 <sup>1</sup>
V6-4.0	2006-2004	w/ 24" Downstream Sensor	234-4403 <sup>1</sup>	-	234-4070 <sup>1</sup>	234-4212 <sup>1</sup>
V6-4.0	2003-2001	w/ 11" Downstream Sensor	234-4403 <sup>1</sup>	-	234-4071	234-4212
V6-4.0	2003-2001	w/ 22" Downstream Sensor	234-4403 <sup>1</sup>	-	234-4070	234-4212
V6-4.0	2000-1997		234-4071 <sup>4</sup>	234-4212 <sup>4</sup>	234-4070	234-4212
V6-4.0	2000-1997		234-4127 <sup>5</sup>	234-4212 <sup>5</sup>	-	-
V6-4.0	1996-1995		234-4127 <sup>1</sup>	234-4212 <sup>1</sup>	234-4070 <sup>1</sup>	234-4212 <sup>1</sup>
V6-4.0	1994		234-4070 <sup>1</sup>	234-4212 <sup>1</sup>	-	-
<b>CX-5</b>						
L4-2.0	2015-2013		234-5059	-	234-4583	-
L4-2.5	2015-2014		234-5059	-	234-4583	-
<b>CX-7</b>						
L4-2.3	2012-2007		234-5012	-	234-4044	-
L4-2.5	2012-2010		234-5043	-	234-4466	-
<b>CX-9</b>						
V6-3.5	2007		234-4372 <sup>1</sup>	-	234-4610 <sup>1</sup>	234-4210 <sup>1</sup>
V6-3.7	2015-2011		234-5038 <sup>1</sup>	-	234-4489 <sup>1</sup>	-
V6-3.7	2010-2008		234-4372 <sup>1</sup>	-	234-4610 <sup>1</sup>	234-4210 <sup>1</sup>
<b>GLC</b>						
L4-1.5	1985-1983		234-1012	234-1000	-	-
<b>MIATA</b>						
L4-1.6	1993-1990		234-1024	234-1000	-	-
L4-1.8	2005-2004	Non-Turbo	234-4723	-	234-4330	-
L4-1.8	2005-2004	Turbo	234-4722	-	234-4330	-
L4-1.8	2003-2001		234-4723	-	234-4330	-

<sup>1</sup> 2 Required / Requis 2 / Requeridos 2 <sup>4</sup> Left Side / Côté gauche / Lado izquierdo <sup>5</sup> Right Side / Côté droit / Lado derecho



ENGINE MOTEUR MOTOR	YEAR ANNEE AÑO	APPLICATION INFORMATION INFORMATION D'APPLICATION INFORMACION DE APLICACION	UPSTREAM / AVANT - C.C. / ANTES DEL C.C.		DOWNSTREAM / APRS - C.C. / DESPUES DEL C.C.	
			TYPE / TIPO O.E.	UNIVERS.	TYPE / TIPO O.E.	UNIVERS.
<b>MAZDA [cont]</b>						
<b>MIATA [cont]</b>						
L4-1.8	2000-1999	Calif.	234-4606	234-4209	234-4144	234-4209
L4-1.8	2000-1999	Exc. Calif.	234-4144	234-4209	234-4333	-
L4-1.8	1997		234-4144	234-4209	234-4333	-
L4-1.8	1996		234-4144	234-4209	234-4145	234-4209
L4-1.8	1995-1994		234-4144	234-4209	-	-
<b>MILLENNIA</b>						
V6-2.3	2002-1995		234-3008 <sup>4</sup>	234-3000 <sup>4</sup>	234-4039 <sup>4</sup>	234-4210 <sup>4</sup>
V6-2.3	2002-1995		234-3012 <sup>5</sup>	234-3000 <sup>5</sup>	234-4612 <sup>5</sup>	234-4210 <sup>5</sup>
V6-2.5	2002-2001		234-4148 <sup>4</sup>	-	234-4629 <sup>4</sup>	234-4210 <sup>4</sup>
V6-2.5	2002-2001		234-4121 <sup>5</sup>	-	234-4612 <sup>5</sup>	234-4210 <sup>5</sup>
V6-2.5	2000-1997		234-4629 <sup>15</sup>	234-4210 <sup>15</sup>	234-4038 <sup>15</sup>	234-4210 <sup>15</sup>
V6-2.5	2000-1997		234-4036 <sup>16</sup>	234-4210 <sup>16</sup>	234-4037 <sup>16</sup>	234-4210 <sup>16</sup>
V6-2.5	1996-1995		234-3009 <sup>15</sup>	234-3000 <sup>15</sup>	234-4629 <sup>15</sup>	234-4210 <sup>15</sup>
V6-2.5	1996-1995		234-3008 <sup>16</sup>	234-3000 <sup>16</sup>	234-4039 <sup>16</sup>	234-4210 <sup>16</sup>
<b>MPV</b>						
L4-2.6	1994-1989		234-2006	234-2000	-	-
V6-2.5	2001-2000	Calif.	234-4722 <sup>4</sup>	-	234-4752 <sup>4</sup>	234-4209 <sup>4</sup>
V6-2.5	2001-2000	Calif.	234-4725 <sup>5</sup>	-	234-4141 <sup>5</sup>	234-4209 <sup>5</sup>
V6-2.5	2001-2000	Exc. Calif.	234-4722 <sup>4</sup>	-	234-4143	234-4209
V6-2.5	2001-2000	Exc. Calif.	234-4725 <sup>5</sup>	-	-	-
V6-2.5	2001-2000	Exc. Calif.; Upstream Sensor in Exhaust Pipe	234-4750 <sup>17</sup>	234-4209 <sup>17</sup>	-	-
V6-3.0	2006-2002		234-4725 <sup>15</sup>	-	234-4142 <sup>15</sup>	234-4209 <sup>15</sup>
V6-3.0	2006-2002		234-4724 <sup>16</sup>	-	234-4141 <sup>16</sup>	234-4209 <sup>16</sup>
V6-3.0	1998-1996	4WD	234-4147	234-4209	234-4141	234-4209
V6-3.0	1998-1996	RWD	234-4147	234-4209	234-4142	234-4209
V6-3.0	1995-1992		234-4037	234-4210	-	-
V6-3.0	1991	Auto Trans; From 07/01/90	234-4037	234-4210	-	-
V6-3.0	1991	Auto Trans; To 07/01/90	234-3086	234-3000	-	-
V6-3.0	1991	Manual Trans	234-3086	234-3000	-	-
V6-3.0	1990-1989		234-3086	234-3000	-	-
<b>MX-3</b>						
L4-1.6	1996		234-3085	234-3000	234-4612	234-4210
L4-1.6	1995-1994		234-3085	234-3000	-	-
L4-1.6	1993-1992		234-1010	234-1000	-	-
V6-1.8	1995-1992		234-4143 <sup>15</sup>	234-4209 <sup>15</sup>	-	-
V6-1.8	1995-1992		234-4606 <sup>16</sup>	234-4209 <sup>16</sup>	-	-
<b>MX-5 MIATA</b>						
L4-2.0	2015-2009		234-9093	-	234-4340	-
L4-2.0	2008-2006		234-9088	-	234-4340	-

<sup>4</sup> Left Side / Côté gauche / Lado izquierdo <sup>5</sup> Right Side / Côté droit / Lado derecho <sup>15</sup> Front / Avant / Parte delantera <sup>16</sup> Rear / Arrière / Parte trasera <sup>17</sup> Location Exhaust Pipe / Empl. tuyau d'éch / Ubicación tubo de escape



ENGINE MOTEUR MOTOR	YEAR ANNEE AÑO	APPLICATION INFORMATION INFORMATION D'APPLICATION INFORMACION DE APLICACION	UPSTREAM / AVANT - C.C. / ANTES DEL C.C.		DOWNSTREAM / APRES - C.C. / DESPUES DEL C.C.	
			TYPE / TIPO O.E.	UNIVERS.	TYPE / TIPO O.E.	UNIVERS.
<b>MAZDA [cont]</b>						
<b>MX-6</b>						
L4-2.0	1997-1996	Auto Trans	234-4629	234-4210	234-4067	234-4210
L4-2.0	1997-1996	Manual Trans	234-3010	234-3000	234-4067	234-4210
L4-2.0	1995-1993		234-4068	234-4210	-	-
L4-2.2	1992-1990		234-1020	234-1000	-	-
L4-2.2	1989-1988		234-1019	234-1000	-	-
V6-2.5	1997		234-3084 <sup>1</sup>	234-3000 <sup>1</sup>	234-4039	234-4210
V6-2.5	1997	Upstream Sensor in Exhaust Pipe	234-4068 <sup>17</sup>	234-4210 <sup>17</sup>	-	-
V6-2.5	1996	Canada Model	234-4068 <sup>15</sup>	234-4210 <sup>15</sup>	-	-
V6-2.5	1996	Canada Model	234-4067 <sup>16</sup>	234-4210 <sup>16</sup>	-	-
V6-2.5	1996	USA Model	234-3084 <sup>15</sup>	234-3000 <sup>15</sup>	234-4628 <sup>15</sup>	234-4210 <sup>15</sup>
V6-2.5	1996	USA Model	234-3084 <sup>16</sup>	234-3000 <sup>16</sup>	234-4627 <sup>16</sup>	234-4210 <sup>16</sup>
V6-2.5	1995-1994	Calif.	234-3042 <sup>1</sup>	234-3000 <sup>1</sup>	-	-
V6-2.5	1995-1994	Exc. Calif. & Canada	234-4068 <sup>15</sup>	234-4210 <sup>15</sup>	-	-
V6-2.5	1995-1994	Exc. Calif. & Canada	234-4067 <sup>16</sup>	234-4210 <sup>16</sup>	-	-
V6-2.5	1993		234-4068 <sup>15</sup>	234-4210 <sup>15</sup>	-	-
V6-2.5	1993		234-4067 <sup>16</sup>	234-4210 <sup>16</sup>	-	-
<b>NAVAJO</b>						
V6-4.0	1994-1991		234-4070	234-4212	-	-
<b>PROTEGE</b>						
L4-1.5	1998-1995		234-3085	234-3000	234-4612	234-4210
L4-1.6	2003-2001		234-4722	-	234-4751	234-4209
L4-1.6	2000-1999	Calif.	234-4722	-	234-4751	234-4209
L4-1.6	2000-1999	Exc. Calif.	234-4146	234-4209	234-4751	234-4209
L4-1.8	2000-1999		234-4143	234-4209	234-4752	234-4209
L4-1.8	1998-1995		234-4606	234-4209	234-4140	234-4209
L4-1.8	1994-1993	4 Lead Sensor	234-4144	234-4209	-	-
L4-1.8	1994-1990	1 Lead Sensor	234-1010	234-1000	-	-
L4-2.0	2003-2001		234-4721	-	234-4752	234-4209
<b>PROTEGES</b>						
L4-2.0	2003-2002		234-4721	-	234-4752	234-4209
<b>RX-7</b>						
R2-1.1	1985-1984		234-1019	234-1000	-	-
R2-1.3	1995		234-1020	234-1000	-	-
R2-1.3	1994-1993		234-1040	234-1000	-	-
R2-1.3	1991-1989		234-1040	234-1000	-	-
R2-1.3	1988-1984		234-1019	234-1000	-	-
<b>RX-8</b>						
R2-1.3	2011-2009	Auto Trans	234-9059	-	234-4349	-
R2-1.3	2011-2009	Manual Trans	234-9059	-	234-4278	-

<sup>1</sup> 2 Required / Requis 2 / Requeridos 2 <sup>15</sup> Front / Avant / Parte delantera <sup>16</sup> Rear / Arrière / Parte trasera <sup>17</sup> Location Exhaust Pipe / Empl. tuyau d'éch / Ubicación tubo de escape



ENGINE MOTEUR MOTOR	YEAR ANNEE AÑO	APPLICATION INFORMATION INFORMATION D'APPLICATION INFORMACION DE APLICACION	UPSTREAM / AVANT - C.C. / ANTES DEL C.C.		DOWNSTREAM / APRES - C.C. / DESPUES DEL C.C.	
			TYPE / TIPO O.E.	UNIVERS.	TYPE / TIPO O.E.	UNIVERS.
<b>MAZDA [cont]</b>						
<b>RX-8 [cont]</b>						
R2-1.3	2008-2004		234-9102	-	234-4349	-
<b>TRIBUTE</b>						
L4-2.0	2004-2001		234-4045	-	234-4608	234-4210
L4-2.3	2008		234-4374	-	234-4609	234-4210
L4-2.3	2006-2005		234-4374	-	234-4609	234-4210
L4-2.5	2011		234-5039	-	234-4609	234-4210
L4-2.5	2010-2009	Hybrid Engine	234-5113	-	234-4609	234-4210
L4-2.5	2010	Gas Engine; Auto Trans	234-5039	-	234-4609	234-4210
L4-2.5	2010	Gas Engine; Manual Trans	234-4374	-	234-4609	234-4210
L4-2.5	2009	Gas Engine	234-4374	-	234-4609	234-4210
V6-3.0	2011-2010		234-5038 <sup>1</sup>	-	234-4609 <sup>1</sup>	234-4210 <sup>1</sup>
V6-3.0	2009		234-4106 <sup>1</sup>	-	234-4609 <sup>1</sup>	234-4210 <sup>1</sup>
V6-3.0	2008		234-4046 <sup>1</sup>	-	234-4609 <sup>1</sup>	234-4210 <sup>1</sup>
V6-3.0	2006-2001		234-4045 <sup>15</sup>	-	234-4609 <sup>15</sup>	234-4210 <sup>15</sup>
V6-3.0	2006-2001		234-4046 <sup>16</sup>	-	234-4609 <sup>16</sup>	234-4210 <sup>16</sup>
<b>MERCEDES-BENZ</b>						
<b>190E</b>						
L4-2.3	1993-1991		234-3082	234-3000	234-3082	234-3000
L4-2.3	1988-1984		234-3082	234-3000	-	-
L6-2.6	1993-1987		234-3082	234-3000	-	-
<b>260E</b>						
L6-2.6	1989-1987		234-3081	234-3000	-	-
<b>280CE</b>						
L6-2.8	1981-1980		-	234-1000	-	-
<b>280E</b>						
L6-2.8	1981-1980		-	234-1000	-	-
<b>280SE</b>						
L6-2.8	1980		-	234-1000	-	-
<b>300CE</b>						
L6-3.0	1992-1990		234-3104	234-3090	-	-
L6-3.0	1989-1988		234-3081	234-3000	-	-
L6-3.2	1993		234-4712	234-4700	-	-
<b>300E</b>						
L6-2.6	1992-1990		234-3081	234-3000	-	-
L6-2.8	1993		234-3104	234-3090	-	-
L6-3.0	1993		234-4712	234-4700	-	-
L6-3.0	1992-1990	4 Lead Sensor	234-4711	234-4700	-	-
L6-3.0	1991	3 Lead Sensor	234-3104	234-3090	-	-
L6-3.0	1989-1986		234-3081	234-3000	-	-
L6-3.2	1993		234-4057	234-4000	-	-

<sup>1</sup> 2 Required / Requis 2 / Requeridos 2 <sup>15</sup> Front / Avant / Parte delantera <sup>16</sup> Rear / Arrière / Parte trasera



ENGINE MOTEUR MOTOR	YEAR ANNEE AÑO	APPLICATION INFORMATION INFORMATION D'APPLICATION INFORMACION DE APLICACION	UPSTREAM / AVANT - C.C. / ANTES DEL C.C.		DOWNSTREAM / APRS - C.C. / DESPUES DEL C.C.	
			TYPE / TIPO O.E.	UNIVERS.	TYPE / TIPO O.E.	UNIVERS.
<b>MERCEDES-BENZ [cont]</b>						
<b>300SE</b>						
L6-3.0	1991-1988		234-3104	234-3090	-	-
L6-3.2	1993		234-4057	234-4000	-	-
L6-3.2	1992		234-4711	234-4700	-	-
<b>300SEL</b>						
L6-3.0	1991-1988		234-3104	234-3090	-	-
<b>300SL</b>						
L6-3.0	1993-1990		234-3105	234-3090	-	-
<b>300TE</b>						
L6-3.0	1993-1990	w/ 11" Sensor	234-3103	234-3090	-	-
L6-3.0	1992-1990	w/ 26" Sensor	234-3104	234-3090	-	-
L6-3.0	1989-1988		234-3081	234-3000	-	-
L6-3.2	1993		234-4712	234-4700	-	-
<b>380SE</b>						
V8-3.8	1985-1984		-	234-1000	-	-
<b>380SEC</b>						
V8-3.8	1983-1982		234-3081	234-3000	-	-
<b>380SEL</b>						
V8-3.8	1983-1981		-	234-1000	-	-
<b>380SL</b>						
V8-3.8	1985-1981		-	234-1000	-	-
<b>380SLC</b>						
V8-3.8	1981		-	234-1000	-	-
<b>400E</b>						
V8-4.2	1993		234-4057	234-4000	-	-
V8-4.2	1992		234-4711	234-4700	-	-
<b>400SE</b>						
V8-4.2	1992	OE #000 540 26 17	234-4711	234-4700	-	-
V8-4.2	1992	OE #000 540 45 17	234-4057	234-4000	-	-
<b>400SEL</b>						
V8-4.2	1993	OE #000 540 26 17	234-4711	234-4700	-	-
V8-4.2	1993	OE #000 540 45 17	234-4057	234-4000	-	-
<b>420SEL</b>						
V8-4.2	1991-1986		234-3081	234-3000	-	-
<b>450SEL</b>						
V8-4.5	1980		-	234-1000	-	-
<b>450SL</b>						
V8-4.5	1980		-	234-1000	-	-
<b>450SLC</b>						
V8-4.5	1980		234-3104	234-3090	-	-



ENGINE MOTEUR MOTOR	YEAR ANNEE AÑO	APPLICATION INFORMATION INFORMATION D'APPLICATION INFORMACION DE APLICACION	UPSTREAM / AVANT - C.C. / ANTES DEL C.C.		DOWNSTREAM / APRES - C.C. / DESPUES DEL C.C.	
			TYPE / TIPO O.E.	UNIVERS.	TYPE / TIPO O.E.	UNIVERS.
<b>MERCEDES-BENZ [cont]</b>						
<b>500E</b>						
V8-5.0	1993		234-4057	234-4000	-	-
V8-5.0	1992		234-4711	234-4700	-	-
<b>500SEC</b>						
V8-5.0	1993	OE #000 540 26 17	234-4711	234-4700	-	-
V8-5.0	1993	OE #000 540 45 17	234-4057	234-4000	-	-
V8-5.0	1985-1984		-	234-1000	-	-
<b>500SEL</b>						
V8-5.0	1993-1992	OE #000 540 26 17	234-4711	234-4700	-	-
V8-5.0	1993-1992	OE #000 540 45 17	234-4057	234-4000	-	-
V8-5.0	1985-1984		-	234-1000	-	-
<b>500SL</b>						
V8-5.0	1993		234-4057	234-4000	-	-
V8-5.0	1992-1990		234-3105	234-3090	-	-
<b>560SEC</b>						
V8-5.6	1991-1986		234-3081	234-3000	-	-
<b>560SEL</b>						
V8-5.6	1991-1986		234-3081	234-3000	-	-
<b>560SL</b>						
V8-5.6	1989-1986		234-3081	234-3000	-	-
<b>600SEC</b>						
V12-6.0	1993		234-4711	234-4700	-	-
<b>600SEL</b>						
V12-6.0	1993-1992		234-4711	234-4700	-	-
<b>600SL</b>						
V12-6.0	1993		234-4711	234-4700	-	-
<b>B200</b>						
L4-2.0	2011-2006		234-4881	-	234-4881	-
<b>B250</b>						
L4-2.0	2015-2013		234-5158	-	234-4839	-
<b>C32 AMG</b>						
V6-3.2	2004-2002		234-4897 <sup>4</sup>	-	234-4898 <sup>4</sup>	-
V6-3.2	2004-2002		234-4883 <sup>5</sup>	-	234-4898 <sup>5</sup>	-
<b>C36 AMG</b>						
L6-3.6	1997		234-4172 <sup>1</sup>	234-4201 <sup>1</sup>	234-4175 <sup>1</sup>	234-4201 <sup>1</sup>
L6-3.6	1996-1995		234-4711 <sup>1</sup>	234-4700 <sup>1</sup>	234-4058 <sup>1</sup>	234-4000 <sup>1</sup>
<b>C43 AMG</b>						
V8-4.3	2000-1998		234-4180 <sup>4</sup>	234-4201 <sup>4</sup>	234-4179 <sup>4</sup>	234-4201 <sup>4</sup>
V8-4.3	2000-1998		234-4173 <sup>5</sup>	234-4201 <sup>5</sup>	234-4178 <sup>5</sup>	234-4201 <sup>5</sup>

<sup>1</sup> 2 Required / Requis 2 / Requeridos 2 <sup>4</sup> Left Side / Côté gauche / Lado izquierdo <sup>5</sup> Right Side / Côté droit / Lado derecho



ENGINE MOTEUR MOTOR	YEAR ANNEE AÑO	APPLICATION INFORMATION INFORMATION D'APPLICATION INFORMACION DE APLICACION	UPSTREAM / AVANT - C.C. / ANTES DEL C.C.		DOWNSTREAM / APRES - C.C. / DESPUES DEL C.C.	
			TYPE / TIPO O.E.	UNIVERS.	TYPE / TIPO O.E.	UNIVERS.
<b>MERCEDES-BENZ [cont]</b>						
<b>C55 AMG</b>						
V8-5.5	2006-2005		234-4897 <sup>4</sup>	-	234-4898 <sup>4</sup>	-
V8-5.5	2006-2005		234-4883 <sup>5</sup>	-	234-4898 <sup>5</sup>	-
<b>C63 AMG</b>						
V8-6.3	2015-2008		234-5096 <sup>1</sup>	-	234-4881 <sup>1</sup>	-
<b>C220</b>						
L4-2.2	1996-1994		234-4710	234-4700	234-4058	234-4000
<b>C230</b>						
L4-1.8	2005-2003		234-5117	-	234-4893	-
L4-2.3	2002		234-4883	-	234-4893	-
L4-2.3	2000-1997		234-4133	234-4212	234-4175	234-4201
V6-2.5	2009-2008	4Matic	234-5096 <sup>1</sup>	-	234-4896 <sup>1</sup>	-
V6-2.5	2009-2008	Exc. 4Matic	234-5096 <sup>1</sup>	-	234-4881 <sup>1</sup>	-
V6-2.5	2007-2006		234-5091 <sup>4</sup>	-	234-4896 <sup>4</sup>	-
V6-2.5	2007-2006		234-5091 <sup>5</sup>	-	234-4881 <sup>5</sup>	-
<b>C240</b>						
V6-2.6	2005-2003	4Matic	234-4897 <sup>4</sup>	-	234-4891 <sup>4</sup>	-
V6-2.6	2005-2003	4Matic	234-4893 <sup>5</sup>	-	234-4898 <sup>5</sup>	-
V6-2.6	2005-2003	Exc. 4Matic	234-4897 <sup>4</sup>	-	234-4898 <sup>4</sup>	-
V6-2.6	2005-2003	Exc. 4Matic	234-4883 <sup>5</sup>	-	234-4898 <sup>5</sup>	-
V6-2.6	2002-2001		234-4897 <sup>4</sup>	-	234-4898 <sup>4</sup>	-
V6-2.6	2002-2001		234-4883 <sup>5</sup>	-	234-4898 <sup>5</sup>	-
<b>C250</b>						
L4-1.8	2015-2012		234-5064	-	234-4585	-
V6-2.5	2012		234-5096 <sup>1</sup>	-	234-4896 <sup>1</sup>	-
V6-2.5	2011-2010	4Matic	234-5096 <sup>1</sup>	-	234-4896 <sup>1</sup>	-
V6-2.5	2011-2010	Exc. 4Matic	234-5096 <sup>1</sup>	-	234-4881 <sup>1</sup>	-
<b>C280</b>						
L6-2.8	1997		234-4172	234-4201	234-4175	234-4201
L6-2.8	1996-1994		234-4711	234-4700	234-4057	234-4000
V6-2.8	2000-1998		234-4180 <sup>4</sup>	234-4201 <sup>4</sup>	234-4179 <sup>4</sup>	234-4201 <sup>4</sup>
V6-2.8	2000-1998		234-4173 <sup>5</sup>	234-4201 <sup>5</sup>	234-4178 <sup>5</sup>	234-4201 <sup>5</sup>
V6-3.0	2007-2006	4Matic	234-5091 <sup>4</sup>	-	234-4893 <sup>4</sup>	-
V6-3.0	2007-2006	4Matic	234-5096 <sup>5</sup>	-	234-4894 <sup>5</sup>	-
V6-3.0	2007-2006	Exc. 4Matic	234-5091 <sup>4</sup>	-	234-4896 <sup>4</sup>	-
V6-3.0	2007-2006	Exc. 4Matic	234-5091 <sup>5</sup>	-	234-4881 <sup>5</sup>	-
<b>C300</b>						
L4-2.0	2016	4Matic	234-5136	-	234-4984	-
L4-2.0	2015	4Matic; From 08/27/2014; From Chassis #003346	234-5136	-	234-4984	-

<sup>1</sup> 2 Required / Requis 2 / Requeridos 2 <sup>4</sup> Left Side / Côté gauche / Lado izquierdo <sup>5</sup> Right Side / Côté droit / Lado derecho



ENGINE MOTEUR MOTOR	YEAR ANNEE AÑO	APPLICATION INFORMATION INFORMATION D'APPLICATION INFORMACION DE APLICACION	UPSTREAM / AVANT - C.C. / ANTES DEL C.C.		DOWNSTREAM / APRS - C.C. / DESPUES DEL C.C.	
			TYPE / TIPO O.E.	UNIVERS.	TYPE / TIPO O.E.	UNIVERS.
<b>MERCEDES-BENZ [cont]</b>						
<b>C300 [cont]</b>						
L4-2.0	2015	4Matic; To 08/27/2014; To Chassis #003346	-	-	234-4984	-
L4-2.0	2015	Base Model	-	-	234-4984	-
V6-3.0	2012-2008	4Matic	234-5096 <sup>1</sup>	-	234-4896 <sup>1</sup>	-
V6-3.0	2011-2008	Exc. 4Matic	234-5096 <sup>1</sup>	-	234-4881 <sup>1</sup>	-
V6-3.5	2014		234-5065 <sup>1</sup>	-	234-4559 <sup>1</sup>	-
V6-3.5	2013		234-5158 <sup>1</sup>	-	234-4559 <sup>1</sup>	-
<b>C320</b>						
V6-3.2	2005-2003	4Matic	234-4897 <sup>4</sup>	-	234-4891 <sup>4</sup>	-
V6-3.2	2005-2003	4Matic	234-4893 <sup>5</sup>	-	234-4898 <sup>5</sup>	-
V6-3.2	2005-2003	Exc. 4Matic	234-4897 <sup>4</sup>	-	234-4898 <sup>4</sup>	-
V6-3.2	2005-2003	Exc. 4Matic	234-4883 <sup>5</sup>	-	234-4898 <sup>5</sup>	-
V6-3.2	2002-2001		234-4897 <sup>4</sup>	-	234-4898 <sup>4</sup>	-
V6-3.2	2002-2001		234-4883 <sup>5</sup>	-	234-4898 <sup>5</sup>	-
<b>C350</b>						
V6-3.5	2015		234-5158 <sup>1</sup>	-	234-4559 <sup>1</sup>	-
V6-3.5	2014	Flex Fuel Engine	234-5158 <sup>1</sup>	-	234-4559 <sup>1</sup>	-
V6-3.5	2014	Gas Engine	234-5065 <sup>1</sup>	-	234-4559 <sup>1</sup>	-
V6-3.5	2013		234-5158 <sup>1</sup>	-	234-4559 <sup>1</sup>	-
V6-3.5	2012		234-5065 <sup>1</sup>	-	234-4559 <sup>1</sup>	-
V6-3.5	2011-2008	4Matic	234-5096 <sup>1</sup>	-	234-4896 <sup>1</sup>	-
V6-3.5	2011-2008	Exc. 4Matic	234-5096 <sup>1</sup>	-	234-4881 <sup>1</sup>	-
V6-3.5	2007-2006	4Matic	234-5091 <sup>4</sup>	-	234-4893 <sup>4</sup>	-
V6-3.5	2007-2006	4Matic	234-5096 <sup>5</sup>	-	234-4894 <sup>5</sup>	-
V6-3.5	2007-2006	Exc. 4Matic	234-5091 <sup>1</sup>	-	234-4881 <sup>1</sup>	-
<b>C400</b>						
V6-3.0	2015		234-5158 <sup>4</sup>	-	234-4586 <sup>4</sup>	-
V6-3.0	2015		234-5085 <sup>5</sup>	-	234-4586 <sup>5</sup>	-
<b>CL55 AMG</b>						
V8-5.5	2006-2001		234-4895 <sup>1</sup>	-	234-4902 <sup>1</sup>	-
<b>CL63 AMG</b>						
V8-5.5	2014		234-5085 <sup>1</sup>	-	234-4559 <sup>1</sup>	-
V8-5.5	2013-2011		234-5085 <sup>1</sup>	-	234-4560 <sup>1</sup>	-
V8-6.3	2010-2008		234-5091 <sup>1</sup>	-	234-4896 <sup>1</sup>	-
<b>CL65 AMG</b>						
V12-6.0	2014-2008		234-4894 <sup>1</sup>	-	234-4894 <sup>1</sup>	-
V12-6.0	2006-2005		234-4894 <sup>1</sup>	-	234-4883 <sup>1</sup>	-
<b>CL500</b>						
V8-5.0	2006-2001		234-4895 <sup>1</sup>	-	234-4902 <sup>1</sup>	-
V8-5.0	2000	From Chassis #A008767 & A005154 (6/30/00)	234-4895 <sup>1</sup>	-	234-4902 <sup>1</sup>	-

<sup>1</sup> 2 Required / Requis 2 / Requeridos 2 <sup>4</sup> Left Side / Côté gauche / Lado izquierdo <sup>5</sup> Right Side / Côté droit / Lado derecho





ENGINE MOTEUR MOTOR	YEAR ANNEE AÑO	APPLICATION INFORMATION INFORMATION D'APPLICATION INFORMACION DE APLICACION	UPSTREAM / AVANT - C.C. / ANTES DEL C.C.		DOWNSTREAM / APRS - C.C. / DESPUES DEL C.C.	
			TYPE / TIPO O.E.	UNIVERS.	TYPE / TIPO O.E.	UNIVERS.
<b>MERCEDES-BENZ [cont]</b>						
<b>CL500 [cont]</b>						
V8-5.0	2000	To Chassis #A008766 (6/30/00)	234-4175 <sup>1</sup>	234-4201 <sup>1</sup>	234-4174 <sup>1</sup>	234-4201 <sup>1</sup>
V8-5.0	1999-1998		234-4175 <sup>4</sup>	234-4201 <sup>4</sup>	234-4175 <sup>4</sup>	234-4201 <sup>4</sup>
V8-5.0	1999-1998		234-4175 <sup>5</sup>	234-4201 <sup>5</sup>	234-4172 <sup>5</sup>	234-4201 <sup>5</sup>
<b>CL550</b>						
V8-4.6	2014-2011		234-5085 <sup>1</sup>	-	234-4560 <sup>1</sup>	-
V8-5.5	2010-2009		234-5096 <sup>4</sup>	-	234-4896 <sup>4</sup>	-
V8-5.5	2010-2009		234-5135 <sup>5</sup>	-	234-4896 <sup>5</sup>	-
V8-5.5	2008-2007		234-5096 <sup>1</sup>	-	234-4896 <sup>1</sup>	-
<b>CL600</b>						
V12-5.5	2014-2007		234-4894 <sup>1</sup>	-	234-4894 <sup>1</sup>	-
V12-5.5	2006-2003		234-4894 <sup>1</sup>	-	234-4883 <sup>1</sup>	-
V12-5.8	2002-2001		234-4883 <sup>1</sup>	-	234-4894 <sup>1</sup>	-
V12-6.0	1999-1998		234-4172 <sup>1</sup>	234-4201 <sup>1</sup>	234-4174 <sup>1</sup>	234-4201 <sup>1</sup>
<b>CLA45 AMG</b>						
L4-2.0	2015-2014		234-5158	-	234-4839	-
<b>CLA250</b>						
L4-2.0	2015-2014		234-5158	-	234-4839	-
<b>CLK55 AMG</b>						
V8-5.5	2006-2004		234-4897 <sup>4</sup>	-	234-4898 <sup>4</sup>	-
V8-5.5	2006-2004		234-4883 <sup>5</sup>	-	234-4898 <sup>5</sup>	-
V8-5.5	2003		234-4883 <sup>1</sup>	-	234-4898 <sup>1</sup>	-
V8-5.5	2002-2001		234-4897 <sup>4</sup>	-	234-4893 <sup>4</sup>	-
V8-5.5	2002-2001		234-4891 <sup>5</sup>	-	234-4890 <sup>5</sup>	-
<b>CLK63 AMG</b>						
V8-6.3	2009-2007		234-5139 <sup>4</sup>	-	234-4881 <sup>4</sup>	-
V8-6.3	2009-2007		234-5091 <sup>5</sup>	-	234-4881 <sup>5</sup>	-
<b>CLK320</b>						
V6-3.2	2005-2004		234-4897 <sup>4</sup>	-	234-4898 <sup>4</sup>	-
V6-3.2	2005-2004		234-4883 <sup>5</sup>	-	234-4898 <sup>5</sup>	-
V6-3.2	2003	Convertible	234-4897 <sup>4</sup>	-	234-4893 <sup>4</sup>	-
V6-3.2	2003	Convertible	234-4891 <sup>5</sup>	-	234-4890 <sup>5</sup>	-
V6-3.2	2003	Coupe	234-4897 <sup>4</sup>	-	234-4898 <sup>4</sup>	-
V6-3.2	2003	Coupe	234-4883 <sup>5</sup>	-	234-4898 <sup>5</sup>	-
V6-3.2	2002-2001		234-4897 <sup>4</sup>	-	234-4893 <sup>4</sup>	-
V6-3.2	2002-2001		234-4891 <sup>5</sup>	-	234-4890 <sup>5</sup>	-
V6-3.2	2000-1998		234-4180 <sup>4</sup>	234-4201 <sup>4</sup>	234-4179 <sup>4</sup>	234-4201 <sup>4</sup>
V6-3.2	2000-1998		234-4173 <sup>5</sup>	234-4201 <sup>5</sup>	234-4178 <sup>5</sup>	234-4201 <sup>5</sup>
<b>CLK350</b>						
V6-3.5	2009-2006		234-5091 <sup>1</sup>	-	234-4881 <sup>1</sup>	-

<sup>1</sup> 2 Required / Requis 2 / Requeridos 2 <sup>4</sup> Left Side / Côté gauche / Lado izquierdo <sup>5</sup> Right Side / Côté droit / Lado derecho



ENGINE MOTEUR MOTOR	YEAR ANNEE AÑO	APPLICATION INFORMATION INFORMATION D'APPLICATION INFORMACION DE APLICACION	UPSTREAM / AVANT - C.C. / ANTES DEL C.C.		DOWNSTREAM / APRES - C.C. / DESPUES DEL C.C.	
			TYPE / TIPO O.E.	UNIVERS.	TYPE / TIPO O.E.	UNIVERS.
<b>MERCEDES-BENZ [cont]</b>						
<b>CLK430</b>						
V8-4.3	2003-2001		234-4897 <sup>4</sup>	-	234-4893 <sup>4</sup>	-
V8-4.3	2003-2001		234-4891 <sup>5</sup>	-	234-4890 <sup>5</sup>	-
V8-4.3	2000-1999		234-4180 <sup>4</sup>	234-4201 <sup>4</sup>	234-4179 <sup>4</sup>	234-4201 <sup>4</sup>
V8-4.3	2000-1999		234-4173 <sup>5</sup>	234-4201 <sup>5</sup>	234-4178 <sup>5</sup>	234-4201 <sup>5</sup>
<b>CLK500</b>						
V8-5.0	2006-2003		234-4883 <sup>5</sup>	-	234-4898 <sup>5</sup>	-
V8-5.0	2006	w/ 27" Upstream Left Sensor	234-4893 <sup>4</sup>	-	234-4898 <sup>4</sup>	-
V8-5.0	2006	w/ 35" Upstream Left Sensor	234-4897 <sup>4</sup>	-	234-4898 <sup>4</sup>	-
V8-5.0	2005-2003		234-4897 <sup>4</sup>	-	234-4898 <sup>4</sup>	-
<b>CLK550</b>						
V8-5.5	2009-2007		234-5091 <sup>1</sup>	-	234-4881 <sup>1</sup>	-
<b>CLS55 AMG</b>						
V8-5.5	2006		234-4883 <sup>1</sup>	-	234-4899 <sup>1</sup>	-
<b>CLS63 AMG</b>						
V8-5.5	2014		234-5158 <sup>1</sup>	-	234-4559 <sup>1</sup>	-
V8-5.5	2013-2012		234-5066 <sup>1</sup>	-	234-4559 <sup>1</sup>	-
V8-6.3	2011-2007		234-5096 <sup>4</sup>	-	234-4896 <sup>4</sup>	-
V8-6.3	2011-2007		234-5091 <sup>5</sup>	-	234-4896 <sup>5</sup>	-
<b>CLS63 AMG S</b>						
V8-5.5	2015-2014		234-5158 <sup>1</sup>	-	234-4559 <sup>1</sup>	-
<b>CLS400</b>						
V6-3.0	2015		-	-	234-4559 <sup>1</sup>	-
<b>CLS500</b>						
V8-5.0	2006		234-4883 <sup>1</sup>	-	234-4899 <sup>1</sup>	-
<b>CLS550</b>						
V8-4.6	2015	4Matic	234-5158 <sup>1</sup>	-	234-4559 <sup>1</sup>	-
V8-4.6	2015	Base Model	-	-	234-4559 <sup>4</sup>	-
V8-4.6	2015	Base Model	234-5158 <sup>5</sup>	-	234-4559 <sup>5</sup>	-
V8-4.6	2014		234-5158 <sup>1</sup>	-	234-4559 <sup>1</sup>	-
V8-4.6	2013-2012		234-5066 <sup>1</sup>	-	234-4559 <sup>1</sup>	-
V8-5.5	2011-2007		234-5096 <sup>1</sup>	-	234-4881 <sup>1</sup>	-
<b>E55 AMG</b>						
V8-5.5	2006-2003		234-4883 <sup>1</sup>	-	234-4899 <sup>1</sup>	-
V8-5.5	2002		234-4895 <sup>4</sup>	-	234-4902 <sup>4</sup>	-
V8-5.5	2002		234-4893 <sup>5</sup>	-	234-4902 <sup>5</sup>	-
V8-5.5	2001	From Chassis #B191888, X044900	234-4883 <sup>4</sup>	-	234-4902 <sup>4</sup>	-
V8-5.5	2001	From Chassis #B191888, X044900	234-4893 <sup>5</sup>	-	234-4902 <sup>5</sup>	-
V8-5.5	2001	To Chassis #B191887, X044899	234-4175 <sup>1</sup>	234-4201 <sup>1</sup>	234-4174 <sup>1</sup>	234-4201 <sup>1</sup>

<sup>1</sup> 2 Required / Requis 2 / Requeridos 2 <sup>4</sup> Left Side / Côté gauche / Lado izquierdo <sup>5</sup> Right Side / Côté droit / Lado derecho



ENGINE MOTEUR MOTOR	YEAR ANNEE AÑO	APPLICATION INFORMATION INFORMATION D'APPLICATION INFORMACION DE APLICACION	UPSTREAM / AVANT - C.C. / ANTES DEL C.C.		DOWNSTREAM / APRS - C.C. / DESPUES DEL C.C.	
			TYPE / TIPO O.E.	UNIVERS.	TYPE / TIPO O.E.	UNIVERS.
<b>MERCEDES-BENZ [cont]</b>						
<b>E55 AMG [cont]</b>						
V8-5.5	2000-1999		234-4175 <sup>1</sup>	234-4201 <sup>1</sup>	234-4174 <sup>1</sup>	234-4201 <sup>1</sup>
<b>E63 AMG</b>						
V8-5.5	2015		234-5158 <sup>1</sup>	-	234-4559 <sup>1</sup>	-
V8-5.5	2014-2012		234-5066 <sup>1</sup>	-	234-4559 <sup>1</sup>	-
V8-6.3	2011-2010		234-5091 <sup>1</sup>	-	234-4896 <sup>1</sup>	-
V8-6.3	2009-2007		234-5096 <sup>4</sup>	-	234-4896 <sup>4</sup>	-
V8-6.3	2009-2007		234-5091 <sup>5</sup>	-	234-4896 <sup>5</sup>	-
<b>E63 AMG S</b>						
V8-5.5	2015		234-5158 <sup>1</sup>	-	234-4559 <sup>1</sup>	-
V8-5.5	2014		234-5066 <sup>1</sup>	-	234-4559 <sup>1</sup>	-
<b>E250</b>						
L4-2.1	2015-2014		234-5157	-	-	-
<b>E280</b>						
V6-3.0	2007		234-5091 <sup>1</sup>	-	234-4883 <sup>1</sup>	-
<b>E300</b>						
V6-3.0	2009-2008		234-5091 <sup>1</sup>	-	234-4883 <sup>1</sup>	-
V6-3.5	2013-2012		234-5065 <sup>1</sup>	-	234-4559 <sup>1</sup>	-
<b>E320</b>						
L6-3.2	2006-2005		234-5139	-	-	-
L6-3.2	1997		234-4175	234-4201	234-4175	234-4201
L6-3.2	1996		234-4176	234-4200	234-4708	-
L6-3.2	1995-1994		234-4712	234-4700	-	-
V6-3.0	2009-2007	Euro Version	234-5096	-	-	-
V6-3.0	2009-2007	US Version	234-5086	-	234-5135	-
V6-3.0	2009-2007	US Version; Loc. Center	234-5135 <sup>12</sup>	-	-	-
V6-3.2	2005-2004	4Matic	234-4893 <sup>1</sup>	-	234-4899 <sup>1</sup>	-
V6-3.2	2005-2004	Exc. 4Matic	234-4883 <sup>1</sup>	-	234-4899 <sup>1</sup>	-
V6-3.2	2003		234-4883 <sup>1</sup>	-	234-4899 <sup>1</sup>	-
V6-3.2	2002-2001		234-4895 <sup>4</sup>	-	234-4902 <sup>4</sup>	-
V6-3.2	2002-2001		234-4893 <sup>5</sup>	-	234-4902 <sup>5</sup>	-
V6-3.2	2000-1998		234-4175 <sup>1</sup>	234-4201 <sup>1</sup>	234-4174 <sup>1</sup>	234-4201 <sup>1</sup>
V6-3.2	1997		234-4175	234-4201	234-4175	234-4201
<b>E350</b>						
V6-3.0	2013-2011		234-5084	-	-	-
V6-3.5	2015-2013		234-5158 <sup>1</sup>	-	234-4559 <sup>1</sup>	-
V6-3.5	2012		234-5065 <sup>1</sup>	-	234-4559 <sup>1</sup>	-
V6-3.5	2011-2010	4Matic	234-5096 <sup>1</sup>	-	234-4896 <sup>1</sup>	-
V6-3.5	2011-2006	Exc. 4Matic	234-5096 <sup>1</sup>	-	234-4881 <sup>1</sup>	-
V6-3.5	2009-2006	4Matic	234-5091 <sup>1</sup>	-	234-4883 <sup>1</sup>	-

<sup>1</sup> 2 Required / Requis 2 / Requeridos 2 <sup>4</sup> Left Side / Côté gauche / Lado izquierdo <sup>5</sup> Right Side / Côté droit / Lado derecho <sup>12</sup> Loc. Center / Empl. central / Ubicación central



ENGINE MOTEUR MOTOR	YEAR ANNEE AÑO	APPLICATION INFORMATION INFORMATION D'APPLICATION INFORMACION DE APLICACION	UPSTREAM / AVANT - C.C. / ANTES DEL C.C.		DOWNSTREAM / APRS - C.C. / DESPUES DEL C.C.	
			TYPE / TIPO O.E.	UNIVERS.	TYPE / TIPO O.E.	UNIVERS.
<b>MERCEDES-BENZ [cont]</b>						
<b>E400</b>						
V6-3.0	2015	4Matic	234-5158 <sup>1</sup>	-	234-4559 <sup>1</sup>	-
V6-3.0	2015	Base Model	234-5085 <sup>1</sup>	-	234-4559 <sup>1</sup>	-
V6-3.5	2015		234-5158 <sup>1</sup>	-	234-4796 <sup>4</sup>	-
V6-3.5	2014-2013		234-5158 <sup>1</sup>	-	234-4796 <sup>1</sup>	-
<b>E420</b>						
V8-4.2	1997		234-4175 <sup>1</sup>	234-4201 <sup>1</sup>	234-4172 <sup>1</sup>	234-4201 <sup>1</sup>
V8-4.2	1995-1994		234-4057	234-4000	-	-
<b>E430</b>						
V8-4.3	2002-2001		234-4895 <sup>4</sup>	-	234-4902 <sup>4</sup>	-
V8-4.3	2002-2001		234-4893 <sup>5</sup>	-	234-4902 <sup>5</sup>	-
V8-4.3	2000-1998		234-4175 <sup>1</sup>	234-4201 <sup>1</sup>	234-4174 <sup>1</sup>	234-4201 <sup>1</sup>
<b>E500</b>						
V8-5.0	2006-2004	4Matic	234-4893 <sup>1</sup>	-	234-4899 <sup>1</sup>	-
V8-5.0	2006-2004	Exc. 4Matic	234-4883 <sup>1</sup>	-	234-4899 <sup>1</sup>	-
V8-5.0	2003		234-4883 <sup>1</sup>	-	234-4899 <sup>1</sup>	-
V8-5.0	1994		234-4057	234-4000	-	-
<b>E550</b>						
V8-4.6	2015-2014		234-5158 <sup>1</sup>	-	234-4559 <sup>1</sup>	-
V8-4.6	2013-2012		234-5066 <sup>1</sup>	-	234-4559 <sup>1</sup>	-
V8-5.5	2011-2010	4Matic	234-5096 <sup>1</sup>	-	234-4896 <sup>1</sup>	-
V8-5.5	2011-2007	Exc. 4Matic	234-5096 <sup>1</sup>	-	234-4881 <sup>1</sup>	-
V8-5.5	2009-2007	4Matic	234-5091 <sup>1</sup>	-	234-4883 <sup>1</sup>	-
<b>G55 AMG</b>						
V8-5.5	2011-2005		234-4901 <sup>1</sup>	-	234-4897 <sup>1</sup>	-
V8-5.5	2004	From Chassis #144226	234-4901 <sup>1</sup>	-	234-4897 <sup>1</sup>	-
V8-5.5	2004	To Chassis #144225	234-4897 <sup>1</sup>	-	234-4901 <sup>1</sup>	-
V8-5.5	2003		234-4897 <sup>1</sup>	-	234-4901 <sup>1</sup>	-
<b>G63 AMG</b>						
V8-5.5	2015-2014		234-5158 <sup>1</sup>	-	234-4799 <sup>1</sup>	-
V8-5.5	2013		234-5135 <sup>1</sup>	-	234-4799 <sup>1</sup>	-
<b>G500</b>						
V8-5.0	2008-2005		234-4901 <sup>1</sup>	-	234-4897 <sup>1</sup>	-
V8-5.0	2004	From Chassis #144226	234-4901 <sup>1</sup>	-	234-4897 <sup>1</sup>	-
V8-5.0	2004	To Chassis #144225	234-4897 <sup>1</sup>	-	234-4901 <sup>1</sup>	-
V8-5.0	2003-2002		234-4897 <sup>1</sup>	-	234-4901 <sup>1</sup>	-
<b>G550</b>						
V8-5.5	2015-2009		234-5096 <sup>4</sup>	-	234-4213 <sup>4</sup>	-
V8-5.5	2015-2009		234-5136 <sup>5</sup>	-	234-4213 <sup>5</sup>	-

<sup>1</sup> 2 Required / Requis 2 / Requeridos 2 <sup>4</sup> Left Side / Côté gauche / Lado izquierdo <sup>5</sup> Right Side / Côté droit / Lado derecho



ENGINE MOTEUR MOTOR	YEAR ANNEE AÑO	APPLICATION INFORMATION INFORMATION D'APPLICATION INFORMACION DE APLICACION	UPSTREAM / AVANT - C.C. / ANTES DEL C.C.		DOWNSTREAM / APRES - C.C. / DESPUES DEL C.C.	
			TYPE / TIPO O.E.	UNIVERS.	TYPE / TIPO O.E.	UNIVERS.
<b>MERCEDES-BENZ [cont]</b>						
<b>GL63 AMG</b>						
V8-5.5	2015-2013		234-5158 <sup>1</sup>	-	234-4559 <sup>1</sup>	-
<b>GL320</b>						
V6-3.0	2009-2007		234-5096	-	-	-
<b>GL350</b>						
V6-3.0	2015-2012		234-5046	-	-	-
V6-3.0	2011		234-5046	-	234-5046	-
V6-3.0	2010		234-5096	-	-	-
<b>GL450</b>						
V6-3.0	2015		234-5085 <sup>4</sup>	-	234-4983 <sup>4</sup>	-
V6-3.0	2015		234-5158 <sup>5</sup>	-	234-4586 <sup>5</sup>	-
V8-4.6	2014-2013		234-5158 <sup>1</sup>	-	234-4559 <sup>1</sup>	-
V8-4.6	2012-2007		234-5096 <sup>4</sup>	-	234-4896 <sup>4</sup>	-
V8-4.6	2012-2007		234-5096 <sup>5</sup>	-	234-4881 <sup>5</sup>	-
<b>GL550</b>						
V8-4.6	2015		234-5158 <sup>1</sup>	-	234-4559 <sup>1</sup>	-
V8-4.6	2014		234-5158 <sup>1</sup>	-	-	-
V8-4.6	2013		234-5158 <sup>1</sup>	-	234-4559 <sup>1</sup>	-
V8-5.5	2012-2008		234-5096 <sup>4</sup>	-	234-4896 <sup>4</sup>	-
V8-5.5	2012-2008		234-5096 <sup>5</sup>	-	234-4881 <sup>5</sup>	-
<b>GLA45 AMG</b>						
L4-2.0	2015		234-5158	-	234-4839	-
<b>GLA250</b>						
L4-2.0	2015		234-5158	-	234-4839	-
<b>GLK250</b>						
L4-2.1	2015-2013		234-5157	-	-	-
<b>GLK350</b>						
V6-3.5	2015		234-5158 <sup>1</sup>	-	234-4559 <sup>1</sup>	-
V6-3.5	2014		234-5065 <sup>1</sup>	-	234-4559 <sup>1</sup>	-
V6-3.5	2013		234-5158 <sup>1</sup>	-	234-4559 <sup>1</sup>	-
V6-3.5	2012-2010	4Matic	234-5096 <sup>1</sup>	-	234-4896 <sup>1</sup>	-
V6-3.5	2012-2010	Exc. 4Matic	234-5096 <sup>1</sup>	-	234-4881 <sup>1</sup>	-
<b>ML55 AMG</b>						
V8-5.5	2003-2000		234-4174 <sup>1</sup>	234-4201 <sup>1</sup>	234-4172 <sup>1</sup>	234-4201 <sup>1</sup>
<b>ML63 AMG</b>						
V8-5.5	2015-2012		234-5158 <sup>1</sup>	-	234-4559 <sup>1</sup>	-
V8-6.3	2011-2007		234-5096 <sup>1</sup>	-	234-4896 <sup>1</sup>	-
<b>ML250</b>						
L4-2.1	2015		234-5157	-	-	-

<sup>1</sup> 2 Required / Requis 2 / Requeridos 2 <sup>4</sup> Left Side / Côté gauche / Lado izquierdo <sup>5</sup> Right Side / Côté droit / Lado derecho



ENGINE MOTEUR MOTOR	YEAR ANNEE AÑO	APPLICATION INFORMATION INFORMATION D'APPLICATION INFORMACION DE APLICACION	UPSTREAM / AVANT - C.C. / ANTES DEL C.C.		DOWNSTREAM / APRES - C.C. / DESPUES DEL C.C.	
			TYPE / TIPO O.E.	UNIVERS.	TYPE / TIPO O.E.	UNIVERS.
<b>MERCEDES-BENZ [cont]</b>						
<b>ML320</b>						
V6-3.0	2009		234-5135	-	-	-
V6-3.0	2008-2007		234-5096	-	-	-
V6-3.2	2003-2001		234-4902 <sup>1</sup>	-	234-4884 <sup>1</sup>	-
V6-3.2	2000-1998		234-4174 <sup>1</sup>	234-4201 <sup>1</sup>	234-4172 <sup>1</sup>	234-4201 <sup>1</sup>
<b>ML350</b>						
V6-3.0	2014-2012		234-5046	-	-	-
V6-3.0	2011		234-5046	-	234-5046	-
V6-3.0	2010		234-5135	-	-	-
V6-3.5	2015		234-5158 <sup>1</sup>	-	234-4586 <sup>1</sup>	-
V6-3.5	2014-2012		234-5135 <sup>1</sup>	-	234-4586 <sup>1</sup>	-
V6-3.5	2011-2006		234-5096 <sup>4</sup>	-	234-4896 <sup>4</sup>	-
V6-3.5	2011-2006		234-5096 <sup>5</sup>	-	234-4881 <sup>5</sup>	-
V6-3.7	2005-2003		234-4902 <sup>1</sup>	-	234-4884 <sup>1</sup>	-
<b>ML400</b>						
V6-3.0	2015		234-5085 <sup>4</sup>	-	234-4983 <sup>4</sup>	-
V6-3.0	2015		234-5158 <sup>5</sup>	-	234-4586 <sup>5</sup>	-
<b>ML430</b>						
V8-4.3	2001		234-4902 <sup>1</sup>	-	234-4884 <sup>1</sup>	-
V8-4.3	2000		234-4174 <sup>1</sup>	234-4201 <sup>1</sup>	234-4172 <sup>1</sup>	234-4201 <sup>1</sup>
V8-4.3	1999		234-4172 <sup>1</sup>	234-4201 <sup>1</sup>	234-4172 <sup>1</sup>	234-4201 <sup>1</sup>
<b>ML450</b>						
V6-3.5	2011		234-5136 <sup>1</sup>	-	234-4522 <sup>1</sup>	-
V6-3.5	2010	From 07/31/09; From Chassis #A542010	234-5096 <sup>4</sup>	-	234-4522 <sup>4</sup>	-
V6-3.5	2010	From 10/05/09; From Chassis #528727	234-5136 <sup>5</sup>	-	234-4522 <sup>5</sup>	-
V6-3.5	2010	To 07/31/09; To Chassis #A542009	234-5091 <sup>4</sup>	-	234-4522 <sup>4</sup>	-
V6-3.5	2010	To 10/05/09; To Chassis #558726	234-5091 <sup>5</sup>	-	234-4522 <sup>5</sup>	-
<b>ML500</b>						
V8-5.0	2007		234-4897 <sup>4</sup>	-	234-4899 <sup>4</sup>	-
V8-5.0	2007		234-4893 <sup>5</sup>	-	234-4898 <sup>5</sup>	-
V8-5.0	2006-2005		234-5096 <sup>4</sup>	-	234-4896 <sup>4</sup>	-
V8-5.0	2006-2005		234-5096 <sup>5</sup>	-	234-4881 <sup>5</sup>	-
V8-5.0	2004-2002		234-4902 <sup>1</sup>	-	234-4884 <sup>1</sup>	-
<b>ML550</b>						
V8-4.6	2014-2012		234-5158 <sup>1</sup>	-	234-4559 <sup>1</sup>	-
V8-5.5	2011-2008		234-5096 <sup>4</sup>	-	234-4896 <sup>4</sup>	-
V8-5.5	2011-2008		234-5096 <sup>5</sup>	-	234-4881 <sup>5</sup>	-
<b>R63 AMG</b>						
V8-6.3	2007		234-5096 <sup>1</sup>	-	234-4896 <sup>1</sup>	-

<sup>1</sup> 2 Required / Requis 2 / Requeridos 2 <sup>4</sup> Left Side / Côté gauche / Lado izquierdo <sup>5</sup> Right Side / Côté droit / Lado derecho



ENGINE MOTEUR MOTOR	YEAR ANNEE AÑO	APPLICATION INFORMATION INFORMATION D'APPLICATION INFORMACION DE APLICACION	UPSTREAM / AVANT - C.C. / ANTES DEL C.C.		DOWNSTREAM / APRS - C.C. / DESPUES DEL C.C.	
			TYPE / TIPO O.E.	UNIVERS.	TYPE / TIPO O.E.	UNIVERS.
<b>MERCEDES-BENZ [cont]</b>						
<b>R320</b>						
V6-3.0	2009		234-5135	-	-	-
V6-3.0	2008-2007		234-5096	-	-	-
<b>R350</b>						
V6-3.0	2013-2011		234-5046	-	234-5046	-
V6-3.0	2010		234-5046	-	-	-
V6-3.5	2013		234-5096 <sup>4</sup>	-	234-4896 <sup>4</sup>	-
V6-3.5	2013		234-5096 <sup>5</sup>	-	234-4881 <sup>5</sup>	-
V6-3.5	2012		234-5096 <sup>1</sup>	-	234-4586 <sup>1</sup>	-
V6-3.5	2011-2006		234-5096 <sup>4</sup>	-	234-4896 <sup>4</sup>	-
V6-3.5	2011-2006		234-5096 <sup>5</sup>	-	234-4881 <sup>5</sup>	-
<b>R500</b>						
V8-5.0	2007-2006		234-4897 <sup>4</sup>	-	234-4899 <sup>4</sup>	-
V8-5.0	2007-2006		234-4893 <sup>5</sup>	-	234-4898 <sup>5</sup>	-
<b>R550</b>						
V8-5.5	2008		234-5096 <sup>4</sup>	-	234-4896 <sup>4</sup>	-
V8-5.5	2008		234-5096 <sup>5</sup>	-	234-4881 <sup>5</sup>	-
<b>S55 AMG</b>						
V8-5.5	2006-2001		234-4895 <sup>1</sup>	-	234-4902 <sup>1</sup>	-
<b>S63 AMG</b>						
V8-5.5	2015-2014		234-5158 <sup>1</sup>	-	234-4560 <sup>1</sup>	-
V8-5.5	2013-2011		234-5085 <sup>1</sup>	-	234-4559 <sup>1</sup>	-
V8-6.3	2010-2008		234-5091 <sup>1</sup>	-	234-4896 <sup>1</sup>	-
<b>S65 AMG</b>						
V12-6.0	2015		234-5085 <sup>1</sup>	-	234-4839 <sup>1</sup>	-
V12-6.0	2013-2007		234-4894 <sup>1</sup>	-	234-4894 <sup>1</sup>	-
V12-6.0	2006		234-4894 <sup>1</sup>	-	234-4883 <sup>1</sup>	-
<b>S320</b>						
L6-3.2	1999-1997		234-4174	234-4201	234-4175	234-4201
L6-3.2	1996		234-4177	234-4200	234-4176	234-4200
L6-3.2	1995		234-4177	234-4200	234-4058	234-4000
L6-3.2	1994		234-4711	234-4700	234-4058	234-4000
<b>S350</b>						
V6-3.0	2013-2012		234-5157	-	-	-
V6-3.7	2006		234-5096 <sup>1</sup>	-	234-4896 <sup>1</sup>	-
<b>S400</b>						
V6-3.5	2013-2010		234-5135 <sup>4</sup>	-	234-4881 <sup>4</sup>	-
V6-3.5	2013-2010		234-5096 <sup>5</sup>	-	234-4896 <sup>5</sup>	-

<sup>1</sup> 2 Required / Requis 2 / Requeridos 2 <sup>4</sup> Left Side / Côté gauche / Lado izquierdo <sup>5</sup> Right Side / Côté droit / Lado derecho



ENGINE MOTEUR MOTOR	YEAR ANNEE AÑO	APPLICATION INFORMATION INFORMATION D'APPLICATION INFORMACION DE APLICACION	UPSTREAM / AVANT - C.C. / ANTES DEL C.C.		DOWNSTREAM / APRES - C.C. / DESPUES DEL C.C.	
			TYPE / TIPO O.E.	UNIVERS.	TYPE / TIPO O.E.	UNIVERS.
<b>MERCEDES-BENZ [cont]</b>						
<b>S420</b>						
V8-4.2	1999-1996		234-4175 <sup>4</sup>	234-4201 <sup>4</sup>	234-4175 <sup>4</sup>	234-4201 <sup>4</sup>
V8-4.2	1999-1996		234-4175 <sup>5</sup>	234-4201 <sup>5</sup>	234-4172 <sup>5</sup>	234-4201 <sup>5</sup>
V8-4.2	1995		234-4057	234-4000	-	-
V8-4.2	1994	OE #000 540 26 17	234-4711	234-4700	-	-
V8-4.2	1994	OE #000 540 45 17	234-4057	234-4000	-	-
<b>S430</b>						
V8-4.3	2006-2001		234-4895 <sup>1</sup>	-	234-4902 <sup>1</sup>	-
V8-4.3	2000		234-4175 <sup>1</sup>	234-4201 <sup>1</sup>	234-4174 <sup>1</sup>	234-4201 <sup>1</sup>
<b>S450</b>						
V8-4.6	2011-2009		234-5135 <sup>5</sup>	-	234-4896 <sup>5</sup>	-
V8-4.6	2011-2008		234-5096 <sup>4</sup>	-	234-4896 <sup>4</sup>	-
V8-4.6	2008	From 06/30/07	234-5135 <sup>5</sup>	-	234-4881 <sup>5</sup>	-
V8-4.6	2008	To 06/30/07	234-5135 <sup>5</sup>	-	234-4896 <sup>5</sup>	-
<b>S500</b>						
V8-5.0	2006-2001		234-4895 <sup>1</sup>	-	234-4902 <sup>1</sup>	-
V8-5.0	2000		234-4175 <sup>1</sup>	234-4201 <sup>1</sup>	234-4174 <sup>1</sup>	234-4201 <sup>1</sup>
V8-5.0	1999-1996		234-4175 <sup>4</sup>	234-4201 <sup>4</sup>	234-4175 <sup>4</sup>	234-4201 <sup>4</sup>
V8-5.0	1999-1996		234-4175 <sup>5</sup>	234-4201 <sup>5</sup>	234-4172 <sup>5</sup>	234-4201 <sup>5</sup>
V8-5.0	1995-1994	OE #000 540 26 17	234-4711	234-4700	-	-
V8-5.0	1995-1994	OE #000 540 45 17	234-4057	234-4000	-	-
<b>S550</b>						
V8-4.6	2015-2014		234-5158 <sup>1</sup>	-	234-4560 <sup>1</sup>	-
V8-4.6	2013		234-5158 <sup>1</sup>	-	234-4559 <sup>1</sup>	-
V8-4.6	2012	4Matic	234-5085 <sup>1</sup>	-	234-4560 <sup>1</sup>	-
V8-4.6	2012	Exc. 4Matic	234-5085 <sup>1</sup>	-	234-4559 <sup>1</sup>	-
V8-5.5	2011-2008	4Matic	234-5096 <sup>4</sup>	-	234-4896 <sup>4</sup>	-
V8-5.5	2011-2008	4Matic	234-5135 <sup>5</sup>	-	234-4896 <sup>5</sup>	-
V8-5.5	2011	Exc. 4Matic	234-5096 <sup>1</sup>	-	234-4896 <sup>1</sup>	-
V8-5.5	2010-2007	Exc. 4Matic	234-5096 <sup>1</sup>	-	234-4881 <sup>1</sup>	-
V8-5.5	2007	4Matic;	234-5096 <sup>4</sup>	-	234-4896 <sup>4</sup>	-
V8-5.5	2007	4Matic; From 06/30/07	234-5135 <sup>5</sup>	-	234-4896 <sup>5</sup>	-
V8-5.5	2007	4Matic; To 06/30/07	234-5135 <sup>5</sup>	-	234-4881 <sup>5</sup>	-
<b>S600</b>						
V12-5.5	2013-2007		234-4894 <sup>1</sup>	-	234-4894 <sup>1</sup>	-
V12-5.5	2006-2003		234-4894 <sup>1</sup>	-	234-4883 <sup>1</sup>	-
V12-5.8	2002-2001		234-4883 <sup>1</sup>	-	234-4894 <sup>1</sup>	-
V12-6.0	2015		234-5085 <sup>1</sup>	-	234-4839 <sup>1</sup>	-
V12-6.0	1999-1996		234-4172 <sup>1</sup>	234-4201 <sup>1</sup>	234-4174 <sup>1</sup>	234-4201 <sup>1</sup>

<sup>1</sup> 2 Required / Requis 2 / Requeridos 2 <sup>4</sup> Left Side / Côté gauche / Lado izquierdo <sup>5</sup> Right Side / Côté droit / Lado derecho





ENGINE MOTEUR MOTOR	YEAR ANNEE AÑO	APPLICATION INFORMATION INFORMATION D'APPLICATION INFORMACION DE APLICACION	UPSTREAM / AVANT - C.C. / ANTES DEL C.C.		DOWNSTREAM / APRS - C.C. / DESPUES DEL C.C.	
			TYPE / TIPO O.E.	UNIVERS.	TYPE / TIPO O.E.	UNIVERS.
<b>MERCEDES-BENZ [cont]</b>						
<b>S600 [cont]</b>						
V12-6.0	1995-1994		234-4711 <sup>1</sup>	234-4700 <sup>1</sup>	-	-
<b>SL55 AMG</b>						
V8-5.5	2008-2003		234-4883 <sup>1</sup>	-	234-4899 <sup>1</sup>	-
V12-5.5	2008		234-4883 <sup>1</sup>	-	234-4899 <sup>1</sup>	-
<b>SL63 AMG</b>						
V8-5.5	2015-2013		234-5158 <sup>1</sup>	-	234-4559 <sup>1</sup>	-
V8-6.3	2012-2009		234-5091 <sup>1</sup>	-	234-4881 <sup>1</sup>	-
<b>SL65 AMG</b>						
V12-6.0	2015-2013		234-5085 <sup>1</sup>	-	234-4839 <sup>1</sup>	-
V12-6.0	2011		234-4894 <sup>1</sup>	-	234-4894 <sup>1</sup>	-
V12-6.0	2010-2005	Exc. Black Series	234-4894 <sup>1</sup>	-	234-4894 <sup>1</sup>	-
V12-6.0	2009-2005	Black Series	234-4523 <sup>1</sup>	-	234-4894 <sup>1</sup>	-
<b>SL320</b>						
L6-3.2	1997		234-4172	234-4201	234-4174	234-4201
L6-3.2	1996		234-4171	234-4201	234-4711	234-4700
L6-3.2	1995-1994		234-4711	234-4700	234-4711	234-4700
<b>SL400</b>						
V6-3.0	2015		-	-	234-4586 <sup>4</sup>	-
V6-3.0	2015		234-5158 <sup>5</sup>	-	234-4586 <sup>5</sup>	-
<b>SL500</b>						
V8-5.0	2006-2003		234-4883 <sup>1</sup>	-	234-4899 <sup>1</sup>	-
V8-5.0	2002-2000		234-4180 <sup>4</sup>	234-4201 <sup>4</sup>	234-4175 <sup>4</sup>	234-4201 <sup>4</sup>
V8-5.0	2002-2000		234-4175 <sup>5</sup>	234-4201 <sup>5</sup>	234-4175 <sup>5</sup>	234-4201 <sup>5</sup>
V8-5.0	1999		234-4172 <sup>1</sup>	234-4201 <sup>1</sup>	234-4175 <sup>1</sup>	234-4201 <sup>1</sup>
V8-5.0	1998-1996		234-4180 <sup>4</sup>	234-4201 <sup>4</sup>	234-4172 <sup>4</sup>	234-4201 <sup>4</sup>
V8-5.0	1998-1996		234-4174 <sup>5</sup>	234-4201 <sup>5</sup>	234-4172 <sup>5</sup>	234-4201 <sup>5</sup>
V8-5.0	1995-1994		234-4057	234-4000	-	-
<b>SL550</b>						
V8-4.6	2015-2013		234-5158 <sup>1</sup>	-	234-4559 <sup>1</sup>	-
V8-5.5	2012-2007		234-5096 <sup>1</sup>	-	234-4881 <sup>1</sup>	-
<b>SL600</b>						
V12-5.5	2011-2005		234-4894 <sup>1</sup>	-	234-4894 <sup>1</sup>	-
V12-5.5	2004		234-4894 <sup>1</sup>	-	234-4883 <sup>1</sup>	-
V12-6.0	2002-1996		234-4172 <sup>1</sup>	234-4201 <sup>1</sup>	234-4172 <sup>1</sup>	234-4201 <sup>1</sup>
V12-6.0	1995-1994		234-4711 <sup>1</sup>	234-4700 <sup>1</sup>	-	-
<b>SLK32 AMG</b>						
V6-3.2	2004-2002		234-4883 <sup>1</sup>	-	234-4902 <sup>1</sup>	-
<b>SLK55 AMG</b>						
V8-5.5	2015-2012		234-5067 <sup>4</sup>	-	234-4796 <sup>4</sup>	-

<sup>1</sup> 2 Required / Requis 2 / Requeridos 2 <sup>4</sup> Left Side / Côté gauche / Lado izquierdo <sup>5</sup> Right Side / Côté droit / Lado derecho



ENGINE MOTEUR MOTOR	YEAR ANNEE AÑO	APPLICATION INFORMATION INFORMATION D'APPLICATION INFORMACION DE APLICACION	UPSTREAM / AVANT - C.C. / ANTES DEL C.C.		DOWNSTREAM / APRS - C.C. / DESPUES DEL C.C.	
			TYPE / TIPO O.E.	UNIVERS.	TYPE / TIPO O.E.	UNIVERS.
<b>MERCEDES-BENZ [cont]</b>						
<b>SLK55 AMG [cont]</b>						
V8-5.5	2015-2012		234-5096 <sup>5</sup>	-	234-4796 <sup>5</sup>	-
V8-5.5	2011-2005		234-4897 <sup>4</sup>	-	234-4899 <sup>4</sup>	-
V8-5.5	2011-2005		234-4893 <sup>5</sup>	-	234-4899 <sup>5</sup>	-
<b>SLK230</b>						
L4-2.3	2004-2000		234-4884	-	234-4894	-
L4-2.3	1999-1998		234-4134	234-4212	234-4172	234-4201
<b>SLK250</b>						
L4-1.8	2015-2012		234-5064	-	234-4585	-
<b>SLK280</b>						
V6-3.0	2008-2006		234-5096 <sup>1</sup>	-	234-4881 <sup>1</sup>	-
<b>SLK300</b>						
V6-3.0	2011-2009		234-5096 <sup>1</sup>	-	234-4881 <sup>1</sup>	-
<b>SLK320</b>						
V6-3.2	2004-2001		234-4883 <sup>1</sup>	-	234-4902 <sup>1</sup>	-
<b>SLK350</b>						
V6-3.5	2015-2014		234-5067 <sup>4</sup>	-	234-4559 <sup>4</sup>	-
V6-3.5	2015-2014		234-5158 <sup>5</sup>	-	234-4559 <sup>5</sup>	-
V6-3.5	2013-2012		234-5067 <sup>1</sup>	-	234-4559 <sup>1</sup>	-
V6-3.5	2011-2005		234-5096 <sup>1</sup>	-	234-4881 <sup>1</sup>	-
<b>SLR MCLAREN</b>						
V8-5.5	2009-2005		234-4895 <sup>1</sup>	-	234-4899 <sup>1</sup>	-
<b>SLS AMG</b>						
V8-6.3	2015-2011		234-5091 <sup>1</sup>	-	234-4522 <sup>1</sup>	-
<b>SPRINTER 2500</b>						
L4-2.1	2015-2014		234-5046	-	-	-
V6-3.0	2015-2010		234-5084	-	-	-
<b>SPRINTER 3500</b>						
L4-2.1	2015-2014		234-5046	-	-	-
V6-3.0	2015-2010		234-5084	-	-	-
<b>MERCURY</b>						
<b>BOBCAT</b>						
L4-2.3	1980-1979		234-1003	234-1000	-	-
V6-2.8	1979		234-1003	234-1000	-	-
<b>CAPRI</b>						
L4-1.6	1994-1991		234-1019	234-1000	-	-
L4-2.3	1986-1979	1 Lead Sensor	234-1003	234-1000	-	-
L4-2.3	1984	3 Lead Sensor	234-3001	234-3000	-	-
L6-3.3	1982-1980		234-1003	234-1000	-	-
V6-3.8	1986-1983		234-1003	234-1000	-	-

<sup>1</sup> 2 Required / Requis 2 / Requeridos 2 <sup>4</sup> Left Side / Côté gauche / Lado izquierdo <sup>5</sup> Right Side / Côté droit / Lado derecho



ENGINE MOTEUR MOTOR	YEAR ANNEE AÑO	APPLICATION INFORMATION INFORMATION D'APPLICATION INFORMACION DE APLICACION	UPSTREAM / AVANT - C.C. / ANTES DEL C.C.		DOWNSTREAM / APRES - C.C. / DESPUES DEL C.C.	
			TYPE / TIPO O.E.	UNIVERS.	TYPE / TIPO O.E.	UNIVERS.
<b>MERCURY [cont]</b>						
<b>CAPRI [cont]</b>						
V8-4.2	1982-1980		234-1003	234-1000	-	-
V8-5.0	1986		234-3001 <sup>1</sup>	234-3000 <sup>1</sup>	-	-
V8-5.0	1985-1984	3 Lead Sensor	234-3001	234-3000	-	-
V8-5.0	1985-1982	1 Lead Sensor	234-1003	234-1000	-	-
<b>COLONY PARK</b>						
V8-5.0	1991-1987		234-3002 <sup>1</sup>	234-3000 <sup>1</sup>	-	-
<b>COUGAR</b>						
L4-2.0	2002		234-4045	-	234-4610	234-4210
L4-2.0	2001-2000		234-4045	-	234-4609	234-4210
L4-2.0	1999		234-4016	234-4210	234-4609	234-4210
L4-2.3	1986-1985		234-1003	234-1000	-	-
L4-2.3	1984		234-3001	234-3000	-	-
L4-2.3	1982-1981		234-1003	234-1000	-	-
L6-3.3	1982-1980		234-1003	234-1000	-	-
V6-2.5	2002-2000		234-4045 <sup>1</sup>	-	234-4610 <sup>1</sup>	234-4210 <sup>1</sup>
V6-2.5	1999	From 05/02/99; Upstream Sensor w/ Round Connector	234-4045	-	234-4610 <sup>1</sup>	234-4210 <sup>1</sup>
V6-2.5	1999	From 05/02/99; Upstream Sensor w/ Square Connector	234-4607 <sup>1</sup>	234-4210 <sup>1</sup>	234-4610 <sup>1</sup>	234-4210 <sup>1</sup>
V6-2.5	1999	To 05/02/99; Upstream Sensor w/ Round Connector	234-4045 <sup>1</sup>	-	234-4609	234-4210
V6-2.5	1999	To 05/02/99; Upstream Sensor w/ Square Connector	234-4607 <sup>1</sup>	234-4210 <sup>1</sup>	234-4609 <sup>1</sup>	234-4210 <sup>1</sup>
V6-3.8	1997-1996		234-4609	234-4210	234-4610	234-4210
V6-3.8	1995-1994		234-4001 <sup>1</sup>	234-4212 <sup>1</sup>	-	-
V6-3.8	1993-1991		234-4610 <sup>1</sup>	234-4210 <sup>1</sup>	-	-
V6-3.8	1990-1988		234-3002 <sup>1</sup>	234-3000 <sup>1</sup>	-	-
V6-3.8	1987-1982		234-1003	234-1000	-	-
V8-4.2	1982-1980		234-1003	234-1000	-	-
V8-4.6	1997-1996		234-4610	234-4210	234-4610	234-4210
V8-4.6	1995-1994		234-4001 <sup>1</sup>	234-4212 <sup>1</sup>	-	-
V8-5.0	1993-1991		234-4610 <sup>1</sup>	234-4210 <sup>1</sup>	-	-
V8-5.0	1988-1987		234-3002 <sup>1</sup>	234-3000 <sup>1</sup>	-	-
V8-5.0	1986		234-3001	234-3000	-	-
V8-5.0	1985-1983		234-1003	234-1000	-	-
V8-5.0	1981-1980		234-1003	234-1000	-	-
V8-5.8	1979		234-1003	234-1000	-	-
<b>GRAND MARQUIS</b>						
V8-4.2	1982-1981		234-1003	234-1000	-	-
V8-4.6	2011-2007		234-4373 <sup>1</sup>	-	234-4609 <sup>1</sup>	234-4210 <sup>1</sup>
V8-4.6	2006	From 12/05/05	234-4373 <sup>1</sup>	-	234-4609 <sup>1</sup>	234-4210 <sup>1</sup>
V8-4.6	2006	To 12/05/05	234-4045 <sup>1</sup>	-	234-4609 <sup>1</sup>	234-4210 <sup>1</sup>
V8-4.6	2005-1999		234-4045 <sup>1</sup>	-	234-4609 <sup>1</sup>	234-4210 <sup>1</sup>
V8-4.6	1998		234-4046 <sup>1</sup>	-	234-4609 <sup>1</sup>	234-4210 <sup>1</sup>

<sup>1</sup> 2 Required / Requis 2 / Requeridos 2



ENGINE MOTEUR MOTOR	YEAR ANNEE AÑO	APPLICATION INFORMATION INFORMATION D'APPLICATION INFORMACION DE APLICACION	UPSTREAM / AVANT - C.C. / ANTES DEL C.C.		DOWNSTREAM / APRS - C.C. / DESPUES DEL C.C.	
			TYPE / TIPO O.E.	UNIVERS.	TYPE / TIPO O.E.	UNIVERS.
<b>MERCURY [cont]</b>						
<b>GRAND MARQUIS [cont]</b>						
V8-4.6	1997-1996		234-4609	234-4210	234-4609	234-4210
V8-4.6	1995		234-4609 <sup>1</sup>	234-4210 <sup>1</sup>	-	-
V8-4.6	1994	Calif.	234-4609 <sup>1</sup>	234-4210 <sup>1</sup>	-	-
V8-4.6	1994	Exc. Calif.	234-4610 <sup>1</sup>	234-4210 <sup>1</sup>	-	-
V8-4.6	1993-1992		234-4610 <sup>1</sup>	234-4210 <sup>1</sup>	-	-
V8-5.0	1991-1987		234-3002 <sup>1</sup>	234-3000 <sup>1</sup>	-	-
V8-5.0	1986		234-3001	234-3000	-	-
V8-5.0	1985-1980		234-1003	234-1000	-	-
V8-5.8	1989-1988		234-3002 <sup>1</sup>	234-3000 <sup>1</sup>	-	-
V8-5.8	1987-1983		234-1003	234-1000	-	-
V8-5.8	1981-1979		234-1003	234-1000	-	-
<b>LN7</b>						
L4-1.6	1983		234-1003	234-1000	-	-
<b>LYNX</b>						
L4-1.6	1985-1983		234-1003	234-1000	-	-
L4-1.9	1987		234-3002	234-3000	-	-
L4-1.9	1986-1985		234-3001	234-3000	-	-
<b>MARAUDER</b>						
V8-4.6	2004-2003		234-4045 <sup>1</sup>	-	234-4609 <sup>1</sup>	234-4210 <sup>1</sup>
<b>MARINER</b>						
L4-2.3	2008-2005		234-4374	-	234-4609	234-4210
L4-2.5	2011	Gas Engine	234-5039	-	234-4490	-
L4-2.5	2011	Hybrid Engine	234-5113	-	234-4490	-
L4-2.5	2010-2009	Hybrid Engine	234-5113	-	234-4609	234-4210
L4-2.5	2010	Gas Engine	234-5039	-	234-4609	234-4210
L4-2.5	2009	Gas Engine	234-4374	-	234-4609	234-4210
V6-3.0	2011		234-5038 <sup>1</sup>	-	234-4490 <sup>1</sup>	-
V6-3.0	2010		234-5038 <sup>1</sup>	-	234-4609 <sup>1</sup>	234-4210 <sup>1</sup>
V6-3.0	2009		234-4106 <sup>1</sup>	-	234-4609 <sup>1</sup>	234-4210 <sup>1</sup>
V6-3.0	2008-2007		234-4046 <sup>1</sup>	-	234-4609 <sup>1</sup>	234-4210 <sup>1</sup>
V6-3.0	2006-2005		234-4045 <sup>15</sup>	-	234-4609 <sup>15</sup>	234-4210 <sup>15</sup>
V6-3.0	2006-2005		234-4046 <sup>16</sup>	-	234-4609 <sup>16</sup>	234-4210 <sup>16</sup>
<b>MARQUIS</b>						
L4-2.3	1986-1983		234-1003	234-1000	-	-
L6-3.3	1983		234-1003	234-1000	-	-
V6-3.8	1986-1983		234-1003	234-1000	-	-
V8-4.2	1982-1981		234-1003	234-1000	-	-
V8-5.0	1985		234-1003	234-1000	-	-
V8-5.0	1982-1980		234-1003	234-1000	-	-
V8-5.8	1981-1979		234-1003	234-1000	-	-

<sup>1</sup> 2 Required / Requis 2 / Requeridos 2 <sup>15</sup> Front / Avant / Parte delantera <sup>16</sup> Rear / Arrière / Parte trasera



ENGINE MOTEUR MOTOR	YEAR ANNEE AÑO	APPLICATION INFORMATION INFORMATION D'APPLICATION INFORMACION DE APLICACION	UPSTREAM / AVANT - C.C. / ANTES DEL C.C.		DOWNSTREAM / APRS - C.C. / DESPUES DEL C.C.	
			TYPE / TIPO O.E.	UNIVERS.	TYPE / TIPO O.E.	UNIVERS.
<b>MERCURY [cont]</b>						
<b>MILAN</b>						
L4-2.3	2009-2006		234-4374	-	234-4609	234-4210
L4-2.5	2011	Gas Engine; Auto Trans	234-5039	-	234-4490	-
L4-2.5	2011	Gas Engine; Manual Trans	234-4740	-	234-4490	-
L4-2.5	2011	Hybrid Engine	234-5113	-	234-4490	-
L4-2.5	2010	Gas Engine; Auto Trans	234-5039	-	234-4609	234-4210
L4-2.5	2010	Gas Engine; Manual Trans	234-4374	-	234-4609	234-4210
L4-2.5	2010	Hybrid Engine	234-5113	-	234-4609	234-4210
V6-3.0	2011		234-5038 <sup>15</sup>	-	234-4490 <sup>15</sup>	-
V6-3.0	2011		234-5038 <sup>16</sup>	-	234-4489 <sup>16</sup>	-
V6-3.0	2010	From 08/03/09	234-5038 <sup>4</sup>	-	234-4609 <sup>4</sup>	234-4210 <sup>4</sup>
V6-3.0	2010	From 08/03/09	234-5038 <sup>5</sup>	-	234-4610 <sup>5</sup>	234-4210 <sup>5</sup>
V6-3.0	2010	To 08/03/09	234-5032 <sup>4</sup>	-	234-4609 <sup>4</sup>	234-4210 <sup>4</sup>
V6-3.0	2010	To 08/03/09	234-5032 <sup>5</sup>	-	234-4610 <sup>5</sup>	234-4210 <sup>5</sup>
V6-3.0	2009-2008		234-4106 <sup>4</sup>	-	234-4610 <sup>4</sup>	234-4210 <sup>4</sup>
V6-3.0	2009-2008	FWD	234-4374 <sup>5</sup>	-	234-4609 <sup>5</sup>	234-4210 <sup>5</sup>
V6-3.0	2009-2007	AWD	234-4106 <sup>5</sup>	-	234-4609 <sup>5</sup>	234-4210 <sup>5</sup>
V6-3.0	2007	AWD	234-4106 <sup>4</sup>	-	234-4610 <sup>4</sup>	234-4210 <sup>4</sup>
V6-3.0	2007	FWD; From 09/04/06	234-4106 <sup>4</sup>	-	234-4610 <sup>4</sup>	234-4210 <sup>4</sup>
V6-3.0	2007	FWD; From 09/04/06	234-4106 <sup>5</sup>	-	234-4609 <sup>5</sup>	234-4210 <sup>5</sup>
V6-3.0	2007	FWD; To 09/04/06	234-4374 <sup>1</sup>	-	234-4610 <sup>1</sup>	234-4210 <sup>1</sup>
V6-3.0	2006		234-4374 <sup>1</sup>	-	234-4610 <sup>1</sup>	234-4210 <sup>1</sup>
<b>MONARCH</b>						
V8-4.2	1980		234-1003	234-1000	-	-
V8-5.0	1980		234-1003	234-1000	-	-
<b>MONTEGO</b>						
V6-3.0	2007-2005		234-4045 <sup>4</sup>	-	234-4610 <sup>4</sup>	234-4210 <sup>4</sup>
V6-3.0	2007-2005		234-4046 <sup>5</sup>	-	234-4609 <sup>5</sup>	234-4210 <sup>5</sup>
<b>MONTEREY</b>						
V6-4.2	2007-2004		234-4401 <sup>1</sup>	-	234-4610 <sup>1</sup>	234-4210 <sup>1</sup>
<b>MOUNTAINEER</b>						
V6-4.0	2010-2004	w/ 19" Downstream Sensors	234-4401 <sup>1</sup>	-	234-4127 <sup>1</sup>	234-4212 <sup>1</sup>
V6-4.0	2005-2004	w/ 11" Downstream Sensors	234-4401 <sup>1</sup>	-	234-4071 <sup>1</sup>	234-4212 <sup>1</sup>
V6-4.0	2003		234-4046 <sup>4</sup>	-	234-4610 <sup>4</sup>	234-4210 <sup>4</sup>
V6-4.0	2003		234-4046 <sup>5</sup>	-	234-4609 <sup>5</sup>	234-4210 <sup>5</sup>
V6-4.0	2002	Flex Fuel Engine	234-4046 <sup>4</sup>	-	234-4610 <sup>4</sup>	234-4210 <sup>4</sup>
V6-4.0	2002	Flex Fuel Engine	234-4046 <sup>5</sup>	-	234-4609 <sup>5</sup>	234-4210 <sup>5</sup>
V6-4.0	2002	Gas Engine	234-4403 <sup>1</sup>	-	234-4071 <sup>1</sup>	234-4212 <sup>1</sup>
V6-4.0	2001-1999		234-4403 <sup>1</sup>	-	234-4071 <sup>1</sup>	234-4212 <sup>1</sup>

<sup>1</sup> 2 Required / Requis 2 / Requeridos 2 <sup>4</sup> Left Side / Côté gauche / Lado izquierdo <sup>5</sup> Right Side / Côté droit / Lado derecho <sup>15</sup> Front / Avant / Parte delantera <sup>16</sup> Rear / Arrière / Parte trasera



ENGINE MOTEUR MOTOR	YEAR ANNEE AÑO	APPLICATION INFORMATION INFORMATION D'APPLICATION INFORMACION DE APLICACION	UPSTREAM / AVANT - C.C. / ANTES DEL C.C.		DOWNSTREAM / APRES - C.C. / DESPUES DEL C.C.	
			TYPE / TIPO O.E.	UNIVERS.	TYPE / TIPO O.E.	UNIVERS.
<b>MERCURY [cont]</b>						
<b>MOUNTAINEER [cont]</b>						
V6-4.0	1998		234-4070 <sup>4</sup>	234-4212 <sup>4</sup>	234-4071 <sup>4</sup>	234-4212 <sup>4</sup>
V6-4.0	1998		234-4127 <sup>5</sup>	234-4212 <sup>5</sup>	234-4071 <sup>5</sup>	234-4212 <sup>5</sup>
V8-4.6	2010-2004	w/ 19" Downstream Sensors	234-4401 <sup>1</sup>	-	234-4127 <sup>1</sup>	234-4212 <sup>1</sup>
V8-4.6	2005-2004	w/ 11" Downstream Sensors	234-4401 <sup>1</sup>	-	234-4071 <sup>1</sup>	234-4212 <sup>1</sup>
V8-4.6	2003-2002		234-4046 <sup>4</sup>	-	234-4609 <sup>4</sup>	234-4210 <sup>4</sup>
V8-4.6	2003-2002		234-4046 <sup>5</sup>	-	234-4610 <sup>5</sup>	234-4210 <sup>5</sup>
V8-5.0	2001-1999		234-4401 <sup>4</sup>	-	234-4071 <sup>4</sup>	234-4212 <sup>4</sup>
V8-5.0	2001-1999		234-4403 <sup>5</sup>	-	234-4071 <sup>5</sup>	234-4212 <sup>5</sup>
V8-5.0	1998-1997		234-4071 <sup>4</sup>	234-4212 <sup>4</sup>	234-4071 <sup>4</sup>	234-4212 <sup>4</sup>
V8-5.0	1998-1997		234-4127 <sup>5</sup>	234-4212 <sup>5</sup>	234-4071 <sup>5</sup>	234-4212 <sup>5</sup>
<b>MYSTIQUE</b>						
L4-2.0	2000		234-4045	-	234-4609	234-4210
L4-2.0	1999-1996		234-4016	234-4210	234-4609	234-4210
L4-2.0	1995		234-4016	234-4210	-	-
V6-2.5	2000		234-4045 <sup>1</sup>	-	234-4610 <sup>1</sup>	234-4210 <sup>1</sup>
V6-2.5	1999	From 05/02/99; Upstream Sensor w/ Round Connector	234-4045 <sup>1</sup>	-	234-4610 <sup>1</sup>	234-4210 <sup>1</sup>
V6-2.5	1999	From 05/02/99; Upstream Sensor w/ Square Connector	234-4607 <sup>1</sup>	234-4210 <sup>1</sup>	234-4610 <sup>1</sup>	234-4210 <sup>1</sup>
V6-2.5	1999	To 05/02/99; Upstream Sensor w/ Round Connector	234-4045 <sup>1</sup>	-	234-4609	234-4210
V6-2.5	1999	To 05/02/99; Upstream Sensor w/ Square Connector	234-4607 <sup>1</sup>	234-4210 <sup>1</sup>	234-4609	234-4210
V6-2.5	1998		234-4607 <sup>1</sup>	234-4210 <sup>1</sup>	234-4609	234-4210
V6-2.5	1997-1996		234-4607 <sup>1</sup>	234-4210 <sup>1</sup>	234-4609 <sup>1</sup>	234-4210 <sup>1</sup>
V6-2.5	1995		234-4607 <sup>1</sup>	234-4210 <sup>1</sup>	-	-
<b>SABLE</b>						
L4-2.5	1986		234-1004	234-1000	-	-
V6-3.0	2005	VIN 2 & U; w/ 11" Upstream Sensor	234-4046 <sup>1</sup>	-	234-4610 <sup>1</sup>	234-4210 <sup>1</sup>
V6-3.0	2005	VIN 2 & U; w/ 15" Upstream Sensor	234-4045 <sup>1</sup>	-	234-4610 <sup>1</sup>	234-4210 <sup>1</sup>
V6-3.0	2005	VIN S	234-4046 <sup>1</sup>	-	234-4610 <sup>1</sup>	234-4210 <sup>1</sup>
V6-3.0	2004-2001		234-4046 <sup>1</sup>	-	234-4610 <sup>1</sup>	234-4210 <sup>1</sup>
V6-3.0	2000		234-4045 <sup>1</sup>	-	234-4610 <sup>1</sup>	234-4210 <sup>1</sup>
V6-3.0	1999	Calif.	234-4045 <sup>1</sup>	-	234-4609 <sup>1</sup>	234-4210 <sup>1</sup>
V6-3.0	1999	Exc. Calif.	234-4609 <sup>1</sup>	234-4210 <sup>1</sup>	234-4609 <sup>1</sup>	234-4210 <sup>1</sup>
V6-3.0	1998-1996		234-4609 <sup>1</sup>	234-4210 <sup>1</sup>	234-4609 <sup>1</sup>	234-4210 <sup>1</sup>
V6-3.0	1995		234-4609 <sup>1</sup>	234-4210 <sup>1</sup>	-	-
V6-3.0	1994-1991	w/ 13" Sensor	234-4610 <sup>1</sup>	234-4210 <sup>1</sup>	-	-
V6-3.0	1994-1991	w/ 18" Sensor	234-4609 <sup>1</sup>	234-4210 <sup>1</sup>	-	-
V6-3.0	1990-1987		234-3002	234-3000	-	-
V6-3.0	1986		234-3001	234-3000	-	-
V6-3.5	2009-2008	Calif.	234-5097 <sup>1</sup>	-	234-4610 <sup>1</sup>	234-4210 <sup>1</sup>
V6-3.5	2009-2008	Exc. Calif.	234-4372 <sup>1</sup>	-	234-4610 <sup>1</sup>	234-4210 <sup>1</sup>

<sup>1</sup> 2 Required / Requis 2 / Requeridos 2 <sup>4</sup> Left Side / Côté gauche / Lado izquierdo <sup>5</sup> Right Side / Côté droit / Lado derecho



ENGINE MOTEUR MOTOR	YEAR ANNEE AÑO	APPLICATION INFORMATION INFORMATION D'APPLICATION INFORMACION DE APLICACION	UPSTREAM / AVANT - C.C. / ANTES DEL C.C.		DOWNSTREAM / APRS - C.C. / DESPUES DEL C.C.	
			TYPE / TIPO O.E.	UNIVERS.	TYPE / TIPO O.E.	UNIVERS.
<b>MERCURY [cont]</b>						
<b>SABLE [cont]</b>						
V6-3.8	1995-1992	w/ 18" Sensor	234-4609 <sup>1</sup>	234-4210 <sup>1</sup>	-	-
V6-3.8	1995-1991	w/ 13" Sensor	234-4610 <sup>1</sup>	234-4210 <sup>1</sup>	-	-
V6-3.8	1990-1988		234-3002 <sup>1</sup>	234-3000 <sup>1</sup>	-	-
<b>TOPAZ</b>						
L4-2.3	1994-1992		234-4609	234-4210	-	-
L4-2.3	1991-1987		234-3007	234-3000	-	-
L4-2.3	1986-1984		234-1004	234-1000	-	-
V6-3.0	1994-1992		234-4610	234-4210	-	-
<b>TRACER</b>						
L4-1.6	1990		234-1010	234-1000	-	-
L4-1.6	1989-1987		234-1019	234-1000	-	-
L4-1.8	1996		234-4606	234-4209	234-4605	234-4209
L4-1.8	1995		234-4606	234-4209	-	-
L4-1.8	1994-1991		234-1010	234-1000	-	-
L4-1.9	1996		234-4610	234-4210	234-4611	234-4210
L4-1.9	1995-1994		234-4610	234-4210	-	-
L4-1.9	1993-1992		234-4070	234-4212	-	-
L4-1.9	1991		234-3002	234-3000	-	-
L4-2.0	1999-1997		234-4610	234-4210	234-4611	234-4210
<b>VILLAGER</b>						
V6-3.0	1998		234-3075	234-3090	234-4779	234-4700
V6-3.0	1997-1996		234-3075	234-3090	234-4702	234-4700
V6-3.0	1995		234-3075	234-3090	-	-
V6-3.0	1994	From 11/93	234-3075	234-3090	-	-
V6-3.0	1994	To 11/93	234-3126	-	-	-
V6-3.0	1993		234-3126	-	-	-
V6-3.3	2002-2001		234-3089	234-3090	234-4701	234-4700
V6-3.3	2000-1999	Calif.	234-3089	234-3090	234-4701	234-4700
V6-3.3	2000-1999	Exc. Calif.	234-3096	234-3090	234-4779	234-4700
<b>ZEPHYR</b>						
L4-2.3	1983-1979		234-1003	234-1000	-	-
L6-3.3	1983-1980		234-1003	234-1000	-	-
V8-4.2	1982-1980		234-1003	234-1000	-	-
<b>MERKUR</b>						
<b>SCORPIO</b>						
V6-2.9	1989-1988	w/ 40" Sensor	234-3073	234-3090	-	-
V6-2.9	1989	w/ 9" Sensor	234-3001	234-3000	-	-
<b>XR4TI</b>						
L4-2.3	1989-1985	w/ 13" Sensor	234-1004	234-1000	-	-
L4-2.3	1986-1985	w/ 7" Sensor	234-1003	234-1000	-	-

<sup>1</sup> 2 Required / Requis 2 / Requeridos 2



ENGINE MOTEUR MOTOR	YEAR ANNEE AÑO	APPLICATION INFORMATION INFORMATION D'APPLICATION INFORMACION DE APLICACION	UPSTREAM / AVANT - C.C. / ANTES DEL C.C.		DOWNSTREAM / APRES - C.C. / DESPUES DEL C.C.	
			TYPE / TIPO O.E.	UNIVERS.	TYPE / TIPO O.E.	UNIVERS.
<b>MINI</b>						
<b>COOPER</b>						
L3-1.5	2015-2014		234-5166	-	234-4971	-
L4-1.6	2015-2011	Non-Turbo	234-5037	-	234-4488	-
L4-1.6	2015	Turbo; N18B16A Engine	234-5026	-	234-4488	-
L4-1.6	2015	Turbo; N18B16C Engine	234-5166	-	234-4971	-
L4-1.6	2014-2013	Turbo	234-5026	-	234-4488	-
L4-1.6	2012-2011	Turbo; Exc. John Cooper Works	234-5026	-	234-4488	-
L4-1.6	2012-2011	Turbo; John Cooper Works	234-5136	-	234-4488	-
L4-1.6	2010-2009	Non-Turbo	234-5135	-	234-4488	-
L4-1.6	2010-2007	Turbo	234-5136	-	234-4488	-
L4-1.6	2008-2007	Non-Turbo; N12B16A Engine	234-5135	-	234-4488	-
L4-1.6	2008-2007	Non-Turbo; W10B16A Engine	234-4457	-	234-4457	-
L4-1.6	2008-2007	Supercharged	234-4457	-	234-4457	-
L4-1.6	2006-2002		234-4457	-	234-4457	-
L4-2.0	2015	S Model	234-5166	-	234-4971	-
L4-2.0	2014		234-5166	-	234-4971	-
<b>COOPER COUNTRYMAN</b>						
L4-1.6	2015-2011	Non-Turbo	234-5037	-	234-4488	-
L4-1.6	2015-2011	Turbo	234-5026	-	234-4488	-
<b>COOPER PACEMAN</b>						
L4-1.6	2015-2013	Non-Turbo	234-5037	-	234-4488	-
L4-1.6	2015-2013	Turbo	234-5026	-	234-4488	-
<b>MITSUBISHI</b>						
<b>3000GT</b>						
V6-3.0	1999-1998		234-4633 <sup>4</sup>	234-4209 <sup>4</sup>	234-4655 <sup>4</sup>	234-4209 <sup>4</sup>
V6-3.0	1999-1998	Non-Turbo; VIN H	234-4631 <sup>5</sup>	234-4209 <sup>5</sup>	234-4645 <sup>5</sup>	234-4209 <sup>5</sup>
V6-3.0	1999-1998	Non-Turbo; VIN J	234-4631 <sup>5</sup>	234-4209 <sup>5</sup>	234-4633 <sup>5</sup>	234-4209 <sup>5</sup>
V6-3.0	1999-1998	Turbo	234-4631 <sup>5</sup>	234-4209 <sup>5</sup>	234-4633 <sup>5</sup>	234-4209 <sup>5</sup>
V6-3.0	1997	Non-Turbo	234-4631 <sup>5</sup>	234-4209 <sup>5</sup>	234-4655 <sup>5</sup>	234-4209 <sup>5</sup>
V6-3.0	1997	Non-Turbo; VIN H	234-4633 <sup>4</sup>	234-4209 <sup>4</sup>	234-4645 <sup>4</sup>	234-4209 <sup>4</sup>
V6-3.0	1997	Non-Turbo; VIN J	234-4633 <sup>4</sup>	234-4209 <sup>4</sup>	234-4633 <sup>4</sup>	234-4209 <sup>4</sup>
V6-3.0	1997	Turbo	234-4633 <sup>4</sup>	234-4209 <sup>4</sup>	234-4655 <sup>4</sup>	234-4209 <sup>4</sup>
V6-3.0	1997	Turbo.	234-4631 <sup>5</sup>	234-4209 <sup>5</sup>	234-4633 <sup>5</sup>	234-4209 <sup>5</sup>
V6-3.0	1996		234-4633 <sup>4</sup>	234-4209 <sup>4</sup>	234-4633 <sup>4</sup>	234-4209 <sup>4</sup>
V6-3.0	1996		234-4631 <sup>5</sup>	234-4209 <sup>5</sup>	234-4655 <sup>5</sup>	234-4209 <sup>5</sup>
V6-3.0	1995-1994	Non-Turbo; Calif.	234-4633 <sup>4</sup>	234-4209 <sup>4</sup>	234-4633 <sup>4</sup>	234-4209 <sup>4</sup>
V6-3.0	1995-1994	Non-Turbo; Calif.	234-4631 <sup>5</sup>	234-4209 <sup>5</sup>	234-4655 <sup>5</sup>	234-4209 <sup>5</sup>
V6-3.0	1995-1994	Non-Turbo; Exc. Calif.	234-4640	234-4209	-	-
V6-3.0	1995-1994	Turbo	234-4633 <sup>4</sup>	234-4209 <sup>4</sup>	234-4633 <sup>4</sup>	234-4209 <sup>4</sup>

<sup>4</sup> Left Side / Côté gauche / Lado izquierdo <sup>5</sup> Right Side / Côté droit / Lado derecho





ENGINE MOTEUR MOTOR	YEAR ANNEE AÑO	APPLICATION INFORMATION INFORMATION D'APPLICATION INFORMACION DE APLICACION	UPSTREAM / AVANT - C.C. / ANTES DEL C.C.		DOWNSTREAM / APRES - C.C. / DESPUES DEL C.C.		
			TYPE / TIPO O.E.	UNIVERS.	TYPE / TIPO O.E.	UNIVERS.	
<b>MITSUBISHI [cont]</b>							
<b>3000GT [cont]</b>							
V6-3.0	1995-1994	Turbo	234-4631 <sup>5</sup>	234-4209 <sup>5</sup>	234-4655 <sup>5</sup>	234-4209 <sup>5</sup>	
V6-3.0	1993	Non-Turbo	234-4640	234-4209	-	-	
V6-3.0	1993	Turbo	234-4633 <sup>4</sup>	234-4209 <sup>4</sup>	-	-	
V6-3.0	1993	Turbo	234-4631 <sup>5</sup>	234-4209 <sup>5</sup>	-	-	
V6-3.0	1992-1991	Non-Turbo	234-4889	-	-	-	
V6-3.0	1992-1991	Turbo	234-4886 <sup>4</sup>	-	-	-	
V6-3.0	1992-1991	Turbo	234-4887 <sup>5</sup>	-	-	-	
<b>CORDIA</b>							
L4-1.8	1988-1983		234-1007	234-1000	-	-	
L4-2.0	1988-1984		234-1005	234-1000	-	-	
<b>DIAMANTE</b>							
V6-3.0	1996		234-4026 <sup>5</sup>	234-4209 <sup>5</sup>	234-4655 <sup>5</sup>	234-4209 <sup>5</sup>	
V6-3.0	1996		234-4633 <sup>4</sup>	234-4209 <sup>4</sup>	234-4633 <sup>4</sup>	234-4209 <sup>4</sup>	
V6-3.0	1995-1994		234-4633 <sup>4</sup>	234-4209 <sup>4</sup>	234-4633 <sup>4</sup>	234-4209 <sup>4</sup>	
V6-3.0	1995-1994	ES Model	234-4026 <sup>5</sup>	234-4209 <sup>5</sup>	234-4655 <sup>5</sup>	234-4209 <sup>5</sup>	
V6-3.0	1995	LS Model	234-4631 <sup>5</sup>	234-4209 <sup>5</sup>	234-4655 <sup>5</sup>	234-4209 <sup>5</sup>	
V6-3.0	1994	LS Model; Calif.	234-4631 <sup>5</sup>	234-4209 <sup>5</sup>	234-4655 <sup>5</sup>	234-4209 <sup>5</sup>	
V6-3.0	1994	LS Model; Exc. Calif.	234-4026 <sup>5</sup>	234-4209 <sup>5</sup>	234-4655 <sup>5</sup>	234-4209 <sup>5</sup>	
V6-3.0	1993-1992		234-4642	234-4209	-	-	
V6-3.5	2004-2001		234-4738 <sup>4</sup>	-	234-4656 <sup>4</sup>	234-4209 <sup>4</sup>	
V6-3.5	2004-2001		234-4739 <sup>5</sup>	-	234-4633 <sup>5</sup>	234-4209 <sup>5</sup>	
V6-3.5	2000-1999	Calif.	234-4738 <sup>4</sup>	-	234-4656 <sup>4</sup>	234-4209 <sup>4</sup>	
V6-3.5	2000-1999	Calif.	234-4739 <sup>5</sup>	-	234-4633 <sup>5</sup>	234-4209 <sup>5</sup>	
V6-3.5	2000-1999	Exc. Calif.	234-4641 <sup>1</sup>	234-4209 <sup>1</sup>	234-4642 <sup>1</sup>	234-4209 <sup>1</sup>	
V6-3.5	1998-1997		234-4641 <sup>1</sup>	234-4209 <sup>1</sup>	234-4642 <sup>1</sup>	234-4209 <sup>1</sup>	
<b>ECLIPSE</b>							
L4-1.8	1994-1991		234-2002	234-2000	-	-	
L4-1.8	1990	Calif.	234-2002	234-2000	-	-	
L4-1.8	1990	Exc. Calif.	234-1007	234-1000	-	-	
L4-2.0	1999-1997	Non-Turbo	234-4076	234-4210	234-4083	234-4210	
L4-2.0	1999-1995	Turbo; GST	234-4026	234-4209	234-4641	234-4209	
L4-2.0	1999-1995	Turbo; GSX	234-4026	234-4209	234-4027	234-4210	
L4-2.0	1996-1995	Non-Turbo	234-4003	234-4210	234-4083	234-4210	
L4-2.0	1994-1991	Turbo	234-4007	234-4210	-	-	
L4-2.0	1994-1990	Non-Turbo	234-4644	234-4209	-	-	
L4-2.0	1990	Turbo	234-4643	234-4209	-	-	
L4-2.4	2012-2006	Cylinder 1,2	234-4316	-	234-4631	234-4209	
L4-2.4	2012-2006	Cylinder 3,4	234-4317	-	234-4026	234-4209	
L4-2.4	2005-2001		234-4738	-	234-4652	234-4209	
L4-2.4	2000	Calif.	234-4738	-	234-4652	234-4209	

<sup>1</sup> 2 Required / Requis 2 / Requeridos 2 <sup>4</sup> Left Side / Côté gauche / Lado izquierdo <sup>5</sup> Right Side / Côté droit / Lado derecho



ENGINE MOTEUR MOTOR	YEAR ANNEE AÑO	APPLICATION INFORMATION INFORMATION D'APPLICATION INFORMACION DE APLICACION	UPSTREAM / AVANT - C.C. / ANTES DEL C.C.		DOWNSTREAM / APRS - C.C. / DESPUES DEL C.C.	
			TYPE / TIPO O.E.	UNIVERS.	TYPE / TIPO O.E.	UNIVERS.
<b>MITSUBISHI [cont]</b>						
<b>ECLIPSE [cont]</b>						
L4-2.4	2000	Exc. Calif.	234-4641	234-4209	234-4642	234-4209
L4-2.4	1999-1998	Calif.	234-4738	-	234-4636	234-4209
L4-2.4	1999-1998	Exc. Calif.	234-4638	234-4209	234-4641	234-4209
L4-2.4	1997-1996		234-4638	234-4209	234-4641	234-4209
V6-3.0	2005-2004		234-4738 <sup>15</sup>	-	234-4656 <sup>15</sup>	234-4209 <sup>15</sup>
V6-3.0	2005-2004		234-4739 <sup>16</sup>	-	234-4656 <sup>16</sup>	234-4209 <sup>16</sup>
V6-3.0	2003-2002		234-4739 <sup>15</sup>	-	234-4656 <sup>15</sup>	234-4209 <sup>15</sup>
V6-3.0	2003-2002		234-4738 <sup>16</sup>	-	234-4656 <sup>16</sup>	234-4209 <sup>16</sup>
V6-3.0	2001		234-4738 <sup>15</sup>	-	234-4656 <sup>15</sup>	234-4209 <sup>15</sup>
V6-3.0	2001		234-4739 <sup>16</sup>	-	234-4656 <sup>16</sup>	234-4209 <sup>16</sup>
V6-3.0	2000	Calif.	234-4739 <sup>15</sup>	-	234-4656	234-4209
V6-3.0	2000	Calif.	234-4738 <sup>16</sup>	-	-	-
V6-3.0	2000	Exc. Calif.	234-4642 <sup>1</sup>	234-4209 <sup>1</sup>	234-4641	234-4209
V6-3.8	2012-2006		234-4738 <sup>16</sup>	-	234-4656 <sup>16</sup>	-
V6-3.8	2012-2006		234-4739 <sup>15</sup>	-	234-4318 <sup>15</sup>	234-4209 <sup>16</sup>
<b>ENDEAVOR</b>						
V6-3.8	2011-2010		234-4739 <sup>15</sup>	-	234-4280 <sup>15</sup>	234-4209 <sup>15</sup>
V6-3.8	2011-2010		234-4741 <sup>16</sup>	-	234-4655 <sup>16</sup>	234-4209 <sup>16</sup>
V6-3.8	2008-2004		234-4739 <sup>15</sup>	-	234-4280 <sup>15</sup>	234-4209 <sup>15</sup>
V6-3.8	2008-2004		234-4741 <sup>16</sup>	-	234-4655 <sup>16</sup>	234-4209 <sup>16</sup>
<b>EXPO</b>						
L4-2.4	1995	AWD	234-4638	234-4209	234-4017	234-4209
L4-2.4	1995	FWD; Calif.	234-4637	234-4209	234-4633	234-4209
L4-2.4	1995	FWD; Exc. Calif.	234-4638	234-4209	234-4017	234-4209
L4-2.4	1994		234-4638	234-4209	234-4017	234-4209
L4-2.4	1993	Calif.	234-4638	234-4209	234-4017	234-4209
L4-2.4	1993	Exc. Calif.	234-2014	234-2000	-	-
L4-2.4	1992		234-2014	234-2000	-	-
<b>EXPO LRV</b>						
L4-1.8	1994		234-4637	234-4209	234-4017	234-4209
L4-1.8	1993	Calif.; AWD	234-4637	234-4209	234-4017	234-4209
L4-1.8	1993	Calif.; FWD	234-4638	234-4209	234-4017	234-4209
L4-1.8	1993	Exc. Calif.	234-2014	234-2000	-	-
L4-1.8	1992		234-2014	234-2000	-	-
L4-2.4	1994		234-4638	234-4209	234-4017	234-4209
L4-2.4	1993	Calif.	234-4638	234-4209	234-4017	234-4209
L4-2.4	1993	Exc. Calif.	234-2014	234-2000	-	-
<b>GALANT</b>						
L4-2.0	1993	Calif.	234-2002	234-2000	-	-
L4-2.0	1993	Exc. Calif.	234-2014	234-2000	-	-

<sup>1</sup> 2 Required / Requis 2 / Requeridos 2 <sup>15</sup> Front / Avant / Parte delantera <sup>16</sup> Rear / Arrière / Parte trasera



ENGINE MOTEUR MOTOR	YEAR ANNEE AÑO	APPLICATION INFORMATION INFORMATION D'APPLICATION INFORMACION DE APLICACION	UPSTREAM / AVANT - C.C. / ANTES DEL C.C.		DOWNSTREAM / APRS - C.C. / DESPUES DEL C.C.	
			TYPE / TIPO O.E.	UNIVERS.	TYPE / TIPO O.E.	UNIVERS.
<b>MITSUBISHI [cont]</b>						
<b>GALANT [cont]</b>						
L4-2.0	1992-1991	VIN U	234-4007	234-4210	-	-
L4-2.0	1992-1989	VIN R	234-4644	234-4209	-	-
L4-2.0	1992-1989	VIN V; Calif.	234-2002	234-2000	-	-
L4-2.0	1992-1989	VIN V; Exc. Calif.	234-1005	234-1000	-	-
L4-2.4	2012-2004	Cylinder 1,2	234-4317	-	234-4026	234-4209
L4-2.4	2012-2004	Cylinder 3,4	234-4316	-	234-4631	234-4209
L4-2.4	2003-2001		234-4738	-	234-4652	234-4209
L4-2.4	2000-1999	Calif.	234-4738	-	234-4652	234-4209
L4-2.4	2000-1999	Exc. Calif.	234-4641	234-4209	234-4641	234-4209
L4-2.4	1998-1995	Calif.	234-4135	234-4212	234-4130	234-4212
L4-2.4	1998-1995	Exc. Calif.	234-4128	234-4212	234-4130	234-4212
L4-2.4	1994	From 05/94; Calif.	234-4135	234-4212	234-4130	234-4212
L4-2.4	1994	From 05/94; Exc. Calif.	234-4128	234-4212	234-4130	234-4212
L4-2.4	1994	To 05/94	234-4128	234-4212	234-4130	234-4212
L4-2.4	1987-1985		234-1007	234-1000	-	-
V6-3.0	2003-2001		234-4738 <sup>4</sup>	-	234-4656 <sup>4</sup>	234-4209 <sup>4</sup>
V6-3.0	2003-2001		234-4739 <sup>5</sup>	-	234-4656 <sup>5</sup>	234-4209 <sup>5</sup>
V6-3.0	2000-1999	Calif.	234-4739 <sup>15</sup>	-	234-4656	234-4209
V6-3.0	2000-1999	Calif.	234-4738 <sup>16</sup>	-	-	-
V6-3.0	2000-1999	Exc. Calif.	234-4639	234-4209	234-4641	234-4209
V6-3.0	1988	Calif.	234-4888	-	-	-
V6-3.0	1988	Exc. Calif.	234-2064	234-2000	-	-
V6-3.8	2009		234-4738 <sup>16</sup>	-	234-4656 <sup>16</sup>	234-4209 <sup>16</sup>
V6-3.8	2009	VIN S	234-4739 <sup>15</sup>	-	234-4280 <sup>15</sup>	234-4209 <sup>15</sup>
V6-3.8	2009	VIN T	234-4739 <sup>15</sup>	-	234-4318 <sup>15</sup>	-
V6-3.8	2008		234-4739 <sup>15</sup>	-	234-4318 <sup>15</sup>	-
V6-3.8	2008		234-4738 <sup>16</sup>	-	234-4656 <sup>16</sup>	234-4209 <sup>16</sup>
V6-3.8	2007-2004		234-4738 <sup>16</sup>	-	234-4656 <sup>16</sup>	234-4209 <sup>16</sup>
V6-3.8	2007	VIN S	234-4739 <sup>15</sup>	-	234-4280 <sup>15</sup>	234-4209 <sup>15</sup>
V6-3.8	2007	VIN T	234-4739 <sup>15</sup>	-	234-4318 <sup>15</sup>	-
V6-3.8	2006-2004		234-4739 <sup>15</sup>	-	234-4280 <sup>15</sup>	234-4209 <sup>15</sup>
<b>LANCER</b>						
L4-2.0	2015	Non-Turbo; Calif.	234-5049	-	234-4116	-
L4-2.0	2015	Non-Turbo; Exc. Calif.	234-5051	-	234-4114	-
L4-2.0	2015	Turbo	234-4116	-	234-4114	-
L4-2.0	2014-2013		234-4116	-	234-4114	-
L4-2.0	2012-2011	Non-Turbo; Calif.	234-5049 <sup>11</sup>	-	234-4386	-
L4-2.0	2012-2011	Non-Turbo; Calif..	-	-	234-4116 <sup>12</sup>	-
L4-2.0	2012-2011	Non-Turbo; Exc. Calif.	234-5051	-	234-4114	-
L4-2.0	2012-2008	Turbo	234-4116	-	234-4114	-

<sup>4</sup> Left Side / Côté gauche / Lado izquierdo <sup>5</sup> Right Side / Côté droit / Lado derecho <sup>11</sup> Loc. Manifold / Empl. collecteur / Ubicación collector <sup>12</sup> Loc. Center / Empl. central / Ubicación central <sup>15</sup> Front / Avant / Parte delantera <sup>16</sup> Rear / Arrière / Parte trasera



ENGINE MOTEUR MOTOR	YEAR ANNEE AÑO	APPLICATION INFORMATION INFORMATION D'APPLICATION INFORMACION DE APLICACION	UPSTREAM / AVANT - C.C. / ANTES DEL C.C.		DOWNSTREAM / APRES - C.C. / DESPUES DEL C.C.	
			TYPE / TIPO O.E.	UNIVERS.	TYPE / TIPO O.E.	UNIVERS.
<b>MITSUBISHI [cont]</b>						
<b>LANCER [cont]</b>						
L4-2.0	2010-2008	Non-Turbo; Calif	-	-	234-4116 <sup>12</sup>	-
L4-2.0	2010-2008	Non-Turbo; Calif.	234-4188 <sup>11</sup>	-	234-4386	-
L4-2.0	2010-2008	Non-Turbo; Exc. Calif	-	-	234-4116 <sup>12</sup>	-
L4-2.0	2010-2008	Non-Turbo; Exc. Calif.	234-4188 <sup>11</sup>	-	234-4114	-
L4-2.0	2007		234-4739	-	234-4430	-
L4-2.0	2006	Non-Turbo; From 03/04/06	234-4739	-	234-4430	-
L4-2.0	2006	Non-Turbo; To 03/03/06	234-4739	-	234-4642	234-4209
L4-2.0	2006	Turbo	234-4741	-	-	-
L4-2.0	2005-2004	Turbo	234-4741	-	234-4281	234-4209
L4-2.0	2005-2003	Non-Turbo	234-4739	-	234-4642	234-4209
L4-2.0	2003	Turbo	234-4741	-	234-4642	234-4209
L4-2.0	2002		234-4739	-	234-4642	234-4209
L4-2.4	2015		234-5051	-	234-4114	-
L4-2.4	2011	Calif	-	-	234-4116 <sup>12</sup>	-
L4-2.4	2011	Calif.	234-5049 <sup>11</sup>	-	234-4386	-
L4-2.4	2011	Exc. Calif.	234-5051	-	234-4114	-
L4-2.4	2010-2009	Exc. Calif	-	-	234-4116 <sup>12</sup>	-
L4-2.4	2010-2009	Exc. Calif.	234-4188 <sup>11</sup>	-	234-4114	-
L4-2.4	2010	Calif.	234-4188 <sup>11</sup>	-	234-4386	-
L4-2.4	2010	Calif.	-	-	234-4116 <sup>12</sup>	-
L4-2.4	2009	Calif.; Hatchback	234-4188 <sup>11</sup>	-	234-4386	-
L4-2.4	2009	Calif.; Hatchback.	-	-	234-4116 <sup>12</sup>	-
L4-2.4	2009	Calif.; Sedan; From 06/01/09	234-4188 <sup>11</sup>	-	234-4386	-
L4-2.4	2009	Calif.; Sedan; From 06/01/09.	-	-	234-4116 <sup>12</sup>	-
L4-2.4	2009	Calif.; Sedan; To 05/03/09	234-4188 <sup>11</sup>	-	234-4114	-
L4-2.4	2006		234-4385	-	234-4383	-
L4-2.4	2005-2004		234-4277	-	234-4281	234-4209
<b>MIGHTY MAX</b>						
L4-2.0	1989-1984		234-1005	234-1000	-	-
L4-2.4	1996	Auto Trans	234-4636	234-4209	234-4658	234-4209
L4-2.4	1996	Manual Trans	234-4637	234-4209	234-4658	234-4209
L4-2.4	1995-1993	Calif.; Auto Trans	234-4636	234-4209	234-4658	234-4209
L4-2.4	1995-1993	Calif.; Manual Trans	234-4637	234-4209	234-4658	234-4209
L4-2.4	1995-1993	Exc. Calif.	234-2067	234-2000	-	-
L4-2.4	1992-1991		234-2067	234-2000	-	-
L4-2.4	1990	Calif.	234-2067	234-2000	-	-
L4-2.4	1990	Exc. Calif.	234-1033	234-1000	-	-
L4-2.6	1989-1984		234-1005	234-1000	-	-
V6-3.0	1994-1990		234-4888	-	-	-

<sup>11</sup> Loc. Manifold / Empl. collecteur / Ubicación collector <sup>12</sup> Loc. Center / Empl. central / Ubicación central



ENGINE MOTEUR MOTOR	YEAR ANNEE AÑO	APPLICATION INFORMATION INFORMATION D'APPLICATION INFORMACION DE APLICACION	UPSTREAM / AVANT - C.C. / ANTES DEL C.C.		DOWNSTREAM / APRS - C.C. / DESPUES DEL C.C.	
			TYPE / TIPO O.E.	UNIVERS.	TYPE / TIPO O.E.	UNIVERS.
<b>MITSUBISHI [cont]</b>						
<b>MIRAGE</b>						
L3-1.2	2015-2014		234-5181	-	234-4952	-
L4-1.5	2002-2001		234-4135	234-4212	234-4633	234-4209
L4-1.5	2000-1998	Calif.	234-4135	234-4212	234-4633	234-4209
L4-1.5	2000-1997	Exc. Calif.	234-4633	234-4209	234-4641	234-4209
L4-1.5	1997	Calif.	234-4633	234-4209	234-4633	234-4209
L4-1.5	1996-1995	Calif.	234-4020	234-4210	234-4032	234-4210
L4-1.5	1996-1995	Exc. Calif.	234-4020	234-4210	234-4081	234-4210
L4-1.5	1994		234-4020	234-4210	234-4081	234-4210
L4-1.5	1993	Calif.	234-4020	234-4210	234-4081	234-4210
L4-1.5	1993	Exc. Calif.	234-2066	234-2000	-	-
L4-1.5	1992-1991		234-2066	234-2000	-	-
L4-1.5	1990		234-2002	234-2000	-	-
L4-1.5	1989	Calif.	234-2002	234-2000	-	-
L4-1.5	1989	Exc. Calif.	234-1007	234-1000	-	-
L4-1.5	1988-1987		234-1007	234-1000	-	-
L4-1.5	1986-1985		234-1005	234-1000	-	-
L4-1.6	1992-1991		234-1007	234-1000	-	-
L4-1.6	1989		234-4643	234-4209	-	-
L4-1.6	1988-1987		234-1007	234-1000	-	-
L4-1.6	1986-1985		234-1005	234-1000	-	-
L4-1.8	2002-2001		234-4738	-	234-4633	234-4209
L4-1.8	2000-1998	Calif.	234-4738	-	234-4633	234-4209
L4-1.8	2000-1997	Exc. Calif.	234-4645	234-4209	234-4641	234-4209
L4-1.8	1997	Calif.	234-4633	234-4209	234-4633	234-4209
L4-1.8	1996-1995	Calif.	234-4638	234-4209	234-4633	234-4209
L4-1.8	1996-1995	Exc. Calif.	234-4638	234-4209	234-4641	234-4209
L4-1.8	1994		234-4638	234-4209	234-4641	234-4209
L4-1.8	1993	Calif.	234-4638	234-4209	234-4641	234-4209
L4-1.8	1993	Exc. Calif.	234-2014	234-2000	-	-
<b>MONTERO</b>						
L4-2.6	1989-1983		234-1005	234-1000	-	-
V6-3.0	1996	Calif.	234-4026 <sup>4</sup>	234-4209 <sup>4</sup>	234-4633 <sup>4</sup>	234-4209 <sup>4</sup>
V6-3.0	1996	Calif.	234-4631 <sup>5</sup>	234-4209 <sup>5</sup>	234-4656 <sup>5</sup>	234-4209 <sup>5</sup>
V6-3.0	1996	Exc. Calif.	234-4633	234-4209	234-4656	234-4209
V6-3.0	1995	Calif.	234-4026 <sup>4</sup>	234-4209 <sup>4</sup>	234-4633 <sup>4</sup>	234-4209 <sup>4</sup>
V6-3.0	1995	Calif.	234-4631 <sup>5</sup>	234-4209 <sup>5</sup>	234-4657 <sup>5</sup>	234-4209 <sup>5</sup>
V6-3.0	1995	Exc. Calif.; Auto Trans	234-4631	234-4209	-	-
V6-3.0	1995	Exc. Calif.; Manual Trans	234-4645	234-4209	-	-
V6-3.0	1994-1992		234-4645	234-4209	-	-
V6-3.0	1991-1990		234-4837	-	-	-

<sup>4</sup> Left Side / Côté gauche / Lado izquierdo <sup>5</sup> Right Side / Côté droit / Lado derecho



ENGINE MOTEUR MOTOR	YEAR ANNEE AÑO	APPLICATION INFORMATION INFORMATION D'APPLICATION INFORMACION DE APLICACION	UPSTREAM / AVANT - C.C. / ANTES DEL C.C.		DOWNSTREAM / APRS - C.C. / DESPUES DEL C.C.	
			TYPE / TIPO O.E.	UNIVERS.	TYPE / TIPO O.E.	UNIVERS.
<b>MITSUBISHI [cont]</b>						
<b>MONTERO [cont]</b>						
V6-3.0	1989		234-2065	234-2000	-	-
V6-3.5	2002-2001		234-4742 <sup>4</sup>	-	234-4633 <sup>4</sup>	234-4209 <sup>4</sup>
V6-3.5	2002-2001		234-4741 <sup>5</sup>	-	234-4656 <sup>5</sup>	234-4209 <sup>5</sup>
V6-3.5	2000-1998	Calif.	234-4742 <sup>4</sup>	-	234-4633 <sup>4</sup>	234-4209 <sup>4</sup>
V6-3.5	2000-1998	Calif.	234-4738 <sup>5</sup>	-	234-4656 <sup>5</sup>	234-4209 <sup>5</sup>
V6-3.5	2000	Exc. Calif.	234-4631	234-4209	234-4657	234-4209
V6-3.5	1999-1997	Exc. Calif.	234-4631	234-4209	234-4656	234-4209
V6-3.5	1997	Calif.	234-4655 <sup>4</sup>	234-4209 <sup>4</sup>	234-4633 <sup>4</sup>	234-4209 <sup>4</sup>
V6-3.5	1997	Calif.	234-4633 <sup>5</sup>	234-4209 <sup>5</sup>	234-4656 <sup>5</sup>	234-4209 <sup>5</sup>
V6-3.5	1996-1995		234-4631	234-4209	234-4656	234-4209
V6-3.5	1994		234-4631	234-4209	-	-
V6-3.8	2006-2003		234-4742 <sup>4</sup>	-	234-4633 <sup>4</sup>	234-4209 <sup>4</sup>
V6-3.8	2006-2003		234-4741 <sup>5</sup>	-	234-4656 <sup>5</sup>	234-4209 <sup>5</sup>
<b>MONTERO SPORT</b>						
L4-2.4	1999-1997	Calif.	234-4026	234-4209	234-4633	234-4209
L4-2.4	1999-1997	Exc. Calif.	234-4633	234-4209	234-4633	234-4209
V6-3.0	2003-2001		234-4742 <sup>4</sup>	-	234-4633 <sup>4</sup>	234-4209 <sup>4</sup>
V6-3.0	2003-2001		234-4741 <sup>5</sup>	-	234-4657 <sup>5</sup>	234-4209 <sup>5</sup>
V6-3.0	2000-1999	Calif.	234-4741 <sup>5</sup>	-	234-4657 <sup>5</sup>	234-4209 <sup>5</sup>
V6-3.0	2000-1997	Exc. Calif.	234-4645	234-4209	234-4633	234-4209
V6-3.0	2000	Calif.	234-4742 <sup>4</sup>	-	234-4633 <sup>4</sup>	234-4209 <sup>4</sup>
V6-3.0	1999-1997	Calif.	234-4656 <sup>4</sup>	234-4209 <sup>4</sup>	234-4633 <sup>4</sup>	234-4209 <sup>4</sup>
V6-3.0	1998-1997	Calif.	234-4631 <sup>5</sup>	234-4209 <sup>5</sup>	234-4657 <sup>5</sup>	234-4209 <sup>5</sup>
V6-3.5	2004-2001		234-4742 <sup>4</sup>	-	234-4633 <sup>4</sup>	234-4209 <sup>4</sup>
V6-3.5	2004-2001		234-4741 <sup>5</sup>	-	234-4657 <sup>5</sup>	234-4209 <sup>5</sup>
V6-3.5	2000-1999	Calif.	234-4742 <sup>4</sup>	-	234-4633 <sup>4</sup>	234-4209 <sup>4</sup>
V6-3.5	2000-1999	Calif.	234-4741 <sup>5</sup>	-	234-4657 <sup>5</sup>	234-4209 <sup>5</sup>
V6-3.5	2000-1999	Exc. Calif.	234-4645	234-4209	234-4633	234-4209
<b>OUTLANDER</b>						
L4-2.4	2015-2014		234-5182	-	234-4116	-
L4-2.4	2013-2011		234-5051	-	234-4114	-
L4-2.4	2010-2008		234-4116	-	234-4114	-
L4-2.4	2006	AWD; From 04/01/06	234-4379	-	234-4282	234-4209
L4-2.4	2006	AWD; To 03/03/06	234-4378	-	234-4282	234-4209
L4-2.4	2006	FWD; From 04/01/06	234-4377	-	234-4282	234-4209
L4-2.4	2006	FWD; To 03/03/06	234-4362	-	234-4282	234-4209
L4-2.4	2005	AWD	234-4378	-	234-4282	234-4209
L4-2.4	2005	FWD	234-4362	-	234-4282	234-4209
L4-2.4	2004	AWD; From 03/03/04	234-4378	-	234-4282	234-4209
L4-2.4	2004	AWD; To 03/02/04	234-4378	-	234-4383	-

<sup>4</sup> Left Side / Côté gauche / Lado izquierdo <sup>5</sup> Right Side / Côté droit / Lado derecho



ENGINE MOTEUR MOTOR	YEAR ANNEE AÑO	APPLICATION INFORMATION INFORMATION D'APPLICATION INFORMACION DE APLICACION	UPSTREAM / AVANT - C.C. / ANTES DEL C.C.		DOWNSTREAM / APRS - C.C. / DESPUES DEL C.C.	
			TYPE / TIPO O.E.	UNIVERS.	TYPE / TIPO O.E.	UNIVERS.
<b>MITSUBISHI [cont]</b>						
<b>OUTLANDER [cont]</b>						
L4-2.4	2004	FWD; From 03/03/04	234-4362	-	234-4282	234-4209
L4-2.4	2004	FWD; To 03/02/04	234-4362	-	234-4383	-
L4-2.4	2003	AWD	234-4378	-	234-4641	234-4209
L4-2.4	2003	FWD	234-4362	-	234-4639	234-4209
V6-3.0	2015-2014		234-5075 <sup>4</sup>	-	234-4656 <sup>4</sup>	234-4209 <sup>4</sup>
V6-3.0	2015-2014		234-5180 <sup>5</sup>	-	234-4631 <sup>5</sup>	234-4209 <sup>5</sup>
V6-3.0	2013-2011		234-4738 <sup>4</sup>	-	234-4656 <sup>4</sup>	234-4209 <sup>4</sup>
V6-3.0	2013-2011		234-4319 <sup>5</sup>	-	234-4631 <sup>5</sup>	234-4209 <sup>5</sup>
V6-3.0	2010-2007		234-4319 <sup>5</sup>	-	-	-
V6-3.0	2010-2007		234-4738 <sup>4</sup>	-	234-4386	-
V6-3.0	2010-2007	Loc. Center	-	-	234-4656 <sup>4,12</sup>	234-4209 <sup>4,12</sup>
V6-3.0	2010-2007	Loc. Center	-	-	234-4631 <sup>5,12</sup>	234-4209 <sup>5,12</sup>
<b>OUTLANDER SPORT</b>						
L4-2.0	2015		234-5180	-	234-4114	-
L4-2.0	2014		234-5180	-	234-4116	-
L4-2.0	2013		234-5049	-	234-4114	-
L4-2.0	2012-2011	Calif	-	-	234-4116 <sup>12</sup>	-
L4-2.0	2012-2011	Calif.	234-5049	-	234-4386	-
L4-2.0	2012-2011	Exc. Calif.	234-5051	-	234-4114	-
<b>PRECIS</b>						
L4-1.5	1994	Fuel Injected	234-4637	234-4209	234-4042	234-4210
L4-1.5	1993	Fuel Injected; Calif.	234-4637	234-4209	234-4042	234-4210
L4-1.5	1993	Fuel Injected; Exc Calif.; To 07/16/93	234-1018	234-1000	234-4042	234-4210
L4-1.5	1993	Fuel Injected; Exc. Calif.; From 07/16/93	234-4637	234-4209	234-4042	234-4210
L4-1.5	1992	Fuel Injected; Calif.; From 07/01/92	234-4637	234-4209	234-4042	234-4210
L4-1.5	1992	Fuel Injected; Calif.; To 07/01/92	234-2002	234-2000	234-4042	234-4210
L4-1.5	1992	Fuel Injected; Canada Model	234-1018	234-1000	-	-
L4-1.5	1992	Fuel Injected; Exc. Calif.	234-1018	234-1000	234-4042	234-4210
L4-1.5	1991-1990	Fuel Injected; Calif.	234-2002	234-2000	-	-
L4-1.5	1991-1990	Fuel Injected; Exc. Calif. & Canada	234-1018	234-1000	-	-
L4-1.5	1989-1988		234-1005	234-1000	-	-
L4-1.5	1987	Auto Trans; From 05/87	234-1005	234-1000	-	-
L4-1.5	1987	Auto Trans; To 04/87	234-1018	234-1000	-	-
L4-1.5	1987	Manual Trans; From 06/87	234-1005	234-1000	-	-
L4-1.5	1987	Manual Trans; To 05/87	234-1018	234-1000	-	-
<b>RAIDER</b>						
V6-3.7	2009-2007		234-4587 <sup>4</sup>	-	234-4588 <sup>4</sup>	-
V6-3.7	2009-2007		234-4588 <sup>5</sup>	-	234-4588 <sup>5</sup>	-
V6-3.7	2006		234-4593 <sup>4</sup>	-	234-4588 <sup>4</sup>	-
V6-3.7	2006		234-4598 <sup>5</sup>	-	234-4587 <sup>5</sup>	-

<sup>1</sup> 2 Required / Requis 2 / Requeridos 2 <sup>4</sup> Left Side / Côté gauche / Lado izquierdo <sup>5</sup> Right Side / Côté droit / Lado derecho <sup>12</sup> Loc. Center / Empl. central / Ubicación central



ENGINE MOTEUR MOTOR	YEAR ANNEE AÑO	APPLICATION INFORMATION INFORMATION D'APPLICATION INFORMACION DE APLICACION	UPSTREAM / AVANT - C.C. / ANTES DEL C.C.		DOWNSTREAM / APRES - C.C. / DESPUES DEL C.C.	
			TYPE / TIPO O.E.	UNIVERS.	TYPE / TIPO O.E.	UNIVERS.
<b>MITSUBISHI [cont]</b>						
<b>RAIDER [cont]</b>						
V8-4.7	2007-2006		234-4744 <sup>1</sup>	234-4212 <sup>1</sup>	234-4756 <sup>1</sup>	234-4212 <sup>1</sup>
<b>RVR</b>						
L4-2.0	2015		234-5180	-	234-4114	-
L4-2.0	2013-2011		234-5051	-	234-4114	-
<b>SIGMA</b>						
V6-3.0	1990-1989	Calif.	234-4888	-	-	-
V6-3.0	1990-1989	Exc. Calif.	234-2064	234-2000	-	-
<b>STARION</b>						
L4-2.6	1989-1983		234-1052	234-1057	-	-
<b>TREDIA</b>						
L4-1.8	1988-1983		234-1007	234-1000	-	-
L4-2.0	1988-1984		234-1005	234-1000	-	-
<b>VAN</b>						
L4-2.4	1990-1987		234-1007	234-1000	-	-
<b>NISSAN</b>						
<b>200SX</b>						
L4-1.6	1998-1997		234-3089	234-3090	234-4705	234-4700
L4-1.6	1996-1995	Calif.	234-3089	234-3090	234-3120	-
L4-1.6	1996	Exc. Calif.; From 05/96	234-3089	234-3090	234-3123	-
L4-1.6	1996	Exc. Calif.; To 05/96	234-1013	234-1000	234-3123	-
L4-1.6	1995	Exc. Calif.	234-1013	234-1000	234-3123	-
L4-1.8	1987		234-3301	-	-	-
L4-1.8	1986	From 01/86	234-3301	-	-	-
L4-1.8	1986	To 01/86	234-3302	-	-	-
L4-1.8	1985-1984		234-3302	-	-	-
L4-2.0	1998		234-3089	234-3090	234-4716	234-4700
L4-2.0	1997-1995		234-3302	-	234-3123	-
L4-2.0	1988-1986		234-1011	234-1000	-	-
L4-2.0	1985-1984		234-1013	234-1000	-	-
L4-2.0	1981-1980		234-1013	234-1000	-	-
L4-2.2	1983-1982		234-1013	234-1000	-	-
V6-3.0	1988-1987		234-3308	-	-	-
<b>240SX</b>						
L4-2.4	1998-1997		234-3096	234-3090	234-4705	234-4700
L4-2.4	1996		234-3096	234-3090	234-3129	-
L4-2.4	1995		234-1013	234-1000	234-3129	-
L4-2.4	1994-1989		234-1013	234-1000	-	-
<b>280ZX</b>						
L6-2.8	1983-1979		234-1013	234-1000	-	-





ENGINE MOTEUR MOTOR	YEAR ANNEE AÑO	APPLICATION INFORMATION INFORMATION D'APPLICATION INFORMACION DE APLICACION	UPSTREAM / AVANT - C.C. / ANTES DEL C.C.		DOWNSTREAM / APRS - C.C. / DESPUES DEL C.C.	
			TYPE / TIPO O.E.	UNIVERS.	TYPE / TIPO O.E.	UNIVERS.
<b>NISSAN [cont]</b>						
<b>300ZX</b>						
V6-3.0	1996		234-3087 <sup>1</sup>	234-3090 <sup>1</sup>	234-4715 <sup>1</sup>	234-4700 <sup>1</sup>
V6-3.0	1995-1994		234-3087 <sup>1</sup>	234-3090 <sup>1</sup>	-	-
V6-3.0	1993-1990		234-3301 <sup>1</sup>	-	-	-
V6-3.0	1989-1987	Non-Turbo	234-3302	-	-	-
V6-3.0	1989-1987	Turbo	234-3122	-	-	-
V6-3.0	1986		234-3120	-	-	-
V6-3.0	1985-1984		234-3302	-	-	-
<b>350Z</b>						
V6-3.5	2009-2008		234-9036 <sup>1</sup>	-	234-4380 <sup>1</sup>	-
V6-3.5	2007		234-9072 <sup>1</sup>	-	234-4380 <sup>1</sup>	-
V6-3.5	2006-2005		234-5061 <sup>4</sup>	-	234-4302 <sup>4</sup>	234-4210 <sup>4</sup>
V6-3.5	2006-2005		234-5061 <sup>5</sup>	-	234-4312 <sup>5</sup>	234-4210 <sup>5</sup>
V6-3.5	2004-2003		234-4308 <sup>4</sup>	-	234-4302 <sup>4</sup>	234-4210 <sup>4</sup>
V6-3.5	2004-2003		234-4308 <sup>5</sup>	-	234-4312 <sup>5</sup>	234-4210 <sup>5</sup>
<b>370Z</b>						
V6-3.7	2015		234-9148 <sup>1</sup>	-	234-4535 <sup>1</sup>	-
V6-3.7	2014		234-9135 <sup>1</sup>	-	234-4535 <sup>1</sup>	-
V6-3.7	2013-2011		234-9135 <sup>1</sup>	-	234-4380 <sup>1</sup>	-
V6-3.7	2010-2009		234-9036 <sup>1</sup>	-	234-4380 <sup>1</sup>	-
<b>720</b>						
L4-2.0	1986-1983		234-1013	234-1000	-	-
L4-2.2	1983		234-1013	234-1000	-	-
L4-2.4	1986-1983		234-1013	234-1000	-	-
<b>810</b>						
L6-2.4	1981-1977		234-1013	234-1000	-	-
<b>ALTIMA</b>						
L4-2.4	2001	From 12/00	234-3113	234-3090	234-4775	234-4700
L4-2.4	2001	To 12/00	234-3112	234-3090	234-4778	234-4700
L4-2.4	2000		234-3112	234-3090	234-4778	234-4700
L4-2.4	1999-1997		234-3075	234-3090	234-4705	234-4700
L4-2.4	1996	From 02/96	234-3075	234-3090	234-4705	234-4700
L4-2.4	1996	To 02/96; Calif.	234-3075	234-3090	234-4705	234-4700
L4-2.4	1996	To 02/96; Exc. Calif.	234-1013	234-1000	234-3123	-
L4-2.4	1995-1993		234-1013	234-1000	234-3123	-
L4-2.5	2015	Calif.	234-9134	-	234-4905	-
L4-2.5	2015	Exc. Calif.	234-9133	-	234-4905	-
L4-2.5	2014-2013	Sedan; Calif.	234-9134	-	234-4905	-
L4-2.5	2014-2013	Sedan; Exc. Calif.	234-9133	-	234-4905	-
L4-2.5	2013	Coupe; Calif.	234-9036	-	234-4382	-

<sup>1</sup> 2 Required / Requis 2 / Requeridos 2 <sup>4</sup> Left Side / Côté gauche / Lado izquierdo <sup>5</sup> Right Side / Côté droit / Lado derecho <sup>12</sup> Loc. Center / Empl. central / Ubicación central



ENGINE MOTEUR MOTOR	YEAR ANNEE AÑO	APPLICATION INFORMATION INFORMATION D'APPLICATION INFORMACION DE APLICACION	UPSTREAM / AVANT - C.C. / ANTES DEL C.C.		DOWNSTREAM / APRES - C.C. / DESPUES DEL C.C.	
			TYPE / TIPO O.E.	UNIVERS.	TYPE / TIPO O.E.	UNIVERS.
<b>NISSAN [cont]</b>						
<b>ALTIMA [cont]</b>						
L4-2.5	2013	Coupe; Calif.; After Primary Catalyst	-	-	234-4381 <sup>12</sup>	-
L4-2.5	2013	Coupe; Exc. Calif.	234-9107	-	234-4381	-
L4-2.5	2012-2011	Gas Engine; Exc. Calif.	234-9107	-	234-4381	-
L4-2.5	2012-2010	Gas Engine; Calif	-	-	234-4381 <sup>12</sup>	-
L4-2.5	2012-2010	Gas Engine; Calif.	234-9036	-	234-4382	-
L4-2.5	2011-2008	Hybrid Engine	234-9038	-	234-4382	-
L4-2.5	2011-2008	Hybrid Engine	-	-	234-4381 <sup>12</sup>	-
L4-2.5	2010	Gas Engine; Exc. Calif.	234-9038	-	234-4381	-
L4-2.5	2009-2008	Gas Engine; Calif.; Coupe	234-9038	-	234-4382	-
L4-2.5	2009-2008	Gas Engine; Calif.; Coupe.	-	-	234-4381 <sup>12</sup>	-
L4-2.5	2009-2008	Gas Engine; Calif.; Sedan	234-9071	-	234-4382	-
L4-2.5	2009-2008	Gas Engine; Calif.; Sedan.	-	-	234-4381 <sup>12</sup>	-
L4-2.5	2009-2008	Gas Engine; Exc. Calif.; Coupe	234-9073	-	234-4381	-
L4-2.5	2009-2008	Gas Engine; Exc. Calif.; Sedan	234-9038	-	234-4381	-
L4-2.5	2007	Gas Engine; Calif	-	-	234-4381 <sup>12</sup>	-
L4-2.5	2007	Gas Engine; Calif.	234-9071	-	234-4382	-
L4-2.5	2007	Gas Engine; Exc. Calif.	234-9073	-	234-4381	-
L4-2.5	2007	Hybrid Engine	234-9073	-	234-4382	-
L4-2.5	2007	Hybrid Engine.	-	-	234-4381 <sup>12</sup>	-
L4-2.5	2006-2004		234-5061	-	234-4301	234-4210
L4-2.5	2003-2002		234-4296	-	234-4309	234-4210
V6-3.5	2015		234-9148 <sup>4</sup>	-	234-4985 <sup>4</sup>	-
V6-3.5	2015		234-9148 <sup>5</sup>	-	234-4986 <sup>5</sup>	-
V6-3.5	2014-2013	Sedan	234-9135 <sup>15</sup>	-	234-4595 <sup>15</sup>	-
V6-3.5	2014-2013	Sedan	234-9135 <sup>16</sup>	-	234-4599 <sup>16</sup>	-
V6-3.5	2013	Coupe	234-9036 <sup>15</sup>	-	234-4381 <sup>15</sup>	-
V6-3.5	2013	Coupe	234-9096 <sup>16</sup>	-	234-4380 <sup>16</sup>	-
V6-3.5	2012-2010		234-9036 <sup>15</sup>	-	234-4381 <sup>15</sup>	-
V6-3.5	2012-2010		234-9096 <sup>16</sup>	-	234-4380 <sup>16</sup>	-
V6-3.5	2009-2008		234-9038 <sup>15</sup>	-	234-4381 <sup>15</sup>	-
V6-3.5	2009-2008		234-9039 <sup>16</sup>	-	234-4380 <sup>16</sup>	-
V6-3.5	2007		234-9072 <sup>15</sup>	-	234-4381 <sup>15</sup>	-
V6-3.5	2007		234-9070 <sup>16</sup>	-	234-4380 <sup>16</sup>	-
V6-3.5	2006		234-5060 <sup>15</sup>	-	234-4301 <sup>15</sup>	234-4210 <sup>15</sup>
V6-3.5	2006		234-5060 <sup>16</sup>	-	234-4312 <sup>16</sup>	234-4210 <sup>16</sup>
V6-3.5	2005	Auto Trans	234-5060 <sup>15</sup>	-	234-4301 <sup>15</sup>	234-4210 <sup>15</sup>
V6-3.5	2005	Auto Trans	234-5060 <sup>16</sup>	-	234-4312 <sup>16</sup>	234-4210 <sup>16</sup>
V6-3.5	2005	Manual Trans	234-5060 <sup>1</sup>	-	234-4301 <sup>1</sup>	234-4210 <sup>1</sup>
V6-3.5	2004	From 01/04; Auto Trans	234-5060 <sup>15</sup>	-	234-4301 <sup>15</sup>	234-4210 <sup>15</sup>
V6-3.5	2004	From 01/04; Auto Trans	234-5060 <sup>16</sup>	-	234-4312 <sup>16</sup>	234-4210 <sup>16</sup>

<sup>1</sup> 2 Required / Requis 2 / Requeridos 2 <sup>4</sup> Left Side / Côté gauche / Lado izquierdo <sup>5</sup> Right Side / Côté droit / Lado derecho <sup>12</sup> Loc. Center / Empl. central / Ubicación central <sup>15</sup> Front / Avant / Parte delantera <sup>16</sup> Rear / Arrière / Parte trasera



ENGINE MOTEUR MOTOR	YEAR ANNEE AÑO	APPLICATION INFORMATION INFORMATION D'APPLICATION INFORMACION DE APLICACION	UPSTREAM / AVANT - C.C. / ANTES DEL C.C.		DOWNSTREAM / APRES - C.C. / DESPUES DEL C.C.	
			TYPE / TIPO O.E.	UNIVERS.	TYPE / TIPO O.E.	UNIVERS.
<b>NISSAN [cont]</b>						
<b>ALTIMA [cont]</b>						
V6-3.5	2004	From 01/04; Manual Trans	234-5060 <sup>1</sup>	-	234-4301 <sup>1</sup>	234-4210 <sup>1</sup>
V6-3.5	2004	To 01/04	234-3113 <sup>15</sup>	234-3090 <sup>15</sup>	234-4775 <sup>15</sup>	234-4700 <sup>15</sup>
V6-3.5	2004	To 01/04	234-3113 <sup>16</sup>	234-3090 <sup>16</sup>	234-4273 <sup>16</sup>	234-4700 <sup>16</sup>
V6-3.5	2003-2002		234-3113 <sup>15</sup>	234-3090 <sup>15</sup>	234-4775 <sup>15</sup>	234-4700 <sup>15</sup>
V6-3.5	2003-2002		234-3113 <sup>16</sup>	234-3090 <sup>16</sup>	234-4273 <sup>16</sup>	234-4700 <sup>16</sup>
<b>ARMADA</b>						
V8-5.6	2015-2014		234-9135 <sup>1</sup>	-	234-4835 <sup>1</sup>	-
V8-5.6	2013-2008		234-9038 <sup>1</sup>	-	234-4835 <sup>1</sup>	-
V8-5.6	2007		234-9072 <sup>1</sup>	-	234-4835 <sup>1</sup>	-
V8-5.6	2006-2005		234-5060 <sup>1</sup>	-	234-4835 <sup>1</sup>	-
<b>AXXESS</b>						
L4-2.4	1995-1992		234-1013	234-1000	-	-
L4-2.4	1991-1990	4WD	234-1013	234-1000	-	-
L4-2.4	1991	FWD; From 05/91	234-1013	234-1000	-	-
L4-2.4	1991	FWD; To 05/91	234-1011	234-1000	-	-
L4-2.4	1990	FWD	234-1011	234-1000	-	-
<b>CUBE</b>						
L4-1.8	2014-2011	Calif.	234-9082	-	234-4536	-
L4-1.8	2014-2011	Exc. Calif.	234-9106	-	234-4380	-
L4-1.8	2010		234-9096	-	234-4380	-
L4-1.8	2009		234-9039	-	234-4380	-
<b>D21</b>						
L4-2.4	1994-1990		234-1011	234-1000	-	-
L4-2.4	1989-1987		234-1013	234-1000	-	-
L4-2.4	1986	From 05/86	234-1011	234-1000	-	-
L4-2.4	1986	To 05/86	234-1013	234-1000	-	-
V6-3.0	1994		234-3093	234-3090	-	-
V6-3.0	1993-1990		234-3121	-	-	-
V6-3.0	1989-1986		234-3307	-	-	-
<b>FRONTIER</b>						
L4-2.4	2004-2002		234-3113	234-3090	234-4323	-
L4-2.4	2001		234-3109	234-3090	234-4323	-
L4-2.4	2000-1998	Calif.	234-3089	234-3090	234-4323	-
L4-2.4	2000-1998	Exc. Calif.	234-3089	234-3090	234-4714	234-4700
L4-2.5	2015-2013		234-9127	-	234-4297	-
L4-2.5	2012-2010		234-9038	-	234-4297	-
L4-2.5	2009-2005		234-5062	-	234-4297	-
V6-3.3	2004		234-3015 <sup>4</sup>	-	234-4198 <sup>4</sup>	-
V6-3.3	2004	Auto Trans	234-3006 <sup>5</sup>	-	234-4197 <sup>5</sup>	-
V6-3.3	2004	Manual Trans	234-3006 <sup>5</sup>	-	234-4198 <sup>5</sup>	-

<sup>1</sup> 2 Required / Requis 2 / Requeridos 2 <sup>4</sup> Left Side / Côté gauche / Lado izquierdo <sup>5</sup> Right Side / Côté droit / Lado derecho <sup>15</sup> Front / Avant / Parte delantera <sup>16</sup> Rear / Arrière / Parte trasera



ENGINE MOTEUR MOTOR	YEAR ANNEE AÑO	APPLICATION INFORMATION INFORMATION D'APPLICATION INFORMACION DE APLICACION	UPSTREAM / AVANT - C.C. / ANTES DEL C.C.		DOWNSTREAM / APRES - C.C. / DESPUES DEL C.C.	
			TYPE / TIPO O.E.	UNIVERS.	TYPE / TIPO O.E.	UNIVERS.
<b>NISSAN [cont]</b>						
<b>FRONTIER [cont]</b>						
V6-3.3	2003-1999		234-3098 <sup>4</sup>	234-3090 <sup>4</sup>	234-4703 <sup>4</sup>	234-4700 <sup>4</sup>
V6-3.3	2003-1999	Auto Trans	234-3089 <sup>5</sup>	234-3090 <sup>5</sup>	234-4704 <sup>5</sup>	234-4700 <sup>5</sup>
V6-3.3	2003-1999	Manual Trans	234-3089 <sup>5</sup>	234-3090 <sup>5</sup>	234-4703 <sup>5</sup>	234-4700 <sup>5</sup>
V6-4.0	2015		234-9148 <sup>1</sup>	-	234-4906 <sup>1</sup>	-
V6-4.0	2014-2013		234-9135 <sup>1</sup>	-	234-4906 <sup>1</sup>	-
V6-4.0	2012-2011		234-9036 <sup>4</sup>	-	234-4297 <sup>4</sup>	-
V6-4.0	2012-2011		234-9036 <sup>5</sup>	-	234-4313 <sup>5</sup>	-
V6-4.0	2010-2008		234-9038 <sup>4</sup>	-	234-4297 <sup>4</sup>	-
V6-4.0	2010-2008		234-9038 <sup>5</sup>	-	234-4313 <sup>5</sup>	-
V6-4.0	2007		234-9072 <sup>4</sup>	-	234-4297 <sup>4</sup>	-
V6-4.0	2007		234-9072 <sup>5</sup>	-	234-4313 <sup>5</sup>	-
V6-4.0	2006-2005		234-5060 <sup>4</sup>	-	234-4297 <sup>4</sup>	-
V6-4.0	2006-2005		234-5060 <sup>5</sup>	-	234-4313 <sup>5</sup>	-
<b>GT-R</b>						
V6-3.8	2015-2009		234-9080 <sup>4</sup>	-	234-4381 <sup>4</sup>	-
V6-3.8	2015-2009		234-9071 <sup>5</sup>	-	234-4381 <sup>5</sup>	-
<b>JUKE</b>						
L4-1.6	2015	Exc. Nismo RS Model; AWD	234-9147	-	234-4985	-
L4-1.6	2015	Exc. Nismo RS Model; FWD	234-9147	-	234-4986	-
L4-1.6	2015	Nismo RS Model	234-9105	-	234-4535	-
L4-1.6	2014-2011		234-9105	-	234-4535	-
<b>MAXIMA</b>						
L6-2.4	1984-1981		234-1013	234-1000	-	-
V6-3.0	2001		234-3109 <sup>4</sup>	234-3090 <sup>4</sup>	234-4777 <sup>4</sup>	234-4700 <sup>4</sup>
V6-3.0	2001		234-3111 <sup>5</sup>	234-3090 <sup>5</sup>	234-4776 <sup>5</sup>	234-4700 <sup>5</sup>
V6-3.0	2000	Calif.	234-3109 <sup>4</sup>	234-3090 <sup>4</sup>	234-4777 <sup>4</sup>	234-4700 <sup>4</sup>
V6-3.0	2000	Calif.	234-3111 <sup>5</sup>	234-3090 <sup>5</sup>	234-4776 <sup>5</sup>	234-4700 <sup>5</sup>
V6-3.0	2000	Exc. Calif.	234-3110 <sup>4</sup>	234-3090 <sup>4</sup>	234-4324	-
V6-3.0	2000	Exc. Calif.	234-3111 <sup>5</sup>	234-3090 <sup>5</sup>	-	-
V6-3.0	1999	Calif.	234-3095 <sup>4</sup>	234-3090 <sup>4</sup>	234-4777 <sup>4</sup>	234-4700 <sup>4</sup>
V6-3.0	1999	Calif.	234-3098 <sup>5</sup>	234-3090 <sup>5</sup>	234-4776 <sup>5</sup>	234-4700 <sup>5</sup>
V6-3.0	1999	Exc. Calif.	234-3098 <sup>1</sup>	234-3090 <sup>1</sup>	234-4716	234-4700
V6-3.0	1998	From 06/98; Calif.	234-3095 <sup>4</sup>	234-3090 <sup>4</sup>	234-4777 <sup>4</sup>	234-4700 <sup>4</sup>
V6-3.0	1998	From 06/98; Calif.	234-3098 <sup>5</sup>	234-3090 <sup>5</sup>	234-4776 <sup>5</sup>	234-4700 <sup>5</sup>
V6-3.0	1998	From 06/98; Exc. Calif.	234-3098 <sup>1</sup>	234-3090 <sup>1</sup>	234-4716	234-4700
V6-3.0	1998	To 06/98	234-3098 <sup>1</sup>	234-3090 <sup>1</sup>	234-4716	234-4700
V6-3.0	1997		234-3098 <sup>1</sup>	234-3090 <sup>1</sup>	234-4716	234-4700
V6-3.0	1996	From 06/96	234-3098 <sup>1</sup>	234-3090 <sup>1</sup>	234-3128	-
V6-3.0	1996	To 06/96	234-3098 <sup>1</sup>	234-3090 <sup>1</sup>	234-3123	-

<sup>1</sup> 2 Required / Requis 2 / Requeridos 2 <sup>4</sup> Left Side / Côté gauche / Lado izquierdo <sup>5</sup> Right Side / Côté droit / Lado derecho



ENGINE MOTEUR MOTOR	YEAR ANNEE AÑO	APPLICATION INFORMATION INFORMATION D'APPLICATION INFORMACION DE APLICACION	UPSTREAM / AVANT - C.C. / ANTES DEL C.C.		DOWNSTREAM / APRS - C.C. / DESPUES DEL C.C.	
			TYPE / TIPO O.E.	UNIVERS.	TYPE / TIPO O.E.	UNIVERS.
<b>NISSAN [cont]</b>						
<b>MAXIMA [cont]</b>						
V6-3.0	1995		234-3098 <sup>1</sup>	234-3090 <sup>1</sup>	234-3123	-
V6-3.0	1994-1990		234-3126	-	-	-
V6-3.0	1989		234-3309	-	-	-
V6-3.0	1988-1987		234-3302	-	-	-
V6-3.0	1986	From 01/86	234-3120	-	-	-
V6-3.0	1986	To 01/86	234-3302	-	-	-
V6-3.0	1985		234-3302	-	-	-
V6-3.5	2014		234-9135 <sup>15</sup>	-	234-4381 <sup>15</sup>	-
V6-3.5	2014		234-9106 <sup>16</sup>	-	234-4380 <sup>16</sup>	-
V6-3.5	2013-2010		234-9036 <sup>15</sup>	-	234-4381 <sup>15</sup>	-
V6-3.5	2013-2010		234-9096 <sup>16</sup>	-	234-4380 <sup>16</sup>	-
V6-3.5	2009		234-9038 <sup>15</sup>	-	234-4381 <sup>15</sup>	-
V6-3.5	2009		234-9039 <sup>16</sup>	-	234-4380 <sup>16</sup>	-
V6-3.5	2008-2007		234-5060 <sup>1</sup>	-	234-4301 <sup>1</sup>	234-4210 <sup>1</sup>
V6-3.5	2006-2004	Auto Trans	234-5060 <sup>16</sup>	-	234-4312 <sup>5</sup>	234-4210 <sup>5</sup>
V6-3.5	2006-2004	Auto Trans	234-5060 <sup>15</sup>	-	234-4301 <sup>15</sup>	234-4210 <sup>15</sup>
V6-3.5	2006-2004	Manual Trans	234-5060 <sup>1</sup>	-	234-4301 <sup>1</sup>	234-4210 <sup>1</sup>
V6-3.5	2003-2002		234-3113 <sup>15</sup>	234-3090 <sup>15</sup>	234-4241 <sup>15</sup>	234-4700 <sup>15</sup>
V6-3.5	2003-2002		234-3113 <sup>16</sup>	234-3090 <sup>16</sup>	234-4270 <sup>16</sup>	234-4700 <sup>16</sup>
<b>MICRA</b>						
L4-1.2	1991-1986	Manual Trans	234-1011	234-1000	-	-
L4-1.6	2015		234-9127	-	234-4534	-
<b>MULTI</b>						
L4-2.0	1988-1986		234-1011	234-1000	-	-
<b>MURANO</b>						
V6-3.5	2015		234-9148 <sup>4</sup>	-	234-4985 <sup>4</sup>	-
V6-3.5	2015		234-9148 <sup>5</sup>	-	234-4986 <sup>5</sup>	-
V6-3.5	2014-2012		234-9106 <sup>5</sup>	-	234-4599 <sup>5</sup>	-
V6-3.5	2014-2012	AWD	234-9135 <sup>4</sup>	-	234-4599 <sup>4</sup>	-
V6-3.5	2014-2012	FWD	234-9135 <sup>4</sup>	-	234-4595 <sup>4</sup>	-
V6-3.5	2011		234-9106 <sup>5</sup>	-	234-4380 <sup>5</sup>	-
V6-3.5	2011	AWD	234-9135 <sup>4</sup>	-	234-4380 <sup>4</sup>	-
V6-3.5	2011	FWD	234-9135 <sup>4</sup>	-	234-4381 <sup>4</sup>	-
V6-3.5	2010-2009		234-9081 <sup>5</sup>	-	234-4380 <sup>5</sup>	-
V6-3.5	2010-2009	AWD	234-9037 <sup>4</sup>	-	234-4380 <sup>4</sup>	-
V6-3.5	2010-2009	FWD	234-9037 <sup>4</sup>	-	234-4381 <sup>4</sup>	-
V6-3.5	2007-2004		234-5060 <sup>1</sup>	-	234-4301 <sup>1</sup>	234-4210 <sup>1</sup>
V6-3.5	2003		234-4296 <sup>1</sup>	-	234-4301 <sup>1</sup>	234-4210 <sup>1</sup>

<sup>1</sup> 2 Required / Requis 2 / Requeridos 2 <sup>4</sup> Left Side / Côté gauche / Lado izquierdo <sup>5</sup> Right Side / Côté droit / Lado derecho <sup>15</sup> Front / Avant / Parte delantera <sup>16</sup> Rear / Arrière / Parte trasera



ENGINE MOTEUR MOTOR	YEAR ANNEE AÑO	APPLICATION INFORMATION INFORMATION D'APPLICATION INFORMACION DE APLICACION	UPSTREAM / AVANT - C.C. / ANTES DEL C.C.		DOWNSTREAM / APRS - C.C. / DESPUES DEL C.C.	
			TYPE / TIPO O.E.	UNIVERS.	TYPE / TIPO O.E.	UNIVERS.
<b>NISSAN [cont]</b>						
<b>NV200</b>						
L4-2.0	2015-2013		234-9135	-	234-4599	-
<b>NV1500</b>						
V6-4.0	2014-2012		234-9135 <sup>4</sup>	-	234-4297 <sup>4</sup>	-
V6-4.0	2014-2012		234-9135 <sup>5</sup>	-	234-4313 <sup>5</sup>	-
<b>NV2500</b>						
V6-4.0	2014-2012		234-9135 <sup>4</sup>	-	234-4297 <sup>4</sup>	-
V6-4.0	2014-2012		234-9135 <sup>5</sup>	-	234-4313 <sup>5</sup>	-
V8-5.6	2014-2012		234-9104 <sup>1</sup>	-	234-4381 <sup>1</sup>	-
<b>NV3500</b>						
V6-4.0	2014-2012		234-9135 <sup>4</sup>	-	234-4297 <sup>4</sup>	-
V6-4.0	2014-2012		234-9135 <sup>5</sup>	-	234-4313 <sup>5</sup>	-
V8-5.6	2014-2012		234-9104 <sup>1</sup>	-	234-4381 <sup>1</sup>	-
<b>NX</b>						
L4-1.6	1993-1991		234-1013	234-1000	-	-
L4-2.0	1993-1991		234-3302	-	-	-
<b>PATHFINDER</b>						
L4-2.4	1988-1987		234-1013	234-1000	-	-
L4-2.5	2014		234-9127	-	234-4906	-
V6-3.0	1995-1994		234-3093	234-3090	-	-
V6-3.0	1993-1990		234-3121	-	-	-
V6-3.0	1989-1987		234-3307	-	-	-
V6-3.3	2000-1996		234-3097 <sup>4</sup>	234-3090 <sup>4</sup>	234-4703 <sup>4</sup>	234-4700 <sup>4</sup>
V6-3.3	2000-1996		234-3087 <sup>5</sup>	234-3090 <sup>5</sup>	234-4704 <sup>5</sup>	234-4700 <sup>5</sup>
V6-3.5	2015		234-9148 <sup>4</sup>	-	234-4985 <sup>4</sup>	-
V6-3.5	2015		234-9148 <sup>5</sup>	-	234-4986 <sup>5</sup>	-
V6-3.5	2014-2013		234-9135 <sup>4</sup>	-	234-4595 <sup>4</sup>	-
V6-3.5	2014-2013		234-9135 <sup>5</sup>	-	234-4599 <sup>5</sup>	-
V6-3.5	2004		234-4295 <sup>4</sup>	-	234-4315 <sup>4</sup>	-
V6-3.5	2004		234-4308 <sup>5</sup>	-	234-4314 <sup>5</sup>	-
V6-3.5	2003		234-4295 <sup>4</sup>	-	234-4311 <sup>4</sup>	234-4210 <sup>4</sup>
V6-3.5	2003		234-4308 <sup>5</sup>	-	234-4310 <sup>5</sup>	234-4210 <sup>5</sup>
V6-3.5	2002		234-3106 <sup>4</sup>	234-3090 <sup>4</sup>	234-4713 <sup>4</sup>	234-4700 <sup>4</sup>
V6-3.5	2002		234-3305 <sup>5</sup>	234-3090 <sup>5</sup>	234-4713 <sup>5</sup>	234-4700 <sup>5</sup>
V6-3.5	2001	From 08/00	234-3106 <sup>4</sup>	234-3090 <sup>4</sup>	234-4713 <sup>4</sup>	234-4700 <sup>4</sup>
V6-3.5	2001	From 08/00	234-3305 <sup>5</sup>	234-3090 <sup>5</sup>	234-4713 <sup>5</sup>	234-4700 <sup>5</sup>
V6-3.5	2001	To 08/00	234-3306 <sup>4</sup>	234-3090 <sup>5</sup>	234-4327 <sup>4</sup>	-
V6-3.5	2001	To 08/00	234-3111 <sup>5</sup>	-	234-4776 <sup>5</sup>	234-4700 <sup>5</sup>
V6-4.0	2012-2011		234-9036 <sup>4</sup>	-	234-4297 <sup>4</sup>	-

<sup>1</sup> 2 Required / Requis 2 / Requeridos 2 <sup>4</sup> Left Side / Côté gauche / Lado izquierdo <sup>5</sup> Right Side / Côté droit / Lado derecho



ENGINE MOTEUR MOTOR	YEAR ANNEE AÑO	APPLICATION INFORMATION INFORMATION D'APPLICATION INFORMACION DE APLICACION	UPSTREAM / AVANT - C.C. / ANTES DEL C.C.		DOWNSTREAM / APRES - C.C. / DESPUES DEL C.C.	
			TYPE / TIPO O.E.	UNIVERS.	TYPE / TIPO O.E.	UNIVERS.
<b>NISSAN [cont]</b>						
<b>PATHFINDER [cont]</b>						
V6-4.0	2012-2011		234-9036 <sup>5</sup>	-	234-4313 <sup>5</sup>	-
V6-4.0	2010-2008		234-9038 <sup>4</sup>	-	234-4297 <sup>4</sup>	-
V6-4.0	2010-2008		234-9038 <sup>5</sup>	-	234-4313 <sup>5</sup>	-
V6-4.0	2007		234-9072 <sup>4</sup>	-	234-4297 <sup>4</sup>	-
V6-4.0	2007		234-9072 <sup>5</sup>	-	234-4313 <sup>5</sup>	-
V6-4.0	2006-2005		234-5060 <sup>4</sup>	-	234-4297 <sup>4</sup>	-
V6-4.0	2006-2005		234-5060 <sup>5</sup>	-	234-4313 <sup>5</sup>	-
V8-5.6	2012-2008		234-9038 <sup>1</sup>	-	234-4835 <sup>1</sup>	-
V8-5.6	2004		234-5060 <sup>1</sup>	-	234-4835 <sup>1</sup>	-
<b>PICKUP</b>						
L4-2.4	1997		234-3075	234-3090	234-4703	234-4700
L4-2.4	1996	From 01/96	234-3075	234-3090	234-4703	234-4700
L4-2.4	1996	To 01/96	234-1011	234-1000	-	-
L4-2.4	1995		234-1011	234-1000	-	-
V6-3.0	1996-1995		234-3093	234-3090	-	-
<b>PULSAR</b>						
L4-1.6	1983		234-1013	234-1000	-	-
<b>PULSAR NX</b>						
L4-1.5	1984-1983		234-1013	234-1000	-	-
L4-1.6	1990-1989		234-1013	234-1000	-	-
L4-1.6	1988		234-1011	234-1000	-	-
L4-1.6	1987	SE Model	234-3120	-	-	-
L4-1.6	1987	XE Model	234-3129	-	-	-
L4-1.6	1986-1983		234-1013	234-1000	-	-
L4-1.8	1989-1988		234-1011	234-1000	-	-
<b>QUEST</b>						
V6-3.0	1998		234-3075	234-3090	234-4779	234-4700
V6-3.0	1997-1996		234-3075	234-3090	234-4702	234-4700
V6-3.0	1995		234-3075	234-3090	-	-
V6-3.0	1994	From 11/93	234-3075	234-3090	-	-
V6-3.0	1994	To 11/93	234-3126	-	-	-
V6-3.0	1993		234-3126	-	-	-
V6-3.3	2002-2001		234-3089	234-3090	234-4701	234-4700
V6-3.3	2000-1999	Calif.	234-3089	234-3090	234-4701	234-4700
V6-3.3	2000-1999	Exc. Calif.	234-3075	234-3090	234-4779	234-4700
V6-3.5	2015		234-9148 <sup>4</sup>	-	234-4987 <sup>4</sup>	-
V6-3.5	2015		234-9148 <sup>5</sup>	-	234-4985 <sup>5</sup>	-
V6-3.5	2014-2012		234-9135 <sup>4</sup>	-	234-4595 <sup>4</sup>	-
V6-3.5	2014		234-9135 <sup>5</sup>	-	234-4599 <sup>5</sup>	-
V6-3.5	2013-2012		234-9106 <sup>5</sup>	-	234-4599 <sup>5</sup>	-

<sup>1</sup> 2 Required / Requis 2 / Requeridos 2 <sup>4</sup> Left Side / Côté gauche / Lado izquierdo <sup>5</sup> Right Side / Côté droit / Lado derecho



ENGINE MOTEUR MOTOR	YEAR ANNEE AÑO	APPLICATION INFORMATION INFORMATION D'APPLICATION INFORMACION DE APLICACION	UPSTREAM / AVANT - C.C. / ANTES DEL C.C.		DOWNSTREAM / APRES - C.C. / DESPUES DEL C.C.	
			TYPE / TIPO O.E.	UNIVERS.	TYPE / TIPO O.E.	UNIVERS.
<b>NISSAN [cont]</b>						
<b>QUEST [cont]</b>						
V6-3.5	2011		234-9135 <sup>4</sup>	-	234-4381 <sup>4</sup>	-
V6-3.5	2011		234-9106 <sup>5</sup>	-	234-4380 <sup>5</sup>	-
V6-3.5	2009-2007		234-5060 <sup>16</sup>	-	234-4312 <sup>5</sup>	234-4210 <sup>5</sup>
V6-3.5	2009-2007		234-5060 <sup>15</sup>	-	234-4301 <sup>15</sup>	234-4210 <sup>15</sup>
V6-3.5	2006-2005	Exc. SE	234-5060 <sup>1</sup>	-	234-4301 <sup>1</sup>	234-4210 <sup>1</sup>
V6-3.5	2006-2005	SE	234-5060 <sup>15</sup>	-	234-4301 <sup>15</sup>	234-4210 <sup>15</sup>
V6-3.5	2006-2005	SE	234-5060 <sup>16</sup>	-	234-4312 <sup>16</sup>	234-4210 <sup>16</sup>
V6-3.5	2004	4 Speed	234-5060 <sup>1</sup>	-	234-4301 <sup>1</sup>	234-4210 <sup>1</sup>
V6-3.5	2004	5 Speed	234-5060 <sup>15</sup>	-	234-4312 <sup>15</sup>	234-4210 <sup>15</sup>
V6-3.5	2004	5 Speed	234-5060 <sup>16</sup>	-	234-4301 <sup>16</sup>	234-4210 <sup>16</sup>
<b>ROGUE</b>						
L4-2.5	2015		234-4906	-	234-9149	-
L4-2.5	2014		234-9149	-	234-4906	-
L4-2.5	2013		234-9036	-	234-4380	-
L4-2.5	2012-2011	Calif.	-	-	234-4380 <sup>12</sup>	-
L4-2.5	2012-2011	Exc. Calif.	234-9036	-	234-4380	-
L4-2.5	2012-2010	Calif.	234-9036	-	234-4382	-
L4-2.5	2010	Exc. Calif.	234-9038	-	234-4380	-
L4-2.5	2009-2008	Calif.	234-9071	-	234-4382	-
L4-2.5	2009-2008	Exc. Calif.	234-9073	-	234-4380	-
<b>ROGUE SELECT</b>						
L4-2.5	2015-2014		234-9036	-	234-4380	-
<b>SENTRA</b>						
L4-1.5	1983-1982		234-1013	234-1000	-	-
L4-1.6	1999-1997		234-3089	234-3090	234-4705	234-4700
L4-1.6	1996-1995	Japan Built; Calif.	234-3089	234-3090	234-3120	-
L4-1.6	1996	Japan Built; Exc. Calif.; From 05/96	234-3089	234-3090	-	-
L4-1.6	1996	Japan Built; Exc. Calif.; To 05/96	234-1013	234-1000	234-3123	-
L4-1.6	1996	Mexico Built	234-3089	234-3090	234-3123	-
L4-1.6	1995	Japan Built; Auto Trans; Exc. Calif.	234-3089	234-3090	234-3123	-
L4-1.6	1995	Japan Built; Manual Trans; Exc. Calif.	234-1013	234-1000	234-3123	-
L4-1.6	1995	Mexico Built; Auto Trans	234-3089	234-3090	234-3123	-
L4-1.6	1995	Mexico Built; Manual Trans	234-1013	234-1000	234-3123	-
L4-1.6	1994	Calif.	234-1013	234-1000	-	-
L4-1.6	1994	Exc. Calif.	234-3089	234-3090	-	-
L4-1.6	1993-1989		234-1013	234-1000	-	-
L4-1.6	1988	1 Lead Sensor	234-1011	234-1000	-	-
L4-1.6	1988	3 Lead Sensor	234-3129	-	-	-
L4-1.6	1987	Carbureted	234-3129	-	-	-
L4-1.6	1987	Fuel Injected; 1 Lead Sensor	234-1011	234-1000	-	-

<sup>1</sup> 2 Required / Requis 2 / Requeridos 2 <sup>5</sup> Right Side / Côté droit / Lado derecho <sup>12</sup> Loc. Center / Empl. central / Ubicación central <sup>15</sup> Front / Avant / Parte delantera <sup>16</sup> Rear / Arrière / Parte trasera





ENGINE MOTEUR MOTOR	YEAR ANNEE AÑO	APPLICATION INFORMATION INFORMATION D'APPLICATION INFORMACION DE APLICACION	UPSTREAM / AVANT - C.C. / ANTES DEL C.C.		DOWNSTREAM / APRS - C.C. / DESPUES DEL C.C.	
			TYPE / TIPO O.E.	UNIVERS.	TYPE / TIPO O.E.	UNIVERS.
<b>NISSAN [cont]</b>						
<b>SENTRA [cont]</b>						
L4-1.6	1987	Fuel Injected; 3 Lead Sensor	234-3129	-	-	-
L4-1.6	1986-1983		234-1013	234-1000	-	-
L4-1.8	2015-2013	Calif.	234-9132	-	234-4904	-
L4-1.8	2015-2013	Exc. Calif.	234-9135	-	234-4904	-
L4-1.8	2006-2004		234-5061	-	234-4835	-
L4-1.8	2003	From 04/03	234-5061	-	234-4835	-
L4-1.8	2003	To 04/03; Calif.	234-5061	-	234-4835	-
L4-1.8	2003	To 04/03; Exc. Calif.	234-4814	-	234-4835	-
L4-1.8	2002-2000	Clean Air Vehicle	234-5060	-	234-4778	234-4700
L4-1.8	2002-2000	Clean Air Vehicle; Loc. Center	-	-	234-4328 <sup>12</sup>	-
L4-1.8	2002	Exc. Clean Air Vehicle	234-4468 <sup>4</sup>	-	234-4270 <sup>4</sup>	234-4700 <sup>4</sup>
L4-1.8	2002	Exc. Clean Air Vehicle	234-4296 <sup>5</sup>	-	234-4241 <sup>5</sup>	234-4700 <sup>5</sup>
L4-1.8	2001	Exc. Clean Air Vehicle; From 08/01/01	234-3113 <sup>4</sup>	234-3090 <sup>4</sup>	234-4270 <sup>4</sup>	234-4700 <sup>4</sup>
L4-1.8	2001	Exc. Clean Air Vehicle; From 08/01/01	234-3113 <sup>5</sup>	234-3090 <sup>5</sup>	234-4241 <sup>5</sup>	234-4700 <sup>5</sup>
L4-1.8	2001	Exc. Clean Air Vehicle; To 08/01/01	234-3109 <sup>4</sup>	234-3090 <sup>4</sup>	234-4776 <sup>4</sup>	234-4700 <sup>4</sup>
L4-1.8	2001	Exc. Clean Air Vehicle; To 08/01/01	234-3109 <sup>5</sup>	234-3090 <sup>5</sup>	234-4777 <sup>5</sup>	234-4700 <sup>5</sup>
L4-1.8	2000	Exc. Clean Air Vehicle	234-3109 <sup>4</sup>	234-3090 <sup>4</sup>	234-4776 <sup>4</sup>	234-4700 <sup>4</sup>
L4-1.8	2000	Exc. Clean Air Vehicle	234-3109 <sup>5</sup>	234-3090 <sup>5</sup>	234-4777 <sup>5</sup>	234-4700 <sup>5</sup>
L4-2.0	2012-2010	Exc. Calif.	234-9096	-	234-4380	-
L4-2.0	2012-2009	Calif.	234-9082	-	234-4380	-
L4-2.0	2009	Exc. Calif.	234-9039	-	234-4380	-
L4-2.0	2008		234-9039	-	234-4380	-
L4-2.0	2007		234-9070	-	234-4380	-
L4-2.0	2001-2000		234-3108	234-3090	234-4778	234-4700
L4-2.0	1999-1998		234-3089	234-3090	234-4323	-
L4-2.0	1994-1991		234-3302	-	-	-
L4-2.5	2012-2008		234-9039 <sup>1</sup>	-	234-4380 <sup>1</sup>	-
L4-2.5	2007		234-9070 <sup>1</sup>	-	234-4380 <sup>1</sup>	-
L4-2.5	2006-2005		234-5061	-	234-4301	234-4210
L4-2.5	2004	Auto Trans; Calif.	234-4296	-	234-4301	234-4210
L4-2.5	2004	Auto Trans; Exc. Calif.	234-5061	-	234-4301	234-4210
L4-2.5	2004	Manual Trans	234-4296	-	234-4301	234-4210
L4-2.5	2003-2002		234-4296	-	234-4309	234-4210
<b>STANZA</b>						
L4-2.0	1989		234-1011	234-1000	-	-
L4-2.0	1988-1987	Sedan	234-1011	234-1000	-	-
L4-2.0	1988-1987	Wagon	234-1013	234-1000	-	-
L4-2.0	1986	4WD	234-1011	234-1000	-	-
L4-2.0	1986	FWD	234-1013	234-1000	-	-
L4-2.0	1985-1984		234-1013	234-1000	-	-
L4-2.4	1992		234-1013	234-1000	-	-

<sup>1</sup> 2 Required / Requis 2 / Requeridos 2 <sup>4</sup> Left Side / Côté gauche / Lado izquierdo <sup>5</sup> Right Side / Côté droit / Lado derecho <sup>12</sup> Loc. Center / Empl. central / Ubicación central



ENGINE MOTEUR MOTOR	YEAR ANNEE AÑO	APPLICATION INFORMATION INFORMATION D'APPLICATION INFORMACION DE APLICACION	UPSTREAM / AVANT - C.C. / ANTES DEL C.C.		DOWNSTREAM / APRS - C.C. / DESPUES DEL C.C.	
			TYPE / TIPO O.E.	UNIVERS.	TYPE / TIPO O.E.	UNIVERS.
<b>NISSAN [cont]</b>						
<b>STANZA [cont]</b>						
L4-2.4	1991-1990		234-1011	234-1000	-	-
<b>TITAN</b>						
V8-5.6	2015-2013		234-9135 <sup>1</sup>	-	234-4835 <sup>1</sup>	-
V8-5.6	2012-2008		234-9038 <sup>1</sup>	-	234-4835 <sup>1</sup>	-
V8-5.6	2007		234-9072 <sup>1</sup>	-	234-4835 <sup>1</sup>	-
V8-5.6	2006-2004		234-5060 <sup>1</sup>	-	234-4835 <sup>1</sup>	-
<b>VAN</b>						
L4-2.4	1988-1987		234-1013	234-1000	-	-
<b>VERSA</b>						
L4-1.6	2015-2012		234-9127	-	234-4534	-
L4-1.6	2011-2009		234-9083	-	234-4380	-
L4-1.8	2012-2010		234-9096	-	234-4380	-
L4-1.8	2009-2008		234-9039	-	234-4380	-
L4-1.8	2007		234-9070	-	234-4380	-
<b>VERSA NOTE</b>						
L4-1.6	2015-2014		234-9127	-	234-4534	-
<b>XTERRA</b>						
L4-2.4	2004-2002		234-3113	234-3090	234-4323	-
L4-2.4	2001		234-3089	234-3090	234-4323	-
L4-2.4	2000	Calif.	234-3089	234-3090	234-4323	-
L4-2.4	2000	Exc. Calif.	234-3089	234-3090	234-4714	234-4700
V6-3.3	2004		234-3015 <sup>4</sup>	-	234-4198 <sup>4</sup>	-
V6-3.3	2004	Auto Trans	234-3006 <sup>5</sup>	-	234-4197 <sup>5</sup>	-
V6-3.3	2004	Manual Trans	234-3006 <sup>5</sup>	-	234-4198 <sup>5</sup>	-
V6-3.3	2003-2000		234-3098 <sup>4</sup>	234-3090 <sup>4</sup>	234-4703 <sup>4</sup>	234-4700 <sup>4</sup>
V6-3.3	2003-2000	Auto Trans	234-3089 <sup>5</sup>	234-3090 <sup>5</sup>	234-4704 <sup>5</sup>	234-4700 <sup>5</sup>
V6-3.3	2003-2000	Manual Trans	234-3089 <sup>5</sup>	234-3090 <sup>5</sup>	234-4703 <sup>5</sup>	234-4700 <sup>5</sup>
V6-4.0	2015		234-9148 <sup>1</sup>	-	234-4906 <sup>1</sup>	-
V6-4.0	2014-2013		234-9135 <sup>1</sup>	-	234-4906 <sup>1</sup>	-
V6-4.0	2012-2011		234-9036 <sup>4</sup>	-	234-4297 <sup>4</sup>	-
V6-4.0	2012-2011		234-9036 <sup>5</sup>	-	234-4313 <sup>5</sup>	-
V6-4.0	2010-2008		234-9038 <sup>4</sup>	-	234-4297 <sup>4</sup>	-
V6-4.0	2010-2008		234-9038 <sup>5</sup>	-	234-4313 <sup>5</sup>	-
V6-4.0	2007		234-9072 <sup>4</sup>	-	234-4297 <sup>4</sup>	-
V6-4.0	2007		234-9072 <sup>5</sup>	-	234-4313 <sup>5</sup>	-
V6-4.0	2006-2005		234-5060 <sup>4</sup>	-	234-4297 <sup>4</sup>	-
V6-4.0	2006-2005		234-5060 <sup>5</sup>	-	234-4313 <sup>5</sup>	-
<b>X-TRAIL</b>						
L4-2.5	2006-2005		234-4296	-	-	-

<sup>1</sup> 2 Required / Requis 2 / Requeridos 2 <sup>4</sup> Left Side / Côté gauche / Lado izquierdo <sup>5</sup> Right Side / Côté droit / Lado derecho



ENGINE MOTEUR MOTOR	YEAR ANNEE AÑO	APPLICATION INFORMATION INFORMATION D'APPLICATION INFORMACION DE APLICACION	UPSTREAM / AVANT - C.C. / ANTES DEL C.C.		DOWNSTREAM / APRS - C.C. / DESPUES DEL C.C.	
			TYPE / TIPO O.E.	UNIVERS.	TYPE / TIPO O.E.	UNIVERS.
<b>OLDSMOBILE</b>						
<b>88</b>						
V6-3.8	1999-1997		234-4018	234-4000	234-4087	234-4000
V6-3.8	1996		234-4012	234-4000	234-4087	234-4000
V6-3.8	1995-1994		234-4012	234-4000	-	-
V6-3.8	1993	1 Lead Sensor	234-1001	234-1000	-	-
V6-3.8	1993	3 Lead Sensor	234-3011	234-3000	-	-
V6-3.8	1992		234-1001	234-1000	-	-
<b>98</b>						
V6-3.0	1985		234-1001	234-1000	-	-
V6-3.8	1996		234-4012	234-4000	234-4087	234-4000
V6-3.8	1995-1994		234-4012	234-4000	-	-
V6-3.8	1993-1985	1 Lead Sensor	234-1001	234-1000	-	-
V6-3.8	1993	3 Lead Sensor	234-3011	234-3000	-	-
V6-4.1	1983-1982		234-1001	234-1000	-	-
V6-4.1	1981		234-2001	234-2000	-	-
V8-5.0	1984-1982		234-1001	234-1000	-	-
V8-5.0	1981-1980		234-2001	234-2000	-	-
V8-5.7	1980-1979		234-2001	234-2000	-	-
V8-6.6	1979		234-2001	234-2000	-	-
<b>ACHIEVA</b>						
L4-2.3	1995-1992		234-1001	234-1000	-	-
L4-2.4	1998-1996		234-1001	234-1000	234-4616	234-4000
V6-3.1	1998-1997		234-4018	234-4000	234-4616	234-4000
V6-3.1	1996		234-4012	234-4000	234-4616	234-4000
V6-3.1	1995-1994		234-4012	234-4000	-	-
V6-3.3	1993-1992		234-1001	234-1000	-	-
<b>ALERO</b>						
L4-2.2	2004-2002		234-4646	234-4209	234-4104	234-4209
L4-2.4	2001-2000		234-2060	234-2000	234-4617	234-4000
L4-2.4	1999		234-1023	234-1000	234-4617	234-4000
V6-3.4	2004-2001		234-4650	234-4209	234-4617	234-4000
V6-3.4	2000-1999		234-4018	234-4000	234-4617	234-4000
<b>AURORA</b>						
V6-3.5	2002-2001		234-4650 <sup>1</sup>	234-4209 <sup>1</sup>	234-4647	234-4209
V8-4.0	2003-2001		234-4650 <sup>1</sup>	234-4209 <sup>1</sup>	234-4647	234-4209
V8-4.0	1999-1996		234-4018 <sup>1</sup>	234-4000 <sup>1</sup>	234-4087	234-4000
V8-4.0	1995		234-4006 <sup>1</sup>	234-4000 <sup>1</sup>	-	-
<b>BRAVADA</b>						
L6-4.2	2004		234-4119	-	234-4285	-
L6-4.2	2003-2002		234-4112	234-4209	234-4285	-
V6-4.3	2001-1998		234-4012 <sup>1</sup>	234-4000 <sup>1</sup>	234-4012	234-4000

<sup>1</sup> 2 Required / Requis 2 / Requeridos 2



ENGINE MOTEUR MOTOR	YEAR ANNEE AÑO	APPLICATION INFORMATION INFORMATION D'APPLICATION INFORMACION DE APLICACION	UPSTREAM / AVANT - C.C. / ANTES DEL C.C.		DOWNSTREAM / APRES - C.C. / DESPUES DEL C.C.	
			TYPE / TIPO O.E.	UNIVERS.	TYPE / TIPO O.E.	UNIVERS.
<b>OLDSMOBILE [cont]</b>						
<b>BRAVADA [cont]</b>						
V6-4.3	1997-1996	Upstream Sensor in Manifold	234-4012 <sup>1</sup>	234-4000 <sup>1</sup>	234-4012	234-4000
V6-4.3	1997-1996	Upstream Sensor in Y Pipe	234-4012	234-4000	-	-
V6-4.3	1994		234-3005	234-3000	-	-
V6-4.3	1993-1992		234-3094	234-3090	-	-
V6-4.3	1991		234-1001	234-1000	-	-
<b>CALAIS</b>						
L4-2.3	1987		234-1001	234-1000	-	-
L4-2.5	1987-1985		234-1001	234-1000	-	-
V6-3.0	1987-1985		234-1001	234-1000	-	-
<b>CUSTOM CRUISER</b>						
V8-5.0	1992-1982		234-1001	234-1000	-	-
V8-5.0	1981-1980		234-2001	234-2000	-	-
V8-5.7	1992		234-1001	234-1000	-	-
V8-5.7	1980-1979		234-2001	234-2000	-	-
V8-6.6	1979		234-2001	234-2000	-	-
<b>CUTLASS</b>						
V6-3.1	1999		234-4018 <sup>1</sup>	234-4000 <sup>1</sup>	234-4617	234-4000
V6-3.1	1998		234-4018	234-4000	234-4616	234-4000
V6-3.1	1997		234-4018	234-4000	234-4617	234-4000
V6-3.8	1981-1979		234-2001	234-2000	-	-
V8-4.3	1981-1979		234-2001	234-2000	-	-
V8-4.4	1981		234-2001	234-2000	-	-
V8-5.0	1987-1985		234-1001	234-1000	-	-
V8-5.0	1980-1979		234-2001	234-2000	-	-
V8-5.7	1980-1979		234-2001	234-2000	-	-
<b>CUTLASS CALAIS</b>						
L4-2.3	1991-1988		234-1001	234-1000	-	-
L4-2.5	1991-1988		234-1001	234-1000	-	-
V6-3.0	1988		234-1001	234-1000	-	-
V6-3.3	1991-1989		234-1001	234-1000	-	-
V6-3.8	1984-1982		234-1001	234-1000	-	-
V6-3.8	1981-1979		234-2001	234-2000	-	-
V6-4.3	1982		234-1001	234-1000	-	-
V8-4.3	1982		234-1001	234-1000	-	-
V8-4.3	1981-1979		234-2001	234-2000	-	-
V8-4.4	1982		234-1001	234-1000	-	-
V8-5.0	1984-1982		234-1001	234-1000	-	-
V8-5.0	1980-1979		234-2001	234-2000	-	-
V8-5.7	1980-1979		234-2001	234-2000	-	-
<b>CUTLASS CIERA</b>						
L4-2.2	1996		234-1001	234-1000	234-4087	234-4000

<sup>1</sup> 2 Required / Requis 2 / Requeridos 2



ENGINE MOTEUR MOTOR	YEAR ANNEE AÑO	APPLICATION INFORMATION INFORMATION D'APPLICATION INFORMACION DE APLICACION	UPSTREAM / AVANT - C.C. / ANTES DEL C.C.		DOWNSTREAM / APRS - C.C. / DESPUES DEL C.C.	
			TYPE / TIPO O.E.	UNIVERS.	TYPE / TIPO O.E.	UNIVERS.
<b>OLDSMOBILE [cont]</b>						
<b>CUTLASS CIERA [cont]</b>						
L4-2.2	1995-1993		234-1001	234-1000	-	-
L4-2.5	1992-1982		234-1001	234-1000	-	-
V6-2.8	1989-1982		234-1001	234-1000	-	-
V6-3.0	1985-1982		234-1001	234-1000	-	-
V6-3.1	1996		234-4012	234-4000	234-4087	234-4000
V6-3.1	1995-1994		234-4012	234-4000	-	-
V6-3.3	1993-1989		234-1001	234-1000	-	-
V6-3.8	1990-1984		234-1001	234-1000	-	-
<b>CUTLASS CRUISER</b>						
L4-2.5	1992-1987		234-1001	234-1000	-	-
V6-2.8	1989-1987		234-1001	234-1000	-	-
V6-3.1	1994		234-4012	234-4000	-	-
V6-3.3	1993-1989		234-1001	234-1000	-	-
V6-3.8	1988-1987		234-1001	234-1000	-	-
V6-3.8	1983-1982		234-1001	234-1000	-	-
V6-3.8	1981-1980		234-2001	234-2000	-	-
V8-4.3	1982		234-1001	234-1000	-	-
V8-4.3	1981-1980		234-2001	234-2000	-	-
V8-4.4	1982		234-1001	234-1000	-	-
V8-5.0	1983-1982		234-1001	234-1000	-	-
V8-5.0	1981-1980		234-2001	234-2000	-	-
V8-5.7	1980		234-2001	234-2000	-	-
<b>CUTLASS SALON</b>						
V6-3.8	1987-1985		234-1001	234-1000	-	-
V6-3.8	1980-1979		234-2001	234-2000	-	-
V8-4.3	1980-1979		234-2001	234-2000	-	-
V8-5.0	1987-1985		234-1001	234-1000	-	-
V8-5.0	1980-1979		234-2001	234-2000	-	-
V8-5.7	1979		234-2001	234-2000	-	-
<b>CUTLASS SUPREME</b>						
L4-2.3	1991-1990		234-1001	234-1000	-	-
V6-2.8	1989-1988		234-1001	234-1000	-	-
V6-3.1	1997		234-4018 <sup>1</sup>	234-4000 <sup>1</sup>	234-4087	234-4000
V6-3.1	1996		234-4012 <sup>1</sup>	234-4000 <sup>1</sup>	234-4087	234-4000
V6-3.1	1995-1994		234-4012	234-4000	-	-
V6-3.1	1993	VIN M	234-4012	234-4000	-	-
V6-3.1	1993	VIN T; Calif.	234-3094	234-3090	-	-
V6-3.1	1993	VIN T; Exc. Calif,	234-1001	234-1000	-	-
V6-3.1	1992-1989		234-1001	234-1000	-	-
V6-3.4	1996		234-4012	234-4000	234-4087	234-4000
V6-3.4	1995-1993		234-4012	234-4000	-	-

<sup>1</sup> 2 Required / Requis 2 / Requeridos 2



ENGINE MOTEUR MOTOR	YEAR ANNEE AÑO	APPLICATION INFORMATION INFORMATION D'APPLICATION INFORMACION DE APLICACION	UPSTREAM / AVANT - C.C. / ANTES DEL C.C.		DOWNSTREAM / APRS - C.C. / DESPUES DEL C.C.	
			TYPE / TIPO O.E.	UNIVERS.	TYPE / TIPO O.E.	UNIVERS.
<b>OLDSMOBILE [cont]</b>						
<b>CUTLASS SUPREME [cont]</b>						
V6-3.4	1992-1991		234-1001	234-1000	-	-
V6-3.8	1987-1982		234-1001	234-1000	-	-
V6-3.8	1981-1979		234-2001	234-2000	-	-
V6-4.3	1982		234-1001	234-1000	-	-
V8-4.3	1982		234-1001	234-1000	-	-
V8-4.3	1981-1979		234-2001	234-2000	-	-
V8-4.4	1982		234-1001	234-1000	-	-
V8-5.0	1988-1982		234-1001	234-1000	-	-
V8-5.0	1980-1979		234-2001	234-2000	-	-
V8-5.7	1980-1979		234-2001	234-2000	-	-
<b>DELTA 88</b>						
V6-3.0	1986		234-1001	234-1000	-	-
V6-3.8	1991-1982		234-1001	234-1000	-	-
V6-3.8	1981-1979		234-2001	234-2000	-	-
V8-4.3	1982		234-1001	234-1000	-	-
V8-4.3	1981-1979		234-2001	234-2000	-	-
V8-4.4	1982		234-1001	234-1000	-	-
V8-4.4	1981		234-2001	234-2000	-	-
V8-4.9	1979		234-2001	234-2000	-	-
V8-5.0	1985-1982		234-1001	234-1000	-	-
V8-5.0	1981-1980		234-2001	234-2000	-	-
V8-5.7	1980-1979		234-2001	234-2000	-	-
V8-6.6	1979		234-2001	234-2000	-	-
<b>FIRENZA</b>						
L4-1.8	1986-1983		234-1001	234-1000	-	-
L4-1.8	1982	Carbureted	234-1001	234-1000	-	-
L4-1.8	1982	Fuel Injected	234-2001	234-2000	-	-
L4-2.0	1988-1983		234-1001	234-1000	-	-
V6-2.8	1987-1985		234-1001	234-1000	-	-
<b>INTRIGUE</b>						
V6-3.5	2002-2000		234-4650	234-4209	234-4647	234-4209
V6-3.5	1999		234-4018	234-4000	234-4087	234-4000
V6-3.8	1999-1998		234-4018	234-4000	234-4087	234-4000
<b>LSS</b>						
V6-3.8	1999-1997		234-4018	234-4000	234-4087	234-4000
V6-3.8	1996		234-4012	234-4000	234-4087	234-4000
<b>OMEGA</b>						
L4-2.5	1984-1982		234-1001	234-1000	-	-
L4-2.5	1981-1980		234-2001	234-2000	-	-
V6-2.8	1984-1982		234-1001	234-1000	-	-
V6-2.8	1981-1980		234-2001	234-2000	-	-



ENGINE MOTEUR MOTOR	YEAR ANNEE AÑO	APPLICATION INFORMATION INFORMATION D'APPLICATION INFORMACION DE APLICACION	UPSTREAM / AVANT - C.C. / ANTES DEL C.C.		DOWNSTREAM / APRS - C.C. / DESPUES DEL C.C.	
			TYPE / TIPO O.E.	UNIVERS.	TYPE / TIPO O.E.	UNIVERS.
<b>OLDSMOBILE [cont]</b>						
<b>OMEGA [cont]</b>						
V6-3.8	1979		234-2001	234-2000	-	-
V8-5.0	1979		234-2001	234-2000	-	-
V8-5.7	1979		234-2001	234-2000	-	-
<b>REGENCY</b>						
V6-3.8	1998-1997		234-4018	234-4000	234-4087	234-4000
<b>SILHOUETTE</b>						
V6-3.1	1994-1990		234-1001	234-1000	-	-
V6-3.4	2004-2001		234-4650	234-4209	234-4087	234-4000
V6-3.4	2000-1997		234-4018	234-4000	234-4087	234-4000
V6-3.4	1996		234-4012	234-4000	234-4087	234-4000
V6-3.8	1995-1994		234-4012	234-4000	-	-
V6-3.8	1993		234-3011	234-3000	-	-
V6-3.8	1992		234-1001	234-1000	-	-
<b>STARFIRE</b>						
L4-2.5	1980-1979		234-2001	234-2000	-	-
V6-3.8	1980-1979		234-2001	234-2000	-	-
V8-5.0	1979		234-2001	234-2000	-	-
<b>TORONADO</b>						
V6-3.8	1992-1986		234-1001	234-1000	-	-
V6-4.1	1984-1982		234-1001	234-1000	-	-
V6-4.1	1981		234-2001	234-2000	-	-
V8-5.0	1985-1982		234-1001	234-1000	-	-
V8-5.0	1981-1980		234-2001	234-2000	-	-
V8-5.7	1980-1979		234-2001	234-2000	-	-
<b>PLYMOUTH</b>						
<b>ACCLAIM</b>						
L4-2.5	1995-1989		234-4004	234-4210	-	-
V6-3.0	1995-1989		234-4004	234-4210	-	-
<b>ARROW</b>						
L4-1.6	1980		234-1002	234-1000	-	-
L4-2.6	1980		234-1002	234-1000	-	-
<b>ARROW PICKUP</b>						
L4-2.0	1982-1980		234-1002	234-1000	-	-
L4-2.6	1982-1980		234-1002	234-1000	-	-
<b>BREEZE</b>						
L4-2.0	2000-1998		234-4078	234-4210	234-4079	234-4210
L4-2.0	1997		234-4077	234-4210	234-4002	234-4210
L4-2.0	1996		234-4004	234-4210	234-4002	234-4210
L4-2.4	2000-1998		234-4078	234-4210	234-4079	234-4210
L4-2.4	1997		234-4077	234-4210	234-4002	234-4210



ENGINE MOTEUR MOTOR	YEAR ANNEE AÑO	APPLICATION INFORMATION INFORMATION D'APPLICATION INFORMACION DE APLICACION	UPSTREAM / AVANT - C.C. / ANTES DEL C.C.		DOWNSTREAM / APRS - C.C. / DESPUES DEL C.C.	
			TYPE / TIPO O.E.	UNIVERS.	TYPE / TIPO O.E.	UNIVERS.
<b>PLYMOUTH [cont]</b>						
<b>BREEZE [cont]</b>						
L4-2.4	1996		234-4004	234-4210	234-4002	234-4210
<b>CARAVELLE</b>						
L4-2.2	1988		234-3003	234-3000	-	-
L4-2.2	1987	Carbureted	234-1002	234-1000	-	-
L4-2.2	1987	Fuel Injected	234-3003	234-3000	-	-
L4-2.2	1986-1983		234-1002	234-1000	-	-
L4-2.5	1988-1987		234-3003	234-3000	-	-
L4-2.5	1986		234-1002	234-1000	-	-
L4-2.6	1985-1984		234-1005	234-1000	-	-
L4-2.6	1983		234-1002	234-1000	-	-
L6-3.7	1983-1979		234-1002	234-1000	-	-
V8-5.2	1989-1980		234-1002	234-1000	-	-
<b>CHAMP</b>						
L4-1.4	1982-1980		234-1002	234-1000	-	-
L4-1.6	1982-1980		234-1002	234-1000	-	-
<b>COLT</b>						
L4-1.4	1984		234-1005	234-1000	-	-
L4-1.4	1983-1980		234-1002	234-1000	-	-
L4-1.5	1995		234-4020 <sup>15</sup>	234-4210 <sup>15</sup>	234-4081	234-4210
L4-1.5	1995		234-4032 <sup>16</sup>	234-4210 <sup>16</sup>	-	-
L4-1.5	1994-1993	Calif.	234-4020	234-4210	234-4081	234-4210
L4-1.5	1994-1993	Exc. Calif.	234-2066	234-2000	-	-
L4-1.5	1992		234-2066	234-2000	-	-
L4-1.5	1991	Auto Trans	234-2066	234-2000	-	-
L4-1.5	1991	Manual Trans	234-2002	234-2000	-	-
L4-1.5	1990-1989	2 Lead Sensor	234-2002	234-2000	-	-
L4-1.5	1990-1987	1 Lead Sensor	234-1007	234-1000	-	-
L4-1.5	1986-1985		234-1005	234-1000	-	-
L4-1.6	1990-1989	VIN F	234-1007	234-1000	-	-
L4-1.6	1990-1989	VIN Y; Calif.	234-2002	234-2000	-	-
L4-1.6	1990-1989	VIN Y; Exc. Calif.	234-1007	234-1000	-	-
L4-1.6	1989	VIN Z	234-4643	234-4209	-	-
L4-1.6	1988-1987		234-1007	234-1000	-	-
L4-1.6	1986-1984		234-1005	234-1000	-	-
L4-1.6	1983-1980		234-1002	234-1000	-	-
L4-1.8	1994-1993	Calif.	234-4641	234-4209	234-4638	234-4209
L4-1.8	1994-1993	Exc. Calif.	234-2014	234-2000	-	-
L4-1.8	1992		234-2014	234-2000	-	-
L4-1.8	1990-1989		234-1007	234-1000	-	-
L4-2.0	1991-1989	Calif.	234-2002	234-2000	-	-
L4-2.0	1991-1989	Exc. Calif.	234-1021	234-1000	-	-

<sup>15</sup> Front / Avant / Parte delantera <sup>16</sup> Rear / Arrière / Parte trasera





ENGINE MOTEUR MOTOR	YEAR ANNEE AÑO	APPLICATION INFORMATION INFORMATION D'APPLICATION INFORMACION DE APLICACION	UPSTREAM / AVANT - C.C. / ANTES DEL C.C.		DOWNSTREAM / APRS - C.C. / DESPUES DEL C.C.	
			TYPE / TIPO O.E.	UNIVERS.	TYPE / TIPO O.E.	UNIVERS.
<b>PLYMOUTH [cont]</b>						
<b>COLT [cont]</b>						
L4-2.0	1988		234-1007	234-1000	-	-
L4-2.0	1987	From 10/86	234-1007	234-1000	-	-
L4-2.0	1987	To 10/86	234-1005	234-1000	-	-
L4-2.0	1986-1984		234-1005	234-1000	-	-
L4-2.4	1994		234-4638	234-4209	234-4017	234-4209
L4-2.4	1993	Calif.; AWD	234-4638	234-4209	234-4017	234-4209
L4-2.4	1993	Calif.; FWD	234-4638	234-4209	234-4027	234-4210
L4-2.4	1993	Exc. Calif.	234-2014	234-2000	-	-
L4-2.4	1992		234-2014	234-2000	-	-
L4-2.6	1980		234-1002	234-1000	-	-
<b>CONQUEST</b>						
L4-2.6	1986-1984		234-1052	234-1057	-	-
<b>EXPO</b>						
L4-2.2	1989		234-4004	234-4210	-	-
L4-2.2	1988		234-3003	234-3000	-	-
L4-2.2	1987		234-1002	234-1000	-	-
<b>GRAND VOYAGER</b>						
L4-2.4	1997		234-4005	234-4210	234-4021	234-4210
L4-2.4	1996		234-4077	234-4210	234-4076	234-4210
L4-2.5	1988-1987		234-3003	234-3000	-	-
V6-3.0	2000	Exc. TLEV	234-4077	234-4210	234-4021	234-4210
V6-3.0	2000	TLEV	234-4077	234-4210	234-4082	234-4210
V6-3.0	1999		234-4077	234-4210	234-4021	234-4210
V6-3.0	1998-1996	Exc. TLEV	234-4077	234-4210	234-4021	234-4210
V6-3.0	1998-1996	TLEV	234-4077	234-4210	234-4082	234-4210
V6-3.0	1995		234-4077	234-4210	-	-
V6-3.0	1994-1992		234-4004	234-4210	-	-
V6-3.0	1989		234-4004	234-4210	-	-
V6-3.0	1988-1987		234-3003	234-3000	-	-
V6-3.3	2000-1996	Exc. TLEV	234-4077	234-4210	234-4021	234-4210
V6-3.3	2000-1996	TLEV	234-4077	234-4210	234-4082	234-4210
V6-3.3	1995		234-4077	234-4210	-	-
V6-3.3	1994-1990		234-4004	234-4210	-	-
V6-3.8	1999-1996	Exc. TLEV	234-4077	234-4210	234-4021	234-4210
V6-3.8	1999-1996	TLEV	234-4077	234-4210	234-4082	234-4210
V6-3.8	1995		234-4077	234-4210	-	-
V6-3.8	1994		234-4004	234-4210	-	-
<b>GRAN FURY</b>						
L6-3.7	1983-1980		234-1002	234-1000	-	-
V8-5.2	1989-1980		234-1002	234-1000	-	-
V8-5.9	1980		234-1002	234-1000	-	-



ENGINE MOTEUR MOTOR	YEAR ANNEE AÑO	APPLICATION INFORMATION INFORMATION D'APPLICATION INFORMACION DE APLICACION	UPSTREAM / AVANT - C.C. / ANTES DEL C.C.		DOWNSTREAM / APRES - C.C. / DESPUES DEL C.C.	
			TYPE / TIPO O.E.	UNIVERS.	TYPE / TIPO O.E.	UNIVERS.
<b>PLYMOUTH [cont]</b>						
<b>HORIZON</b>						
L4-1.6	1986-1983		234-1002	234-1000	-	-
L4-1.7	1983-1980		234-1002	234-1000	-	-
L4-2.2	1990-1989		234-4004	234-4210	-	-
L4-2.2	1988		234-3003	234-3000	-	-
L4-2.2	1987-1981		234-1002	234-1000	-	-
<b>LASER</b>						
L4-1.8	1994-1991		234-2002	234-2000	-	-
L4-1.8	1990	Calif.	234-2002	234-2000	-	-
L4-1.8	1990	Exc. Calif.	234-1007	234-1000	-	-
L4-2.0	1994-1991	Turbo	234-4007	234-4210	-	-
L4-2.0	1994-1990	Non-Turbo	234-4644	234-4209	-	-
L4-2.0	1990	Turbo	234-4643	234-4209	-	-
<b>NEON</b>						
L4-2.0	2001	Calif.	234-4882	-	234-4078	234-4210
L4-2.0	2001	Exc. Calif.	234-4882	-	234-4008	234-4210
L4-2.0	2000	Exc. ULEV	234-4115	-	234-4614	234-4210
L4-2.0	2000	ULEV	234-4882	-	234-4078	234-4210
L4-2.0	1999-1997		234-4077	234-4210	234-4614	234-4210
L4-2.0	1996-1995		234-4004	234-4210	234-4013	234-4210
<b>PB100</b>						
L6-3.7	1980-1979		234-1002	234-1000	-	-
V8-5.2	1980		234-1002	234-1000	-	-
<b>PB150</b>						
L6-3.7	1983-1981		234-1002	234-1000	-	-
V8-5.2	1983		234-1002	234-1000	-	-
V8-5.2	1981		234-1002	234-1000	-	-
<b>PB200</b>						
L6-3.7	1980		234-1002	234-1000	-	-
V8-5.2	1980		234-1002	234-1000	-	-
V8-5.9	1980		234-1002	234-1000	-	-
<b>PB250</b>						
L6-3.7	1983-1981		234-1002	234-1000	-	-
V8-5.2	1983-1981		234-1002	234-1000	-	-
V8-5.9	1981		234-1002	234-1000	-	-
<b>PB300</b>						
V8-5.2	1980		234-1002	234-1000	-	-
V8-5.9	1980		234-1002	234-1000	-	-
<b>PB350</b>						
V8-5.2	1983-1981		234-1002	234-1000	-	-
V8-5.9	1983-1981		234-1002	234-1000	-	-



ENGINE MOTEUR MOTOR	YEAR ANNEE AÑO	APPLICATION INFORMATION INFORMATION D'APPLICATION INFORMACION DE APLICACION	UPSTREAM / AVANT - C.C. / ANTES DEL C.C.		DOWNSTREAM / APRS - C.C. / DESPUES DEL C.C.	
			TYPE / TIPO O.E.	UNIVERS.	TYPE / TIPO O.E.	UNIVERS.
<b>PLYMOUTH [cont]</b>						
<b>PROWLER</b>						
V6-3.5	2001-2000		234-4078 <sup>1</sup>	234-4210 <sup>1</sup>	234-4078 <sup>1</sup>	234-4210 <sup>1</sup>
V6-3.5	1999		234-4077 <sup>1</sup>	234-4210 <sup>1</sup>	234-4078 <sup>1</sup>	234-4210 <sup>1</sup>
V6-3.5	1997		234-4077 <sup>1</sup>	234-4210 <sup>1</sup>	234-4078 <sup>1</sup>	234-4210 <sup>1</sup>
<b>RELIANT</b>						
L4-2.2	1989		234-4004	234-4210	-	-
L4-2.2	1988-1987		234-3003	234-3000	-	-
L4-2.2	1986-1981		234-1002	234-1000	-	-
L4-2.5	1989		234-4004	234-4210	-	-
L4-2.5	1988-1987		234-3003	234-3000	-	-
L4-2.5	1986		234-1002	234-1000	-	-
L4-2.6	1985-1984		234-1005	234-1000	-	-
L4-2.6	1983-1981		234-1002	234-1000	-	-
<b>SAPORO</b>						
L4-2.6	1983-1980		234-1002	234-1000	-	-
<b>SCAMP</b>						
L4-2.2	1983		234-1002	234-1000	-	-
<b>SUNDANCE</b>						
L4-2.2	1994-1989		234-4004	234-4210	-	-
L4-2.2	1988-1987		234-3003	234-3000	-	-
L4-2.5	1994-1989		234-4004	234-4210	-	-
L4-2.5	1988		234-3003	234-3000	-	-
V6-3.0	1994-1992		234-4004	234-4210	-	-
<b>TC3</b>						
L4-1.7	1982-1980		234-1002	234-1000	-	-
L4-2.2	1982-1981		234-1002	234-1000	-	-
<b>TRAILDUSTER</b>						
L6-3.7	1980-1979		234-1002	234-1000	-	-
V8-5.2	1981-1980		234-1002	234-1000	-	-
V8-5.9	1981-1980		234-1002	234-1000	-	-
<b>TURISMO</b>						
L4-1.6	1986-1983		234-1002	234-1000	-	-
L4-1.7	1983		234-1002	234-1000	-	-
L4-2.2	1987-1983		234-1002	234-1000	-	-
<b>TURISMO 2.2</b>						
L4-2.2	1986-1983		234-1002	234-1000	-	-
<b>VOLARE</b>						
L6-3.7	1980-1979		234-1002	234-1000	-	-
V8-5.2	1980		234-1002	234-1000	-	-
V8-5.9	1980		234-1002	234-1000	-	-

<sup>1</sup> 2 Required / Requis 2 / Requeridos 2



ENGINE MOTEUR MOTOR	YEAR ANNEE AÑO	APPLICATION INFORMATION INFORMATION D'APPLICATION INFORMACION DE APLICACION	UPSTREAM / AVANT - C.C. / ANTES DEL C.C.		DOWNSTREAM / APRS - C.C. / DESPUES DEL C.C.	
			TYPE / TIPO O.E.	UNIVERS.	TYPE / TIPO O.E.	UNIVERS.
<b>PLYMOUTH [cont]</b>						
<b>VOYAGER</b>						
L4-2.2	1987-1984		234-1002	234-1000	-	-
L4-2.4	2000-1999	Exc. TLEV	234-4005	234-4210	234-4021	234-4210
L4-2.4	2000-1999	TLEV	234-4005	234-4210	234-4082	234-4210
L4-2.4	1998		234-4002	234-4210	234-4021	234-4210
L4-2.4	1997		234-4005	234-4210	234-4021	234-4210
L4-2.4	1996		234-4077	234-4210	234-4076	234-4210
L4-2.5	1995-1989		234-4004	234-4210	-	-
L4-2.5	1988-1987		234-3003	234-3000	-	-
L4-2.6	1987-1984		234-1005	234-1000	-	-
V6-3.0	2000	Exc. TLEV	234-4077	234-4210	234-4021	234-4210
V6-3.0	2000	TLEV	234-4077	234-4210	234-4082	234-4210
V6-3.0	1999		234-4077	234-4210	234-4021	234-4210
V6-3.0	1998-1996	Exc. TLEV	234-4077	234-4210	234-4021	234-4210
V6-3.0	1998-1996	TLEV	234-4077	234-4210	234-4082	234-4210
V6-3.0	1995		234-4077	234-4210	-	-
V6-3.0	1994-1989		234-4004	234-4210	-	-
V6-3.0	1988-1987		234-3003	234-3000	-	-
V6-3.3	2000-1996	Exc. TLEV	234-4077	234-4210	234-4021	234-4210
V6-3.3	2000-1996	TLEV	234-4077	234-4210	234-4082	234-4210
V6-3.3	1995		234-4077	234-4210	-	-
V6-3.3	1994-1991		234-4004	234-4210	-	-
V6-3.8	1999-1997	Exc. TLEV	234-4077	234-4210	234-4021	234-4210
V6-3.8	1999-1997	TLEV	234-4077	234-4210	234-4082	234-4210
<b>PONTIAC</b>						
<b>6000</b>						
L4-2.5	1991-1982		234-1001	234-1000	-	-
V6-2.8	1989-1982		234-1001	234-1000	-	-
V6-3.1	1991-1988		234-1001	234-1000	-	-
<b>ACADIAN</b>						
L4-1.6	1987-1982		234-1001	234-1000	-	-
L4-1.6	1981-1980	1 Lead Sensor	234-1001	234-1000	-	-
L4-1.6	1981-1980	2 Lead Sensor	234-2001	234-2000	-	-
<b>AZTEK</b>						
V6-3.4	2005		234-4343	-	234-4647	234-4209
V6-3.4	2004-2001		234-4650	234-4209	234-4087	234-4000
<b>BONNEVILLE</b>						
V6-3.8	2005-2004		234-4646 <sup>1</sup>	234-4209 <sup>1</sup>	234-4647 <sup>1</sup>	234-4209 <sup>1</sup>
V6-3.8	2003-1997		234-4018	234-4000	234-4087	234-4000
V6-3.8	1996		234-4012	234-4000	234-4087	234-4000

<sup>1</sup> 2 Required / Requis 2 / Requeridos 2



ENGINE MOTEUR MOTOR	YEAR ANNEE AÑO	APPLICATION INFORMATION INFORMATION D'APPLICATION INFORMACION DE APLICACION	UPSTREAM / AVANT - C.C. / ANTES DEL C.C.		DOWNSTREAM / APRES - C.C. / DESPUES DEL C.C.	
			TYPE / TIPO O.E.	UNIVERS.	TYPE / TIPO O.E.	UNIVERS.
<b>PONTIAC [cont]</b>						
<b>BONNEVILLE [cont]</b>						
V6-3.8	1995-1994		234-4012	234-4000	-	-
V6-3.8	1993-1980	1 Lead Sensor	234-1001	234-1000	-	-
V6-3.8	1993	3 Lead Sensor	234-3011	234-3000	-	-
V6-3.8	1981-1980	2 Lead Sensor	234-2001	234-2000	-	-
V6-4.1	1982		234-1001	234-1000	-	-
V6-4.3	1986		234-1001	234-1000	-	-
V8-4.3	1981-1980	1 Lead Sensor	234-1001	234-1000	-	-
V8-4.3	1981-1980	2 Lead Sensor	234-2001	234-2000	-	-
V8-4.6	2005-2004		234-4668 <sup>1</sup>	234-4212 <sup>1</sup>	234-4346 <sup>1</sup>	-
V8-4.9	1980-1979	2 Lead Sensor	234-2001	234-2000	-	-
V8-4.9	1980	1 Lead Sensor	234-1001	234-1000	-	-
V8-5.0	1986-1983		234-1001	234-1000	-	-
V8-5.0	1981	1 Lead Sensor	234-1001	234-1000	-	-
V8-5.0	1981	2 Lead Sensor	234-2001	234-2000	-	-
V8-5.7	1980-1979	2 Lead Sensor	234-2001	234-2000	-	-
V8-5.7	1980	1 Lead Sensor	234-1001	234-1000	-	-
V8-6.6	1979		234-2001	234-2000	-	-
<b>CATALINA</b>						
L6-4.1	1979		234-2001	234-2000	-	-
V6-3.8	1981-1980	1 Lead Sensor	234-1001	234-1000	-	-
V6-3.8	1981-1979	2 Lead Sensor	234-2001	234-2000	-	-
V8-4.3	1981-1980	1 Lead Sensor	234-1001	234-1000	-	-
V8-4.3	1981-1980	2 Lead Sensor	234-2001	234-2000	-	-
V8-4.4	1981-1980	1 Lead Sensor	234-1001	234-1000	-	-
V8-4.4	1981-1980	2 Lead Sensor	234-2001	234-2000	-	-
V8-4.9	1980-1979	2 Lead Sensor	234-2001	234-2000	-	-
V8-4.9	1980	1 Lead Sensor	234-1001	234-1000	-	-
V8-5.0	1981-1980	1 Lead Sensor	234-1001	234-1000	-	-
V8-5.0	1981-1980	2 Lead Sensor	234-2001	234-2000	-	-
V8-5.7	1980-1979	2 Lead Sensor	234-2001	234-2000	-	-
V8-5.7	1980	1 Lead Sensor	234-1001	234-1000	-	-
V8-6.6	1979		234-2001	234-2000	-	-
<b>FIERO</b>						
L4-2.5	1988-1984		234-1001	234-1000	-	-
V6-2.8	1988-1985		234-1001	234-1000	-	-
<b>FIREBIRD</b>						
L4-2.5	1986-1982		234-1001	234-1000	-	-
V6-2.8	1989-1982		234-1001	234-1000	-	-
V6-3.1	1992-1990		234-1001	234-1000	-	-
V6-3.4	1995-1993		234-1001 <sup>1</sup>	234-1000 <sup>1</sup>	-	-
V6-3.8	2002-2001	Upstream Sensor in Manifold	234-4018 <sup>1</sup>	234-4000 <sup>1</sup>	234-4087	234-4000

<sup>1</sup> 2 Required / Requis 2 / Requeridos 2 <sup>17</sup> Location Exhaust Pipe / Empl. tuyau d'éch / Ubicación tubo de escape



ENGINE MOTEUR MOTOR	YEAR ANNEE AÑO	APPLICATION INFORMATION INFORMATION D'APPLICATION INFORMACION DE APLICACION	UPSTREAM / AVANT - C.C. / ANTES DEL C.C.		DOWNSTREAM / APRS - C.C. / DESPUES DEL C.C.	
			TYPE / TIPO O.E.	UNIVERS.	TYPE / TIPO O.E.	UNIVERS.
<b>PONTIAC [cont]</b>						
<b>FIREBIRD [cont]</b>						
V6-3.8	2002-1996	Upstream Sensor in Exhaust Pipe	234-4087 <sup>17</sup>	234-4000 <sup>17</sup>	-	-
V6-3.8	2000-1998	2 Lead Upstream Sensor in Manifold	234-2013 <sup>1</sup>	234-2000 <sup>1</sup>	234-4087	234-4000
V6-3.8	2000-1998	4 Lead Upstream Sensor in Manifold	234-4018 <sup>1</sup>	234-4000 <sup>1</sup>	234-4087	234-4000
V6-3.8	1997	Upstream Sensor in Manifold	234-4018 <sup>1</sup>	234-4000 <sup>1</sup>	234-4087	234-4000
V6-3.8	1996	Upstream Sensor in Manifold	234-4012 <sup>1</sup>	234-4000 <sup>1</sup>	234-4087	234-4000
V6-3.8	1995		234-4012 <sup>1</sup>	234-4000 <sup>1</sup>	234-4012 <sup>1</sup>	234-4000 <sup>1</sup>
V6-3.8	1989		234-1001	234-1000	-	-
V6-3.8	1981-1980	1 Lead Sensor	234-1001	234-1000	-	-
V6-3.8	1981-1979	2 Lead Sensor	234-2001	234-2000	-	-
V8-4.3	1981-1980	1 Lead Sensor	234-1001	234-1000	-	-
V8-4.3	1981-1980	2 Lead Sensor	234-2001	234-2000	-	-
V8-4.4	1981	1 Lead Sensor	234-1001	234-1000	-	-
V8-4.4	1981	2 Lead Sensor	234-2001	234-2000	-	-
V8-4.9	1981-1980	1 Lead Sensor	234-1001	234-1000	-	-
V8-4.9	1981-1979	2 Lead Sensor	234-2001	234-2000	-	-
V8-5.0	1992-1980	1 Lead Sensor	234-1001	234-1000	-	-
V8-5.0	1981-1979	2 Lead Sensor	234-2001	234-2000	-	-
V8-5.7	2002-2000		234-4087 <sup>5</sup>	234-4000 <sup>5</sup>	234-4025 <sup>5</sup>	234-4000 <sup>5</sup>
V8-5.7	2002-1998		234-4025 <sup>4</sup>	234-4000 <sup>4</sup>	234-4025 <sup>4</sup>	234-4000 <sup>4</sup>
V8-5.7	1999-1998		234-4087 <sup>5</sup>	234-4000 <sup>5</sup>	234-4087 <sup>5</sup>	234-4000 <sup>5</sup>
V8-5.7	1997-1996	Upstream Sensor in Exhaust Pipe	234-4087 <sup>17</sup>	234-4000 <sup>17</sup>	-	-
V8-5.7	1997-1996	Upstream Sensor in Manifold	234-4012 <sup>1</sup>	234-4000 <sup>1</sup>	234-4087	234-4000
V8-5.7	1995-1994		234-4012 <sup>1</sup>	234-4000 <sup>1</sup>	-	-
V8-5.7	1993		234-1001 <sup>1</sup>	234-1000 <sup>1</sup>	-	-
V8-5.7	1992-1987		234-1001	234-1000	-	-
V8-5.7	1979		234-2001	234-2000	-	-
V8-6.6	1979		234-2001	234-2000	-	-
<b>FIREFLY</b>						
L3-1.0	2000-1996		234-4049	234-4209	234-4648	234-4209
L3-1.0	1995		234-4049	234-4209	-	-
L3-1.0	1994	Calif.	234-4049	234-4209	-	-
L3-1.0	1994	Exc. Calif.	234-1001	234-1000	-	-
L3-1.0	1991-1987		234-1001	234-1000	-	-
L3-1.0	1986-1985		234-1009	234-1000	-	-
L4-1.3	2000-1996		234-4049	234-4209	234-4648	234-4209
L4-1.3	1995		234-4049	234-4209	-	-
L4-1.3	1994		234-1001	234-1000	-	-
<b>G3</b>						
L4-1.6	2010-2009		234-4290	-	234-4298	-

<sup>1</sup> 2 Required / Requis 2 / Requeridos 2 <sup>4</sup> Left Side / Côté gauche / Lado izquierdo <sup>5</sup> Right Side / Côté droit / Lado derecho <sup>17</sup> Location Exhaust Pipe / Empl. tuyau d'éch / Ubicación tubo de escape



ENGINE MOTEUR MOTOR	YEAR ANNEE AÑO	APPLICATION INFORMATION INFORMATION D'APPLICATION INFORMACION DE APLICACION	UPSTREAM / AVANT - C.C. / ANTES DEL C.C.		DOWNSTREAM / APRS - C.C. / DESPUES DEL C.C.	
			TYPE / TIPO O.E.	UNIVERS.	TYPE / TIPO O.E.	UNIVERS.
<b>PONTIAC [cont]</b>						
<b>G3 WAVE</b>						
L4-1.6	2009		234-4290	-	234-4298	-
<b>G5</b>						
L4-2.2	2010-2007		234-4668	234-4212	234-4066	234-4209
L4-2.4	2008-2007		234-4342	-	234-4066	234-4209
<b>G6</b>						
L4-2.4	2010		234-4242	-	234-4250	-
L4-2.4	2009	4 Speed Auto Trans	234-4242	-	234-4250	-
L4-2.4	2009	6 Speed Auto Trans	234-4673	234-4212	234-4251	-
L4-2.4	2008	1st Design; Downstream Sensor Marked 12597947	234-4242	-	234-4294	-
L4-2.4	2008	2nd Design; Downstream Sensor Marked 12617907	234-4242	-	234-4250	-
L4-2.4	2007-2006		234-4342	-	234-4285	-
V6-3.5	2010-2008		234-4668 <sup>1</sup>	234-4212 <sup>1</sup>	234-4255 <sup>1</sup>	-
V6-3.5	2007-2005		234-4668 <sup>1</sup>	234-4212 <sup>1</sup>	234-4651 <sup>1</sup>	234-4209 <sup>1</sup>
V6-3.6	2009-2008		234-4668 <sup>4</sup>	234-4212 <sup>4</sup>	234-4254 <sup>4</sup>	-
V6-3.6	2009-2008		234-4668 <sup>5</sup>	234-4212 <sup>5</sup>	234-4341 <sup>5</sup>	-
V6-3.6	2007		234-4668 <sup>5</sup>	234-4212 <sup>5</sup>	234-4286 <sup>5</sup>	-
V6-3.6	2007		234-4668 <sup>4</sup>	234-4212 <sup>4</sup>	234-4651 <sup>4</sup>	234-4209 <sup>4</sup>
V6-3.9	2009-2008		234-4668 <sup>1</sup>	234-4212 <sup>1</sup>	234-4255 <sup>1</sup>	-
V6-3.9	2007-2006	Auto Trans	234-4668 <sup>4</sup>	234-4212 <sup>4</sup>	234-4651 <sup>4</sup>	234-4209 <sup>4</sup>
V6-3.9	2007-2006	Auto Trans	234-4668 <sup>5</sup>	234-4212 <sup>5</sup>	234-4647 <sup>5</sup>	234-4209 <sup>5</sup>
V6-3.9	2007	Manual Trans	234-4668 <sup>5</sup>	234-4212 <sup>5</sup>	234-4286 <sup>5</sup>	-
V6-3.9	2007	Manual Trans	234-4668 <sup>4</sup>	234-4212 <sup>4</sup>	234-4651 <sup>4</sup>	234-4209 <sup>4</sup>
V6-3.9	2006	Manual Trans	234-4668 <sup>1</sup>	234-4212 <sup>1</sup>	234-4651 <sup>1</sup>	234-4209 <sup>1</sup>
<b>G8</b>						
V6-3.6	2009-2008		234-4283 <sup>1</sup>	-	234-4821 <sup>1</sup>	-
V8-6.0	2009-2008		234-4668 <sup>1</sup>	234-4212 <sup>1</sup>	234-4253 <sup>1</sup>	-
V8-6.2	2009		234-4668 <sup>1</sup>	234-4212 <sup>1</sup>	234-4253 <sup>1</sup>	-
<b>GRAND AM</b>						
L4-2.0	1989-1987		234-1001	234-1000	-	-
L4-2.2	2005-2002		234-4646	234-4209	234-4104	234-4209
L4-2.3	1995-1988		234-1001	234-1000	-	-
L4-2.4	2001-2000		234-2060	234-2000	234-4617	234-4000
L4-2.4	1999	Exc. RC9 Option Code	234-1001	234-1000	234-4617	234-4000
L4-2.4	1999	RC9 Option Code	234-1023	234-1000	234-4617	234-4000
L4-2.4	1998-1996		234-1001	234-1000	234-4616	234-4000
L4-2.5	1991-1985		234-1001	234-1000	-	-
V6-3.0	1987-1985		234-1001	234-1000	-	-
V6-3.1	1998-1997		234-4018	234-4000	234-4616	234-4000
V6-3.1	1996		234-4012	234-4000	234-4616	234-4000

<sup>1</sup> 2 Required / Requis 2 / Requeridos 2 <sup>4</sup> Left Side / Côté gauche / Lado izquierdo <sup>5</sup> Right Side / Côté droit / Lado derecho



ENGINE MOTEUR MOTOR	YEAR ANNEE AÑO	APPLICATION INFORMATION INFORMATION D'APPLICATION INFORMACION DE APLICACION	UPSTREAM / AVANT - C.C. / ANTES DEL C.C.		DOWNSTREAM / APRS - C.C. / DESPUES DEL C.C.	
			TYPE / TIPO O.E.	UNIVERS.	TYPE / TIPO O.E.	UNIVERS.
<b>PONTIAC [cont]</b>						
<b>GRAND AM [cont]</b>						
V6-3.1	1995-1994		234-4012	234-4000	-	-
V6-3.3	1993-1992		234-1001	234-1000	-	-
V6-3.4	2005		234-4343	-	234-4108	234-4209
V6-3.4	2004-2001		234-4650	234-4209	234-4617	234-4000
V6-3.4	2000-1999		234-4018	234-4000	234-4617	234-4000
V6-3.8	1979		234-2001	234-2000	-	-
V8-4.9	1980-1979	2 Lead Sensor	234-2001	234-2000	-	-
V8-4.9	1980	1 Lead Sensor	234-1001	234-1000	-	-
V8-5.0	1980-1979	2 Lead Sensor	234-2001	234-2000	-	-
V8-5.0	1980	1 Lead Sensor	234-1001	234-1000	-	-
<b>GRAND LEMANS</b>						
V6-3.3	1979		234-2001	234-2000	-	-
V6-3.8	1983-1980	1 Lead Sensor	234-1001	234-1000	-	-
V6-3.8	1981-1979	2 Lead Sensor	234-2001	234-2000	-	-
V6-4.1	1982	1 Lead Sensor	234-1001	234-1000	-	-
V8-4.3	1981-1980	1 Lead Sensor	234-1001	234-1000	-	-
V8-4.3	1981-1980	2 Lead Sensor	234-2001	234-2000	-	-
V8-4.4	1982-1980	1 Lead Sensor	234-1001	234-1000	-	-
V8-4.4	1981-1979	2 Lead Sensor	234-2001	234-2000	-	-
V8-4.9	1981-1980	1 Lead Sensor	234-1001	234-1000	-	-
V8-4.9	1981-1979	2 Lead Sensor	234-2001	234-2000	-	-
V8-5.0	1983-1980	1 Lead Sensor	234-1001	234-1000	-	-
V8-5.0	1981-1979	2 Lead Sensor	234-2001	234-2000	-	-
V8-5.7	1979		234-2001	234-2000	-	-
<b>GRAND PRIX</b>						
L4-2.3	1991-1990		234-1001	234-1000	-	-
V6-2.8	1989-1988		234-1001	234-1000	-	-
V6-3.1	2003-2001		234-4650	234-4209	234-4087	234-4000
V6-3.1	2000-1997		234-4018	234-4000	234-4087	234-4000
V6-3.1	1996		234-4012 <sup>1</sup>	234-4000 <sup>1</sup>	234-4087	234-4000
V6-3.1	1995-1994		234-4012 <sup>1</sup>	234-4000 <sup>1</sup>	-	-
V6-3.1	1993	Calif.	234-3094	234-3090	-	-
V6-3.1	1993	Exc. Calif.	234-1001	234-1000	-	-
V6-3.1	1992-1989		234-1001	234-1000	-	-
V6-3.4	1996		234-4012 <sup>1</sup>	234-4000 <sup>1</sup>	234-4087	234-4000
V6-3.4	1995-1994		234-4012 <sup>1</sup>	234-4000 <sup>1</sup>	-	-
V6-3.4	1993		234-3094	234-3090	-	-
V6-3.4	1992-1991		234-1001	234-1000	-	-
V6-3.8	2008	Calif.	234-4668	234-4212	234-4103	234-4209
V6-3.8	2008	Exc. Calif.	234-4646	234-4209	234-4103	234-4209
V6-3.8	2007-2005	Non-Supercharged; Calif.	234-4668	234-4212	234-4647	234-4209

<sup>1</sup> 2 Required / Requis 2 / Requeridos 2





ENGINE MOTEUR MOTOR	YEAR ANNEE AÑO	APPLICATION INFORMATION INFORMATION D'APPLICATION INFORMACION DE APLICACION	UPSTREAM / AVANT - C.C. / ANTES DEL C.C.		DOWNSTREAM / APRS - C.C. / DESPUES DEL C.C.	
			TYPE / TIPO O.E.	UNIVERS.	TYPE / TIPO O.E.	UNIVERS.
<b>PONTIAC [cont]</b>						
<b>GRAND PRIX [cont]</b>						
V6-3.8	2007-2005	Non-Supercharged; Exc. Calif.	234-4646	234-4209	234-4647	234-4209
V6-3.8	2007-2005	Supercharged	234-4646	234-4209	234-4647	234-4209
V6-3.8	2004		234-4646	234-4209	234-4647	234-4209
V6-3.8	2003-1997		234-4018	234-4000	234-4087	234-4000
V6-3.8	1987-1980	1 Lead Sensor	234-1001	234-1000	-	-
V6-3.8	1981-1979	2 Lead Sensor	234-2001	234-2000	-	-
V6-4.1	1982		234-1001	234-1000	-	-
V6-4.3	1987-1986		234-1001	234-1000	-	-
V8-4.3	1981-1980	1 Lead Sensor	234-1001	234-1000	-	-
V8-4.3	1981-1980	2 Lead Sensor	234-2001	234-2000	-	-
V8-4.4	1982-1981	1 Lead Sensor	234-1001	234-1000	-	-
V8-4.4	1981	2 Lead Sensor	234-2001	234-2000	-	-
V8-4.9	1980-1979	2 Lead Sensor	234-2001	234-2000	-	-
V8-4.9	1980	1 Lead Sensor	234-1001	234-1000	-	-
V8-5.0	1987-1983		234-1001	234-1000	-	-
V8-5.0	1980-1979	2 Lead Sensor	234-2001	234-2000	-	-
V8-5.0	1980	1 Lead Sensor	234-1001	234-1000	-	-
V8-5.3	2008		234-4236	-	234-4249	-
V8-5.3	2007-2005		234-4236	-	234-4647	234-4209
<b>GTO</b>						
V8-5.7	2004		234-4668 <sup>1</sup>	234-4212 <sup>1</sup>	234-4063 <sup>1</sup>	234-4209 <sup>1</sup>
V8-6.0	2006-2005		234-4668 <sup>1</sup>	234-4212 <sup>1</sup>	234-4063 <sup>1</sup>	234-4209 <sup>1</sup>
<b>J2000</b>						
L4-1.8	1983-1982	1 Lead Sensor	234-1001	234-1000	-	-
L4-1.8	1982	2 Lead Sensor	234-2001	234-2000	-	-
L4-2.0	1983		234-1001	234-1000	-	-
<b>J2000 SUNBIRD</b>						
L4-1.8	1985-1984		234-1001	234-1000	-	-
L4-2.0	1985-1984		234-1001	234-1000	-	-
<b>LAURENTIAN</b>						
L6-4.1	1979		234-2001	234-2000	-	-
V6-3.8	1981-1980	1 Lead Sensor	234-1001	234-1000	-	-
V6-3.8	1981-1980	2 Lead Sensor	234-2001	234-2000	-	-
V8-4.3	1981	1 Lead Sensor	234-1001	234-1000	-	-
V8-4.3	1981	2 Lead Sensor	234-2001	234-2000	-	-
V8-4.4	1981-1980	1 Lead Sensor	234-1001	234-1000	-	-
V8-4.4	1981-1980	2 Lead Sensor	234-2001	234-2000	-	-
V8-5.0	1981-1980	1 Lead Sensor	234-1001	234-1000	-	-
V8-5.0	1981-1979	2 Lead Sensor	234-2001	234-2000	-	-
V8-5.7	1980-1979	2 Lead Sensor	234-2001	234-2000	-	-
V8-5.7	1980	1 Lead Sensor	234-1001	234-1000	-	-

<sup>1</sup> 2 Required / Requis 2 / Requeridos 2



ENGINE MOTEUR MOTOR	YEAR ANNEE AÑO	APPLICATION INFORMATION INFORMATION D'APPLICATION INFORMACION DE APLICACION	UPSTREAM / AVANT - C.C. / ANTES DEL C.C.		DOWNSTREAM / APRES - C.C. / DESPUES DEL C.C.	
			TYPE / TIPO O.E.	UNIVERS.	TYPE / TIPO O.E.	UNIVERS.
<b>PONTIAC [cont]</b>						
<b>LEMANS</b>						
L4-1.6	1993-1988		234-1001	234-1000	-	-
L4-2.0	1990-1989		234-1001	234-1000	-	-
V6-3.3	1979		234-2001	234-2000	-	-
V6-3.8	1981-1980	1 Lead Sensor	234-1001	234-1000	-	-
V6-3.8	1981-1979	2 Lead Sensor	234-2001	234-2000	-	-
V8-4.3	1981-1980	1 Lead Sensor	234-1001	234-1000	-	-
V8-4.3	1981-1980	2 Lead Sensor	234-2001	234-2000	-	-
V8-4.4	1981-1980	1 Lead Sensor	234-1001	234-1000	-	-
V8-4.4	1981-1979	2 Lead Sensor	234-2001	234-2000	-	-
V8-4.9	1981-1980	1 Lead Sensor	234-1001	234-1000	-	-
V8-4.9	1981-1979	2 Lead Sensor	234-2001	234-2000	-	-
V8-5.0	1981-1980	1 Lead Sensor	234-1001	234-1000	-	-
V8-5.0	1981-1979	2 Lead Sensor	234-2001	234-2000	-	-
V8-5.7	1979		234-2001	234-2000	-	-
<b>MONTANA</b>						
V6-3.4	2005		234-4343	-	234-4647	234-4209
V6-3.4	2004-2001		234-4650	234-4209	234-4087	234-4000
V6-3.4	2000-1999		234-4018	234-4000	234-4087	234-4000
V6-3.5	2006-2005		234-4668	234-4212	234-4647	234-4209
V6-3.9	2009-2008		234-4668	234-4212	234-4255	-
V6-3.9	2007-2006		234-4668	234-4212	234-4647	234-4209
<b>OPTIMA</b>						
L4-1.6	1991-1988		234-1001	234-1000	-	-
L4-2.0	1990-1988		234-1001	234-1000	-	-
<b>PARISIENNE</b>						
L6-4.1	1979		234-2001	234-2000	-	-
V6-3.8	1985-1980	1 Lead Sensor	234-1001	234-1000	-	-
V6-3.8	1981-1980	2 Lead Sensor	234-2001	234-2000	-	-
V6-4.3	1986		234-1001	234-1000	-	-
V6-4.3	1985		234-3074	234-3090	-	-
V8-4.3	1981	1 Lead Sensor	234-1001	234-1000	-	-
V8-4.3	1981	2 Lead Sensor	234-2001	234-2000	-	-
V8-4.4	1982-1980	1 Lead Sensor	234-1001	234-1000	-	-
V8-4.4	1981-1980	2 Lead Sensor	234-2001	234-2000	-	-
V8-5.0	1986-1980	1 Lead Sensor	234-1001	234-1000	-	-
V8-5.0	1981-1979	2 Lead Sensor	234-2001	234-2000	-	-
V8-5.7	1980-1979	2 Lead Sensor	234-2001	234-2000	-	-
V8-5.7	1980	1 Lead Sensor	234-1001	234-1000	-	-
<b>PHOENIX</b>						
L4-2.5	1984-1980	1 Lead Sensor	234-1001	234-1000	-	-



ENGINE MOTEUR MOTOR	YEAR ANNEE AÑO	APPLICATION INFORMATION INFORMATION D'APPLICATION INFORMACION DE APLICACION	UPSTREAM / AVANT - C.C. / ANTES DEL C.C.		DOWNSTREAM / APRS - C.C. / DESPUES DEL C.C.	
			TYPE / TIPO O.E.	UNIVERS.	TYPE / TIPO O.E.	UNIVERS.
<b>PONTIAC [cont]</b>						
<b>PHOENIX [cont]</b>						
L4-2.5	1981-1980	2 Lead Sensor	234-2001	234-2000	-	-
V6-2.8	1984-1980	1 Lead Sensor	234-1001	234-1000	-	-
V6-2.8	1981-1980	2 Lead Sensor	234-2001	234-2000	-	-
V6-3.8	1979		234-2001	234-2000	-	-
V8-5.0	1979		234-2001	234-2000	-	-
V8-5.7	1979		234-2001	234-2000	-	-
<b>PURSUIT</b>						
L4-2.2	2006-2005		234-4342	-	234-4066	234-4209
L4-2.4	2006		234-4342	-	234-4066	234-4209
<b>SAFARI</b>						
V8-5.0	1989-1987		234-1001	234-1000	-	-
<b>SOLSTICE</b>						
L4-2.0	2009		234-5007	-	234-4245	-
L4-2.0	2008-2007	1st Design; w/ 15" Downstream Sensor	234-5007	-	234-4820	-
L4-2.0	2008-2007	2nd Design; w/ 26" Downstream Sensor	234-5007	-	234-4245	-
L4-2.4	2009-2008		234-4242	-	234-4251	-
L4-2.4	2007-2006		234-4342	-	234-4289	-
<b>SUNBIRD</b>						
L4-1.8	1986		234-1001	234-1000	-	-
L4-2.0	1994-1986		234-1001	234-1000	-	-
L4-2.5	1980-1979		234-2001	234-2000	-	-
V6-3.1	1994-1991		234-1001	234-1000	-	-
V6-3.8	1980-1979	2 Lead Sensor	234-2001	234-2000	-	-
V6-3.8	1980	1 Lead Sensor	234-1001	234-1000	-	-
V8-5.0	1979		234-2001	234-2000	-	-
<b>SUNBURST</b>						
L4-1.5	1988-1985		234-1001	234-1000	-	-
<b>SUNFIRE</b>						
L4-2.2	2005-2002		234-4646	234-4209	234-4108	234-4209
L4-2.2	2001-2000		234-2060	234-2000	234-4089	234-4000
L4-2.2	1999		234-1023	234-1000	234-4089	234-4000
L4-2.2	1998-1996		234-1001	234-1000	234-4616	234-4000
L4-2.2	1995		234-1001	234-1000	-	-
L4-2.3	1995	Auto Trans	234-1001	234-1000	234-4616	234-4000
L4-2.3	1995	Manual Trans	234-1001	234-1000	-	-
L4-2.4	2002-2000		234-2060	234-2000	234-4616	234-4000
L4-2.4	1999		234-1023	234-1000	234-4616	234-4000
L4-2.4	1998-1996		234-1001	234-1000	234-4616	234-4000
<b>SUNRUNNER</b>						
L4-1.6	1997-1996		234-4060	234-4209	234-4649	234-4209
L4-1.6	1995-1994	Calif.	234-4060	234-4209	-	-



ENGINE MOTEUR MOTOR	YEAR ANNEE AÑO	APPLICATION INFORMATION INFORMATION D'APPLICATION INFORMACION DE APLICACION	UPSTREAM / AVANT - C.C. / ANTES DEL C.C.		DOWNSTREAM / APRES - C.C. / DESPUES DEL C.C.	
			TYPE / TIPO O.E.	UNIVERS.	TYPE / TIPO O.E.	UNIVERS.
<b>PONTIAC [cont]</b>						
<b>SUNRUNNER [cont]</b>						
L4-1.6	1995	Exc. Calif.	234-3014	234-3000	-	-
L4-1.6	1994	Exc. Calif.	234-3004	234-3000	-	-
<b>T1000</b>						
L4-1.6	1987-1981	1 Lead Sensor	234-1001	234-1000	-	-
L4-1.6	1981	2 Lead Sensor	234-2001	234-2000	-	-
<b>TEMPEST</b>						
L4-2.0	1989-1987		234-1001	234-1000	-	-
L4-2.2	1991-1990		234-1001	234-1000	-	-
V6-2.8	1989-1987		234-1001	234-1000	-	-
V6-3.1	1991-1990		234-1001	234-1000	-	-
<b>TORRENT</b>						
V6-3.4	2009-2008		234-4668	234-4212	234-4255	-
V6-3.4	2007-2006		234-4668	234-4212	234-4647	234-4209
V6-3.6	2009-2008		234-4819 <sup>1</sup>	-	234-4840 <sup>1</sup>	-
<b>TRANS SPORT</b>						
V6-3.1	1995-1990		234-1001	234-1000	-	-
V6-3.4	1999-1997		234-4018	234-4000	234-4087	234-4000
V6-3.4	1996		234-4012	234-4000	234-4087	234-4000
V6-3.8	1995-1994		234-4012	234-4000	-	-
V6-3.8	1993	3 Lead Sensor	234-3011	234-3000	-	-
V6-3.8	1992	1 Lead Sensor	234-1001	234-1000	-	-
<b>VIBE</b>						
L4-1.8	2010-2009		234-9090	-	234-4305	-
L4-1.8	2008-2007		234-9052	-	234-4233	234-4209
L4-1.8	2006-2005	VIN 8; FWD	234-9052	-	234-4233	234-4209
L4-1.8	2006-2004	VIN L	234-4802	-	234-4233	234-4209
L4-1.8	2006-2003	VIN 8; AWD	234-4801	-	234-4623	234-4209
L4-1.8	2004-2003	VIN 8; FWD	234-4800	-	234-4233	234-4209
L4-1.8	2003	VIN L	234-4233	234-4209	234-4233	234-4209
L4-2.4	2010-2009	AWD	234-9008	-	234-4306	-
L4-2.4	2010-2009	FWD	234-9008	-	234-4622	234-4209
<b>WAVE</b>						
L4-1.6	2008-2006		234-4293	-	234-4288	-
L4-1.6	2005		234-4284	-	234-4284	-
<b>WAVE5</b>						
L4-1.6	2007-2006		234-4293	-	234-4288	-
L4-1.6	2005		234-4284	-	234-4284	-

<sup>1</sup> 2 Required / Requis 2 / Requeridos 2



ENGINE MOTEUR MOTOR	YEAR ANNEE AÑO	APPLICATION INFORMATION INFORMATION D'APPLICATION INFORMACION DE APLICACION	UPSTREAM / AVANT - C.C. / ANTES DEL C.C.		DOWNSTREAM / APRS - C.C. / DESPUES DEL C.C.	
			TYPE / TIPO O.E.	UNIVERS.	TYPE / TIPO O.E.	UNIVERS.
<b>PORSCHE</b>						
<b>911</b>						
H6-3.0	1983-1979		-	234-1000	-	-
H6-3.2	1989-1986		234-3031	234-3000	-	-
H6-3.2	1985-1984	Non-Turbo	-	234-3000	-	-
H6-3.2	1985-1984	Turbo	234-3031	234-3000	-	-
H6-3.3	1992-1991		234-3031	234-3000	-	-
H6-3.3	1989-1984		234-3031	234-3000	-	-
H6-3.4	2014-2012		234-5069 <sup>1</sup>	-	234-4475 <sup>1</sup>	-
H6-3.4	2001-2000		234-4182 <sup>1</sup>	234-4201 <sup>1</sup>	234-4182 <sup>1</sup>	234-4201 <sup>1</sup>
H6-3.4	1999		234-4182 <sup>1</sup>	234-4201 <sup>1</sup>	234-4184 <sup>1</sup>	234-4201 <sup>1</sup>
H6-3.6	2012-2011	Non-Turbo	234-5023 <sup>1</sup>	-	234-4475 <sup>1</sup>	-
H6-3.6	2011	Turbo	234-5108 <sup>1</sup>	-	234-4879 <sup>1</sup>	-
H6-3.6	2010		234-5023 <sup>1</sup>	-	234-4475 <sup>1</sup>	-
H6-3.6	2009-2007	Turbo	234-5108 <sup>1</sup>	-	234-4879 <sup>1</sup>	-
H6-3.6	2009	Non-Turbo	234-5023 <sup>1</sup>	-	234-4475 <sup>1</sup>	-
H6-3.6	2008-2007	Non-Turbo; Carrera & Targa	234-5107 <sup>1</sup>	-	234-4879 <sup>1</sup>	-
H6-3.6	2008-2007	Non-Turbo; GT3	234-5108 <sup>1</sup>	-	234-4496 <sup>1</sup>	-
H6-3.6	2006		234-5107 <sup>1</sup>	-	234-4879 <sup>1</sup>	-
H6-3.6	2005-2002	Non-Turbo	234-4911 <sup>1</sup>	-	234-4923 <sup>1</sup>	-
H6-3.6	2005-2002	Turbo	234-5072 <sup>1</sup>	-	234-4878 <sup>1</sup>	-
H6-3.6	2001		234-5072 <sup>1</sup>	-	234-4878 <sup>1</sup>	-
H6-3.6	1998		234-4185 <sup>1</sup>	234-4201 <sup>1</sup>	234-4184 <sup>1</sup>	234-4201 <sup>1</sup>
H6-3.6	1997-1996	Non-Turbo	234-4185 <sup>1</sup>	234-4201 <sup>1</sup>	234-4184 <sup>1</sup>	234-4201 <sup>1</sup>
H6-3.6	1997-1996	Turbo	234-4182 <sup>1</sup>	234-4201 <sup>1</sup>	234-4185 <sup>1</sup>	234-4201 <sup>1</sup>
H6-3.6	1995		234-4185 <sup>1</sup>	234-4201 <sup>1</sup>	234-4184 <sup>1</sup>	234-4201 <sup>1</sup>
H6-3.6	1994	Carrera 2 & 4 ; VIN Beginning with 99	234-4185	234-4201	-	-
H6-3.6	1994	Carrera 2; VIN Beginning with 96	234-3031	234-3000	-	-
H6-3.6	1994	Carrera 4; VIN Beginning with 96	234-4923	-	-	-
H6-3.6	1994	Exc. Carrera	234-3031	234-3000	-	-
H6-3.6	1993-1989		234-3031	234-3000	-	-
H6-3.8	2014	Non-Turbo; Exc. GT3 Submodel	234-5069 <sup>1</sup>	-	234-4475 <sup>1</sup>	-
H6-3.8	2014	Non-Turbo; GT3 Submodel	234-5069 <sup>1</sup>	-	234-4879 <sup>1</sup>	-
H6-3.8	2014	Turbo	234-5036 <sup>1</sup>	-	234-4475 <sup>1</sup>	-
H6-3.8	2013-2010	Turbo	234-5108 <sup>1</sup>	-	234-4475 <sup>1</sup>	-
H6-3.8	2013	Non-Turbo	234-5069 <sup>1</sup>	-	234-4475 <sup>1</sup>	-
H6-3.8	2012	Non-Turbo; Carrera S Model	234-5069 <sup>1</sup>	-	234-4475 <sup>1</sup>	-
H6-3.8	2012	Non-Turbo; Exc. Carrera S Model	234-5023 <sup>1</sup>	-	234-4475 <sup>1</sup>	-
H6-3.8	2011-2010	Non-Turbo; Exc. GT3	234-5023 <sup>1</sup>	-	234-4475 <sup>1</sup>	-
H6-3.8	2011-2010	Non-Turbo; GT3	234-5023 <sup>1</sup>	-	234-4496 <sup>1</sup>	-

<sup>1</sup> 2 Required / Requis 2 / Requeridos 2



ENGINE MOTEUR MOTOR	YEAR ANNEE AÑO	APPLICATION INFORMATION INFORMATION D'APPLICATION INFORMACION DE APLICACION	UPSTREAM / AVANT - C.C. / ANTES DEL C.C.		DOWNSTREAM / APRS - C.C. / DESPUES DEL C.C.	
			TYPE / TIPO O.E.	UNIVERS.	TYPE / TIPO O.E.	UNIVERS.
<b>PORSCHE [cont]</b>						
<b>911 [cont]</b>						
H6-3.8	2009		234-5023 <sup>1</sup>	-	234-4475 <sup>1</sup>	-
H6-3.8	2008-2006		234-5107 <sup>1</sup>	-	234-4879 <sup>1</sup>	-
H6-3.8	2005		234-4911 <sup>1</sup>	-	234-4923 <sup>1</sup>	-
H6-4.0	2011		234-5023 <sup>1</sup>	-	234-4496 <sup>1</sup>	-
<b>918 SPYDER</b>						
V8-4.6	2015		234-5102 <sup>1</sup>	-	234-4475 <sup>1</sup>	-
<b>924</b>						
L4-2.0	1982-1980		-	234-1000	-	-
L4-2.5	1988-1987	Calif.	-	234-3000	-	-
L4-2.5	1988-1987	Exc. Calif.	234-3029	234-3000	-	-
<b>928</b>						
V8-4.5	1982-1980		-	234-1000	-	-
V8-4.7	1984-1983		-	234-3000	-	-
V8-5.0	1991-1988		234-3031	234-3000	-	-
V8-5.0	1987-1985		-	234-3000	-	-
V8-5.4	1995-1993		234-3031	234-3000	-	-
<b>944</b>						
L4-2.5	1989		234-3031	234-3000	-	-
L4-2.5	1988-1986	Non-Turbo; Calif.	-	234-3000	-	-
L4-2.5	1988-1986	Non-Turbo; Exc. Calif.	234-3029	234-3000	-	-
L4-2.5	1988-1986	Turbo	234-3031	234-3000	-	-
L4-2.5	1985-1983	Calif.	-	234-3000	-	-
L4-2.5	1985-1983	Exc. Calif.	-	234-1000	-	-
L4-2.7	1989		234-3029	234-3000	-	-
L4-3.0	1991		234-3029	234-3000	-	-
L4-3.0	1990	Non-Turbo	234-3029	234-3000	-	-
L4-3.0	1990	Turbo	234-3031	234-3000	-	-
L4-3.0	1989		234-3029	234-3000	-	-
<b>968</b>						
L4-3.0	1995-1992		234-3029	234-3000	-	-
<b>BOXSTER</b>						
H6-2.5	1999-1997		234-4186 <sup>1</sup>	234-4201 <sup>1</sup>	234-4186 <sup>1</sup>	234-4201 <sup>1</sup>
H6-2.7	2015-2013		234-5102 <sup>1</sup>	-	234-4474 <sup>1</sup>	-
H6-2.7	2008-2005		234-5108 <sup>1</sup>	-	234-4496 <sup>1</sup>	-
H6-2.7	2004-2003	Loc. Primary Catalyst	234-4920 <sup>1</sup>	-	234-4917 <sup>1</sup>	-
H6-2.7	2004-2003	Loc. Secondary Catalyst	-	-	234-4916 <sup>1</sup>	-
H6-2.7	2002-2000	Loc. Primary Catalyst	234-4271 <sup>1</sup>	234-4201 <sup>1</sup>	234-4269 <sup>1</sup>	-
H6-2.7	2002-2000	Loc. Secondary Catalyst	-	-	234-4186 <sup>1</sup>	234-4201 <sup>1</sup>
H6-2.9	2012-2009		234-5023 <sup>1</sup>	-	234-4496 <sup>1</sup>	-
H6-3.2	2006-2005		234-5108 <sup>1</sup>	-	234-4496 <sup>1</sup>	-

<sup>1</sup> 2 Required / Requis 2 / Requeridos 2



ENGINE MOTEUR MOTOR	YEAR ANNEE AÑO	APPLICATION INFORMATION INFORMATION D'APPLICATION INFORMACION DE APLICACION	UPSTREAM / AVANT - C.C. / ANTES DEL C.C.		DOWNSTREAM / APRS - C.C. / DESPUES DEL C.C.	
			TYPE / TIPO O.E.	UNIVERS.	TYPE / TIPO O.E.	UNIVERS.
<b>PORSCHE [cont]</b>						
<b>BOXSTER [cont]</b>						
H6-3.2	2004-2003	Loc. Primary Catalyst	234-4920 <sup>1</sup>	-	234-4917 <sup>1</sup>	-
H6-3.2	2004-2003	Loc. Secondary Catalyst	-	-	234-4916 <sup>1</sup>	-
H6-3.2	2002-2000	Loc. Primary Catalyst	234-4271 <sup>1</sup>	234-4201 <sup>1</sup>	234-4269 <sup>1</sup>	-
H6-3.2	2002-2000	Loc. Secondary Catalyst	-	-	234-4186 <sup>1</sup>	234-4201 <sup>1</sup>
H6-3.4	2015-2013		234-5102 <sup>1</sup>	-	234-4474 <sup>1</sup>	-
H6-3.4	2012-2009		234-5023 <sup>1</sup>	-	234-4496 <sup>1</sup>	-
H6-3.4	2008-2007		234-5108 <sup>1</sup>	-	234-4496 <sup>1</sup>	-
<b>CARRERA GT</b>						
V10-5.7	2005-2004		234-4911 <sup>1</sup>	-	234-4911 <sup>1</sup>	-
<b>CAYENNE</b>						
V6-3.0	2015-2013	Hybrid Engine	234-5034 <sup>5</sup>	-	234-4485 <sup>5</sup>	-
V6-3.0	2015	Hybrid Engine	-	-	234-4498 <sup>4</sup>	-
V6-3.0	2014-2013	Hybrid Engine	234-5119 <sup>4</sup>	-	234-4498 <sup>4</sup>	-
V6-3.0	2013	Diesel Engine	234-5034	-	234-5159	-
V6-3.0	2012-2011		234-5119 <sup>4</sup>	-	234-4498 <sup>4</sup>	-
V6-3.0	2012-2011		234-5034 <sup>5</sup>	-	234-4485 <sup>5</sup>	-
V6-3.2	2006-2004		234-5073 <sup>4</sup>	-	234-4809 <sup>4</sup>	-
V6-3.2	2006-2004		234-5028 <sup>5</sup>	-	234-4808 <sup>5</sup>	-
V6-3.6	2015	Non-Turbo; Cylinder 1,2,3	234-5108	-	234-4829	-
V6-3.6	2015	Non-Turbo; Cylinder 4,5,6	234-5087	-	234-4498	-
V6-3.6	2015	Turbo	234-5102 <sup>4</sup>	-	234-4496 <sup>4</sup>	-
V6-3.6	2015	Turbo	234-5036 <sup>5</sup>	-	234-4496 <sup>5</sup>	-
V6-3.6	2014-2011	Cylinder 1,2,3	234-5108	-	234-4231	-
V6-3.6	2014-2011	Cylinder 4,5,6	234-5087	-	234-4499	-
V6-3.6	2010-2008	Cylinder 1,2,3	234-5125	-	234-4485	-
V6-3.6	2010-2008	Cylinder 4,5,6	234-5104	-	234-4485	-
V8-4.5	2006-2003	Non-Turbo	234-5074 <sup>4</sup>	-	234-4809 <sup>4</sup>	-
V8-4.5	2006-2003	Non-Turbo	234-5045 <sup>5</sup>	-	234-4809 <sup>5</sup>	-
V8-4.5	2006-2003	Turbo	234-5117 <sup>1</sup>	-	234-4809 <sup>1</sup>	-
V8-4.8	2015		234-5024 <sup>1</sup>	-	234-4496 <sup>1</sup>	-
V8-4.8	2014-2011	Non-Turbo	234-5023 <sup>1</sup>	-	234-4496 <sup>1</sup>	-
V8-4.8	2014-2011	Turbo	234-5024 <sup>1</sup>	-	234-4496 <sup>1</sup>	-
V8-4.8	2010-2008	Non-Turbo	234-5023 <sup>1</sup>	-	234-4878 <sup>1</sup>	-
V8-4.8	2010-2008	Turbo	234-5024 <sup>1</sup>	-	234-4878 <sup>1</sup>	-
<b>CAYMAN</b>						
H6-2.7	2015-2014		234-5102 <sup>1</sup>	-	234-4474 <sup>1</sup>	-
H6-2.7	2008-2007		234-5108 <sup>1</sup>	-	234-4496 <sup>1</sup>	-
H6-2.9	2012-2009		234-5023 <sup>1</sup>	-	234-4496 <sup>1</sup>	-
H6-3.4	2015-2014		234-5102 <sup>1</sup>	-	234-4474 <sup>1</sup>	-

<sup>1</sup> 2 Required / Requis 2 / Requeridos 2 <sup>4</sup> Left Side / Côté gauche / Lado izquierdo <sup>5</sup> Right Side / Côté droit / Lado derecho



ENGINE MOTEUR MOTOR	YEAR ANNEE AÑO	APPLICATION INFORMATION INFORMATION D'APPLICATION INFORMACION DE APLICACION	UPSTREAM / AVANT - C.C. / ANTES DEL C.C.		DOWNSTREAM / APRS - C.C. / DESPUES DEL C.C.	
			TYPE / TIPO O.E.	UNIVERS.	TYPE / TIPO O.E.	UNIVERS.
<b>PORSCHE [cont]</b>						
<b>CAYMAN [cont]</b>						
H6-3.4	2012-2009		234-5023 <sup>1</sup>	-	234-4496 <sup>1</sup>	-
H6-3.4	2008-2006		234-5108 <sup>1</sup>	-	234-4496 <sup>1</sup>	-
<b>MACAN</b>						
V6-3.0	2015		234-5102 <sup>4</sup>	-	234-4879 <sup>4</sup>	-
V6-3.0	2015		234-5102 <sup>5</sup>	-	234-4878 <sup>5</sup>	-
V6-3.6	2015		234-5102 <sup>4</sup>	-	234-4879 <sup>4</sup>	-
V6-3.6	2015		234-5102 <sup>5</sup>	-	234-4878 <sup>5</sup>	-
<b>PANAMERA</b>						
V6-3.0	2015	Gas Engine	234-5036 <sup>4</sup>	-	234-4475 <sup>4</sup>	-
V6-3.0	2015	Gas Engine	234-5023 <sup>5</sup>	-	234-4969 <sup>5</sup>	-
V6-3.0	2015	Hybrid Engine	-	-	234-4474 <sup>4</sup>	-
V6-3.0	2015	Hybrid Engine	234-5034 <sup>5</sup>	-	234-4474 <sup>5</sup>	-
V6-3.0	2014		234-5036 <sup>4</sup>	-	234-4475 <sup>4</sup>	-
V6-3.0	2014		234-5023 <sup>5</sup>	-	234-4969 <sup>5</sup>	-
V6-3.0	2013-2012		234-5119 <sup>4</sup>	-	234-4474 <sup>4</sup>	-
V6-3.0	2013-2012		234-5034 <sup>5</sup>	-	234-4474 <sup>5</sup>	-
V6-3.6	2015-2011		234-5036 <sup>4</sup>	-	234-4475 <sup>4</sup>	-
V6-3.6	2015	Auto Trans	234-5119 <sup>5</sup>	-	234-4474 <sup>5</sup>	-
V6-3.6	2015	Manual Trans	234-5119 <sup>5</sup>	-	234-4497 <sup>5</sup>	-
V6-3.6	2014-2011		234-5119 <sup>5</sup>	-	234-4474 <sup>5</sup>	-
V8-3.0	2015	Gas Engine	234-5036 <sup>4</sup>	-	234-4475 <sup>4</sup>	-
V8-3.0	2015	Gas Engine	234-5023 <sup>5</sup>	-	234-4969 <sup>5</sup>	-
V8-3.0	2014		234-5036 <sup>4</sup>	-	234-4475 <sup>4</sup>	-
V8-3.0	2014		234-5023 <sup>5</sup>	-	234-4969 <sup>5</sup>	-
V8-4.8	2015-2010		234-5036 <sup>4</sup>	-	234-4475 <sup>4</sup>	-
V8-4.8	2015	Non-Turbo; Auto Trans	234-5119 <sup>5</sup>	-	234-4474 <sup>5</sup>	-
V8-4.8	2015	Non-Turbo; Manual Trans	234-5119 <sup>5</sup>	-	234-4497 <sup>5</sup>	-
V8-4.8	2015	Turbo	234-5119 <sup>5</sup>	-	234-4474 <sup>5</sup>	-
V8-4.8	2014-2010		234-5119 <sup>5</sup>	-	234-4474 <sup>5</sup>	-
<b>RAM</b>						
<b>1500</b>						
V6-3.0	2015-2014		234-5170	-	-	-
V6-3.6	2014-2013		234-4545 <sup>4</sup>	-	234-4545 <sup>4</sup>	-
V6-3.6	2014-2013		234-4587 <sup>5</sup>	-	234-4545 <sup>5</sup>	-
V6-3.7	2012-2011		234-4588 <sup>1</sup>	-	234-4587 <sup>1</sup>	-
V8-4.7	2013-2011		234-4587 <sup>1</sup>	-	234-4587 <sup>1</sup>	-
V8-5.7	2015-2013	6 Speed Trans	234-4547 <sup>1</sup>	-	234-4579	-
V8-5.7	2015-2013	8 Speed Trans	234-4579 <sup>4</sup>	-	234-4547 <sup>4</sup>	-

<sup>1</sup> 2 Required / Requis 2 / Requeridos 2 <sup>4</sup> Left Side / Côté gauche / Lado izquierdo <sup>5</sup> Right Side / Côté droit / Lado derecho





ENGINE MOTEUR MOTOR	YEAR ANNEE AÑO	APPLICATION INFORMATION INFORMATION D'APPLICATION INFORMACION DE APLICACION	UPSTREAM / AVANT - C.C. / ANTES DEL C.C.		DOWNSTREAM / APRS - C.C. / DESPUES DEL C.C.	
			TYPE / TIPO O.E.	UNIVERS.	TYPE / TIPO O.E.	UNIVERS.
<b>RAM [cont]</b>						
<b>1500 [cont]</b>						
V8-5.7	2015-2013	8 Speed Trans	234-4545 <sup>5</sup>	-	234-4547 <sup>5</sup>	-
V8-5.7	2012	EZC Engine; Tradesman HD Model	234-4547 <sup>4</sup>	-	234-4579 <sup>4</sup>	-
V8-5.7	2012	EZC Engine; Tradesman HD Model	234-4547 <sup>5</sup>	-	234-4545 <sup>5</sup>	-
V8-5.7	2012	EZH Engine; Exc. Tradesman HD Model	234-4547 <sup>4</sup>	-	234-4547 <sup>4</sup>	-
V8-5.7	2012	EZH Engine; Exc. Tradesman HD Model	234-4547 <sup>5</sup>	-	234-4579 <sup>5</sup>	-
V8-5.7	2011		234-4588 <sup>5</sup>	-	234-4588 <sup>5</sup>	-
V8-5.7	2011	4WD	234-4588 <sup>4</sup>	-	234-4587 <sup>4</sup>	-
V8-5.7	2011	RWD	234-4587 <sup>4</sup>	-	234-4587 <sup>4</sup>	-
<b>2500</b>						
L6-6.7	2012		234-5090 <sup>4</sup>	-	234-5090 <sup>5</sup>	-
L6-6.7	2011		234-5090	-	234-5090	-
V8-5.7	2015-2012		234-4547 <sup>4</sup>	-	234-4579 <sup>4</sup>	-
V8-5.7	2015-2012		234-4547 <sup>5</sup>	-	234-4545 <sup>5</sup>	-
V8-5.7	2011		234-4587 <sup>4</sup>	-	234-4588 <sup>4</sup>	-
V8-5.7	2011		234-4587 <sup>5</sup>	-	234-4546 <sup>5</sup>	-
V8-6.4	2015		234-4547 <sup>4</sup>	-	234-4545 <sup>4</sup>	-
V8-6.4	2015	4WD	234-4547 <sup>5</sup>	-	234-4547 <sup>5</sup>	-
V8-6.4	2015	RWD	234-4547 <sup>5</sup>	-	234-4579 <sup>5</sup>	-
V8-6.4	2014		234-4547 <sup>4</sup>	-	234-4579 <sup>4</sup>	-
V8-6.4	2014		234-4547 <sup>5</sup>	-	234-4545 <sup>5</sup>	-
<b>3500</b>						
L6-6.7	2012-2011	Pickup	234-5090	-	234-5090	-
V8-5.7	2015-2012		234-4547 <sup>4</sup>	-	234-4579 <sup>4</sup>	-
V8-5.7	2015-2012		234-4547 <sup>5</sup>	-	234-4545 <sup>5</sup>	-
V8-5.7	2011		234-4587 <sup>4</sup>	-	234-4588 <sup>4</sup>	-
V8-5.7	2011		234-4587 <sup>5</sup>	-	234-4546 <sup>5</sup>	-
V8-6.4	2015		234-4547 <sup>4</sup>	-	234-4545 <sup>4</sup>	-
V8-6.4	2015	4WD	234-4547 <sup>5</sup>	-	234-4547 <sup>5</sup>	-
V8-6.4	2015	RWD	234-4547 <sup>5</sup>	-	234-4579 <sup>5</sup>	-
V8-6.4	2014	ESA Engine	234-4547 <sup>4</sup>	-	234-4579 <sup>4</sup>	-
V8-6.4	2014	ESA Engine	234-4547 <sup>5</sup>	-	234-4545 <sup>5</sup>	-
V8-6.4	2014	ESB Engine	234-4547 <sup>4</sup>	-	234-4545 <sup>4</sup>	-
V8-6.4	2014	ESB Engine; 4WD	234-4547 <sup>5</sup>	-	234-4547 <sup>5</sup>	-
V8-6.4	2014	ESB Engine; RWD	234-4547 <sup>5</sup>	-	234-4579 <sup>5</sup>	-
<b>C/V</b>						
V6-3.6	2015-2014		234-4545 <sup>4</sup>	-	234-4545 <sup>4</sup>	-
V6-3.6	2015-2014		234-4545 <sup>5</sup>	-	234-4547 <sup>5</sup>	-
V6-3.6	2013-2012		234-4545 <sup>4</sup>	-	234-4547 <sup>4</sup>	-
V6-3.6	2013-2012		234-4545 <sup>5</sup>	-	234-4545 <sup>5</sup>	-

<sup>4</sup> Left Side / Côté gauche / Lado izquierdo <sup>5</sup> Right Side / Côté droit / Lado derecho



ENGINE MOTEUR MOTOR	YEAR ANNEE AÑO	APPLICATION INFORMATION INFORMATION D'APPLICATION INFORMACION DE APLICACION	UPSTREAM / AVANT - C.C. / ANTES DEL C.C.		DOWNSTREAM / APRS - C.C. / DESPUES DEL C.C.	
			TYPE / TIPO O.E.	UNIVERS.	TYPE / TIPO O.E.	UNIVERS.
<b>RAM [cont]</b>						
<b>DAKOTA</b>						
V6-3.7	2011		234-4587 <sup>4</sup>	-	234-4588 <sup>4</sup>	-
V6-3.7	2011		234-4588 <sup>5</sup>	-	234-4588 <sup>5</sup>	-
V8-4.7	2011		234-4587 <sup>4</sup>	-	234-4588 <sup>4</sup>	-
V8-4.7	2011		234-4588 <sup>5</sup>	-	234-4588 <sup>5</sup>	-
<b>PROMASTER 1500</b>						
L4-3.0	2014		234-5170	-	-	-
V6-3.6	2015-2014		234-4545 <sup>1</sup>	-	234-4545 <sup>1</sup>	-
<b>PROMASTER 2500</b>						
L4-3.0	2014		234-5170	-	-	-
V6-3.6	2015-2014		234-4545 <sup>1</sup>	-	234-4545 <sup>1</sup>	-
<b>PROMASTER 3500</b>						
L4-3.0	2014		234-5170	-	-	-
V6-3.6	2015-2014		234-4545 <sup>1</sup>	-	234-4545 <sup>1</sup>	-
<b>PROMASTER CITY</b>						
L4-2.4	2015		234-5150	-	234-4545	-
<b>RENAULT</b>						
<b>ALLIANCE</b>						
L4-1.4	1987-1986	Ford Connector	234-1003	234-1000	-	-
L4-1.4	1987-1986	GM Connector	234-1001	234-1000	-	-
L4-1.4	1985-1983	VIN D	234-1003	234-1000	-	-
L4-1.4	1984-1983	VIN E	234-1013	234-1000	-	-
L4-1.7	1987-1986	Ford Connector	234-1003	234-1000	-	-
L4-1.7	1987-1986	GM Connector	234-1001	234-1000	-	-
L4-1.7	1985		234-1003	234-1000	-	-
<b>ENCORE</b>						
L4-1.4	1986	Ford Connector	234-1003	234-1000	-	-
L4-1.4	1986	GM Connector	234-1001	234-1000	-	-
L4-1.4	1985-1984	VIN D	234-1003	234-1000	-	-
L4-1.4	1985-1984	VIN E	234-1013	234-1000	-	-
L4-1.7	1986-1985	Ford Connector	234-1003	234-1000	-	-
L4-1.7	1986	GM Connector	234-1001	234-1000	-	-
<b>FUEGO</b>						
L4-1.6	1984-1982		234-1011	234-1000	-	-
L4-2.2	1985-1984		234-1011	234-1000	-	-
<b>LECAR</b>						
L4-1.4	1983-1980		234-1011	234-1000	-	-
<b>R18</b>						
L4-1.6	1981		234-1011	234-1000	-	-

<sup>1</sup> 2 Required / Requis 2 / Requeridos 2 <sup>4</sup> Left Side / Côté gauche / Lado izquierdo <sup>5</sup> Right Side / Côté droit / Lado derecho



ENGINE MOTEUR MOTOR	YEAR ANNEE AÑO	APPLICATION INFORMATION INFORMATION D'APPLICATION INFORMACION DE APLICACION	UPSTREAM / AVANT - C.C. / ANTES DEL C.C.		DOWNSTREAM / APRS - C.C. / DESPUES DEL C.C.	
			TYPE / TIPO O.E.	UNIVERS.	TYPE / TIPO O.E.	UNIVERS.
<b>RENAULT [cont]</b>						
<b>R18I</b>						
L4-1.6	1983-1981		234-1011	234-1000	-	-
L4-2.2	1986-1984		234-1011	234-1000	-	-
<b>ROLLS-ROYCE</b>						
<b>GHOST</b>						
V12-6.6	2015-2010		234-5037 <sup>1</sup>	-	234-4900 <sup>1</sup>	-
<b>PHANTOM</b>						
V12-6.7	2015-2008		234-5136 <sup>1</sup>	-	234-4875 <sup>1</sup>	-
V12-6.7	2007	From 09/2006	234-5136 <sup>1</sup>	-	234-4875 <sup>1</sup>	-
V12-6.7	2007	To 09/2006	-	-	234-4470 <sup>1</sup>	234-4201 <sup>1</sup>
V12-6.7	2006-2004		-	-	234-4470 <sup>1</sup>	234-4201 <sup>1</sup>
<b>SAAB</b>						
<b>9-2X</b>						
H4-2.0	2005		234-9011	-	234-4732	-
H4-2.5	2006	Non-Turbo	234-9123	-	234-4445	-
H4-2.5	2006	Turbo	234-9120	-	234-4732	-
H4-2.5	2005		234-9122	-	234-4732	-
<b>9-3</b>						
L4-2.0	2011-2004		234-4912	-	234-4910	-
L4-2.0	2003	Exc. SE Model	234-4268	-	234-4267	-
L4-2.0	2003	SE Model	234-4911	-	234-4913	-
L4-2.0	2002-2000		234-4911	-	234-4913	-
L4-2.0	1999	From Chassis #020001	234-4184	234-4201	234-4184	234-4201
L4-2.0	1999	To Chassis #020000	234-4185	234-4201	234-4184	234-4201
L4-2.3	2002-2000		234-4911	-	234-4913	-
L4-2.3	1999	From Chassis #020001	234-4184	234-4201	234-4184	234-4201
L4-2.3	1999	To Chassis #020000	234-4185	234-4201	234-4184	234-4201
V6-2.8	2009-2006		234-5108	-	234-4821	-
<b>9-3X</b>						
L4-2.0	2011-2010		234-4912	-	234-4910	-
<b>9-4X</b>						
V6-2.8	2011		234-4821	-	234-4821	-
V6-3.0	2011		234-4815 <sup>1</sup>	-	234-4815 <sup>1</sup>	-
<b>9-5</b>						
L4-2.0	2011		234-4673	234-4212	234-4526	-
L4-2.3	2009-2000		234-4911	-	234-4913	-
L4-2.3	1999		234-4184	234-4201	234-4184	234-4201
V6-2.8	2011-2010		234-4821	-	234-4527	-
V6-3.0	2003-2000		234-4911 <sup>1</sup>	-	234-4914	-

<sup>1</sup> 2 Required / Requis 2 / Requeridos 2



ENGINE MOTEUR MOTOR	YEAR ANNEE AÑO	APPLICATION INFORMATION INFORMATION D'APPLICATION INFORMACION DE APLICACION	UPSTREAM / AVANT - C.C. / ANTES DEL C.C.		DOWNSTREAM / APRES - C.C. / DESPUES DEL C.C.	
			TYPE / TIPO O.E.	UNIVERS.	TYPE / TIPO O.E.	UNIVERS.
<b>SAAB [cont]</b>						
<b>9-5 [cont]</b>						
V6-3.0	1999		234-4184 <sup>1</sup>	234-4201 <sup>1</sup>	234-4183	234-4201
<b>9-7X</b>						
L6-4.2	2009-2007		234-4331	-	234-4294	-
L6-4.2	2006		234-4331	-	234-4348	-
L6-4.2	2005		234-4119	-	234-4285	-
V8-5.3	2009-2008		234-4339 <sup>4</sup>	-	234-4246 <sup>4</sup>	-
V8-5.3	2009-2008		234-4339 <sup>5</sup>	-	234-4243 <sup>5</sup>	-
V8-5.3	2007		234-4339 <sup>1</sup>	-	234-4561 <sup>1</sup>	-
V8-5.3	2006	1st Design; Square Downstream Connector	234-4339 <sup>1</sup>	-	234-4285 <sup>1</sup>	-
V8-5.3	2006	2nd Design; Triangular Downstream Connector	234-4339 <sup>1</sup>	-	234-4561 <sup>1</sup>	-
V8-5.3	2005		234-4651 <sup>1</sup>	234-4209 <sup>1</sup>	234-4651 <sup>1</sup>	234-4209 <sup>1</sup>
V8-6.0	2009-2008		234-4339 <sup>4</sup>	-	234-4246 <sup>4</sup>	-
V8-6.0	2009-2008		234-4339 <sup>5</sup>	-	234-4243 <sup>5</sup>	-
<b>99</b>						
L4-2.0	1980-1977		234-1011	234-1000	-	-
<b>900</b>						
L4-2.0	1998-1996		234-4185	234-4201	234-4184	234-4201
L4-2.0	1995-1994		234-3079	234-3000	-	-
L4-2.0	1993-1989		234-3048	234-3000	-	-
L4-2.0	1988	Exc. VIN J	234-3048	234-3000	-	-
L4-2.0	1988	VIN J	234-3028	234-3000	-	-
L4-2.0	1987-1986	1 Lead Sensor	234-1015	234-1000	-	-
L4-2.0	1987-1986	3 Lead Sensor	234-3048	234-3000	-	-
L4-2.0	1985-1979		234-1011	234-1000	-	-
L4-2.1	1994		234-3079	234-3000	-	-
L4-2.1	1993-1991		234-3048	234-3000	-	-
L4-2.3	1998-1996		234-4185	234-4201	234-4184	234-4201
L4-2.3	1995		234-3079	234-3000	-	-
L4-2.3	1994		234-1011	234-1000	-	-
V6-2.5	1997-1996		234-4182 <sup>4</sup>	234-4201 <sup>4</sup>	234-4183 <sup>4</sup>	234-4201 <sup>4</sup>
V6-2.5	1997-1996		234-4182 <sup>5</sup>	234-4201 <sup>5</sup>	234-4181 <sup>5</sup>	234-4201 <sup>5</sup>
V6-2.5	1995-1994		234-3078 <sup>1</sup>	234-3000 <sup>1</sup>	-	-
<b>9000</b>						
L4-2.0	1990		234-3048	234-3000	-	-
L4-2.0	1989-1987	Non-Turbo	234-3028	234-3000	-	-
L4-2.0	1989-1987	Turbo	234-3048	234-3000	-	-
L4-2.0	1986		234-3048	234-3000	-	-
L4-2.3	1998-1996		234-4185	234-4201	234-4182	234-4201
L4-2.3	1995-1994		234-3079	234-3000	-	-
L4-2.3	1993	Non-Turbo	234-3070	234-3000	-	-

<sup>1</sup> 2 Required / Requis 2 / Requeridos 2 <sup>4</sup> Left Side / Côté gauche / Lado izquierdo <sup>5</sup> Right Side / Côté droit / Lado derecho



ENGINE MOTEUR MOTOR	YEAR ANNEE AÑO	APPLICATION INFORMATION INFORMATION D'APPLICATION INFORMACION DE APLICACION	UPSTREAM / AVANT - C.C. / ANTES DEL C.C.		DOWNSTREAM / APRES - C.C. / DESPUES DEL C.C.	
			TYPE / TIPO O.E.	UNIVERS.	TYPE / TIPO O.E.	UNIVERS.
<b>SAAB [cont]</b>						
<b>9000 [cont]</b>						
L4-2.3	1993	Turbo	234-3092	234-3000	-	-
L4-2.3	1992		234-3092	234-3000	-	-
L4-2.3	1991-1990		234-3048	234-3000	-	-
V6-3.0	1997-1996		234-4182 <sup>1</sup>	234-4201 <sup>1</sup>	234-4183	234-4201
V6-3.0	1995		234-3078 <sup>1</sup>	234-3000 <sup>1</sup>	-	-
<b>SATURN</b>						
<b>ASTRA</b>						
L4-1.8	2009-2008		234-4247	-	234-4248	-
<b>AURA</b>						
L4-2.4	2009	Gas Engine	234-4673	234-4212	234-4251	-
L4-2.4	2009	Hybrid Engine	234-4242	-	234-4250	-
L4-2.4	2008	1st Design; Gas Engine; Downstream Sensor Marked 12597947	234-4242	-	234-4294	-
L4-2.4	2008	1st Design; Hybrid Engine; Downstream Sensor Marked 12615904	234-4242	-	234-4251	-
L4-2.4	2008	2nd Design; Downstream Sensor Marked 12617907	234-4242	-	234-4250	-
L4-2.4	2007	1st Design; Downstream Sensor Marked 12597947	234-4242	-	234-4294	-
L4-2.4	2007	2nd Design; Downstream Sensor Marked 12615904	234-4242	-	234-4251	-
V6-3.5	2008		234-4668 <sup>1</sup>	234-4212 <sup>1</sup>	234-4255 <sup>1</sup>	-
V6-3.5	2007		234-4668 <sup>4</sup>	234-4212 <sup>4</sup>	234-4651 <sup>4</sup>	234-4209 <sup>4</sup>
V6-3.5	2007		234-4668 <sup>5</sup>	234-4212 <sup>5</sup>	234-4647 <sup>5</sup>	234-4209 <sup>5</sup>
V6-3.6	2009-2008		234-4668 <sup>4</sup>	234-4212 <sup>4</sup>	234-4254 <sup>4</sup>	-
V6-3.6	2009-2008		234-4668 <sup>5</sup>	234-4212 <sup>5</sup>	234-4341 <sup>5</sup>	-
V6-3.6	2007		234-4668 <sup>5</sup>	234-4212 <sup>5</sup>	234-4286 <sup>5</sup>	-
V6-3.6	2007		234-4668 <sup>4</sup>	234-4212 <sup>4</sup>	234-4651 <sup>4</sup>	234-4209 <sup>4</sup>
<b>ION</b>						
L4-2.0	2007-2005		234-4646	234-4209	234-4066	234-4209
L4-2.0	2004		234-4646	234-4209	234-4235	234-4209
L4-2.2	2007		234-4668	234-4212	234-4066	234-4209
L4-2.2	2006-2005		234-4342	-	234-4066	234-4209
L4-2.2	2004-2003		234-4646	234-4209	234-4235	234-4209
L4-2.4	2007-2006		234-4342	-	234-4066	234-4209
<b>L100</b>						
L4-2.2	2002		234-4646	234-4209	234-4066	234-4209
L4-2.2	2001		234-2060	234-2000	234-4090	234-4000
<b>L200</b>						
L4-2.2	2003-2002		234-4646	234-4209	234-4066	234-4209
L4-2.2	2001		234-2060	234-2000	234-4090	234-4000
<b>L300</b>						
L4-2.2	2004		234-4646	234-4209	234-4066	234-4209
V6-3.0	2005-2001		234-5006 <sup>1</sup>	-	234-4822 <sup>1</sup>	-

<sup>1</sup> 2 Required / Requis 2 / Requeridos 2 <sup>4</sup> Left Side / Côté gauche / Lado izquierdo <sup>5</sup> Right Side / Côté droit / Lado derecho



ENGINE MOTEUR MOTOR	YEAR ANNEE AÑO	APPLICATION INFORMATION INFORMATION D'APPLICATION INFORMACION DE APLICACION	UPSTREAM / AVANT - C.C. / ANTES DEL C.C.		DOWNSTREAM / APRS - C.C. / DESPUES DEL C.C.	
			TYPE / TIPO O.E.	UNIVERS.	TYPE / TIPO O.E.	UNIVERS.
<b>SATURN [cont]</b>						
<b>LS</b>						
L4-2.2	2000		234-2060	234-2000	234-4090	234-4000
<b>LS1</b>						
L4-2.2	2000		234-2060	234-2000	234-4090	234-4000
<b>LS2</b>						
V6-3.0	2000		234-5006 <sup>1</sup>	-	234-4822 <sup>1</sup>	-
<b>LW1</b>						
L4-2.2	2000		234-2060	234-2000	234-4090	234-4000
<b>LW2</b>						
V6-3.0	2000		234-5006 <sup>1</sup>	-	234-4822 <sup>1</sup>	-
<b>LW200</b>						
L4-2.2	2003-2002		234-4646	234-4209	234-4066	234-4209
L4-2.2	2001		234-2060	234-2000	234-4090	234-4000
<b>LW300</b>						
V6-3.0	2003-2001		234-5006 <sup>1</sup>	-	234-4822 <sup>1</sup>	-
<b>OUTLOOK</b>						
V6-3.6	2010-2009		234-4815 <sup>1</sup>	-	234-4816 <sup>1</sup>	-
V6-3.6	2008-2007		234-4668 <sup>1</sup>	234-4212 <sup>1</sup>	234-4294 <sup>1</sup>	-
<b>RELAY</b>						
V6-3.5	2006-2005		234-4668	234-4212	234-4647	234-4209
V6-3.9	2007-2006		234-4668	234-4212	234-4647	234-4209
<b>SC</b>						
L4-1.9	1992-1991		234-1029	-	-	-
<b>SC1</b>						
L4-1.9	2002-2000		234-1022	234-1000	234-4066	234-4209
L4-1.9	1999-1996		234-1022	234-1000	234-4618	234-4000
L4-1.9	1995		234-1022	234-1000	-	-
L4-1.9	1994-1993		234-1029	-	-	-
<b>SC2</b>						
L4-1.9	2002-2000		234-1022	234-1000	234-4066	234-4209
L4-1.9	1999-1996		234-1022	234-1000	234-4618	234-4000
L4-1.9	1995		234-1022	234-1000	-	-
L4-1.9	1994	Calif.	234-1030	-	-	-
L4-1.9	1994	Exc. Calif.	234-1029	-	-	-
L4-1.9	1993		234-1029	-	-	-
<b>SKY</b>						
L4-2.0	2010-2009		234-5007	-	234-4245	-
L4-2.0	2008-2007	1st Design; w/ 15" Downstream Sensor	234-5007	-	234-4820	-
L4-2.0	2008-2007	2nd Design; w/ 37" Downstream Sensor	234-5007	-	234-4245	-
L4-2.4	2010-2008		234-4242	-	234-4251	-

<sup>1</sup> 2 Required / Requis 2 / Requeridos 2



ENGINE MOTEUR MOTOR	YEAR ANNEE AÑO	APPLICATION INFORMATION INFORMATION D'APPLICATION INFORMACION DE APLICACION	UPSTREAM / AVANT - C.C. / ANTES DEL C.C.		DOWNSTREAM / APRS - C.C. / DESPUES DEL C.C.	
			TYPE / TIPO O.E.	UNIVERS.	TYPE / TIPO O.E.	UNIVERS.
<b>SATURN [cont]</b>						
<b>SKY [cont]</b>						
L4-2.4	2007		234-4342	-	234-4289	-
<b>SL</b>						
L4-1.9	2002-2000		234-1022	234-1000	234-4066	234-4209
L4-1.9	1999-1996		234-1022	234-1000	234-4618	234-4000
L4-1.9	1995		234-1022	234-1000	-	-
L4-1.9	1994-1991		234-1029	-	-	-
<b>SL1</b>						
L4-1.9	2002-2000		234-1022	234-1000	234-4066	234-4209
L4-1.9	1999-1996		234-1022	234-1000	234-4618	234-4000
L4-1.9	1995		234-1022	234-1000	-	-
L4-1.9	1994-1991		234-1029	-	-	-
<b>SL2</b>						
L4-1.9	2002-2000		234-1022	234-1000	234-4066	234-4209
L4-1.9	1999-1996		234-1022	234-1000	234-4618	234-4000
L4-1.9	1995		234-1022	234-1000	-	-
L4-1.9	1994	Calif.	234-1030	-	-	-
L4-1.9	1994	Exc. Calif.	234-1029	-	-	-
L4-1.9	1993-1991		234-1029	-	-	-
<b>SW1</b>						
L4-1.9	1999-1996		234-1022	234-1000	234-4618	234-4000
L4-1.9	1995		234-1022	234-1000	-	-
L4-1.9	1994-1993		234-1029	-	-	-
<b>SW2</b>						
L4-1.9	2001-2000		234-1022	234-1000	234-4066	234-4209
L4-1.9	1999-1996		234-1022	234-1000	234-4618	234-4000
L4-1.9	1995		234-1022	234-1000	-	-
L4-1.9	1994	Calif.	234-1030	-	-	-
L4-1.9	1994	Exc. Calif.	234-1029	-	-	-
L4-1.9	1993		234-1029	-	-	-
<b>VUE</b>						
L4-2.2	2007-2006		234-4342	-	234-4066	234-4209
L4-2.2	2005-2004		234-4646	234-4209	234-4235	234-4209
L4-2.2	2003-2002		234-4646	234-4209	234-4066	234-4209
L4-2.4	2010		234-4242	-	234-4251	-
L4-2.4	2009-2008		234-4242	-	234-4294	-
L4-2.4	2007		234-4342	-	234-4066	234-4209
V6-3.0	2003-2002		234-4821 <sup>1</sup>	-	234-4821 <sup>1</sup>	-
V6-3.5	2010-2008		234-4668 <sup>1</sup>	234-4212 <sup>1</sup>	234-4255 <sup>1</sup>	-
V6-3.5	2007-2004		234-5010 <sup>1</sup>	-	234-4292 <sup>1</sup>	-
V6-3.6	2010		234-4668 <sup>1</sup>	234-4212 <sup>1</sup>	234-4251 <sup>1</sup>	-
V6-3.6	2009-2008		234-4668 <sup>1</sup>	234-4212 <sup>1</sup>	234-4294 <sup>1</sup>	-

<sup>1</sup> 2 Required / Requis 2 / Requeridos 2



ENGINE MOTEUR MOTOR	YEAR ANNEE AÑO	APPLICATION INFORMATION INFORMATION D'APPLICATION INFORMACION DE APLICACION	UPSTREAM / AVANT - C.C. / ANTES DEL C.C.		DOWNSTREAM / APRS - C.C. / DESPUES DEL C.C.	
			TYPE / TIPO O.E.	UNIVERS.	TYPE / TIPO O.E.	UNIVERS.
<b>SCION</b>						
<b>FR-S</b>						
H4-2.0	2016-2013		234-9136	-	234-4908	-
<b>IQ</b>						
L4-1.3	2015-2012		234-9112	-	234-4538	-
<b>TC</b>						
L4-2.4	2010-2005		234-9041	-	234-4149	234-4209
L4-2.5	2016-2014		234-9114	-	234-4909	-
L4-2.5	2013-2011		234-9114	-	234-4557	-
<b>XA</b>						
L4-1.5	2006-2004		234-4524	-	234-4069	234-4209
<b>XB</b>						
L4-1.5	2006-2004		234-4524	-	234-4069	234-4209
L4-2.4	2015-2011		234-9049	-	234-4168	234-4209
L4-2.4	2010-2008		234-9041	-	234-4168	234-4209
<b>XD</b>						
L4-1.8	2014-2010		234-9112	-	234-4623	234-4209
L4-1.8	2009-2008		234-9056	-	234-4623	234-4209
<b>SMART</b>						
<b>FORTWO</b>						
L3-1.0	2015-2008		234-5071	-	234-4881	-
<b>SRT</b>						
<b>VIPER</b>						
V10-8.4	2014-2013		234-4545 <sup>1</sup>	-	234-4579 <sup>1</sup>	-
<b>STERLING</b>						
<b>825</b>						
V6-2.5	1988-1987		234-1009 <sup>1</sup>	234-1000 <sup>1</sup>	-	-
<b>827</b>						
V6-2.7	1991-1989		234-1009 <sup>1</sup>	234-1000 <sup>1</sup>	-	-
<b>SUBARU</b>						
<b>B9 TRIBECA</b>						
H6-3.0	2007-2006		234-9047 <sup>1</sup>	-	234-4447 <sup>1</sup>	-
<b>BAJA</b>						
H4-2.5	2006-2004	Non-Turbo	234-9015	-	234-4132	234-4212
H4-2.5	2006-2004	Turbo	234-9121	-	234-4732	-
H4-2.5	2003		234-9015	-	234-4132	234-4212
<b>BRAT</b>						
H4-1.8	1987-1981		234-1011	234-1000	-	-

<sup>1</sup> 2 Required / Requis 2 / Requeridos 2





ENGINE MOTEUR MOTOR	YEAR ANNEE AÑO	APPLICATION INFORMATION INFORMATION D'APPLICATION INFORMACION DE APLICACION	UPSTREAM / AVANT - C.C. / ANTES DEL C.C.		DOWNSTREAM / APRS - C.C. / DESPUES DEL C.C.	
			TYPE / TIPO O.E.	UNIVERS.	TYPE / TIPO O.E.	UNIVERS.
<b>SUBARU [cont]</b>						
<b>BRZ</b>						
H4-2.0	2015-2013		234-9136	-	234-4908	-
<b>DL</b>						
H4-1.6	1984-1980		234-1011	234-1000	-	-
H4-1.8	1989-1988		234-1005	234-1000	-	-
H4-1.8	1987-1980		234-1011	234-1000	-	-
<b>FORESTER</b>						
H4-2.0	2015-2014		234-5178	-	234-4988	-
H4-2.5	2015-2014		234-9138	-	234-4513	-
H4-2.5	2013-2011	Non-Turbo	234-9109	-	234-4513	-
H4-2.5	2013-2011	Turbo	234-9108	-	234-4195	-
H4-2.5	2010-2009	Turbo	234-9120	-	234-4195	-
H4-2.5	2010-2006	Non-Turbo	234-9123	-	234-4445	-
H4-2.5	2008-2004	Turbo	234-9120	-	234-4732	-
H4-2.5	2005	Non-Turbo	234-9122	-	234-4732	-
H4-2.5	2004	Non-Turbo	234-9015	-	234-4706	234-4700
H4-2.5	2003		234-9015	-	234-4706	234-4700
H4-2.5	2002-2000		234-5003	-	234-4706	234-4700
H4-2.5	1999		234-3091	234-3090	234-4706	234-4700
H4-2.5	1998		234-3091	234-3090	234-3088	234-3090
<b>GL</b>						
H4-1.6	1987-1986		234-1011	234-1000	-	-
H4-1.6	1980		234-1011	234-1000	-	-
H4-1.8	1989-1988	Carbureted	234-1011	234-1000	-	-
H4-1.8	1989-1988	Fuel Injected; Non-Turbo	234-1005	234-1000	-	-
H4-1.8	1989-1988	Fuel Injected; Turbo; Calif.	234-3201	-	-	-
H4-1.8	1989-1988	Fuel Injected; Turbo; Exc. Calif.	234-1005	234-1000	-	-
H4-1.8	1987-1980		234-1011	234-1000	-	-
<b>GL-10</b>						
H4-1.8	1989-1988	Non-Turbo	234-1005	234-1000	-	-
H4-1.8	1989-1988	Turbo; Calif.	234-3201	-	-	-
H4-1.8	1989-1988	Turbo; Exc. Calif.	234-1005	234-1000	-	-
H4-1.8	1987-1985		234-1011	234-1000	-	-
<b>GLF</b>						
H4-1.6	1980		234-1011	234-1000	-	-
H4-1.8	1982-1980		234-1011	234-1000	-	-
<b>IMPREZA</b>						
H4-1.8	1997-1996		234-3088	234-3090	234-3088	234-3090
H4-1.8	1995-1993		234-3083	234-3090	-	-
H4-2.0	2015		234-9138	-	234-4513	-
H4-2.0	2014-2012		234-9109	-	234-4513	-



ENGINE MOTEUR MOTOR	YEAR ANNEE AÑO	APPLICATION INFORMATION INFORMATION D'APPLICATION INFORMACION DE APLICACION	UPSTREAM / AVANT - C.C. / ANTES DEL C.C.		DOWNSTREAM / APRES - C.C. / DESPUES DEL C.C.	
			TYPE / TIPO O.E.	UNIVERS.	TYPE / TIPO O.E.	UNIVERS.
<b>SUBARU [cont]</b>						
<b>IMPREZA [cont]</b>						
H4-2.0	2005-2003		234-9011	-	234-4732	-
H4-2.0	2002	Auto Trans	234-9011	-	234-4732	-
H4-2.0	2002	Manual Trans	234-9011	-	234-4446	-
H4-2.2	2001-2000		234-9018	-	234-4736	-
H4-2.2	1999	Calif.	234-9018	-	234-4736	-
H4-2.2	1999	Canada & Exc. Calif.	234-3091	234-3090	234-4706	234-4700
H4-2.2	1998		234-3091	234-3090	234-3088	234-3090
H4-2.2	1997-1995		234-3088	234-3090	234-3088	234-3090
H4-2.5	2014	EJ255 Engine	234-9108	-	234-4195	-
H4-2.5	2014	EJ257 Engine	234-9034	-	234-4732	-
H4-2.5	2013	EJ255 Engine; Exc. STI Model	234-9108	-	234-4195	-
H4-2.5	2013	EJ257 Engine; STI Model	234-9034	-	234-4732	-
H4-2.5	2012-2011	Turbo; EJ255 Engine; Exc. STI	234-9108	-	234-4195	-
H4-2.5	2012-2008	Turbo; EJ257 Engine; STi	234-9034	-	234-4732	-
H4-2.5	2011-2006	Non-Turbo	234-9123	-	234-4445	-
H4-2.5	2010	Turbo; EJ255 Engine; Exc. WRX Limited Model	234-9035	-	234-4195	-
H4-2.5	2010	Turbo; EJ255 Engine; WRX Limited Model	234-9108	-	234-4195	-
H4-2.5	2009	Turbo; EJ255 Engine; Exc. STI	234-9035	-	234-4195	-
H4-2.5	2008	Turbo; EJ255 Engine; Exc. STI	234-9120	-	234-4195	-
H4-2.5	2007-2004	Turbo	234-9120	-	234-4732	-
H4-2.5	2005	Non-Turbo	234-9122	-	234-4732	-
H4-2.5	2004	Non-Turbo	234-9015	-	234-4706	234-4700
H4-2.5	2003		234-9015	-	234-4706	234-4700
H4-2.5	2002-2000		234-5003	-	234-4706	234-4700
H4-2.5	1999		234-3091	234-3090	234-4706	234-4700
H4-2.5	1998		234-3091	234-3090	234-3088	234-3090
<b>JUSTY</b>						
L3-1.2	1995-1989		234-1016	234-1000	-	-
L3-1.2	1988		234-1005	234-1000	-	-
L3-1.2	1987		234-1011	234-1000	-	-
<b>LEGACY</b>						
H4-2.2	1999	Calif.	234-9018	-	234-4736	-
H4-2.2	1999	Exc. Calif.	234-3091	234-3090	234-4132	234-4212
H4-2.2	1998-1996		234-3091	234-3090	234-3088	234-3090
H4-2.2	1995		234-3088	234-3090	234-3088	234-3090
H4-2.2	1994-1991	Non-Turbo	234-3083	234-3090	-	-
H4-2.2	1994-1991	Turbo	234-3202	234-3090	-	-
H4-2.2	1990		234-3083	234-3090	-	-
H4-2.5	2015		234-9138	-	234-4907	-
H4-2.5	2014-2013		234-9136	-	234-4907	-
H4-2.5	2012-2010	Non-Turbo	234-9097	-	234-4445	-



ENGINE MOTEUR MOTOR	YEAR ANNEE AÑO	APPLICATION INFORMATION INFORMATION D'APPLICATION INFORMACION DE APLICACION	UPSTREAM / AVANT - C.C. / ANTES DEL C.C.		DOWNSTREAM / APRS - C.C. / DESPUES DEL C.C.	
			TYPE / TIPO O.E.	UNIVERS.	TYPE / TIPO O.E.	UNIVERS.
<b>SUBARU [cont]</b>						
<b>LEGACY [cont]</b>						
H4-2.5	2012-2010	Turbo	234-9098	-	234-4732	-
H4-2.5	2009-2008	Turbo; Exc. GT Spec. B; Auto Trans	234-9035	-	234-4732	-
H4-2.5	2009-2008	Turbo; Exc. GT Spec. B; Manual Trans	234-9035	-	234-4446	-
H4-2.5	2009-2008	Turbo; GT Spec. B	234-9035	-	234-4732	-
H4-2.5	2009-2006	Non-Turbo	234-9123	-	234-4445	-
H4-2.5	2007	Turbo; GT Limited; Auto Trans	234-9120	-	234-4732	-
H4-2.5	2007	Turbo; GT Limited; Manual Trans	234-9120	-	234-4446	-
H4-2.5	2007	Turbo; GT Spec. B	234-9120	-	234-4732	-
H4-2.5	2006-2005	Turbo; Auto Trans	234-9120	-	234-4732	-
H4-2.5	2006-2005	Turbo; Manual Trans	234-9120	-	234-4446	-
H4-2.5	2005	Non-Turbo; Calif	-	-	234-4446 <sup>1,12</sup>	-
H4-2.5	2005	Non-Turbo; Calif.	234-9122 <sup>1</sup>	-	234-4732	-
H4-2.5	2005	Non-Turbo; Exc. Calif.	234-9122	-	234-4732	-
H4-2.5	2004	Calif.	234-9122 <sup>1</sup>	-	234-4732	-
H4-2.5	2004	Calif.; Loc. Center	-	-	234-4446 <sup>1,12</sup>	-
H4-2.5	2004	Exc. Calif. & Canada	234-9015	-	234-4132	234-4212
H4-2.5	2003		234-9015	-	234-4132	234-4212
H4-2.5	2002		234-5003	-	234-4132	234-4212
H4-2.5	2001-2000	Auto Trans	234-5003	-	234-4132	234-4212
H4-2.5	2001-2000	Manual Trans	234-9018	-	234-4736	-
H4-2.5	1999		234-3091	234-3090	234-4132	234-4212
H4-2.5	1998-1996		234-3091	234-3090	234-3088	234-3090
H6-3.0	2009-2008		234-9047 <sup>1</sup>	-	234-4447 <sup>1</sup>	-
H6-3.6	2015		234-9139 <sup>4</sup>	-	234-4195 <sup>4</sup>	-
H6-3.6	2015		234-9139 <sup>5</sup>	-	234-4989 <sup>5</sup>	-
H6-3.6	2014-2010		234-9092 <sup>1</sup>	-	234-4447 <sup>1</sup>	-
<b>LOYALE</b>						
H4-1.8	1994-1991		234-1005	234-1000	-	-
H4-1.8	1990	Non-Turbo	234-1005	234-1000	-	-
H4-1.8	1990	Turbo; Calif.	234-3201	-	-	-
H4-1.8	1990	Turbo; Exc. Calif.	234-1005	234-1000	-	-
<b>OUTBACK</b>						
H4-2.5	2015		234-9138	-	234-4907	-
H4-2.5	2014-2013		234-9136	-	234-4907	-
H4-2.5	2012-2010		234-9097	-	234-4445	-
H4-2.5	2009-2008	Turbo; Auto Trans	234-9035	-	234-4732	-
H4-2.5	2009-2008	Turbo; Manual Trans	234-9035	-	234-4446	-
H4-2.5	2009-2006	Non-Turbo	234-9123	-	234-4445	-
H4-2.5	2007-2005	Turbo; Auto Trans	234-9120	-	234-4732	-
H4-2.5	2007-2005	Turbo; Manual Trans	234-9120	-	234-4446	-
H4-2.5	2005	Non-Turbo; Calif	-	-	234-4446 <sup>1,12</sup>	-

<sup>1</sup> 2 Required / Requis 2 / Requeridos 2 <sup>4</sup> Left Side / Côté gauche / Lado izquierdo <sup>5</sup> Right Side / Côté droit / Lado derecho <sup>12</sup> Loc. Center / Empl. central / Ubicación central



ENGINE MOTEUR MOTOR	YEAR ANNEE AÑO	APPLICATION INFORMATION INFORMATION D'APPLICATION INFORMACION DE APLICACION	UPSTREAM / AVANT - C.C. / ANTES DEL C.C.		DOWNSTREAM / APRS - C.C. / DESPUES DEL C.C.	
			TYPE / TIPO O.E.	UNIVERS.	TYPE / TIPO O.E.	UNIVERS.
<b>SUBARU [cont]</b>						
<b>OUTBACK [cont]</b>						
H4-2.5	2005	Non-Turbo; Calif.	234-9122 <sup>1</sup>	-	234-4732	-
H4-2.5	2005	Non-Turbo; Exc. Calif.	234-9122	-	234-4732	-
H4-2.5	2004	Calif.	234-9122 <sup>1</sup>	-	234-4732	-
H4-2.5	2004	Calif.; Loc. Center	-	-	234-4446 <sup>1,12</sup>	-
H4-2.5	2004	Exc. Calif. & Canada	234-9015	-	234-4132	234-4212
H4-2.5	2003		234-9015	-	234-4132	234-4212
H4-2.5	2002		234-5003	-	234-4132	234-4212
H4-2.5	2001-2000	Auto Trans	234-5003	-	234-4132	234-4212
H4-2.5	2001-2000	Manual Trans	234-9018	-	234-4736	-
H6-3.0	2009-2005		234-9047 <sup>1</sup>	-	234-4447 <sup>1</sup>	-
H6-3.0	2004-2001		234-9010 <sup>1</sup>	-	234-4732	-
H6-3.6	2014-2010		234-9092 <sup>1</sup>	-	234-4447 <sup>1</sup>	-
<b>RX</b>						
H4-1.8	1989-1988	Calif.	234-3201	-	-	-
H4-1.8	1989-1988	Exc. Calif.	234-1005	234-1000	-	-
H4-1.8	1987-1985		234-1011	234-1000	-	-
<b>STANDARD</b>						
H4-1.6	1987-1980		234-1011	234-1000	-	-
H4-1.8	1987		234-1011	234-1000	-	-
H4-1.8	1982-1981		234-1011	234-1000	-	-
<b>SVX</b>						
H6-3.3	1997-1996		234-3083 <sup>1</sup>	234-3090 <sup>1</sup>	234-3083	234-3090
H6-3.3	1995-1992		234-3083 <sup>1</sup>	234-3090 <sup>1</sup>	-	-
<b>TRIBECA</b>						
H6-3.6	2014-2010		234-9092 <sup>1</sup>	-	234-4447 <sup>1</sup>	-
H6-3.6	2009-2008		234-9047 <sup>1</sup>	-	234-4447 <sup>1</sup>	-
<b>WRX</b>						
H4-2.0	2015		234-5178	-	234-4988	-
H4-2.5	2014-2013		234-9108	-	234-4195	-
<b>WRX STI</b>						
H4-2.5	2015-2013		234-9034	-	234-4732	-
<b>XT</b>						
H4-1.8	1991-1988		234-1005	234-1000	-	-
H4-1.8	1987-1985		234-1011	234-1000	-	-
H6-2.7	1991-1988		234-1005	234-1000	-	-
<b>XV CROSSTREK</b>						
H4-2.0	2015		234-9138	-	234-4513	-
H4-2.0	2014	Gas Engine	234-9109	-	234-4513	-
H4-2.0	2014	Hybrid Engine	234-9138	-	234-4513	-
H4-2.0	2013		234-9109	-	234-4513	-

<sup>1</sup> 2 Required / Requis 2 / Requeridos 2 <sup>12</sup> Loc. Center / Empl. central / Ubicación central



ENGINE MOTEUR MOTOR	YEAR ANNEE AÑO	APPLICATION INFORMATION INFORMATION D'APPLICATION INFORMACION DE APLICACION	UPSTREAM / AVANT - C.C. / ANTES DEL C.C.		DOWNSTREAM / APRES - C.C. / DESPUES DEL C.C.	
			TYPE / TIPO O.E.	UNIVERS.	TYPE / TIPO O.E.	UNIVERS.
<b>SUZUKI</b>						
<b>AERIO</b>						
L4-2.0	2003-2002		234-4105	-	234-4225	234-4212
L4-2.3	2007-2004		234-4105	-	234-4225	234-4212
<b>EQUATOR</b>						
L4-2.5	2012-2010		234-9038	-	234-4297	-
L4-2.5	2009		234-5062	-	234-4297	-
V6-4.0	2012-2011		234-9036 <sup>4</sup>	-	234-4313 <sup>4</sup>	-
V6-4.0	2012-2011		234-9036 <sup>5</sup>	-	234-4297 <sup>5</sup>	-
V6-4.0	2010-2009		234-9038 <sup>4</sup>	-	234-4297 <sup>4</sup>	-
V6-4.0	2010-2009		234-9038 <sup>5</sup>	-	234-4313 <sup>5</sup>	-
<b>ESTEEM</b>						
L4-1.6	2001		234-4227	-	234-4387	-
L4-1.6	2000-1996		234-4060	234-4209	234-4234	234-4209
L4-1.6	1995		234-4060	234-4209	-	-
L4-1.8	2002-2001	5 Door	234-4387	-	234-4227	-
L4-1.8	2002-2000	4 Door	234-4060	234-4209	234-4234	234-4209
L4-1.8	2000	5 Door	234-4105	-	234-4424	-
L4-1.8	1999		234-4060	234-4209	234-4234	234-4209
<b>FORENZA</b>						
L4-2.0	2008-2006		234-4725	-	234-4423	-
L4-2.0	2005-2004		234-4117	-	234-4427	-
<b>FORSA</b>						
L3-1.0	1988-1987		234-1001	234-1000	-	-
L3-1.0	1986-1985		234-1009	234-1000	-	-
<b>GRAND VITARA</b>						
L4-2.4	2013-2009		234-9299	-	234-4300	-
V6-2.5	2005-2001		234-4105 <sup>1</sup>	-	234-4080 <sup>1</sup>	234-4210 <sup>1</sup>
V6-2.5	2000-1999		234-4105 <sup>1</sup>	-	234-4033 <sup>1</sup>	234-4210 <sup>1</sup>
V6-2.7	2008-2007		234-9031 <sup>1</sup>	-	234-4387 <sup>1</sup>	-
V6-2.7	2006		234-9032 <sup>1</sup>	-	234-4387 <sup>1</sup>	-
V6-2.7	2001		234-4084 <sup>1</sup>	234-4210 <sup>1</sup>	234-4222 <sup>1</sup>	234-4209 <sup>1</sup>
V6-3.2	2010-2009		234-4303 <sup>1</sup>	-	234-4304 <sup>1</sup>	-
<b>KIZASHI</b>						
L4-2.4	2013-2010		234-9099	-	234-4303	-
<b>RENO</b>						
L4-2.0	2008-2006		234-4725	-	234-4423	-
L4-2.0	2005		234-4117	-	234-4427	-
<b>SA310</b>						
L3-1.0	1985		234-1009	234-1000	-	-

<sup>1</sup> 2 Required / Requis 2 / Requeridos 2 <sup>4</sup> Left Side / Côté gauche / Lado izquierdo <sup>5</sup> Right Side / Côté droit / Lado derecho



ENGINE MOTEUR MOTOR	YEAR ANNEE AÑO	APPLICATION INFORMATION INFORMATION D'APPLICATION INFORMACION DE APLICACION	UPSTREAM / AVANT - C.C. / ANTES DEL C.C.		DOWNSTREAM / APRES - C.C. / DESPUES DEL C.C.	
			TYPE / TIPO O.E.	UNIVERS.	TYPE / TIPO O.E.	UNIVERS.
<b>SUZUKI [cont]</b>						
<b>SAMURAI</b>						
L4-1.3	1995-1985		234-1009	234-1000	-	-
<b>SIDEKICK</b>						
L4-1.3	1989		234-1009	234-1000	-	-
L4-1.6	1998-1996		234-4060	234-4209	234-4649	234-4209
L4-1.6	1995-1994	Calif.	234-4060	234-4209	-	-
L4-1.6	1995-1994	Exc. Calif.	234-3014	234-3000	-	-
L4-1.6	1993-1992	Convertible	234-3014	234-3000	-	-
L4-1.6	1993-1992	Hardtop	234-4060	234-4209	-	-
L4-1.6	1991		234-3014	234-3000	-	-
L4-1.6	1990-1989		234-1009	234-1000	-	-
L4-1.8	1998-1996		234-4031	234-4210	234-4226	234-4210
<b>SJ413</b>						
L4-1.3	1985		234-1009	234-1000	-	-
<b>SWIFT</b>						
L3-1.0	1994	Calif.	234-4049	234-4209	-	-
L3-1.0	1994	Exc. Calif.	234-1001	234-1000	-	-
L3-1.0	1993-1992		234-1001	234-1000	-	-
L4-1.3	2001-1996		234-4049	234-4209	234-4648	234-4209
L4-1.3	1995		234-4049	234-4209	-	-
L4-1.3	1994-1989		234-1001	234-1000	-	-
L4-1.6	1993-1992		234-1001	234-1000	-	-
<b>SWIFT+</b>						
L4-1.6	2009		234-4293	-	234-4298	-
L4-1.6	2008-2006		234-4293	-	234-4288	-
L4-1.6	2005-2004		234-4284	-	234-4284	-
<b>SX4</b>						
L4-2.0	2013-2010		234-9099	-	234-4165	-
L4-2.0	2009-2008		234-9033	-	234-4165	-
L4-2.0	2007		234-9033	-	234-4388	-
<b>SX4 CROSSOVER</b>						
L4-2.0	2012		234-9099	-	234-4165	-
<b>VERONA</b>						
L6-2.5	2006	w/ 14" Downstream Sensor	234-4420 <sup>1</sup>	-	234-4426 <sup>1</sup>	-
L6-2.5	2006	w/ 19" Downstream Sensor	234-4420 <sup>1</sup>	-	234-4425 <sup>1</sup>	-
L6-2.5	2005-2004		234-4422 <sup>1</sup>	-	234-4421 <sup>1</sup>	-
<b>VITARA</b>						
L4-1.6	2002-2001		234-4731	-	234-4222	234-4209
L4-1.6	2000-1999	Calif.	234-4084	234-4210	234-4648	234-4209
L4-1.6	2000-1999	Exc. Calif.	234-4049	234-4209	234-4649	234-4209
L4-2.0	2003-2001		234-4731	-	234-4222	234-4209

<sup>1</sup> 2 Required / Requis 2 / Requeridos 2



ENGINE MOTEUR MOTOR	YEAR ANNEE AÑO	APPLICATION INFORMATION INFORMATION D'APPLICATION INFORMACION DE APLICACION	UPSTREAM / AVANT - C.C. / ANTES DEL C.C.		DOWNSTREAM / APRS - C.C. / DESPUES DEL C.C.	
			TYPE / TIPO O.E.	UNIVERS.	TYPE / TIPO O.E.	UNIVERS.
<b>SUZUKI [cont]</b>						
<b>VITARA [cont]</b>						
L4-2.0	2000-1999	Calif.	234-4084	234-4210	234-4648	234-4209
L4-2.0	2000-1999	Exc. Calif.	234-4049	234-4209	234-4649	234-4209
V6-2.5	2004		234-4105 <sup>1</sup>	-	234-4080 <sup>1</sup>	234-4210 <sup>1</sup>
<b>X-90</b>						
L4-1.6	1998-1996		234-4060	234-4209	234-4649	234-4209
<b>XL-7</b>						
V6-2.7	2006-2002		234-4084 <sup>1</sup>	234-4210 <sup>1</sup>	234-4222 <sup>1</sup>	234-4209 <sup>1</sup>
V6-3.6	2009-2007		234-4819 <sup>1</sup>	-	234-4840 <sup>1</sup>	-
<b>TOYOTA</b>						
<b>4RUNNER</b>						
L4-2.4	1995-1993	Calif.	234-4151	234-4050	234-4154	234-4206
L4-2.4	1995-1993	Exc. Calif.	234-4052	234-4050	-	-
L4-2.4	1992	Calif.	234-4160	234-4050	-	-
L4-2.4	1992	Exc. Calif.	234-4072	234-4050	-	-
L4-2.4	1991-1990		234-4056	234-4050	-	-
L4-2.4	1989		234-4152	234-4050	-	-
L4-2.4	1988	Non-Turbo	234-4152	234-4050	-	-
L4-2.4	1988	Turbo	234-1056	234-1057	-	-
L4-2.4	1987-1985		234-1056	234-1057	-	-
L4-2.4	1984		234-1051	234-1057	-	-
L4-2.7	2010	4WD	234-9022	-	234-4064	234-4209
L4-2.7	2010	RWD	234-9022	-	234-4169	234-4209
L4-2.7	2000-1999	Calif.; Auto Trans; 4WD	234-9002	-	234-4154	234-4206
L4-2.7	2000-1999	Calif.; Auto Trans; RWD	234-9002	-	234-4622	234-4209
L4-2.7	2000-1999	Exc. Calif.; 4WD	234-4162	234-4206	234-4154	234-4206
L4-2.7	2000-1999	Exc. Calif.; RWD	234-4162	234-4206	234-4162	234-4206
L4-2.7	2000	Calif.; Manual Trans	234-9001	-	234-4622	234-4209
L4-2.7	1999	Calif.; Manual Trans	234-9003	-	234-4622	234-4209
L4-2.7	1998-1996	4WD	234-4162	234-4206	234-4154	234-4206
L4-2.7	1998-1996	RWD	234-4162	234-4206	234-4153	234-4206
V6-3.0	1995-1994	Calif.	234-4052	234-4050	234-4161	234-4206
V6-3.0	1995-1994	Exc. Calif.	234-4052	234-4050	-	-
V6-3.0	1993-1992		234-4052	234-4050	-	-
V6-3.0	1991-1990		234-4055	234-4050	-	-
V6-3.0	1989-1988		234-4152	234-4050	-	-
V6-3.4	2002-2001		234-9002	-	234-4261	234-4209
V6-3.4	2000-1999	4WD; Calif.; Auto Trans	234-9002	-	234-4153	234-4206
V6-3.4	2000-1999	4WD; Calif.; Manual Trans	234-9003	-	234-4153	234-4206
V6-3.4	2000-1999	4WD; Exc. Calif.; Auto Trans	234-4162	234-4206	234-4162	234-4206
V6-3.4	2000-1999	4WD; Exc. Calif.; Manual Trans	234-4161	234-4206	234-4154	234-4206

<sup>1</sup> 2 Required / Requis 2 / Requeridos 2



ENGINE MOTEUR MOTOR	YEAR ANNEE AÑO	APPLICATION INFORMATION INFORMATION D'APPLICATION INFORMACION DE APLICACION	UPSTREAM / AVANT - C.C. / ANTES DEL C.C.		DOWNSTREAM / APRES - C.C. / DESPUES DEL C.C.	
			TYPE / TIPO O.E.	UNIVERS.	TYPE / TIPO O.E.	UNIVERS.
<b>TOYOTA [cont]</b>						
<b>4RUNNER [cont]</b>						
V6-3.4	2000-1999	RWD; Calif.	234-9002	-	234-4155	234-4206
V6-3.4	2000-1999	RWD; Exc. Calif.	234-4162	234-4206	234-4162	234-4206
V6-3.4	1998-1996	Auto Trans; 4WD	234-4162	234-4206	234-4154	234-4206
V6-3.4	1998-1996	Auto Trans; RWD	234-4162	234-4206	234-4153	234-4206
V6-3.4	1998-1996	Manual Trans; 4WD	234-4161	234-4206	234-4154	234-4206
V6-3.4	1998-1996	Manual Trans; RWD	234-4161	234-4206	234-4153	234-4206
V6-4.0	2016-2015		234-9143 <sup>4</sup>	-	234-4758 <sup>4</sup>	-
V6-4.0	2016-2015		234-9143 <sup>5</sup>	-	234-4931 <sup>5</sup>	-
V6-4.0	2014-2013		234-9144 <sup>4</sup>	-	234-4758 <sup>4</sup>	-
V6-4.0	2014-2013		234-9144 <sup>5</sup>	-	234-4931 <sup>5</sup>	-
V6-4.0	2012-2010		234-9101 <sup>4</sup>	-	234-4260 <sup>4</sup>	234-4209 <sup>4</sup>
V6-4.0	2012-2010		234-9101 <sup>5</sup>	-	234-4138 <sup>5</sup>	234-4209 <sup>5</sup>
V6-4.0	2009-2008		234-9026 <sup>1</sup>	-	234-4260 <sup>1</sup>	234-4209 <sup>1</sup>
V6-4.0	2007	From 06/07	234-9026 <sup>1</sup>	-	234-4260 <sup>1</sup>	234-4209 <sup>1</sup>
V6-4.0	2007	To 06/07	234-9051 <sup>1</sup>	-	234-4260 <sup>1</sup>	234-4209 <sup>1</sup>
V6-4.0	2006-2005		234-9051 <sup>4</sup>	-	234-4261 <sup>4</sup>	234-4209 <sup>4</sup>
V6-4.0	2006-2005		234-9051 <sup>5</sup>	-	234-4260 <sup>5</sup>	234-4209 <sup>5</sup>
V6-4.0	2004-2003		234-9047 <sup>4</sup>	-	234-4804 <sup>4</sup>	-
V6-4.0	2004-2003		234-9047 <sup>5</sup>	-	234-4805 <sup>5</sup>	-
V8-4.7	2009-2005		234-9051 <sup>1</sup>	-	234-4261 <sup>1</sup>	234-4209 <sup>1</sup>
V8-4.7	2004-2003		234-4138 <sup>4</sup>	234-4209 <sup>4</sup>	234-4261 <sup>4</sup>	234-4209 <sup>4</sup>
V8-4.7	2004-2003		234-4138 <sup>5</sup>	234-4209 <sup>5</sup>	234-4260 <sup>5</sup>	234-4209 <sup>5</sup>
<b>AVALON</b>						
L4-2.5	2016-2013		234-9128	-	234-4757	-
V6-3.0	2004-2000		234-9021 <sup>1</sup>	-	234-4061	234-4209
V6-3.0	1999-1997	Calif.	234-9009 <sup>4</sup>	-	234-4061	234-4209
V6-3.0	1999-1997	Calif.	234-9007 <sup>5</sup>	-	-	-
V6-3.0	1999-1997	Exc. Calif.	234-4622 <sup>1</sup>	234-4209 <sup>1</sup>	234-4061	234-4209
V6-3.0	1996-1995		234-4622 <sup>1</sup>	234-4209 <sup>1</sup>	234-4061	234-4209
V6-3.5	2016-2015		234-9154 <sup>4</sup>	-	234-4927 <sup>4</sup>	-
V6-3.5	2016-2015		234-9155 <sup>5</sup>	-	234-4925 <sup>5</sup>	-
V6-3.5	2014-2012		234-9128 <sup>4</sup>	-	234-4260 <sup>4</sup>	234-4209 <sup>4</sup>
V6-3.5	2014-2012		234-9128 <sup>5</sup>	-	234-4064 <sup>5</sup>	234-4209 <sup>5</sup>
V6-3.5	2011-2008		234-9008 <sup>4</sup>	-	234-4260 <sup>4</sup>	234-4209 <sup>4</sup>
V6-3.5	2011-2008		234-9022 <sup>5</sup>	-	234-4064 <sup>5</sup>	234-4209 <sup>5</sup>
V6-3.5	2007-2006		234-9041 <sup>4</sup>	-	234-4260 <sup>4</sup>	234-4209 <sup>4</sup>
V6-3.5	2007-2006		234-9050 <sup>5</sup>	-	234-4064 <sup>5</sup>	234-4209 <sup>5</sup>
V6-3.5	2005		234-9041 <sup>4</sup>	-	234-4064 <sup>4</sup>	234-4209 <sup>4</sup>
V6-3.5	2005		234-9050 <sup>5</sup>	-	234-4260 <sup>5</sup>	234-4209 <sup>5</sup>

<sup>1</sup> 2 Required / Requis 2 / Requeridos 2 <sup>4</sup> Left Side / Côté gauche / Lado izquierdo <sup>5</sup> Right Side / Côté droit / Lado derecho





ENGINE MOTEUR MOTOR	YEAR ANNEE AÑO	APPLICATION INFORMATION INFORMATION D'APPLICATION INFORMACION DE APLICACION	UPSTREAM / AVANT - C.C. / ANTES DEL C.C.		DOWNSTREAM / APRES - C.C. / DESPUES DEL C.C.	
			TYPE / TIPO O.E.	UNIVERS.	TYPE / TIPO O.E.	UNIVERS.
<b>TOYOTA [cont]</b>						
<b>CAMRY</b>						
L4-2.0	1991-1990	4WD	234-1051	234-1057	-	-
L4-2.0	1991-1990	FWD; Calif.; Flange Type	234-1051	234-1057	-	-
L4-2.0	1991-1990	FWD; Calif.; Screw Type	234-2009	234-2000	-	-
L4-2.0	1991-1990	FWD; Exc. Calif.	234-1051	234-1057	-	-
L4-2.0	1989-1987		234-1051	234-1057	-	-
L4-2.0	1986-1983		234-1058	-	-	-
L4-2.2	2001-2000	CNG Engine	234-9010	-	234-4137	234-4209
L4-2.2	2001-2000	Gas Engine; Calif.	234-9010	-	234-4137	234-4209
L4-2.2	2001-2000	Gas Engine; Exc. Calif.	234-4626	234-4209	234-4137	234-4209
L4-2.2	1999-1997	Calif.	234-9024	-	234-4137	234-4209
L4-2.2	1999-1997	Exc. Calif.	234-4626	234-4209	234-4137	234-4209
L4-2.2	1996		234-2058	234-2050	234-2008	234-2000
L4-2.2	1995-1994		234-1053	234-1057	234-2008	234-2000
L4-2.2	1993-1992	Calif.	234-1053	234-1057	234-2008	234-2000
L4-2.2	1993-1992	Exc. Calif.	234-1055	234-1057	-	-
L4-2.4	2011-2010		234-9041	-	234-4622	234-4209
L4-2.4	2009-2008	Gas Engine; Auto Trans; Calif.	234-9049	-	234-4622	234-4209
L4-2.4	2009-2008	Gas Engine; Auto Trans; Exc. Calif.	234-9049	-	234-4260	234-4209
L4-2.4	2009-2008	Gas Engine; Manual Trans	234-9049	-	234-4260	234-4209
L4-2.4	2009-2007	Hybrid Engine	234-9041	-	234-4622	234-4209
L4-2.4	2007	Gas Engine; Auto Trans; Calif.	234-9041	-	234-4622	234-4209
L4-2.4	2007	Gas Engine; Auto Trans; Exc. Calif.	234-9041	-	234-4260	234-4209
L4-2.4	2007	Gas Engine; Manual Trans	234-9041	-	234-4260	234-4209
L4-2.4	2006-2004	Exc. Calif.; Japan Built	234-9041 <sup>11</sup>	-	234-4603	234-4209
L4-2.4	2006-2004	Exc. Calif.; Japan Built; Loc. Center	234-4624 <sup>12</sup>	234-4209 <sup>12</sup>	-	-
L4-2.4	2006-2004	Exc. Calif.; USA Built	234-9041 <sup>11</sup>	-	234-4603	234-4209
L4-2.4	2006-2004	Exc. Calif.; USA Built; Loc. Center	234-4622 <sup>12</sup>	234-4209 <sup>12</sup>	-	-
L4-2.4	2006-2003	Calif.	234-9041 <sup>11</sup>	-	234-4603	234-4209
L4-2.4	2006-2003	Calif.; Loc. Center	234-4624 <sup>12</sup>	234-4209 <sup>12</sup>	-	-
L4-2.4	2003	Exc. Calif.	234-9010 <sup>11</sup>	-	234-4149	234-4209
L4-2.4	2002		234-9010	-	234-4149	234-4209
L4-2.5	2016-2012		234-9128	-	234-4757	-
L4-2.5	2011-2010		234-9089	-	234-4622	234-4209
V6-2.5	1991-1990	Calif.	234-2069	234-2000	-	-
V6-2.5	1991-1988	Exc. Calif.	234-4051	234-4050	-	-
V6-2.5	1989-1988	Calif.	234-2005	234-2000	-	-
V6-3.0	2006-2002		234-9042 <sup>15</sup>	-	234-4261 <sup>15</sup>	234-4209 <sup>15</sup>
V6-3.0	2006-2002		234-9047 <sup>16</sup>	-	234-4064 <sup>16</sup>	234-4209 <sup>16</sup>
V6-3.0	2001	Auto Trans	234-9021 <sup>1</sup>	-	234-4137	234-4209
V6-3.0	2001	Manual Trans	234-4622 <sup>1</sup>	234-4209 <sup>1</sup>	234-4137	234-4209

<sup>1</sup> 2 Required / Requis 2 / Requeridos 2 <sup>11</sup> Loc. Manifold / Empl. collecteur / Ubicación collector <sup>12</sup> Loc. Center / Empl. central / Ubicación central <sup>15</sup> Front / Avant / Parte delantera <sup>16</sup> Rear / Arrière / Parte trasera



ENGINE MOTEUR MOTOR	YEAR ANNEE AÑO	APPLICATION INFORMATION INFORMATION D'APPLICATION INFORMACION DE APLICACION	UPSTREAM / AVANT - C.C. / ANTES DEL C.C.		DOWNSTREAM / APRES - C.C. / DESPUES DEL C.C.	
			TYPE / TIPO O.E.	UNIVERS.	TYPE / TIPO O.E.	UNIVERS.
<b>TOYOTA [cont]</b>						
<b>CAMRY [cont]</b>						
V6-3.0	2000-1998	Calif.	234-9009 <sup>15</sup>	-	234-4137	234-4209
V6-3.0	2000-1998	Calif.	234-9007 <sup>16</sup>	-	-	-
V6-3.0	2000-1998	Exc. Calif.	234-4622 <sup>1</sup>	234-4209 <sup>1</sup>	234-4137	234-4209
V6-3.0	1997		234-4622 <sup>1</sup>	234-4209 <sup>1</sup>	234-4137	234-4209
V6-3.0	1996-1994		234-4622 <sup>1</sup>	234-4209 <sup>1</sup>	234-4623	234-4209
V6-3.0	1993-1992	Calif.	234-1053 <sup>1</sup>	234-1057 <sup>1</sup>	234-4623	234-4209
V6-3.0	1993-1992	Exc. Calif.	234-1053 <sup>1</sup>	234-1057 <sup>1</sup>	-	-
V6-3.3	2006-2004		234-9042 <sup>15</sup>	-	234-4261 <sup>15</sup>	234-4209 <sup>15</sup>
V6-3.3	2006-2004		234-9057 <sup>16</sup>	-	234-4064 <sup>16</sup>	234-4209 <sup>16</sup>
V6-3.5	2016-2015		234-9154 <sup>4</sup>	-	234-4927 <sup>4</sup>	-
V6-3.5	2016-2015		234-9155 <sup>5</sup>	-	234-4925 <sup>5</sup>	-
V6-3.5	2014-2012		234-9128 <sup>4</sup>	-	234-4260 <sup>4</sup>	234-4209 <sup>4</sup>
V6-3.5	2014-2012		234-9128 <sup>5</sup>	-	234-4064 <sup>5</sup>	234-4209 <sup>5</sup>
V6-3.5	2011-2008		234-9008 <sup>4</sup>	-	234-4260 <sup>4</sup>	234-4209 <sup>4</sup>
V6-3.5	2011-2008		234-9022 <sup>5</sup>	-	234-4064 <sup>5</sup>	234-4209 <sup>5</sup>
V6-3.5	2007		234-9041 <sup>4</sup>	-	234-4260 <sup>4</sup>	234-4209 <sup>4</sup>
V6-3.5	2007		234-9050 <sup>5</sup>	-	234-4064 <sup>5</sup>	234-4209 <sup>5</sup>
<b>CELICA</b>						
L4-1.6	1993-1992	Exc. Calif.	234-4072	234-4050	-	-
L4-1.6	1993-1990	Calif.	234-2057	234-2050	-	-
L4-1.6	1991-1990	Exc. Calif.	234-4158	234-4050	-	-
L4-1.8	2005-2003	GT	234-4803	-	234-4623	234-4209
L4-1.8	2005-2003	GTS	234-4803	-	234-4139	234-4209
L4-1.8	2002-2000	GT	234-4604	234-4209	234-4623	234-4209
L4-1.8	2002-2000	GTS	234-4604	234-4209	234-4139	234-4209
L4-1.8	1997-1996		234-2008	234-2000	234-4623	234-4209
L4-1.8	1995-1994		234-1053	234-1057	234-2052	234-2050
L4-2.0	1993-1990		234-4156	234-4050	-	-
L4-2.0	1989-1988	All Trac & GTS	234-4051	234-4050	-	-
L4-2.0	1989	GT & ST; Calif.; 1 Lead Sensor	234-1051	234-1057	-	-
L4-2.0	1989	GT & ST; Calif.; 2 Lead Sensor	234-2009	234-2000	-	-
L4-2.0	1989	GT & ST; Exc. Calif.	234-1051	234-1057	-	-
L4-2.0	1988	GT & ST	234-1051	234-1057	-	-
L4-2.0	1987		234-1051	234-1057	-	-
L4-2.0	1986	GT & ST	234-1058	-	-	-
L4-2.0	1986	GTS	234-1051	234-1057	-	-
L4-2.2	1999-1996		234-2058	234-2050	234-2010	234-2000
L4-2.2	1995-1994		234-1053	234-1057	234-2010	234-2000
L4-2.2	1993-1992	Calif.	234-1053	234-1057	234-2008	234-2000
L4-2.2	1993-1992	Exc. Calif.	234-1053	234-1057	-	-

<sup>1</sup> 2 Required / Requis 2 / Requeridos 2 <sup>4</sup> Left Side / Côté gauche / Lado izquierdo <sup>5</sup> Right Side / Côté droit / Lado derecho <sup>15</sup> Front / Avant / Parte delantera <sup>16</sup> Rear / Arrière / Parte trasera



ENGINE MOTEUR MOTOR	YEAR ANNEE AÑO	APPLICATION INFORMATION INFORMATION D'APPLICATION INFORMACION DE APLICACION	UPSTREAM / AVANT - C.C. / ANTES DEL C.C.		DOWNSTREAM / APRS - C.C. / DESPUES DEL C.C.	
			TYPE / TIPO O.E.	UNIVERS.	TYPE / TIPO O.E.	UNIVERS.
<b>TOYOTA [cont]</b>						
<b>CELICA [cont]</b>						
L4-2.2	1991-1990	Calif.	234-2068	234-2000	-	-
L4-2.2	1991-1990	Exc. Calif.	234-1051	234-1057	-	-
L4-2.4	1985-1984		234-1056	234-1057	-	-
L4-2.4	1983	Carbureted	234-1051	234-1057	-	-
L4-2.4	1983	Fuel Injected	234-1056	234-1057	-	-
L4-2.4	1982-1981		234-1051	234-1057	-	-
L6-2.6	1980-1979		-	234-1057	-	-
L6-2.8	1986-1981		234-1056	234-1057	-	-
<b>COROLLA</b>						
L4-1.6	1997-1996		234-2003	234-2000	234-4061	234-4209
L4-1.6	1995-1993	Calif.	234-1053	234-1057	234-2051	234-2071
L4-1.6	1995-1993	Exc. Calif.	234-2052	234-2050	-	-
L4-1.6	1992		234-2055	234-2050	-	-
L4-1.6	1991-1990	4AFE Engine	234-2055	234-2050	-	-
L4-1.6	1991-1990	4AGE Engine; Calif.	234-4059	234-4208	234-2005	234-2000
L4-1.6	1991-1990	4AGE Engine; Exc. Calif.	234-4508	-	-	-
L4-1.6	1989-1988	Fuel Injected; AWD	234-1056	234-1057	-	-
L4-1.6	1989	Carbureted	234-1051	234-1057	-	-
L4-1.6	1989	Fuel Injected; FWD; Calif.	234-4059	234-4208	234-2005	234-2000
L4-1.6	1989	Fuel Injected; FWD; Exc. Calif.	234-4508	-	-	-
L4-1.6	1988	Carbureted; 4AF Engine	234-1051	234-1057	-	-
L4-1.6	1988	Carbureted; 4ALC Engine	234-1056	234-1057	-	-
L4-1.6	1988	Fuel Injected; FWD; 4AGE Engine	234-4059	234-4208	-	-
L4-1.6	1988	Fuel Injected; FWD; 4AGELC Engine	234-4150	234-4050	-	-
L4-1.6	1987-1985	Carbureted	234-1056	234-1057	-	-
L4-1.6	1987-1985	Fuel Injected	234-1051	234-1057	-	-
L4-1.6	1984-1983		234-1056	234-1057	-	-
L4-1.8	2016-2014		234-9140	-	234-4921	-
L4-1.8	2013-2011	Japan Built	234-9090	-	234-4305	-
L4-1.8	2013-2011	North American Built	234-9112	-	234-4305	-
L4-1.8	2010-2009		234-9056	-	234-4305	-
L4-1.8	2008-2007		234-9052	-	234-4233	234-4209
L4-1.8	2006-2005	1ZZFE Engine	234-9052	-	234-4233	234-4209
L4-1.8	2006-2005	2ZZGE Engine	234-4802	-	234-4233	234-4209
L4-1.8	2004-2003		234-4800	-	234-4233	234-4209
L4-1.8	2002-1998		234-4205	234-4207	234-4061	234-4209
L4-1.8	1997-1995		234-2003	234-2000	234-4061	234-4209
L4-1.8	1994-1993	Calif.	234-1053	234-1057	234-2051	234-2071
L4-1.8	1994-1993	Exc. Calif.	234-2052	234-2050	-	-
L4-1.8	1982-1981		234-1051	234-1057	-	-
L4-1.8	1980		234-1056	234-1057	-	-



ENGINE MOTEUR MOTOR	YEAR ANNEE AÑO	APPLICATION INFORMATION INFORMATION D'APPLICATION INFORMACION DE APLICACION	UPSTREAM / AVANT - C.C. / ANTES DEL C.C.		DOWNSTREAM / APRES - C.C. / DESPUES DEL C.C.	
			TYPE / TIPO O.E.	UNIVERS.	TYPE / TIPO O.E.	UNIVERS.
<b>TOYOTA [cont]</b>						
<b>COROLLA [cont]</b>						
L4-2.4	2012-2009		234-9008	-	234-4622	234-4209
<b>CORONA</b>						
L4-2.4	1982-1981		234-1051	234-1057	-	-
<b>CRESSIDA</b>						
L6-2.6	1980		-	234-1057	-	-
L6-2.8	1988-1981		234-1056	234-1057	-	-
L6-3.0	1992-1989	Calif.	234-1051	234-1057	234-4054	234-4050
L6-3.0	1992-1989	Exc. Calif.	234-1051	234-1057	-	-
<b>ECHO</b>						
L4-1.5	2005-2003	Downstream OE #89465-52200	234-4524	-	234-4069	234-4209
L4-1.5	2005-2003	Downstream OE #89465-52280	234-4524	-	234-4069	-
L4-1.5	2002-2000		234-4624	234-4209	234-4069	234-4209
<b>FJ CRUISER</b>						
V6-4.0	2014-2013		234-9144 <sup>4</sup>	-	234-4758 <sup>4</sup>	-
V6-4.0	2014-2013		234-9144 <sup>5</sup>	-	234-4931 <sup>5</sup>	-
V6-4.0	2012-2010		234-9101 <sup>4</sup>	-	234-4260 <sup>4</sup>	234-4209 <sup>4</sup>
V6-4.0	2012-2010		234-9101 <sup>5</sup>	-	234-4138 <sup>5</sup>	234-4209 <sup>5</sup>
V6-4.0	2009-2008		234-9026 <sup>1</sup>	-	234-4260 <sup>1</sup>	234-4209 <sup>1</sup>
V6-4.0	2007		234-9051 <sup>4</sup>	-	234-4261 <sup>4</sup>	234-4209 <sup>4</sup>
V6-4.0	2007		234-9051 <sup>5</sup>	-	234-4260 <sup>5</sup>	234-4209 <sup>5</sup>
<b>HIGHLANDER</b>						
L4-2.4	2007-2004		234-9054	-	234-4504	-
L4-2.4	2003-2001	Cylinder 1,4	234-9041	-	234-4048	234-4209
L4-2.4	2003-2001	Cylinder 2,3	234-9058	-	234-4048	234-4209
L4-2.7	2016-2014		234-9153	-	234-4948	-
L4-2.7	2013-2009		234-9092	-	234-4509	-
V6-3.0	2003-2001		234-9009 <sup>1</sup>	-	234-4215	234-4206
V6-3.3	2010-2008		234-9067 <sup>5</sup>	-	234-4502 <sup>5</sup>	-
V6-3.3	2010-2008		234-9068 <sup>4</sup>	-	234-4149 <sup>4</sup>	234-4209 <sup>4</sup>
V6-3.3	2007-2006	Gas Engine	234-9042 <sup>5</sup>	-	234-4509 <sup>5</sup>	-
V6-3.3	2007-2006	Gas Engine	234-9042 <sup>4</sup>	-	234-4168 <sup>4</sup>	234-4209 <sup>4</sup>
V6-3.3	2007-2006	Hybrid Engine	234-9042 <sup>5</sup>	-	234-4502 <sup>5</sup>	-
V6-3.3	2007-2006	Hybrid Engine	234-9042 <sup>4</sup>	-	234-4149 <sup>4</sup>	234-4209 <sup>4</sup>
V6-3.3	2005-2004		234-9042 <sup>5</sup>	-	234-4509 <sup>5</sup>	-
V6-3.3	2005-2004		234-9042 <sup>4</sup>	-	234-4168 <sup>4</sup>	234-4209 <sup>4</sup>
V6-3.5	2016-2014	Gas Engine	234-9154 <sup>4</sup>	-	234-4400 <sup>4</sup>	-
V6-3.5	2016-2014	Gas Engine	234-9155 <sup>5</sup>	-	234-4509 <sup>5</sup>	-
V6-3.5	2016-2014	Hybrid Engine	234-9114 <sup>4</sup>	-	234-4400 <sup>4</sup>	-
V6-3.5	2016-2014	Hybrid Engine	234-9115 <sup>5</sup>	-	234-4928 <sup>5</sup>	-
V6-3.5	2013-2011	Gas Engine	234-9114 <sup>5</sup>	-	234-4509 <sup>5</sup>	-

<sup>1</sup> 2 Required / Requis 2 / Requeridos 2 <sup>4</sup> Left Side / Côté gauche / Lado izquierdo <sup>5</sup> Right Side / Côté droit / Lado derecho



ENGINE MOTEUR MOTOR	YEAR ANNEE AÑO	APPLICATION INFORMATION INFORMATION D'APPLICATION INFORMACION DE APLICACION	UPSTREAM / AVANT - C.C. / ANTES DEL C.C.		DOWNSTREAM / APRS - C.C. / DESPUES DEL C.C.	
			TYPE / TIPO O.E.	UNIVERS.	TYPE / TIPO O.E.	UNIVERS.
<b>TOYOTA [cont]</b>						
<b>HIGHLANDER [cont]</b>						
V6-3.5	2013-2011	Hybrid Engine	234-9115 <sup>4</sup>	-	234-4509 <sup>4</sup>	-
V6-3.5	2013-2011	Hybrid Engine	234-9114 <sup>5</sup>	-	234-4400 <sup>5</sup>	-
V6-3.5	2013	Gas Engine	234-9128 <sup>4</sup>	-	234-4149 <sup>4</sup>	234-4209 <sup>4</sup>
V6-3.5	2012-2011	Gas Engine	234-9115 <sup>4</sup>	-	234-4149 <sup>4</sup>	234-4209 <sup>4</sup>
V6-3.5	2010-2008		234-9022 <sup>5</sup>	-	234-4509 <sup>5</sup>	-
V6-3.5	2010-2008		234-9008 <sup>4</sup>	-	234-4149 <sup>4</sup>	234-4209 <sup>4</sup>
<b>LAND CRUISER</b>						
L6-4.0	1992-1990		234-4051 <sup>4</sup>	234-4050 <sup>4</sup>	-	-
L6-4.0	1992-1990		234-4150 <sup>5</sup>	234-4050 <sup>5</sup>	-	-
L6-4.0	1989-1988		234-4056	234-4050	-	-
L6-4.2	1987-1986		234-4150	234-4050	-	-
L6-4.2	1985	Hardtop	234-1056	234-1057	-	-
L6-4.2	1985	Wagon; From 04/85	234-4150	234-4050	-	-
L6-4.2	1985	Wagon; To 04/85	234-1056	234-1057	-	-
L6-4.2	1984-1981		234-1056	234-1057	-	-
L6-4.5	1997-1996		234-4157	234-4206	234-4153	234-4206
L6-4.5	1995	From 01/95	234-4157	234-4206	234-4153	234-4206
L6-4.5	1995	To 01/95	234-4520 <sup>1</sup>	-	-	-
L6-4.5	1994-1993		234-4520 <sup>1</sup>	-	-	-
V8-4.7	2007-2006		234-9051 <sup>1</sup>	-	234-4260 <sup>1</sup>	234-4209 <sup>1</sup>
V8-4.7	2005	From 05/05	234-9051 <sup>1</sup>	-	234-4260 <sup>1</sup>	234-4209 <sup>1</sup>
V8-4.7	2005	To 05/05	234-4138 <sup>1</sup>	234-4209 <sup>1</sup>	234-4154 <sup>1</sup>	234-4206 <sup>1</sup>
V8-4.7	2004-2003		234-4138 <sup>1</sup>	234-4209 <sup>1</sup>	234-4154 <sup>1</sup>	234-4206 <sup>1</sup>
V8-4.7	2002-1998		234-4169 <sup>1</sup>	234-4209 <sup>1</sup>	234-4154 <sup>1</sup>	234-4206 <sup>1</sup>
V8-5.7	2016-2015		234-9145 <sup>4</sup>	-	234-4927 <sup>4</sup>	-
V8-5.7	2016-2014		234-9145 <sup>5</sup>	-	234-4931 <sup>5</sup>	-
V8-5.7	2014		234-9145 <sup>4</sup>	-	234-4758 <sup>4</sup>	-
V8-5.7	2013		234-9111 <sup>4</sup>	-	234-4260 <sup>4</sup>	234-4209 <sup>4</sup>
V8-5.7	2013		234-9111 <sup>5</sup>	-	234-4169 <sup>5</sup>	234-4209 <sup>5</sup>
V8-5.7	2011-2008		234-9026 <sup>4</sup>	-	234-4260 <sup>4</sup>	234-4209 <sup>4</sup>
V8-5.7	2011-2008		234-9026 <sup>5</sup>	-	234-4169 <sup>5</sup>	234-4209 <sup>5</sup>
<b>MATRIX</b>						
L4-1.8	2014-2011		234-9112	-	234-4305	-
L4-1.8	2010-2009		234-9056	-	234-4305	-
L4-1.8	2008-2007		234-9052	-	234-4233	234-4209
L4-1.8	2006-2005	1ZZFE Engine; AWD.	234-4801	-	234-4623	234-4209
L4-1.8	2006-2005	1ZZFE Engine; FWD	234-9052	-	234-4233	234-4209
L4-1.8	2006-2005	2ZZGE Engine	234-4802	-	234-4233	234-4209
L4-1.8	2004-2003	1ZZFE Engine; AWD	234-4801	-	234-4623	234-4209
L4-1.8	2004-2003	1ZZFE Engine; FWD	234-4800	-	234-4233	234-4209

<sup>1</sup> 2 Required / Requis 2 / Requeridos 2 <sup>4</sup> Left Side / Côté gauche / Lado izquierdo <sup>5</sup> Right Side / Côté droit / Lado derecho



ENGINE MOTEUR MOTOR	YEAR ANNEE AÑO	APPLICATION INFORMATION INFORMATION D'APPLICATION INFORMACION DE APLICACION	UPSTREAM / AVANT - C.C. / ANTES DEL C.C.		DOWNSTREAM / APRS - C.C. / DESPUES DEL C.C.	
			TYPE / TIPO O.E.	UNIVERS.	TYPE / TIPO O.E.	UNIVERS.
<b>TOYOTA [cont]</b>						
<b>MATRIX [cont]</b>						
L4-1.8	2004	2ZZGE Engine; From 05/03	234-4802	-	234-4233	234-4209
L4-1.8	2004	2ZZGE Engine; To 05/03	234-4233	234-4209	234-4233	234-4209
L4-1.8	2003	2ZZGE Engine	234-4233	234-4209	234-4233	234-4209
L4-2.4	2013-2009	AWD	234-9008	-	234-4306	-
L4-2.4	2013-2009	FWD	234-9008	-	234-4622	234-4209
<b>MR2</b>						
L4-1.6	1989-1988	Non-Supercharged	234-4056	234-4050	-	-
L4-1.6	1989-1988	Supercharged	234-4051	234-4050	-	-
L4-1.6	1987-1985		234-1056	234-1057	-	-
L4-2.0	1995-1991		234-4156	234-4050	-	-
L4-2.2	1995-1993		234-1055	234-1057	234-2003	234-2000
L4-2.2	1992	From 01/92	234-1055	234-1057	234-2003	234-2000
L4-2.2	1992	To 01/92	234-1056	234-1057	234-2068	234-2000
L4-2.2	1991		234-1056	234-1057	234-2068	234-2000
<b>MR2 SPYDER</b>						
L4-1.8	2005-2000		234-4624	234-4209	234-4603	234-4209
<b>PASEO</b>						
L4-1.5	1999-1997		234-2010	234-2000	234-4061	234-4209
L4-1.5	1996		234-4622	234-4209	234-4061	234-4209
L4-1.5	1995	Calif.	234-4622	234-4209	234-4061	234-4209
L4-1.5	1995	Exc. Calif.	234-2052	234-2050	-	-
L4-1.5	1994-1992		234-2052	234-2050	-	-
<b>PICKUP</b>						
L4-2.2	1980-1979		234-1051	234-1057	-	-
L4-2.4	1995-1993	4WD; Calif.; Japan Built	234-4151	234-4050	234-4154	234-4206
L4-2.4	1995-1993	4WD; Calif.; USA Built	234-4052	234-4050	234-4154	234-4206
L4-2.4	1995-1993	RWD; Calif.	234-4052	234-4050	234-4154	234-4206
L4-2.4	1995-1992	4WD; Exc. Calif.	234-4052	234-4050	-	-
L4-2.4	1995-1992	RWD; Exc. Calif.	234-4072	234-4050	-	-
L4-2.4	1992	4WD; Calif.; Long Bed	234-4072	234-4050	234-4052	234-4050
L4-2.4	1992	4WD; Calif.; Short Bed	234-4052	234-4050	234-4052	234-4050
L4-2.4	1992	RWD; Calif.; Long Bed	234-4072	234-4050	234-4160	234-4050
L4-2.4	1992	RWD; Calif.; Short Bed	234-4072	234-4050	234-4052	234-4050
L4-2.4	1991	4WD; Calif.; Long Bed	234-4056	234-4050	234-4051	234-4050
L4-2.4	1991	4WD; Calif.; Short Bed	234-4056	234-4050	234-4055	234-4050
L4-2.4	1991	4WD; Exc. Calif.	234-4055	234-4050	-	-
L4-2.4	1991	RWD; Calif.; Long Bed	234-4051	234-4050	234-4150	234-4050
L4-2.4	1991	RWD; Calif.; Short Bed	234-4051	234-4050	234-4055	234-4050
L4-2.4	1991	RWD; Exc. Calif.	234-4051	234-4050	-	-
L4-2.4	1990-1989	Carbureted; w/ 14" Sensor	234-4051	234-4050	-	-
L4-2.4	1990-1989	Carbureted; w/ 22" Sensor	234-4055	234-4050	-	-



ENGINE MOTEUR MOTOR	YEAR ANNEE AÑO	APPLICATION INFORMATION INFORMATION D'APPLICATION INFORMACION DE APLICACION	UPSTREAM / AVANT - C.C. / ANTES DEL C.C.		DOWNSTREAM / APRS - C.C. / DESPUES DEL C.C.	
			TYPE / TIPO O.E.	UNIVERS.	TYPE / TIPO O.E.	UNIVERS.
<b>TOYOTA [cont]</b>						
<b>PICKUP [cont]</b>						
L4-2.4	1990-1989	Fuel Injected; 4WD; Calif.; Long Bed	234-4056	234-4050	234-4051	234-4050
L4-2.4	1990-1989	Fuel Injected; 4WD; Calif.; Short Bed	234-4056	234-4050	234-4055	234-4050
L4-2.4	1990-1989	Fuel Injected; 4WD; Exc. Calif.	234-4055	234-4050	-	-
L4-2.4	1990-1989	Fuel Injected; RWD; Calif.; Long Bed	234-4051	234-4050	234-4150	234-4050
L4-2.4	1990-1989	Fuel Injected; RWD; Calif.; Short Bed	234-4051	234-4050	234-4055	234-4050
L4-2.4	1990-1989	Fuel Injected; RWD; Exc. Calif.	234-4051	234-4050	-	-
L4-2.4	1988	Carbureted	234-1056	234-1057	-	-
L4-2.4	1988	Fuel Injected; Non-Turbo; 4WD	234-4152	234-4050	-	-
L4-2.4	1988	Fuel Injected; Non-Turbo; RWD	234-4053	234-4050	-	-
L4-2.4	1988	Fuel Injected; Turbo	234-1056	234-1057	-	-
L4-2.4	1987-1985		234-1056	234-1057	-	-
L4-2.4	1984	Carbureted	234-1051	234-1057	-	-
L4-2.4	1984	Fuel Injected	234-1056	234-1057	-	-
L4-2.4	1983-1981		234-1051	234-1057	-	-
V6-3.0	1995-1994	4WD; Calif.	234-4052	234-4050	234-4154	234-4206
V6-3.0	1995-1994	4WD; Exc. Calif.	234-4052	234-4050	-	-
V6-3.0	1995-1994	RWD; Calif.	234-4052	234-4050	234-4162	234-4206
V6-3.0	1995-1992	RWD; Exc. Calif.; Dual Rear Wheels	234-4072	234-4050	-	-
V6-3.0	1995-1992	RWD; Exc. Calif.; Single Rear Wheels	234-4052	234-4050	-	-
V6-3.0	1993-1992	4WD	234-4052	234-4050	-	-
V6-3.0	1993-1992	RWD; Calif.	234-4511	-	-	-
V6-3.0	1991-1990	Exc. Base Model; 4WD	234-4055	234-4050	-	-
V6-3.0	1991-1990	Exc. Base Model; RWD; Calif.	234-4507	-	-	-
V6-3.0	1991-1990	Exc. Base Model; RWD; Exc. Calif.	234-4055	234-4050	-	-
V6-3.0	1989	Exc. Base Model	234-4055	234-4050	-	-
V6-3.0	1988		234-4152	234-4050	-	-
<b>PREVIA</b>						
L4-2.4	1997-1994	Supercharged	234-4155	234-4206	234-4153	234-4206
L4-2.4	1995-1991	Non-Supercharged	234-4072	234-4050	234-2052	234-2050
<b>PRIUS</b>						
L4-1.5	2009-2004		234-9056	-	234-4623	234-4209
L4-1.5	2003-2001		234-4624	234-4209	234-4623	234-4209
L4-1.8	2015		234-9090	-	234-4400	-
L4-1.8	2014-2011		234-9112	-	234-4400	-
L4-1.8	2010		234-9090	-	234-4400	-
<b>PRIUS C</b>						
L4-1.5	2016-2012		234-9130	-	234-4760	-
<b>PRIUS V</b>						
L4-1.8	2016-2015		234-9090	-	234-4400	-
L4-1.8	2014-2012		234-9112	-	234-4400	-



ENGINE MOTEUR MOTOR	YEAR ANNEE AÑO	APPLICATION INFORMATION INFORMATION D'APPLICATION INFORMACION DE APLICACION	UPSTREAM / AVANT - C.C. / ANTES DEL C.C.		DOWNSTREAM / APRES - C.C. / DESPUES DEL C.C.	
			TYPE / TIPO O.E.	UNIVERS.	TYPE / TIPO O.E.	UNIVERS.
<b>TOYOTA [cont]</b>						
<b>RAV4</b>						
L4-2.0	2003-2001		234-9023 <sup>4</sup>	-	234-4048 <sup>4</sup>	234-4209 <sup>4</sup>
L4-2.0	2003-2001		234-9028 <sup>5</sup>	-	234-4048 <sup>5</sup>	234-4209 <sup>5</sup>
L4-2.0	2000-1998	Calif.	234-9007 <sup>11</sup>	-	234-4214	234-4206
L4-2.0	2000-1998	Exc. Calif.	234-4624	234-4209	234-4214	234-4206
L4-2.0	1997-1996		234-2058	234-2050	234-2010	234-2000
L4-2.4	2008-2006		234-9041	-	234-4622	234-4209
L4-2.4	2005-2004		234-9041	-	234-4503	-
L4-2.5	2016	Gas Engine	234-9114	-	234-4757	-
L4-2.5	2016	Hybrid Engine	234-9154	-	234-4757	-
L4-2.5	2015-2013		234-9114	-	234-4757	-
L4-2.5	2012-2009	Japan Built	234-9022	-	234-4622	234-4209
L4-2.5	2012-2009	USA Built	234-9022	-	234-4622	-
V6-3.5	2012-2006		234-9022 <sup>5</sup>	-	234-4501 <sup>5</sup>	-
V6-3.5	2012-2006		234-9049 <sup>4</sup>	-	234-4261 <sup>4</sup>	234-4209 <sup>4</sup>
<b>SEQUOIA</b>						
V8-4.6	2012-2010		234-9026 <sup>4</sup>	-	234-4260 <sup>4</sup>	234-4209 <sup>4</sup>
V8-4.6	2012-2010		234-9026 <sup>5</sup>	-	234-4624 <sup>5</sup>	234-4209 <sup>5</sup>
V8-4.7	2009-2008		234-9026 <sup>4</sup>	-	234-4260 <sup>4</sup>	234-4209 <sup>4</sup>
V8-4.7	2009-2008		234-9026 <sup>5</sup>	-	234-4624 <sup>5</sup>	234-4209 <sup>5</sup>
V8-4.7	2007-2005		234-9051 <sup>1</sup>	-	234-4260 <sup>1</sup>	234-4209 <sup>1</sup>
V8-4.7	2004-2001	4WD	234-4169 <sup>1</sup>	234-4209 <sup>1</sup>	234-4162 <sup>1</sup>	234-4206 <sup>1</sup>
V8-4.7	2004-2001	RWD	234-4169 <sup>1</sup>	234-4209 <sup>1</sup>	234-4161 <sup>1</sup>	234-4206 <sup>1</sup>
V8-5.7	2016-2015	Gas Engine	234-9145 <sup>4</sup>	-	234-4927 <sup>4</sup>	-
V8-5.7	2016-2014	Gas Engine	234-9145 <sup>5</sup>	-	234-4926 <sup>5</sup>	-
V8-5.7	2016	Flex Fuel Engine	234-9145 <sup>4</sup>	-	234-4260 <sup>4</sup>	234-4209 <sup>4</sup>
V8-5.7	2016	Flex Fuel Engine	234-9145 <sup>5</sup>	-	234-4624 <sup>5</sup>	234-4209 <sup>5</sup>
V8-5.7	2015-2014	Flex Fuel Engine	234-9111 <sup>4</sup>	-	234-4260 <sup>4</sup>	234-4209 <sup>4</sup>
V8-5.7	2015-2014	Flex Fuel Engine	234-9144 <sup>5</sup>	-	234-4624 <sup>5</sup>	234-4209 <sup>5</sup>
V8-5.7	2014	Gas Engine	234-9145 <sup>4</sup>	-	234-4758 <sup>4</sup>	-
V8-5.7	2013-2012		234-9111 <sup>4</sup>	-	234-4260 <sup>4</sup>	234-4209 <sup>4</sup>
V8-5.7	2013-2012		234-9144 <sup>5</sup>	-	234-4624 <sup>5</sup>	234-4209 <sup>5</sup>
V8-5.7	2011-2008		234-9026 <sup>4</sup>	-	234-4260 <sup>4</sup>	234-4209 <sup>4</sup>
V8-5.7	2011-2008		234-9026 <sup>5</sup>	-	234-4624 <sup>5</sup>	234-4209 <sup>5</sup>
<b>SIENNA</b>						
L4-2.7	2013-2011		234-9113	-	234-4537	-
V6-3.0	2003-2001		234-9021 <sup>1</sup>	-	234-4163	234-4206
V6-3.0	2000-1999	Calif.	234-9007 <sup>4</sup>	-	234-4623	234-4209
V6-3.0	2000-1999	Calif.	234-9009 <sup>5</sup>	-	-	-

<sup>1</sup> 2 Required / Requis 2 / Requeridos 2 <sup>4</sup> Left Side / Côté gauche / Lado izquierdo <sup>5</sup> Right Side / Côté droit / Lado derecho <sup>11</sup> Loc. Manifold / Empl. collecteur / Ubicación collector





ENGINE MOTEUR MOTOR	YEAR ANNEE AÑO	APPLICATION INFORMATION INFORMATION D'APPLICATION INFORMACION DE APLICACION	UPSTREAM / AVANT - C.C. / ANTES DEL C.C.		DOWNSTREAM / APRS - C.C. / DESPUES DEL C.C.	
			TYPE / TIPO O.E.	UNIVERS.	TYPE / TIPO O.E.	UNIVERS.
<b>TOYOTA [cont]</b>						
<b>SIENNA [cont]</b>						
V6-3.0	2000-1999	Exc. Calif.	234-4622 <sup>1</sup>	234-4209 <sup>1</sup>	234-4623	234-4209
V6-3.0	1998		234-4622 <sup>1</sup>	234-4209 <sup>1</sup>	234-4623	234-4209
V6-3.3	2006-2004		234-9042 <sup>15</sup>	-	234-4168 <sup>15</sup>	234-4209 <sup>15</sup>
V6-3.3	2006-2004	AWD	234-9012 <sup>16</sup>	-	234-4512 <sup>16</sup>	-
V6-3.3	2006-2004	FWD	234-9012 <sup>16</sup>	-	234-4516 <sup>16</sup>	-
V6-3.5	2016-2015	AWD	234-9154 <sup>4</sup>	-	234-4400 <sup>4</sup>	-
V6-3.5	2016-2015	AWD	234-9155 <sup>5</sup>	-	234-4400 <sup>5</sup>	-
V6-3.5	2016-2015	FWD	234-9154 <sup>4</sup>	-	234-4946 <sup>4</sup>	-
V6-3.5	2016-2015	FWD	234-9155 <sup>5</sup>	-	234-4946 <sup>5</sup>	-
V6-3.5	2014-2012		234-9128 <sup>4</sup>	-	234-4416 <sup>4</sup>	-
V6-3.5	2014-2012	AWD	234-9114 <sup>5</sup>	-	234-4539 <sup>5</sup>	-
V6-3.5	2014-2012	FWD	234-9114 <sup>5</sup>	-	234-4540 <sup>5</sup>	-
V6-3.5	2011		234-9008 <sup>4</sup>	-	234-4416 <sup>4</sup>	-
V6-3.5	2011	AWD	234-9022 <sup>5</sup>	-	234-4539 <sup>5</sup>	-
V6-3.5	2011	FWD	234-9022 <sup>5</sup>	-	234-4540 <sup>5</sup>	-
V6-3.5	2010-2007		234-9049 <sup>4</sup>	-	234-4149 <sup>4</sup>	234-4209 <sup>4</sup>
V6-3.5	2010-2007	AWD	234-9012 <sup>5</sup>	-	234-4512 <sup>5</sup>	-
V6-3.5	2010-2007	FWD	234-9012 <sup>5</sup>	-	234-4516 <sup>5</sup>	-
<b>SOLARA</b>						
L4-2.2	2001		234-9010	-	234-4137	234-4209
L4-2.2	2000-1999	Exc. Calif.	234-4626	234-4209	234-4137	234-4209
L4-2.2	2000	Calif.	234-9010	-	234-4137	234-4209
L4-2.2	1999	Calif.	234-9024	-	234-4137	234-4209
L4-2.4	2008		234-9049	-	234-4260	234-4209
L4-2.4	2007		234-9041	-	234-4260	234-4209
L4-2.4	2006-2004		234-9041	-	234-4624	234-4209
L4-2.4	2003-2002		234-9010	-	234-4149	234-4209
V6-3.0	2003-2001	Auto Trans	234-9021 <sup>1</sup>	-	234-4137	234-4209
V6-3.0	2003-2001	Manual Trans	234-4622 <sup>1</sup>	234-4209 <sup>1</sup>	234-4137	234-4209
V6-3.0	2000-1999	Calif.	234-9009 <sup>15</sup>	-	234-4137	234-4209
V6-3.0	2000-1999	Calif.	234-9007 <sup>16</sup>	-	-	-
V6-3.0	2000-1999	Exc. Calif.	234-4622 <sup>1</sup>	234-4209 <sup>1</sup>	234-4137	234-4209
V6-3.3	2008-2004		234-9042 <sup>15</sup>	-	234-4261 <sup>15</sup>	234-4209 <sup>15</sup>
V6-3.3	2008-2004		234-9057 <sup>16</sup>	-	234-4064 <sup>16</sup>	234-4209 <sup>16</sup>
<b>STARLET</b>						
L4-1.3	1984-1981		234-1056	234-1057	-	-
<b>SUPRA</b>						
L6-3.0	1998-1993	Turbo	234-4514	-	234-4215	234-4206
L6-3.0	1998	Non-Turbo; Cylinder 1,2,3	234-4626	234-4209	234-4626	234-4209

<sup>1</sup> 2 Required / Requis 2 / Requeridos 2 <sup>4</sup> Left Side / Côté gauche / Lado izquierdo <sup>5</sup> Right Side / Côté droit / Lado derecho <sup>15</sup> Front / Avant / Parte delantera <sup>16</sup> Rear / Arrière / Parte trasera



ENGINE MOTEUR MOTOR	YEAR ANNEE AÑO	APPLICATION INFORMATION INFORMATION D'APPLICATION INFORMACION DE APLICACION	UPSTREAM / AVANT - C.C. / ANTES DEL C.C.		DOWNSTREAM / APRES - C.C. / DESPUES DEL C.C.	
			TYPE / TIPO O.E.	UNIVERS.	TYPE / TIPO O.E.	UNIVERS.
<b>TOYOTA [cont]</b>						
<b>SUPRA [cont]</b>						
L6-3.0	1998	Non-Turbo; Cylinder 4,5,6	234-4623	234-4209	234-4630	234-4209
L6-3.0	1997-1996	Non-Turbo	234-4626 <sup>1</sup>	234-4209 <sup>1</sup>	234-4215	234-4206
L6-3.0	1995-1993	Non-Turbo; Calif.	234-4626 <sup>1</sup>	234-4209 <sup>1</sup>	234-4215	234-4206
L6-3.0	1995-1993	Non-Turbo; Exc. Calif.	234-1055 <sup>1</sup>	234-1057 <sup>1</sup>	-	-
L6-3.0	1992-1991	Turbo	234-3052	234-3050	-	-
L6-3.0	1992-1989	Non-Turbo; Calif.	234-4204	234-4208	-	-
L6-3.0	1992-1989	Non-Turbo; Exc. Calif.	234-1056	234-1057	-	-
L6-3.0	1990-1987	Turbo	234-3051	234-3050	-	-
L6-3.0	1988	Non-Turbo; Calif.	234-4202	234-4208	-	-
L6-3.0	1988	Non-Turbo; Exc. Calif.	234-1051	234-1057	-	-
L6-3.0	1987	Non-Turbo	234-1051	234-1057	-	-
L6-3.0	1986		234-1051	234-1057	-	-
<b>T100</b>						
L4-2.7	1998-1996	Manual Trans	234-4154	234-4206	234-4153	234-4206
L4-2.7	1998-1995	Auto Trans	234-4162	234-4206	234-4161	234-4206
L4-2.7	1995	Manual Trans	234-4160	234-4050	234-4153	234-4206
L4-2.7	1994		234-4160	234-4050	234-4153	234-4206
V6-3.0	1994-1993	Calif.	234-4151	234-4050	234-4155	234-4206
V6-3.0	1994-1993	Exc. Calif.	234-4151	234-4050	-	-
V6-3.4	1998-1995	Auto Trans; 4WD	234-4162	234-4206	234-4162	234-4206
V6-3.4	1998-1995	Auto Trans; RWD	234-4162	234-4206	234-4161	234-4206
V6-3.4	1998-1995	Manual Trans; 4WD	234-4153	234-4206	234-4162	234-4206
V6-3.4	1998	Manual Trans; RWD	234-4153	234-4206	234-4161	234-4206
V6-3.4	1997-1995	Manual Trans; RWD	234-4151	234-4050	234-4161	234-4206
<b>TACOMA</b>						
L4-2.4	2004		234-9001	-	234-4189	234-4206
L4-2.4	2003-2001	Auto Trans	234-9002	-	234-4189	234-4206
L4-2.4	2003-2001	Manual Trans	234-9001	-	234-4189	234-4206
L4-2.4	2000	Auto Trans; Calif.	234-4154	234-4206	234-4189	234-4206
L4-2.4	2000	Auto Trans; Exc. Calif.	234-4154	234-4206	234-4153	234-4206
L4-2.4	2000	Manual Trans; Calif.	234-4162	234-4206	234-4189	234-4206
L4-2.4	2000	Manual Trans; Exc. Calif.	234-4162	234-4206	234-4153	234-4206
L4-2.4	1999-1995	Auto Trans	234-4154	234-4206	234-4153	234-4206
L4-2.4	1999-1995	Manual Trans	234-4162	234-4206	234-4153	234-4206
L4-2.7	2015	From 02/2015; 4WD; Manual Trans	234-9128	-	234-4927	-
L4-2.7	2015	To 01/2015; 4WD; Auto Trans	234-9128	-	234-4926	-
L4-2.7	2015	To 01/2015; 4WD; Manual Trans	234-9128	-	234-4926	-
L4-2.7	2015	To 01/2015; RWD	234-9128	-	234-4927	-
L4-2.7	2014-2013	4WD	234-9128	-	234-4926	-
L4-2.7	2014-2013	RWD	234-9128	-	234-4927	-
L4-2.7	2012-2011	Auto Trans; 4WD	234-9022	-	234-4624	234-4209

<sup>1</sup> 2 Required / Requis 2 / Requeridos 2



ENGINE MOTEUR MOTOR	YEAR ANNEE AÑO	APPLICATION INFORMATION INFORMATION D'APPLICATION INFORMACION DE APLICACION	UPSTREAM / AVANT - C.C. / ANTES DEL C.C.		DOWNSTREAM / APRES - C.C. / DESPUES DEL C.C.	
			TYPE / TIPO O.E.	UNIVERS.	TYPE / TIPO O.E.	UNIVERS.
<b>TOYOTA [cont]</b>						
<b>TACOMA [cont]</b>						
L4-2.7	2012-2011	Auto Trans; RWD	234-9022	-	234-4260	234-4209
L4-2.7	2012-2011	Manual Trans; 4WD	234-9050	-	234-4624	234-4209
L4-2.7	2012-2011	Manual Trans; RWD	234-9050	-	234-4260	234-4209
L4-2.7	2010-2007	RWD	234-9050	-	234-4260	234-4209
L4-2.7	2010-2005	4WD	234-9050	-	234-4624	234-4209
L4-2.7	2006-2005	RWD	234-9050	-	234-4261	234-4209
L4-2.7	2004-2003		234-9001	-	234-4189	234-4206
L4-2.7	2002-2001	4WD; Auto Trans	234-9001	-	234-4189	234-4206
L4-2.7	2002-2001	4WD; Manual Trans	234-9002	-	234-4189	234-4206
L4-2.7	2002-2001	RWD	234-9001	-	234-4189	234-4206
L4-2.7	2000	Calif.; Auto Trans	234-9001	-	234-4189	234-4206
L4-2.7	2000	Calif.; Manual Trans	234-9002	-	234-4189	234-4206
L4-2.7	2000	Exc. Calif.; 4WD; Auto Trans	234-4162	234-4206	234-4153	234-4206
L4-2.7	2000	Exc. Calif.; 4WD; Manual Trans	234-4162	234-4206	234-4162	234-4206
L4-2.7	2000	Exc. Calif.; RWD	234-4162	234-4206	234-4159	234-4206
L4-2.7	1999-1998	RWD	234-4162	234-4206	234-4159	234-4206
L4-2.7	1999	4WD; Auto Trans	234-4162	234-4206	234-4153	234-4206
L4-2.7	1999	4WD; Manual Trans	234-4162	234-4206	234-4162	234-4206
L4-2.7	1998	4WD	234-4162	234-4206	234-4162	234-4206
L4-2.7	1997-1995		234-4162	234-4206	234-4162	234-4206
V6-3.4	2004-2001	Auto Trans	234-9001	-	234-4189	234-4206
V6-3.4	2004-2001	Manual Trans	234-9003	-	234-4189	234-4206
V6-3.4	2000	Calif.; Auto Trans	234-9001	-	234-4189	234-4206
V6-3.4	2000	Calif.; Manual Trans	234-9003	-	234-4189	234-4206
V6-3.4	2000	Exc. Calif.; 4WD; Auto Trans	234-4162	234-4206	234-4162	234-4206
V6-3.4	2000	Exc. Calif.; 4WD; Manual Trans	234-4161	234-4206	234-4154	234-4206
V6-3.4	2000	Exc. Calif.; RWD; DLX; Auto Trans	234-4162	234-4206	234-4159	234-4206
V6-3.4	2000	Exc. Calif.; RWD; DLX; Manual Trans	234-4162	234-4206	234-4159	234-4206
V6-3.4	2000	Exc. Calif.; RWD; Pre-Runner	234-4162	234-4206	234-4153	234-4206
V6-3.4	1999-1995	4WD; Auto Trans	234-4162	234-4206	234-4162	234-4206
V6-3.4	1999-1995	4WD; Manual Trans	234-4161	234-4206	234-4154	234-4206
V6-3.4	1999	RWD; DLX; Auto Trans	234-4162	234-4206	234-4159	234-4206
V6-3.4	1999	RWD; DLX; Manual Trans	234-4153	234-4206	234-4159	234-4206
V6-3.4	1999	RWD; Pre-Runner	234-4162	234-4206	234-4153	234-4206
V6-3.4	1998	RWD; DLX; Manual Trans	234-4153	234-4206	234-4153	234-4206
V6-3.4	1998	RWD; DLX; Auto Trans	234-4162	234-4206	234-4153	234-4206
V6-3.4	1998	RWD; Pre-Runner	234-4162	234-4206	234-4159	234-4206
V6-3.4	1997-1995	RWD; Auto Trans	234-4162	234-4206	234-4153	234-4206
V6-3.4	1997-1995	RWD; Manual Trans	234-4153	234-4206	234-4153	234-4206
V6-4.0	2015		234-9145 <sup>4</sup>	-	234-4927 <sup>4</sup>	-
V6-4.0	2015		234-9145 <sup>5</sup>	-	234-4758 <sup>5</sup>	-

<sup>1</sup> 2 Required / Requis 2 / Requeridos 2 <sup>4</sup> Left Side / Côté gauche / Lado izquierdo <sup>5</sup> Right Side / Côté droit / Lado derecho



ENGINE MOTEUR MOTOR	YEAR ANNEE AÑO	APPLICATION INFORMATION INFORMATION D'APPLICATION INFORMACION DE APLICACION	UPSTREAM / AVANT - C.C. / ANTES DEL C.C.		DOWNSTREAM / APRS - C.C. / DESPUES DEL C.C.	
			TYPE / TIPO O.E.	UNIVERS.	TYPE / TIPO O.E.	UNIVERS.
<b>TOYOTA [cont]</b>						
<b>TACOMA [cont]</b>						
V6-4.0	2014-2012		234-9111 <sup>1</sup>	-	234-4758 <sup>1</sup>	-
V6-4.0	2011-2009		234-9067 <sup>4</sup>	-	234-4260 <sup>4</sup>	234-4209 <sup>4</sup>
V6-4.0	2011-2009		234-9084 <sup>5</sup>	-	234-4260 <sup>5</sup>	234-4209 <sup>5</sup>
V6-4.0	2008-2007		234-9026 <sup>1</sup>	-	234-4260 <sup>1</sup>	234-4209 <sup>1</sup>
V6-4.0	2006-2005		234-9026 <sup>4</sup>	-	234-4261 <sup>4</sup>	234-4209 <sup>4</sup>
V6-4.0	2006-2005		234-9026 <sup>5</sup>	-	234-4260 <sup>5</sup>	234-4209 <sup>5</sup>
<b>TERCEL</b>						
L4-1.5	1999-1997		234-2010	234-2000	234-4061	234-4209
L4-1.5	1996-1995		234-4622	234-4209	234-4061	234-4209
L4-1.5	1994-1991		234-2052	234-2050	-	-
L4-1.5	1990-1989		234-1051	234-1057	-	-
L4-1.5	1988-1987	VIN A	234-1056	234-1057	-	-
L4-1.5	1988-1987	VIN E	234-1051	234-1057	-	-
L4-1.5	1986-1983		234-1056	234-1057	-	-
L4-1.5	1982-1980		234-1051	234-1057	-	-
<b>TUNDRA</b>						
V6-3.4	2004-2001	Auto Trans	234-9001	-	234-4161	234-4206
V6-3.4	2004-2001	Manual Trans	234-9003	-	234-4161	234-4206
V6-3.4	2000	Calif.; Auto Trans	234-9001	-	234-4161	234-4206
V6-3.4	2000	Calif.; Manual Trans	234-9003	-	234-4161	234-4206
V6-3.4	2000	Exc. Calif.; Auto Trans	234-4162	234-4206	234-4161	234-4206
V6-3.4	2000	Exc. Calif.; Manual Trans	234-4161	234-4206	234-4161	234-4206
V6-4.0	2014-2013		234-9111 <sup>4</sup>	-	234-4758 <sup>4</sup>	-
V6-4.0	2014-2013		234-9111 <sup>5</sup>	-	234-4926 <sup>5</sup>	-
V6-4.0	2012-2011		234-9111 <sup>4</sup>	-	234-4260 <sup>4</sup>	234-4209 <sup>4</sup>
V6-4.0	2012-2011		234-9111 <sup>5</sup>	-	234-4624 <sup>5</sup>	234-4209 <sup>5</sup>
V6-4.0	2010-2007		234-9026 <sup>4</sup>	-	234-4260 <sup>4</sup>	234-4209 <sup>4</sup>
V6-4.0	2010-2007		234-9026 <sup>5</sup>	-	234-4624 <sup>5</sup>	234-4209 <sup>5</sup>
V6-4.0	2006-2005		234-9026 <sup>1</sup>	-	234-4260 <sup>1</sup>	234-4209 <sup>1</sup>
V8-4.6	2016-2014		234-9145 <sup>5</sup>	-	234-4926 <sup>5</sup>	-
V8-4.6	2016		234-9145 <sup>4</sup>	-	-	-
V8-4.6	2015		234-9145 <sup>4</sup>	-	234-4927 <sup>4</sup>	-
V8-4.6	2014		234-9145 <sup>4</sup>	-	234-4758 <sup>4</sup>	-
V8-4.6	2013-2010		234-9026 <sup>4</sup>	-	234-4260 <sup>4</sup>	234-4209 <sup>4</sup>
V8-4.6	2013-2010		234-9026 <sup>5</sup>	-	234-4624 <sup>5</sup>	234-4209 <sup>5</sup>
V8-4.7	2009-2007		234-9026 <sup>4</sup>	-	234-4260 <sup>4</sup>	234-4209 <sup>4</sup>
V8-4.7	2009-2007		234-9026 <sup>5</sup>	-	234-4624 <sup>5</sup>	234-4209 <sup>5</sup>
V8-4.7	2006-2005		234-9051 <sup>1</sup>	-	234-4260 <sup>1</sup>	234-4209 <sup>1</sup>
V8-4.7	2004-2003	4WD	234-4169 <sup>4</sup>	234-4209 <sup>4</sup>	234-4161 <sup>4</sup>	234-4206 <sup>4</sup>
V8-4.7	2004-2003	4WD	234-4169 <sup>5</sup>	234-4209 <sup>5</sup>	234-4162 <sup>5</sup>	234-4206 <sup>5</sup>

<sup>1</sup> 2 Required / Requis 2 / Requeridos 2 <sup>4</sup> Left Side / Côté gauche / Lado izquierdo <sup>5</sup> Right Side / Côté droit / Lado derecho



ENGINE MOTEUR MOTOR	YEAR ANNEE AÑO	APPLICATION INFORMATION INFORMATION D'APPLICATION INFORMACION DE APLICACION	UPSTREAM / AVANT - C.C. / ANTES DEL C.C.		DOWNSTREAM / APRS - C.C. / DESPUES DEL C.C.	
			TYPE / TIPO O.E.	UNIVERS.	TYPE / TIPO O.E.	UNIVERS.
<b>TOYOTA [cont]</b>						
<b>TUNDRA [cont]</b>						
V8-4.7	2004-2003	RWD	234-4169 <sup>1</sup>	234-4209 <sup>1</sup>	234-4161 <sup>1</sup>	234-4206 <sup>1</sup>
V8-4.7	2002-2000	4WD	234-4169 <sup>1</sup>	234-4209 <sup>1</sup>	234-4162 <sup>1</sup>	234-4206 <sup>1</sup>
V8-4.7	2002-2000	RWD	234-4169 <sup>1</sup>	234-4209 <sup>1</sup>	234-4154 <sup>1</sup>	234-4206 <sup>1</sup>
V8-5.7	2016-2015	Gas Engine	234-9145 <sup>4</sup>	-	234-4927 <sup>4</sup>	-
V8-5.7	2016-2014	Gas Engine	234-9145 <sup>5</sup>	-	234-4926 <sup>5</sup>	-
V8-5.7	2016	Flex Fuel Engine	234-9145 <sup>1</sup>	-	-	-
V8-5.7	2015-2014	Flex Fuel Engine	234-9111 <sup>4</sup>	-	234-4260 <sup>4</sup>	234-4209 <sup>4</sup>
V8-5.7	2015-2013	Flex Fuel Engine	234-9144 <sup>5</sup>	-	234-4624 <sup>5</sup>	234-4209 <sup>5</sup>
V8-5.7	2014	Gas Engine	234-9145 <sup>4</sup>	-	234-4758 <sup>4</sup>	-
V8-5.7	2013	Flex Fuel Engine	234-9145 <sup>4</sup>	-	234-4260 <sup>4</sup>	234-4209 <sup>4</sup>
V8-5.7	2013	Gas Engine	234-9111 <sup>4</sup>	-	234-4758 <sup>4</sup>	-
V8-5.7	2013	Gas Engine	234-9144 <sup>5</sup>	-	234-4926 <sup>5</sup>	-
V8-5.7	2012		234-9111 <sup>4</sup>	-	234-4260 <sup>4</sup>	234-4209 <sup>4</sup>
V8-5.7	2012		234-9144 <sup>5</sup>	-	234-4624 <sup>5</sup>	234-4209 <sup>5</sup>
V8-5.7	2011-2007		234-9026 <sup>4</sup>	-	234-4260 <sup>4</sup>	234-4209 <sup>4</sup>
V8-5.7	2011-2007		234-9026 <sup>5</sup>	-	234-4624 <sup>5</sup>	234-4209 <sup>5</sup>
<b>VAN</b>						
L4-2.0	1985-1984		234-1056	234-1057	-	-
L4-2.2	1989-1988		234-4055	234-4050	234-2062	234-2050
L4-2.2	1987-1986		234-1056	234-1057	-	-
<b>VAN WAGON</b>						
L4-2.2	1988		234-4055	234-4050	234-2062	234-2050
<b>VENZA</b>						
L4-2.7	2016-2015	Exc. Towing Package	234-9128	-	234-4949	-
L4-2.7	2016-2015	Towing Package	234-9141	-	234-4949	-
L4-2.7	2014-2013	Exc. Towing Package	234-9128	-	234-4389	-
L4-2.7	2014-2013	Towing Package	234-9141	-	234-4389	-
L4-2.7	2012-2009		234-9089	-	234-4389	-
V6-3.5	2016-2015		234-9154 <sup>4</sup>	-	234-4947 <sup>4</sup>	-
V6-3.5	2016-2015		234-9155 <sup>5</sup>	-	234-4306 <sup>5</sup>	-
V6-3.5	2014-2012		234-9114 <sup>5</sup>	-	234-4260 <sup>5</sup>	-
V6-3.5	2014-2012		234-9128 <sup>4</sup>	-	234-4306 <sup>4</sup>	234-4209 <sup>5</sup>
V6-3.5	2011		234-9022 <sup>5</sup>	-	234-4260 <sup>5</sup>	-
V6-3.5	2011		234-9008 <sup>4</sup>	-	234-4306 <sup>4</sup>	234-4209 <sup>5</sup>
V6-3.5	2010-2009		234-9022 <sup>5</sup>	-	234-4306 <sup>5</sup>	-
V6-3.5	2010-2009		234-9008 <sup>4</sup>	-	234-4260 <sup>4</sup>	234-4209 <sup>4</sup>
<b>YARIS</b>						
L4-1.5	2016-2015		234-9129	-	234-4996	-
L4-1.5	2014-2012	Hatchback	234-9129	-	234-4759	-

<sup>1</sup> 2 Required / Requis 2 / Requeridos 2 <sup>4</sup> Left Side / Côté gauche / Lado izquierdo <sup>5</sup> Right Side / Côté droit / Lado derecho



ENGINE MOTEUR MOTOR	YEAR ANNEE AÑO	APPLICATION INFORMATION INFORMATION D'APPLICATION INFORMACION DE APLICACION	UPSTREAM / AVANT - C.C. / ANTES DEL C.C.		DOWNSTREAM / APRS - C.C. / DESPUES DEL C.C.	
			TYPE / TIPO O.E.	UNIVERS.	TYPE / TIPO O.E.	UNIVERS.
<b>TOYOTA [cont]</b>						
<b>YARIS [cont]</b>						
L4-1.5	2014-2012	Sedan	234-9052	-	234-4069	234-4209
L4-1.5	2011-2006		234-9052	-	234-4069	234-4209
<b>VOLKSWAGEN</b>						
<b>BEETLE</b>						
L4-1.8	2015		234-5162	-	234-4935	-
L4-1.8	2014	From 06/30/2014	234-5162	-	234-4935	-
L4-1.8	2014	To 06/29/2014	234-5163	-	234-4935	-
L4-1.8	2005	w/ 20" Downstream Sensor	234-5102	-	234-4850	-
L4-1.8	2005	w/ 25" Downstream Sensor	234-5102	-	234-4859	-
L4-1.8	2004-2002		234-5115	-	234-4874	-
L4-1.8	2001-1999	APH Engine	234-5028	-	234-4859	-
L4-1.8	2001	AWV Engine	234-5115	-	234-4874	-
L4-1.9	2006-2004		234-5102	-	-	-
L4-2.0	2015	Diesel Engine	234-5036	-	-	-
L4-2.0	2015	Gas Engine; CPLA Engine	234-5145	-	-	-
L4-2.0	2015	Gas Engine; CPPA Engine	234-5145	-	234-4935	-
L4-2.0	2014-2013	Diesel Engine	234-5036	-	234-5116	-
L4-2.0	2014-2013	Gas Engine; CPLA Engine	234-5184	-	234-4935	-
L4-2.0	2014-2013	Gas Engine; CPPA Engine	234-5184	-	234-4935	-
L4-2.0	2013	Gas Engine; CBFA Engine	234-5142	-	234-4754	-
L4-2.0	2013	Gas Engine; CBFA Engine; Loc. Center	-	-	234-4829 <sup>12</sup>	-
L4-2.0	2013	Gas Engine; CCTA Engine	234-5141	-	234-4754	-
L4-2.0	2012	CBFA Engine	234-5142	-	234-4754	-
L4-2.0	2012	CBFA Engine; Loc. Center	-	-	234-4829 <sup>12</sup>	-
L4-2.0	2012	CCTA Engine	234-5141	-	234-4754	-
L4-2.0	2005-2002		234-5045	-	234-4808	-
L4-2.0	2001-1998	AEG Engine	234-4874	-	234-4859	-
L4-2.0	2001	AVH & AZG Engine	234-5045	-	234-4808	-
L5-2.5	2014-2012	CBTA Engine	234-5102	-	234-4754	-
L5-2.5	2014-2012	CBUA Engine	234-5102	-	234-4754	-
L5-2.5	2014-2012	CBUA Engine; Loc. Center	-	-	234-4829 <sup>12</sup>	-
L5-2.5	2010-2009	BPR Engine	234-5119	-	234-4859	-
L5-2.5	2010-2009	BPS Engine	234-5119	-	234-4859	-
L5-2.5	2010-2006	BPR Engine; Loc. Center	-	-	234-4850 <sup>12</sup>	-
L5-2.5	2008	BPR & BPS Engine; Convertible; From Chassis #1Y-8-412-897	234-5119	-	234-4859	-
L5-2.5	2008	BPR & BPS Engine; Convertible; To Chassis #1Y-8-412-896	234-5116	-	234-4859	-
L5-2.5	2008	BPR & BPS Engine; Hatchback; From Chassis #1C-8-514-950	234-5119	-	234-4859	-
L5-2.5	2008	BPR & BPS Engine; Hatchback; To Chassis #1C-8-514-949	234-5116	-	234-4859	-
L5-2.5	2007-2006	BPR Engine	234-5116	-	234-4859	-
L5-2.5	2007-2006	BPS Engine	234-5116	-	234-4859	-

<sup>12</sup> Loc. Center / Empl. central / Ubicación central



ENGINE MOTEUR MOTOR	YEAR ANNEE AÑO	APPLICATION INFORMATION INFORMATION D'APPLICATION INFORMACION DE APLICACION	UPSTREAM / AVANT - C.C. / ANTES DEL C.C.		DOWNSTREAM / APRS - C.C. / DESPUES DEL C.C.	
			TYPE / TIPO O.E.	UNIVERS.	TYPE / TIPO O.E.	UNIVERS.
<b>VOLKSWAGEN [cont]</b>						
<b>CABRIO</b>						
L4-2.0	2002-2000		234-4874	-	234-4874	-
L4-2.0	1999-1996		234-4663	234-4201	234-4666	234-4201
L4-2.0	1995		234-4665	234-4201	-	-
<b>CABRIOLET</b>						
L4-1.8	1993-1990	Calif.	234-3013	234-3000	-	-
L4-1.8	1993-1990	Exc. Calif.	234-3023	234-3000	-	-
L4-1.8	1989-1988		234-3048	234-3000	-	-
L4-1.8	1987	1 Lead Sensor	-	234-1000	-	-
L4-1.8	1987	3 Lead Sensor	234-3048	234-3000	-	-
L4-1.8	1986-1985		-	234-1000	-	-
<b>CC</b>						
L4-2.0	2015-2010	CBFA Engine	234-5036	-	234-4754	-
L4-2.0	2015-2009	CCTA Engine	234-5107	-	234-4754	-
L4-2.0	2015	CBFA Engine; Loc. Center	-	-	234-4829 <sup>12</sup>	-
L4-2.0	2014-2010	CBFA Engine; Loc. Center	234-4829 <sup>12</sup>	-	-	-
V6-3.6	2015-2009		234-5118 <sup>4</sup>	-	234-4833 <sup>4</sup>	-
V6-3.6	2015-2009		234-5108 <sup>5</sup>	-	234-4485 <sup>5</sup>	-
<b>CORRADO</b>						
L4-1.8	1992-1991		234-3013	234-3000	-	-
L4-1.8	1990		234-3023	234-3000	-	-
V6-2.8	1995-1992		234-4665	234-4201	-	-
<b>DASHER</b>						
L4-1.6	1980-1979		-	234-1000	-	-
<b>EOS</b>						
L4-2.0	2015-2009	CCTA Engine	234-5107	-	234-4754	-
L4-2.0	2015	CBFA Engine	234-5036	-	234-4829	-
L4-2.0	2015	CBFA Engine; Loc. Center	-	-	234-4754 <sup>12</sup>	-
L4-2.0	2014-2009	CBFA Engine	234-5036	-	234-4754	-
L4-2.0	2014-2009	CBFA Engine; Loc. Center	234-4829 <sup>12</sup>	-	-	-
L4-2.0	2009-2007	BPY Engine	234-5107	-	234-4754	-
V6-3.2	2008-2007		234-5102 <sup>4</sup>	-	234-4485 <sup>4</sup>	-
V6-3.2	2008-2007		234-5125 <sup>5</sup>	-	234-4485 <sup>5</sup>	-
<b>EUROVAN</b>						
L5-2.5	1996-1992		234-3013	234-3000	-	-
V6-2.8	2003-2001	AXK Engine	234-5115	-	234-4874	-
V6-2.8	2001-1999	AES Engine	234-4664	234-4200	234-4666	234-4201
V6-2.8	1997		234-4664	234-4200	234-4666	234-4201
<b>FOX</b>						
L4-1.8	1993-1991	Calif.	234-3013	234-3000	-	-

<sup>4</sup> Left Side / Côté gauche / Lado izquierdo <sup>5</sup> Right Side / Côté droit / Lado derecho <sup>12</sup> Loc. Center / Empl. central / Ubicación central



ENGINE MOTEUR MOTOR	YEAR ANNEE AÑO	APPLICATION INFORMATION INFORMATION D'APPLICATION INFORMACION DE APLICACION	UPSTREAM / AVANT - C.C. / ANTES DEL C.C.		DOWNSTREAM / APRS - C.C. / DESPUES DEL C.C.	
			TYPE / TIPO O.E.	UNIVERS.	TYPE / TIPO O.E.	UNIVERS.
<b>VOLKSWAGEN [cont]</b>						
<b>FOX [cont]</b>						
L4-1.8	1993-1991	Exc. Calif.	234-3023	234-3000	-	-
L4-1.8	1990-1988		234-3048	234-3000	-	-
L4-1.8	1987	1 Lead Sensor	-	234-1000	-	-
L4-1.8	1987	3 Lead Sensor	234-3048	234-3000	-	-
<b>GOLF</b>						
L4-1.8	2015	CXBA Engine	-	-	234-4992	-
L4-1.8	2015	CXBB Engine	-	-	234-4992	-
L4-1.8	2006-2002		234-5115	-	234-4874	-
L4-1.8	2001-2000	AWD Engine	234-4874	-	234-4859	-
L4-1.8	2001	AWW Engine	234-5115	-	234-4874	-
L4-1.8	1998-1993	1 Lead Sensor	-	234-1000	-	-
L4-1.8	1998-1993	3 Lead Sensor	234-3023	234-3000	-	-
L4-1.8	1992-1991	Calif.	234-3013	234-3000	-	-
L4-1.8	1992-1991	Exc. Calif.	234-3018	234-3000	-	-
L4-1.8	1990	Exc. PL Engine	234-3018	234-3000	-	-
L4-1.8	1989-1988	Exc. GTI 16-Valve	234-3018	234-3000	-	-
L4-1.8	1989-1988	GTI 16-Valve	234-3048	234-3000	-	-
L4-1.8	1987-1985	1 Lead Sensor	234-1011	234-1000	-	-
L4-1.8	1987-1985	3 Lead Sensor	234-3048	234-3000	-	-
L4-1.9	2006-2004		234-5102	-	-	-
L4-2.0	2015	Gas Engine	234-5185	-	234-4992	-
L4-2.0	2014-2012	Diesel Engine	234-5036	-	234-5116	-
L4-2.0	2013	Gas Engine; CBFA Engine	234-5036	-	234-4754	-
L4-2.0	2013	Gas Engine; CBFA Engine; Loc. Center	234-4829 <sup>12</sup>	-	-	-
L4-2.0	2013	Gas Engine; CCTA Engine	234-5107	-	234-4754	-
L4-2.0	2013	Gas Engine; CRZA Engine	234-5107	-	234-4829	-
L4-2.0	2012	Gas Engine	234-5107	-	234-4829	-
L4-2.0	2011-2010		234-5036	-	234-5116	-
L4-2.0	2006-2002		234-5045	-	234-4808	-
L4-2.0	2001-1999	AEG Engine	234-4874	-	234-4859	-
L4-2.0	1999-1997	ABA Engine; Canada Model; From Chassis #1H-W-000 001	234-4663	234-4201	234-4666	234-4201
L4-2.0	1999-1997	ABA Engine; Canada Model; To Chassis #1H-V-999 000	234-4665	234-4201	-	-
L4-2.0	1999-1997	ABA Engine; USA Model	234-4663	234-4201	234-4666	234-4201
L4-2.0	1996	Canada Model	234-4665	234-4201	-	-
L4-2.0	1996	USA Model; From Chassis #1H-T-000 001	234-4663	234-4201	234-4666	234-4201
L4-2.0	1996	USA Model; To Chassis #1H-S-999 000	234-4665	234-4201	-	-
L4-2.0	1995-1993		234-4665	234-4201	-	-
L4-2.0	1992-1990		234-3048	234-3000	-	-
L5-2.5	2014-2010	CBTA Engine	234-5102	-	234-4754	-
L5-2.5	2014-2010	CBUA Engine	234-5102	-	234-4754	-
L5-2.5	2014-2010	CBUA Engine; Loc. Center	-	-	234-4829 <sup>12</sup>	-

<sup>12</sup> Loc. Center / Empl. central / Ubicación central





ENGINE MOTEUR MOTOR	YEAR ANNEE AÑO	APPLICATION INFORMATION INFORMATION D'APPLICATION INFORMACION DE APLICACION	UPSTREAM / AVANT - C.C. / ANTES DEL C.C.		DOWNSTREAM / APRS - C.C. / DESPUES DEL C.C.	
			TYPE / TIPO O.E.	UNIVERS.	TYPE / TIPO O.E.	UNIVERS.
<b>VOLKSWAGEN [cont]</b>						
<b>GOLF [cont]</b>						
V6-2.8	2005-2003		234-5045	-	234-4809	-
V6-2.8	2002	AFP Engine	234-5045	-	234-4874	-
V6-2.8	2002	BDF Engine	234-5115	-	234-4809	-
V6-2.8	2001-1999	AFP Engine	234-5115	-	234-4874	-
V6-2.8	1998-1996	AAA Engine	234-4664	234-4200	234-4666	234-4201
V6-2.8	1995		234-4664	234-4200	-	-
V6-3.2	2004		234-5045 <sup>4</sup>	-	234-4809 <sup>4</sup>	-
V6-3.2	2004		234-5148 <sup>5</sup>	-	234-4808 <sup>5</sup>	-
<b>GOLF CITY</b>						
L4-2.0	2010-2007		234-5045	-	234-4808	-
<b>GOLF SPORTWAGEN</b>						
L4-1.8	2015		234-5143	-	234-4992	-
L4-2.0	2015		234-5036	-	-	-
<b>GTI</b>						
L4-2.0	2015	CXCA Engine	234-5185	-	234-4992	-
L4-2.0	2014-2008	CBFA Engine	234-5036	-	234-4754	-
L4-2.0	2014-2008	CBFA Engine; Loc. Center	234-4829 <sup>12</sup>	-	-	-
L4-2.0	2014-2008	CCTA Engine	234-5107	-	234-4754	-
L4-2.0	2008-2006	BPY Engine	234-5107	-	234-4754	-
<b>JETTA</b>						
L4-1.4	2015		234-5019	-	234-4933	-
L4-1.4	2014-2013		234-5019	-	234-4934	-
L4-1.4	2014-2013	Loc. Center	234-4933 <sup>12</sup>	-	-	-
L4-1.6	1980		-	234-1000	-	-
L4-1.7	1984-1981		-	234-1000	-	-
L4-1.8	2015		234-5162	-	234-4935	-
L4-1.8	2014		234-5163	-	234-4935	-
L4-1.8	2005-2002		234-5115	-	234-4874	-
L4-1.8	2001-2000	AWD Engine	234-4874	-	234-4859	-
L4-1.8	2001	AWW Engine	234-5115	-	234-4874	-
L4-1.8	1995-1993	1 Lead Sensor	-	234-1000	-	-
L4-1.8	1995-1993	3 Lead Sensor	234-3023	234-3000	-	-
L4-1.8	1992-1991	PF Engine	234-3018	234-3000	-	-
L4-1.8	1992-1991	RV Engine; Exc. Calif.	234-3018	234-3000	-	-
L4-1.8	1992	RV Engine; Calif.	234-3013	234-3000	-	-
L4-1.8	1991	RV Engine; Calif.; From Chassis #1G-M-020 636	234-3013	234-3000	-	-
L4-1.8	1991	RV Engine; Calif.; To Chassis #1G-M-020 635	234-3018	234-3000	-	-
L4-1.8	1990-1987	Sensor w/ 1 Connector	234-3018	234-3000	-	-
L4-1.8	1990	Sensor w/ 2 Connectors	-	234-3000	-	-
L4-1.8	1989-1987	Sensor w/ 2 Connectors	234-3048	234-3000	-	-
L4-1.8	1986-1985	GLi	234-3048	234-3000	-	-

<sup>4</sup> Left Side / Côté gauche / Lado izquierdo <sup>5</sup> Right Side / Côté droit / Lado derecho <sup>12</sup> Loc. Center / Empl. central / Ubicación central



ENGINE MOTEUR MOTOR	YEAR ANNEE AÑO	APPLICATION INFORMATION INFORMATION D'APPLICATION INFORMACION DE APLICACION	UPSTREAM / AVANT - C.C. / ANTES DEL C.C.		DOWNSTREAM / APRS - C.C. / DESPUES DEL C.C.	
			TYPE / TIPO O.E.	UNIVERS.	TYPE / TIPO O.E.	UNIVERS.
<b>VOLKSWAGEN [cont]</b>						
<b>JETTA [cont]</b>						
L4-1.8	1986-1984	Exc. GLi & GL	-	234-1000	-	-
L4-1.8	1986	GL	234-1011	234-1000	-	-
L4-1.8	1985	GX Engine	234-1011	234-1000	-	-
L4-1.9	2006-2005	BRM Engine	234-5036	-	-	-
L4-1.9	2005-2004	BEW Engine	234-5102	-	-	-
L4-2.0	2015-2013	Gas Engine; CBPA Engine	234-5036	-	234-4485	-
L4-2.0	2015-2009	Diesel Engine	234-5036	-	234-5116	-
L4-2.0	2015	Gas Engine; CBPA Engine; Loc. Center	-	-	234-4829 <sup>12</sup>	-
L4-2.0	2015	Gas Engine; CPLA Engine	234-5145	-	-	-
L4-2.0	2015	Gas Engine; CPPA Engine	234-5145	-	234-4935	-
L4-2.0	2014-2013	Gas Engine; CBPA Engine; Loc. Center	-	-	234-4485 <sup>12</sup>	-
L4-2.0	2014-2013	Gas Engine; CPLA Engine	234-5184	-	234-4935	-
L4-2.0	2014-2013	Gas Engine; CPPA Engine	234-5184	-	234-4935	-
L4-2.0	2013	Gas Engine; CBFA Engine	234-5142	-	234-4754	-
L4-2.0	2013	Gas Engine; CBFA Engine; Loc. Center	234-4829	-	-	-
L4-2.0	2013	Gas Engine; CCTA Engine	234-5141	-	234-4754	-
L4-2.0	2012	Gas Engine; Non-Turbo	234-5036	-	234-4485	-
L4-2.0	2012	Gas Engine; Turbo; CBFA Engine	234-5142	-	234-4754	-
L4-2.0	2012	Gas Engine; Turbo; CBFA Engine; Loc. Center	234-4829 <sup>12</sup>	-	-	-
L4-2.0	2012	Gas Engine; Turbo; CCTA Engine	234-5141	-	234-4754	-
L4-2.0	2011	Gas Engine	234-5036	-	234-4485	-
L4-2.0	2010-2009	Gas Engine; CBFA Engine	234-5036	-	234-4754	-
L4-2.0	2010-2009	Gas Engine; CBFA Engine; Loc. Center	234-4829 <sup>12</sup>	-	-	-
L4-2.0	2010-2009	Gas Engine; CCTA Engine	234-5107	-	234-4754	-
L4-2.0	2008-2006	BPY Engine	234-5107	-	234-4754	-
L4-2.0	2008	CBFA Engine	234-5036	-	234-4754	-
L4-2.0	2008	CBFA Engine; Loc. Center	234-4829 <sup>12</sup>	-	-	-
L4-2.0	2008	CCTA Engine	234-5107	-	234-4754	-
L4-2.0	2005-2004	BBW Engine	234-5045	-	234-4753	-
L4-2.0	2005-2004	BBW Engine; Loc. Center	-	-	234-4850 <sup>12</sup>	-
L4-2.0	2005	BEV Engine	234-4874	-	234-4808	-
L4-2.0	2004	Exc. BBW Engine; From Chassis #9M-4-000 001	234-4874	-	234-4808	-
L4-2.0	2004	Exc. BBW Engine; To Chassis #9M-3-999 000	234-5045	-	234-4808	-
L4-2.0	2003-2002		234-5045	-	234-4808	-
L4-2.0	2001-1999	AEG Engine	234-4874	-	234-4859	-
L4-2.0	2001	AVH & AZG Engine	234-5045	-	234-4808	-
L4-2.0	1999-1997	ABA Engine; Canada Model; From Chassis #1H-W-000 001	234-4663	234-4201	234-4666	234-4201
L4-2.0	1999-1997	ABA Engine; Canada Model; To Chassis #1H-V-999 000	234-4665	234-4201	-	-
L4-2.0	1999-1997	ABA Engine; USA Model	234-4663	234-4201	234-4666	234-4201
L4-2.0	1996	Canada Model	234-4665	234-4201	-	-
L4-2.0	1996	USA Model; From Chassis #1H-T-000 001	234-4663	234-4201	234-4666	234-4201

<sup>12</sup> Loc. Center / Empl. central / Ubicación central



ENGINE MOTEUR MOTOR	YEAR ANNEE AÑO	APPLICATION INFORMATION INFORMATION D'APPLICATION INFORMACION DE APLICACION	UPSTREAM / AVANT - C.C. / ANTES DEL C.C.		DOWNSTREAM / APRS - C.C. / DESPUES DEL C.C.	
			TYPE / TIPO O.E.	UNIVERS.	TYPE / TIPO O.E.	UNIVERS.
<b>VOLKSWAGEN [cont]</b>						
<b>JETTA [cont]</b>						
L4-2.0	1996	USA Model; To Chassis #1H-S-999 000	234-4665	234-4201	-	-
L4-2.0	1995-1993		234-4665	234-4201	-	-
L4-2.0	1992-1990		234-3048	234-3000	-	-
L5-2.5	2014-2013	CBTA Engine	234-5102	-	234-4754	-
L5-2.5	2014-2008	CBUA Engine	234-5102	-	234-4754	-
L5-2.5	2014-2008	CBUA Engine; Loc. Center	-	-	234-4829 <sup>12</sup>	-
L5-2.5	2012-2011	CBTA & CCCA Engine	234-5102	-	234-4754	-
L5-2.5	2010-2008	CBTA Engine	234-5102	-	234-4754	-
L5-2.5	2007-2005	BGP Engine	234-5102	-	234-4754	-
L5-2.5	2007-2005	BGQ Engine	234-5102	-	234-4754	-
L5-2.5	2007-2005	BGQ Engine; Loc. Center	-	-	234-4829 <sup>12</sup>	-
V6-2.8	2004-2002	BDF Engine	234-5045	-	234-4809	-
V6-2.8	2002-1999	AFP Engine	234-5115	-	234-4874	-
V6-2.8	1999-1997	AAA Engine	234-4664	234-4200	234-4666	234-4201
V6-2.8	1996	From Chassis #1H-T-000 001	234-4664	234-4200	234-4666	234-4201
V6-2.8	1996	To Chassis #1H-S-999 000	234-4665	234-4201	-	-
V6-2.8	1995		234-4664	234-4200	-	-
V6-2.8	1994		234-4665	234-4201	-	-
<b>JETTA CITY</b>						
L4-2.0	2009-2007		234-5045	-	234-4808	-
<b>PASSAT</b>						
L4-1.8	2015		234-5162	-	234-4935	-
L4-1.8	2014		234-5163	-	234-4935	-
L4-1.8	2005-2001	AWM Engine	234-5115	-	234-4874	-
L4-1.8	2001-2000	ATW Engine	234-4874	-	234-4874	-
L4-1.8	2001-2000	AUG Engine	234-4666	234-4201	234-4874	-
L4-1.8	1999-1998		234-4666	234-4201	234-4664	234-4200
L4-2.0	2015		234-5036	-	-	-
L4-2.0	2014-2012	Diesel Engine	234-5036	-	-	-
L4-2.0	2010	CBFA Engine	234-5036	-	234-4754	-
L4-2.0	2010	CBFA Engine; Loc. Center	234-4829 <sup>12</sup>	-	-	-
L4-2.0	2010	CCTA Engine	234-5107	-	234-4754	-
L4-2.0	2009-2006		234-5107	-	234-4754	-
L4-2.0	2005-2004		234-5116	-	-	-
L4-2.0	1996		234-4664	234-4200	234-4666	234-4201
L4-2.0	1995	From Chassis #3A-S-202 677	234-4533	-	-	-
L4-2.0	1995	To Chassis #3A-S-202 676	234-4709	234-4700	-	-
L4-2.0	1994		234-4666	234-4201	-	-
L4-2.0	1993-1991		234-3023	234-3000	-	-
L4-2.0	1990		234-3048	234-3000	-	-
L5-2.5	2014-2012	CBTA Engine	234-5102	-	234-4754	-

<sup>12</sup> Loc. Center / Empl. central / Ubicación central



ENGINE MOTEUR MOTOR	YEAR ANNEE AÑO	APPLICATION INFORMATION INFORMATION D'APPLICATION INFORMACION DE APLICACION	UPSTREAM / AVANT - C.C. / ANTES DEL C.C.		DOWNSTREAM / APRES - C.C. / DESPUES DEL C.C.	
			TYPE / TIPO O.E.	UNIVERS.	TYPE / TIPO O.E.	UNIVERS.
<b>VOLKSWAGEN [cont]</b>						
<b>PASSAT [cont]</b>						
L5-2.5	2014-2012	CBUA Engine	234-5102	-	234-4754	-
L5-2.5	2014-2012	CBUA Engine; Loc. Center	234-4829 <sup>12</sup>	-	-	-
V6-2.8	2005-2000		234-4812 <sup>1</sup>	-	234-4812 <sup>1</sup>	-
V6-2.8	1999-1998		234-4664 <sup>1</sup>	234-4200 <sup>1</sup>	234-4661 <sup>1</sup>	234-4201 <sup>1</sup>
V6-2.8	1997-1996		234-4664	234-4200	234-4666	234-4201
V6-2.8	1995	From Chassis #3A-S-086-001	234-4664	234-4200	234-4666	234-4201
V6-2.8	1995	To Chassis #3A-S-086-000	234-4664	234-4200	234-4665	234-4201
V6-2.8	1994-1993		234-4665	234-4201	-	-
V6-3.6	2015-2012		234-5102 <sup>4</sup>	-	234-4833 <sup>4</sup>	-
V6-3.6	2015-2012		234-5019 <sup>5</sup>	-	234-4833 <sup>5</sup>	-
V6-3.6	2010-2008		234-5118 <sup>4</sup>	-	234-4833 <sup>4</sup>	-
V6-3.6	2010-2008		234-5108 <sup>5</sup>	-	234-4485 <sup>5</sup>	-
V6-3.6	2007-2006		234-5118 <sup>4</sup>	-	234-4832 <sup>4</sup>	-
V6-3.6	2007-2006		234-5108 <sup>5</sup>	-	234-4849 <sup>5</sup>	-
V6-3.6	2007-2006	Loc. Center	-	-	234-4833 <sup>4,12</sup>	-
V6-3.6	2007-2006	Loc. Center	-	-	234-4485 <sup>5,12</sup>	-
W8-4.0	2004-2002		234-5129 <sup>4</sup>	-	234-4809 <sup>4</sup>	-
W8-4.0	2004-2002		234-5045 <sup>5</sup>	-	234-4809 <sup>5</sup>	-
<b>PASSAT CC</b>						
L4-2.0	2010-2009		234-5107	-	234-4754	-
V6-3.6	2010-2009		234-5118 <sup>4</sup>	-	234-4833 <sup>4</sup>	-
V6-3.6	2010-2009		234-5108 <sup>5</sup>	-	234-4485 <sup>5</sup>	-
<b>PHAETON</b>						
V8-4.2	2006-2004		234-5115 <sup>1</sup>	-	234-4874 <sup>1</sup>	-
W12-6.0	2006		234-5119 <sup>4,15</sup>	-	234-4809 <sup>4,15</sup>	-
W12-6.0	2006		234-5102 <sup>4,16</sup>	-	234-4809 <sup>4,16</sup>	-
W12-6.0	2006		234-5108 <sup>5,15</sup>	-	234-4809 <sup>5,15</sup>	-
W12-6.0	2006		234-5128 <sup>5,16</sup>	-	234-4809 <sup>5,16</sup>	-
W12-6.0	2005-2004		234-5115 <sup>4,15</sup>	-	234-4809 <sup>4,15</sup>	-
W12-6.0	2005-2004		234-5115 <sup>4,16</sup>	-	234-4809 <sup>4,16</sup>	-
W12-6.0	2005-2004		234-5117 <sup>5,15</sup>	-	234-4809 <sup>5,15</sup>	-
W12-6.0	2005-2004		234-5127 <sup>5,16</sup>	-	234-4809 <sup>5,16</sup>	-
<b>QUANTUM</b>						
L4-1.7	1983-1982		-	234-1000	-	-
L4-1.8	1985-1984		-	234-1000	-	-
L5-2.2	1988-1987		234-3019	234-3090	-	-
L5-2.2	1986	1 Lead Sensor	-	234-1000	-	-
L5-2.2	1986	3 Lead Sensor	234-3019	234-3090	-	-
L5-2.2	1985		234-1011	234-1000	-	-
L5-2.2	1984-1983		-	234-1000	-	-

<sup>1</sup> 2 Required / Requis 2 / Requeridos 2 <sup>4</sup> Left Side / Côté gauche / Lado izquierdo <sup>5</sup> Right Side / Côté droit / Lado derecho <sup>12</sup> Loc. Center / Empl. central / Ubicación central <sup>15</sup> Front / Avant / Parte delantera <sup>16</sup> Rear / Arrière / Parte trasera



ENGINE MOTEUR MOTOR	YEAR ANNEE AÑO	APPLICATION INFORMATION INFORMATION D'APPLICATION INFORMACION DE APLICACION	UPSTREAM / AVANT - C.C. / ANTES DEL C.C.		DOWNSTREAM / APRS - C.C. / DESPUES DEL C.C.	
			TYPE / TIPO O.E.	UNIVERS.	TYPE / TIPO O.E.	UNIVERS.
<b>VOLKSWAGEN [cont]</b>						
<b>R32</b>						
V6-3.2	2008		234-5102 <sup>4</sup>	-	234-4485 <sup>4</sup>	-
V6-3.2	2008		234-5125 <sup>5</sup>	-	234-4485 <sup>5</sup>	-
<b>RABBIT</b>						
L4-1.5	1980		-	234-1000	-	-
L4-1.6	1980		-	234-1000	-	-
L4-1.7	1984-1981		-	234-1000	-	-
L4-1.8	1984-1983		-	234-1000	-	-
L5-2.5	2009-2008	CBTA Engine	234-5102	-	234-4754	-
L5-2.5	2009-2008	CBUA Engine	234-5102	-	234-4754	-
L5-2.5	2009-2008	CBUA Engine; Loc. Center	-	-	234-4829 <sup>12</sup>	-
L5-2.5	2007-2006		234-5102	-	234-4754	-
<b>RABBIT CONVERTIBLE</b>						
L4-1.6	1980		-	234-1000	-	-
L4-1.7	1983-1981		-	234-1000	-	-
L4-1.8	1984		-	234-1000	-	-
<b>RABBIT PICKUP</b>						
L4-1.5	1980		-	234-1000	-	-
L4-1.6	1980		-	234-1000	-	-
L4-1.7	1983-1981		-	234-1000	-	-
<b>ROUTAN</b>						
V6-3.6	2014-2011		234-4545 <sup>4</sup>	-	234-4545 <sup>4</sup>	-
V6-3.6	2014-2011		234-4545 <sup>5</sup>	-	234-4553 <sup>5</sup>	-
V6-3.8	2010-2009		234-4881	-	234-4588	-
V6-4.0	2010-2009		234-4587 <sup>1</sup>	-	234-4587 <sup>1</sup>	-
<b>SCIROCCO</b>						
L4-1.6	1980-1979		-	234-1000	-	-
L4-1.7	1983-1981		-	234-1000	-	-
L4-1.8	1989-1984	1 Lead Sensor	-	234-1000	-	-
L4-1.8	1988-1986	3 Lead Sensor	234-3048	234-3000	-	-
<b>SUPER BEETLE</b>						
H4-1.6	1980		-	234-1000	-	-
<b>TIGUAN</b>						
L4-2.0	2015-2009		234-5034	-	234-4754	-
<b>TOUAREG</b>						
V6-3.0	2015-2011	Hybrid Engine	234-5114 <sup>4</sup>	-	234-4829 <sup>4</sup>	-
V6-3.0	2015-2011	Hybrid Engine	234-5036 <sup>5</sup>	-	234-4754 <sup>5</sup>	-
V6-3.0	2015-2009	Diesel Engine	234-5036	-	-	-
V6-3.2	2006-2004		234-5129 <sup>4</sup>	-	234-4809 <sup>4</sup>	-
V6-3.2	2006-2004		234-5129 <sup>5</sup>	-	234-4850 <sup>5</sup>	-

<sup>1</sup> 2 Required / Requis 2 / Requeridos 2 <sup>4</sup> Left Side / Côté gauche / Lado izquierdo <sup>5</sup> Right Side / Côté droit / Lado derecho <sup>12</sup> Loc. Center / Empl. central / Ubicación central



ENGINE MOTEUR MOTOR	YEAR ANNEE AÑO	APPLICATION INFORMATION INFORMATION D'APPLICATION INFORMACION DE APLICACION	UPSTREAM / AVANT - C.C. / ANTES DEL C.C.		DOWNSTREAM / APRS - C.C. / DESPUES DEL C.C.	
			TYPE / TIPO O.E.	UNIVERS.	TYPE / TIPO O.E.	UNIVERS.
<b>VOLKSWAGEN [cont]</b>						
<b>TOUAREG [cont]</b>						
V6-3.6	2015		234-5019 <sup>1</sup>	-	234-4829 <sup>1</sup>	-
V6-3.6	2014-2011		234-5019 <sup>4</sup>	-	234-4829 <sup>4</sup>	-
V6-3.6	2014-2011		234-5019 <sup>5</sup>	-	234-4754 <sup>5</sup>	-
V6-3.6	2010-2007		234-5019 <sup>4</sup>	-	234-4485 <sup>4</sup>	-
V6-3.6	2010-2007		234-5125 <sup>5</sup>	-	234-4485 <sup>5</sup>	-
V8-4.2	2009-2007	BAR Engine	234-5045 <sup>4</sup>	-	234-4843 <sup>4</sup>	-
V8-4.2	2009-2007	BAR Engine	234-5045 <sup>5</sup>	-	234-4833 <sup>5</sup>	-
V8-4.2	2007-2004	AXQ Engine	234-5115 <sup>1</sup>	-	234-4874 <sup>1</sup>	-
V10-4.9	2004		234-5115 <sup>4</sup>	-	-	-
V10-4.9	2004		234-5045 <sup>5</sup>	-	-	-
V10-5.0	2008-2006		234-5105 <sup>4</sup>	-	-	-
V10-5.0	2008-2006		234-5116 <sup>5</sup>	-	-	-
V10-5.0	2005		234-5102 <sup>1</sup>	-	-	-
<b>TRANSPORTER</b>						
H4-1.9	1985		-	234-1000	-	-
H4-2.0	1979		-	234-1000	-	-
H4-2.1	1991-1986		234-3028	234-3000	-	-
L5-2.5	1993-1992		234-3013	234-3000	-	-
<b>VANAGON</b>						
H4-1.9	1985-1983		-	234-1000	-	-
H4-2.0	1983-1980		-	234-1000	-	-
H4-2.1	1991-1986		234-3028	234-3000	-	-
<b>VOLVO</b>						
<b>240</b>						
L4-2.3	1993	Calif.	234-3135	234-3000	-	-
L4-2.3	1993	Exc. Calif.	234-3033	234-3090	-	-
L4-2.3	1992		-	234-3090	-	-
L4-2.3	1992	Base Model	234-3033	234-3090	-	-
L4-2.3	1992	GL Model; Exc. Regina Engine Control System	234-3033	234-3090	-	-
L4-2.3	1992	GL Model; Regina Engine Control System	234-3131	-	-	-
L4-2.3	1991-1990		234-3033	234-3090	-	-
<b>242</b>						
L4-2.1	1984-1977		234-1011	234-1000	-	-
L4-2.3	1984-1983		234-1011	234-1000	-	-
<b>244</b>						
L4-2.1	1985-1977		234-1011	234-1000	-	-
L4-2.3	1989		234-3033	234-3090	-	-
L4-2.3	1988		234-3028	234-3000	-	-
L4-2.3	1987-1986		234-3019	234-3090	-	-

<sup>1</sup> 2 Required / Requis 2 / Requeridos 2 <sup>4</sup> Left Side / Côté gauche / Lado izquierdo <sup>5</sup> Right Side / Côté droit / Lado derecho



ENGINE MOTEUR MOTOR	YEAR ANNEE AÑO	APPLICATION INFORMATION INFORMATION D'APPLICATION INFORMACION DE APLICACION	UPSTREAM / AVANT - C.C. / ANTES DEL C.C.		DOWNSTREAM / APRS - C.C. / DESPUES DEL C.C.	
			TYPE / TIPO O.E.	UNIVERS.	TYPE / TIPO O.E.	UNIVERS.
<b>VOLVO [cont]</b>						
<b>244 [cont]</b>						
L4-2.3	1985		234-3028	234-3000	-	-
L4-2.3	1984-1983		234-1011	234-1000	-	-
<b>245</b>						
L4-2.1	1985-1977		234-1011	234-1000	-	-
L4-2.3	1989		234-3033	234-3090	-	-
L4-2.3	1988		234-3028	234-3000	-	-
L4-2.3	1987-1986		234-3019	234-3090	-	-
L4-2.3	1985		234-3028	234-3000	-	-
L4-2.3	1984-1983		234-1011	234-1000	-	-
<b>262</b>						
V6-2.7	1979-1978		234-1015	234-1000	-	-
V6-2.8	1981-1980		234-1011	234-1000	-	-
<b>264</b>						
L4-2.1	1981-1980		234-1011	234-1000	-	-
V6-2.7	1979-1977		234-1015	234-1000	-	-
V6-2.8	1982-1980		234-1011	234-1000	-	-
<b>265</b>						
V6-2.7	1979-1977		234-1015	234-1000	-	-
V6-2.8	1981-1980		234-1011	234-1000	-	-
<b>740</b>						
L4-2.3	1992-1989	Non-Turbo; Exc. Regina Eng. Control System	234-3033	234-3090	-	-
L4-2.3	1992-1989	Non-Turbo; Regina Eng. Control System	234-3131	-	-	-
L4-2.3	1992-1985	Turbo	234-3019	234-3090	-	-
L4-2.3	1988-1985	Non-Turbo	234-3028	234-3000	-	-
<b>745</b>						
L4-2.3	1985	Non-Turbo	234-3028	234-3000	-	-
L4-2.3	1985	Turbo	234-3019	234-3090	-	-
<b>760</b>						
L4-2.3	1990-1984		234-3019	234-3090	-	-
V6-2.8	1990-1987		234-3033	234-3090	-	-
V6-2.8	1986-1985		234-3019	234-3090	-	-
V6-2.8	1984-1983		234-1011	234-1000	-	-
<b>780</b>						
L4-2.3	1991-1989		234-3019	234-3090	-	-
V6-2.8	1990-1987		234-3033	234-3090	-	-
<b>850</b>						
L5-2.3	1997-1994		234-4698	234-4201	234-4689	234-4201
L5-2.4	1997-1996		234-4698	234-4201	234-4689	234-4201
L5-2.4	1995	Air Pump	234-4698	234-4201	234-4689	234-4201
L5-2.4	1995	Exc. Air Pump	234-4182	234-4201	234-4689	234-4201
L5-2.4	1994	Air Pump	234-4697	234-4200	-	-



ENGINE MOTEUR MOTOR	YEAR ANNEE AÑO	APPLICATION INFORMATION INFORMATION D'APPLICATION INFORMACION DE APLICACION	UPSTREAM / AVANT - C.C. / ANTES DEL C.C.		DOWNSTREAM / APRS - C.C. / DESPUES DEL C.C.	
			TYPE / TIPO O.E.	UNIVERS.	TYPE / TIPO O.E.	UNIVERS.
<b>VOLVO [cont]</b>						
<b>850 [cont]</b>						
L5-2.4	1994	Exc. Air Pump	234-4182	234-4201	-	-
L5-2.4	1993	From Chassis #70019; Air Pump	234-4697	234-4200	-	-
L5-2.4	1993	From Chassis #70019; Exc. Air Pump	234-4182	234-4201	-	-
L5-2.4	1993	To Chassis #70018	234-4440	-	-	-
<b>940</b>						
L4-2.3	1995-1994	Non-Turbo; Exc. Regina Eng. Control System	234-3070	234-3000	-	-
L4-2.3	1995-1994	Non-Turbo; Regina Eng. Control System	234-3132	-	-	-
L4-2.3	1995-1994	Turbo; EGR Valve	234-3080	234-3000	-	-
L4-2.3	1995-1994	Turbo; Exc. EGR Valve	234-3070	234-3000	-	-
L4-2.3	1993-1992	Non-Turbo; B230F Engine; Exc. Regina Eng. Control System	234-3033	234-3090	-	-
L4-2.3	1993-1992	Non-Turbo; B230F Engine; Regina Eng. Control System	234-3131	-	-	-
L4-2.3	1993-1992	Turbo	234-3019	234-3090	-	-
L4-2.3	1992	Non-Turbo; B234F Engine	234-3019	234-3090	-	-
L4-2.3	1991		234-3019	234-3090	-	-
<b>960</b>						
L6-2.9	1997-1996		234-4699	234-4201	234-4689	234-4201
L6-2.9	1995		234-4699	234-4201	-	-
L6-2.9	1994-1992		234-3033	234-3090	-	-
<b>C30</b>						
L5-2.4	2010-2007		234-9150	-	234-4454	-
L5-2.5	2013-2007		234-5702	-	234-4861	-
<b>C70</b>						
L5-2.3	2004-2000		234-5700	-	234-4863	-
L5-2.3	1999		234-5702	-	234-4863	-
L5-2.3	1998		234-4698	234-4201	234-4698	234-4201
L5-2.4	2004-2000		234-5700	-	234-4863	-
L5-2.4	1999		234-5702	-	234-4863	-
L5-2.4	1998		234-4698	234-4201	234-4698	234-4201
L5-2.5	2013-2006		234-5702	-	234-4861	-
<b>DL</b>						
L4-2.1	1984		234-1011	234-1000	-	-
<b>GLE</b>						
L4-2.3	1984		234-1011	234-1000	-	-
<b>S40</b>						
L4-1.9	2004-2000		234-4860	-	234-4862	-
L5-2.4	2010-2007	B5244S7 Engine	234-9150	-	234-4454	-
L5-2.4	2010-2005	B5244S4 Engine	234-9150	-	234-4454	-
L5-2.4	2010-2005	B5244S7 Engine; Loc. Center	234-4734 <sup>12</sup>	-	-	-
L5-2.4	2006-2005	B5244S7 Engine	234-9150	-	234-4450	-
L5-2.4	2004		234-9150	-	234-4454	-
L5-2.5	2011-2004		234-5702	-	234-4861	-

<sup>12</sup> Loc. Center / Empl. central / Ubicación central





ENGINE MOTEUR MOTOR	YEAR ANNEE AÑO	APPLICATION INFORMATION INFORMATION D'APPLICATION INFORMACION DE APLICACION	UPSTREAM / AVANT - C.C. / ANTES DEL C.C.		DOWNSTREAM / APRS - C.C. / DESPUES DEL C.C.	
			TYPE / TIPO O.E.	UNIVERS.	TYPE / TIPO O.E.	UNIVERS.
<b>VOLVO [cont]</b>						
<b>S60</b>						
L4-2.0	2015	B4204T11 Engine	234-9156	-	234-4941	-
L4-2.0	2015	B4204T11 Engine; Loc. Center	-	-	234-4600 <sup>12</sup>	-
L4-2.0	2015	B4204T9 Engine	234-9156	-	234-4600 <sup>1</sup>	-
L5-2.3	2004-2001		234-5700	-	234-4863	-
L5-2.4	2009-2006		234-5700	-	234-4861	-
L5-2.4	2005	Non-Turbo; Emissions Code A; B5244S Engine	234-9151	-	234-4453	-
L5-2.4	2005	Non-Turbo; Emissions Code A; B5244S6 Engine	234-9150	-	234-4453	-
L5-2.4	2005	Non-Turbo; Exc. Emissions Code A; B5244S Engine	234-9151	-	234-4450	-
L5-2.4	2005	Non-Turbo; Exc. Emissions Code A; B5244S6 Engine	234-9150	-	234-4450	-
L5-2.4	2005	Turbo	234-5700	-	234-4861	-
L5-2.4	2004	Non-Turbo	234-9151	-	234-4450	-
L5-2.4	2003-2001	Turbo	234-5700	-	234-4863	-
L5-2.4	2003	Non-Turbo; B5244S Engine	234-9151	-	234-4450	-
L5-2.4	2003	Non-Turbo; B5244S6 Engine	234-9150	-	234-4450	-
L5-2.4	2002	Non-Turbo	234-9019	-	234-4452	-
L5-2.4	2001	Non-Turbo	234-9019	-	234-4755	-
L5-2.5	2014-2013		234-9137	-	234-4932	-
L5-2.5	2012		234-5702	-	234-4861	-
L5-2.5	2009-2005		234-5700	-	234-4861	-
L5-2.5	2004-2003		234-5700	-	234-4864	-
L6-3.0	2015	From Chassis #22625	234-9151	-	234-4454	-
L6-3.0	2015	From Chassis 10779	234-9151	-	234-4454	-
L6-3.0	2015	To Chassis #22624	234-9151	-	234-4453	-
L6-3.0	2015	To Chassis 10778	234-9151	-	234-4453	-
L6-3.0	2014		234-9151	-	234-4453	-
L6-3.0	2013		234-9151	-	234-4454	-
L6-3.0	2012-2011		234-9151	-	234-4453	-
<b>S70</b>						
L5-2.3	2000		234-5700	-	234-4863	-
L5-2.3	1999		234-5702	-	234-4863	-
L5-2.3	1998		234-4698	234-4201	234-4689	234-4201
L5-2.4	2000-1999	Non-Turbo	234-9020	-	234-4734	-
L5-2.4	2000	Turbo	234-5700	-	234-4863	-
L5-2.4	1999	Turbo	234-5702	-	234-4863	-
L5-2.4	1998	Non-Turbo	234-4698	234-4201	234-4689	234-4201
L5-2.4	1998	Turbo	234-4698	234-4201	234-4698	234-4201
<b>S80</b>						
L4-2.0	2015		234-9156	-	234-4941	-
L4-2.0	2015	Loc. Center	-	-	234-4600 <sup>12</sup>	-
L5-2.5	2006-2005		234-5700	-	234-4861	-

<sup>1</sup> 2 Required / Requis 2 / Requeridos 2 <sup>12</sup> Loc. Center / Empl. central / Ubicación central



ENGINE MOTEUR MOTOR	YEAR ANNEE AÑO	APPLICATION INFORMATION INFORMATION D'APPLICATION INFORMACION DE APLICACION	UPSTREAM / AVANT - C.C. / ANTES DEL C.C.		DOWNSTREAM / APRS - C.C. / DESPUES DEL C.C.	
			TYPE / TIPO O.E.	UNIVERS.	TYPE / TIPO O.E.	UNIVERS.
<b>VOLVO [cont]</b>						
<b>S80 [cont]</b>						
L5-2.5	2004		234-5700	-	234-4864	-
L6-2.8	2001-1999		234-5703 <sup>1</sup>	-	234-4866 <sup>1</sup>	-
L6-2.9	2005-2003		234-5703 <sup>4</sup>	-	234-4865 <sup>4</sup>	-
L6-2.9	2005-2003		234-5701 <sup>5</sup>	-	234-4861 <sup>5</sup>	-
L6-2.9	2002		234-5703 <sup>4</sup>	-	234-4867 <sup>4</sup>	-
L6-2.9	2002		234-5701 <sup>5</sup>	-	234-4865 <sup>5</sup>	-
L6-2.9	2001-2000		234-5702 <sup>4</sup>	-	234-4867 <sup>4</sup>	-
L6-2.9	2001-2000		234-5705 <sup>5</sup>	-	234-4867 <sup>5</sup>	-
L6-2.9	1999		234-5703 <sup>1</sup>	-	234-4866 <sup>1</sup>	-
L6-3.0	2015-2011		234-9151	-	234-4454	-
L6-3.0	2010-2008		234-9151	-	234-4453	-
L6-3.2	2014-2011	B632455 Engine	234-9151 <sup>1</sup>	-	234-4454 <sup>1</sup>	-
L6-3.2	2014	B632454 Engine	234-9151	-	234-4453	-
L6-3.2	2014	B632454 Engine; Loc. Center	234-4487	-	-	-
L6-3.2	2013-2011	B632454 Engine	234-9151	-	234-4454	-
L6-3.2	2013-2011	B632454 Engine; Loc. Center	234-4487 <sup>12</sup>	-	-	-
L6-3.2	2010	B63245 Engine	234-9151 <sup>1</sup>	-	234-4454 <sup>1</sup>	-
L6-3.2	2010	B632452 Engine	234-9151	-	234-4453	-
L6-3.2	2010	B632452 Engine; Loc. Center	234-4487 <sup>12</sup>	-	-	-
L6-3.2	2009-2007		234-9151 <sup>1</sup>	-	234-4454 <sup>1</sup>	-
V8-4.4	2010-2007		234-9152 <sup>4</sup>	-	234-4453 <sup>4</sup>	-
V8-4.4	2010-2007		234-9152 <sup>5</sup>	-	234-4451 <sup>5</sup>	-
<b>S90</b>						
L6-2.9	1998-1997		234-4699	234-4201	234-4689	234-4201
<b>V40</b>						
L4-1.9	2004-2000		234-4860	-	234-4862	-
<b>V50</b>						
L5-2.4	2010-2007	B524457 Engine	234-9150	-	234-4454	-
L5-2.4	2010-2005	B524454 Engine	234-9150	-	234-4454	-
L5-2.4	2010-2005	B524457 Engine; Loc. Center	234-4734 <sup>12</sup>	-	-	-
L5-2.4	2006-2005	B524457 Engine	234-9150	-	234-4450	-
L5-2.5	2011-2005		234-5702	-	234-4861	-
<b>V60</b>						
L4-2.0	2015		234-9156	-	234-4941	-
L4-2.0	2015	Loc. Center	-	-	234-4600 <sup>12</sup>	-
L6-3.0	2015	From Chassis 10779	234-9151	-	234-4454	-
L6-3.0	2015	To Chassis 10778	234-9151	-	234-4453	-
<b>V70</b>						
L5-2.3	2004-2000		234-5700	-	234-4863	-
L5-2.3	1999		234-5702	-	234-4863	-

<sup>1</sup> 2 Required / Requis 2 / Requeridos 2 <sup>4</sup> Left Side / Côté gauche / Lado izquierdo <sup>5</sup> Right Side / Côté droit / Lado derecho <sup>12</sup> Loc. Center / Empl. central / Ubicación central



ENGINE MOTEUR MOTOR	YEAR ANNEE AÑO	APPLICATION INFORMATION INFORMATION D'APPLICATION INFORMACION DE APLICACION	UPSTREAM / AVANT - C.C. / ANTES DEL C.C.		DOWNSTREAM / APRS - C.C. / DESPUES DEL C.C.	
			TYPE / TIPO O.E.	UNIVERS.	TYPE / TIPO O.E.	UNIVERS.
<b>VOLVO [cont]</b>						
<b>V70 [cont]</b>						
L5-2.3	1998		234-4698	234-4201	234-4698	234-4201
L5-2.4	2007	Emissions Code A	234-9151	-	234-4453	-
L5-2.4	2007	Exc. Emissions Code A	234-9151	-	234-4450	-
L5-2.4	2006	Emissions Code A; B5244S Engine	234-9151	-	234-4453	-
L5-2.4	2006	Emissions Code A; B5244S6 Engine	234-9150	-	234-4453	-
L5-2.4	2006	Exc. Emissions Code A; B5244S Engine	234-9151	-	234-4450	-
L5-2.4	2006	Exc. Emissions Code A; B5244S6 Engine	234-9150	-	234-4450	-
L5-2.4	2005	Non-Turbo; Emissions Code A; B5244S Engine	234-9151	-	234-4453	-
L5-2.4	2005	Non-Turbo; Emissions Code A; B5244S6 Engine	234-9150	-	234-4453	-
L5-2.4	2005	Non-Turbo; Exc. Emissions Code A; B5244S Engine	234-9151	-	234-4450	-
L5-2.4	2005	Non-Turbo; Exc. Emissions Code A; B5244S6 Engine	234-9150	-	234-4450	-
L5-2.4	2005	Turbo	234-5700	-	234-4861	-
L5-2.4	2004		234-9151	-	234-4450	-
L5-2.4	2003-2000	Turbo	234-5700	-	234-4863	-
L5-2.4	2003	Non-Turbo, B5244S Engine	234-9150	-	234-4450	-
L5-2.4	2003	Non-Turbo, B5244S6 Engine	234-9151	-	234-4450	-
L5-2.4	2002	Non-Turbo	234-9019	-	234-4452	-
L5-2.4	2001	Non-Turbo	234-9019	-	234-4755	-
L5-2.4	2000-1999	Non-Turbo	234-9020	-	234-4734	-
L5-2.4	1999	Turbo	234-5702	-	234-4863	-
L5-2.4	1998	Non-Turbo	234-4698	234-4201	234-4689	234-4201
L5-2.4	1998	Turbo	234-4698	234-4201	234-4698	234-4201
L5-2.5	2007-2005		234-5700	-	234-4861	-
L5-2.5	2004-2003		234-5700	-	234-4864	-
L6-3.2	2010	B6324S Engine	234-9151 <sup>1</sup>	-	234-4454 <sup>1</sup>	-
L6-3.2	2010	B6324S2 Engine	234-9151	-	234-4453	-
L6-3.2	2010	B6324S2 Engine; Loc. Center	234-4487 <sup>12</sup>	-	-	-
L6-3.2	2009-2008		234-9151 <sup>1</sup>	-	234-4454 <sup>1</sup>	-
<b>V90</b>						
L6-2.9	1998-1997		234-4699	234-4201	234-4689	234-4201
<b>XC60</b>						
L4-2.0	2015	B4204T11 Engine	234-9156	-	234-4941	-
L4-2.0	2015	B4204T11 Engine; Loc. Center	-	-	234-4600 <sup>12</sup>	-
L4-2.0	2015	B4204T9 Engine	234-9156	-	234-4600 <sup>1</sup>	-
L5-2.5	2015		234-9137	-	234-4932	-
L6-3.0	2015	From Chassis #179185	234-9151	-	234-4454	-
L6-3.0	2015	To Chassis #179184	234-9151	-	234-4453	-
L6-3.0	2014-2013		234-9151	-	234-4454	-
L6-3.0	2012	From Chassis/VIN #179185	234-9151	-	234-4454	-
L6-3.0	2012	To Chassis/VIN #179184	234-9151	-	234-4453	-
L6-3.0	2011-2010		234-9151	-	234-4453	-

<sup>1</sup> 2 Required / Requis 2 / Requeridos 2 <sup>12</sup> Loc. Center / Empl. central / Ubicación central



ENGINE MOTEUR MOTOR	YEAR ANNEE AÑO	APPLICATION INFORMATION INFORMATION D'APPLICATION INFORMACION DE APLICACION	UPSTREAM / AVANT - C.C. / ANTES DEL C.C.		DOWNSTREAM / APRS - C.C. / DESPUES DEL C.C.	
			TYPE / TIPO O.E.	UNIVERS.	TYPE / TIPO O.E.	UNIVERS.
<b>VOLVO [cont]</b>						
<b>XC60 [cont]</b>						
L6-3.2	2014-2011	B6324S4 Engine	234-9151	-	234-4453	-
L6-3.2	2014-2011	B6324S5 Engine	234-9151 <sup>1</sup>	-	234-4454 <sup>1</sup>	-
L6-3.2	2014	B6324S4 Engine; Loc. Center	234-4487	-	-	-
L6-3.2	2013-2011	B6324S4 Engine; Loc. Center	234-4487 <sup>12</sup>	-	-	-
L6-3.2	2010	B6324S Engine	234-9151 <sup>1</sup>	-	234-4454 <sup>1</sup>	-
L6-3.2	2010	B6324S2 Engine	234-9151	-	234-4453	-
L6-3.2	2010	B6324S2 Engine; Loc. Center	234-4487 <sup>12</sup>	-	-	-
<b>XC70</b>						
L4-2.0	2015		234-9156	-	234-4941	-
L4-2.0	2015	Loc. Center	-	-	234-4600 <sup>12</sup>	-
L5-2.5	2007-2005		234-5700	-	234-4861	-
L5-2.5	2004-2003		234-5700	-	234-4864	-
L6-3.0	2015-2011		234-9151	-	234-4454	-
L6-3.0	2010-2009		234-9151	-	234-4453	-
L6-3.2	2015-2014	B6324S4 Engine	234-9151	-	234-4453	-
L6-3.2	2015	B6324S4 Engine; Loc. Center	-	-	234-4487	-
L6-3.2	2014-2011	B6324S5 Engine	234-9151 <sup>1</sup>	-	234-4454 <sup>1</sup>	-
L6-3.2	2014	B6324S4 Engine; Loc. Center	234-4487	-	-	-
L6-3.2	2013-2011	B6324S4 Engine	234-9151	-	234-4454	-
L6-3.2	2013-2011	B6324S4 Engine; Loc. Center	234-4487 <sup>12</sup>	-	-	-
L6-3.2	2010	B6324S Engine	234-9151 <sup>1</sup>	-	234-4454 <sup>1</sup>	-
L6-3.2	2010	B6324S2 Engine	234-9151	-	234-4453	-
L6-3.2	2010	B6324S2 Engine; Loc. Center	234-4487 <sup>12</sup>	-	-	-
L6-3.2	2009-2008		234-9151 <sup>1</sup>	-	234-4454 <sup>1</sup>	-
<b>XC90</b>						
L5-2.5	2006-2005		234-5700	-	234-4861	-
L5-2.5	2004-2003		234-5700	-	234-4864	-
L6-2.9	2005-2003		234-5703 <sup>4</sup>	-	234-4865	-
L6-2.9	2005-2003		234-5701 <sup>5</sup>	-	-	-
L6-3.2	2014-2007		234-9151 <sup>4</sup>	-	234-4450 <sup>4</sup>	-
L6-3.2	2014-2007		234-9151 <sup>5</sup>	-	234-4451 <sup>5</sup>	-
V8-4.4	2011-2005		234-9152 <sup>4</sup>	-	234-4453 <sup>4</sup>	-
V8-4.4	2011-2005		234-9152 <sup>5</sup>	-	234-4451 <sup>5</sup>	-

<sup>1</sup> 2 Required / Requis 2 / Requeridos 2 <sup>4</sup> Left Side / Côté gauche / Lado izquierdo <sup>5</sup> Right Side / Côté droit / Lado derecho <sup>12</sup> Loc. Center / Empl. central / Ubicación central



*first time fit*

PRODUCT INFORMATION



OXYGEN & AIR/FUEL SENSOR

## Lead Wire Length

The photo guide describes sensor lead wire length in the following perspective:

Measure from the bottom of the hex/flange to the end of the connector.

### 234-3052

Flange Gasket / Bride Joint /  
 Empaque del reborde (in/cm): 44

Lead Wire / Fil de Sortie /  
 Alambre Lider (in/cm): 19.84 / 50.39

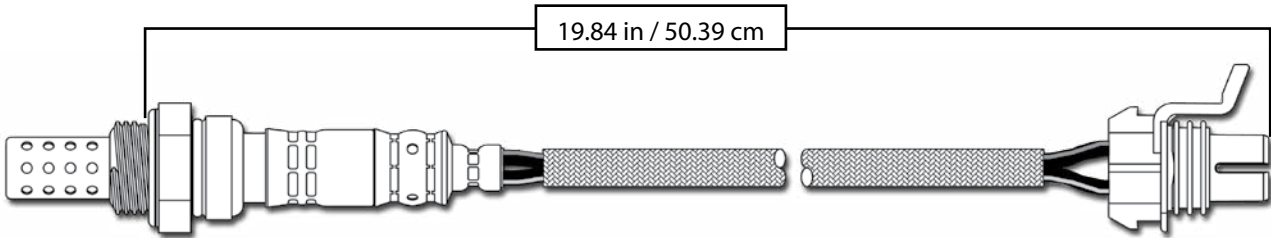
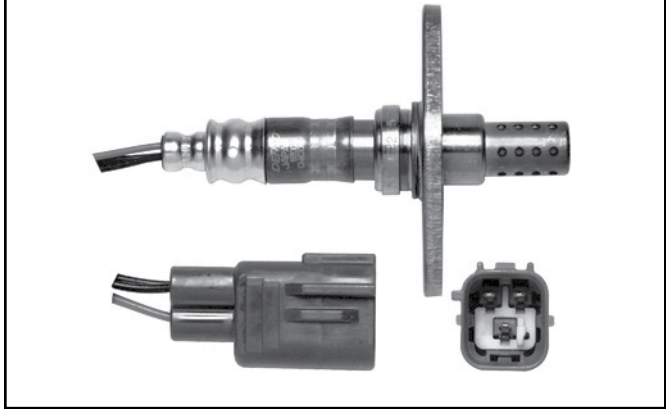

## Flange Gasket Measurement

Measure from the center of one mounting hole to the center of the other.

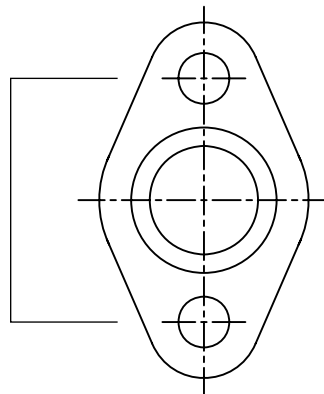

## SENSOR 4-WIRE COLOR COMPARISON

BRAND	SIGNAL	GROUND	HEATER	HEATER
Bosch	Black	Gray	White	White
Chrysler	Black	Gray	White	White
<b>DENSO</b>	Blue	White	Black	Black
Ford	Black	Gray	White	White
GM	Purple	Tan	Brown	Brown
Honda	White	Green	Black	Black
Isuzu	Blue	White	Black	Black
Mazda	Black	Red	White	White
Nissan	Black	Gray	White	White
NTK	Black	Gray	White	White

MARQUE	SIGNAL	MISE À LA TERRE	DISPOSITIF DE CHAUFFAGE	DISPOSITIF DE CHAUFFAGE
Bosch	Noir	Gris	Blanc	Blanc
Chrysler	Noir	Gris	Blanc	Blanc
<b>DENSO</b>	Bleu	Blanc	Noir	Noir
Ford	Noir	Gris	Blanc	Blanc
GM	Violet	Fauve	Marron	Marron
Honda	Blanc	Vert	Noir	Noir
Isuzu	Bleu	Blanc	Noir	Noir
Mazda	Noir	Rouge	Blanc	Blanc
Nissan	Noir	Gris	Blanc	Blanc
NTK	Noir	Gris	Blanc	Blanc

MARCA	CABLE DE SEÑAL	CABLE A TIERRA	CALENTADOR	CALENTADOR
Bosch	Negro	Gris	Blanco	Blanco
Chrysler	Negro	Gris	Blanco	Blanco
<b>DENSO</b>	Azul	Blanco	Negro	Negro
Ford	Negro	Gris	Blanco	Blanco
GM	Púrpura	Marrón claro	Marrón oscuro	Marrón oscuro
Honda	Blanco	Verde	Negro	Negro
Isuzu	Azul	Blanco	Negro	Negro
Mazda	Negro	Rojo	Blanco	Blanco
Nissan	Negro	Gris	Blanco	Blanco
NTK	Negro	Gris	Blanco	Blanco



**234-1000 Univers.**

Lead Wire / Fil de Sortie /  
Alambre Líder (in/cm): 11.77 / 29.90



**234-1003**

Lead Wire / Fil de Sortie /  
Alambre Líder (in/cm): 9.06 / 23.00



**234-1001**

Lead Wire / Fil de Sortie /  
Alambre Líder (in/cm): 14.57 / 37.00



**234-1004**

Lead Wire / Fil de Sortie /  
Alambre Líder (in/cm): 16.81 / 42.70



**234-1002**

Lead Wire / Fil de Sortie /  
Alambre Líder (in/cm): 6.81 / 17.30



**234-1005**

Lead Wire / Fil de Sortie /  
Alambre Líder (in/cm): 19.80 / 50.29







**234-1006**

Lead Wire / Fil de Sortie /  
Alambre Líder (in/cm): 9.06 / 23.00



**234-1009**

Lead Wire / Fil de Sortie /  
Alambre Líder (in/cm): 18.82 / 47.80



**234-1007**

Lead Wire / Fil de Sortie /  
Alambre Líder (in/cm): 31.81 / 80.80



**234-1010**

Lead Wire / Fil de Sortie /  
Alambre Líder (in/cm): 18.82 / 47.80



**234-1008**

Lead Wire / Fil de Sortie /  
Alambre Líder (in/cm): 24.41 / 62.00



**234-1011**

Lead Wire / Fil de Sortie /  
Alambre Líder (in/cm): 21.81 / 55.40





**234-1012**

Lead Wire / Fil de Sortie /  
Alambre Líder (in/cm): 25.79 / 65.50



**234-1015**

Lead Wire / Fil de Sortie /  
Alambre Líder (in/cm): 38.82 / 98.60



**234-1013**

Lead Wire / Fil de Sortie /  
Alambre Líder (in/cm): 9.80 / 24.90



**234-1016**

Lead Wire / Fil de Sortie /  
Alambre Líder (in/cm): 16.81 / 42.70



**234-1014**

Lead Wire / Fil de Sortie /  
Alambre Líder (in/cm): 41.81 / 106.20



**234-1017**

Lead Wire / Fil de Sortie /  
Alambre Líder (in/cm): 13.78 / 35.00





**234-1018**

Lead Wire / Fil de Sortie /  
Alambre Líder (in/cm): 21.85 / 55.50



**234-1021**

Lead Wire / Fil de Sortie /  
Alambre Líder (in/cm): 25.59 / 65.00



**234-1019**

Lead Wire / Fil de Sortie /  
Alambre Líder (in/cm): 22.83 / 58.00



**234-1022**

Lead Wire / Fil de Sortie /  
Alambre Líder (in/cm): 8.78 / 22.30



**234-1020**

Lead Wire / Fil de Sortie /  
Alambre Líder (in/cm): 21.81 / 55.40



**234-1023**

Lead Wire / Fil de Sortie /  
Alambre Líder (in/cm): 15.87 / 40.30





**234-1024**

Lead Wire / Fil de Sortie /  
Alambre Líder (in/cm): 21.65 / 55.00



**234-1030**

Lead Wire / Fil de Sortie /  
Alambre Líder (in/cm): 4.57 / 11.60



**234-1025**

Lead Wire / Fil de Sortie /  
Alambre Líder (in/cm): 6.81 / 17.30



**234-1033**

Lead Wire / Fil de Sortie /  
Alambre Líder (in/cm): 18.90 / 48.00



**234-1029**

Lead Wire / Fil de Sortie /  
Alambre Líder (in/cm): 5.51 / 14.00



**234-1034**

Lead Wire / Fil de Sortie /  
Alambre Líder (in/cm): 14.69 / 37.30





**234-1040**

Lead Wire / Fil de Sortie /  
Alambre Líder (in/cm): 13.46 / 34.20



**234-1053**

Flange Gasket / Bride Joint /  
Empaque del reborde (in/cm): 1.73 / 4.4

Lead Wire / Fil de Sortie /  
Alambre Líder (in/cm): 12.80 / 32.50



**234-1051**

Flange Gasket / Bride Joint /  
Empaque del reborde (in/cm): 1.73 / 4.4

Lead Wire / Fil de Sortie /  
Alambre Líder (in/cm): 13.82 / 35.10



**234-1055**

Flange Gasket / Bride Joint /  
Empaque del reborde (in/cm): 1.73 / 4.4

Lead Wire / Fil de Sortie /  
Alambre Líder (in/cm): 19.84 / 50.40



**234-1052**

Flange Gasket / Bride Joint /  
Empaque del reborde (in/cm): 1.73 / 4.4

Lead Wire / Fil de Sortie /  
Alambre Líder (in/cm): 31.02 / 78.80



**234-1056**

Flange Gasket / Bride Joint /  
Empaque del reborde (in/cm): 1.73 / 4.4

Lead Wire / Fil de Sortie /  
Alambre Líder (in/cm): 19.69 / 50.00





**234-1057 Univers.**

Flange Gasket / Bride Joint /  
Empaque del reborde (in/cm): 1.73 / 4.4

Lead Wire / Fil de Sortie /  
Alambre Lider (in/cm): 11.77 / 29.90



**234-2001**

Lead Wire / Fil de Sortie /  
Alambre Lider (in/cm): 14.80 / 37.60



**234-1058**

Flange Gasket / Bride Joint /  
Empaque del reborde (in/cm): 1.5 / 3.8

Lead Wire / Fil de Sortie /  
Alambre Lider (in/cm): 19.69 / 50.00



**234-2002**

Lead Wire / Fil de Sortie /  
Alambre Lider (in/cm): 25.79 / 65.50



**234-2000 Univers.**

Lead Wire / Fil de Sortie /  
Alambre Lider (in/cm): 11.77 / 29.90



**234-2003**

Lead Wire / Fil de Sortie /  
Alambre Lider (in/cm): 18.82 / 47.80





**234-2004**

Lead Wire / Fil de Sortie /  
Alambre Líder (in/cm): 43.82 / 111.30



**234-2007**

Lead Wire / Fil de Sortie /  
Alambre Líder (in/cm): 19.61 / 49.80



**234-2005**

Lead Wire / Fil de Sortie /  
Alambre Líder (in/cm): 12.2 / 31.00



**234-2008**

Lead Wire / Fil de Sortie /  
Alambre Líder (in/cm): 22.83 / 58.00



**234-2006**

Lead Wire / Fil de Sortie /  
Alambre Líder (in/cm): 43.82 / 111.30



**234-2009**

Lead Wire / Fil de Sortie /  
Alambre Líder (in/cm): 17.83 / 45.29





**234-2010**

Lead Wire / Fil de Sortie /  
Alambre Líder (in/cm): 11.81 / 30.00



**234-2014**

Lead Wire / Fil de Sortie /  
Alambre Líder (in/cm): 19.09 / 48.49



**234-2011**

Lead Wire / Fil de Sortie /  
Alambre Líder (in/cm): 17.8 / 45.20



**234-2015**

Lead Wire / Fil de Sortie /  
Alambre Líder (in/cm): 10.83 / 27.51



**234-2013**

Lead Wire / Fil de Sortie /  
Alambre Líder (in/cm): 24.80 / 62.99



**234-2038**

Lead Wire / Fil de Sortie /  
Alambre Líder (in/cm): 17.83 / 45.29







**234-2050 Univers.**

Flange Gasket / Bride Joint /  
Empaque del reborde (in/cm): 1.73 / 4.4

Lead Wire / Fil de Sortie /  
Alambre Líder (in/cm): 18.10 / 45.97



**234-2055**

Flange Gasket / Bride Joint /  
Empaque del reborde (in/cm): 1.73 / 4.4

Lead Wire / Fil de Sortie /  
Alambre Líder (in/cm): 10.08 / 25.60



**234-2051**

Flange Gasket / Bride Joint /  
Empaque del reborde (in/cm): 2.13 / 5.4

Lead Wire / Fil de Sortie /  
Alambre Líder (in/cm): 11.00 / 27.94



**234-2057**

Flange Gasket / Bride Joint /  
Empaque del reborde (in/cm): 1.73 / 4.4

Lead Wire / Fil de Sortie /  
Alambre Líder (in/cm): 10.50 / 26.67



**234-2052**

Flange Gasket / Bride Joint /  
Empaque del reborde (in/cm): 1.73 / 4.4

Lead Wire / Fil de Sortie /  
Alambre Líder (in/cm): 35.20 / 89.41



**234-2058**

Flange Gasket / Bride Joint /  
Empaque del reborde (in/cm): 1.73 / 4.4

Lead Wire / Fil de Sortie /  
Alambre Líder (in/cm): 11.81 / 30.00





**234-2060**

Lead Wire / Fil de Sortie /  
Alambre Líder (in/cm): 15.35 / 39.00



**234-2065**

Lead Wire / Fil de Sortie /  
Alambre Líder (in/cm): 47.80 / 121.40



**234-2062**

Flange Gasket / Bride Joint /  
Empaque del reborde (in/cm): 1.73 / 4.4

Lead Wire / Fil de Sortie /  
Alambre Líder (in/cm): 19.80 / 50.30



**234-2066**

Lead Wire / Fil de Sortie /  
Alambre Líder (in/cm): 24.80 / 63.00



**234-2064**

Lead Wire / Fil de Sortie /  
Alambre Líder (in/cm): 7.83 / 19.90



**234-2067**

Lead Wire / Fil de Sortie /  
Alambre Líder (in/cm): 17.80 / 45.20





**234-2068**

Lead Wire / Fil de Sortie /  
Alambre Líder (in/cm): 17.80 / 45.20



**234-3000 Univers.**

Lead Wire / Fil de Sortie /  
Alambre Líder (in/cm): 11.77 / 29.90



**234-2069**

Lead Wire / Fil de Sortie /  
Alambre Líder (in/cm): 12.20 / 31.00



**234-3001**

Lead Wire / Fil de Sortie /  
Alambre Líder (in/cm): 10.83 / 27.50



**234-2071 Univers.**

Flange Gasket / Bride Joint /  
Empaque del reborde (in/cm): 2.13 / 5.4

Lead Wire / Fil de Sortie /  
Alambre Líder (in/cm): 11.77 / 29.90



**234-3002**

Lead Wire / Fil de Sortie /  
Alambre Líder (in/cm): 10.94 / 27.80





**234-3003**

Lead Wire / Fil de Sortie /  
Alambre Líder (in/cm): 12.83 / 32.60



**234-3006**

Lead Wire / Fil de Sortie /  
Alambre Líder (in/cm): 12.60 / 32.00



**234-3004**

Lead Wire / Fil de Sortie /  
Alambre Líder (in/cm): 15.43 / 39.20



**234-3007**

Lead Wire / Fil de Sortie /  
Alambre Líder (in/cm): 18.82 / 47.80



**234-3005**

Lead Wire / Fil de Sortie /  
Alambre Líder (in/cm): 13.39 / 34.00



**234-3008**

Lead Wire / Fil de Sortie /  
Alambre Líder (in/cm): 22.64 / 57.50





**234-3009**

Lead Wire / Fil de Sortie /  
Alambre Líder (in/cm): 19.29 / 49.00



**234-3012**

Lead Wire / Fil de Sortie /  
Alambre Líder (in/cm): 13.78 / 35.00



**234-3010**

Lead Wire / Fil de Sortie /  
Alambre Líder (in/cm): 8.86 / 22.50



**234-3013**

Lead Wire / Fil de Sortie /  
Alambre Líder (in/cm): 23.82 / 60.50



**234-3011**

Lead Wire / Fil de Sortie /  
Alambre Líder (in/cm): 13.98 / 35.50



**234-3014**

Lead Wire / Fil de Sortie /  
Alambre Líder (in/cm): 12.80 / 32.50





**234-3015**

Lead Wire / Fil de Sortie /  
Alambre Líder (in/cm): 34.06 / 86.50



**234-3019**

Lead Wire / Fil de Sortie /  
Alambre Líder (in/cm): 38.82 / 98.60



**234-3016**

Lead Wire / Fil de Sortie /  
Alambre Líder (in/cm): 19.80 / 50.30



**234-3023**

Lead Wire / Fil de Sortie /  
Alambre Líder (in/cm): 22.83 / 58.00



**234-3018**

Lead Wire / Fil de Sortie /  
Alambre Líder (in/cm): 38.82 / 98.60



**234-3027**

Lead Wire / Fil de Sortie /  
Alambre Líder (in/cm): 34.84 / 88.50





**234-3028**

Lead Wire / Fil de Sortie /  
Alambre Líder (in/cm): 26.81 / 68.10



**234-3031**

Lead Wire / Fil de Sortie /  
Alambre Líder (in/cm): 26.81 / 68.10



**234-3029**

Lead Wire / Fil de Sortie /  
Alambre Líder (in/cm): 36.81 / 93.50



**234-3032**

Lead Wire / Fil de Sortie /  
Alambre Líder (in/cm): 20.51 / 52.10



**234-3030**

Lead Wire / Fil de Sortie /  
Alambre Líder (in/cm): 24.8 / 63.00



**234-3033**

Lead Wire / Fil de Sortie /  
Alambre Líder (in/cm): 66.61 / 169.20





**234-3034**

Lead Wire / Fil de Sortie /  
Alambre Líder (in/cm): 68.82 / 174.80



**234-3050 Univers.**

Flange Gasket / Bride Joint /  
Empaque del reborde (in/cm): 1.73 / 4.4

Lead Wire / Fil de Sortie /  
Alambre Líder (in/cm): 11.77 / 29.90



**234-3042**

Lead Wire / Fil de Sortie /  
Alambre Líder (in/cm): 13.82 / 35.10



**234-3051**

Flange Gasket / Bride Joint /  
Empaque del reborde (in/cm): 1.73 / 4.4

Lead Wire / Fil de Sortie /  
Alambre Líder (in/cm): 19.69 / 50.00



**234-3048**

Lead Wire / Fil de Sortie /  
Alambre Líder (in/cm): 49.49 / 125.70



**234-3052**

Flange Gasket / Bride Joint /  
Empaque del reborde (in/cm): 1.73 / 4.4

Lead Wire / Fil de Sortie /  
Alambre Líder (in/cm): 19.84 / 50.40







**234-3060**

Lead Wire / Fil de Sortie /  
Alambre Líder (in/cm): 28.82 / 73.20



**234-3074**

Lead Wire / Fil de Sortie /  
Alambre Líder (in/cm): 12.80 / 32.50



**234-3070**

Lead Wire / Fil de Sortie /  
Alambre Líder (in/cm): 73.82 / 187.50



**234-3075**

Lead Wire / Fil de Sortie /  
Alambre Líder (in/cm): 10.24 / 26.00



**234-3073**

Lead Wire / Fil de Sortie /  
Alambre Líder (in/cm): 46.26 / 117.50



**234-3078**

Lead Wire / Fil de Sortie /  
Alambre Líder (in/cm): 18.82 / 47.80





**234-3079**

Lead Wire / Fil de Sortie /  
Alambre Líder (in/cm): 42.80 / 108.70



**234-3082**

Lead Wire / Fil de Sortie /  
Alambre Líder (in/cm): 12.99 / 33.00



**234-3080**

Lead Wire / Fil de Sortie /  
Alambre Líder (in/cm): 35.79 / 90.90



**234-3083**

Lead Wire / Fil de Sortie /  
Alambre Líder (in/cm): 17.83 / 45.30



**234-3081**

Lead Wire / Fil de Sortie /  
Alambre Líder (in/cm): 38.19 / 97.00



**234-3084**

Lead Wire / Fil de Sortie /  
Alambre Líder (in/cm): 13.82 / 35.10





**234-3085**

Lead Wire / Fil de Sortie /  
Alambre Líder (in/cm): 15.35 / 39.00



**234-3088**

Lead Wire / Fil de Sortie /  
Alambre Líder (in/cm): 17.83 / 45.30



**234-3086**

Lead Wire / Fil de Sortie /  
Alambre Líder (in/cm): 16.85 / 42.80



**234-3089**

Lead Wire / Fil de Sortie /  
Alambre Líder (in/cm): 15.35 / 39.00



**234-3087**

Lead Wire / Fil de Sortie /  
Alambre Líder (in/cm): 22.83 / 58.00



**234-3090 Univers.**

Lead Wire / Fil de Sortie /  
Alambre Líder (in/cm): 11.77 / 29.90





**234-3091**

Lead Wire / Fil de Sortie /  
Alambre Líder (in/cm): 17.32 / 44.00



**234-3094**

Lead Wire / Fil de Sortie /  
Alambre Líder (in/cm): 12.99 / 33.00



**234-3092**

Lead Wire / Fil de Sortie /  
Alambre Líder (in/cm): 57.80 / 146.80



**234-3095**

Lead Wire / Fil de Sortie /  
Alambre Líder (in/cm): 15.75 / 40.00

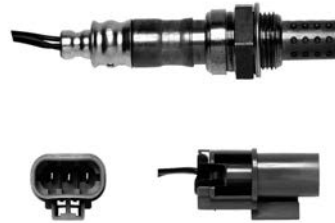

**234-3093**

Lead Wire / Fil de Sortie /  
Alambre Líder (in/cm): 72.83 / 185.00



**234-3096**

Lead Wire / Fil de Sortie /  
Alambre Líder (in/cm): 10.83 / 27.50





**234-3097**

Lead Wire / Fil de Sortie /  
Alambre Líder (in/cm): 36.61 / 93.00



**234-3100**

Lead Wire / Fil de Sortie /  
Alambre Líder (in/cm): 14.57 / 37.00



**234-3098**

Lead Wire / Fil de Sortie /  
Alambre Líder (in/cm): 35.04 / 89.00



**234-3101**

Lead Wire / Fil de Sortie /  
Alambre Líder (in/cm): 27.95 / 71.00



**234-3099**

Lead Wire / Fil de Sortie /  
Alambre Líder (in/cm): 22.64 / 57.50



**234-3102**

Lead Wire / Fil de Sortie /  
Alambre Líder (in/cm): 16.73 / 42.50





**234-3103**

Lead Wire / Fil de Sortie /  
Alambre Líder (in/cm): 14.57 / 37.00



**234-3106**

Lead Wire / Fil de Sortie /  
Alambre Líder (in/cm): 36.02 / 91.50



**234-3104**

Lead Wire / Fil de Sortie /  
Alambre Líder (in/cm): 29.72 / 75.50



**234-3107**

Lead Wire / Fil de Sortie /  
Alambre Líder (in/cm): 17.13 / 43.50



**234-3105**

Lead Wire / Fil de Sortie /  
Alambre Líder (in/cm): 17.72 / 45.00



**234-3108**

Lead Wire / Fil de Sortie /  
Alambre Líder (in/cm): 12.60 / 32.00





**234-3109**

Lead Wire / Fil de Sortie /  
Alambre Líder (in/cm): 14.96 / 38.00



**234-3112**

Lead Wire / Fil de Sortie /  
Alambre Líder (in/cm): 8.66 / 22.00



**234-3110**

Lead Wire / Fil de Sortie /  
Alambre Líder (in/cm): 26.77 / 68.00



**234-3113**

Lead Wire / Fil de Sortie /  
Alambre Líder (in/cm): 15.35 / 39.00



**234-3111**

Lead Wire / Fil de Sortie /  
Alambre Líder (in/cm): 25.20 / 64.00



**234-3116**

Lead Wire / Fil de Sortie /  
Alambre Líder (in/cm): 10.83 / 27.50





**234-3120**

Lead Wire / Fil de Sortie /  
Alambre Líder (in/cm): 9.45 / 24.00

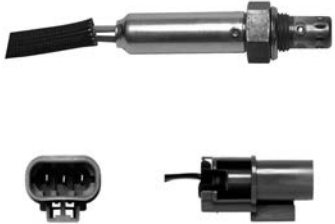

**234-3123**

Lead Wire / Fil de Sortie /  
Alambre Líder (in/cm): 18.90 / 48.00



**234-3121**

Lead Wire / Fil de Sortie /  
Alambre Líder (in/cm): 70.87 / 180.00

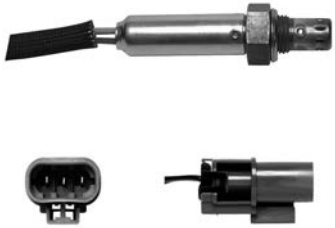

**234-3126**

Lead Wire / Fil de Sortie /  
Alambre Líder (in/cm): 28.94 / 73.50

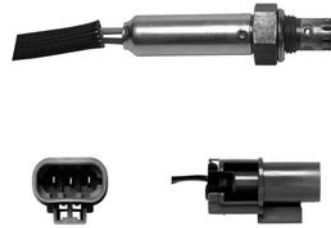

**234-3122**

Lead Wire / Fil de Sortie /  
Alambre Líder (in/cm): 16.93 / 43.00



**234-3128**

Lead Wire / Fil de Sortie /  
Alambre Líder (in/cm): 19.09 / 48.50







**234-3129**

Lead Wire / Fil de Sortie /  
Alambre Líder (in/cm): 11.61 / 29.50

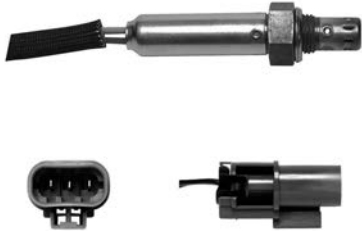

**234-3132**

Lead Wire / Fil de Sortie /  
Alambre Líder (in/cm): 75.79 / 192.50

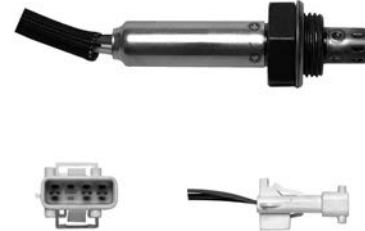

**234-3130**

Lead Wire / Fil de Sortie /  
Alambre Líder (in/cm): 20.35 / 51.70



**234-3135**

Lead Wire / Fil de Sortie /  
Alambre Líder (in/cm): 65.94 / 167.50



**234-3131**

Lead Wire / Fil de Sortie /  
Alambre Líder (in/cm): 67.72 / 172.00



**234-3150**

Lead Wire / Fil de Sortie /  
Alambre Líder (in/cm): 32.48 / 82.50





**234-3201**

Lead Wire / Fil de Sortie /  
Alambre Lider (in/cm): 17.91 / 45.50



**234-3302**

Lead Wire / Fil de Sortie /  
Alambre Lider (in/cm): 16.14 / 41.00

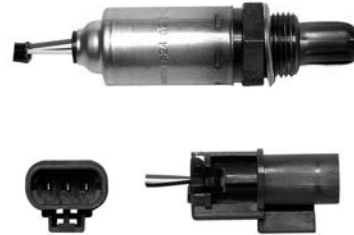

**234-3202**

Lead Wire / Fil de Sortie /  
Alambre Lider (in/cm): 6.97 / 17.70



**234-3304**

Lead Wire / Fil de Sortie /  
Alambre Lider (in/cm): 25.43 / 64.60



**234-3301**

Lead Wire / Fil de Sortie /  
Alambre Lider (in/cm): 20.87 / 53.00



**234-3305**

Lead Wire / Fil de Sortie /  
Alambre Lider (in/cm): 18.70 / 47.50





**234-3306**

Lead Wire / Fil de Sortie /  
Alambre Líder (in/cm): 37.01 / 94.00



**234-3309**

Lead Wire / Fil de Sortie /  
Alambre Líder (in/cm): 27.95 / 71.00



**234-3307**

Lead Wire / Fil de Sortie /  
Alambre Líder (in/cm): 71.14 / 180.70



**234-3310**

Lead Wire / Fil de Sortie /  
Alambre Líder (in/cm): 20.91 / 53.10



**234-3308**

Lead Wire / Fil de Sortie /  
Alambre Líder (in/cm): 45.47 / 115.50



**234-4000 Univers.**

Lead Wire / Fil de Sortie /  
Alambre Líder (in/cm): 11.77 / 29.90





**234-4001**

Lead Wire / Fil de Sortie /  
Alambre Lider (in/cm): 14.84 / 37.70



**234-4004**

Lead Wire / Fil de Sortie /  
Alambre Lider (in/cm): 11.81 / 30.00



**234-4002**

Lead Wire / Fil de Sortie /  
Alambre Lider (in/cm): 16.81 / 42.70



**234-4005**

Lead Wire / Fil de Sortie /  
Alambre Lider (in/cm): 17.32 / 44.00



**234-4003**

Lead Wire / Fil de Sortie /  
Alambre Lider (in/cm): 23.82 / 60.50



**234-4006**

Lead Wire / Fil de Sortie /  
Alambre Lider (in/cm): 12.80 / 32.50





**234-4007**

Lead Wire / Fil de Sortie /  
Alambre Líder (in/cm): 29.80 / 75.70



**234-4011**

Lead Wire / Fil de Sortie /  
Alambre Líder (in/cm): 11.81 / 30.00



**234-4008**

Lead Wire / Fil de Sortie /  
Alambre Líder (in/cm): 11.02 / 28.00



**234-4012**

Lead Wire / Fil de Sortie /  
Alambre Líder (in/cm): 15.35 / 39.00



**234-4010**

Lead Wire / Fil de Sortie /  
Alambre Líder (in/cm): 20.47 / 52.00



**234-4013**

Lead Wire / Fil de Sortie /  
Alambre Líder (in/cm): 35.83 / 91.00





**234-4014**

Lead Wire / Fil de Sortie /  
Alambre Líder (in/cm): 58.82 / 149.40



**234-4017**

Lead Wire / Fil de Sortie /  
Alambre Líder (in/cm): 21.81 / 55.40



**234-4015**

Lead Wire / Fil de Sortie /  
Alambre Líder (in/cm): 27.17 / 69.00



**234-4018**

Lead Wire / Fil de Sortie /  
Alambre Líder (in/cm): 15.35 / 39.00



**234-4016**

Lead Wire / Fil de Sortie /  
Alambre Líder (in/cm): 25.20 / 64.00



**234-4019**

Lead Wire / Fil de Sortie /  
Alambre Líder (in/cm): 15.35 / 39.00





**234-4020**

Lead Wire / Fil de Sortie /  
Alambre Líder (in/cm): 12.80 / 32.50



**234-4023**

Lead Wire / Fil de Sortie /  
Alambre Líder (in/cm): 61.81 / 157.00



**234-4021**

Lead Wire / Fil de Sortie /  
Alambre Líder (in/cm): 12.01 / 30.50



**234-4024**

Lead Wire / Fil de Sortie /  
Alambre Líder (in/cm): 22.05 / 56.00



**234-4022**

Lead Wire / Fil de Sortie /  
Alambre Líder (in/cm): 11.81 / 30.00



**234-4025**

Lead Wire / Fil de Sortie /  
Alambre Líder (in/cm): 16.54 / 42.00





**234-4026**

Lead Wire / Fil de Sortie /  
Alambre Líder (in/cm): 39.37 / 100.00



**234-4029**

Lead Wire / Fil de Sortie /  
Alambre Líder (in/cm): 18.70 / 47.50



**234-4027**

Lead Wire / Fil de Sortie /  
Alambre Líder (in/cm): 21.81 / 55.40



**234-4030**

Lead Wire / Fil de Sortie /  
Alambre Líder (in/cm): 14.57 / 37.00



**234-4028**

Lead Wire / Fil de Sortie /  
Alambre Líder (in/cm): 12.20 / 31.00



**234-4031**

Lead Wire / Fil de Sortie /  
Alambre Líder (in/cm): 12.80 / 32.50







**234-4032**

Lead Wire / Fil de Sortie /  
Alambre Líder (in/cm): 20.87 / 53.00



**234-4035**

Lead Wire / Fil de Sortie /  
Alambre Líder (in/cm): 32.28 / 82.00



**234-4033**

Lead Wire / Fil de Sortie /  
Alambre Líder (in/cm): 24.61 / 62.50



**234-4036**

Lead Wire / Fil de Sortie /  
Alambre Líder (in/cm): 37.80 / 96.00



**234-4034**

Lead Wire / Fil de Sortie /  
Alambre Líder (in/cm): 11.81 / 30.00



**234-4037**

Lead Wire / Fil de Sortie /  
Alambre Líder (in/cm): 39.76 / 101.00





**234-4038**

Lead Wire / Fil de Sortie /  
Alambre Líder (in/cm): 29.72 / 75.50



**234-4041**

Lead Wire / Fil de Sortie /  
Alambre Líder (in/cm): 20.08 / 51.00



**234-4039**

Lead Wire / Fil de Sortie /  
Alambre Líder (in/cm): 25.59 / 65.00



**234-4042**

Lead Wire / Fil de Sortie /  
Alambre Líder (in/cm): 15.94 / 40.50



**234-4040**

Lead Wire / Fil de Sortie /  
Alambre Líder (in/cm): 18.70 / 47.50



**234-4043**

Lead Wire / Fil de Sortie /  
Alambre Líder (in/cm): 16.93 / 43.00





**234-4044**

Lead Wire / Fil de Sortie /  
Alambre Líder (in/cm): 25.98 / 66.00



**234-4048**

Lead Wire / Fil de Sortie /  
Alambre Líder (in/cm): 31.10 / 79.00



**234-4045**

Lead Wire / Fil de Sortie /  
Alambre Líder (in/cm): 18.90 / 48.00



**234-4049**

Lead Wire / Fil de Sortie /  
Alambre Líder (in/cm): 14.96 / 38.00



**234-4046**

Lead Wire / Fil de Sortie /  
Alambre Líder (in/cm): 10.63 / 27.00



**234-4050 Univers.**

Flange Gasket / Bride Joint /  
Empaque del reborde (in/cm): 1.73 / 4.4

Lead Wire / Fil de Sortie /  
Alambre Líder (in/cm): 11.77 / 29.90





**234-4051**

Flange Gasket / Bride Joint /  
Empaque del reborde (in/cm): 1.73 / 4.4

Lead Wire / Fil de Sortie /  
Alambre Líder (in/cm): 14.80 / 37.60



**234-4054**

Flange Gasket / Bride Joint /  
Empaque del reborde (in/cm): 1.73 / 4.4

Lead Wire / Fil de Sortie /  
Alambre Líder (in/cm): 19.69 / 50.00



**234-4052**

Flange Gasket / Bride Joint /  
Empaque del reborde (in/cm): 1.73 / 4.4

Lead Wire / Fil de Sortie /  
Alambre Líder (in/cm): 20.79 / 52.80



**234-4055**

Flange Gasket / Bride Joint /  
Empaque del reborde (in/cm): 1.73 / 4.4

Lead Wire / Fil de Sortie /  
Alambre Líder (in/cm): 20.87 / 53.00

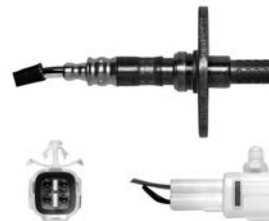

**234-4053**

Flange Gasket / Bride Joint /  
Empaque del reborde (in/cm): 1.73 / 4.4

Lead Wire / Fil de Sortie /  
Alambre Líder (in/cm): 22.80 / 57.90



**234-4056**

Flange Gasket / Bride Joint /  
Empaque del reborde (in/cm): 1.73 / 4.4

Lead Wire / Fil de Sortie /  
Alambre Líder (in/cm): 19.80 / 50.30





**234-4057**

Lead Wire / Fil de Sortie /  
Alambre Líder (in/cm): 12.40 / 31.50



**234-4060**

Lead Wire / Fil de Sortie /  
Alambre Líder (in/cm): 21.26 / 54.00



**234-4058**

Lead Wire / Fil de Sortie /  
Alambre Líder (in/cm): 25.00 / 63.50



**234-4061**

Lead Wire / Fil de Sortie /  
Alambre Líder (in/cm): 14.17 / 36.00



**234-4059**

Flange Gasket / Bride Joint /  
Empaque del reborde (in/cm): 2.13 / 5.4

Lead Wire / Fil de Sortie /  
Alambre Líder (in/cm): 9.45 / 24.00



**234-4062**

Lead Wire / Fil de Sortie /  
Alambre Líder (in/cm): 13.39 / 34.00





**234-4063**

Lead Wire / Fil de Sortie /  
Alambre Líder (in/cm): 12.40 / 31.50



**234-4066**

Lead Wire / Fil de Sortie /  
Alambre Líder (in/cm): 27.95 / 71.00



**234-4064**

Lead Wire / Fil de Sortie /  
Alambre Líder (in/cm): 12.80 / 32.50



**234-4067**

Lead Wire / Fil de Sortie /  
Alambre Líder (in/cm): 19.29 / 49.00



**234-4065**

Lead Wire / Fil de Sortie /  
Alambre Líder (in/cm): 20.47 / 52.00



**234-4068**

Lead Wire / Fil de Sortie /  
Alambre Líder (in/cm): 12.20 / 31.00





**234-4069**

Lead Wire / Fil de Sortie /  
Alambre Líder (in/cm): 17.32 / 44.00



**234-4072**

Flange Gasket / Bride Joint /  
Empaque del reborde (in/cm): 1.73 / 4.4

Lead Wire / Fil de Sortie /  
Alambre Líder (in/cm): 15.75 / 40.00



**234-4070**

Lead Wire / Fil de Sortie /  
Alambre Líder (in/cm): 23.82 / 60.50



**234-4073**

Lead Wire / Fil de Sortie /  
Alambre Líder (in/cm): 29.53 / 75.00



**234-4071**

Lead Wire / Fil de Sortie /  
Alambre Líder (in/cm): 10.83 / 27.50



**234-4074**

Lead Wire / Fil de Sortie /  
Alambre Líder (in/cm): 16.14 / 41.00





**234-4075**

Lead Wire / Fil de Sortie /  
Alambre Lider (in/cm): 50.79 / 129.00



**234-4078**

Lead Wire / Fil de Sortie /  
Alambre Lider (in/cm): 14.37 / 36.50



**234-4076**

Lead Wire / Fil de Sortie /  
Alambre Lider (in/cm): 23.23 / 59.00



**234-4079**

Lead Wire / Fil de Sortie /  
Alambre Lider (in/cm): 18.31 / 46.50



**234-4077**

Lead Wire / Fil de Sortie /  
Alambre Lider (in/cm): 12.99 / 33.00



**234-4080**

Lead Wire / Fil de Sortie /  
Alambre Lider (in/cm): 23.82 / 60.50







**234-4081**

Lead Wire / Fil de Sortie /  
Alambre Líder (in/cm): 24.80 / 63.00



**234-4084**

Lead Wire / Fil de Sortie /  
Alambre Líder (in/cm): 9.84 / 25.00



**234-4082**

Lead Wire / Fil de Sortie /  
Alambre Líder (in/cm): 35.83 / 91.00



**234-4086**

Lead Wire / Fil de Sortie /  
Alambre Líder (in/cm): 7.80 / 19.80



**234-4083**

Lead Wire / Fil de Sortie /  
Alambre Líder (in/cm): 25.20 / 64.00



**234-4087**

Lead Wire / Fil de Sortie /  
Alambre Líder (in/cm): 12.2 / 31.00





**234-4088**

Lead Wire / Fil de Sortie /  
Alambre Líder (in/cm): 25.51 / 64.80



**234-4092**

Lead Wire / Fil de Sortie /  
Alambre Líder (in/cm): 24.02 / 61.00



**234-4089**

Lead Wire / Fil de Sortie /  
Alambre Líder (in/cm): 49.21 / 125.00



**234-4093**

Lead Wire / Fil de Sortie /  
Alambre Líder (in/cm): 22.83 / 58.00



**234-4090**

Lead Wire / Fil de Sortie /  
Alambre Líder (in/cm): 27.56 / 70.00



**234-4094**

Lead Wire / Fil de Sortie /  
Alambre Líder (in/cm): 13.78 / 35.00





**234-4095**

Lead Wire / Fil de Sortie /  
Alambre Líder (in/cm): 9.25 / 23.50



**234-4099**

Lead Wire / Fil de Sortie /  
Alambre Líder (in/cm): 16.93 / 43.00



**234-4097**

Lead Wire / Fil de Sortie /  
Alambre Líder (in/cm): 30.31 / 77.00



**234-4100**

Lead Wire / Fil de Sortie /  
Alambre Líder (in/cm): 34.65 / 88.00



**234-4098**

Lead Wire / Fil de Sortie /  
Alambre Líder (in/cm): 15.75 / 40.00



**234-4102**

Lead Wire / Fil de Sortie /  
Alambre Líder (in/cm): 21.65 / 55.00





**234-4103**

Lead Wire / Fil de Sortie /  
Alambre Líder (in/cm): 14.76 / 37.50



**234-4106**

Lead Wire / Fil de Sortie /  
Alambre Líder (in/cm): 10.63 / 27.00



**234-4104**

Lead Wire / Fil de Sortie /  
Alambre Líder (in/cm): 42.52 / 108.00



**234-4107**

Lead Wire / Fil de Sortie /  
Alambre Líder (in/cm): 18.03 / 45.80



**234-4105**

Lead Wire / Fil de Sortie /  
Alambre Líder (in/cm): 13.39 / 34.00



**234-4108**

Lead Wire / Fil de Sortie /  
Alambre Líder (in/cm): 48.82 / 124.00





**234-4112**

Lead Wire / Fil de Sortie /  
Alambre Líder (in/cm): 16.93 / 43.00



**234-4116**

Lead Wire / Fil de Sortie /  
Alambre Líder (in/cm): 36.10 / 91.70



**234-4114**

Lead Wire / Fil de Sortie /  
Alambre Líder (in/cm): 35.51 / 90.20



**234-4117**

Lead Wire / Fil de Sortie /  
Alambre Líder (in/cm): 12.01 / 30.50



**234-4115**

Lead Wire / Fil de Sortie /  
Alambre Líder (in/cm): 11.81 / 30.00



**234-4118**

Lead Wire / Fil de Sortie /  
Alambre Líder (in/cm): 25.24 / 64.10





**234-4119**

Lead Wire / Fil de Sortie /  
Alambre Líder (in/cm): 18.74 / 47.60



**234-4122**

Lead Wire / Fil de Sortie /  
Alambre Líder (in/cm): 21.26 / 54.00



**234-4120**

Lead Wire / Fil de Sortie /  
Alambre Líder (in/cm): 19.69 / 50.00



**234-4123**

Lead Wire / Fil de Sortie /  
Alambre Líder (in/cm): 12.99 / 33.00



**234-4121**

Lead Wire / Fil de Sortie /  
Alambre Líder (in/cm): 19.69 / 50.00



**234-4124**

Lead Wire / Fil de Sortie /  
Alambre Líder (in/cm): 20.47 / 52.00





**234-4125**

Lead Wire / Fil de Sortie /  
Alambre Líder (in/cm): 10.83 / 27.50



**234-4128**

Lead Wire / Fil de Sortie /  
Alambre Líder (in/cm): 11.42 / 29.00



**234-4126**

Lead Wire / Fil de Sortie /  
Alambre Líder (in/cm): 12.60 / 32.00



**234-4129**

Lead Wire / Fil de Sortie /  
Alambre Líder (in/cm): 9.84 / 25.00



**234-4127**

Lead Wire / Fil de Sortie /  
Alambre Líder (in/cm): 18.82 / 47.80



**234-4130**

Lead Wire / Fil de Sortie /  
Alambre Líder (in/cm): 21.65 / 55.00





**234-4131**

Lead Wire / Fil de Sortie /  
Alambre Líder (in/cm): 17.91 / 45.50



**234-4134**

Lead Wire / Fil de Sortie /  
Alambre Líder (in/cm): 18.31 / 46.50



**234-4132**

Lead Wire / Fil de Sortie /  
Alambre Líder (in/cm): 18.11 / 46.00



**234-4135**

Lead Wire / Fil de Sortie /  
Alambre Líder (in/cm): 20.87 / 53.00



**234-4133**

Lead Wire / Fil de Sortie /  
Alambre Líder (in/cm): 45.08 / 114.50



**234-4136**

Lead Wire / Fil de Sortie /  
Alambre Líder (in/cm): 16.97 / 43.10







**234-4137**

Lead Wire / Fil de Sortie /  
Alambre Líder (in/cm): 28.74 / 73.00



**234-4140**

Lead Wire / Fil de Sortie /  
Alambre Líder (in/cm): 13.98 / 35.50



**234-4138**

Lead Wire / Fil de Sortie /  
Alambre Líder (in/cm): 8.27 / 21.00



**234-4141**

Lead Wire / Fil de Sortie /  
Alambre Líder (in/cm): 24.41 / 62.00



**234-4139**

Lead Wire / Fil de Sortie /  
Alambre Líder (in/cm): 25.59 / 65.00



**234-4142**

Lead Wire / Fil de Sortie /  
Alambre Líder (in/cm): 17.91 / 45.50





**234-4143**

Lead Wire / Fil de Sortie /  
Alambre Líder (in/cm): 9.84 / 25.00



**234-4146**

Lead Wire / Fil de Sortie /  
Alambre Líder (in/cm): 14.96 / 38.00



**234-4144**

Lead Wire / Fil de Sortie /  
Alambre Líder (in/cm): 29.13 / 74.00



**234-4147**

Lead Wire / Fil de Sortie /  
Alambre Líder (in/cm): 39.76 / 101.00



**234-4145**

Lead Wire / Fil de Sortie /  
Alambre Líder (in/cm): 19.69 / 50.00



**234-4148**

Lead Wire / Fil de Sortie /  
Alambre Líder (in/cm): 23.43 / 59.50





**234-4149**

Lead Wire / Fil de Sortie /  
Alambre Líder (in/cm): 10.24 / 26.00



**234-4152**

Flange Gasket / Bride Joint /  
Empaque del reborde (in/cm): 1.73 / 4.4

Lead Wire / Fil de Sortie /  
Alambre Líder (in/cm): 32.83 / 83.40

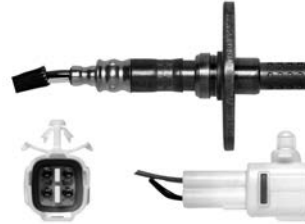

**234-4150**

Flange Gasket / Bride Joint /  
Empaque del reborde (in/cm): 1.73 / 4.4

Lead Wire / Fil de Sortie /  
Alambre Líder (in/cm): 10.00 / 25.40



**234-4153**

Flange Gasket / Bride Joint /  
Empaque del reborde (in/cm): 1.73 / 4.4

Lead Wire / Fil de Sortie /  
Alambre Líder (in/cm): 18.50 / 47.00



**234-4151**

Flange Gasket / Bride Joint /  
Empaque del reborde (in/cm): 1.73 / 4.4

Lead Wire / Fil de Sortie /  
Alambre Líder (in/cm): 12.6 / 32.00



**234-4154**

Flange Gasket / Bride Joint /  
Empaque del reborde (in/cm): 1.73 / 4.4

Lead Wire / Fil de Sortie /  
Alambre Líder (in/cm): 12.91 / 32.80





**234-4155**

Flange Gasket / Bride Joint /  
Empaque del reborde (in/cm): 1.73 / 4.4

Lead Wire / Fil de Sortie /  
Alambre Líder (in/cm): 24.41 / 62.00



**234-4158**

Flange Gasket / Bride Joint /  
Empaque del reborde (in/cm): 1.73 / 4.4

Lead Wire / Fil de Sortie /  
Alambre Líder (in/cm): 12.99 / 33.00



**234-4156**

Flange Gasket / Bride Joint /  
Empaque del reborde (in/cm): 1.73 / 4.4

Lead Wire / Fil de Sortie /  
Alambre Líder (in/cm): 12.20 / 31.00



**234-4159**

Flange Gasket / Bride Joint /  
Empaque del reborde (in/cm): 1.73 / 4.4

Lead Wire / Fil de Sortie /  
Alambre Líder (in/cm): 33.07 / 84.00



**234-4157**

Flange Gasket / Bride Joint /  
Empaque del reborde (in/cm): 1.73 / 4.4

Lead Wire / Fil de Sortie /  
Alambre Líder (in/cm): 10.24 / 26.00



**234-4160**

Flange Gasket / Bride Joint /  
Empaque del reborde (in/cm): 1.73 / 4.4

Lead Wire / Fil de Sortie /  
Alambre Líder (in/cm): 9.45 / 24.00

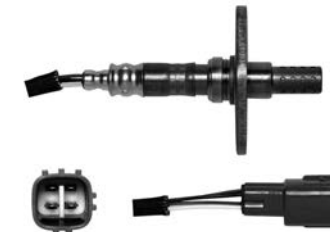



**234-4161**

Flange Gasket / Bride Joint /  
Empaque del reborde (in/cm): 1.73 / 4.4

Lead Wire / Fil de Sortie /  
Alambre Líder (in/cm): 15.35 / 39.00



**234-4164**

Lead Wire / Fil de Sortie /  
Alambre Líder (in/cm): 16.14 / 41.00



**234-4162**

Flange Gasket / Bride Joint /  
Empaque del reborde (in/cm): 1.73 / 4.4

Lead Wire / Fil de Sortie /  
Alambre Líder (in/cm): 10.63 / 27.00



**234-4165**

Lead Wire / Fil de Sortie /  
Alambre Líder (in/cm): 8.86 / 22.50



**234-4163**

Flange Gasket / Bride Joint /  
Empaque del reborde (in/cm): 1.73 / 4.4

Lead Wire / Fil de Sortie /  
Alambre Líder (in/cm): 11.81 / 30.00



**234-4166**

Lead Wire / Fil de Sortie /  
Alambre Líder (in/cm): 28.35 / 72.00





**234-4167**

Lead Wire / Fil de Sortie /  
Alambre Líder (in/cm): 29.92 / 76.00



**234-4171**

Lead Wire / Fil de Sortie /  
Alambre Líder (in/cm): 7.28 / 18.50



**234-4168**

Lead Wire / Fil de Sortie /  
Alambre Líder (in/cm): 13.78 / 35.00



**234-4172**

Lead Wire / Fil de Sortie /  
Alambre Líder (in/cm): 10.43 / 26.50



**234-4169**

Lead Wire / Fil de Sortie /  
Alambre Líder (in/cm): 11.42 / 29.00



**234-4173**

Lead Wire / Fil de Sortie /  
Alambre Líder (in/cm): 25.79 / 65.50





**234-4174**

Lead Wire / Fil de Sortie /  
Alambre Líder (in/cm): 14.76 / 37.50



**234-4177**

Lead Wire / Fil de Sortie /  
Alambre Líder (in/cm): 14.37 / 36.50



**234-4175**

Lead Wire / Fil de Sortie /  
Alambre Líder (in/cm): 24.41 / 62.00



**234-4178**

Lead Wire / Fil de Sortie /  
Alambre Líder (in/cm): 23.43 / 59.50



**234-4176**

Lead Wire / Fil de Sortie /  
Alambre Líder (in/cm): 21.06 / 53.50



**234-4179**

Lead Wire / Fil de Sortie /  
Alambre Líder (in/cm): 12.60 / 32.00





**234-4180**

Lead Wire / Fil de Sortie /  
Alambre Líder (in/cm): 32.09 / 81.50



**234-4183**

Lead Wire / Fil de Sortie /  
Alambre Líder (in/cm): 73.23 / 186.00



**234-4181**

Lead Wire / Fil de Sortie /  
Alambre Líder (in/cm): 80.71 / 205.00



**234-4184**

Lead Wire / Fil de Sortie /  
Alambre Líder (in/cm): 29.72 / 75.50



**234-4182**

Lead Wire / Fil de Sortie /  
Alambre Líder (in/cm): 21.85 / 55.50



**234-4185**

Lead Wire / Fil de Sortie /  
Alambre Líder (in/cm): 43.31 / 110.00







**234-4186**

Lead Wire / Fil de Sortie /  
Alambre Líder (in/cm): 9.84 / 25.00



**234-4189**

Flange Gasket / Bride Joint /  
Empaque del reborde (in/cm): 1.73 / 4.4

Lead Wire / Fil de Sortie /  
Alambre Líder (in/cm): 37.80 / 96.00



**234-4187**

Lead Wire / Fil de Sortie /  
Alambre Líder (in/cm): 15.43 / 39.20



**234-4190**

Lead Wire / Fil de Sortie /  
Alambre Líder (in/cm): 11.61 / 29.50



**234-4188**

Lead Wire / Fil de Sortie /  
Alambre Líder (in/cm): 25.08 / 63.70



**234-4191**

Lead Wire / Fil de Sortie /  
Alambre Líder (in/cm): 15.35 / 39.00





**234-4192**

Lead Wire / Fil de Sortie /  
Alambre Líder (in/cm): 24.80 / 63.00



**234-4195**

Lead Wire / Fil de Sortie /  
Alambre Líder (in/cm): 14.88 / 37.80



**234-4193**

Lead Wire / Fil de Sortie /  
Alambre Líder (in/cm): 18.11 / 46.00



**234-4197**

Lead Wire / Fil de Sortie /  
Alambre Líder (in/cm): 44.49 / 113.00



**234-4194**

Lead Wire / Fil de Sortie /  
Alambre Líder (in/cm): 16.93 / 43.00



**234-4198**

Lead Wire / Fil de Sortie /  
Alambre Líder (in/cm): 33.46 / 85.00





**234-4199**

Lead Wire / Fil de Sortie /  
Alambre Líder (in/cm): 20.87 / 53.00



**234-4202**

Flange Gasket / Bride Joint /  
Empaque del reborde (in/cm): 2.13 / 5.4

Lead Wire / Fil de Sortie /  
Alambre Líder (in/cm): 11.81 / 30.00



**234-4200 Univers.**

Lead Wire / Fil de Sortie /  
Alambre Líder (in/cm): 11.77 / 29.90



**234-4204**

Flange Gasket / Bride Joint /  
Empaque del reborde (in/cm): 2.13 / 5.4

Lead Wire / Fil de Sortie /  
Alambre Líder (in/cm): 32.68 / 83.00



**234-4201 Univers.**

Lead Wire / Fil de Sortie /  
Alambre Líder (in/cm): 11.77 / 29.90



**234-4205**

Flange Gasket / Bride Joint /  
Empaque del reborde (in/cm): 2.13 / 5.4

Lead Wire / Fil de Sortie /  
Alambre Líder (in/cm): 16.54 / 42.00





**234-4206 Univers.**

Flange Gasket / Bride Joint /  
Empaque del reborde (in/cm): 1.73 / 4.4

Lead Wire / Fil de Sortie /  
Alambre Lider (in/cm): 11.77 / 29.90



**234-4209 Univers.**

Lead Wire / Fil de Sortie /  
Alambre Lider (in/cm): 11.77 / 29.90



**234-4207 Univers.**

Flange Gasket / Bride Joint /  
Empaque del reborde (in/cm): 2.13 / 5.4

Lead Wire / Fil de Sortie /  
Alambre Lider (in/cm): 11.77 / 29.90



**234-4210 Univers.**

Lead Wire / Fil de Sortie /  
Alambre Lider (in/cm): 11.77 / 29.90



**234-4208 Univers.**

Flange Gasket / Bride Joint /  
Empaque del reborde (in/cm): 2.13 / 5.4

Lead Wire / Fil de Sortie /  
Alambre Lider (in/cm): 11.77 / 29.90



**234-4211**

Lead Wire / Fil de Sortie /  
Alambre Lider (in/cm): 9.84 / 25.00





**234-4212 Univers.**

Lead Wire / Fil de Sortie /  
Alambre Líder (in/cm): 11.77 / 29.90



**234-4215**

Flange Gasket / Bride Joint /  
Empaque del reborde (in/cm): 1.73 / 4.4

Lead Wire / Fil de Sortie /  
Alambre Líder (in/cm): 19.69 / 50.00



**234-4213**

Lead Wire / Fil de Sortie /  
Alambre Líder (in/cm): 36.81 / 93.50



**234-4216**

Lead Wire / Fil de Sortie /  
Alambre Líder (in/cm): 14.96 / 38.00



**234-4214**

Flange Gasket / Bride Joint /  
Empaque del reborde (in/cm): 1.73 / 4.4

Lead Wire / Fil de Sortie /  
Alambre Líder (in/cm): 25.59 / 65.00



**234-4217**

Lead Wire / Fil de Sortie /  
Alambre Líder (in/cm): 10.04 / 25.50





**234-4218**

Lead Wire / Fil de Sortie /  
Alambre Líder (in/cm): 31.61 / 80.30



**234-4221**

Lead Wire / Fil de Sortie /  
Alambre Líder (in/cm): 32.68 / 83.00



**234-4219**

Lead Wire / Fil de Sortie /  
Alambre Líder (in/cm): 31.38 / 79.70



**234-4222**

Lead Wire / Fil de Sortie /  
Alambre Líder (in/cm): 24.8 / 63.00



**234-4220**

Lead Wire / Fil de Sortie /  
Alambre Líder (in/cm): 14.96 / 38.00



**234-4224**

Lead Wire / Fil de Sortie /  
Alambre Líder (in/cm): 8.66 / 22.00





**234-4225**

Lead Wire / Fil de Sortie /  
Alambre Líder (in/cm): 18.90 / 48.00



**234-4228**

Lead Wire / Fil de Sortie /  
Alambre Líder (in/cm): 9.65 / 24.50



**234-4226**

Lead Wire / Fil de Sortie /  
Alambre Líder (in/cm): 24.8 / 63.00



**234-4229**

Lead Wire / Fil de Sortie /  
Alambre Líder (in/cm): 9.65 / 24.50



**234-4227**

Lead Wire / Fil de Sortie /  
Alambre Líder (in/cm): 19.69 / 50.00



**234-4230**

Lead Wire / Fil de Sortie /  
Alambre Líder (in/cm): 24.80 / 63.00





**234-4231**

Lead Wire / Fil de Sortie /  
Alambre Líder (in/cm): 25.98 / 66.00



**234-4234**

Lead Wire / Fil de Sortie /  
Alambre Líder (in/cm): 20.87 / 53.00



**234-4232**

Lead Wire / Fil de Sortie /  
Alambre Líder (in/cm): 10.43 / 26.50



**234-4235**

Lead Wire / Fil de Sortie /  
Alambre Líder (in/cm): 36.61 / 93.00



**234-4233**

Lead Wire / Fil de Sortie /  
Alambre Líder (in/cm): 21.26 / 54.00



**234-4236**

Lead Wire / Fil de Sortie /  
Alambre Líder (in/cm): 12.20 / 31.00







**234-4237**

Lead Wire / Fil de Sortie /  
Alambre Líder (in/cm): 22.01 / 55.90



**234-4240**

Lead Wire / Fil de Sortie /  
Alambre Líder (in/cm): 12.60 / 32.00



**234-4238**

Lead Wire / Fil de Sortie /  
Alambre Líder (in/cm): 23.43 / 59.50



**234-4241**

Lead Wire / Fil de Sortie /  
Alambre Líder (in/cm): 31.89 / 81.00



**234-4239**

Lead Wire / Fil de Sortie /  
Alambre Líder (in/cm): 18.50 / 47.00



**234-4242**

Lead Wire / Fil de Sortie /  
Alambre Líder (in/cm): 9.92 / 25.20





**234-4243**

Lead Wire / Fil de Sortie /  
Alambre Lider (in/cm): 14.84 / 37.70



**234-4246**

Lead Wire / Fil de Sortie /  
Alambre Lider (in/cm): 14.84 / 37.70



**234-4244**

Lead Wire / Fil de Sortie /  
Alambre Lider (in/cm): 13.39 / 34.00



**234-4247**

Lead Wire / Fil de Sortie /  
Alambre Lider (in/cm): 18.54 / 47.10



**234-4245**

Lead Wire / Fil de Sortie /  
Alambre Lider (in/cm): 27.17 / 69.00



**234-4248**

Lead Wire / Fil de Sortie /  
Alambre Lider (in/cm): 18.50 / 47.00





**234-4249**

Lead Wire / Fil de Sortie /  
Alambre Líder (in/cm): 11.02 / 28.00



**234-4252**

Lead Wire / Fil de Sortie /  
Alambre Líder (in/cm): 21.73 / 55.20



**234-4250**

Lead Wire / Fil de Sortie /  
Alambre Líder (in/cm): 10.94 / 27.80



**234-4253**

Lead Wire / Fil de Sortie /  
Alambre Líder (in/cm): 12.28 / 31.20



**234-4251**

Lead Wire / Fil de Sortie /  
Alambre Líder (in/cm): 14.88 / 37.80



**234-4254**

Lead Wire / Fil de Sortie /  
Alambre Líder (in/cm): 10.83 / 27.50





**234-4255**

Lead Wire / Fil de Sortie /  
Alambre Lider (in/cm): 14.76 / 37.50



**234-4258**

Lead Wire / Fil de Sortie /  
Alambre Lider (in/cm): 14.80 / 37.60



**234-4256**

Lead Wire / Fil de Sortie /  
Alambre Lider (in/cm): 14.80 / 37.60



**234-4260**

Lead Wire / Fil de Sortie /  
Alambre Lider (in/cm): 9.45 / 24.00



**234-4257**

Lead Wire / Fil de Sortie /  
Alambre Lider (in/cm): 12.40 / 31.50



**234-4261**

Lead Wire / Fil de Sortie /  
Alambre Lider (in/cm): 10.24 / 26.00





**234-4262**

Lead Wire / Fil de Sortie /  
Alambre Líder (in/cm): 9.21 / 23.40



**234-4265**

Lead Wire / Fil de Sortie /  
Alambre Líder (in/cm): 14.76 / 37.50



**234-4263**

Lead Wire / Fil de Sortie /  
Alambre Líder (in/cm): 13.82 / 35.10



**234-4266**

Lead Wire / Fil de Sortie /  
Alambre Líder (in/cm): 16.61 / 42.20



**234-4264**

Lead Wire / Fil de Sortie /  
Alambre Líder (in/cm): 9.06 / 23.00



**234-4267**

Lead Wire / Fil de Sortie /  
Alambre Líder (in/cm): 28.35 / 72.00





**234-4268**

Lead Wire / Fil de Sortie /  
Alambre Lider (in/cm): 16.69 / 42.40



**234-4271**

Lead Wire / Fil de Sortie /  
Alambre Lider (in/cm): 9.69 / 24.60



**234-4269**

Lead Wire / Fil de Sortie /  
Alambre Lider (in/cm): 15.55 / 39.50



**234-4272**

Lead Wire / Fil de Sortie /  
Alambre Lider (in/cm): 23.74 / 60.30



**234-4270**

Lead Wire / Fil de Sortie /  
Alambre Lider (in/cm): 39.37 / 100.00



**234-4273**

Lead Wire / Fil de Sortie /  
Alambre Lider (in/cm): 14.57 / 37.00





**234-4277**

Lead Wire / Fil de Sortie /  
Alambre Líder (in/cm): 15.75 / 40.00



**234-4280**

Lead Wire / Fil de Sortie /  
Alambre Líder (in/cm): 20.87 / 53.00



**234-4278**

Lead Wire / Fil de Sortie /  
Alambre Líder (in/cm): 10.04 / 25.50



**234-4281**

Lead Wire / Fil de Sortie /  
Alambre Líder (in/cm): 19.29 / 49.00



**234-4279**

Lead Wire / Fil de Sortie /  
Alambre Líder (in/cm): 34.84 / 88.50



**234-4282**

Lead Wire / Fil de Sortie /  
Alambre Líder (in/cm): 22.83 / 58.00





**234-4283**

Lead Wire / Fil de Sortie /  
Alambre Líder (in/cm): 12.60 / 32.00



**234-4286**

Lead Wire / Fil de Sortie /  
Alambre Líder (in/cm): 21.65 / 55.00



**234-4284**

Lead Wire / Fil de Sortie /  
Alambre Líder (in/cm): 15.75 / 40.00



**234-4287**

Lead Wire / Fil de Sortie /  
Alambre Líder (in/cm): 9.65 / 24.50



**234-4285**

Lead Wire / Fil de Sortie /  
Alambre Líder (in/cm): 13.19 / 33.50



**234-4288**

Lead Wire / Fil de Sortie /  
Alambre Líder (in/cm): 12.01 / 30.50







**234-4289**

Lead Wire / Fil de Sortie /  
Alambre Líder (in/cm): 16.73 / 42.50



**234-4292**

Lead Wire / Fil de Sortie /  
Alambre Líder (in/cm): 20.87 / 53.00



**234-4290**

Lead Wire / Fil de Sortie /  
Alambre Líder (in/cm): 13.58 / 34.50



**234-4293**

Lead Wire / Fil de Sortie /  
Alambre Líder (in/cm): 15.75 / 40.00



**234-4291**

Lead Wire / Fil de Sortie /  
Alambre Líder (in/cm): 12.20 / 31.00



**234-4294**

Lead Wire / Fil de Sortie /  
Alambre Líder (in/cm): 14.76 / 37.50





**234-4295**

Lead Wire / Fil de Sortie /  
Alambre Líder (in/cm): 35.83 / 91.00



**234-4298**

Lead Wire / Fil de Sortie /  
Alambre Líder (in/cm): 15.20 / 38.60



**234-4296**

Lead Wire / Fil de Sortie /  
Alambre Líder (in/cm): 14.57 / 37.00



**234-4300**

Lead Wire / Fil de Sortie /  
Alambre Líder (in/cm): 19.21 / 48.80



**234-4297**

Lead Wire / Fil de Sortie /  
Alambre Líder (in/cm): 10.83 / 27.50



**234-4301**

Lead Wire / Fil de Sortie /  
Alambre Líder (in/cm): 10.63 / 27.00





**234-4302**

Lead Wire / Fil de Sortie /  
Alambre Líder (in/cm): 14.57 / 37.00



**234-4305**

Lead Wire / Fil de Sortie /  
Alambre Líder (in/cm): 31.10 / 79.00



**234-4303**

Lead Wire / Fil de Sortie /  
Alambre Líder (in/cm): 11.73 / 29.80



**234-4306**

Lead Wire / Fil de Sortie /  
Alambre Líder (in/cm): 37.01 / 94.00



**234-4304**

Lead Wire / Fil de Sortie /  
Alambre Líder (in/cm): 14.96 / 38.00



**234-4308**

Lead Wire / Fil de Sortie /  
Alambre Líder (in/cm): 21.06 / 53.50





**234-4309**

Lead Wire / Fil de Sortie /  
Alambre Lider (in/cm): 18.50 / 47.00



**234-4312**

Lead Wire / Fil de Sortie /  
Alambre Lider (in/cm): 15.35 / 39.00



**234-4310**

Lead Wire / Fil de Sortie /  
Alambre Lider (in/cm): 35.24 / 89.50



**234-4313**

Lead Wire / Fil de Sortie /  
Alambre Lider (in/cm): 10.63 / 27.00



**234-4311**

Lead Wire / Fil de Sortie /  
Alambre Lider (in/cm): 48.03 / 122.00



**234-4314**

Lead Wire / Fil de Sortie /  
Alambre Lider (in/cm): 34.84 / 88.50





**234-4315**

Lead Wire / Fil de Sortie /  
Alambre Líder (in/cm): 47.83 / 121.50



**234-4318**

Lead Wire / Fil de Sortie /  
Alambre Líder (in/cm): 21.26 / 54.00



**234-4316**

Lead Wire / Fil de Sortie /  
Alambre Líder (in/cm): 12.99 / 33.00



**234-4319**

Lead Wire / Fil de Sortie /  
Alambre Líder (in/cm): 22.83 / 58.00



**234-4317**

Lead Wire / Fil de Sortie /  
Alambre Líder (in/cm): 20.87 / 53.00



**234-4320**

Lead Wire / Fil de Sortie /  
Alambre Líder (in/cm): 22.83 / 58.00





**234-4321**

Lead Wire / Fil de Sortie /  
Alambre Líder (in/cm): 24.02 / 61.00



**234-4324**

Lead Wire / Fil de Sortie /  
Alambre Líder (in/cm): 21.38 / 54.30



**234-4322**

Lead Wire / Fil de Sortie /  
Alambre Líder (in/cm): 33.86 / 86.00



**234-4325**

Lead Wire / Fil de Sortie /  
Alambre Líder (in/cm): 7.68 / 19.50



**234-4323**

Lead Wire / Fil de Sortie /  
Alambre Líder (in/cm): 28.94 / 73.50



**234-4326**

Lead Wire / Fil de Sortie /  
Alambre Líder (in/cm): 14.37 / 36.50





**234-4327**

Lead Wire / Fil de Sortie /  
Alambre Líder (in/cm): 47.64 / 121.00



**234-4330**

Lead Wire / Fil de Sortie /  
Alambre Líder (in/cm): 39.76 / 101.00



**234-4328**

Lead Wire / Fil de Sortie /  
Alambre Líder (in/cm): 36.02 / 91.50



**234-4331**

Lead Wire / Fil de Sortie /  
Alambre Líder (in/cm): 18.90 / 48.00



**234-4329**

Lead Wire / Fil de Sortie /  
Alambre Líder (in/cm): 32.48 / 82.50



**234-4332**

Lead Wire / Fil de Sortie /  
Alambre Líder (in/cm): 11.42 / 29.00





**234-4333**

Lead Wire / Fil de Sortie /  
Alambre Líder (in/cm): 19.57 / 49.70



**234-4336**

Lead Wire / Fil de Sortie /  
Alambre Líder (in/cm): 14.76 / 37.50



**234-4334**

Lead Wire / Fil de Sortie /  
Alambre Líder (in/cm): 14.92 / 37.90



**234-4337**

Lead Wire / Fil de Sortie /  
Alambre Líder (in/cm): 16.14 / 41.00



**234-4335**

Lead Wire / Fil de Sortie /  
Alambre Líder (in/cm): 37.32 / 94.80



**234-4338**

Lead Wire / Fil de Sortie /  
Alambre Líder (in/cm): 31.50 / 80.00







**234-4339**

Lead Wire / Fil de Sortie /  
Alambre Líder (in/cm): 15.75 / 40.00



**234-4342**

Lead Wire / Fil de Sortie /  
Alambre Líder (in/cm): 9.84 / 25.00



**234-4340**

Lead Wire / Fil de Sortie /  
Alambre Líder (in/cm): 17.40 / 44.20



**234-4343**

Lead Wire / Fil de Sortie /  
Alambre Líder (in/cm): 12.28 / 31.20



**234-4341**

Lead Wire / Fil de Sortie /  
Alambre Líder (in/cm): 25.59 / 65.00



**234-4344**

Lead Wire / Fil de Sortie /  
Alambre Líder (in/cm): 12.13 / 30.80





**234-4345**

Lead Wire / Fil de Sortie /  
Alambre Líder (in/cm): 14.69 / 37.30



**234-4348**

Lead Wire / Fil de Sortie /  
Alambre Líder (in/cm): 12.13 / 30.80



**234-4346**

Lead Wire / Fil de Sortie /  
Alambre Líder (in/cm): 16.14 / 41.00

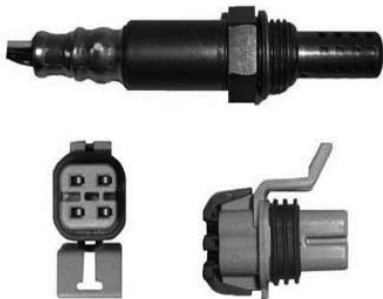

**234-4349**

Lead Wire / Fil de Sortie /  
Alambre Líder (in/cm): 10.63 / 27.00



**234-4347**

Lead Wire / Fil de Sortie /  
Alambre Líder (in/cm): 9.06 / 23.00



**234-4350**

Lead Wire / Fil de Sortie /  
Alambre Líder (in/cm): 10.75 / 27.30





**234-4351**

Lead Wire / Fil de Sortie /  
Alambre Líder (in/cm): 21.50 / 54.60



**234-4354**

Lead Wire / Fil de Sortie /  
Alambre Líder (in/cm): 20.08 / 51.00



**234-4352**

Lead Wire / Fil de Sortie /  
Alambre Líder (in/cm): 10.75 / 27.30



**234-4355**

Lead Wire / Fil de Sortie /  
Alambre Líder (in/cm): 16.73 / 42.50



**234-4353**

Lead Wire / Fil de Sortie /  
Alambre Líder (in/cm): 25.98 / 66.00



**234-4358**

Lead Wire / Fil de Sortie /  
Alambre Líder (in/cm): 33.78 / 85.80





**234-4359**

Lead Wire / Fil de Sortie /  
Alambre Líder (in/cm): 19.88 / 50.50



**234-4362**

Lead Wire / Fil de Sortie /  
Alambre Líder (in/cm): 24.02 / 61.00



**234-4360**

Lead Wire / Fil de Sortie /  
Alambre Líder (in/cm): 20.08 / 51.00



**234-4363**

Lead Wire / Fil de Sortie /  
Alambre Líder (in/cm): 38.98 / 99.00



**234-4361**

Lead Wire / Fil de Sortie /  
Alambre Líder (in/cm): 10.83 / 27.50



**234-4364**

Lead Wire / Fil de Sortie /  
Alambre Líder (in/cm): 25.59 / 65.00





**234-4368**

Lead Wire / Fil de Sortie /  
Alambre Líder (in/cm): 21.26 / 54.00



**234-4372**

Lead Wire / Fil de Sortie /  
Alambre Líder (in/cm): 10.63 / 27.00



**234-4370**

Lead Wire / Fil de Sortie /  
Alambre Líder (in/cm): 12.09 / 30.70



**234-4373**

Lead Wire / Fil de Sortie /  
Alambre Líder (in/cm): 15.43 / 39.20



**234-4371**

Lead Wire / Fil de Sortie /  
Alambre Líder (in/cm): 15.83 / 40.20



**234-4374**

Lead Wire / Fil de Sortie /  
Alambre Líder (in/cm): 15.39 / 39.10





**234-4375**

Lead Wire / Fil de Sortie /  
Alambre Líder (in/cm): 17.91 / 45.50



**234-4378**

Lead Wire / Fil de Sortie /  
Alambre Líder (in/cm): 17.32 / 44.00



**234-4376**

Lead Wire / Fil de Sortie /  
Alambre Líder (in/cm): 25.98 / 66.00



**234-4379**

Lead Wire / Fil de Sortie /  
Alambre Líder (in/cm): 17.32 / 44.00



**234-4377**

Lead Wire / Fil de Sortie /  
Alambre Líder (in/cm): 24.02 / 61.00



**234-4380**

Lead Wire / Fil de Sortie /  
Alambre Líder (in/cm): 18.50 / 47.00





**234-4381**

Lead Wire / Fil de Sortie /  
Alambre Líder (in/cm): 10.71 / 27.20



**234-4385**

Lead Wire / Fil de Sortie /  
Alambre Líder (in/cm): 15.55 / 39.50



**234-4382**

Lead Wire / Fil de Sortie /  
Alambre Líder (in/cm): 18.54 / 47.10



**234-4386**

Lead Wire / Fil de Sortie /  
Alambre Líder (in/cm): 35.24 / 89.50



**234-4383**

Lead Wire / Fil de Sortie /  
Alambre Líder (in/cm): 21.65 / 55.00



**234-4387**

Lead Wire / Fil de Sortie /  
Alambre Líder (in/cm): 20.28 / 51.50





**234-4388**

Lead Wire / Fil de Sortie /  
Alambre Líder (in/cm): 17.32 / 44.00



**234-4391**

Lead Wire / Fil de Sortie /  
Alambre Líder (in/cm): 14.17 / 36.00



**234-4389**

Lead Wire / Fil de Sortie /  
Alambre Líder (in/cm): 12.17 / 30.90



**234-4392**

Lead Wire / Fil de Sortie /  
Alambre Líder (in/cm): 30.35 / 77.10



**234-4390**

Lead Wire / Fil de Sortie /  
Alambre Líder (in/cm): 31.10 / 79.00



**234-4393**

Lead Wire / Fil de Sortie /  
Alambre Líder (in/cm): 24.09 / 61.20







**234-4394**

Lead Wire / Fil de Sortie /  
Alambre Líder (in/cm): 21.65 / 55.00



**234-4397**

Lead Wire / Fil de Sortie /  
Alambre Líder (in/cm): 36.22 / 92.00



**234-4395**

Lead Wire / Fil de Sortie /  
Alambre Líder (in/cm): 25.63 / 65.10



**234-4398**

Lead Wire / Fil de Sortie /  
Alambre Líder (in/cm): 48.43 / 123.00



**234-4396**

Lead Wire / Fil de Sortie /  
Alambre Líder (in/cm): 18.11 / 46.00



**234-4399**

Lead Wire / Fil de Sortie /  
Alambre Líder (in/cm): 24.41 / 62.00





**234-4400**

Lead Wire / Fil de Sortie /  
Alambre Líder (in/cm): 22.32 / 56.70



**234-4407**

Lead Wire / Fil de Sortie /  
Alambre Líder (in/cm): 14.76 / 37.50



**234-4401**

Lead Wire / Fil de Sortie /  
Alambre Líder (in/cm): 11.02 / 28.00



**234-4408**

Lead Wire / Fil de Sortie /  
Alambre Líder (in/cm): 38.19 / 97.00



**234-4403**

Lead Wire / Fil de Sortie /  
Alambre Líder (in/cm): 15.35 / 39.00



**234-4409**

Lead Wire / Fil de Sortie /  
Alambre Líder (in/cm): 38.19 / 97.00





**234-4410**

Lead Wire / Fil de Sortie /  
Alambre Líder (in/cm): 17.99 / 45.70



**234-4413**

Lead Wire / Fil de Sortie /  
Alambre Líder (in/cm): 23.27 / 59.10



**234-4411**

Lead Wire / Fil de Sortie /  
Alambre Líder (in/cm): 17.52 / 44.50



**234-4414**

Lead Wire / Fil de Sortie /  
Alambre Líder (in/cm): 28.35 / 72.00



**234-4412**

Lead Wire / Fil de Sortie /  
Alambre Líder (in/cm): 26.69 / 67.80



**234-4416**

Lead Wire / Fil de Sortie /  
Alambre Líder (in/cm): 10.04 / 25.50





**234-4417**

Lead Wire / Fil de Sortie /  
Alambre Lider (in/cm): 10.08 / 25.60



**234-4420**

Lead Wire / Fil de Sortie /  
Alambre Lider (in/cm): 15.75 / 40.00



**234-4418**

Lead Wire / Fil de Sortie /  
Alambre Lider (in/cm): 12.28 / 31.20



**234-4421**

Lead Wire / Fil de Sortie /  
Alambre Lider (in/cm): 23.03 / 58.50



**234-4419**

Lead Wire / Fil de Sortie /  
Alambre Lider (in/cm): 44.61 / 113.30



**234-4422**

Lead Wire / Fil de Sortie /  
Alambre Lider (in/cm): 15.75 / 40.00





**234-4423**

Lead Wire / Fil de Sortie /  
Alambre Líder (in/cm): 27.56 / 70.00



**234-4426**

Lead Wire / Fil de Sortie /  
Alambre Líder (in/cm): 27.36 / 69.50



**234-4424**

Lead Wire / Fil de Sortie /  
Alambre Líder (in/cm): 20.67 / 52.50



**234-4427**

Lead Wire / Fil de Sortie /  
Alambre Líder (in/cm): 8.66 / 22.00



**234-4425**

Lead Wire / Fil de Sortie /  
Alambre Líder (in/cm): 18.70 / 47.50



**234-4428**

Lead Wire / Fil de Sortie /  
Alambre Líder (in/cm): 14.02 / 35.60





**234-4429**

Lead Wire / Fil de Sortie /  
Alambre Líder (in/cm): 12.28 / 31.20



**234-4432**

Lead Wire / Fil de Sortie /  
Alambre Líder (in/cm): 25.00 / 63.50



**234-4430**

Lead Wire / Fil de Sortie /  
Alambre Líder (in/cm): 16.54 / 42.00



**234-4433**

Lead Wire / Fil de Sortie /  
Alambre Líder (in/cm): 28.94 / 73.50

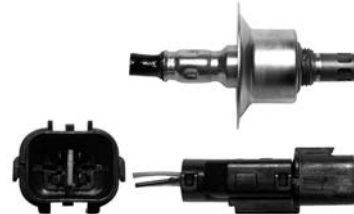

**234-4431**

Lead Wire / Fil de Sortie /  
Alambre Líder (in/cm): 16.10 / 40.90



**234-4434**

Lead Wire / Fil de Sortie /  
Alambre Líder (in/cm): 23.62 / 60.00





**234-4435**

Lead Wire / Fil de Sortie /  
Alambre Líder (in/cm): 10.91 / 27.70



**234-4438**

Lead Wire / Fil de Sortie /  
Alambre Líder (in/cm): 8.46 / 21.50



**234-4436**

Lead Wire / Fil de Sortie /  
Alambre Líder (in/cm): 14.80 / 37.60



**234-4439**

Lead Wire / Fil de Sortie /  
Alambre Líder (in/cm): 18.11 / 46.00



**234-4437**

Lead Wire / Fil de Sortie /  
Alambre Líder (in/cm): 19.76 / 50.20



**234-4440**

Lead Wire / Fil de Sortie /  
Alambre Líder (in/cm): 34.88 / 88.60





**234-4441**

Lead Wire / Fil de Sortie /  
Alambre Líder (in/cm): 15.94 / 40.50



**234-4444**

Lead Wire / Fil de Sortie /  
Alambre Líder (in/cm): 17.36 / 44.10



**234-4442**

Lead Wire / Fil de Sortie /  
Alambre Líder (in/cm): 11.81 / 30.00



**234-4445**

Lead Wire / Fil de Sortie /  
Alambre Líder (in/cm): 20.87 / 53.00



**234-4443**

Lead Wire / Fil de Sortie /  
Alambre Líder (in/cm): 22.68 / 57.60



**234-4446**

Lead Wire / Fil de Sortie /  
Alambre Líder (in/cm): 27.17 / 69.00







**234-4447**

Lead Wire / Fil de Sortie /  
Alambre Líder (in/cm): 12.72 / 32.30



**234-4450**

Lead Wire / Fil de Sortie /  
Alambre Líder (in/cm): 25.59 / 65.00



**234-4448**

Lead Wire / Fil de Sortie /  
Alambre Líder (in/cm): 20.08 / 51.00



**234-4451**

Lead Wire / Fil de Sortie /  
Alambre Líder (in/cm): 30.71 / 78.00



**234-4449**

Lead Wire / Fil de Sortie /  
Alambre Líder (in/cm): 18.90 / 48.00



**234-4452**

Lead Wire / Fil de Sortie /  
Alambre Líder (in/cm): 33.86 / 86.00





**234-4453**

Lead Wire / Fil de Sortie /  
Alambre Líder (in/cm): 15.35 / 39.00



**234-4456**

Lead Wire / Fil de Sortie /  
Alambre Líder (in/cm): 11.61 / 29.50



**234-4454**

Lead Wire / Fil de Sortie /  
Alambre Líder (in/cm): 18.11 / 46.00



**234-4457**

Lead Wire / Fil de Sortie /  
Alambre Líder (in/cm): 24.45 / 62.10



**234-4455**

Lead Wire / Fil de Sortie /  
Alambre Líder (in/cm): 24.41 / 62.00



**234-4458**

Lead Wire / Fil de Sortie /  
Alambre Líder (in/cm): 12.60 / 32.00





**234-4461**

Lead Wire / Fil de Sortie /  
Alambre Líder (in/cm): 24.96 / 63.40



**234-4464**

Lead Wire / Fil de Sortie /  
Alambre Líder (in/cm): 17.91 / 45.50



**234-4462**

Lead Wire / Fil de Sortie /  
Alambre Líder (in/cm): 8.07 / 20.50



**234-4465**

Lead Wire / Fil de Sortie /  
Alambre Líder (in/cm): 40.59 / 103.10



**234-4463**

Lead Wire / Fil de Sortie /  
Alambre Líder (in/cm): 16.30 / 41.40



**234-4466**

Lead Wire / Fil de Sortie /  
Alambre Líder (in/cm): 28.35 / 72.00





**234-4467**

Lead Wire / Fil de Sortie /  
Alambre Lider (in/cm): 12.60 / 32.00



**234-4471**

Lead Wire / Fil de Sortie /  
Alambre Lider (in/cm): 13.66 / 34.70



**234-4468**

Lead Wire / Fil de Sortie /  
Alambre Lider (in/cm): 15.16 / 38.50



**234-4472**

Lead Wire / Fil de Sortie /  
Alambre Lider (in/cm): 45.43 / 115.40



**234-4470**

Lead Wire / Fil de Sortie /  
Alambre Lider (in/cm): 16.73 / 42.50



**234-4473**

Lead Wire / Fil de Sortie /  
Alambre Lider (in/cm): 38.58 / 98.00





**234-4474**

Lead Wire / Fil de Sortie /  
Alambre Líder (in/cm): 47.24 / 120.00



**234-4477**

Lead Wire / Fil de Sortie /  
Alambre Líder (in/cm): 26.57 / 67.50



**234-4475**

Lead Wire / Fil de Sortie /  
Alambre Líder (in/cm): 36.02 / 91.50



**234-4478**

Lead Wire / Fil de Sortie /  
Alambre Líder (in/cm): 14.17 / 36.00



**234-4476**

Lead Wire / Fil de Sortie /  
Alambre Líder (in/cm): 13.86 / 35.20



**234-4479**

Lead Wire / Fil de Sortie /  
Alambre Líder (in/cm): 26.77 / 68.00





**234-4480**

Lead Wire / Fil de Sortie /  
Alambre Líder (in/cm): 36.61 / 93.00



**234-4483**

Lead Wire / Fil de Sortie /  
Alambre Líder (in/cm): 26.77 / 68.00



**234-4481**

Lead Wire / Fil de Sortie /  
Alambre Líder (in/cm): 9.49 / 24.10



**234-4484**

Lead Wire / Fil de Sortie /  
Alambre Líder (in/cm): 44.69 / 113.50



**234-4482**

Lead Wire / Fil de Sortie /  
Alambre Líder (in/cm): 15.83 / 40.20



**234-4485**

Lead Wire / Fil de Sortie /  
Alambre Líder (in/cm): 28.94 / 73.50





**234-4486**

Lead Wire / Fil de Sortie /  
Alambre Líder (in/cm): 20.87 / 53.00



**234-4489**

Lead Wire / Fil de Sortie /  
Alambre Líder (in/cm): 12.44 / 31.60



**234-4487**

Lead Wire / Fil de Sortie /  
Alambre Líder (in/cm): 14.57 / 37.00



**234-4490**

Lead Wire / Fil de Sortie /  
Alambre Líder (in/cm): 17.52 / 44.50



**234-4488**

Lead Wire / Fil de Sortie /  
Alambre Líder (in/cm): 17.52 / 44.50



**234-4491**

Lead Wire / Fil de Sortie /  
Alambre Líder (in/cm): 17.48 / 44.40





**234-4492**

Lead Wire / Fil de Sortie /  
Alambre Líder (in/cm): 10.08 / 25.60



**234-4495**

Lead Wire / Fil de Sortie /  
Alambre Líder (in/cm): 27.24 / 69.20



**234-4493**

Lead Wire / Fil de Sortie /  
Alambre Líder (in/cm): 15.24 / 38.70



**234-4496**

Lead Wire / Fil de Sortie /  
Alambre Líder (in/cm): 31.57 / 80.20



**234-4494**

Lead Wire / Fil de Sortie /  
Alambre Líder (in/cm): 15.55 / 39.50



**234-4497**

Lead Wire / Fil de Sortie /  
Alambre Líder (in/cm): 52.13 / 132.40







**234-4498**

Lead Wire / Fil de Sortie /  
Alambre Líder (in/cm): 49.69 / 126.20



**234-4502**

Lead Wire / Fil de Sortie /  
Alambre Líder (in/cm): 20.67 / 52.50



**234-4499**

Lead Wire / Fil de Sortie /  
Alambre Líder (in/cm): 33.27 / 84.50



**234-4503**

Lead Wire / Fil de Sortie /  
Alambre Líder (in/cm): 25.98 / 66.00



**234-4501**

Lead Wire / Fil de Sortie /  
Alambre Líder (in/cm): 15.35 / 39.00



**234-4504**

Lead Wire / Fil de Sortie /  
Alambre Líder (in/cm): 31.50 / 80.00





**234-4505**

Lead Wire / Fil de Sortie /  
Alambre Líder (in/cm): 15.83 / 40.20



**234-4508**

Lead Wire / Fil de Sortie /  
Alambre Líder (in/cm): 7.99 / 20.30



**234-4506**

Lead Wire / Fil de Sortie /  
Alambre Líder (in/cm): 28.35 / 72.00



**234-4509**

Lead Wire / Fil de Sortie /  
Alambre Líder (in/cm): 25.59 / 65.00



**234-4507**

Lead Wire / Fil de Sortie /  
Alambre Líder (in/cm): 19.69 / 50.00



**234-4511**

Lead Wire / Fil de Sortie /  
Alambre Líder (in/cm): 19.49 / 49.50





**234-4512**

Lead Wire / Fil de Sortie /  
Alambre Líder (in/cm): 19.69 / 50.00



**234-4515**

Lead Wire / Fil de Sortie /  
Alambre Líder (in/cm): 26.38 / 67.00



**234-4513**

Lead Wire / Fil de Sortie /  
Alambre Líder (in/cm): 7.48 / 19.00



**234-4516**

Lead Wire / Fil de Sortie /  
Alambre Líder (in/cm): 15.75 / 40.00



**234-4514**

Lead Wire / Fil de Sortie /  
Alambre Líder (in/cm): 32.87 / 83.50



**234-4517**

Lead Wire / Fil de Sortie /  
Alambre Líder (in/cm): 35.83 / 91.00





**234-4518**

Lead Wire / Fil de Sortie /  
Alambre Líder (in/cm): 43.31 / 110.00



**234-4521**

Lead Wire / Fil de Sortie /  
Alambre Líder (in/cm): 21.65 / 55.00



**234-4519**

Lead Wire / Fil de Sortie /  
Alambre Líder (in/cm): 43.50 / 110.50



**234-4522**

Lead Wire / Fil de Sortie /  
Alambre Líder (in/cm): 28.74 / 73.00



**234-4520**

Lead Wire / Fil de Sortie /  
Alambre Líder (in/cm): 12.60 / 32.00



**234-4523**

Lead Wire / Fil de Sortie /  
Alambre Líder (in/cm): 19.49 / 49.50





**234-4524**

Lead Wire / Fil de Sortie /  
Alambre Líder (in/cm): 13.78 / 35.00



**234-4528**

Lead Wire / Fil de Sortie /  
Alambre Líder (in/cm): 10.71 / 27.20



**234-4526**

Lead Wire / Fil de Sortie /  
Alambre Líder (in/cm): 16.38 / 41.60



**234-4529**

Lead Wire / Fil de Sortie /  
Alambre Líder (in/cm): 22.05 / 56.00



**234-4527**

Lead Wire / Fil de Sortie /  
Alambre Líder (in/cm): 21.26 / 54.00



**234-4530**

Lead Wire / Fil de Sortie /  
Alambre Líder (in/cm): 12.40 / 31.50





**234-4533**

Lead Wire / Fil de Sortie /  
Alambre Líder (in/cm): 34.65 / 88.00



**234-4536**

Lead Wire / Fil de Sortie /  
Alambre Líder (in/cm): 15.35 / 39.00



**234-4534**

Lead Wire / Fil de Sortie /  
Alambre Líder (in/cm): 14.76 / 37.50



**234-4537**

Lead Wire / Fil de Sortie /  
Alambre Líder (in/cm): 19.09 / 48.50



**234-4535**

Lead Wire / Fil de Sortie /  
Alambre Líder (in/cm): 14.76 / 37.50



**234-4538**

Lead Wire / Fil de Sortie /  
Alambre Líder (in/cm): 12.48 / 31.70





**234-4539**

Lead Wire / Fil de Sortie /  
Alambre Líder (in/cm): 20.28 / 51.50



**234-4544**

Lead Wire / Fil de Sortie /  
Alambre Líder (in/cm): 32.44 / 82.40



**234-4540**

Lead Wire / Fil de Sortie /  
Alambre Líder (in/cm): 16.93 / 43.00



**234-4545**

Lead Wire / Fil de Sortie /  
Alambre Líder (in/cm): 10.08 / 25.60



**234-4543**

Lead Wire / Fil de Sortie /  
Alambre Líder (in/cm): 14.37 / 36.50



**234-4546**

Lead Wire / Fil de Sortie /  
Alambre Líder (in/cm): 13.98 / 35.50





**234-4547**

Lead Wire / Fil de Sortie /  
Alambre Líder (in/cm): 14.17 / 36.00



**234-4550**

Lead Wire / Fil de Sortie /  
Alambre Líder (in/cm): 29.09 / 73.90



**234-4548**

Lead Wire / Fil de Sortie /  
Alambre Líder (in/cm): 27.40 / 69.60



**234-4551**

Lead Wire / Fil de Sortie /  
Alambre Líder (in/cm): 20.55 / 52.20



**234-4549**

Lead Wire / Fil de Sortie /  
Alambre Líder (in/cm): 43.70 / 111.00



**234-4552**

Lead Wire / Fil de Sortie /  
Alambre Líder (in/cm): 25.00 / 63.50







**234-4553**

Lead Wire / Fil de Sortie /  
Alambre Líder (in/cm): 14.17 / 36.00



**234-4559**

Lead Wire / Fil de Sortie /  
Alambre Líder (in/cm): 12.01 / 30.50



**234-4555**

Lead Wire / Fil de Sortie /  
Alambre Líder (in/cm): 13.19 / 33.50



**234-4560**

Lead Wire / Fil de Sortie /  
Alambre Líder (in/cm): 11.97 / 30.40



**234-4557**

Lead Wire / Fil de Sortie /  
Alambre Líder (in/cm): 13.43 / 34.10



**234-4561**

Lead Wire / Fil de Sortie /  
Alambre Líder (in/cm): 12.99 / 33.00





**234-4562**

Lead Wire / Fil de Sortie /  
Alambre Líder (in/cm): 20.71 / 52.6



**234-4565**

Lead Wire / Fil de Sortie /  
Alambre Líder (in/cm): 10.24 / 26



**234-4563**

Lead Wire / Fil de Sortie /  
Alambre Líder (in/cm): 14.76 / 37.5



**234-4566**

Lead Wire / Fil de Sortie /  
Alambre Líder (in/cm): 14.76 / 37.5



**234-4564**

Lead Wire / Fil de Sortie /  
Alambre Líder (in/cm): 12.2 / 31



**234-4567**

Lead Wire / Fil de Sortie /  
Alambre Líder (in/cm): 14.96 / 38





**234-4568**

Lead Wire / Fil de Sortie /  
Alambre Líder (in/cm): 20.16 / 51.2



**234-4571**

Lead Wire / Fil de Sortie /  
Alambre Líder (in/cm): 18.74 / 47.6



**234-4569**

Lead Wire / Fil de Sortie /  
Alambre Líder (in/cm): 18.78 / 47.7



**234-4572**

Lead Wire / Fil de Sortie /  
Alambre Líder (in/cm): 29.33 / 74.5



**234-4570**

Lead Wire / Fil de Sortie /  
Alambre Líder (in/cm): 22.83 / 58



**234-4573**

Lead Wire / Fil de Sortie /  
Alambre Líder (in/cm): 10.63 / 27





**234-4574**

Lead Wire / Fil de Sortie /  
Alambre Líder (in/cm): 13.7 / 34.8



**234-4577**

Lead Wire / Fil de Sortie /  
Alambre Líder (in/cm): 26.26 / 66.7



**234-4575**

Lead Wire / Fil de Sortie /  
Alambre Líder (in/cm): 26.97 / 68.5



**234-4578**

Lead Wire / Fil de Sortie /  
Alambre Líder (in/cm): 26.57 / 67.5



**234-4576**

Lead Wire / Fil de Sortie /  
Alambre Líder (in/cm): 15.43 / 39.2



**234-4579**

Lead Wire / Fil de Sortie /  
Alambre Líder (in/cm): 18.11 / 46





**234-4580**

Lead Wire / Fil de Sortie /  
Alambre Líder (in/cm): 24.88 / 63.2



**234-4583**

Lead Wire / Fil de Sortie /  
Alambre Líder (in/cm): 25.47 / 64.7



**234-4581**

Lead Wire / Fil de Sortie /  
Alambre Líder (in/cm): 13.07 / 33.2



**234-4584**

Lead Wire / Fil de Sortie /  
Alambre Líder (in/cm): 15.63 / 39.7



**234-4582**

Lead Wire / Fil de Sortie /  
Alambre Líder (in/cm): 18.43 / 46.8



**234-4585**

Lead Wire / Fil de Sortie /  
Alambre Líder (in/cm): 27.56 / 70





**234-4586**

Lead Wire / Fil de Sortie /  
Alambre Líder (in/cm): 14.96 / 38



**234-4589**

Lead Wire / Fil de Sortie /  
Alambre Líder (in/cm): 30.43 / 77.3



**234-4587**

Lead Wire / Fil de Sortie /  
Alambre Líder (in/cm): 15.75 / 40.00



**234-4590**

Lead Wire / Fil de Sortie /  
Alambre Líder (in/cm): 11.81 / 30.00



**234-4588**

Lead Wire / Fil de Sortie /  
Alambre Líder (in/cm): 18.70 / 47.50



**234-4591**

Lead Wire / Fil de Sortie /  
Alambre Líder (in/cm): 25.24 / 64.1





**234-4592**

Lead Wire / Fil de Sortie /  
Alambre Líder (in/cm): 15.75 / 40.00



**234-4596**

Lead Wire / Fil de Sortie /  
Alambre Líder (in/cm): 16.73 / 42.50



**234-4593**

Lead Wire / Fil de Sortie /  
Alambre Líder (in/cm): 12.80 / 32.50



**234-4597**

Lead Wire / Fil de Sortie /  
Alambre Líder (in/cm): 24.33 / 61.80



**234-4595**

Lead Wire / Fil de Sortie /  
Alambre Líder (in/cm): 10.79 / 27.4



**234-4598**

Lead Wire / Fil de Sortie /  
Alambre Líder (in/cm): 17.99 / 45.70





**234-4599**

Lead Wire / Fil de Sortie /  
Alambre Líder (in/cm): 18.62 / 47.3



**234-4602**

Lead Wire / Fil de Sortie /  
Alambre Líder (in/cm): 13.98 / 35.50



**234-4600**

Lead Wire / Fil de Sortie /  
Alambre Líder (in/cm): 23.23 / 59.00



**234-4603**

Lead Wire / Fil de Sortie /  
Alambre Líder (in/cm): 33.07 / 84.00



**234-4601**

Lead Wire / Fil de Sortie /  
Alambre Líder (in/cm): 33.86 / 86.00



**234-4604**

Lead Wire / Fil de Sortie /  
Alambre Líder (in/cm): 20.08 / 51.00







**234-4605**

Lead Wire / Fil de Sortie /  
Alambre Líder (in/cm): 22.24 / 56.50



**234-4608**

Lead Wire / Fil de Sortie /  
Alambre Líder (in/cm): 29.92 / 76.00



**234-4606**

Lead Wire / Fil de Sortie /  
Alambre Líder (in/cm): 22.05 / 56.00



**234-4609**

Lead Wire / Fil de Sortie /  
Alambre Líder (in/cm): 18.11 / 46.00



**234-4607**

Lead Wire / Fil de Sortie /  
Alambre Líder (in/cm): 15.35 / 39.00



**234-4610**

Lead Wire / Fil de Sortie /  
Alambre Líder (in/cm): 13.15 / 33.40





**234-4611**

Lead Wire / Fil de Sortie /  
Alambre Líder (in/cm): 23.62 / 60.00



**234-4614**

Lead Wire / Fil de Sortie /  
Alambre Líder (in/cm): 33.07 / 84.00



**234-4612**

Lead Wire / Fil de Sortie /  
Alambre Líder (in/cm): 32.28 / 82.00



**234-4615**

Lead Wire / Fil de Sortie /  
Alambre Líder (in/cm): 72.83 / 185.00



**234-4613**

Lead Wire / Fil de Sortie /  
Alambre Líder (in/cm): 27.56 / 70.00



**234-4616**

Lead Wire / Fil de Sortie /  
Alambre Líder (in/cm): 68.31 / 173.50





**234-4617**

Lead Wire / Fil de Sortie /  
Alambre Líder (in/cm): 44.84 / 113.90



**234-4620**

Lead Wire / Fil de Sortie /  
Alambre Líder (in/cm): 11.42 / 29.00



**234-4618**

Lead Wire / Fil de Sortie /  
Alambre Líder (in/cm): 27.80 / 70.60



**234-4621**

Lead Wire / Fil de Sortie /  
Alambre Líder (in/cm): 20.28 / 51.50



**234-4619**

Lead Wire / Fil de Sortie /  
Alambre Líder (in/cm): 31.50 / 80.00



**234-4622**

Lead Wire / Fil de Sortie /  
Alambre Líder (in/cm): 12.60 / 32.00





**234-4623**

Lead Wire / Fil de Sortie /  
Alambre Líder (in/cm): 23.23 / 59.00



**234-4627**

Lead Wire / Fil de Sortie /  
Alambre Líder (in/cm): 22.83 / 58.00



**234-4624**

Lead Wire / Fil de Sortie /  
Alambre Líder (in/cm): 16.14 / 41.00



**234-4628**

Lead Wire / Fil de Sortie /  
Alambre Líder (in/cm): 14.80 / 37.60



**234-4626**

Lead Wire / Fil de Sortie /  
Alambre Líder (in/cm): 23.23 / 59.00



**234-4629**

Lead Wire / Fil de Sortie /  
Alambre Líder (in/cm): 13.39 / 34.00





**234-4630**

Lead Wire / Fil de Sortie /  
Alambre Líder (in/cm): 17.72 / 45.00



**234-4634**

Lead Wire / Fil de Sortie /  
Alambre Líder (in/cm): 12.20 / 31.00



**234-4631**

Lead Wire / Fil de Sortie /  
Alambre Líder (in/cm): 30.31 / 77.00



**234-4635**

Lead Wire / Fil de Sortie /  
Alambre Líder (in/cm): 18.11 / 46.00



**234-4633**

Lead Wire / Fil de Sortie /  
Alambre Líder (in/cm): 23.23 / 59.00



**234-4636**

Lead Wire / Fil de Sortie /  
Alambre Líder (in/cm): 22.83 / 58.00





**234-4637**

Lead Wire / Fil de Sortie /  
Alambre Líder (in/cm): 16.14 / 41.00



**234-4640**

Lead Wire / Fil de Sortie /  
Alambre Líder (in/cm): 11.42 / 29.00



**234-4638**

Lead Wire / Fil de Sortie /  
Alambre Líder (in/cm): 10.43 / 26.50



**234-4641**

Lead Wire / Fil de Sortie /  
Alambre Líder (in/cm): 24.61 / 62.50



**234-4639**

Lead Wire / Fil de Sortie /  
Alambre Líder (in/cm): 20.08 / 51.00



**234-4642**

Lead Wire / Fil de Sortie /  
Alambre Líder (in/cm): 19.29 / 49.00





**234-4643**

Lead Wire / Fil de Sortie /  
Alambre Líder (in/cm): 27.56 / 70.00



**234-4646**

Lead Wire / Fil de Sortie /  
Alambre Líder (in/cm): 12.99 / 33.00



**234-4644**

Lead Wire / Fil de Sortie /  
Alambre Líder (in/cm): 17.52 / 44.50



**234-4647**

Lead Wire / Fil de Sortie /  
Alambre Líder (in/cm): 12.60 / 32.00



**234-4645**

Lead Wire / Fil de Sortie /  
Alambre Líder (in/cm): 15.75 / 40.00



**234-4648**

Lead Wire / Fil de Sortie /  
Alambre Líder (in/cm): 25.20 / 64.00





**234-4649**

Lead Wire / Fil de Sortie /  
Alambre Lider (in/cm): 24.41 / 62.00



**234-4652**

Lead Wire / Fil de Sortie /  
Alambre Lider (in/cm): 21.65 / 55.00



**234-4650**

Lead Wire / Fil de Sortie /  
Alambre Lider (in/cm): 15.55 / 39.50



**234-4653**

Lead Wire / Fil de Sortie /  
Alambre Lider (in/cm): 18.50 / 47.00



**234-4651**

Lead Wire / Fil de Sortie /  
Alambre Lider (in/cm): 16.54 / 42.00



**234-4654**

Lead Wire / Fil de Sortie /  
Alambre Lider (in/cm): 14.57 / 37.00







**234-4655**

Lead Wire / Fil de Sortie /  
Alambre Líder (in/cm): 34.65 / 88.00



**234-4658**

Lead Wire / Fil de Sortie /  
Alambre Líder (in/cm): 16.14 / 41.00



**234-4656**

Lead Wire / Fil de Sortie /  
Alambre Líder (in/cm): 29.53 / 75.00



**234-4659**

Lead Wire / Fil de Sortie /  
Alambre Líder (in/cm): 12.99 / 33.00



**234-4657**

Lead Wire / Fil de Sortie /  
Alambre Líder (in/cm): 17.32 / 44.00



**234-4660**

Lead Wire / Fil de Sortie /  
Alambre Líder (in/cm): 48.23 / 122.50





**234-4661**

Lead Wire / Fil de Sortie /  
Alambre Líder (in/cm): 67.72 / 172.00



**234-4664**

Lead Wire / Fil de Sortie /  
Alambre Líder (in/cm): 30.91 / 78.50



**234-4662**

Lead Wire / Fil de Sortie /  
Alambre Líder (in/cm): 33.07 / 84.00



**234-4665**

Lead Wire / Fil de Sortie /  
Alambre Líder (in/cm): 24.41 / 62.00



**234-4663**

Lead Wire / Fil de Sortie /  
Alambre Líder (in/cm): 40.94 / 104.00



**234-4666**

Lead Wire / Fil de Sortie /  
Alambre Líder (in/cm): 52.36 / 133.00





**234-4668**

Lead Wire / Fil de Sortie /  
Alambre Líder (in/cm): 15.75 / 40.00



**234-4671**

Lead Wire / Fil de Sortie /  
Alambre Líder (in/cm): 17.91 / 45.50



**234-4669**

Lead Wire / Fil de Sortie /  
Alambre Líder (in/cm): 14.76 / 37.50



**234-4672**

Lead Wire / Fil de Sortie /  
Alambre Líder (in/cm): 13.39 / 34.00



**234-4670**

Lead Wire / Fil de Sortie /  
Alambre Líder (in/cm): 15.55 / 39.50



**234-4673**

Lead Wire / Fil de Sortie /  
Alambre Líder (in/cm): 21.65 / 55.00





**234-4674**

Lead Wire / Fil de Sortie /  
Alambre Líder (in/cm): 31.10 / 79.00



**234-4677**

Lead Wire / Fil de Sortie /  
Alambre Líder (in/cm): 32.09 / 81.50



**234-4675**

Lead Wire / Fil de Sortie /  
Alambre Líder (in/cm): 9.25 / 23.50



**234-4678**

Lead Wire / Fil de Sortie /  
Alambre Líder (in/cm): 41.34 / 105.00



**234-4676**

Lead Wire / Fil de Sortie /  
Alambre Líder (in/cm): 20.08 / 51.00



**234-4679**

Lead Wire / Fil de Sortie /  
Alambre Líder (in/cm): 35.43 / 90.00





**234-4680**

Lead Wire / Fil de Sortie /  
Alambre Líder (in/cm): 11.42 / 29.00



**234-4683**

Lead Wire / Fil de Sortie /  
Alambre Líder (in/cm): 38.78 / 98.50



**234-4681**

Lead Wire / Fil de Sortie /  
Alambre Líder (in/cm): 21.46 / 54.50



**234-4684**

Lead Wire / Fil de Sortie /  
Alambre Líder (in/cm): 11.61 / 29.50



**234-4682**

Lead Wire / Fil de Sortie /  
Alambre Líder (in/cm): 29.13 / 74.00



**234-4685**

Lead Wire / Fil de Sortie /  
Alambre Líder (in/cm): 55.91 / 142.00





**234-4686**

Lead Wire / Fil de Sortie /  
Alambre Líder (in/cm): 15.75 / 40.00



**234-4689**

Lead Wire / Fil de Sortie /  
Alambre Líder (in/cm): 84.06 / 213.50



**234-4687**

Lead Wire / Fil de Sortie /  
Alambre Líder (in/cm): 21.06 / 53.50



**234-4690**

Lead Wire / Fil de Sortie /  
Alambre Líder (in/cm): 10.24 / 26.00



**234-4688**

Lead Wire / Fil de Sortie /  
Alambre Líder (in/cm): 23.23 / 59.00



**234-4691**

Lead Wire / Fil de Sortie /  
Alambre Líder (in/cm): 17.72 / 45.00





**234-4692**

Lead Wire / Fil de Sortie /  
Alambre Líder (in/cm): 12.60 / 32.00



**234-4695**

Lead Wire / Fil de Sortie /  
Alambre Líder (in/cm): 18.90 / 48.00



**234-4693**

Lead Wire / Fil de Sortie /  
Alambre Líder (in/cm): 16.14 / 41.00



**234-4696**

Lead Wire / Fil de Sortie /  
Alambre Líder (in/cm): 22.44 / 57.00



**234-4694**

Lead Wire / Fil de Sortie /  
Alambre Líder (in/cm): 12.60 / 32.00



**234-4697**

Lead Wire / Fil de Sortie /  
Alambre Líder (in/cm): 20.08 / 51.00





**234-4698**

Lead Wire / Fil de Sortie /  
Alambre Líder (in/cm): 35.04 / 89.00



**234-4701**

Lead Wire / Fil de Sortie /  
Alambre Líder (in/cm): 25.59 / 65.00



**234-4699**

Lead Wire / Fil de Sortie /  
Alambre Líder (in/cm): 65.55 / 166.50



**234-4702**

Lead Wire / Fil de Sortie /  
Alambre Líder (in/cm): 51.18 / 130.00



**234-4700 Univers.**

Lead Wire / Fil de Sortie /  
Alambre Líder (in/cm): 11.77 / 29.90



**234-4703**

Lead Wire / Fil de Sortie /  
Alambre Líder (in/cm): 50.39 / 128.00







**234-4704**

Lead Wire / Fil de Sortie /  
Alambre Líder (in/cm): 36.22 / 92.00



**234-4707**

Lead Wire / Fil de Sortie /  
Alambre Líder (in/cm): 58.86 / 149.50



**234-4705**

Lead Wire / Fil de Sortie /  
Alambre Líder (in/cm): 12.20 / 31.00



**234-4708**

Lead Wire / Fil de Sortie /  
Alambre Líder (in/cm): 24.09 / 61.20



**234-4706**

Lead Wire / Fil de Sortie /  
Alambre Líder (in/cm): 17.72 / 45.00



**234-4709**

Lead Wire / Fil de Sortie /  
Alambre Líder (in/cm): 25.98 / 66.00





**234-4710**

Lead Wire / Fil de Sortie /  
Alambre Líder (in/cm): 38.39 / 97.50



**234-4713**

Lead Wire / Fil de Sortie /  
Alambre Líder (in/cm): 47.83 / 121.50



**234-4711**

Lead Wire / Fil de Sortie /  
Alambre Líder (in/cm): 13.78 / 35.00



**234-4714**

Lead Wire / Fil de Sortie /  
Alambre Líder (in/cm): 49.61 / 126.00



**234-4712**

Lead Wire / Fil de Sortie /  
Alambre Líder (in/cm): 29.72 / 75.50



**234-4715**

Lead Wire / Fil de Sortie /  
Alambre Líder (in/cm): 28.74 / 73.00





**234-4716**

Lead Wire / Fil de Sortie /  
Alambre Líder (in/cm): 21.65 / 55.00



**234-4719**

Lead Wire / Fil de Sortie /  
Alambre Líder (in/cm): 18.19 / 46.20



**234-4717**

Lead Wire / Fil de Sortie /  
Alambre Líder (in/cm): 26.97 / 68.5



**234-4720**

Lead Wire / Fil de Sortie /  
Alambre Líder (in/cm): 15.75 / 40.00



**234-4718**

Lead Wire / Fil de Sortie /  
Alambre Líder (in/cm): 11.81 / 30.00



**234-4721**

Lead Wire / Fil de Sortie /  
Alambre Líder (in/cm): 9.45 / 24.00





**234-4722**

Lead Wire / Fil de Sortie /  
Alambre Líder (in/cm): 18.11 / 46.00



**234-4725**

Lead Wire / Fil de Sortie /  
Alambre Líder (in/cm): 14.57 / 37.00



**234-4723**

Lead Wire / Fil de Sortie /  
Alambre Líder (in/cm): 29.13 / 74.00



**234-4726**

Lead Wire / Fil de Sortie /  
Alambre Líder (in/cm): 21.26 / 54.00



**234-4724**

Lead Wire / Fil de Sortie /  
Alambre Líder (in/cm): 9.84 / 25.00



**234-4727**

Lead Wire / Fil de Sortie /  
Alambre Líder (in/cm): 17.32 / 44.00





**234-4729**

Lead Wire / Fil de Sortie /  
Alambre Líder (in/cm): 25.20 / 64.00



**234-4732**

Lead Wire / Fil de Sortie /  
Alambre Líder (in/cm): 21.26 / 54.00



**234-4730**

Lead Wire / Fil de Sortie /  
Alambre Líder (in/cm): 34.65 / 88.00



**234-4733**

Lead Wire / Fil de Sortie /  
Alambre Líder (in/cm): 13.19 / 33.50



**234-4731**

Lead Wire / Fil de Sortie /  
Alambre Líder (in/cm): 9.84 / 25.00



**234-4734**

Lead Wire / Fil de Sortie /  
Alambre Líder (in/cm): 25.59 / 65.00





**234-4736**

Lead Wire / Fil de Sortie /  
Alambre Líder (in/cm): 17.32 / 44.00



**234-4739**

Lead Wire / Fil de Sortie /  
Alambre Líder (in/cm): 14.57 / 37.00



**234-4737**

Lead Wire / Fil de Sortie /  
Alambre Líder (in/cm): 25.59 / 65



**234-4740**

Lead Wire / Fil de Sortie /  
Alambre Líder (in/cm): 17.52 / 44.5



**234-4738**

Lead Wire / Fil de Sortie /  
Alambre Líder (in/cm): 22.83 / 58.00



**234-4741**

Lead Wire / Fil de Sortie /  
Alambre Líder (in/cm): 27.56 / 70.00





**234-4742**

Lead Wire / Fil de Sortie /  
Alambre Líder (in/cm): 29.92 / 76.00



**234-4745**

Lead Wire / Fil de Sortie /  
Alambre Líder (in/cm): 18.11 / 46.00



**234-4743**

Lead Wire / Fil de Sortie /  
Alambre Líder (in/cm): 11.89 / 30.2



**234-4746**

Lead Wire / Fil de Sortie /  
Alambre Líder (in/cm): 11.81 / 30.00



**234-4744**

Lead Wire / Fil de Sortie /  
Alambre Líder (in/cm): 11.81 / 30.00



**234-4747**

Lead Wire / Fil de Sortie /  
Alambre Líder (in/cm): 13.98 / 35.50





**234-4748**

Lead Wire / Fil de Sortie /  
Alambre Líder (in/cm): 12.24 / 31.10



**234-4751**

Lead Wire / Fil de Sortie /  
Alambre Líder (in/cm): 34.65 / 88.00



**234-4749**

Lead Wire / Fil de Sortie /  
Alambre Líder (in/cm): 18.19 / 46.20



**234-4752**

Lead Wire / Fil de Sortie /  
Alambre Líder (in/cm): 25.59 / 65.00



**234-4750**

Lead Wire / Fil de Sortie /  
Alambre Líder (in/cm): 12.99 / 33.00



**234-4753**

Lead Wire / Fil de Sortie /  
Alambre Líder (in/cm): 29.13 / 74







**234-4754**

Lead Wire / Fil de Sortie /  
Alambre Líder (in/cm): 28.74 / 73



**234-4757**

Lead Wire / Fil de Sortie /  
Alambre Líder (in/cm): 12.64 / 32.1



**234-4755**

Lead Wire / Fil de Sortie /  
Alambre Líder (in/cm): 32.28 / 82.00



**234-4758**

Lead Wire / Fil de Sortie /  
Alambre Líder (in/cm): 8.86 / 22.5



**234-4756**

Lead Wire / Fil de Sortie /  
Alambre Líder (in/cm): 18.11 / 46.00



**234-4759**

Lead Wire / Fil de Sortie /  
Alambre Líder (in/cm): 16.73 / 42.5





**234-4760**

Lead Wire / Fil de Sortie /  
Alambre Líder (in/cm): 17.72 / 45



**234-4763**

Lead Wire / Fil de Sortie /  
Alambre Líder (in/cm): 15.04 / 38.20



**234-4761**

Lead Wire / Fil de Sortie /  
Alambre Líder (in/cm): 18.19 / 46.20



**234-4764**

Lead Wire / Fil de Sortie /  
Alambre Líder (in/cm): 11.81 / 30.00



**234-4762**

Lead Wire / Fil de Sortie /  
Alambre Líder (in/cm): 14.76 / 37.50



**234-4765**

Lead Wire / Fil de Sortie /  
Alambre Líder (in/cm): 11.38 / 28.90





**234-4766**

Lead Wire / Fil de Sortie /  
Alambre Líder (in/cm): 18.19 / 46.20



**234-4769**

Lead Wire / Fil de Sortie /  
Alambre Líder (in/cm): 18.19 / 46.20



**234-4767**

Lead Wire / Fil de Sortie /  
Alambre Líder (in/cm): 18.19 / 46.20



**234-4770**

Lead Wire / Fil de Sortie /  
Alambre Líder (in/cm): 11.81 / 30.00



**234-4768**

Lead Wire / Fil de Sortie /  
Alambre Líder (in/cm): 18.19 / 46.20



**234-4771**

Lead Wire / Fil de Sortie /  
Alambre Líder (in/cm): 11.81 / 30.00





**234-4772**

Lead Wire / Fil de Sortie /  
Alambre Líder (in/cm): 11.81 / 30.00



**234-4775**

Lead Wire / Fil de Sortie /  
Alambre Líder (in/cm): 10.63 / 27.00



**234-4773**

Lead Wire / Fil de Sortie /  
Alambre Líder (in/cm): 10.55 / 26.80



**234-4776**

Lead Wire / Fil de Sortie /  
Alambre Líder (in/cm): 39.37 / 100.00



**234-4774**

Lead Wire / Fil de Sortie /  
Alambre Líder (in/cm): 15.47 / 39.30



**234-4777**

Lead Wire / Fil de Sortie /  
Alambre Líder (in/cm): 30.71 / 78.00





**234-4778**

Lead Wire / Fil de Sortie /  
Alambre Líder (in/cm): 11.42 / 29.00



**234-4781**

Lead Wire / Fil de Sortie /  
Alambre Líder (in/cm): 9.45 / 24.00



**234-4779**

Lead Wire / Fil de Sortie /  
Alambre Líder (in/cm): 32.68 / 83.00



**234-4782**

Lead Wire / Fil de Sortie /  
Alambre Líder (in/cm): 9.37 / 23.80



**234-4780**

Lead Wire / Fil de Sortie /  
Alambre Líder (in/cm): 17.13 / 43.50



**234-4783**

Lead Wire / Fil de Sortie /  
Alambre Líder (in/cm): 20.87 / 53.00





**234-4784**

Lead Wire / Fil de Sortie /  
Alambre Líder (in/cm): 25.20 / 64.00



**234-4787**

Lead Wire / Fil de Sortie /  
Alambre Líder (in/cm): 26.77 / 68.00



**234-4785**

Lead Wire / Fil de Sortie /  
Alambre Líder (in/cm): 15.75 / 40.00



**234-4788**

Lead Wire / Fil de Sortie /  
Alambre Líder (in/cm): 20.47 / 52.00



**234-4786**

Lead Wire / Fil de Sortie /  
Alambre Líder (in/cm): 11.50 / 29.20



**234-4789**

Lead Wire / Fil de Sortie /  
Alambre Líder (in/cm): 38.98 / 99.00





**234-4790**

Lead Wire / Fil de Sortie /  
Alambre Líder (in/cm): 21.34 / 54.20



**234-4793**

Lead Wire / Fil de Sortie /  
Alambre Líder (in/cm): 41.02 / 104.20



**234-4791**

Lead Wire / Fil de Sortie /  
Alambre Líder (in/cm): 25.67 / 65.20



**234-4794**

Lead Wire / Fil de Sortie /  
Alambre Líder (in/cm): 12.01 / 30.50



**234-4792**

Lead Wire / Fil de Sortie /  
Alambre Líder (in/cm): 15.59 / 39.60



**234-4795**

Lead Wire / Fil de Sortie /  
Alambre Líder (in/cm): 20.79 / 52.80





**234-4796**

Lead Wire / Fil de Sortie /  
Alambre Lider (in/cm): 18.03 / 45.80



**234-4799**

Lead Wire / Fil de Sortie /  
Alambre Lider (in/cm): 35.43 / 90.00



**234-4797**

Lead Wire / Fil de Sortie /  
Alambre Lider (in/cm): 42.13 / 107.00



**234-4800**

Lead Wire / Fil de Sortie /  
Alambre Lider (in/cm): 14.76 / 37.50



**234-4798**

Lead Wire / Fil de Sortie /  
Alambre Lider (in/cm): 21.26 / 54.00



**234-4801**

Lead Wire / Fil de Sortie /  
Alambre Lider (in/cm): 18.50 / 47.00







**234-4802**

Lead Wire / Fil de Sortie /  
Alambre Líder (in/cm): 21.46 / 54.50



**234-4805**

Lead Wire / Fil de Sortie /  
Alambre Líder (in/cm): 7.87 / 20.00



**234-4803**

Lead Wire / Fil de Sortie /  
Alambre Líder (in/cm): 19.29 / 49.00



**234-4806**

Lead Wire / Fil de Sortie /  
Alambre Líder (in/cm): 21.26 / 54.00



**234-4804**

Lead Wire / Fil de Sortie /  
Alambre Líder (in/cm): 13.39 / 34.00



**234-4808**

Lead Wire / Fil de Sortie /  
Alambre Líder (in/cm): 24.61 / 62.50





**234-4809**

Lead Wire / Fil de Sortie /  
Alambre Líder (in/cm): 36.42 / 92.50



**234-4812**

Lead Wire / Fil de Sortie /  
Alambre Líder (in/cm): 66.54 / 169.00



**234-4810**

Lead Wire / Fil de Sortie /  
Alambre Líder (in/cm): 43.31 / 110.00



**234-4814**

Lead Wire / Fil de Sortie /  
Alambre Líder (in/cm): 18.90 / 48.00



**234-4811**

Lead Wire / Fil de Sortie /  
Alambre Líder (in/cm): 63.78 / 162.00



**234-4815**

Lead Wire / Fil de Sortie /  
Alambre Líder (in/cm): 12.40 / 31.50





**234-4816**

Lead Wire / Fil de Sortie /  
Alambre Líder (in/cm): 20.59 / 52.30



**234-4819**

Lead Wire / Fil de Sortie /  
Alambre Líder (in/cm): 14.17 / 36.00



**234-4817**

Lead Wire / Fil de Sortie /  
Alambre Líder (in/cm): 32.87 / 83.50



**234-4820**

Lead Wire / Fil de Sortie /  
Alambre Líder (in/cm): 16.14 / 41.00



**234-4818**

Lead Wire / Fil de Sortie /  
Alambre Líder (in/cm): 9.84 / 25.00



**234-4821**

Lead Wire / Fil de Sortie /  
Alambre Líder (in/cm): 15.79 / 40.10





**234-4822**

Lead Wire / Fil de Sortie /  
Alambre Líder (in/cm): 39.76 / 101.00



**234-4829**

Lead Wire / Fil de Sortie /  
Alambre Líder (in/cm): 31.38 / 79.70



**234-4827**

Lead Wire / Fil de Sortie /  
Alambre Líder (in/cm): 17.99 / 45.70



**234-4830**

Lead Wire / Fil de Sortie /  
Alambre Líder (in/cm): 14.76 / 37.50



**234-4828**

Lead Wire / Fil de Sortie /  
Alambre Líder (in/cm): 21.26 / 54.00



**234-4831**

Lead Wire / Fil de Sortie /  
Alambre Líder (in/cm): 21.85 / 55.50





**234-4832**

Lead Wire / Fil de Sortie /  
Alambre Líder (in/cm): 26.42 / 67.10



**234-4835**

Lead Wire / Fil de Sortie /  
Alambre Líder (in/cm): 11.81 / 30.00



**234-4833**

Lead Wire / Fil de Sortie /  
Alambre Líder (in/cm): 31.5 / 80.00



**234-4836**

Lead Wire / Fil de Sortie /  
Alambre Líder (in/cm): 38.27 / 97.20



**234-4834**

Lead Wire / Fil de Sortie /  
Alambre Líder (in/cm): 12.80 / 32.50



**234-4837**

Lead Wire / Fil de Sortie /  
Alambre Líder (in/cm): 48.23 / 122.50





**234-4839**

Lead Wire / Fil de Sortie /  
Alambre Líder (in/cm): 12.44 / 31.60



**234-4844**

Lead Wire / Fil de Sortie /  
Alambre Líder (in/cm): 64.37 / 163.50



**234-4840**

Lead Wire / Fil de Sortie /  
Alambre Líder (in/cm): 12.80 / 32.50



**234-4846**

Lead Wire / Fil de Sortie /  
Alambre Líder (in/cm): 67.13 / 170.50



**234-4843**

Lead Wire / Fil de Sortie /  
Alambre Líder (in/cm): 51.50 / 130.80



**234-4849**

Lead Wire / Fil de Sortie /  
Alambre Líder (in/cm): 28.54 / 72.50





**234-4850**

Lead Wire / Fil de Sortie /  
Alambre Líder (in/cm): 20.08 / 51.00



**234-4854**

Lead Wire / Fil de Sortie /  
Alambre Líder (in/cm): 12.68 / 32.20



**234-4851**

Lead Wire / Fil de Sortie /  
Alambre Líder (in/cm): 15.16 / 38.50



**234-4855**

Lead Wire / Fil de Sortie /  
Alambre Líder (in/cm): 32.28 / 82.00



**234-4852**

Lead Wire / Fil de Sortie /  
Alambre Líder (in/cm): 8.39 / 21.30



**234-4856**

Lead Wire / Fil de Sortie /  
Alambre Líder (in/cm): 24.02 / 61.00





**234-4857**

Lead Wire / Fil de Sortie /  
Alambre Líder (in/cm): 17.72 / 45.00



**234-4860**

Lead Wire / Fil de Sortie /  
Alambre Líder (in/cm): 36.02 / 91.50



**234-4858**

Lead Wire / Fil de Sortie /  
Alambre Líder (in/cm): 22.83 / 58.00



**234-4861**

Lead Wire / Fil de Sortie /  
Alambre Líder (in/cm): 29.53 / 75.00



**234-4859**

Lead Wire / Fil de Sortie /  
Alambre Líder (in/cm): 25.79 / 65.50



**234-4862**

Lead Wire / Fil de Sortie /  
Alambre Líder (in/cm): 38.98 / 99.00







**234-4863**

Lead Wire / Fil de Sortie /  
Alambre Líder (in/cm): 31.89 / 81.00



**234-4866**

Lead Wire / Fil de Sortie /  
Alambre Líder (in/cm): 66.14 / 168.00



**234-4864**

Lead Wire / Fil de Sortie /  
Alambre Líder (in/cm): 41.34 / 105.00



**234-4867**

Lead Wire / Fil de Sortie /  
Alambre Líder (in/cm): 39.57 / 100.50



**234-4865**

Lead Wire / Fil de Sortie /  
Alambre Líder (in/cm): 28.74 / 73.00



**234-4871**

Lead Wire / Fil de Sortie /  
Alambre Líder (in/cm): 32.72 / 83.10





**234-4872**

Lead Wire / Fil de Sortie /  
Alambre Lider (in/cm): 23.7 / 60.20



**234-4876**

Lead Wire / Fil de Sortie /  
Alambre Lider (in/cm): 22.64 / 57.50



**234-4874**

Lead Wire / Fil de Sortie /  
Alambre Lider (in/cm): 49.37 / 125.40



**234-4877**

Lead Wire / Fil de Sortie /  
Alambre Lider (in/cm): 17.72 / 45.00



**234-4875**

Lead Wire / Fil de Sortie /  
Alambre Lider (in/cm): 12.20 / 31.00



**234-4878**

Lead Wire / Fil de Sortie /  
Alambre Lider (in/cm): 26.22 / 66.60





**234-4879**

Lead Wire / Fil de Sortie /  
Alambre Líder (in/cm): 26.69 / 67.80



**234-4882**

Lead Wire / Fil de Sortie /  
Alambre Líder (in/cm): 16.14 / 41.00



**234-4880**

Lead Wire / Fil de Sortie /  
Alambre Líder (in/cm): 18.50 / 47.00



**234-4883**

Lead Wire / Fil de Sortie /  
Alambre Líder (in/cm): 18.50 / 47.00



**234-4881**

Lead Wire / Fil de Sortie /  
Alambre Líder (in/cm): 13.19 / 33.50



**234-4884**

Lead Wire / Fil de Sortie /  
Alambre Líder (in/cm): 10.24 / 26.00





**234-4886**

Lead Wire / Fil de Sortie /  
Alambre Líder (in/cm): 16.61 / 42.20



**234-4889**

Lead Wire / Fil de Sortie /  
Alambre Líder (in/cm): 11.42 / 29.00



**234-4887**

Lead Wire / Fil de Sortie /  
Alambre Líder (in/cm): 28.54 / 72.50



**234-4890**

Lead Wire / Fil de Sortie /  
Alambre Líder (in/cm): 24.02 / 61.00



**234-4888**

Lead Wire / Fil de Sortie /  
Alambre Líder (in/cm): 22.83 / 58.00



**234-4891**

Lead Wire / Fil de Sortie /  
Alambre Líder (in/cm): 30.71 / 78.00





**234-4892**

Lead Wire / Fil de Sortie /  
Alambre Líder (in/cm): 19.69 / 50.00



**234-4895**

Lead Wire / Fil de Sortie /  
Alambre Líder (in/cm): 19.50 / 50.00



**234-4893**

Lead Wire / Fil de Sortie /  
Alambre Líder (in/cm): 27.95 / 71.00



**234-4896**

Lead Wire / Fil de Sortie /  
Alambre Líder (in/cm): 18.70 / 47.50



**234-4894**

Lead Wire / Fil de Sortie /  
Alambre Líder (in/cm): 15.55 / 39.50



**234-4897**

Lead Wire / Fil de Sortie /  
Alambre Líder (in/cm): 36.42 / 92.50





**234-4898**

Lead Wire / Fil de Sortie /  
Alambre Líder (in/cm): 13.58 / 34.50



**234-4901**

Lead Wire / Fil de Sortie /  
Alambre Líder (in/cm): 10.24 / 26.00



**234-4899**

Lead Wire / Fil de Sortie /  
Alambre Líder (in/cm): 20.67 / 52.50



**234-4902**

Lead Wire / Fil de Sortie /  
Alambre Líder (in/cm): 13.58 / 34.50



**234-4900**

Lead Wire / Fil de Sortie /  
Alambre Líder (in/cm): 23.82 / 60.50



**234-4903**

Lead Wire / Fil de Sortie /  
Alambre Líder (in/cm): 14.29 / 36.30





**234-4904**

Lead Wire / Fil de Sortie /  
Alambre Líder (in/cm): 15.43 / 39.20



**234-4907**

Lead Wire / Fil de Sortie /  
Alambre Líder (in/cm): 7.56 / 19.20



**234-4905**

Lead Wire / Fil de Sortie /  
Alambre Líder (in/cm): 10.67 / 27.10



**234-4908**

Lead Wire / Fil de Sortie /  
Alambre Líder (in/cm): 20.24 / 51.40



**234-4906**

Lead Wire / Fil de Sortie /  
Alambre Líder (in/cm): 11.46 / 29.10



**234-4909**

Lead Wire / Fil de Sortie /  
Alambre Líder (in/cm): 13.46 / 34.20





**234-4910**

Lead Wire / Fil de Sortie /  
Alambre Lider (in/cm): 32.48 / 82.50



**234-4913**

Lead Wire / Fil de Sortie /  
Alambre Lider (in/cm): 32.48 / 82.50



**234-4911**

Lead Wire / Fil de Sortie /  
Alambre Lider (in/cm): 27.36 / 69.50



**234-4914**

Lead Wire / Fil de Sortie /  
Alambre Lider (in/cm): 59.45 / 151.00



**234-4912**

Lead Wire / Fil de Sortie /  
Alambre Lider (in/cm): 17.32 / 44.00



**234-4916**

Lead Wire / Fil de Sortie /  
Alambre Lider (in/cm): 10.83 / 27.50







**234-4917**

Lead Wire / Fil de Sortie /  
Alambre Líder (in/cm): 15.94 / 40.50



**234-4922**

Lead Wire / Fil de Sortie /  
Alambre Líder (in/cm): 21.34 / 54.20



**234-4920**

Lead Wire / Fil de Sortie /  
Alambre Líder (in/cm): 10.16 / 25.80



**234-4923**

Lead Wire / Fil de Sortie /  
Alambre Líder (in/cm): 23.03 / 58.50



**234-4921**

Lead Wire / Fil de Sortie /  
Alambre Líder (in/cm): 31.57 / 80.20



**234-4924**

Lead Wire / Fil de Sortie /  
Alambre Líder (in/cm): 7.17 / 18.20





**234-4925**

Lead Wire / Fil de Sortie /  
Alambre Líder (in/cm): 13.07 / 33.20



**234-4928**

Lead Wire / Fil de Sortie /  
Alambre Líder (in/cm): 24.13 / 61.30



**234-4926**

Lead Wire / Fil de Sortie /  
Alambre Líder (in/cm): 16.22 / 41.20



**234-4929**

Lead Wire / Fil de Sortie /  
Alambre Líder (in/cm): 26.50 / 67.30



**234-4927**

Lead Wire / Fil de Sortie /  
Alambre Líder (in/cm): 9.76 / 24.80



**234-4930**

Lead Wire / Fil de Sortie /  
Alambre Líder (in/cm): 44.09 / 112.00





**234-4931**

Lead Wire / Fil de Sortie /  
Alambre Líder (in/cm): 9.49 / 24.10



**234-4934**

Lead Wire / Fil de Sortie /  
Alambre Líder (in/cm): 16.26 / 41.30



**234-4932**

Lead Wire / Fil de Sortie /  
Alambre Líder (in/cm): 15.83 / 40.20



**234-4935**

Lead Wire / Fil de Sortie /  
Alambre Líder (in/cm): 29.13 / 74.00



**234-4933**

Lead Wire / Fil de Sortie /  
Alambre Líder (in/cm): 37.60 / 95.50



**234-4936**

Lead Wire / Fil de Sortie /  
Alambre Líder (in/cm): 31.50 / 80.00





**234-4937**

Lead Wire / Fil de Sortie /  
Alambre Líder (in/cm): 41.18 / 104.60



**234-4940**

Lead Wire / Fil de Sortie /  
Alambre Líder (in/cm): 13.19 / 33.50



**234-4938**

Lead Wire / Fil de Sortie /  
Alambre Líder (in/cm): 20.16 / 51.20



**234-4941**



**234-4939**

Lead Wire / Fil de Sortie /  
Alambre Líder (in/cm): 26.77 / 68.00



**234-4944**

Lead Wire / Fil de Sortie /  
Alambre Líder (in/cm): 15.35 / 39.00





**234-4945**

Lead Wire / Fil de Sortie /  
Alambre Líder (in/cm): 22.83 / 58.00



**234-4948**

Lead Wire / Fil de Sortie /  
Alambre Líder (in/cm): 27.48 / 69.80



**234-4946**

Lead Wire / Fil de Sortie /  
Alambre Líder (in/cm): 23.62 / 60.00



**234-4949**

Lead Wire / Fil de Sortie /  
Alambre Líder (in/cm): 8.27 / 21.00



**234-4947**

Lead Wire / Fil de Sortie /  
Alambre Líder (in/cm): 16.85 / 42.80



**234-4950**

Lead Wire / Fil de Sortie /  
Alambre Líder (in/cm): 17.32 / 44.00





**234-4951**

Lead Wire / Fil de Sortie /  
Alambre Líder (in/cm): 18.90 / 48.00



**234-4954**

Lead Wire / Fil de Sortie /  
Alambre Líder (in/cm): 29.13 / 74.00



**234-4952**

Lead Wire / Fil de Sortie /  
Alambre Líder (in/cm): 19.49 / 49.50



**234-4955**

Lead Wire / Fil de Sortie /  
Alambre Líder (in/cm): 10.24 / 26.00



**234-4953**

Lead Wire / Fil de Sortie /  
Alambre Líder (in/cm): 28.78 / 73.10



**234-4956**

Lead Wire / Fil de Sortie /  
Alambre Líder (in/cm): 28.90 / 73.40





**234-4957**

Lead Wire / Fil de Sortie /  
Alambre Líder (in/cm): 30.00 / 76.20



**234-4960**

Lead Wire / Fil de Sortie /  
Alambre Líder (in/cm): 21.65 / 55.00



**234-4958**

Lead Wire / Fil de Sortie /  
Alambre Líder (in/cm): 38.07 / 96.70



**234-4961**

Lead Wire / Fil de Sortie /  
Alambre Líder (in/cm): 15.16 / 38.50



**234-4959**

Lead Wire / Fil de Sortie /  
Alambre Líder (in/cm): 27.05 / 68.70



**234-4962**

Lead Wire / Fil de Sortie /  
Alambre Líder (in/cm): 29.33 / 74.50





**234-4963**

Lead Wire / Fil de Sortie /  
Alambre Líder (in/cm): 29.33 / 74.50



**234-4966**

Lead Wire / Fil de Sortie /  
Alambre Líder (in/cm): 17.56 / 44.60



**234-4964**

Lead Wire / Fil de Sortie /  
Alambre Líder (in/cm): 12.99 / 33.00



**234-4967**

Lead Wire / Fil de Sortie /  
Alambre Líder (in/cm): 26.57 / 67.50



**234-4965**

Lead Wire / Fil de Sortie /  
Alambre Líder (in/cm): 17.32 / 44.00



**234-4968**

Lead Wire / Fil de Sortie /  
Alambre Líder (in/cm): 15.87 / 40.30







**234-4969**

Lead Wire / Fil de Sortie /  
Alambre Líder (in/cm): 56.30 / 143.00



**234-4972**

Lead Wire / Fil de Sortie /  
Alambre Líder (in/cm): 26.57 / 67.50



**234-4970**

Lead Wire / Fil de Sortie /  
Alambre Líder (in/cm): 15.83 / 40.20



**234-4973**

Lead Wire / Fil de Sortie /  
Alambre Líder (in/cm): 26.54 / 67.40



**234-4971**

Lead Wire / Fil de Sortie /  
Alambre Líder (in/cm): 24.25 / 61.60



**234-4974**

Lead Wire / Fil de Sortie /  
Alambre Líder (in/cm): 13.19 / 33.50





**234-4975**

Lead Wire / Fil de Sortie /  
Alambre Líder (in/cm): 17.28 / 43.90



**234-4978**

Lead Wire / Fil de Sortie /  
Alambre Líder (in/cm): 25.59 / 65.00



**234-4976**

Lead Wire / Fil de Sortie /  
Alambre Líder (in/cm): 27.17 / 69.00



**234-4979**

Lead Wire / Fil de Sortie /  
Alambre Líder (in/cm): 8.66 / 22.00



**234-4977**

Lead Wire / Fil de Sortie /  
Alambre Líder (in/cm): 11.42 / 29.00



**234-4980**

Lead Wire / Fil de Sortie /  
Alambre Líder (in/cm): 11.81 / 30.00





**234-4981**

Lead Wire / Fil de Sortie /  
Alambre Líder (in/cm): 27.28 / 69.30



**234-4984**

Lead Wire / Fil de Sortie /  
Alambre Líder (in/cm): 18.74 / 47.60



**234-4982**

Lead Wire / Fil de Sortie /  
Alambre Líder (in/cm): 17.76 / 45.10



**234-4985**

Lead Wire / Fil de Sortie /  
Alambre Líder (in/cm): 11.18 / 28.40



**234-4983**

Lead Wire / Fil de Sortie /  
Alambre Líder (in/cm): 9.06 / 23.00



**234-4986**

Lead Wire / Fil de Sortie /  
Alambre Líder (in/cm): 15.08 / 38.30





**234-4987**

Lead Wire / Fil de Sortie /  
Alambre Líder (in/cm): 19.02 / 48.30



**234-4990**

Lead Wire / Fil de Sortie /  
Alambre Líder (in/cm): 17.01 / 43.20



**234-4988**

Lead Wire / Fil de Sortie /  
Alambre Líder (in/cm): 9.53 / 24.20



**234-4991**

Lead Wire / Fil de Sortie /  
Alambre Líder (in/cm): 11.30 / 28.70



**234-4989**

Lead Wire / Fil de Sortie /  
Alambre Líder (in/cm): 11.61 / 29.50



**234-4992**

Lead Wire / Fil de Sortie /  
Alambre Líder (in/cm): 29.92 / 76.00





**234-4993**

Lead Wire / Fil de Sortie /  
Alambre Líder (in/cm): 28.35 / 72.00



**234-4996**

Lead Wire / Fil de Sortie /  
Alambre Líder (in/cm): 16.61 / 42.20



**234-4994**

Lead Wire / Fil de Sortie /  
Alambre Líder (in/cm): 23.23 / 59.00



**234-5001**

Lead Wire / Fil de Sortie /  
Alambre Líder (in/cm): 37.20 / 94.50



**234-4995**

Lead Wire / Fil de Sortie /  
Alambre Líder (in/cm): 28.31 / 71.90



**234-5002**

Lead Wire / Fil de Sortie /  
Alambre Líder (in/cm): 14.53 / 36.90





**234-5003**

Lead Wire / Fil de Sortie /  
Alambre Líder (in/cm): 20.28 / 51.50



**234-5006**

Lead Wire / Fil de Sortie /  
Alambre Líder (in/cm): 22.20 / 56.40



**234-5004**

Lead Wire / Fil de Sortie /  
Alambre Líder (in/cm): 11.61 / 29.50



**234-5007**

Lead Wire / Fil de Sortie /  
Alambre Líder (in/cm): 14.96 / 38.00



**234-5005**

Lead Wire / Fil de Sortie /  
Alambre Líder (in/cm): 16.22 / 41.20



**234-5008**

Lead Wire / Fil de Sortie /  
Alambre Líder (in/cm): 62.01 / 157.50





**234-5009**

Lead Wire / Fil de Sortie /  
Alambre Líder (in/cm): 30.91 / 78.50



**234-5012**

Lead Wire / Fil de Sortie /  
Alambre Líder (in/cm): 31.50 / 80.00



**234-5010**

Lead Wire / Fil de Sortie /  
Alambre Líder (in/cm): 11.50 / 29.20



**234-5013**

Lead Wire / Fil de Sortie /  
Alambre Líder (in/cm): 28.74 / 73.00



**234-5011**

Lead Wire / Fil de Sortie /  
Alambre Líder (in/cm): 24.41 / 62.00



**234-5014**

Lead Wire / Fil de Sortie /  
Alambre Líder (in/cm): 30.71 / 78.00





**234-5015**

Lead Wire / Fil de Sortie /  
Alambre Líder (in/cm): 19.41 / 49.30



**234-5022**

Lead Wire / Fil de Sortie /  
Alambre Líder (in/cm): 49.72 / 126.30



**234-5018**

Lead Wire / Fil de Sortie /  
Alambre Líder (in/cm): 10.79 / 27.40



**234-5023**

Lead Wire / Fil de Sortie /  
Alambre Líder (in/cm): 57.40 / 145.80



**234-5019**

Lead Wire / Fil de Sortie /  
Alambre Líder (in/cm): 12.80 / 32.50



**234-5024**

Lead Wire / Fil de Sortie /  
Alambre Líder (in/cm): 26.93 / 68.40







**234-5025**

Lead Wire / Fil de Sortie /  
Alambre Líder (in/cm): 51.10 / 129.80



**234-5028**

Lead Wire / Fil de Sortie /  
Alambre Líder (in/cm): 28.74 / 73.00



**234-5026**

Lead Wire / Fil de Sortie /  
Alambre Líder (in/cm): 19.17 / 48.70



**234-5029**

Lead Wire / Fil de Sortie /  
Alambre Líder (in/cm): 17.80 / 45.20



**234-5027**

Lead Wire / Fil de Sortie /  
Alambre Líder (in/cm): 43.31 / 110.00



**234-5030**

Lead Wire / Fil de Sortie /  
Alambre Líder (in/cm): 25.39 / 64.50





**234-5032**

Lead Wire / Fil de Sortie /  
Alambre Líder (in/cm): 11.61 / 29.50



**234-5036**

Lead Wire / Fil de Sortie /  
Alambre Líder (in/cm): 24.80 / 63.00



**234-5033**

Lead Wire / Fil de Sortie /  
Alambre Líder (in/cm): 21.65 / 55.00



**234-5037**

Lead Wire / Fil de Sortie /  
Alambre Líder (in/cm): 11.97 / 30.40



**234-5034**

Lead Wire / Fil de Sortie /  
Alambre Líder (in/cm): 21.02 / 53.40



**234-5038**

Lead Wire / Fil de Sortie /  
Alambre Líder (in/cm): 11.57 / 29.40





**234-5039**

Lead Wire / Fil de Sortie /  
Alambre Líder (in/cm): 16.61 / 42.20



**234-5042**

Lead Wire / Fil de Sortie /  
Alambre Líder (in/cm): 29.53 / 75.00



**234-5040**

Lead Wire / Fil de Sortie /  
Alambre Líder (in/cm): 19.49 / 49.50



**234-5043**

Lead Wire / Fil de Sortie /  
Alambre Líder (in/cm): 19.61 / 49.80



**234-5041**

Lead Wire / Fil de Sortie /  
Alambre Líder (in/cm): 11.89 / 30.20



**234-5044**

Lead Wire / Fil de Sortie /  
Alambre Líder (in/cm): 26.93 / 68.40





**234-5045**

Lead Wire / Fil de Sortie /  
Alambre Líder (in/cm): 67.72 / 172.00



**234-5048**

Lead Wire / Fil de Sortie /  
Alambre Líder (in/cm): 18.50 / 47.00



**234-5046**

Lead Wire / Fil de Sortie /  
Alambre Líder (in/cm): 12.99 / 33.00



**234-5049**

Lead Wire / Fil de Sortie /  
Alambre Líder (in/cm): 26.57 / 67.50



**234-5047**

Lead Wire / Fil de Sortie /  
Alambre Líder (in/cm): 21.73 / 55.20



**234-5050**

Lead Wire / Fil de Sortie /  
Alambre Líder (in/cm): 8.15 / 20.70





**234-5051**

Lead Wire / Fil de Sortie /  
Alambre Líder (in/cm): 40.55 / 103.00



**234-5054**

Lead Wire / Fil de Sortie /  
Alambre Líder (in/cm): 15.24 / 38.7



**234-5052**

Lead Wire / Fil de Sortie /  
Alambre Líder (in/cm): 15.94 / 40.50



**234-5055**

Lead Wire / Fil de Sortie /  
Alambre Líder (in/cm): 23.23 / 59



**234-5053**

Lead Wire / Fil de Sortie /  
Alambre Líder (in/cm): 11.61 / 29.50



**234-5056**

Lead Wire / Fil de Sortie /  
Alambre Líder (in/cm): 10.51 / 26.7





**234-5057**

Lead Wire / Fil de Sortie /  
Alambre Líder (in/cm): 15.16 / 38.5



**234-5060**

Lead Wire / Fil de Sortie /  
Alambre Líder (in/cm): 14.57 / 37.00



**234-5058**

Lead Wire / Fil de Sortie /  
Alambre Líder (in/cm): 18.9 / 48



**234-5061**

Lead Wire / Fil de Sortie /  
Alambre Líder (in/cm): 20.87 / 53.00



**234-5059**

Lead Wire / Fil de Sortie /  
Alambre Líder (in/cm): 24.49 / 62.2



**234-5062**

Lead Wire / Fil de Sortie /  
Alambre Líder (in/cm): 14.57 / 37.00





**234-5063**

Lead Wire / Fil de Sortie /  
Alambre Líder (in/cm): 16.65 / 42.3



**234-5066**

Lead Wire / Fil de Sortie /  
Alambre Líder (in/cm): 18.62 / 47.3



**234-5064**

Lead Wire / Fil de Sortie /  
Alambre Líder (in/cm): 52.56 / 133.5



**234-5067**

Lead Wire / Fil de Sortie /  
Alambre Líder (in/cm): 26.81 / 68.1



**234-5065**

Lead Wire / Fil de Sortie /  
Alambre Líder (in/cm): 19.96 / 50.7



**234-5068**

Lead Wire / Fil de Sortie /  
Alambre Líder (in/cm): 18.27 / 46.4





**234-5069**

Lead Wire / Fil de Sortie /  
Alambre Líder (in/cm): 30.87 / 78.4



**234-5073**

Lead Wire / Fil de Sortie /  
Alambre Líder (in/cm): 23.23 / 59.00



**234-5071**

Lead Wire / Fil de Sortie /  
Alambre Líder (in/cm): 13.15 / 33.40



**234-5074**

Lead Wire / Fil de Sortie /  
Alambre Líder (in/cm): 58.35 / 148.20



**234-5072**

Lead Wire / Fil de Sortie /  
Alambre Líder (in/cm): 28.35 / 72.00



**234-5075**

Lead Wire / Fil de Sortie /  
Alambre Líder (in/cm): 20.55 / 52.20







**234-5076**

Lead Wire / Fil de Sortie /  
Alambre Líder (in/cm): 28.74 / 73.00



**234-5079**

Lead Wire / Fil de Sortie /  
Alambre Líder (in/cm): 28.90 / 73.40



**234-5077**

Lead Wire / Fil de Sortie /  
Alambre Líder (in/cm): 12.83 / 32.60



**234-5080**

Lead Wire / Fil de Sortie /  
Alambre Líder (in/cm): 28.86 / 73.30



**234-5078**

Lead Wire / Fil de Sortie /  
Alambre Líder (in/cm): 12.72 / 32.30



**234-5081**

Lead Wire / Fil de Sortie /  
Alambre Líder (in/cm): 18.58 / 47.20





**234-5082**

Lead Wire / Fil de Sortie /  
Alambre Líder (in/cm): 12.48 / 31.70



**234-5085**

Lead Wire / Fil de Sortie /  
Alambre Líder (in/cm): 16.61 / 42.20



**234-5083**

Lead Wire / Fil de Sortie /  
Alambre Líder (in/cm): 19.88 / 50.50



**234-5086**

Lead Wire / Fil de Sortie /  
Alambre Líder (in/cm): 21.65 / 55.00



**234-5084**

Lead Wire / Fil de Sortie /  
Alambre Líder (in/cm): 21.73 / 55.20



**234-5087**

Lead Wire / Fil de Sortie /  
Alambre Líder (in/cm): 19.21 / 48.80





**234-5090**

Lead Wire / Fil de Sortie /  
Alambre Líder (in/cm): 13.15 / 33.40



**234-5093**

Lead Wire / Fil de Sortie /  
Alambre Líder (in/cm): 22.24 / 56.50



**234-5091**

Lead Wire / Fil de Sortie /  
Alambre Líder (in/cm): 31.50 / 80.00



**234-5094**

Lead Wire / Fil de Sortie /  
Alambre Líder (in/cm): 25.98 / 66.00



**234-5092**

Lead Wire / Fil de Sortie /  
Alambre Líder (in/cm): 53.15 / 135.00



**234-5095**

Lead Wire / Fil de Sortie /  
Alambre Líder (in/cm): 18.70 / 47.50





**234-5096**

Lead Wire / Fil de Sortie /  
Alambre Líder (in/cm): 21.34 / 54.20



**234-5099**

Lead Wire / Fil de Sortie /  
Alambre Líder (in/cm): 10.35 / 26.30



**234-5097**

Lead Wire / Fil de Sortie /  
Alambre Líder (in/cm): 11.54 / 29.30



**234-5102**

Lead Wire / Fil de Sortie /  
Alambre Líder (in/cm): 30.47 / 77.40



**234-5098**

Lead Wire / Fil de Sortie /  
Alambre Líder (in/cm): 10.39 / 26.40



**234-5103**

Lead Wire / Fil de Sortie /  
Alambre Líder (in/cm): 67.13 / 170.50





**234-5104**

Lead Wire / Fil de Sortie /  
Alambre Líder (in/cm): 12.60 / 32.00



**234-5107**

Lead Wire / Fil de Sortie /  
Alambre Líder (in/cm): 22.87 / 58.10



**234-5105**

Lead Wire / Fil de Sortie /  
Alambre Líder (in/cm): 51.97 / 132.00



**234-5108**

Lead Wire / Fil de Sortie /  
Alambre Líder (in/cm): 33.27 / 84.50



**234-5106**

Lead Wire / Fil de Sortie /  
Alambre Líder (in/cm): 56.18 / 142.70



**234-5110**

Lead Wire / Fil de Sortie /  
Alambre Líder (in/cm): 11.46 / 29.10





**234-5113**

Lead Wire / Fil de Sortie /  
Alambre Lider (in/cm): 16.73 / 42.50



**234-5116**

Lead Wire / Fil de Sortie /  
Alambre Lider (in/cm): 39.96 / 101.50



**234-5114**

Lead Wire / Fil de Sortie /  
Alambre Lider (in/cm): 36.10 / 91.70



**234-5117**

Lead Wire / Fil de Sortie /  
Alambre Lider (in/cm): 33.07 / 84.00



**234-5115**

Lead Wire / Fil de Sortie /  
Alambre Lider (in/cm): 35.55 / 90.30



**234-5118**

Lead Wire / Fil de Sortie /  
Alambre Lider (in/cm): 28.15 / 71.50





**234-5119**

Lead Wire / Fil de Sortie /  
Alambre Líder (in/cm): 49.53 / 125.80



**234-5126**

Lead Wire / Fil de Sortie /  
Alambre Líder (in/cm): 30.28 / 76.90



**234-5120**

Lead Wire / Fil de Sortie /  
Alambre Líder (in/cm): 22.56 / 57.30



**234-5127**

Lead Wire / Fil de Sortie /  
Alambre Líder (in/cm): 28.74 / 73.00



**234-5125**

Lead Wire / Fil de Sortie /  
Alambre Líder (in/cm): 14.57 / 37.00



**234-5128**

Lead Wire / Fil de Sortie /  
Alambre Líder (in/cm): 28.82 / 73.20





**234-5129**

Lead Wire / Fil de Sortie /  
Alambre Lider (in/cm): 19.45 / 49.40



**234-5133**

Lead Wire / Fil de Sortie /  
Alambre Lider (in/cm): 24.37 / 61.90



**234-5131**

Lead Wire / Fil de Sortie /  
Alambre Lider (in/cm): 18.11 / 46.00



**234-5134**

Lead Wire / Fil de Sortie /  
Alambre Lider (in/cm): 40.67 / 103.30



**234-5132**

Lead Wire / Fil de Sortie /  
Alambre Lider (in/cm): 18.19 / 46.20



**234-5135**

Lead Wire / Fil de Sortie /  
Alambre Lider (in/cm): 14.29 / 36.30







**234-5136**

Lead Wire / Fil de Sortie /  
Alambre Líder (in/cm): 26.26 / 66.70



**234-5139**

Lead Wire / Fil de Sortie /  
Alambre Líder (in/cm): 60.43 / 153.50



**234-5137**

Lead Wire / Fil de Sortie /  
Alambre Líder (in/cm): 38.66 / 98.20



**234-5140**

Lead Wire / Fil de Sortie /  
Alambre Líder (in/cm): 23.46 / 59.60



**234-5138**

Lead Wire / Fil de Sortie /  
Alambre Líder (in/cm): 46.85 / 119.00



**234-5141**

Lead Wire / Fil de Sortie /  
Alambre Líder (in/cm): 23.62 / 60





**234-5142**

Lead Wire / Fil de Sortie /  
Alambre Líder (in/cm): 25.98 / 66



**234-5145**

Lead Wire / Fil de Sortie /  
Alambre Líder (in/cm): 24.09 / 61.2



**234-5143**

Lead Wire / Fil de Sortie /  
Alambre Líder (in/cm): 34.37 / 87.3



**234-5146**

Lead Wire / Fil de Sortie /  
Alambre Líder (in/cm): 35.35 / 89.8



**234-5144**

Lead Wire / Fil de Sortie /  
Alambre Líder (in/cm): 25.28 / 64.2



**234-5147**

Lead Wire / Fil de Sortie /  
Alambre Líder (in/cm): 17.6 / 44.7





**234-5148**

Lead Wire / Fil de Sortie /  
Alambre Líder (in/cm): 34.80 / 88



**234-5152**

Lead Wire / Fil de Sortie /  
Alambre Líder (in/cm): 10.55 / 26.80



**234-5150**

Lead Wire / Fil de Sortie /  
Alambre Líder (in/cm): 20.47 / 52.00



**234-5153**

Lead Wire / Fil de Sortie /  
Alambre Líder (in/cm): 22.09 / 56.10



**234-5151**

Lead Wire / Fil de Sortie /  
Alambre Líder (in/cm): 19.29 / 49.00



**234-5154**

Lead Wire / Fil de Sortie /  
Alambre Líder (in/cm): 29.84 / 75.80





**234-5155**

Lead Wire / Fil de Sortie /  
Alambre Líder (in/cm): 17.87 / 45.40



**234-5158**

Lead Wire / Fil de Sortie /  
Alambre Líder (in/cm): 21.46 / 54.50



**234-5156**

Lead Wire / Fil de Sortie /  
Alambre Líder (in/cm): 12.68 / 32.20



**234-5159**

Lead Wire / Fil de Sortie /  
Alambre Líder (in/cm): 51.18 / 130.00



**234-5157**

Lead Wire / Fil de Sortie /  
Alambre Líder (in/cm): 24.49 / 62.20



**234-5160**

Lead Wire / Fil de Sortie /  
Alambre Líder (in/cm): 24.53 / 62.30





**234-5161**

Lead Wire / Fil de Sortie /  
Alambre Líder (in/cm): 24.61 / 62.50



**234-5164**

Lead Wire / Fil de Sortie /  
Alambre Líder (in/cm): 22.52 / 57.20



**234-5162**

Lead Wire / Fil de Sortie /  
Alambre Líder (in/cm): 22.52 / 57.20



**234-5165**

Lead Wire / Fil de Sortie /  
Alambre Líder (in/cm): 33.39 / 84.80



**234-5163**

Lead Wire / Fil de Sortie /  
Alambre Líder (in/cm): 17.05 / 43.30



**234-5166**

Lead Wire / Fil de Sortie /  
Alambre Líder (in/cm): 25.83 / 65.60





**234-5167**

Lead Wire / Fil de Sortie /  
Alambre Lider (in/cm): 18.50 / 47.00



**234-5170**

Lead Wire / Fil de Sortie /  
Alambre Lider (in/cm): 23.70 / 60.20



**234-5168**

Lead Wire / Fil de Sortie /  
Alambre Lider (in/cm): 15.20 / 38.60



**234-5171**

Lead Wire / Fil de Sortie /  
Alambre Lider (in/cm): 23.78 / 60.40



**234-5169**

Lead Wire / Fil de Sortie /  
Alambre Lider (in/cm): 20.39 / 51.80



**234-5172**

Lead Wire / Fil de Sortie /  
Alambre Lider (in/cm): 11.46 / 29.10





**234-5173**

Lead Wire / Fil de Sortie /  
Alambre Líder (in/cm): 14.65 / 37.20



**234-5176**

Lead Wire / Fil de Sortie /  
Alambre Líder (in/cm): 19.17 / 48.70



**234-5174**

Lead Wire / Fil de Sortie /  
Alambre Líder (in/cm): 19.80 / 50.30



**234-5177**

Lead Wire / Fil de Sortie /  
Alambre Líder (in/cm): 28.15 / 71.50



**234-5175**

Lead Wire / Fil de Sortie /  
Alambre Líder (in/cm): 11.46 / 29.10



**234-5178**

Lead Wire / Fil de Sortie /  
Alambre Líder (in/cm): 11.10 / 28.20





**234-5180**

Lead Wire / Fil de Sortie /  
Alambre Líder (in/cm): 23.82 / 60.50



**234-5183**

Lead Wire / Fil de Sortie /  
Alambre Líder (in/cm): 23.03 / 58.50



**234-5181**

Lead Wire / Fil de Sortie /  
Alambre Líder (in/cm): 12.01 / 30.50



**234-5184**

Lead Wire / Fil de Sortie /  
Alambre Líder (in/cm): 17.01 / 43.20



**234-5182**

Lead Wire / Fil de Sortie /  
Alambre Líder (in/cm): 17.60 / 44.70



**234-5185**

Lead Wire / Fil de Sortie /  
Alambre Líder (in/cm): 26.89 / 68.30







**234-5430**

Lead Wire / Fil de Sortie /  
Alambre Líder (in/cm): 20.87 / 53.00



**234-5702**

Lead Wire / Fil de Sortie /  
Alambre Líder (in/cm): 23.23 / 59.00



**234-5700**

Lead Wire / Fil de Sortie /  
Alambre Líder (in/cm): 47.24 / 120.00



**234-5703**

Lead Wire / Fil de Sortie /  
Alambre Líder (in/cm): 34.17 / 86.80



**234-5701**

Lead Wire / Fil de Sortie /  
Alambre Líder (in/cm): 40.55 / 103.00



**234-5705**

Lead Wire / Fil de Sortie /  
Alambre Líder (in/cm): 52.09 / 132.30





**234-9001**

Lead Wire / Fil de Sortie /  
Alambre Líder (in/cm): 10.63 / 27.00



**234-9004**

Lead Wire / Fil de Sortie /  
Alambre Líder (in/cm): 10.24 / 26.00



**234-9002**

Lead Wire / Fil de Sortie /  
Alambre Líder (in/cm): 13.39 / 34.00



**234-9005**

Lead Wire / Fil de Sortie /  
Alambre Líder (in/cm): 13.78 / 35.00



**234-9003**

Lead Wire / Fil de Sortie /  
Alambre Líder (in/cm): 16.54 / 42.00



**234-9006**

Lead Wire / Fil de Sortie /  
Alambre Líder (in/cm): 16.54 / 42.00





**234-9007**

Lead Wire / Fil de Sortie /  
Alambre Líder (in/cm): 11.02 / 28.00



**234-9010**

Lead Wire / Fil de Sortie /  
Alambre Líder (in/cm): 20.47 / 52.00



**234-9008**

Lead Wire / Fil de Sortie /  
Alambre Líder (in/cm): 18.03 / 45.80



**234-9011**

Lead Wire / Fil de Sortie /  
Alambre Líder (in/cm): 31.50 / 80.00



**234-9009**

Lead Wire / Fil de Sortie /  
Alambre Líder (in/cm): 14.17 / 36.00



**234-9012**

Lead Wire / Fil de Sortie /  
Alambre Líder (in/cm): 7.09 / 18.00





**234-9013**

Lead Wire / Fil de Sortie /  
Alambre Lider (in/cm): 8.07 / 20.50



**234-9016**

Lead Wire / Fil de Sortie /  
Alambre Lider (in/cm): 17.72 / 45.00



**234-9014**

Lead Wire / Fil de Sortie /  
Alambre Lider (in/cm): 13.78 / 35.00



**234-9017**

Lead Wire / Fil de Sortie /  
Alambre Lider (in/cm): 21.65 / 55.00



**234-9015**

Lead Wire / Fil de Sortie /  
Alambre Lider (in/cm): 20.47 / 52.00



**234-9018**

Lead Wire / Fil de Sortie /  
Alambre Lider (in/cm): 15.35 / 39.00





**234-9019**

Lead Wire / Fil de Sortie /  
Alambre Líder (in/cm): 24.41 / 62.00



**234-9022**

Lead Wire / Fil de Sortie /  
Alambre Líder (in/cm): 13.39 / 34.00



**234-9020**

Lead Wire / Fil de Sortie /  
Alambre Líder (in/cm): 20.87 / 53.00



**234-9023**

Lead Wire / Fil de Sortie /  
Alambre Líder (in/cm): 15.35 / 39.00



**234-9021**

Lead Wire / Fil de Sortie /  
Alambre Líder (in/cm): 14.17 / 36.00



**234-9024**

Lead Wire / Fil de Sortie /  
Alambre Líder (in/cm): 18.90 / 48.00





**234-9025**

Lead Wire / Fil de Sortie /  
Alambre Líder (in/cm): 13.78 / 35.00



**234-9028**

Lead Wire / Fil de Sortie /  
Alambre Líder (in/cm): 11.81 / 30.00



**234-9026**

Lead Wire / Fil de Sortie /  
Alambre Líder (in/cm): 7.09 / 18.00



**234-9029**

Lead Wire / Fil de Sortie /  
Alambre Líder (in/cm): 17.72 / 45.00



**234-9027**

Lead Wire / Fil de Sortie /  
Alambre Líder (in/cm): 18.46 / 46.90



**234-9030**

Lead Wire / Fil de Sortie /  
Alambre Líder (in/cm): 11.81 / 30.00





**234-9031**

Lead Wire / Fil de Sortie /  
Alambre Líder (in/cm): 7.87 / 20.00



**234-9034**

Lead Wire / Fil de Sortie /  
Alambre Líder (in/cm): 31.06 / 78.90



**234-9032**

Lead Wire / Fil de Sortie /  
Alambre Líder (in/cm): 7.87 / 20.00



**234-9035**

Lead Wire / Fil de Sortie /  
Alambre Líder (in/cm): 10.63 / 27.00



**234-9033**

Lead Wire / Fil de Sortie /  
Alambre Líder (in/cm): 15.35 / 39.00



**234-9036**

Lead Wire / Fil de Sortie /  
Alambre Líder (in/cm): 14.53 / 36.90





**234-9037**

Lead Wire / Fil de Sortie /  
Alambre Líder (in/cm): 14.53 / 36.90



**234-9040**

Lead Wire / Fil de Sortie /  
Alambre Líder (in/cm): 16.14 / 41.00



**234-9038**

Lead Wire / Fil de Sortie /  
Alambre Líder (in/cm): 14.57 / 37.00



**234-9041**

Lead Wire / Fil de Sortie /  
Alambre Líder (in/cm): 20.16 / 51.20



**234-9039**

Lead Wire / Fil de Sortie /  
Alambre Líder (in/cm): 14.57 / 37.00



**234-9042**

Lead Wire / Fil de Sortie /  
Alambre Líder (in/cm): 11.93 / 30.30







**234-9047**

Lead Wire / Fil de Sortie /  
Alambre Líder (in/cm): 7.87 / 20.00



**234-9050**

Lead Wire / Fil de Sortie /  
Alambre Líder (in/cm): 14.17 / 36.00



**234-9048**

Lead Wire / Fil de Sortie /  
Alambre Líder (in/cm): 10.83 / 27.50



**234-9051**

Lead Wire / Fil de Sortie /  
Alambre Líder (in/cm): 8.66 / 22.00



**234-9049**

Lead Wire / Fil de Sortie /  
Alambre Líder (in/cm): 20.08 / 51.00

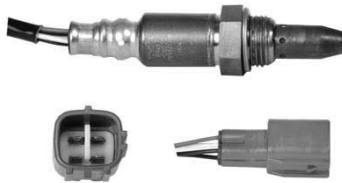

**234-9052**

Lead Wire / Fil de Sortie /  
Alambre Líder (in/cm): 14.80 / 37.60





**234-9054**

Lead Wire / Fil de Sortie /  
Alambre Líder (in/cm): 19.02 / 48.30



**234-9058**

Lead Wire / Fil de Sortie /  
Alambre Líder (in/cm): 11.42 / 29.00



**234-9056**

Lead Wire / Fil de Sortie /  
Alambre Líder (in/cm): 14.25 / 36.20



**234-9059**

Lead Wire / Fil de Sortie /  
Alambre Líder (in/cm): 22.72 / 57.70



**234-9057**

Lead Wire / Fil de Sortie /  
Alambre Líder (in/cm): 9.06 / 23.00



**234-9060**

Lead Wire / Fil de Sortie /  
Alambre Líder (in/cm): 10.63 / 27.00





**234-9061**

Lead Wire / Fil de Sortie /  
Alambre Líder (in/cm): 13.31 / 33.80



**234-9064**

Lead Wire / Fil de Sortie /  
Alambre Líder (in/cm): 13.98 / 35.50



**234-9062**

Lead Wire / Fil de Sortie /  
Alambre Líder (in/cm): 11.38 / 28.90



**234-9065**

Lead Wire / Fil de Sortie /  
Alambre Líder (in/cm): 20.39 / 51.80



**234-9063**

Lead Wire / Fil de Sortie /  
Alambre Líder (in/cm): 15.83 / 40.20



**234-9066**

Lead Wire / Fil de Sortie /  
Alambre Líder (in/cm): 23.62 / 60.00





**234-9067**

Lead Wire / Fil de Sortie /  
Alambre Líder (in/cm): 11.42 / 29.00



**234-9070**

Lead Wire / Fil de Sortie /  
Alambre Líder (in/cm): 14.76 / 37.50



**234-9068**

Lead Wire / Fil de Sortie /  
Alambre Líder (in/cm): 8.66 / 22.00



**234-9071**

Lead Wire / Fil de Sortie /  
Alambre Líder (in/cm): 14.57 / 37.00



**234-9069**

Lead Wire / Fil de Sortie /  
Alambre Líder (in/cm): 10.43 / 26.50



**234-9072**

Lead Wire / Fil de Sortie /  
Alambre Líder (in/cm): 14.65 / 37.20





**234-9073**

Lead Wire / Fil de Sortie /  
Alambre Líder (in/cm): 14.69 / 37.30



**234-9076**

Lead Wire / Fil de Sortie /  
Alambre Líder (in/cm): 12.99 / 33.00



**234-9074**

Lead Wire / Fil de Sortie /  
Alambre Líder (in/cm): 11.93 / 30.30



**234-9077**

Lead Wire / Fil de Sortie /  
Alambre Líder (in/cm): 10.35 / 26.30



**234-9075**

Lead Wire / Fil de Sortie /  
Alambre Líder (in/cm): 7.95 / 20.20



**234-9078**

Lead Wire / Fil de Sortie /  
Alambre Líder (in/cm): 10.55 / 26.80





**234-9079**

Lead Wire / Fil de Sortie /  
Alambre Lider (in/cm): 18.31 / 46.50



**234-9082**

Lead Wire / Fil de Sortie /  
Alambre Lider (in/cm): 14.37 / 36.50



**234-9080**

Lead Wire / Fil de Sortie /  
Alambre Lider (in/cm): 14.53 / 36.90



**234-9083**

Lead Wire / Fil de Sortie /  
Alambre Lider (in/cm): 10.67 / 27.10



**234-9081**

Lead Wire / Fil de Sortie /  
Alambre Lider (in/cm): 14.57 / 37.00



**234-9084**

Lead Wire / Fil de Sortie /  
Alambre Lider (in/cm): 12.48 / 31.70





**234-9085**

Lead Wire / Fil de Sortie /  
Alambre Líder (in/cm): 18.11 / 46.00



**234-9088**

Lead Wire / Fil de Sortie /  
Alambre Líder (in/cm): 8.90 / 22.60



**234-9086**

Lead Wire / Fil de Sortie /  
Alambre Líder (in/cm): 24.41 / 62.00



**234-9089**

Lead Wire / Fil de Sortie /  
Alambre Líder (in/cm): 13.03 / 33.10



**234-9087**

Lead Wire / Fil de Sortie /  
Alambre Líder (in/cm): 24.53 / 62.30



**234-9090**

Lead Wire / Fil de Sortie /  
Alambre Líder (in/cm): 13.35 / 33.90





**234-9091**

Lead Wire / Fil de Sortie /  
Alambre Líder (in/cm): 13.78 / 35.00



**234-9094**

Lead Wire / Fil de Sortie /  
Alambre Líder (in/cm): 24.80 / 63.00



**234-9092**

Lead Wire / Fil de Sortie /  
Alambre Líder (in/cm): 7.64 / 19.40



**234-9095**

Lead Wire / Fil de Sortie /  
Alambre Líder (in/cm): 9.96 / 25.30



**234-9093**

Lead Wire / Fil de Sortie /  
Alambre Líder (in/cm): 8.90 / 22.60



**234-9096**

Lead Wire / Fil de Sortie /  
Alambre Líder (in/cm): 14.57 / 37.00







**234-9097**

Lead Wire / Fil de Sortie /  
Alambre Líder (in/cm): 19.88 / 50.50



**234-9100**

Lead Wire / Fil de Sortie /  
Alambre Líder (in/cm): 15.04 / 38.20



**234-9098**

Lead Wire / Fil de Sortie /  
Alambre Líder (in/cm): 22.44 / 57.00



**234-9101**

Lead Wire / Fil de Sortie /  
Alambre Líder (in/cm): 7.20 / 18.30



**234-9099**

Lead Wire / Fil de Sortie /  
Alambre Líder (in/cm): 9.25 / 23.50



**234-9102**

Lead Wire / Fil de Sortie /  
Alambre Líder (in/cm): 21.42 / 54.40





**234-9103**

Lead Wire / Fil de Sortie /  
Alambre Líder (in/cm): 20.87 / 53.00



**234-9106**

Lead Wire / Fil de Sortie /  
Alambre Líder (in/cm): 14.55 / 36.95



**234-9104**

Lead Wire / Fil de Sortie /  
Alambre Líder (in/cm): 14.53 / 36.90



**234-9107**

Lead Wire / Fil de Sortie /  
Alambre Líder (in/cm): 14.57 / 37.00



**234-9105**

Lead Wire / Fil de Sortie /  
Alambre Líder (in/cm): 10.61 / 26.95



**234-9108**

Lead Wire / Fil de Sortie /  
Alambre Líder (in/cm): 10.63 / 27.00





**234-9109**

Lead Wire / Fil de Sortie /  
Alambre Líder (in/cm): 12.60 / 32.00



**234-9113**

Lead Wire / Fil de Sortie /  
Alambre Líder (in/cm): 8.27 / 21.00



**234-9111**

Lead Wire / Fil de Sortie /  
Alambre Líder (in/cm): 7.09 / 18.00



**234-9114**

Lead Wire / Fil de Sortie /  
Alambre Líder (in/cm): 12.40 / 31.50



**234-9112**

Lead Wire / Fil de Sortie /  
Alambre Líder (in/cm): 14.76 / 37.50



**234-9115**

Lead Wire / Fil de Sortie /  
Alambre Líder (in/cm): 16.34 / 41.50





**234-9116**

Lead Wire / Fil de Sortie /  
Alambre Lider (in/cm): 10.83 / 27.50



**234-9119**

Lead Wire / Fil de Sortie /  
Alambre Lider (in/cm): 10.83 / 27.50



**234-9117**

Lead Wire / Fil de Sortie /  
Alambre Lider (in/cm): 10.91 / 27.70



**234-9120**

Lead Wire / Fil de Sortie /  
Alambre Lider (in/cm): 30.71 / 78.00



**234-9118**

Lead Wire / Fil de Sortie /  
Alambre Lider (in/cm): 13.82 / 35.10



**234-9121**

Lead Wire / Fil de Sortie /  
Alambre Lider (in/cm): 37.80 / 96.00





**234-9122**

Lead Wire / Fil de Sortie /  
Alambre Líder (in/cm): 21.85 / 55.50



**234-9125**

Lead Wire / Fil de Sortie /  
Alambre Líder (in/cm): 11.89 / 30.20



**234-9123**

Lead Wire / Fil de Sortie /  
Alambre Líder (in/cm): 19.69 / 50.00



**234-9126**

Lead Wire / Fil de Sortie /  
Alambre Líder (in/cm): 11.38 / 28.90



**234-9124**

Lead Wire / Fil de Sortie /  
Alambre Líder (in/cm): 10.43 / 26.50



**234-9127**

Lead Wire / Fil de Sortie /  
Alambre Líder (in/cm): 10.51 / 26.7





**234-9128**

Lead Wire / Fil de Sortie /  
Alambre Lider (in/cm): 16.34 / 41.5



**234-9131**

Lead Wire / Fil de Sortie /  
Alambre Lider (in/cm): 8.27 / 21.00



**234-9129**

Lead Wire / Fil de Sortie /  
Alambre Lider (in/cm): 13.78 / 35



**234-9132**

Lead Wire / Fil de Sortie /  
Alambre Lider (in/cm): 19.09 / 48.50



**234-9130**

Lead Wire / Fil de Sortie /  
Alambre Lider (in/cm): 14.17 / 36



**234-9133**

Lead Wire / Fil de Sortie /  
Alambre Lider (in/cm): 10.67 / 27.10





**234-9134**

Lead Wire / Fil de Sortie /  
Alambre Líder (in/cm): 10.35 / 26.30



**234-9137**

Lead Wire / Fil de Sortie /  
Alambre Líder (in/cm): 18.19 / 46.20



**234-9135**

Lead Wire / Fil de Sortie /  
Alambre Líder (in/cm): 18.23 / 46.30



**234-9138**

Lead Wire / Fil de Sortie /  
Alambre Líder (in/cm): 12.91 / 32.80



**234-9136**

Lead Wire / Fil de Sortie /  
Alambre Líder (in/cm): 16.34 / 41.50



**234-9139**

Lead Wire / Fil de Sortie /  
Alambre Líder (in/cm): 8.58 / 21.80





**234-9140**

Lead Wire / Fil de Sortie /  
Alambre Líder (in/cm): 9.06 / 23.00



**234-9143**

Lead Wire / Fil de Sortie /  
Alambre Líder (in/cm): 11.02 / 28.00



**234-9141**

Lead Wire / Fil de Sortie /  
Alambre Líder (in/cm): 19.06 / 48.40



**234-9144**

Lead Wire / Fil de Sortie /  
Alambre Líder (in/cm): 24.09 / 61.20



**234-9142**

Lead Wire / Fil de Sortie /  
Alambre Líder (in/cm): 15.04 / 38.20



**234-9145**

Lead Wire / Fil de Sortie /  
Alambre Líder (in/cm): 16.54 / 42.00







**234-9146**

Lead Wire / Fil de Sortie /  
Alambre Líder (in/cm): 13.46 / 34.20



**234-9149**

Lead Wire / Fil de Sortie /  
Alambre Líder (in/cm): 11.02 / 28.00



**234-9147**

Lead Wire / Fil de Sortie /  
Alambre Líder (in/cm): 20.24 / 51.40



**234-9150**

Lead Wire / Fil de Sortie /  
Alambre Líder (in/cm): 27.20 / 69.10



**234-9148**

Lead Wire / Fil de Sortie /  
Alambre Líder (in/cm): 15.04 / 38.20



**234-9151**

Lead Wire / Fil de Sortie /  
Alambre Líder (in/cm): 18.50 / 47.00





**234-9152**

Lead Wire / Fil de Sortie /  
Alambre Lider (in/cm): 30.04 / 76.30



**234-9155**

Lead Wire / Fil de Sortie /  
Alambre Lider (in/cm): 13.46 / 34.20



**234-9153**

Lead Wire / Fil de Sortie /  
Alambre Lider (in/cm): 24.09 / 61.20



**234-9156**

Lead Wire / Fil de Sortie /  
Alambre Lider (in/cm): 20.24 / 51.40



**234-9154**

Lead Wire / Fil de Sortie /  
Alambre Lider (in/cm): 16.54 / 42.00



**234-9299**

Lead Wire / Fil de Sortie /  
Alambre Lider (in/cm): 10.75 / 27.30





#PART PIECE PARTE	MFR/ MARQUE FABRICANTE	MODEL MODELE MODELO	A
<b>234-1000</b>			
1986-1991	ACURA	INTEGRA	
1986-1990	ACURA	LEGEND	
1982-1985	ALFA ROMEO	SPIDER	
1981-1982	ALFA ROMEO	GTV-6	
1995-1996	AM GENERAL	HUMMER	
1981-1988	AMC	EAGLE	
1981-1983	AMC	CONCORD	
1981-1983	AMC	SPIRIT	
1993	ASUNA	GT	
1993	ASUNA	SE	
1984-1987	AUDI	4000 QUATTRO	
1981-1987	AUDI	COUPE	
1979-1987	AUDI	5000	
1983-1986	AUDI	QUATTRO	
1980-1986	AUDI	4000	
1982-1987	BMW	528E	
1984-1985	BMW	318I	
1983-1984	BMW	533I	
1980-1984	BMW	633CSI	
1979-1984	BMW	733I	
1979-1983	BMW	320I	
1979-1981	BMW	528I	
1982-1998	BUICK	SKYLARK	
1982-1996	BUICK	CENTURY	
1991-1993	BUICK	PARK AVENUE	
1991-1993	BUICK	ROADMASTER	
1982-1993	BUICK	LESABRE	
1982-1993	BUICK	REGAL	
1982-1993	BUICK	RIVIERA	
1988-1991	BUICK	REATA	
1982-1990	BUICK	ELECTRA	
1982-1989	BUICK	SKYHAWK	
1986-1987	BUICK	SOMERSET	
1985	BUICK	SOMERSET REGAL	
1982-1983	BUICK	ESTATE WAGON	
1993	CADILLAC	FLEETWOOD	
1987-1992	CADILLAC	BROUGHAM	
1982-1988	CADILLAC	CIMARRON	
1985-1987	CADILLAC	DEVILLE	
1985-1987	CADILLAC	FLEETWOOD	
1985-1987	CADILLAC	SEVILLE	
1985-1986	CADILLAC	ELDORADO	
1982	CADILLAC	DEVILLE	
1982	CADILLAC	ELDORADO	
1982	CADILLAC	FLEETWOOD	
1982	CADILLAC	SEVILLE	
1979-1980	CADILLAC	ELDORADO	
1979-1980	CADILLAC	SEVILLE	
1982-2000	CHEVROLET	S10	
1997-1999	CHEVROLET	MALIBU	
1982-1999	CHEVROLET	CAVALIER	

#PART PIECE PARTE	MFR/ MARQUE FABRICANTE	MODEL MODELE MODELO	A
<b>234-1000 (CONT.)</b>			
1987-1996	CHEVROLET	BERETTA	
1987-1996	CHEVROLET	CORSICA	
1992-1995	CHEVROLET	C1500 SUBURBAN	
1992-1995	CHEVROLET	C2500 SUBURBAN	
1992-1995	CHEVROLET	K1500 SUBURBAN	
1992-1995	CHEVROLET	K2500 SUBURBAN	
1990-1995	CHEVROLET	LUMINA APV	
1988-1995	CHEVROLET	C1500 TRUCK	
1988-1995	CHEVROLET	C2500 TRUCK	
1988-1995	CHEVROLET	C3500 TRUCK	
1988-1995	CHEVROLET	K1500 TRUCK	
1988-1995	CHEVROLET	K2500 TRUCK	
1988-1995	CHEVROLET	K3500 TRUCK	
1987-1995	CHEVROLET	LLV	
1983-1995	CHEVROLET	P30 VAN	
1980-1995	CHEVROLET	CAMARO	
1980-1995	CHEVROLET	G10 VAN	
1980-1995	CHEVROLET	G20 VAN	
1980-1995	CHEVROLET	G30 VAN	
1995	CHEVROLET	TAHOE	
1990-1994	CHEVROLET	LUMINA	
1983-1994	CHEVROLET	BLAZER	
1984-1993	CHEVROLET	CORVETTE	
1980-1993	CHEVROLET	CAPRICE	
1985-1992	CHEVROLET	SPRINT	
1992	CHEVROLET	METRO	
1989-1991	CHEVROLET	R1500 SUBURBAN	
1989-1991	CHEVROLET	R2500 SUBURBAN	
1989-1991	CHEVROLET	R3500 TRUCK	
1989-1991	CHEVROLET	V1500 SUBURBAN	
1989-1991	CHEVROLET	V2500 SUBURBAN	
1989-1991	CHEVROLET	V3500 TRUCK	
1985-1991	CHEVROLET	ASTRO	
1983-1991	CHEVROLET	S10 BLAZER	
1989-1990	CHEVROLET	TRACKER	
1982-1990	CHEVROLET	CELEBRITY	
1983-1989	CHEVROLET	P20 VAN	
1989	CHEVROLET	R2500 TRUCK	
1987-1988	CHEVROLET	R10 SUBURBAN	
1987-1988	CHEVROLET	R20 SUBURBAN	
1987-1988	CHEVROLET	R20 TRUCK	
1987-1988	CHEVROLET	R30 TRUCK	
1987-1988	CHEVROLET	V10 SUBURBAN	
1987-1988	CHEVROLET	V20 SUBURBAN	
1987-1988	CHEVROLET	V30 TRUCK	
1985-1988	CHEVROLET	SPECTRUM	
1980-1988	CHEVROLET	MONTE CARLO	
1980-1987	CHEVROLET	CHEVETTE	
1980-1987	CHEVROLET	EL CAMINO	
1987	CHEVROLET	R10 TRUCK	
1987	CHEVROLET	V10 TRUCK	

#PART PIECE PARTE	MFR/ MARQUE FABRICANTE	MODEL MODELE MODELO	A
<b>234-1000 (CONT.)</b>			
1987	CHEVROLET	V20 TRUCK	
1983-1986	CHEVROLET	C10 SUBURBAN	
1983-1986	CHEVROLET	C10 TRUCK	
1983-1986	CHEVROLET	C20 SUBURBAN	
1983-1986	CHEVROLET	C20 TRUCK	
1983-1986	CHEVROLET	C30 TRUCK	
1983-1986	CHEVROLET	K10 SUBURBAN	
1983-1986	CHEVROLET	K10 TRUCK	
1983-1986	CHEVROLET	K20 SUBURBAN	
1983-1986	CHEVROLET	K20 TRUCK	
1983-1986	CHEVROLET	K30 TRUCK	
1984-1985	CHEVROLET	CITATION II	
1980-1985	CHEVROLET	IMPALA	
1980-1983	CHEVROLET	CITATION	
1980-1983	CHEVROLET	MALIBU	
1980-1982	CHEVROLET	LUV	
1982	CHEVROLET	CORVETTE	
1981	CHEVROLET	BEL AIR	
1980	CHEVROLET	MONZA	
1983-1989	CHRYSLER	FIFTH AVENUE	
1985-1986	CHRYSLER	EXECUTIVE	
1984-1986	CHRYSLER	DAYTONA	
1984-1986	CHRYSLER	LASER	
1980-1986	CHRYSLER	NEW YORKER	
1980-1986	CHRYSLER	TOWN & COUNTRY	
1979-1986	CHRYSLER	LEBARON	
1983-1984	CHRYSLER	E CLASS	
1983-1984	CHRYSLER	EXECUTIVE SEDAN	
1981-1983	CHRYSLER	IMPERIAL	
1980-1983	CHRYSLER	CORDOBA	
1979-1981	CHRYSLER	NEWPORT	
1990-1992	DAIHATSU	ROCKY	
1988-1992	DAIHATSU	CHARADE	
1981-1983	DELOREAN	DMC 12	
1980-1991	DODGE	COLT	
1989-1990	DODGE	2000 GTX	
1983-1990	DODGE	RAM 50	
1987-1989	DODGE	RAIDER	
1979-1989	DODGE	DIPLOMAT	
1986-1987	DODGE	W100 PICKUP	
1984-1987	DODGE	CARAVAN	
1984-1987	DODGE	D100 PICKUP	
1984-1987	DODGE	MINI RAM	
1984-1987	DODGE	ROYAL MINI RAM	
1983-1987	DODGE	CHARGER	
1981-1987	DODGE	B150 VAN	
1981-1987	DODGE	B250 VAN	
1981-1987	DODGE	B350 VAN	
1981-1987	DODGE	D250 PICKUP	
1981-1987	DODGE	D350 PICKUP	
1981-1987	DODGE	W250 PICKUP	

# NUMERICAL LISTING



#PART PIECE PARTE	MFR / MARQUE FABRICANTE	MODEL MODELE MODELO	A
<b>234-1000 (CONT.)</b>			
1981-1987	DODGE	W350 PICKUP	
1980-1987	DODGE	OMNI	
1979-1987	DODGE	D150 PICKUP	
1979-1987	DODGE	RAMCHARGER	
1979-1987	DODGE	W150 PICKUP	
1987	DODGE	DAKOTA	
1985-1986	DODGE	LANCER	
1984-1986	DODGE	DAYTONA	
1983-1986	DODGE	600	
1983-1986	DODGE	POWER RAM 50	
1981-1986	DODGE	ARIES	
1982-1984	DODGE	RAMPAGE	
1982-1983	DODGE	400	
1980-1983	DODGE	CHALLENGER	
1980-1983	DODGE	MIRADA	
1980-1982	DODGE	D50	
1980-1981	DODGE	D400 PICKUP	
1980-1981	DODGE	D450 PICKUP	
1979-1981	DODGE	ST. REGIS	
1979-1980	DODGE	ASPEN	
1979-1980	DODGE	B100 VAN	
1979-1980	DODGE	B200 VAN	
1979-1980	DODGE	B300 VAN	
1979-1980	DODGE	CB300	
1979-1980	DODGE	D200 PICKUP	
1979-1980	DODGE	W200 PICKUP	
1980	DODGE	D300 PICKUP	
1980	DODGE	RD200	
1980	DODGE	W300 PICKUP	
1979	DODGE	D100 PICKUP	
1991-1992	EAGLE	2000 GTX	
1988-1991	EAGLE	VISTA	
1989-1990	EAGLE	SUMMIT	
1988-1989	EAGLE	MEDALLION	
1994-1997	FORD	ASPIRE	
1991-1994	FORD	ESCORT	
1988-1993	FORD	FESTIVA	
1989-1992	FORD	PROBE	
1980-1987	FORD	BRONCO	
1980-1987	FORD	E-150 VAN	
1980-1987	FORD	E-250 VAN	
1980-1987	FORD	E-350 VAN	
1979-1987	FORD	THUNDERBIRD	
1987	FORD	LTD CROWN VICTORIA	
1984-1986	FORD	TEMPO	
1980-1986	FORD	F-150	
1980-1986	FORD	F-250	
1980-1986	FORD	F-350	
1979-1986	FORD	LTD	
1979-1986	FORD	MUSTANG	
1986	FORD	AEROSTAR	

#PART PIECE PARTE	MFR / MARQUE FABRICANTE	MODEL MODELE MODELO	A
<b>234-1000 (CONT.)</b>			
1986	FORD	TAURUS	
1984-1985	FORD	BRONCO II	
1983-1985	FORD	ESCORT	
1983-1985	FORD	EXP	
1983-1985	FORD	RANGER	
1980-1983	FORD	E-100 VAN	
1980-1983	FORD	F-100	
1979-1983	FORD	FAIRMONT	
1980-1982	FORD	GRANADA	
1979-1982	FORD	COURIER	
1979-1980	FORD	PINTO	
1979	FORD	LTD II	
1979	FORD	RANCHERO	
1989-1994	GEO	METRO	
1990-1993	GEO	STORM	
1989-1990	GEO	TRACKER	
1989	GEO	SPECTRUM	
1991-2000	GMC	SONOMA	
1992-1995	GMC	C15/C1500	
1992-1995	GMC	C25/C2500	
1992-1995	GMC	K15/K1500	
1992-1995	GMC	K25/K2500	
1992-1995	GMC	YUKON	
1988-1995	GMC	C15/C1500 PICKUP	
1988-1995	GMC	C25/C2500 PICKUP	
1988-1995	GMC	C35/C3500 PICKUP	
1988-1995	GMC	K15/K1500 TRUCK	
1988-1995	GMC	K25/K2500 TRUCK	
1988-1995	GMC	K35/K3500 TRUCK	
1983-1995	GMC	P35/P3500 VAN	
1980-1995	GMC	G15/G1500 VAN	
1980-1995	GMC	G25/G2500 VAN	
1980-1995	GMC	G35/G3500 VAN	
1987-1991	GMC	R1500 SUBURBAN	
1987-1991	GMC	R2500 SUBURBAN	
1987-1991	GMC	R3500 TRUCK	
1987-1991	GMC	V1500 SUBURBAN	
1987-1991	GMC	V2500 SUBURBAN	
1987-1991	GMC	V3500 TRUCK	
1985-1991	GMC	SAFARI	
1983-1991	GMC	JIMMY	
1983-1991	GMC	S15 JIMMY	
1989-1990	GMC	TRACKER	
1982-1990	GMC	S15	
1987-1989	GMC	R2500 TRUCK	
1983-1989	GMC	P25/P2500 VAN	
1979-1987	GMC	CABALLERO	
1987	GMC	R1500 TRUCK	
1987	GMC	V1500 TRUCK	
1987	GMC	V2500 TRUCK	
1983-1986	GMC	C15/C1500 PICKUP	

#PART PIECE PARTE	MFR / MARQUE FABRICANTE	MODEL MODELE MODELO	A
<b>234-1000 (CONT.)</b>			
1983-1986	GMC	C15/C1500	
1983-1986	GMC	C25/C2500 PICKUP	
1983-1986	GMC	C25/C2500	
1983-1986	GMC	C35/C3500 PICKUP	
1983-1986	GMC	K15/K1500	
1983-1986	GMC	K15/K1500 TRUCK	
1983-1986	GMC	K25/K2500	
1983-1986	GMC	K25/K2500 TRUCK	
1983-1986	GMC	K35/K3500 TRUCK	
1983-1995	HONDA	CIVIC	
1988-1991	HONDA	CRX	
1984-1991	HONDA	PRELUDE	
1984-1989	HONDA	ACCORD	
1986-1987	HONDA	WAGOVAN	
1984	HONDA	WAGOVAN	
1991-1995	HYUNDAI	SCOUPE	
1986-1993	HYUNDAI	EXCEL	
1989-1990	HYUNDAI	SONATA	
1996-2000	ISUZU	HOMBRE	
1981-1994	ISUZU	PICKUP	
1991-1993	ISUZU	RODEO	
1991-1993	ISUZU	STYLUS	
1989-1993	ISUZU	AMIGO	
1984-1991	ISUZU	TROOPER	
1983-1989	ISUZU	IMPULSE	
1981-1989	ISUZU	I-MARK	
1982-1987	JAGUAR	VANDEN PLAS	
1979-1987	JAGUAR	XJ6	
1984-1991	JEEP	GRAND WAGONEER	
1987-1990	JEEP	WRANGLER	
1981-1988	JEEP	J10	
1981-1988	JEEP	J20	
1981-1987	JEEP	WAGONEER	
1981-1986	JEEP	CHEROKEE	
1981-1986	JEEP	CJ7	
1986	JEEP	COMANCHE	
1981-1985	JEEP	SCRAMBLER	
1981-1983	JEEP	CJ5	
1994-1995	KIA	SEPHIA	
1984-1985	LINCOLN	MARK VII	
1982-1985	LINCOLN	CONTINENTAL	
1981-1985	LINCOLN	TOWN CAR	
1980-1983	LINCOLN	MARK VI	
1980	LINCOLN	CONTINENTAL	
1980	LINCOLN	VERSAILLES	
1993-1995	MAZDA	RX-7	
1986-1995	MAZDA	323	
1990-1994	MAZDA	PROTEGE	
1992-1993	MAZDA	MX-3	
1990-1993	MAZDA	MIATA	
1987-1993	MAZDA	B2200	



#PART PIECE PARTE	MFR/ MARQUE FABRICANTE	MODEL MODELE MODELO	A
<b>234-1000 (CONT.)</b>			
1988-1992	MAZDA	MX-6	
1983-1992	MAZDA	626	
1984-1991	MAZDA	RX-7	
1987-1988	MAZDA	B2600	
1986-1987	MAZDA	B2000	
1983-1985	MAZDA	GLC	
1984-1985	MERCEDES-BENZ	380SE	
1984-1985	MERCEDES-BENZ	500SEC	
1984-1985	MERCEDES-BENZ	500SEL	
1981-1985	MERCEDES-BENZ	380SL	
1981-1983	MERCEDES-BENZ	380SEL	
1980-1981	MERCEDES-BENZ	280CE	
1980-1981	MERCEDES-BENZ	280E	
1981	MERCEDES-BENZ	380SLC	
1980	MERCEDES-BENZ	280SE	
1980	MERCEDES-BENZ	450SEL	
1980	MERCEDES-BENZ	450SL	
1991-1994	MERCURY	CAPRI	
1987-1994	MERCURY	TRACER	
1979-1987	MERCURY	COUGAR	
1979-1987	MERCURY	GRAND MARQUIS	
1984-1986	MERCURY	TOPAZ	
1979-1986	MERCURY	CAPRI	
1979-1986	MERCURY	MARQUIS	
1986	MERCURY	SABLE	
1983-1985	MERCURY	LYNX	
1979-1983	MERCURY	ZEPHYR	
1983	MERCURY	LN7	
1979-1980	MERCURY	BOBCAT	
1980	MERCURY	MONARCH	
1985-1989	MERKUR	XR4TI	
1987-1993	MITSUBISHI	PRECIS	
1991-1992	MITSUBISHI	MIRAGE	
1989-1992	MITSUBISHI	GALANT	
1987-1990	MITSUBISHI	VAN	
1984-1990	MITSUBISHI	MIGHTY MAX	
1990	MITSUBISHI	ECLIPSE	
1985-1989	MITSUBISHI	MIRAGE	
1983-1989	MITSUBISHI	MONTERO	
1983-1988	MITSUBISHI	CORDIA	
1983-1988	MITSUBISHI	TREDIA	
1985-1987	MITSUBISHI	GALANT	
1995-1996	NISSAN	200SX	
1995-1996	NISSAN	PICKUP	
1993-1996	NISSAN	ALTIMA	
1982-1996	NISSAN	SENTRA	
1990-1995	NISSAN	AXXESS	
1989-1995	NISSAN	240SX	
1986-1994	NISSAN	D21	
1991-1993	NISSAN	NX	
1984-1992	NISSAN	STANZA	

#PART PIECE PARTE	MFR/ MARQUE FABRICANTE	MODEL MODELE MODELO	A
<b>234-1000 (CONT.)</b>			
1986-1991	NISSAN	MICRA	
1988-1990	NISSAN	PULSAR NX	
1987-1988	NISSAN	PATHFINDER	
1987-1988	NISSAN	VAN	
1986-1988	NISSAN	MULTI	
1980-1988	NISSAN	200SX	
1983-1986	NISSAN	720	
1983-1986	NISSAN	PULSAR NX	
1981-1984	NISSAN	MAXIMA	
1979-1983	NISSAN	280ZX	
1983	NISSAN	PULSAR	
1977-1981	NISSAN	810	
1999	OLDSMOBILE	ALERO	
1992-1998	OLDSMOBILE	ACHIEVA	
1982-1996	OLDSMOBILE	CUTLASS CIERA	
1990-1994	OLDSMOBILE	SILHOUETTE	
1992-1993	OLDSMOBILE	88	
1987-1993	OLDSMOBILE	CUTLASS CRUISER	
1982-1993	OLDSMOBILE	98	
1982-1993	OLDSMOBILE	CUTLASS SUPREME	
1982-1992	OLDSMOBILE	CUSTOM CRUISER	
1982-1992	OLDSMOBILE	TORONADO	
1988-1991	OLDSMOBILE	CUTLASS CALAIS	
1982-1991	OLDSMOBILE	DELTA 88	
1991	OLDSMOBILE	BRAVADA	
1982-1988	OLDSMOBILE	FIRENZA	
1985-1987	OLDSMOBILE	CALAIS	
1985-1987	OLDSMOBILE	CUTLASS	
1985-1987	OLDSMOBILE	CUTLASS SALON	
1982-1984	OLDSMOBILE	CUTLASS CALAIS	
1982-1984	OLDSMOBILE	OMEGA	
1982-1983	OLDSMOBILE	CUTLASS CRUISER	
1980-1991	PLYMOUTH	COLT	
1990	PLYMOUTH	LASER	
1980-1989	PLYMOUTH	GRAN FURY	
1979-1989	PLYMOUTH	CARAVELLE	
1984-1987	PLYMOUTH	VOYAGER	
1983-1987	PLYMOUTH	TURISMO	
1980-1987	PLYMOUTH	HORIZON	
1987	PLYMOUTH	EXPO	
1983-1986	PLYMOUTH	TURISMO 2.2	
1981-1986	PLYMOUTH	RELIANT	
1981-1983	PLYMOUTH	PB150	
1981-1983	PLYMOUTH	PB250	
1981-1983	PLYMOUTH	PB350	
1980-1983	PLYMOUTH	SAPPORO	
1983	PLYMOUTH	SCAMP	
1980-1982	PLYMOUTH	ARROW PICKUP	
1980-1982	PLYMOUTH	CHAMP	
1980-1982	PLYMOUTH	TC3	
1979-1981	PLYMOUTH	TRAILDUSTER	

#PART PIECE PARTE	MFR/ MARQUE FABRICANTE	MODEL MODELE MODELO	A
<b>234-1000 (CONT.)</b>			
1979-1980	PLYMOUTH	PB100	
1979-1980	PLYMOUTH	VOLARE	
1980	PLYMOUTH	ARROW	
1980	PLYMOUTH	PB200	
1980	PLYMOUTH	PB300	
1995-1999	PONTIAC	SUNFIRE	
1985-1999	PONTIAC	GRAND AM	
1990-1995	PONTIAC	TRANS SPORT	
1980-1995	PONTIAC	FIREBIRD	
1986-1994	PONTIAC	SUNBIRD	
1994	PONTIAC	FIREFLY	
1988-1993	PONTIAC	LEMANS	
1980-1993	PONTIAC	BONNEVILLE	
1980-1993	PONTIAC	GRAND PRIX	
1988-1991	PONTIAC	OPTIMA	
1987-1991	PONTIAC	TEMPEST	
1985-1991	PONTIAC	FIREFLY	
1982-1991	PONTIAC	6000	
1987-1989	PONTIAC	SAFARI	
1985-1988	PONTIAC	SUNBURST	
1984-1988	PONTIAC	FIERO	
1981-1987	PONTIAC	T1000	
1980-1987	PONTIAC	ACADIAN	
1980-1986	PONTIAC	PARISIENNE	
1984-1985	PONTIAC	J2000 SUNBIRD	
1980-1984	PONTIAC	PHOENIX	
1982-1983	PONTIAC	J2000	
1980-1983	PONTIAC	GRAND LEMANS	
1980-1981	PONTIAC	CATALINA	
1980-1981	PONTIAC	LAURENTIAN	
1980-1981	PONTIAC	LEMANS	
1980	PONTIAC	GRAND AM	
1980	PONTIAC	SUNBIRD	
1983-1985	PORSCHE	944	
1979-1983	PORSCHE	911	
1980-1982	PORSCHE	924	
1980-1982	PORSCHE	928	
1983-1987	RENAULT	ALLIANCE	
1984-1986	RENAULT	ENCORE	
1981-1986	RENAULT	R18I	
1982-1985	RENAULT	FUEGO	
1980-1983	RENAULT	LECAR	
1981	RENAULT	R18	
1994	SAAB	900	
1979-1987	SAAB	900	
1977-1980	SAAB	99	
1995-2002	SATURN	SC1	
1995-2002	SATURN	SC2	
1995-2002	SATURN	SL	
1995-2002	SATURN	SL1	
1995-2002	SATURN	SL2	



#PART PIECE PARTE	MFR / MARQUE FABRICANTE	MODEL MODELE MODELO	A
<b>234-1000 (CONT.)</b>			<b>A</b>
1995-2001	SATURN	SW2	
1995-1999	SATURN	SW1	
1989-1991	STERLING	827	
1987-1988	STERLING	825	
1987-1995	SUBARU	JUSTY	
1990-1994	SUBARU	LOYALE	
1985-1991	SUBARU	XT	
1985-1989	SUBARU	GL-10	
1985-1989	SUBARU	RX	
1980-1989	SUBARU	DL	
1980-1989	SUBARU	GL	
1981-1987	SUBARU	BRAT	
1980-1987	SUBARU	STANDARD	
1980-1982	SUBARU	GLF	
1985-1995	SUZUKI	SAMURAI	
1989-1994	SUZUKI	SWIFT	
1989-1990	SUZUKI	SIDEKICK	
1985-1988	SUZUKI	FORSA	
1985	SUZUKI	SA310	
1985	SUZUKI	SJ413	
1993-1998	VOLKSWAGEN	GOLF	
1993-1995	VOLKSWAGEN	JETTA	
1979-1989	VOLKSWAGEN	SCIROCCO	
1985-1987	VOLKSWAGEN	CABRIOLET	
1985-1987	VOLKSWAGEN	GOLF	
1987	VOLKSWAGEN	FOX	
1982-1986	VOLKSWAGEN	QUANTUM	
1980-1986	VOLKSWAGEN	JETTA	
1980-1985	VOLKSWAGEN	VANAGON	
1985	VOLKSWAGEN	TRANSPORTER	
1980-1984	VOLKSWAGEN	RABBIT	
1980-1984	VOLKSWAGEN	RABBIT CONVERTIBLE	
1980-1983	VOLKSWAGEN	RABBIT PICKUP	
1979-1980	VOLKSWAGEN	DASHER	
1980	VOLKSWAGEN	SUPER BEETLE	
1979	VOLKSWAGEN	TRANSPORTER	
1977-1985	VOLVO	244	
1977-1985	VOLVO	245	
1983-1984	VOLVO	760	
1977-1984	VOLVO	242	
1984	VOLVO	DL	
1984	VOLVO	GLE	
1977-1982	VOLVO	264	
1978-1981	VOLVO	262	
1977-1981	VOLVO	265	
<b>234-1001</b>			<b>A</b>
1995-1996	AM GENERAL	HUMMER	
1993	ASUNA	GT	
1993	ASUNA	SE	
1982-1998	BUICK	SKYLARK	
1982-1996	BUICK	CENTURY	

#PART PIECE PARTE	MFR / MARQUE FABRICANTE	MODEL MODELE MODELO	A
<b>234-1001 (CONT.)</b>			<b>A</b>
1991-1993	BUICK	PARK AVENUE	
1991-1993	BUICK	ROADMASTER	
1982-1993	BUICK	LESABRE	
1982-1993	BUICK	REGAL	
1982-1993	BUICK	RIVIERA	
1988-1991	BUICK	REATA	
1982-1990	BUICK	ELECTRA	
1982-1989	BUICK	SKYHAWK	
1986-1987	BUICK	SOMERSET	
1985	BUICK	SOMERSET REGAL	
1982-1983	BUICK	ESTATE WAGON	
1993	CADILLAC	FLEETWOOD	
1987-1992	CADILLAC	BROUGHAM	
1982-1988	CADILLAC	CIMARRON	
1985-1987	CADILLAC	DEVILLE	
1985-1987	CADILLAC	FLEETWOOD	
1985-1987	CADILLAC	SEVILLE	
1985-1986	CADILLAC	ELDORADO	
1982	CADILLAC	DEVILLE	
1982	CADILLAC	ELDORADO	
1982	CADILLAC	FLEETWOOD	
1982	CADILLAC	SEVILLE	
1997-1999	CHEVROLET	MALIBU	
1982-1998	CHEVROLET	CAVALIER	
1982-1998	CHEVROLET	S10	
1987-1996	CHEVROLET	BERETTA	
1987-1996	CHEVROLET	CORSICA	
1992-1995	CHEVROLET	C1500 SUBURBAN	
1992-1995	CHEVROLET	C2500 SUBURBAN	
1992-1995	CHEVROLET	K1500 SUBURBAN	
1992-1995	CHEVROLET	K2500 SUBURBAN	
1990-1995	CHEVROLET	LUMINA APV	
1988-1995	CHEVROLET	C1500 TRUCK	
1988-1995	CHEVROLET	C2500 TRUCK	
1988-1995	CHEVROLET	C3500 TRUCK	
1988-1995	CHEVROLET	K1500 TRUCK	
1988-1995	CHEVROLET	K2500 TRUCK	
1988-1995	CHEVROLET	K3500 TRUCK	
1987-1995	CHEVROLET	LLV	
1983-1995	CHEVROLET	P30 VAN	
1980-1995	CHEVROLET	CAMARO	
1980-1995	CHEVROLET	G10 VAN	
1980-1995	CHEVROLET	G20 VAN	
1980-1995	CHEVROLET	G30 VAN	
1995	CHEVROLET	TAHOE	
1990-1994	CHEVROLET	LUMINA	
1983-1994	CHEVROLET	BLAZER	
1984-1993	CHEVROLET	CORVETTE	
1980-1993	CHEVROLET	CAPRICE	
1987-1992	CHEVROLET	SPRINT	
1992	CHEVROLET	METRO	

#PART PIECE PARTE	MFR / MARQUE FABRICANTE	MODEL MODELE MODELO	A
<b>234-1001 (CONT.)</b>			<b>A</b>
1989-1991	CHEVROLET	R1500 SUBURBAN	
1989-1991	CHEVROLET	R2500 SUBURBAN	
1989-1991	CHEVROLET	R3500 TRUCK	
1989-1991	CHEVROLET	V1500 SUBURBAN	
1989-1991	CHEVROLET	V2500 SUBURBAN	
1989-1991	CHEVROLET	V3500 TRUCK	
1985-1991	CHEVROLET	ASTRO	
1983-1991	CHEVROLET	S10 BLAZER	
1982-1990	CHEVROLET	CELEBRITY	
1983-1989	CHEVROLET	P20 VAN	
1989	CHEVROLET	R2500 TRUCK	
1987-1988	CHEVROLET	R10 SUBURBAN	
1987-1988	CHEVROLET	R20 SUBURBAN	
1987-1988	CHEVROLET	R20 TRUCK	
1987-1988	CHEVROLET	R30 TRUCK	
1987-1988	CHEVROLET	V10 SUBURBAN	
1987-1988	CHEVROLET	V20 SUBURBAN	
1987-1988	CHEVROLET	V30 TRUCK	
1985-1988	CHEVROLET	SPECTRUM	
1980-1988	CHEVROLET	MONTE CARLO	
1980-1987	CHEVROLET	CHEVETTE	
1980-1987	CHEVROLET	EL CAMINO	
1987	CHEVROLET	R10 TRUCK	
1987	CHEVROLET	V10 TRUCK	
1987	CHEVROLET	V20 TRUCK	
1983-1986	CHEVROLET	C10 SUBURBAN	
1983-1986	CHEVROLET	C10 TRUCK	
1983-1986	CHEVROLET	C20 SUBURBAN	
1983-1986	CHEVROLET	C20 TRUCK	
1983-1986	CHEVROLET	C30 TRUCK	
1983-1986	CHEVROLET	K10 SUBURBAN	
1983-1986	CHEVROLET	K10 TRUCK	
1983-1986	CHEVROLET	K20 SUBURBAN	
1983-1986	CHEVROLET	K20 TRUCK	
1983-1986	CHEVROLET	K30 TRUCK	
1984-1985	CHEVROLET	CITATION II	
1980-1985	CHEVROLET	IMPALA	
1980-1983	CHEVROLET	CITATION	
1980-1983	CHEVROLET	MALIBU	
1980-1982	CHEVROLET	LUV	
1982	CHEVROLET	CORVETTE	
1981	CHEVROLET	BEL AIR	
1980	CHEVROLET	MONZA	
1989-1994	GEO	METRO	
1990-1993	GEO	STORM	
1989	GEO	SPECTRUM	
1991-1998	GMC	SONOMA	
1992-1995	GMC	C15/C1500	
1992-1995	GMC	C25/C2500	
1992-1995	GMC	K15/K1500	
1992-1995	GMC	K25/K2500	



#PART PIECE PARTE	MFR/ MARQUE FABRICANTE	MODEL MODELE MODELO	A
<b>234-1001 (CONT.)</b>			<b>A</b>
1992-1995	GMC	YUKON	
1988-1995	GMC	C15/C1500 PICKUP	
1988-1995	GMC	C25/C2500 PICKUP	
1988-1995	GMC	C35/C3500 PICKUP	
1988-1995	GMC	K15/K1500 TRUCK	
1988-1995	GMC	K25/K2500 TRUCK	
1988-1995	GMC	K35/K3500 TRUCK	
1983-1995	GMC	P35/P3500 VAN	
1980-1995	GMC	G15/G1500 VAN	
1980-1995	GMC	G25/G2500 VAN	
1980-1995	GMC	G35/G3500 VAN	
1987-1991	GMC	R1500 SUBURBAN	
1987-1991	GMC	R2500 SUBURBAN	
1987-1991	GMC	R3500 TRUCK	
1987-1991	GMC	V1500 SUBURBAN	
1987-1991	GMC	V2500 SUBURBAN	
1987-1991	GMC	V3500 TRUCK	
1985-1991	GMC	SAFARI	
1983-1991	GMC	JIMMY	
1983-1991	GMC	S15 JIMMY	
1982-1990	GMC	S15	
1987-1989	GMC	R2500 TRUCK	
1983-1989	GMC	P25/P2500 VAN	
1979-1987	GMC	CABALLERO	
1987	GMC	R1500 TRUCK	
1987	GMC	V1500 TRUCK	
1987	GMC	V2500 TRUCK	
1983-1986	GMC	C15/C1500 PICKUP	
1983-1986	GMC	C15/C1500	
1983-1986	GMC	C25/C2500 PICKUP	
1983-1986	GMC	C25/C2500	
1983-1986	GMC	C35/C3500 PICKUP	
1983-1986	GMC	K15/K1500	
1983-1986	GMC	K15/K1500 TRUCK	
1983-1986	GMC	K25/K2500	
1983-1986	GMC	K25/K2500 TRUCK	
1983-1986	GMC	K35/K3500 TRUCK	
1996-1998	ISUZU	HOMBRE	
1981-1994	ISUZU	PICKUP	
1991-1993	ISUZU	RODEO	
1991-1993	ISUZU	STYLUS	
1989-1993	ISUZU	AMIGO	
1984-1991	ISUZU	TROOPER	
1983-1989	ISUZU	IMPULSE	
1981-1989	ISUZU	I-MARK	
1987-1991	JEEP	GRAND WAGONEER	
1987-1990	JEEP	WRANGLER	
1987-1988	JEEP	J10	
1987-1988	JEEP	J20	
1984-1987	JEEP	WAGONEER	
1984-1986	JEEP	CHEROKEE	

#PART PIECE PARTE	MFR/ MARQUE FABRICANTE	MODEL MODELE MODELO	A
<b>234-1001 (CONT.)</b>			<b>A</b>
1986	JEEP	COMANCHE	
1992-1998	OLDSMOBILE	ACHIEVA	
1982-1996	OLDSMOBILE	CUTLASS CIERA	
1990-1994	OLDSMOBILE	SILHOUETTE	
1992-1993	OLDSMOBILE	88	
1987-1993	OLDSMOBILE	CUTLASS CRUISER	
1982-1993	OLDSMOBILE	98	
1982-1993	OLDSMOBILE	CUTLASS SUPREME	
1982-1992	OLDSMOBILE	CUSTOM CRUISER	
1982-1992	OLDSMOBILE	TORONADO	
1988-1991	OLDSMOBILE	CUTLASS CALAIS	
1982-1991	OLDSMOBILE	DELTA 88	
1991	OLDSMOBILE	BRAVADA	
1982-1988	OLDSMOBILE	FIRENZA	
1985-1987	OLDSMOBILE	CALAIS	
1985-1987	OLDSMOBILE	CUTLASS	
1985-1987	OLDSMOBILE	CUTLASS SALON	
1982-1984	OLDSMOBILE	CUTLASS CALAIS	
1982-1984	OLDSMOBILE	OMEGA	
1982-1983	OLDSMOBILE	CUTLASS CRUISER	
1985-1999	PONTIAC	GRAND AM	
1995-1998	PONTIAC	SUNFIRE	
1990-1995	PONTIAC	TRANS SPORT	
1980-1995	PONTIAC	FIREBIRD	
1986-1994	PONTIAC	SUNBIRD	
1994	PONTIAC	FIREFLY	
1988-1993	PONTIAC	LEMANS	
1980-1993	PONTIAC	BONNEVILLE	
1980-1993	PONTIAC	GRAND PRIX	
1988-1991	PONTIAC	OPTIMA	
1987-1991	PONTIAC	FIREFLY	
1987-1991	PONTIAC	TEMPEST	
1982-1991	PONTIAC	6000	
1987-1989	PONTIAC	SAFARI	
1985-1988	PONTIAC	SUNBURST	
1984-1988	PONTIAC	FIERO	
1981-1987	PONTIAC	T1000	
1980-1987	PONTIAC	ACADIAN	
1980-1986	PONTIAC	PARISIENNE	
1984-1985	PONTIAC	J2000 SUNBIRD	
1980-1984	PONTIAC	PHOENIX	
1982-1983	PONTIAC	J2000	
1980-1983	PONTIAC	GRAND LEMANS	
1980-1981	PONTIAC	CATALINA	
1980-1981	PONTIAC	LAURENTIAN	
1980-1981	PONTIAC	LEMANS	
1980	PONTIAC	GRAND AM	
1980	PONTIAC	SUNBIRD	
1986-1987	RENAULT	ALLIANCE	
1986	RENAULT	ENCORE	
1989-1994	SUZUKI	SWIFT	

#PART PIECE PARTE	MFR/ MARQUE FABRICANTE	MODEL MODELE MODELO	A
1987-1988	SUZUKI	FORSA	
<b>234-1002</b>			<b>C</b>
1983-1989	CHRYSLER	FIFTH AVENUE	
1984-1986	CHRYSLER	DAYTONA	
1984-1986	CHRYSLER	LASER	
1980-1986	CHRYSLER	NEW YORKER	
1980-1986	CHRYSLER	TOWN & COUNTRY	
1979-1986	CHRYSLER	LEBARON	
1986	CHRYSLER	EXECUTIVE	
1983-1984	CHRYSLER	E CLASS	
1981-1983	CHRYSLER	IMPERIAL	
1980-1983	CHRYSLER	CORDOBA	
1983	CHRYSLER	EXECUTIVE SEDAN	
1979-1981	CHRYSLER	NEWPORT	
1979-1989	DODGE	DIPLOMAT	
1986-1987	DODGE	W100 PICKUP	
1984-1987	DODGE	CARAVAN	
1984-1987	DODGE	D100 PICKUP	
1984-1987	DODGE	MINI RAM	
1984-1987	DODGE	ROYAL MINI RAM	
1983-1987	DODGE	CHARGER	
1981-1987	DODGE	B150 VAN	
1981-1987	DODGE	B250 VAN	
1981-1987	DODGE	B350 VAN	
1981-1987	DODGE	D250 PICKUP	
1981-1987	DODGE	D350 PICKUP	
1981-1987	DODGE	W250 PICKUP	
1981-1987	DODGE	W350 PICKUP	
1980-1987	DODGE	OMNI	
1979-1987	DODGE	D150 PICKUP	
1979-1987	DODGE	RAMCHARGER	
1979-1987	DODGE	W150 PICKUP	
1987	DODGE	DAKOTA	
1985-1986	DODGE	LANCER	
1984-1986	DODGE	DAYTONA	
1983-1986	DODGE	600	
1981-1986	DODGE	ARIES	
1982-1984	DODGE	RAMPAGE	
1982-1983	DODGE	400	
1980-1983	DODGE	CHALLENGER	
1980-1983	DODGE	COLT	
1980-1983	DODGE	MIRADA	
1983	DODGE	POWER RAM 50	
1983	DODGE	RAM 50	
1980-1982	DODGE	D50	
1979-1981	DODGE	ST. REGIS	
1979-1980	DODGE	ASPEN	
1979-1980	DODGE	B100 VAN	
1979-1980	DODGE	B200 VAN	
1979-1980	DODGE	B300 VAN	
1979-1980	DODGE	CB300	



#PART PIECE PARTE	MFR / MARQUE FABRICANTE	MODEL MODELE MODELO	
<b>234-1002 (CONT.)</b>			<b>C</b>
1979-1980	DODGE	D200 PICKUP	
1979-1980	DODGE	W200 PICKUP	
1980	DODGE	D300 PICKUP	
1980	DODGE	RD200	
1980	DODGE	W300 PICKUP	
1979	DODGE	D100 PICKUP	
1980-1989	PLYMOUTH	GRAN FURY	
1979-1989	PLYMOUTH	CARAVELLE	
1984-1987	PLYMOUTH	VOYAGER	
1983-1987	PLYMOUTH	TURISMO	
1980-1987	PLYMOUTH	HORIZON	
1987	PLYMOUTH	EXPO	
1983-1986	PLYMOUTH	TURISMO 2.2	
1981-1986	PLYMOUTH	RELIANT	
1981-1983	PLYMOUTH	PB150	
1981-1983	PLYMOUTH	PB250	
1981-1983	PLYMOUTH	PB350	
1980-1983	PLYMOUTH	COLT	
1980-1983	PLYMOUTH	SAPPORO	
1983	PLYMOUTH	SCAMP	
1980-1982	PLYMOUTH	ARROW PICKUP	
1980-1982	PLYMOUTH	CHAMP	
1980-1982	PLYMOUTH	TC3	
1979-1981	PLYMOUTH	TRAILDUSTER	
1979-1980	PLYMOUTH	PB100	
1979-1980	PLYMOUTH	VOLARE	
1980	PLYMOUTH	ARROW	
1980	PLYMOUTH	PB200	
1980	PLYMOUTH	PB300	
<b>234-1003</b>			<b>D</b>
1981-1988	AMC	EAGLE	
1981-1983	AMC	CONCORD	
1981-1983	AMC	SPIRIT	
1980-1987	FORD	BRONCO	
1979-1987	FORD	THUNDERBIRD	
1987	FORD	LTD CROWN VICTORIA	
1979-1986	FORD	LTD	
1979-1986	FORD	MUSTANG	
1986	FORD	AEROSTAR	
1984-1985	FORD	BRONCO II	
1983-1985	FORD	ESCORT	
1983-1985	FORD	EXP	
1983-1985	FORD	RANGER	
1980-1985	FORD	E-150 VAN	
1980-1985	FORD	E-250 VAN	
1980-1985	FORD	F-150	
1980-1985	FORD	F-250	
1980-1985	FORD	F-350	
1980-1983	FORD	E-100 VAN	
1980-1983	FORD	E-350 VAN	
1980-1983	FORD	F-100	

#PART PIECE PARTE	MFR / MARQUE FABRICANTE	MODEL MODELE MODELO	
<b>234-1003 (CONT.)</b>			<b>D</b>
1979-1983	FORD	FAIRMONT	
1980-1982	FORD	GRANADA	
1979-1982	FORD	COURIER	
1979-1980	FORD	PINTO	
1979	FORD	LTD II	
1979	FORD	RANCHERO	
1984-1986	JEEP	GRAND WAGONEER	
1981-1986	JEEP	CHEROKEE	
1981-1986	JEEP	CJ7	
1981-1986	JEEP	J10	
1981-1986	JEEP	J20	
1981-1986	JEEP	WAGONEER	
1981-1985	JEEP	SCRAMBLER	
1981-1983	JEEP	CJ5	
1984-1985	LINCOLN	MARK VII	
1982-1985	LINCOLN	CONTINENTAL	
1981-1985	LINCOLN	TOWN CAR	
1980-1983	LINCOLN	MARK VI	
1980	LINCOLN	CONTINENTAL	
1980	LINCOLN	VERSAILLES	
1979-1987	MERCURY	COUGAR	
1979-1987	MERCURY	GRAND MARQUIS	
1979-1986	MERCURY	CAPRI	
1979-1986	MERCURY	MARQUIS	
1983-1985	MERCURY	LYNX	
1979-1983	MERCURY	ZEPHYR	
1983	MERCURY	LN7	
1979-1980	MERCURY	BOBCAT	
1980	MERCURY	MONARCH	
1985-1986	MERKUR	XR4TI	
1983-1987	RENAULT	ALLIANCE	
1984-1986	RENAULT	ENCORE	
<b>234-1004</b>			<b>D</b>
1984-1987	FORD	BRONCO	
1984-1987	FORD	E-150 VAN	
1984-1987	FORD	E-250 VAN	
1984-1987	FORD	E-350 VAN	
1984-1986	FORD	F-150	
1984-1986	FORD	F-250	
1984-1986	FORD	F-350	
1984-1986	FORD	TEMPO	
1986	FORD	TAURUS	
1984-1986	MERCURY	TOPAZ	
1986	MERCURY	SABLE	
1985-1989	MERKUR	XR4TI	
<b>234-1005</b>			<b>D</b>
1984-1985	CHRYSLER	LEBARON	
1984-1985	CHRYSLER	NEW YORKER	
1982-1985	CHRYSLER	TOWN & COUNTRY	
1985	CHRYSLER	EXECUTIVE	
1984	CHRYSLER	E CLASS	

#PART PIECE PARTE	MFR / MARQUE FABRICANTE	MODEL MODELE MODELO	
<b>234-1005 (CONT.)</b>			<b>D</b>
1984	CHRYSLER	EXECUTIVE SEDAN	
1989-1990	DODGE	2000 GTX	
1987-1989	DODGE	RAIDER	
1984-1989	DODGE	RAM 50	
1984-1987	DODGE	CARAVAN	
1984-1987	DODGE	COLT	
1984-1987	DODGE	MINI RAM	
1984-1987	DODGE	ROYAL MINI RAM	
1984-1986	DODGE	POWER RAM 50	
1984-1985	DODGE	600	
1984-1985	DODGE	ARIES	
1991-1992	EAGLE	2000 GTX	
1987-1989	HYUNDAI	EXCEL	
1989-1992	MITSUBISHI	GALANT	
1987-1989	MITSUBISHI	PRECIS	
1984-1989	MITSUBISHI	MIGHTY MAX	
1983-1989	MITSUBISHI	MONTERO	
1984-1988	MITSUBISHI	CORDIA	
1984-1988	MITSUBISHI	TREDIA	
1985-1986	MITSUBISHI	MIRAGE	
1984-1987	PLYMOUTH	COLT	
1984-1987	PLYMOUTH	VOYAGER	
1984-1985	PLYMOUTH	CARAVELLE	
1984-1985	PLYMOUTH	RELIANT	
1990-1994	SUBARU	LOYALE	
1988-1991	SUBARU	XT	
1988-1989	SUBARU	DL	
1988-1989	SUBARU	GL	
1988-1989	SUBARU	GL-10	
1988-1989	SUBARU	RX	
1988	SUBARU	JUSTY	
<b>234-1006</b>			<b>C</b>
1988-1991	HONDA	PRELUDE	
<b>234-1007</b>			<b>C</b>
1987-1990	DODGE	COLT	
1989-1990	EAGLE	SUMMIT	
1988-1990	EAGLE	VISTA	
1989-1990	HYUNDAI	SONATA	
1991-1992	MITSUBISHI	MIRAGE	
1987-1990	MITSUBISHI	VAN	
1990	MITSUBISHI	ECLIPSE	
1987-1989	MITSUBISHI	MIRAGE	
1983-1988	MITSUBISHI	CORDIA	
1983-1988	MITSUBISHI	TREDIA	
1985-1987	MITSUBISHI	GALANT	
1987-1990	PLYMOUTH	COLT	
1990	PLYMOUTH	LASER	
<b>234-1008</b>			<b>D</b>
1990-1992	DAIHATSU	ROCKY	
1988-1992	DAIHATSU	CHARADE	
1986-1987	HONDA	WAGOVAN	





#PART PIECE PARTE	MFR/ MARQUE FABRICANTE	MODEL MODELE MODELO	
<b>234-1008 (CONT.)</b>			<b>D</b>
1983-1987	HONDA	CIVIC	
1984	HONDA	WAGOVAN	
<b>234-1009</b>			<b>C</b>
1988-1990	ACURA	INTEGRA	
1986-1990	ACURA	LEGEND	
1989-1990	CHEVROLET	TRACKER	
1985-1986	CHEVROLET	SPRINT	
1989-1990	GEO	TRACKER	
1989-1990	GMC	TRACKER	
1988-1991	HONDA	CIVIC	
1988-1991	HONDA	CRX	
1984-1990	HONDA	PRELUDE	
1984-1989	HONDA	ACCORD	
1985-1986	PONTIAC	FIREFLY	
1989-1991	STERLING	827	
1987-1988	STERLING	825	
1985-1995	SUZUKI	SAMURAI	
1989-1990	SUZUKI	SIDEKICK	
1985-1986	SUZUKI	FORSA	
1985	SUZUKI	SA310	
1985	SUZUKI	SJ413	
<b>234-1010</b>			<b>D</b>
1991-1994	FORD	ESCORT	
1990-1993	FORD	FESTIVA	
1994-1995	KIA	SEPHIA	
1990-1995	MAZDA	323	
1990-1994	MAZDA	PROTEGE	
1992-1993	MAZDA	MX-3	
1990-1994	MERCURY	TRACER	
<b>234-1011</b>			<b>D</b>
1984-1987	AUDI	4000 QUATTRO	
1983-1986	AUDI	QUATTRO	
1982-1985	AUDI	5000	
1981-1983	DELOREAN	DMC 12	
1988-1989	EAGLE	MEDALLION	
1995-1996	NISSAN	PICKUP	
1990-1994	NISSAN	D21	
1990-1991	NISSAN	AXXESS	
1986-1991	NISSAN	MICRA	
1986-1991	NISSAN	STANZA	
1988-1989	NISSAN	PULSAR NX	
1987-1988	NISSAN	SENTRA	
1986-1988	NISSAN	200SX	
1986-1988	NISSAN	MULTI	
1986	NISSAN	D21	
1981-1986	RENAULT	R18I	
1982-1985	RENAULT	FUEGO	
1980-1983	RENAULT	LECAR	
1981	RENAULT	R18	
1994	SAAB	900	
1979-1985	SAAB	900	

#PART PIECE PARTE	MFR/ MARQUE FABRICANTE	MODEL MODELE MODELO	
<b>234-1011 (CONT.)</b>			<b>D</b>
1977-1980	SAAB	99	
1980-1989	SUBARU	GL	
1985-1987	SUBARU	GL-10	
1985-1987	SUBARU	RX	
1985-1987	SUBARU	XT	
1981-1987	SUBARU	BRAT	
1980-1987	SUBARU	DL	
1980-1987	SUBARU	STANDARD	
1987	SUBARU	JUSTY	
1980-1982	SUBARU	GLF	
1985-1987	VOLKSWAGEN	GOLF	
1985-1986	VOLKSWAGEN	JETTA	
1985	VOLKSWAGEN	QUANTUM	
1977-1985	VOLVO	244	
1977-1985	VOLVO	245	
1983-1984	VOLVO	760	
1977-1984	VOLVO	242	
1984	VOLVO	DL	
1984	VOLVO	GLE	
1980-1982	VOLVO	264	
1980-1981	VOLVO	262	
1980-1981	VOLVO	265	
<b>234-1012</b>			<b>C</b>
1987-1988	MAZDA	B2600	
1983-1987	MAZDA	626	
1983-1985	MAZDA	GLC	
<b>234-1013</b>			<b>C</b>
1982-1987	JAGUAR	VANDEN PLAS	
1979-1987	JAGUAR	XJ6	
1995-1996	NISSAN	200SX	
1993-1996	NISSAN	ALTIMA	
1989-1996	NISSAN	SENTRA	
1990-1995	NISSAN	AXXESS	
1989-1995	NISSAN	240SX	
1991-1993	NISSAN	NX	
1992	NISSAN	STANZA	
1989-1990	NISSAN	PULSAR NX	
1986-1989	NISSAN	D21	
1987-1988	NISSAN	PATHFINDER	
1987-1988	NISSAN	VAN	
1984-1988	NISSAN	STANZA	
1983-1986	NISSAN	720	
1983-1986	NISSAN	PULSAR NX	
1982-1986	NISSAN	SENTRA	
1980-1985	NISSAN	200SX	
1981-1984	NISSAN	MAXIMA	
1979-1983	NISSAN	280ZX	
1983	NISSAN	PULSAR	
1977-1981	NISSAN	810	
1984-1985	RENAULT	ENCORE	
1983-1984	RENAULT	ALLIANCE	

#PART PIECE PARTE	MFR/ MARQUE FABRICANTE	MODEL MODELE MODELO	
<b>234-1014</b>			<b>C</b>
1987-1993	MAZDA	B2200	
1986-1987	MAZDA	B2000	
<b>234-1015</b>			<b>C</b>
1982-1987	BMW	528E	
1984-1985	BMW	318I	
1983-1984	BMW	533I	
1980-1984	BMW	633CSI	
1979-1984	BMW	733I	
1979-1983	BMW	320I	
1979-1981	BMW	528I	
1986-1987	SAAB	900	
1978-1979	VOLVO	262	
1977-1979	VOLVO	264	
1977-1979	VOLVO	265	
<b>234-1016</b>			<b>C</b>
1989-1995	SUBARU	JUSTY	
<b>234-1017</b>			<b>D</b>
1991	ACURA	INTEGRA	
1986-1990	ACURA	LEGEND	
1986-1987	ACURA	INTEGRA	
1988-1991	HONDA	PRELUDE	
1986-1989	HONDA	ACCORD	
<b>234-1018</b>			<b>C</b>
1991-1995	HYUNDAI	SCOUPE	
1990-1993	HYUNDAI	EXCEL	
1986-1987	HYUNDAI	EXCEL	
1990-1993	MITSUBISHI	PRECIS	
1987	MITSUBISHI	PRECIS	
<b>234-1019</b>			<b>D</b>
1988-1989	FORD	FESTIVA	
1989	FORD	PROBE	
1988-1989	MAZDA	626	
1988-1989	MAZDA	MX-6	
1986-1989	MAZDA	323	
1984-1988	MAZDA	RX-7	
1983-1985	MAZDA	626	
1991-1994	MERCURY	CAPRI	
1987-1989	MERCURY	TRACER	
<b>234-1020</b>			<b>D</b>
1994-1997	FORD	ASPIRE	
1990-1992	FORD	PROBE	
1995	MAZDA	RX-7	
1990-1992	MAZDA	626	
1990-1992	MAZDA	MX-6	
<b>234-1021</b>			<b>C</b>
1989-1991	DODGE	COLT	
1989-1991	EAGLE	VISTA	
1989-1991	PLYMOUTH	COLT	
<b>234-1022</b>			<b>A</b>
1995-2002	SATURN	SC1	
1995-2002	SATURN	SC2	



#PART PIECE PARTE	MFR / MARQUE FABRICANTE	MODEL MODELE MODELO	
<b>234-1022 (CONT.)</b>			<b>A</b>
1995-2002	SATURN	SL	
1995-2002	SATURN	SL1	
1995-2002	SATURN	SL2	
1995-2001	SATURN	SW2	
1995-1999	SATURN	SW1	
<b>234-1023</b>			<b>D</b>
1999-2000	CHEVROLET	S10	
1999	CHEVROLET	CAVALIER	
1999	CHEVROLET	MALIBU	
1999-2000	GMC	SONOMA	
1999-2000	ISUZU	HOMBRE	
1999	OLDSMOBILE	ALERO	
1999	PONTIAC	GRAND AM	
1999	PONTIAC	SUNFIRE	
<b>234-1024</b>			<b>D</b>
1990-1993	MAZDA	MIATA	
<b>234-1025</b>			<b>D</b>
1979-1980	CADILLAC	ELDORADO	
1979-1980	CADILLAC	SEVILLE	
<b>234-1029</b>			<b>D</b>
1993-1994	SATURN	SC1	
1993-1994	SATURN	SC2	
1993-1994	SATURN	SW1	
1993-1994	SATURN	SW2	
1991-1994	SATURN	SL	
1991-1994	SATURN	SL1	
1991-1994	SATURN	SL2	
1991-1992	SATURN	SC	
<b>234-1030</b>			<b>C</b>
1994	SATURN	SC2	
1994	SATURN	SL2	
1994	SATURN	SW2	
<b>234-1033</b>			<b>C</b>
1990	DODGE	RAM 50	
1990	MITSUBISHI	MIGHTY MAX	
<b>234-1034</b>			<b>C</b>
1992-1995	HONDA	CIVIC	
<b>234-1040</b>			<b>C</b>
1993-1994	MAZDA	RX-7	
1989-1991	MAZDA	RX-7	
<b>234-1051</b>			<b>C</b>
1989-1992	TOYOTA	CRESSIDA	
1987-1991	TOYOTA	CAMRY	
1986-1991	TOYOTA	CELICA	
1987-1990	TOYOTA	TERCEL	
1985-1989	TOYOTA	COROLLA	
1986-1988	TOYOTA	SUPRA	
1979-1984	TOYOTA	PICKUP	
1984	TOYOTA	4RUNNER	
1981-1983	TOYOTA	CELICA	
1981-1982	TOYOTA	COROLLA	

#PART PIECE PARTE	MFR / MARQUE FABRICANTE	MODEL MODELE MODELO	
<b>234-1051 (CONT.)</b>			<b>C</b>
1981-1982	TOYOTA	CORONA	
1980-1982	TOYOTA	TERCEL	
<b>234-1052</b>			<b>C</b>
1987-1989	CHRYSLER	CONQUEST	
1984-1986	DODGE	CONQUEST	
1983-1989	MITSUBISHI	STARION	
1984-1986	PLYMOUTH	CONQUEST	
<b>234-1053</b>			<b>B</b>
1993-1995	GEO	PRIZM	
1992-1994	LEXUS	ES300	
1993-1995	TOYOTA	COROLLA	
1992-1995	TOYOTA	CAMRY	
1992-1995	TOYOTA	CELICA	
<b>234-1055</b>			<b>D</b>
1992-1995	LEXUS	SC300	
1993-1994	LEXUS	GS300	
1993-1995	TOYOTA	SUPRA	
1992-1995	TOYOTA	MR2	
1992-1993	TOYOTA	CAMRY	
<b>234-1056</b>			<b>C</b>
1985-1988	CHEVROLET	NOVA	
1991-1992	TOYOTA	MR2	
1989-1992	TOYOTA	SUPRA	
1983-1989	TOYOTA	COROLLA	
1985-1988	TOYOTA	4RUNNER	
1984-1988	TOYOTA	PICKUP	
1983-1988	TOYOTA	TERCEL	
1981-1988	TOYOTA	CRESSIDA	
1985-1987	TOYOTA	MR2	
1984-1987	TOYOTA	VAN	
1981-1986	TOYOTA	CELICA	
1981-1985	TOYOTA	LAND CRUISER	
1981-1984	TOYOTA	STARLET	
1980	TOYOTA	COROLLA	
<b>234-1057</b>			<b>D</b>
1985-1988	CHEVROLET	NOVA	
1987-1989	CHRYSLER	CONQUEST	
1984-1986	DODGE	CONQUEST	
1993-1995	GEO	PRIZM	
1992-1995	LEXUS	SC300	
1993-1994	LEXUS	GS300	
1992-1994	LEXUS	ES300	
1983-1989	MITSUBISHI	STARION	
1984-1986	PLYMOUTH	CONQUEST	
1993-1995	TOYOTA	COROLLA	
1991-1995	TOYOTA	MR2	
1987-1995	TOYOTA	CAMRY	
1986-1995	TOYOTA	SUPRA	
1979-1995	TOYOTA	CELICA	
1980-1992	TOYOTA	CRESSIDA	
1980-1990	TOYOTA	TERCEL	

#PART PIECE PARTE	MFR / MARQUE FABRICANTE	MODEL MODELE MODELO	
<b>234-1057 (CONT.)</b>			<b>D</b>
1980-1989	TOYOTA	COROLLA	
1984-1988	TOYOTA	4RUNNER	
1979-1988	TOYOTA	PICKUP	
1985-1987	TOYOTA	MR2	
1984-1987	TOYOTA	VAN	
1981-1985	TOYOTA	LAND CRUISER	
1981-1984	TOYOTA	STARLET	
1981-1982	TOYOTA	CORONA	
<b>234-1058</b>			<b>C</b>
1983-1986	TOYOTA	CAMRY	
1986	TOYOTA	CELICA	
<b>234-2000</b>			<b>D</b>
1980-1982	AMC	CONCORD	
1980-1982	AMC	EAGLE	
1980-1982	AMC	SPIRIT	
1980	AMC	AMX	
1980	AMC	PACER	
1982	BUICK	SKYHAWK	
1980-1981	BUICK	ELECTRA	
1980-1981	BUICK	ESTATE WAGON	
1979-1981	BUICK	CENTURY	
1979-1981	BUICK	LESABRE	
1979-1981	BUICK	REGAL	
1979-1981	BUICK	RIVIERA	
1979-1981	BUICK	SKYLARK	
1979-1980	BUICK	SKYHAWK	
1988-1995	CADILLAC	DEVILLE	
1988-1993	CADILLAC	SEVILLE	
1987-1993	CADILLAC	ELDORADO	
1993	CADILLAC	60 SPECIAL	
1987-1992	CADILLAC	ALLANTE	
1986-1992	CADILLAC	FLEETWOOD	
1980-1984	CADILLAC	COMMERCIAL	
1980-1984	CADILLAC	DEVILLE	
1980-1984	CADILLAC	ELDORADO	
1980-1984	CADILLAC	FLEETWOOD	
1980-1984	CADILLAC	SEVILLE	
2000-2003	CHEVROLET	S10	
2000-2002	CHEVROLET	CAVALIER	
1998-2000	CHEVROLET	CAMARO	
1980-1981	CHEVROLET	CAMARO	
1980-1981	CHEVROLET	CAPRICE	
1980-1981	CHEVROLET	CHEVETTE	
1980-1981	CHEVROLET	CITATION	
1980-1981	CHEVROLET	CORVETTE	
1980-1981	CHEVROLET	IMPALA	
1980-1981	CHEVROLET	LUV	
1979-1981	CHEVROLET	EL CAMINO	
1979-1981	CHEVROLET	MALIBU	
1979-1981	CHEVROLET	MONTE CARLO	
1981	CHEVROLET	BEL AIR	



#PART PIECE PARTE	MFR/ MARQUE FABRICANTE	MODEL MODELE MODELO	D
<b>234-2000 (CONT.)</b>			
1979-1980	CHEVROLET	MONZA	
1999-2002	DAEWOO	LANOS	
1999-2002	DAEWOO	LEGANZA	
1999-2002	DAEWOO	NUBIRA	
1989-1994	DODGE	COLT	
1990-1993	DODGE	RAM 50	
1989	DODGE	RAIDER	
1993-1994	EAGLE	TALON	
1989-1994	EAGLE	SUMMIT	
1993	EAGLE	2000 GTX	
1989-1992	EAGLE	VISTA	
1995-1997	GEO	PRIZM	
1990-1992	GEO	PRIZM	
2000-2003	GMC	SONOMA	
1979-1981	GMC	CABALLERO	
1991-1995	HYUNDAI	SCOUPE	
1990-1992	HYUNDAI	EXCEL	
1989-1991	HYUNDAI	SONATA	
1981-1982	JEEP	SCRAMBLER	
1980-1982	JEEP	CJ5	
1980-1982	JEEP	CJ7	
1980	JEEP	CHEROKEE	
1980	JEEP	J10	
1980	JEEP	WAGONEER	
1990-1994	LEXUS	LS400	
1990-1991	LEXUS	ES250	
1989-1994	MAZDA	MPV	
1990-1993	MAZDA	B2200	
1989-1993	MAZDA	B2600	
1990-1995	MITSUBISHI	MIGHTY MAX	
1990-1994	MITSUBISHI	ECLIPSE	
1992-1993	MITSUBISHI	EXPO	
1992-1993	MITSUBISHI	EXPO LRV	
1989-1993	MITSUBISHI	MIRAGE	
1988-1993	MITSUBISHI	GALANT	
1990-1992	MITSUBISHI	PRECIS	
1989-1990	MITSUBISHI	SIGMA	
1989	MITSUBISHI	MONTERO	
2000-2001	OLDSMOBILE	ALERO	
1982	OLDSMOBILE	FIRENZA	
1980-1981	OLDSMOBILE	CUTLASS CRUISER	
1979-1981	OLDSMOBILE	98	
1979-1981	OLDSMOBILE	CUSTOM CRUISER	
1979-1981	OLDSMOBILE	CUTLASS	
1979-1981	OLDSMOBILE	CUTLASS CALAIS	
1979-1981	OLDSMOBILE	CUTLASS SUPREME	
1979-1981	OLDSMOBILE	DELTA 88	
1979-1981	OLDSMOBILE	OMEGA	
1979-1981	OLDSMOBILE	TORONADO	
1979-1980	OLDSMOBILE	CUTLASS SALON	
1979-1980	OLDSMOBILE	STARFIRE	

#PART PIECE PARTE	MFR/ MARQUE FABRICANTE	MODEL MODELE MODELO	D
<b>234-2000 (CONT.)</b>			
1990-1994	PLYMOUTH	LASER	
1989-1994	PLYMOUTH	COLT	
2000-2002	PONTIAC	SUNFIRE	
2000-2001	PONTIAC	GRAND AM	
1998-2000	PONTIAC	FIREBIRD	
1982	PONTIAC	J2000	
1980-1981	PONTIAC	ACADIAN	
1979-1981	PONTIAC	BONNEVILLE	
1979-1981	PONTIAC	CATALINA	
1979-1981	PONTIAC	FIREBIRD	
1979-1981	PONTIAC	GRAND LEMANS	
1979-1981	PONTIAC	GRAND PRIX	
1979-1981	PONTIAC	LAURENTIAN	
1979-1981	PONTIAC	LEMANS	
1979-1981	PONTIAC	PARISIENNE	
1979-1981	PONTIAC	PHOENIX	
1981	PONTIAC	T1000	
1979-1980	PONTIAC	GRAND AM	
1979-1980	PONTIAC	SUNBIRD	
2001	SATURN	L100	
2001	SATURN	L200	
2001	SATURN	LW200	
2000	SATURN	LS	
2000	SATURN	LS1	
2000	SATURN	LW1	
1997-1999	TOYOTA	PASEO	
1997-1999	TOYOTA	TERCEL	
1989-1999	TOYOTA	CELICA	
1996-1997	TOYOTA	RAV4	
1995-1997	TOYOTA	COROLLA	
1988-1996	TOYOTA	CAMRY	
1991-1995	TOYOTA	MR2	
1989-1991	TOYOTA	COROLLA	
<b>234-2001</b>			
			<b>A</b>
1982	BUICK	SKYHAWK	
1980-1981	BUICK	ELECTRA	
1980-1981	BUICK	ESTATE WAGON	
1979-1981	BUICK	CENTURY	
1979-1981	BUICK	LESABRE	
1979-1981	BUICK	REGAL	
1979-1981	BUICK	RIVIERA	
1979-1981	BUICK	SKYLARK	
1979-1980	BUICK	SKYHAWK	
1988-1995	CADILLAC	DEVILLE	
1988-1993	CADILLAC	SEVILLE	
1987-1993	CADILLAC	ELDORADO	
1993	CADILLAC	60 SPECIAL	
1987-1992	CADILLAC	ALLANTE	
1986-1992	CADILLAC	FLEETWOOD	
1980-1984	CADILLAC	COMMERCIAL	
1980-1984	CADILLAC	DEVILLE	

#PART PIECE PARTE	MFR/ MARQUE FABRICANTE	MODEL MODELE MODELO	A
<b>234-2001 (CONT.)</b>			
1980-1984	CADILLAC	ELDORADO	
1980-1984	CADILLAC	FLEETWOOD	
1980-1984	CADILLAC	SEVILLE	
1980-1981	CHEVROLET	CAMARO	
1980-1981	CHEVROLET	CAPRICE	
1980-1981	CHEVROLET	CHEVETTE	
1980-1981	CHEVROLET	CITATION	
1980-1981	CHEVROLET	CORVETTE	
1980-1981	CHEVROLET	IMPALA	
1980-1981	CHEVROLET	LUV	
1979-1981	CHEVROLET	EL CAMINO	
1979-1981	CHEVROLET	MALIBU	
1979-1981	CHEVROLET	MONTE CARLO	
1981	CHEVROLET	BEL AIR	
1979-1980	CHEVROLET	MONZA	
1999-2002	DAEWOO	LANOS	
1999-2002	DAEWOO	LEGANZA	
1999-2002	DAEWOO	NUBIRA	
1979-1981	GMC	CABALLERO	
1982	OLDSMOBILE	FIRENZA	
1980-1981	OLDSMOBILE	CUTLASS CRUISER	
1979-1981	OLDSMOBILE	98	
1979-1981	OLDSMOBILE	CUSTOM CRUISER	
1979-1981	OLDSMOBILE	CUTLASS	
1979-1981	OLDSMOBILE	CUTLASS CALAIS	
1979-1981	OLDSMOBILE	CUTLASS SUPREME	
1979-1981	OLDSMOBILE	DELTA 88	
1979-1981	OLDSMOBILE	OMEGA	
1979-1981	OLDSMOBILE	TORONADO	
1979-1980	OLDSMOBILE	CUTLASS SALON	
1979-1980	OLDSMOBILE	STARFIRE	
1982	PONTIAC	J2000	
1980-1981	PONTIAC	ACADIAN	
1979-1981	PONTIAC	BONNEVILLE	
1979-1981	PONTIAC	CATALINA	
1979-1981	PONTIAC	FIREBIRD	
1979-1981	PONTIAC	GRAND LEMANS	
1979-1981	PONTIAC	GRAND PRIX	
1979-1981	PONTIAC	LAURENTIAN	
1979-1981	PONTIAC	LEMANS	
1979-1981	PONTIAC	PARISIENNE	
1979-1981	PONTIAC	PHOENIX	
1981	PONTIAC	T1000	
1979-1980	PONTIAC	GRAND AM	
1979-1980	PONTIAC	SUNBIRD	
<b>234-2002</b>			
			<b>D</b>
1989-1991	DODGE	COLT	
1993-1994	EAGLE	TALON	
1989-1991	EAGLE	SUMMIT	
1989-1991	EAGLE	VISTA	
1991-1995	HYUNDAI	SCOUPE	



#PART PIECE PARTE	MFR / MARQUE FABRICANTE	MODEL MODELE MODELO	
<b>234-2002 (CONT.)</b>			<b>D</b>
1990-1992	HYUNDAI	EXCEL	
1989-1991	HYUNDAI	SONATA	
1990-1994	MITSUBISHI	ECLIPSE	
1989-1993	MITSUBISHI	GALANT	
1990-1992	MITSUBISHI	PRECIS	
1989-1990	MITSUBISHI	MIRAGE	
1990-1994	PLYMOUTH	LASER	
1989-1991	PLYMOUTH	COLT	
<b>234-2003</b>			<b>A</b>
1995-1997	GEO	PRIZM	
1995-1997	TOYOTA	COROLLA	
1992-1995	TOYOTA	MR2	
<b>234-2004</b>			<b>D</b>
1990-1993	MAZDA	B2200	
1989-1993	MAZDA	B2600	
<b>234-2005</b>			<b>C</b>
1989-1991	TOYOTA	COROLLA	
1988-1989	TOYOTA	CAMRY	
<b>234-2006</b>			<b>C</b>
1989-1994	MAZDA	MPV	
<b>234-2007</b>			<b>C</b>
1980-1982	AMC	CONCORD	
1980-1982	AMC	EAGLE	
1980-1982	AMC	SPIRIT	
1980	AMC	AMX	
1980	AMC	PACER	
1981-1982	JEEP	SCRAMBLER	
1980-1982	JEEP	CJ5	
1980-1982	JEEP	CJ7	
1980	JEEP	CHEROKEE	
1980	JEEP	J10	
1980	JEEP	WAGONEER	
<b>234-2008</b>			<b>C</b>
1996-1997	TOYOTA	CELICA	
1992-1996	TOYOTA	CAMRY	
1992-1993	TOYOTA	CELICA	
<b>234-2009</b>			<b>D</b>
1990-1991	TOYOTA	CAMRY	
1989	TOYOTA	CELICA	
<b>234-2010</b>			<b>D</b>
1997-1999	TOYOTA	PASEO	
1997-1999	TOYOTA	TERCEL	
1994-1999	TOYOTA	CELICA	
1996-1997	TOYOTA	RAV4	
<b>234-2011</b>			<b>C</b>
1993-1994	LEXUS	LS400	
<b>234-2013</b>			<b>B</b>
1998-2000	CHEVROLET	CAMARO	
1998-2000	PONTIAC	FIREBIRD	
<b>234-2014</b>			<b>D</b>
1992-1994	DODGE	COLT	

#PART PIECE PARTE	MFR / MARQUE FABRICANTE	MODEL MODELE MODELO	
<b>234-2014 (CONT.)</b>			<b>D</b>
1992-1994	EAGLE	SUMMIT	
1993	EAGLE	2000 GTX	
1992-1993	MITSUBISHI	EXPO	
1992-1993	MITSUBISHI	EXPO LRV	
1993	MITSUBISHI	GALANT	
1993	MITSUBISHI	MIRAGE	
1992-1994	PLYMOUTH	COLT	
<b>234-2015</b>			<b>D</b>
1990-1992	LEXUS	LS400	
<b>234-2038</b>			<b>C</b>
1997-1999	JAGUAR	XK8	
1998	JAGUAR	VANDEN PLAS	
1998	JAGUAR	XJ8	
1998	JAGUAR	XJR	
<b>234-2050</b>			<b>D</b>
1989-1995	GEO	PRIZM	
1990-1999	TOYOTA	CELICA	
1996-1997	TOYOTA	RAV4	
1996	TOYOTA	CAMRY	
1992-1995	TOYOTA	PASEO	
1991-1995	TOYOTA	PREVIA	
1990-1995	TOYOTA	COROLLA	
1991-1994	TOYOTA	TERCEL	
1988-1989	TOYOTA	VAN	
1988	TOYOTA	VAN WAGON	
<b>234-2051</b>			<b>D</b>
1993-1995	GEO	PRIZM	
1993-1995	TOYOTA	COROLLA	
<b>234-2052</b>			<b>C</b>
1993-1995	GEO	PRIZM	
1994-1995	TOYOTA	CELICA	
1993-1995	TOYOTA	COROLLA	
1992-1995	TOYOTA	PASEO	
1991-1995	TOYOTA	PREVIA	
1991-1994	TOYOTA	TERCEL	
<b>234-2055</b>			<b>D</b>
1990-1992	TOYOTA	COROLLA	
<b>234-2057</b>			<b>D</b>
1989-1992	GEO	PRIZM	
1990-1993	TOYOTA	CELICA	
<b>234-2058</b>			<b>C</b>
1996-1999	TOYOTA	CELICA	
1996-1997	TOYOTA	RAV4	
1996	TOYOTA	CAMRY	
<b>234-2060</b>			<b>B</b>
2000-2003	CHEVROLET	S10	
2000-2002	CHEVROLET	CAVALIER	
2000-2003	GMC	SONOMA	
2000-2001	OLDSMOBILE	ALERO	
2000-2002	PONTIAC	SUNFIRE	
2000-2001	PONTIAC	GRAND AM	

#PART PIECE PARTE	MFR / MARQUE FABRICANTE	MODEL MODELE MODELO	
<b>234-2060 (CONT.)</b>			<b>B</b>
2001	SATURN	L100	
2001	SATURN	L200	
2001	SATURN	LW200	
2000	SATURN	LS	
2000	SATURN	LS1	
2000	SATURN	LW1	
<b>234-2062</b>			<b>C</b>
1989-1990	GEO	PRIZM	
1988-1989	TOYOTA	VAN	
1988	TOYOTA	VAN WAGON	
<b>234-2064</b>			<b>C</b>
1989-1990	MITSUBISHI	SIGMA	
1988	MITSUBISHI	GALANT	
<b>234-2065</b>			<b>C</b>
1989	DODGE	RAIDER	
1989	MITSUBISHI	MONTERO	
<b>234-2066</b>			<b>C</b>
1991-1994	DODGE	COLT	
1991-1994	EAGLE	SUMMIT	
1991-1992	EAGLE	VISTA	
1991-1993	MITSUBISHI	MIRAGE	
1991-1994	PLYMOUTH	COLT	
<b>234-2067</b>			<b>D</b>
1990-1993	DODGE	RAM 50	
1990-1995	MITSUBISHI	MIGHTY MAX	
<b>234-2068</b>			<b>C</b>
1990-1992	GEO	PRIZM	
1991-1992	TOYOTA	MR2	
1990-1991	TOYOTA	CELICA	
<b>234-2069</b>			<b>C</b>
1990-1991	LEXUS	ES250	
1990-1991	TOYOTA	CAMRY	
<b>234-2071</b>			<b>D</b>
1993-1995	GEO	PRIZM	
1993-1995	TOYOTA	COROLLA	
<b>234-3000</b>			<b>D</b>
1986-1994	ALFA ROMEO	SPIDER	
1991-1993	ALFA ROMEO	164	
1987-1989	ALFA ROMEO	MILANO	
1983-1986	ALFA ROMEO	GTV-6	
1992-1993	ASUNA	SUNRUNNER	
1990-1994	AUDI	V8 QUATTRO	
1989-1993	AUDI	100 QUATTRO	
1988-1993	AUDI	90 QUATTRO	
1989-1992	AUDI	100 SERIES	
1988-1992	AUDI	80	
1988-1992	AUDI	80 QUATTRO	
1990-1991	AUDI	COUPE QUATTRO	
1989-1991	AUDI	200	
1989-1991	AUDI	200 QUATTRO	
1988-1991	AUDI	90	



#PART PIECE PARTE	MFR/ MARQUE FABRICANTE	MODEL MODELE MODELO	D
<b>234-3000 (CONT.)</b>			
1986-1988	AUDI	5000	
1986-1988	AUDI	5000 QUATTRO	
1987	AUDI	COUPE	
1988-1991	BMW	M3	
1987-1988	BMW	M6	
1986-1988	BMW	325	
1988	BMW	M5	
1986-1987	BMW	325ES	
1985-1987	BMW	535I	
1985-1987	BMW	635CSI	
1984-1987	BMW	325E	
1987	BMW	L6	
1985	BMW	318I	
1985	BMW	735I	
1993	BUICK	LESABRE	
1993	BUICK	PARK AVENUE	
1993	BUICK	REGAL	
1994-1996	CHEVROLET	G30 VAN	
1994-1995	CHEVROLET	ASTRO	
1994-1995	CHEVROLET	BLAZER	
1994-1995	CHEVROLET	C1500 SUBURBAN	
1994-1995	CHEVROLET	C1500 TRUCK	
1994-1995	CHEVROLET	C2500 SUBURBAN	
1994-1995	CHEVROLET	C2500 TRUCK	
1994-1995	CHEVROLET	C3500 TRUCK	
1994-1995	CHEVROLET	G10 VAN	
1994-1995	CHEVROLET	G20 VAN	
1994-1995	CHEVROLET	K1500 SUBURBAN	
1994-1995	CHEVROLET	K1500 TRUCK	
1994-1995	CHEVROLET	K2500 SUBURBAN	
1994-1995	CHEVROLET	K2500 TRUCK	
1994-1995	CHEVROLET	K3500 TRUCK	
1994-1995	CHEVROLET	S10	
1992-1995	CHEVROLET	CORVETTE	
1995	CHEVROLET	TAHOE	
1994	CHEVROLET	S10 BLAZER	
1993	CHEVROLET	LUMINA APV	
1991	CHEVROLET	TRACKER	
1990	CHRYSLER	TC MASERATI	
1987-1988	CHRYSLER	DAYTONA	
1987-1988	CHRYSLER	LEBARON	
1987-1988	CHRYSLER	NEW YORKER	
1987-1988	CHRYSLER	TOWN & COUNTRY	
1987-1988	DODGE	600	
1987-1988	DODGE	ARIES	
1987-1988	DODGE	CARAVAN	
1987-1988	DODGE	DAKOTA	
1987-1988	DODGE	DAYTONA	
1987-1988	DODGE	GRAND CARAVAN	
1987-1988	DODGE	LANCER	
1987-1988	DODGE	MINI RAM	

#PART PIECE PARTE	MFR/ MARQUE FABRICANTE	MODEL MODELE MODELO	D
<b>234-3000 (CONT.)</b>			
1987-1988	DODGE	SHADOW	
1988	DODGE	B150 VAN	
1988	DODGE	B250 VAN	
1988	DODGE	B350 VAN	
1988	DODGE	D100 PICKUP	
1988	DODGE	D150 PICKUP	
1988	DODGE	D250 PICKUP	
1988	DODGE	DYNASTY	
1988	DODGE	OMNI	
1988	DODGE	RAMCHARGER	
1988	DODGE	W100 PICKUP	
1988	DODGE	W150 PICKUP	
1988	DODGE	W250 PICKUP	
1987	DODGE	CHARGER	
1987	DODGE	ROYAL MINI RAM	
1986	DODGE	OMNI	
1994-1997	FORD	PROBE	
1986-1995	FORD	TAURUS	
1994	FORD	RANGER	
1984-1993	FORD	MUSTANG	
1990-1992	FORD	PROBE	
1987-1992	FORD	F-250	
1987-1992	FORD	F-350	
1986-1992	FORD	E-350 VAN	
1985-1992	FORD	RANGER	
1987-1991	FORD	COUNTRY SQUIRE	
1987-1991	FORD	LTD CROWN VICTORIA	
1987-1991	FORD	TEMPO	
1986-1991	FORD	AEROSTAR	
1986-1991	FORD	E-250 VAN	
1985-1991	FORD	ESCORT	
1987-1990	FORD	BRONCO	
1987-1990	FORD	F-150	
1986-1990	FORD	BRONCO II	
1986-1990	FORD	E-150 VAN	
1986-1990	FORD	THUNDERBIRD	
1986-1988	FORD	EXP	
1986	FORD	LTD	
1984	FORD	THUNDERBIRD	
1991-1995	GEO	TRACKER	
1990-1991	GEO	STORM	
1994-1995	GMC	C15/C1500 PICKUP	
1994-1995	GMC	C15/C1500	
1994-1995	GMC	C25/C2500 PICKUP	
1994-1995	GMC	C25/C2500	
1994-1995	GMC	C35/C3500 PICKUP	
1994-1995	GMC	G15/G1500 VAN	
1994-1995	GMC	G25/G2500 VAN	
1994-1995	GMC	G35/G3500 VAN	
1994-1995	GMC	JIMMY	
1994-1995	GMC	K15/K1500	

#PART PIECE PARTE	MFR/ MARQUE FABRICANTE	MODEL MODELE MODELO	D
<b>234-3000 (CONT.)</b>			
1994-1995	GMC	K15/K1500 TRUCK	
1994-1995	GMC	K25/K2500	
1994-1995	GMC	K25/K2500 TRUCK	
1994-1995	GMC	K35/K3500 TRUCK	
1994-1995	GMC	SAFARI	
1994-1995	GMC	SONOMA	
1994-1995	GMC	YUKON	
1991	GMC	TRACKER	
1990-1992	ISUZU	IMPULSE	
1991	ISUZU	STYLUS	
1980-1993	JAGUAR	XJS	
1993	JAGUAR	VANDEN PLAS	
1993	JAGUAR	XJ6	
1981-1992	JAGUAR	XJ12	
1986-1991	JAGUAR	VANDEN PLAS	
1986-1991	JAGUAR	XJ6	
1987-1990	JEEP	CHEROKEE	
1987-1990	JEEP	WRANGLER	
1986-1990	JEEP	COMANCHE	
1987	JEEP	WAGONEER	
1995-1997	KIA	SEPHIA	
1985-1992	LINCOLN	MARK VII	
1986-1990	LINCOLN	CONTINENTAL	
1986-1990	LINCOLN	TOWN CAR	
1995-2002	MAZDA	MILLENNIA	
1994-1999	MAZDA	626	
1995-1998	MAZDA	PROTEGE	
1994-1997	MAZDA	MX-6	
1994-1996	MAZDA	MX-3	
1994	MAZDA	B2300	
1989-1991	MAZDA	MPV	
1988-1991	MAZDA	929	
1984-1993	MERCEDES-BENZ	190E	
1986-1992	MERCEDES-BENZ	300E	
1986-1991	MERCEDES-BENZ	420SEL	
1986-1991	MERCEDES-BENZ	560SEC	
1986-1991	MERCEDES-BENZ	560SEL	
1988-1989	MERCEDES-BENZ	300CE	
1988-1989	MERCEDES-BENZ	300TE	
1987-1989	MERCEDES-BENZ	260E	
1986-1989	MERCEDES-BENZ	560SL	
1982-1983	MERCEDES-BENZ	380SEC	
1987-1991	MERCURY	COLONY PARK	
1987-1991	MERCURY	TOPAZ	
1986-1991	MERCURY	GRAND MARQUIS	
1991	MERCURY	TRACER	
1986-1990	MERCURY	COUGAR	
1986-1990	MERCURY	SABLE	
1985-1987	MERCURY	LYNX	
1984-1986	MERCURY	CAPRI	
1984	MERCURY	COUGAR	



#PART PIECE PARTE	MFR/ MARQUE FABRICANTE	MODEL MODELE MODELO	D
<b>234-3000 (CONT.)</b>			
1989	MERKUR	SCORPIO	
1994	OLDSMOBILE	BRAVADA	
1993	OLDSMOBILE	88	
1993	OLDSMOBILE	98	
1993	OLDSMOBILE	SILHOUETTE	
1987-1988	PLYMOUTH	CARAVELLE	
1987-1988	PLYMOUTH	GRAND VOYAGER	
1987-1988	PLYMOUTH	RELIANT	
1987-1988	PLYMOUTH	SUNDANCE	
1987-1988	PLYMOUTH	VOYAGER	
1988	PLYMOUTH	EXPO	
1988	PLYMOUTH	HORIZON	
1994-1995	PONTIAC	SUNRUNNER	
1993	PONTIAC	BONNEVILLE	
1993	PONTIAC	TRANS SPORT	
1993-1995	PORSCHE	928	
1992-1995	PORSCHE	968	
1984-1994	PORSCHE	911	
1983-1991	PORSCHE	928	
1983-1991	PORSCHE	944	
1987-1988	PORSCHE	924	
1986-1995	SAAB	900	
1986-1995	SAAB	9000	
1991-1995	SUZUKI	SIDEKICK	
1985-1998	VOLKSWAGEN	GOLF	
1992-1996	VOLKSWAGEN	EUROVAN	
1985-1995	VOLKSWAGEN	JETTA	
1990-1993	VOLKSWAGEN	PASSAT	
1987-1993	VOLKSWAGEN	CABRIOLET	
1987-1993	VOLKSWAGEN	FOX	
1986-1993	VOLKSWAGEN	TRANSPORTER	
1990-1992	VOLKSWAGEN	CORRADO	
1986-1991	VOLKSWAGEN	VANAGON	
1986-1988	VOLKSWAGEN	SCIROCCO	
1994-1995	VOLVO	940	
1993	VOLVO	240	
1985-1988	VOLVO	740	
1988	VOLVO	244	
1988	VOLVO	245	
1985	VOLVO	244	
1985	VOLVO	245	
1985	VOLVO	745	
<b>234-3001</b>			
<b>D</b>			
1985-1986	FORD	ESCORT	
1985-1986	FORD	RANGER	
1984-1986	FORD	MUSTANG	
1986	FORD	AEROSTAR	
1986	FORD	BRONCO II	
1986	FORD	E-150 VAN	
1986	FORD	E-250 VAN	
1986	FORD	EXP	

#PART PIECE PARTE	MFR/ MARQUE FABRICANTE	MODEL MODELE MODELO	D
<b>234-3001 (CONT.)</b>			
1986	FORD	LTD	
1986	FORD	TAURUS	
1986	FORD	THUNDERBIRD	
1984	FORD	THUNDERBIRD	
1985-1987	LINCOLN	MARK VII	
1986	LINCOLN	CONTINENTAL	
1986	LINCOLN	TOWN CAR	
1985-1986	MERCURY	LYNX	
1984-1986	MERCURY	CAPRI	
1986	MERCURY	COUGAR	
1986	MERCURY	GRAND MARQUIS	
1986	MERCURY	SABLE	
1984	MERCURY	COUGAR	
1989	MERKUR	SCORPIO	
<b>234-3002</b>			
<b>C</b>			
1987-1995	FORD	TAURUS	
1994	FORD	RANGER	
1987-1993	FORD	MUSTANG	
1990-1992	FORD	PROBE	
1987-1992	FORD	RANGER	
1987-1991	FORD	COUNTRY SQUIRE	
1987-1991	FORD	ESCORT	
1987-1991	FORD	LTD CROWN VICTORIA	
1986-1991	FORD	AEROSTAR	
1987-1990	FORD	BRONCO II	
1987-1990	FORD	F-150	
1987-1990	FORD	F-250	
1987-1990	FORD	THUNDERBIRD	
1986-1990	FORD	E-150 VAN	
1986-1990	FORD	E-250 VAN	
1990	FORD	BRONCO	
1987-1989	FORD	F-350	
1986-1989	FORD	E-350 VAN	
1987-1988	FORD	BRONCO	
1987-1988	FORD	EXP	
1987-1992	LINCOLN	MARK VII	
1987-1990	LINCOLN	CONTINENTAL	
1987-1990	LINCOLN	TOWN CAR	
1994	MAZDA	B2300	
1987-1991	MERCURY	COLONY PARK	
1987-1991	MERCURY	GRAND MARQUIS	
1991	MERCURY	TRACER	
1987-1990	MERCURY	COUGAR	
1987-1990	MERCURY	SABLE	
1987	MERCURY	LYNX	
<b>234-3003</b>			
<b>D</b>			
1990	CHRYSLER	TC MASERATI	
1987-1988	CHRYSLER	DAYTONA	
1987-1988	CHRYSLER	LEBARON	
1987-1988	CHRYSLER	NEW YORKER	
1987-1988	CHRYSLER	TOWN & COUNTRY	

#PART PIECE PARTE	MFR/ MARQUE FABRICANTE	MODEL MODELE MODELO	D
<b>234-3003 (CONT.)</b>			
1987-1988	DODGE	600	
1987-1988	DODGE	ARIES	
1987-1988	DODGE	CARAVAN	
1987-1988	DODGE	DAKOTA	
1987-1988	DODGE	DAYTONA	
1987-1988	DODGE	GRAND CARAVAN	
1987-1988	DODGE	LANCER	
1987-1988	DODGE	MINI RAM	
1987-1988	DODGE	SHADOW	
1988	DODGE	B150 VAN	
1988	DODGE	B250 VAN	
1988	DODGE	B350 VAN	
1988	DODGE	D100 PICKUP	
1988	DODGE	D150 PICKUP	
1988	DODGE	D250 PICKUP	
1988	DODGE	DYNASTY	
1988	DODGE	OMNI	
1988	DODGE	RAMCHARGER	
1988	DODGE	W100 PICKUP	
1988	DODGE	W150 PICKUP	
1988	DODGE	W250 PICKUP	
1987	DODGE	CHARGER	
1987	DODGE	ROYAL MINI RAM	
1986	DODGE	OMNI	
1987-1988	PLYMOUTH	CARAVELLE	
1987-1988	PLYMOUTH	GRAND VOYAGER	
1987-1988	PLYMOUTH	RELIANT	
1987-1988	PLYMOUTH	SUNDANCE	
1987-1988	PLYMOUTH	VOYAGER	
1988	PLYMOUTH	EXPO	
1988	PLYMOUTH	HORIZON	
<b>234-3004</b>			
<b>C</b>			
1992-1993	ASUNA	SUNRUNNER	
1991	CHEVROLET	TRACKER	
1991-1994	GEO	TRACKER	
1991	GMC	TRACKER	
1994	PONTIAC	SUNRUNNER	
<b>234-3005</b>			
<b>B</b>			
1994-1995	CHEVROLET	BLAZER	
1994-1995	CHEVROLET	S10	
1992-1995	CHEVROLET	CORVETTE	
1994	CHEVROLET	ASTRO	
1994	CHEVROLET	C1500 SUBURBAN	
1994	CHEVROLET	C1500 TRUCK	
1994	CHEVROLET	C2500 SUBURBAN	
1994	CHEVROLET	C2500 TRUCK	
1994	CHEVROLET	C3500 TRUCK	
1994	CHEVROLET	G10 VAN	
1994	CHEVROLET	G20 VAN	
1994	CHEVROLET	G30 VAN	
1994	CHEVROLET	K1500 SUBURBAN	



#PART PIECE PARTE	MFR/ MARQUE FABRICANTE	MODEL MODELE MODELO
<b>234-3005 (CONT.) B</b>		
1994	CHEVROLET	K1500 TRUCK
1994	CHEVROLET	K2500 SUBURBAN
1994	CHEVROLET	K2500 TRUCK
1994	CHEVROLET	K3500 TRUCK
1994	CHEVROLET	S10 BLAZER
1994-1995	GMC	JIMMY
1994-1995	GMC	SONOMA
1994	GMC	C15/C1500 PICKUP
1994	GMC	C15/C1500
1994	GMC	C25/C2500 PICKUP
1994	GMC	C25/C2500
1994	GMC	C35/C3500 PICKUP
1994	GMC	G15/G1500 VAN
1994	GMC	G25/G2500 VAN
1994	GMC	G35/G3500 VAN
1994	GMC	K15/K1500
1994	GMC	K15/K1500 TRUCK
1994	GMC	K25/K2500
1994	GMC	K25/K2500 TRUCK
1994	GMC	K35/K3500 TRUCK
1994	GMC	SAFARI
1994	GMC	YUKON
1987-1990	JEEP	CHEROKEE
1987-1990	JEEP	WRANGLER
1986-1990	JEEP	COMANCHE
1987	JEEP	WAGONEER
1994	OLDSMOBILE	BRAVADA
<b>234-3006 D</b>		
2004	NISSAN	FRONTIER
2004	NISSAN	XTERRA
<b>234-3007 D</b>		
1989-1992	FORD	RANGER
1987-1992	FORD	F-250
1987-1992	FORD	F-350
1986-1992	FORD	E-350 VAN
1987-1991	FORD	TEMPO
1986-1991	FORD	E-250 VAN
1989-1990	FORD	BRONCO II
1987-1990	FORD	BRONCO
1987-1990	FORD	F-150
1987-1990	FORD	TAURUS
1986-1990	FORD	E-150 VAN
1987-1991	MERCURY	TOPAZ
<b>234-3008 D</b>		
1995-2002	MAZDA	MILLENNIA
<b>234-3009 C</b>		
1995-1996	MAZDA	MILLENNIA
<b>234-3010 C</b>		
1996-1997	MAZDA	626
1996-1997	MAZDA	MX-6

#PART PIECE PARTE	MFR/ MARQUE FABRICANTE	MODEL MODELE MODELO
<b>234-3011 C</b>		
1993	BUICK	LESABRE
1993	BUICK	PARK AVENUE
1993	BUICK	REGAL
1995-1996	CHEVROLET	G30 VAN
1995	CHEVROLET	ASTRO
1995	CHEVROLET	C1500 SUBURBAN
1995	CHEVROLET	C1500 TRUCK
1995	CHEVROLET	C2500 SUBURBAN
1995	CHEVROLET	C2500 TRUCK
1995	CHEVROLET	C3500 TRUCK
1995	CHEVROLET	G10 VAN
1995	CHEVROLET	G20 VAN
1995	CHEVROLET	K1500 SUBURBAN
1995	CHEVROLET	K1500 TRUCK
1995	CHEVROLET	K2500 SUBURBAN
1995	CHEVROLET	K2500 TRUCK
1995	CHEVROLET	K3500 TRUCK
1995	CHEVROLET	TAHOE
1993	CHEVROLET	LUMINA APV
1995	GMC	C15/C1500 PICKUP
1995	GMC	C15/C1500
1995	GMC	C25/C2500 PICKUP
1995	GMC	C25/C2500
1995	GMC	C35/C3500 PICKUP
1995	GMC	G15/G1500 VAN
1995	GMC	G25/G2500 VAN
1995	GMC	G35/G3500 VAN
1995	GMC	K15/K1500
1995	GMC	K15/K1500 TRUCK
1995	GMC	K25/K2500
1995	GMC	K25/K2500 TRUCK
1995	GMC	K35/K3500 TRUCK
1995	GMC	SAFARI
1995	GMC	YUKON
1993	OLDSMOBILE	88
1993	OLDSMOBILE	98
1993	OLDSMOBILE	SILHOUETTE
1993	PONTIAC	BONNEVILLE
1993	PONTIAC	TRANS SPORT
<b>234-3012 C</b>		
1995-2002	MAZDA	MILLENNIA
<b>234-3013 C</b>		
1992-1996	VOLKSWAGEN	EUROVAN
1992-1993	VOLKSWAGEN	TRANSPORTER
1991-1993	VOLKSWAGEN	FOX
1990-1993	VOLKSWAGEN	CABRIOLET
1991-1992	VOLKSWAGEN	CORRADO
1991-1992	VOLKSWAGEN	GOLF
1991-1992	VOLKSWAGEN	JETTA
<b>234-3014 D</b>		
1995	GEO	TRACKER

#PART PIECE PARTE	MFR/ MARQUE FABRICANTE	MODEL MODELE MODELO
<b>234-3014 (CONT.) D</b>		
1990-1991	GEO	STORM
1990-1992	ISUZU	IMPULSE
1991	ISUZU	STYLUS
1995	PONTIAC	SUNRUNNER
1991-1995	SUZUKI	SIDEKICK
<b>234-3015 C</b>		
2004	NISSAN	FRONTIER
2004	NISSAN	XTERRA
<b>234-3016 C</b>		
1986-1988	BMW	325
1986-1987	BMW	325ES
1984-1987	BMW	325E
1985-1986	BMW	535I
1985-1986	BMW	635CSI
1985	BMW	735I
<b>234-3018 C</b>		
1988-1992	VOLKSWAGEN	GOLF
1987-1992	VOLKSWAGEN	JETTA
<b>234-3019 C</b>		
1995-1997	AUDI	S6
1992-1994	AUDI	S4
1990-1991	AUDI	V8 QUATTRO
1985-1987	AUDI	4000
1992-1994	JAGUAR	VANDEN PLAS
1992-1994	JAGUAR	XJ6
1992-1994	JAGUAR	XJS
1994	JAGUAR	XJ12
1993	JAGUAR	XJRS
1986-1988	VOLKSWAGEN	QUANTUM
1991-1993	VOLVO	940
1985-1992	VOLVO	740
1989-1991	VOLVO	780
1984-1990	VOLVO	760
1986-1987	VOLVO	244
1986-1987	VOLVO	245
1985	VOLVO	745
<b>234-3023 C</b>		
1993-1998	VOLKSWAGEN	GOLF
1993-1995	VOLKSWAGEN	JETTA
1991-1993	VOLKSWAGEN	FOX
1991-1993	VOLKSWAGEN	PASSAT
1990-1993	VOLKSWAGEN	CABRIOLET
1990	VOLKSWAGEN	CORRADO
<b>234-3027 C</b>		
1986-1989	ALFA ROMEO	SPIDER
1987	ALFA ROMEO	MILANO
1983-1986	ALFA ROMEO	GTV-6
<b>234-3028 C</b>		
1987-1989	SAAB	9000
1988	SAAB	900
1986-1991	VOLKSWAGEN	TRANSPORTER



#PART PIECE PARTE	MFR / MARQUE FABRICANTE	MODEL MODELE MODELO	
<b>234-3028 (CONT.)</b>			<b>C</b>
1986-1991	VOLKSWAGEN	VANAGON	
1985-1988	VOLVO	740	
1988	VOLVO	244	
1988	VOLVO	245	
1985	VOLVO	244	
1985	VOLVO	245	
1985	VOLVO	745	
<b>234-3029</b>			<b>C</b>
1992-1995	PORSCHE	968	
1986-1991	PORSCHE	944	
1987-1988	PORSCHE	924	
<b>234-3031</b>			<b>C</b>
1993-1995	PORSCHE	928	
1984-1994	PORSCHE	911	
1988-1991	PORSCHE	928	
1986-1990	PORSCHE	944	
<b>234-3032</b>			<b>C</b>
1992-1993	AUDI	100 QUATTRO	
1993	AUDI	90 QUATTRO	
1992	AUDI	100 SERIES	
<b>234-3033</b>			<b>D</b>
1992-1994	VOLVO	960	
1992-1993	VOLVO	940	
1990-1993	VOLVO	240	
1989-1992	VOLVO	740	
1987-1990	VOLVO	760	
1987-1990	VOLVO	780	
1989	VOLVO	244	
1989	VOLVO	245	
<b>234-3034</b>			<b>C</b>
1987-1988	BMW	M6	
1988	BMW	M5	
1987	BMW	535I	
1987	BMW	635CSI	
1987	BMW	L6	
<b>234-3042</b>			<b>C</b>
1994-1995	FORD	PROBE	
1994-1995	MAZDA	626	
1994-1995	MAZDA	MX-6	
<b>234-3048</b>			<b>C</b>
1990-1994	ALFA ROMEO	SPIDER	
1991-1993	ALFA ROMEO	164	
1987-1989	ALFA ROMEO	MILANO	
1990-1994	AUDI	V8 QUATTRO	
1988-1992	AUDI	80	
1988-1992	AUDI	80 QUATTRO	
1988-1992	AUDI	90 QUATTRO	
1990-1991	AUDI	COUPE QUATTRO	
1989-1991	AUDI	100 QUATTRO	
1989-1991	AUDI	100 SERIES	
1989-1991	AUDI	200	

#PART PIECE PARTE	MFR / MARQUE FABRICANTE	MODEL MODELE MODELO	
<b>234-3048 (CONT.)</b>			<b>C</b>
1989-1991	AUDI	200 QUATTRO	
1988-1991	AUDI	90	
1986-1988	AUDI	5000	
1986-1988	AUDI	5000 QUATTRO	
1987	AUDI	COUPE	
1980-1993	JAGUAR	XJS	
1993	JAGUAR	VANDEN PLAS	
1993	JAGUAR	XJ6	
1981-1992	JAGUAR	XJ12	
1986-1991	JAGUAR	VANDEN PLAS	
1986-1991	JAGUAR	XJ6	
1986-1993	SAAB	900	
1986-1991	SAAB	9000	
1985-1992	VOLKSWAGEN	GOLF	
1985-1992	VOLKSWAGEN	JETTA	
1987-1990	VOLKSWAGEN	FOX	
1990	VOLKSWAGEN	PASSAT	
1987-1989	VOLKSWAGEN	CABRIOLET	
1986-1988	VOLKSWAGEN	SCIROCCO	
<b>234-3050</b>			<b>C</b>
1987-1992	TOYOTA	SUPRA	
<b>234-3051</b>			<b>D</b>
1987-1990	TOYOTA	SUPRA	
<b>234-3052</b>			<b>C</b>
1991-1992	TOYOTA	SUPRA	
<b>234-3060</b>			<b>C</b>
1988-1991	BMW	M3	
1985	BMW	318I	
<b>234-3070</b>			<b>C</b>
1993	SAAB	9000	
1994-1995	VOLVO	940	
<b>234-3073</b>			<b>C</b>
1988-1989	MERKUR	SCORPIO	
<b>234-3074</b>			<b>D</b>
1985	CHEVROLET	CAPRICE	
1985	CHEVROLET	EL CAMINO	
1985	CHEVROLET	IMPALA	
1985	CHEVROLET	MONTE CARLO	
1985	GMC	CABALLERO	
1994-1995	HONDA	PASSPORT	
1993-1995	ISUZU	PICKUP	
1993-1995	ISUZU	RODEO	
1993-1994	ISUZU	AMIGO	
1985	PONTIAC	PARISIENNE	
<b>234-3075</b>			<b>A</b>
1994-1998	MERCURY	VILLAGER	
1994-2000	NISSAN	QUEST	
1996-1999	NISSAN	ALTIMA	
1996-1997	NISSAN	PICKUP	
<b>234-3078</b>			<b>C</b>
1994-1995	SAAB	900	

#PART PIECE PARTE	MFR / MARQUE FABRICANTE	MODEL MODELE MODELO	
<b>234-3078 (CONT.)</b>			<b>C</b>
1995	SAAB	9000	
<b>234-3079</b>			<b>C</b>
1994-1995	SAAB	900	
1994-1995	SAAB	9000	
<b>234-3080</b>			<b>C</b>
1994-1995	VOLVO	940	
<b>234-3081</b>			<b>C</b>
1986-1992	MERCEDES-BENZ	300E	
1986-1991	MERCEDES-BENZ	420SEL	
1986-1991	MERCEDES-BENZ	560SEC	
1986-1991	MERCEDES-BENZ	560SEL	
1988-1989	MERCEDES-BENZ	300CE	
1988-1989	MERCEDES-BENZ	300TE	
1987-1989	MERCEDES-BENZ	260E	
1986-1989	MERCEDES-BENZ	560SL	
1982-1983	MERCEDES-BENZ	380SEC	
<b>234-3082</b>			<b>C</b>
1984-1993	MERCEDES-BENZ	190E	
<b>234-3083</b>			<b>D</b>
1992-1997	SUBARU	SVX	
1993-1995	SUBARU	IMPREZA	
1990-1994	SUBARU	LEGACY	
<b>234-3084</b>			<b>D</b>
1996-1997	FORD	PROBE	
1996-1997	MAZDA	626	
1996-1997	MAZDA	MX-6	
<b>234-3085</b>			<b>D</b>
1995-1997	KIA	SEPHIA	
1998-1999	MAZDA	626	
1995-1998	MAZDA	PROTEGE	
1994-1996	MAZDA	MX-3	
<b>234-3086</b>			<b>C</b>
1989-1991	MAZDA	MPV	
1988-1991	MAZDA	929	
<b>234-3087</b>			<b>C</b>
1990-2001	INFINITI	Q45	
1997-2000	INFINITI	QX4	
1993-1995	INFINITI	J30	
1996-2000	NISSAN	PATHFINDER	
1994-1996	NISSAN	300ZX	
<b>234-3088</b>			<b>B</b>
1995-1998	SUBARU	IMPREZA	
1995-1998	SUBARU	LEGACY	
1998	SUBARU	FORESTER	
<b>234-3089</b>			<b>B</b>
1999	INFINITI	G20	
1997-1998	INFINITI	Q45	
1999-2002	MERCURY	VILLAGER	
2000-2003	NISSAN	XTERRA	
1998-2003	NISSAN	FRONTIER	
1999-2002	NISSAN	QUEST	





#PART PIECE PARTE	MFR/ MARQUE FABRICANTE	MODEL MODELE MODELO	
<b>234-3089 (CONT.)</b>			<b>B</b>
1994-1999	NISSAN	SENTRA	
1995-1998	NISSAN	200SX	
<b>234-3090</b>			<b>D</b>
1994	ALFA ROMEO	164	
1995-1998	AUDI	A6	
1995-1998	AUDI	A6 QUATTRO	
1994-1998	AUDI	CABRIOLET	
1996-1997	AUDI	A4	
1996-1997	AUDI	A4 QUATTRO	
1995-1997	AUDI	S6	
1993-1995	AUDI	90	
1993-1995	AUDI	90 QUATTRO	
1993-1994	AUDI	100 QUATTRO	
1993-1994	AUDI	100 SERIES	
1992-1994	AUDI	S4	
1990-1991	AUDI	V8 QUATTRO	
1985-1987	AUDI	4000	
1993	BUICK	REGAL	
1992-1994	CHEVROLET	P30 VAN	
1992-1993	CHEVROLET	ASTRO	
1992-1993	CHEVROLET	BLAZER	
1992-1993	CHEVROLET	C1500 SUBURBAN	
1992-1993	CHEVROLET	C1500 TRUCK	
1992-1993	CHEVROLET	C2500 SUBURBAN	
1992-1993	CHEVROLET	C2500 TRUCK	
1992-1993	CHEVROLET	C3500 TRUCK	
1992-1993	CHEVROLET	CAPRICE	
1992-1993	CHEVROLET	G10 VAN	
1992-1993	CHEVROLET	G20 VAN	
1992-1993	CHEVROLET	G30 VAN	
1992-1993	CHEVROLET	K1500 SUBURBAN	
1992-1993	CHEVROLET	K1500 TRUCK	
1992-1993	CHEVROLET	K2500 SUBURBAN	
1992-1993	CHEVROLET	K2500 TRUCK	
1992-1993	CHEVROLET	K3500 TRUCK	
1992-1993	CHEVROLET	S10	
1992-1993	CHEVROLET	S10 BLAZER	
1993	CHEVROLET	LUMINA	
1990-1992	CHEVROLET	CORVETTE	
1985	CHEVROLET	CAPRICE	
1985	CHEVROLET	EL CAMINO	
1985	CHEVROLET	IMPALA	
1985	CHEVROLET	MONTE CARLO	
1992-1994	GMC	P35/P3500 VAN	
1992-1993	GMC	C15/C1500 PICKUP	
1992-1993	GMC	C15/C1500	
1992-1993	GMC	C25/C2500 PICKUP	
1992-1993	GMC	C25/C2500	
1992-1993	GMC	C35/C3500 PICKUP	
1992-1993	GMC	G15/G1500 VAN	
1992-1993	GMC	G25/G2500 VAN	

#PART PIECE PARTE	MFR/ MARQUE FABRICANTE	MODEL MODELE MODELO	
<b>234-3090 (CONT.)</b>			<b>D</b>
1992-1993	GMC	G35/G3500 VAN	
1992-1993	GMC	JIMMY	
1992-1993	GMC	K15/K1500	
1992-1993	GMC	K15/K1500 TRUCK	
1992-1993	GMC	K25/K2500	
1992-1993	GMC	K25/K2500 TRUCK	
1992-1993	GMC	K35/K3500 TRUCK	
1992-1993	GMC	SAFARI	
1992-1993	GMC	SONOMA	
1992-1993	GMC	TYPHOON	
1992-1993	GMC	YUKON	
1991	GMC	SYCLONE	
1985	GMC	CABALLERO	
1994-1995	HONDA	PASSPORT	
1993-1995	HYUNDAI	SCOUPE	
1995	HYUNDAI	ACCENT	
2002-2004	INFINITI	I35	
1997-2003	INFINITI	QX4	
1999-2002	INFINITI	G20	
1996-2001	INFINITI	I30	
1990-2001	INFINITI	Q45	
1993-1997	INFINITI	J30	
1993-1995	ISUZU	PICKUP	
1993-1995	ISUZU	RODEO	
1993-1994	ISUZU	AMIGO	
1992-1994	JAGUAR	VANDEN PLAS	
1992-1994	JAGUAR	XJ6	
1992-1994	JAGUAR	XJS	
1994	JAGUAR	XJ12	
1993	JAGUAR	XJRS	
1995	KIA	SPORTAGE	
1990-1993	MERCEDES-BENZ	300SL	
1990-1993	MERCEDES-BENZ	300TE	
1993	MERCEDES-BENZ	300E	
1990-1992	MERCEDES-BENZ	300CE	
1990-1992	MERCEDES-BENZ	500SL	
1988-1991	MERCEDES-BENZ	300SE	
1988-1991	MERCEDES-BENZ	300SEL	
1991	MERCEDES-BENZ	300E	
1980	MERCEDES-BENZ	450SLC	
1994-2002	MERCURY	VILLAGER	
1988-1989	MERKUR	SCORPIO	
2000-2004	NISSAN	XTERRA	
1998-2004	NISSAN	FRONTIER	
1996-2004	NISSAN	ALTIMA	
1995-2003	NISSAN	MAXIMA	
1994-2002	NISSAN	PATHFINDER	
1994-2002	NISSAN	QUEST	
1994-2001	NISSAN	SENTRA	
1996-1998	NISSAN	240SX	
1995-1998	NISSAN	200SX	

#PART PIECE PARTE	MFR/ MARQUE FABRICANTE	MODEL MODELE MODELO	
<b>234-3090 (CONT.)</b>			<b>D</b>
1995-1997	NISSAN	PICKUP	
1994-1996	NISSAN	300ZX	
1994	NISSAN	D21	
1992-1993	OLDSMOBILE	BRAVADA	
1993	OLDSMOBILE	CUTLASS SUPREME	
1993	PONTIAC	GRAND PRIX	
1985	PONTIAC	PARISIENNE	
1998-1999	SUBARU	FORESTER	
1993-1999	SUBARU	IMPREZA	
1990-1999	SUBARU	LEGACY	
1992-1997	SUBARU	SVX	
1986-1988	VOLKSWAGEN	QUANTUM	
1992-1994	VOLVO	960	
1991-1993	VOLVO	940	
1990-1993	VOLVO	240	
1985-1992	VOLVO	740	
1987-1991	VOLVO	780	
1984-1990	VOLVO	760	
1989	VOLVO	244	
1989	VOLVO	245	
1986-1987	VOLVO	244	
1986-1987	VOLVO	245	
1985	VOLVO	745	
<b>234-3091</b>			<b>C</b>
1998-1999	SUBARU	FORESTER	
1998-1999	SUBARU	IMPREZA	
1996-1999	SUBARU	LEGACY	
<b>234-3092</b>			<b>C</b>
1992-1993	SAAB	9000	
<b>234-3093</b>			<b>D</b>
1995-1996	NISSAN	PICKUP	
1994-1995	NISSAN	PATHFINDER	
1994	NISSAN	D21	
<b>234-3094</b>			<b>D</b>
1993	BUICK	REGAL	
1992-1994	CHEVROLET	P30 VAN	
1992-1993	CHEVROLET	ASTRO	
1992-1993	CHEVROLET	BLAZER	
1992-1993	CHEVROLET	C1500 SUBURBAN	
1992-1993	CHEVROLET	C1500 TRUCK	
1992-1993	CHEVROLET	C2500 SUBURBAN	
1992-1993	CHEVROLET	C2500 TRUCK	
1992-1993	CHEVROLET	C3500 TRUCK	
1992-1993	CHEVROLET	CAPRICE	
1992-1993	CHEVROLET	G10 VAN	
1992-1993	CHEVROLET	G20 VAN	
1992-1993	CHEVROLET	G30 VAN	
1992-1993	CHEVROLET	K1500 SUBURBAN	
1992-1993	CHEVROLET	K1500 TRUCK	
1992-1993	CHEVROLET	K2500 SUBURBAN	
1992-1993	CHEVROLET	K2500 TRUCK	



#PART PIECE PARTE	MFR / MARQUE FABRICANTE	MODEL MODELE MODELO	
<b>234-3094 (CONT.)</b>			<b>D</b>
1992-1993	CHEVROLET	K3500 TRUCK	
1992-1993	CHEVROLET	S10	
1992-1993	CHEVROLET	S10 BLAZER	
1993	CHEVROLET	LUMINA	
1990-1992	CHEVROLET	CORVETTE	
1992-1994	GMC	P35/P3500 VAN	
1992-1993	GMC	C15/C1500 PICKUP	
1992-1993	GMC	C15/C1500	
1992-1993	GMC	C25/C2500 PICKUP	
1992-1993	GMC	C25/C2500	
1992-1993	GMC	C35/C3500 PICKUP	
1992-1993	GMC	G15/G1500 VAN	
1992-1993	GMC	G25/G2500 VAN	
1992-1993	GMC	G35/G3500 VAN	
1992-1993	GMC	JIMMY	
1992-1993	GMC	K15/K1500	
1992-1993	GMC	K15/K1500 TRUCK	
1992-1993	GMC	K25/K2500	
1992-1993	GMC	K25/K2500 TRUCK	
1992-1993	GMC	K35/K3500 TRUCK	
1992-1993	GMC	SAFARI	
1992-1993	GMC	SONOMA	
1992-1993	GMC	TYPHOON	
1992-1993	GMC	YUKON	
1991	GMC	SYCLONE	
1992-1993	OLDSMOBILE	BRAVADA	
1993	OLDSMOBILE	CUTLASS SUPREME	
1993	PONTIAC	GRAND PRIX	
<b>234-3095</b>			<b>D</b>
1999	INFINITI	I30	
1998-1999	NISSAN	MAXIMA	
<b>234-3096</b>			<b>D</b>
1999-2000	MERCURY	VILLAGER	
1996-1998	NISSAN	240SX	
<b>234-3097</b>			<b>D</b>
1997-2000	INFINITI	QX4	
1996-2000	NISSAN	PATHFINDER	
<b>234-3098</b>			<b>A</b>
1996-1999	INFINITI	I30	
2000-2003	NISSAN	XTERRA	
1999-2003	NISSAN	FRONTIER	
1995-1999	NISSAN	MAXIMA	
<b>234-3099</b>			<b>C</b>
1995	KIA	SPORTAGE	
<b>234-3100</b>			<b>C</b>
1995	KIA	SPORTAGE	
<b>234-3101</b>			<b>C</b>
1995-1998	AUDI	A6	
1995-1998	AUDI	A6 QUATTRO	
1994-1998	AUDI	CABRIOLET	
1993-1995	AUDI	90	

#PART PIECE PARTE	MFR / MARQUE FABRICANTE	MODEL MODELE MODELO	
<b>234-3101 (CONT.)</b>			<b>C</b>
1993-1995	AUDI	90 QUATTRO	
1993-1994	AUDI	100 QUATTRO	
1993-1994	AUDI	100 SERIES	
1993	HYUNDAI	SCOUPE	
<b>234-3102</b>			<b>C</b>
1996-1997	AUDI	A4	
1996-1997	AUDI	A4 QUATTRO	
<b>234-3103</b>			<b>C</b>
1990-1993	MERCEDES-BENZ	300TE	
<b>234-3104</b>			<b>C</b>
1993	MERCEDES-BENZ	300E	
1990-1992	MERCEDES-BENZ	300CE	
1990-1992	MERCEDES-BENZ	300TE	
1988-1991	MERCEDES-BENZ	300SE	
1988-1991	MERCEDES-BENZ	300SEL	
1991	MERCEDES-BENZ	300E	
1980	MERCEDES-BENZ	450SLC	
<b>234-3105</b>			<b>C</b>
1990-1993	MERCEDES-BENZ	300SL	
1990-1992	MERCEDES-BENZ	500SL	
<b>234-3106</b>			<b>D</b>
2002-2003	INFINITI	QX4	
2001-2002	NISSAN	PATHFINDER	
<b>234-3107</b>			<b>C</b>
1993-1995	HYUNDAI	SCOUPE	
1995	HYUNDAI	ACCENT	
<b>234-3108</b>			<b>D</b>
2000-2001	INFINITI	G20	
2000-2001	NISSAN	SENTRA	
<b>234-3109</b>			<b>B</b>
2000-2001	INFINITI	I30	
2000-2001	NISSAN	MAXIMA	
2000-2001	NISSAN	SENTRA	
2001	NISSAN	FRONTIER	
<b>234-3110</b>			<b>D</b>
2000	NISSAN	MAXIMA	
<b>234-3111</b>			<b>B</b>
2000-2001	INFINITI	I30	
2001	INFINITI	QX4	
2000-2001	NISSAN	MAXIMA	
2001	NISSAN	PATHFINDER	
<b>234-3112</b>			<b>D</b>
2000-2001	NISSAN	ALTIMA	
<b>234-3113</b>			<b>C</b>
2002-2004	INFINITI	I35	
2002	INFINITI	G20	
2002-2004	NISSAN	FRONTIER	
2002-2004	NISSAN	XTERRA	
2001-2004	NISSAN	ALTIMA	
2002-2003	NISSAN	MAXIMA	
2001	NISSAN	SENTRA	

#PART PIECE PARTE	MFR / MARQUE FABRICANTE	MODEL MODELE MODELO	
<b>234-3120</b>			<b>D</b>
1995-1996	NISSAN	200SX	
1995-1996	NISSAN	SENTRA	
1987	NISSAN	PULSAR NX	
1986	NISSAN	300ZX	
1986	NISSAN	MAXIMA	
<b>234-3121</b>			<b>C</b>
1990-1993	NISSAN	D21	
1990-1993	NISSAN	PATHFINDER	
<b>234-3122</b>			<b>C</b>
1987-1989	NISSAN	300ZX	
<b>234-3123</b>			<b>C</b>
1994-1996	INFINITI	G20	
1996	INFINITI	I30	
1995-1997	NISSAN	200SX	
1995-1996	NISSAN	MAXIMA	
1995-1996	NISSAN	SENTRA	
1993-1996	NISSAN	ALTIMA	
<b>234-3126</b>			<b>D</b>
1993-1994	MERCURY	VILLAGER	
1993-1994	NISSAN	QUEST	
1990-1994	NISSAN	MAXIMA	
<b>234-3128</b>			<b>C</b>
1996	NISSAN	MAXIMA	
<b>234-3129</b>			<b>D</b>
1995-1996	NISSAN	240SX	
1987-1988	NISSAN	SENTRA	
1987	NISSAN	PULSAR NX	
<b>234-3130</b>			<b>C</b>
1994-1995	LAND ROVER	DEFENDER 90	
1994-1995	LAND ROVER	DISCOVERY	
1987-1995	LAND ROVER	RANGE ROVER	
1993	LAND ROVER	DEFENDER 110	
<b>234-3131</b>			<b>C</b>
1992-1993	VOLVO	940	
1989-1992	VOLVO	740	
1992	VOLVO	240	
<b>234-3132</b>			<b>C</b>
1994-1995	VOLVO	940	
<b>234-3135</b>			<b>C</b>
1993	VOLVO	240	
<b>234-3150</b>			<b>C</b>
1993-1995	HYUNDAI	SCOUPE	
<b>234-3201</b>			<b>C</b>
1990	SUBARU	LOYALE	
1988-1989	SUBARU	GL	
1988-1989	SUBARU	GL-10	
1988-1989	SUBARU	RX	
<b>234-3202</b>			<b>C</b>
1991-1994	SUBARU	LEGACY	
<b>234-3301</b>			<b>D</b>
1990-1993	NISSAN	300ZX	



#PART PIECE PARTE	MFR/ MARQUE FABRICANTE	MODEL MODELE MODELO	
<b>234-3301 (CONT.)</b>			<b>D</b>
1986-1987	NISSAN	200SX	
<b>234-3302</b>			<b>D</b>
1991-1996	INFINITI	G20	
1990	INFINITI	Q45	
1995-1997	NISSAN	200SX	
1991-1994	NISSAN	SENTRA	
1991-1993	NISSAN	NX	
1987-1989	NISSAN	300ZX	
1985-1988	NISSAN	MAXIMA	
1984-1986	NISSAN	200SX	
1984-1985	NISSAN	300ZX	
<b>234-3304</b>			<b>C</b>
1996-1997	INFINITI	J30	
<b>234-3305</b>			<b>D</b>
2002-2003	INFINITI	QX4	
2001-2002	NISSAN	PATHFINDER	
<b>234-3306</b>			<b>C</b>
2001	INFINITI	QX4	
2001	NISSAN	PATHFINDER	
<b>234-3307</b>			<b>C</b>
1987-1989	NISSAN	PATHFINDER	
1986-1989	NISSAN	D21	
<b>234-3308</b>			<b>C</b>
1987-1988	NISSAN	200SX	
<b>234-3309</b>			<b>C</b>
1989	NISSAN	MAXIMA	
<b>234-3310</b>			<b>C</b>
1990-1992	INFINITI	M30	
<b>234-4000</b>			<b>B</b>
1996-1999	ACURA	SLX	
1987-1988	BMW	325I	
1987-1988	BMW	325IS	
1988	BMW	325IX	
1988	BMW	528E	
1986-1987	BMW	735I	
1986-1987	BMW	L7	
2002-2004	BUICK	RENDEZVOUS	
1994-2004	BUICK	CENTURY	
1994-2003	BUICK	LESABRE	
1994-2003	BUICK	PARK AVENUE	
1993-2003	BUICK	REGAL	
1995-1999	BUICK	RIVIERA	
1994-1998	BUICK	SKYLARK	
1994-1996	BUICK	ROADMASTER	
2002	CADILLAC	ESCALADE	
2002	CADILLAC	ESCALADE EXT	
1999-2000	CADILLAC	ESCALADE	
1993-2000	CADILLAC	ELDORADO	
1993-2000	CADILLAC	SEVILLE	
1994-1999	CADILLAC	DEVILLE	
1993-1996	CADILLAC	FLEETWOOD	

#PART PIECE PARTE	MFR/ MARQUE FABRICANTE	MODEL MODELE MODELO	
<b>234-4000 (CONT.)</b>			<b>B</b>
1993	CADILLAC	ALLANTE	
2000-2004	CHEVROLET	IMPALA	
1997-2004	CHEVROLET	VENTURE	
1995-2004	CHEVROLET	MONTE CARLO	
1997-2003	CHEVROLET	MALIBU	
1994-2003	CHEVROLET	CORVETTE	
1994-2003	CHEVROLET	S10	
2000-2002	CHEVROLET	SUBURBAN 1500	
1999-2002	CHEVROLET	SILVERADO 1500	
1996-2002	CHEVROLET	EXPRESS 1500	
1996-2002	CHEVROLET	EXPRESS 2500	
1996-2002	CHEVROLET	EXPRESS 3500	
1996-2002	CHEVROLET	TAHOE	
1995-2002	CHEVROLET	CAVALIER	
1994-2002	CHEVROLET	CAMARO	
2002	CHEVROLET	AVALANCHE 1500	
2000-2001	CHEVROLET	SUBURBAN 2500	
1999-2001	CHEVROLET	SILVERADO 2500	
1995-2001	CHEVROLET	BLAZER	
1994-2001	CHEVROLET	LUMINA	
2001	CHEVROLET	SILVERADO 1500 HD	
2001	CHEVROLET	SILVERADO 2500 HD	
2001	CHEVROLET	SILVERADO 3500	
1996-2000	CHEVROLET	C2500 TRUCK	
1996-2000	CHEVROLET	C3500 TRUCK	
1996-2000	CHEVROLET	K2500 TRUCK	
1996-2000	CHEVROLET	K3500 TRUCK	
1996-1999	CHEVROLET	C1500 SUBURBAN	
1996-1999	CHEVROLET	C1500 TRUCK	
1996-1999	CHEVROLET	C2500 SUBURBAN	
1996-1999	CHEVROLET	K1500 SUBURBAN	
1996-1999	CHEVROLET	K1500 TRUCK	
1996-1999	CHEVROLET	K2500 SUBURBAN	
1995-1999	CHEVROLET	P30 VAN	
1996-1997	CHEVROLET	ASTRO	
1994-1996	CHEVROLET	BERETTA	
1994-1996	CHEVROLET	CAPRICE	
1994-1996	CHEVROLET	CORSICA	
1994-1996	CHEVROLET	IMPALA	
1994-1996	CHEVROLET	LUMINA APV	
1996	CHEVROLET	G30 VAN	
1994	CHEVROLET	S10 BLAZER	
1999-2002	DAEWOO	LANOS	
1999-2002	DAEWOO	LEGANZA	
1999-2002	DAEWOO	NUBIRA	
1994-2003	GMC	SONOMA	
2000-2002	GMC	YUKON XL 1500	
1999-2002	GMC	SIERRA 1500	
1996-2002	GMC	SAVANA 1500	
1996-2002	GMC	SAVANA 2500	
1996-2002	GMC	SAVANA 3500	

#PART PIECE PARTE	MFR/ MARQUE FABRICANTE	MODEL MODELE MODELO	
<b>234-4000 (CONT.)</b>			<b>B</b>
1996-2002	GMC	YUKON	
2000-2001	GMC	YUKON XL 2500	
1999-2001	GMC	SIERRA 2500	
1994-2001	GMC	JIMMY	
2001	GMC	SIERRA 1500 HD	
2001	GMC	SIERRA 2500 HD	
2001	GMC	SIERRA 3500	
1996-2000	GMC	C25/C2500 PICKUP	
1996-2000	GMC	C35/C3500 PICKUP	
1996-2000	GMC	K25/K2500 TRUCK	
1996-2000	GMC	K35/K3500 TRUCK	
1996-1999	GMC	C15/C1500 PICKUP	
1996-1999	GMC	C15/C1500	
1996-1999	GMC	C25/C2500	
1996-1999	GMC	K15/K1500	
1996-1999	GMC	K15/K1500 TRUCK	
1996-1999	GMC	K25/K2500	
1995-1999	GMC	P35/P3500 VAN	
1996-1997	GMC	SAFARI	
1996	GMC	G35/G3500 VAN	
1996-2000	HONDA	PASSPORT	
2001-2003	ISUZU	RODEO SPORT	
1996-2003	ISUZU	RODEO	
1999-2001	ISUZU	VEHICROSS	
1998-2000	ISUZU	AMIGO	
1996-2000	ISUZU	HOMBRE	
1996-1999	ISUZU	TROOPER	
1992-1995	LEXUS	SC400	
1990-1994	LEXUS	LS400	
1995-1996	MERCEDES-BENZ	C36 AMG	
1994-1996	MERCEDES-BENZ	C220	
1994-1996	MERCEDES-BENZ	C280	
1994-1995	MERCEDES-BENZ	E420	
1994-1995	MERCEDES-BENZ	S320	
1994-1995	MERCEDES-BENZ	S420	
1994-1995	MERCEDES-BENZ	S500	
1994-1995	MERCEDES-BENZ	SL500	
1994	MERCEDES-BENZ	E500	
1992-1993	MERCEDES-BENZ	500SEL	
1993	MERCEDES-BENZ	300E	
1993	MERCEDES-BENZ	300SE	
1993	MERCEDES-BENZ	400E	
1993	MERCEDES-BENZ	400SEL	
1993	MERCEDES-BENZ	500E	
1993	MERCEDES-BENZ	500SEC	
1993	MERCEDES-BENZ	500SL	
1992	MERCEDES-BENZ	400SE	
1999-2004	OLDSMOBILE	ALERO	
1994-2004	OLDSMOBILE	SILHOUETTE	
1996-2001	OLDSMOBILE	BRAVADA	
1998-1999	OLDSMOBILE	INTRIGUE	



#PART PIECE PARTE	MFR / MARQUE FABRICANTE	MODEL MODELE MODELO
<b>234-4000 (CONT.) B</b>		
1997-1999	OLDSMOBILE	CUTLASS
1996-1999	OLDSMOBILE	LSS
1995-1999	OLDSMOBILE	AURORA
1994-1999	OLDSMOBILE	88
1997-1998	OLDSMOBILE	REGENCY
1994-1998	OLDSMOBILE	ACHIEVA
1993-1997	OLDSMOBILE	CUTLASS SUPREME
1994-1996	OLDSMOBILE	98
1994-1996	OLDSMOBILE	CUTLASS CIERA
1994	OLDSMOBILE	CUTLASS CRUISER
2001-2004	PONTIAC	AZTEK
1999-2004	PONTIAC	MONTANA
1994-2004	PONTIAC	GRAND AM
1994-2003	PONTIAC	BONNEVILLE
1994-2003	PONTIAC	GRAND PRIX
1995-2002	PONTIAC	SUNFIRE
1994-2002	PONTIAC	FIREBIRD
1994-1999	PONTIAC	TRANS SPORT
2001	SATURN	L100
2001	SATURN	L200
2001	SATURN	LW200
2000	SATURN	LS
2000	SATURN	LS1
2000	SATURN	LW1
1996-1999	SATURN	SC1
1996-1999	SATURN	SC2
1996-1999	SATURN	SL
1996-1999	SATURN	SL1
1996-1999	SATURN	SL2
1996-1999	SATURN	SW1
1996-1999	SATURN	SW2
<b>234-4001 A</b>		
1994-1995	FORD	MUSTANG
1994-1995	FORD	THUNDERBIRD
1995	FORD	BRONCO
1995	FORD	E-150 VAN
1995	FORD	E-250 VAN
1995	FORD	E-350 VAN
1995	FORD	F-150
1995	FORD	F-250
1995	FORD	F-350
2001-2002	JAGUAR	S-TYPE
1994	MAZDA	B2300
1994-1995	MERCURY	COUGAR
<b>234-4002 D</b>		
1996-1997	CHRYSLER	CONCORDE
1996-1997	CHRYSLER	INTREPID
1996-1997	CHRYSLER	LHS
1995-1997	CHRYSLER	CIRRUS
1996	CHRYSLER	NEW YORKER
1998	DODGE	CARAVAN

#PART PIECE PARTE	MFR / MARQUE FABRICANTE	MODEL MODELE MODELO
<b>234-4002 (CONT.) D</b>		
1996-1997	DODGE	INTREPID
1995-1997	DODGE	STRATUS
1996-1997	EAGLE	VISION
1998	PLYMOUTH	VOYAGER
1996-1997	PLYMOUTH	BREEZE
<b>234-4003 A</b>		
1996-1997	CHRYSLER	CONCORDE
1996-1997	CHRYSLER	INTREPID
1996-1997	CHRYSLER	LHS
1995-1997	CHRYSLER	SEBRING
1996	CHRYSLER	NEW YORKER
1996-1997	DODGE	INTREPID
1995-1997	DODGE	AVENGER
1992-1995	DODGE	VIPER
1990-1995	DODGE	DAKOTA
1995	DODGE	B1500 VAN
1995	DODGE	B2500 VAN
1995	DODGE	B3500 VAN
1990-1994	DODGE	B150 VAN
1990-1994	DODGE	B250 VAN
1990-1994	DODGE	B350 VAN
1994	DODGE	RAM 1500 PICKUP
1994	DODGE	RAM 2500 PICKUP
1994	DODGE	RAM 3500 PICKUP
1990-1993	DODGE	D150 PICKUP
1990-1993	DODGE	D250 PICKUP
1990-1993	DODGE	RAMCHARGER
1990-1993	DODGE	W150 PICKUP
1990-1993	DODGE	W250 PICKUP
1996-1997	EAGLE	VISION
1995-1996	EAGLE	TALON
1993-1995	JEEP	GRAND CHEROKEE
1991-1995	JEEP	CHEROKEE
1991-1995	JEEP	WRANGLER
1993	JEEP	GRAND WAGONEER
1991-1992	JEEP	COMANCHE
1995-1996	MITSUBISHI	ECLIPSE
<b>234-4004 A</b>		
1995-1996	CHRYSLER	CIRRUS
1996	CHRYSLER	SEBRING
1994-1995	CHRYSLER	LHS
1993-1995	CHRYSLER	CONCORDE
1993-1995	CHRYSLER	INTREPID
1989-1995	CHRYSLER	LEBARON
1989-1995	CHRYSLER	NEW YORKER
1990-1994	CHRYSLER	TOWN & COUNTRY
1990-1993	CHRYSLER	IMPERIAL
1989-1993	CHRYSLER	DAYTONA
1988-1993	CHRYSLER	DYNASTY
1989-1991	CHRYSLER	TC MASERATI
1995-1996	DODGE	NEON

#PART PIECE PARTE	MFR / MARQUE FABRICANTE	MODEL MODELE MODELO
<b>234-4004 (CONT.) A</b>		
1995-1996	DODGE	STRATUS
1989-1996	DODGE	DAKOTA
1994-1995	DODGE	RAM 1500 PICKUP
1994-1995	DODGE	RAM 2500 PICKUP
1994-1995	DODGE	RAM 3500 PICKUP
1993-1995	DODGE	INTREPID
1989-1995	DODGE	CARAVAN
1989-1995	DODGE	SPIRIT
1989-1994	DODGE	GRAND CARAVAN
1989-1994	DODGE	SHADOW
1989-1993	DODGE	DAYTONA
1989-1993	DODGE	DYNASTY
1988-1993	DODGE	B250 VAN
1988-1993	DODGE	B350 VAN
1988-1993	DODGE	D250 PICKUP
1988-1993	DODGE	D350 PICKUP
1988-1993	DODGE	RAMCHARGER
1988-1993	DODGE	W250 PICKUP
1988-1993	DODGE	W350 PICKUP
1993	DODGE	D150 PICKUP
1993	DODGE	W150 PICKUP
1988-1991	DODGE	D150 PICKUP
1988-1991	DODGE	W150 PICKUP
1991	DODGE	B150 VAN
1989-1990	DODGE	OMNI
1988-1989	DODGE	D100 PICKUP
1988-1989	DODGE	W100 PICKUP
1989	DODGE	ARIES
1989	DODGE	B150 VAN
1989	DODGE	LANCER
1993-1995	EAGLE	VISION
1991-1996	JEEP	CHEROKEE
1991-1995	JEEP	WRANGLER
1991-1992	JEEP	COMANCHE
1995-1996	PLYMOUTH	NEON
1996	PLYMOUTH	BREEZE
1989-1995	PLYMOUTH	ACCLAIM
1989-1995	PLYMOUTH	VOYAGER
1989-1994	PLYMOUTH	GRAND VOYAGER
1989-1994	PLYMOUTH	SUNDANCE
1989-1990	PLYMOUTH	HORIZON
1989	PLYMOUTH	EXPO
1989	PLYMOUTH	RELIANT
<b>234-4005 D</b>		
2000	CHRYSLER	VOYAGER
1996-1997	CHRYSLER	SEBRING
1997	CHRYSLER	CIRRUS
1999-2000	DODGE	CARAVAN
1997	DODGE	CARAVAN
1997	DODGE	GRAND CARAVAN
1997	DODGE	STRATUS



#PART PIECE PARTE	MFR/ MARQUE FABRICANTE	MODEL MODELE MODELO	
<b>234-4005 (CONT.)</b>			<b>D</b>
1999-2000	PLYMOUTH	VOYAGER	
1997	PLYMOUTH	GRAND VOYAGER	
1997	PLYMOUTH	VOYAGER	
<b>234-4006</b>			<b>D</b>
1994-1995	CADILLAC	DEVILLE	
1993-1995	CADILLAC	ELDORADO	
1993-1995	CADILLAC	SEVILLE	
1993	CADILLAC	ALLANTE	
1995	OLDSMOBILE	AURORA	
<b>234-4007</b>			<b>C</b>
1991-1994	EAGLE	TALON	
1991-1994	MITSUBISHI	ECLIPSE	
1991-1992	MITSUBISHI	GALANT	
1991-1994	PLYMOUTH	LASER	
<b>234-4008</b>			<b>D</b>
2001-2002	CHRYSLER	NEON	
2001-2002	CHRYSLER	PT CRUISER	
2001-2002	DODGE	NEON	
2000-2001	JEEP	CHEROKEE	
2000	JEEP	TJ	
2000	JEEP	WRANGLER	
2001	PLYMOUTH	NEON	
<b>234-4010</b>			<b>C</b>
2001-2003	CHRYSLER	TOWN & COUNTRY	
2001-2003	CHRYSLER	VOYAGER	
2001-2003	DODGE	CARAVAN	
2001-2003	DODGE	GRAND CARAVAN	
<b>234-4011</b>			<b>A</b>
1994-2001	ACURA	INTEGRA	
1992-1994	ACURA	VIGOR	
1997-2001	HONDA	CR-V	
1999-2000	HONDA	CIVIC	
1994-1997	HONDA	CIVIC DEL SOL	
1992-1995	HONDA	PRELUDE	
<b>234-4012</b>			<b>A</b>
1996-1999	ACURA	SLX	
1995-1996	BUICK	RIVIERA	
1994-1996	BUICK	CENTURY	
1994-1996	BUICK	LESABRE	
1994-1996	BUICK	PARK AVENUE	
1994-1996	BUICK	ROADMASTER	
1994-1996	BUICK	SKYLARK	
1993-1996	BUICK	REGAL	
2002	CADILLAC	ESCALADE	
1999-2000	CADILLAC	ESCALADE	
1993-1996	CADILLAC	FLEETWOOD	
1994-2003	CHEVROLET	CORVETTE	
2000-2002	CHEVROLET	SUBURBAN 1500	
1999-2002	CHEVROLET	SILVERADO 1500	
1996-2002	CHEVROLET	EXPRESS 1500	
1996-2002	CHEVROLET	EXPRESS 2500	

#PART PIECE PARTE	MFR/ MARQUE FABRICANTE	MODEL MODELE MODELO	
<b>234-4012 (CONT.)</b>			<b>A</b>
1996-2002	CHEVROLET	EXPRESS 3500	
1996-2002	CHEVROLET	TAHOE	
2002	CHEVROLET	AVALANCHE 1500	
1995-2001	CHEVROLET	BLAZER	
1994-2001	CHEVROLET	S10	
1999-2000	CHEVROLET	SILVERADO 2500	
1996-1999	CHEVROLET	C1500 SUBURBAN	
1996-1999	CHEVROLET	C1500 TRUCK	
1996-1999	CHEVROLET	K1500 SUBURBAN	
1996-1999	CHEVROLET	K1500 TRUCK	
1996-1998	CHEVROLET	C2500 TRUCK	
1996-1998	CHEVROLET	K2500 TRUCK	
1996-1997	CHEVROLET	ASTRO	
1994-1997	CHEVROLET	CAMARO	
1995-1996	CHEVROLET	MONTE CARLO	
1994-1996	CHEVROLET	BERETTA	
1994-1996	CHEVROLET	CAPRICE	
1994-1996	CHEVROLET	CORSICA	
1994-1996	CHEVROLET	IMPALA	
1994-1996	CHEVROLET	LUMINA	
1994-1996	CHEVROLET	LUMINA APV	
1996	CHEVROLET	C2500 SUBURBAN	
1996	CHEVROLET	G30 VAN	
1996	CHEVROLET	K2500 SUBURBAN	
1995	CHEVROLET	P30 VAN	
1994	CHEVROLET	S10 BLAZER	
1999-2002	DAEWOO	LANOS	
1999-2002	DAEWOO	LEGANZA	
2000-2002	GMC	YUKON XL 1500	
1999-2002	GMC	SIERRA 1500	
1996-2002	GMC	SAVANA 1500	
1996-2002	GMC	SAVANA 2500	
1996-2002	GMC	SAVANA 3500	
1996-2002	GMC	YUKON	
1994-2001	GMC	JIMMY	
1994-2001	GMC	SONOMA	
1999-2000	GMC	SIERRA 2500	
1996-1999	GMC	C15/C1500 PICKUP	
1996-1999	GMC	C15/C1500	
1996-1999	GMC	K15/K1500	
1996-1999	GMC	K15/K1500 TRUCK	
1996-1998	GMC	C25/C2500 PICKUP	
1996-1998	GMC	K25/K2500 TRUCK	
1996-1997	GMC	SAFARI	
1996	GMC	C25/C2500	
1996	GMC	G35/G3500 VAN	
1996	GMC	K25/K2500	
1995	GMC	P35/P3500 VAN	
1996-2000	HONDA	PASSPORT	
2001-2003	ISUZU	RODEO SPORT	
1996-2003	ISUZU	RODEO	

#PART PIECE PARTE	MFR/ MARQUE FABRICANTE	MODEL MODELE MODELO	
<b>234-4012 (CONT.)</b>			<b>A</b>
1999-2001	ISUZU	VEHICROSS	
1998-2000	ISUZU	AMIGO	
1996-2000	ISUZU	HOMBRE	
1996-1999	ISUZU	TROOPER	
1996-2001	OLDSMOBILE	BRAVADA	
1994-1996	OLDSMOBILE	88	
1994-1996	OLDSMOBILE	98	
1994-1996	OLDSMOBILE	ACHIEVA	
1994-1996	OLDSMOBILE	CUTLASS CIERA	
1994-1996	OLDSMOBILE	SILHOUETTE	
1993-1996	OLDSMOBILE	CUTLASS SUPREME	
1996	OLDSMOBILE	LSS	
1994	OLDSMOBILE	CUTLASS CRUISER	
1994-1997	PONTIAC	FIREBIRD	
1994-1996	PONTIAC	BONNEVILLE	
1994-1996	PONTIAC	GRAND AM	
1994-1996	PONTIAC	GRAND PRIX	
1994-1996	PONTIAC	TRANS SPORT	
<b>234-4013</b>			<b>D</b>
1995-1996	DODGE	NEON	
1988-1993	DODGE	DAKOTA	
1991-1992	DODGE	MONACO	
1988-1989	DODGE	D100 PICKUP	
1988-1989	DODGE	D150 PICKUP	
1988-1989	DODGE	D250 PICKUP	
1989	DODGE	W100 PICKUP	
1989	DODGE	W150 PICKUP	
1991-1992	EAGLE	PREMIER	
1995-1996	PLYMOUTH	NEON	
<b>234-4014</b>			<b>C</b>
1988-1989	DODGE	B150 VAN	
1988-1989	DODGE	B250 VAN	
<b>234-4015</b>			<b>C</b>
2001-2005	LEXUS	IS300	
<b>234-4016</b>			<b>D</b>
1995-1999	FORD	CONTOUR	
1995-1999	MERCURY	MYSTIQUE	
1999	MERCURY	COUGAR	
<b>234-4017</b>			<b>C</b>
1993-1994	DODGE	COLT	
1993-1996	EAGLE	SUMMIT	
1993-1995	MITSUBISHI	EXPO	
1993-1994	MITSUBISHI	EXPO LRV	
1993-1994	PLYMOUTH	COLT	
<b>234-4018</b>			<b>A</b>
1997-2003	BUICK	LESABRE	
1997-2003	BUICK	PARK AVENUE	
1997-2003	BUICK	REGAL	
1997-2000	BUICK	CENTURY	
1997-1999	BUICK	RIVIERA	
1997-1998	BUICK	SKYLARK	



#PART PIECE PARTE	MFR / MARQUE FABRICANTE	MODEL MODELE MODELO	A
<b>234-4018 (CONT.)</b>			
2002	CADILLAC	ESCALADE	
2002	CADILLAC	ESCALADE EXT	
1999-2000	CADILLAC	ESCALADE	
1996-2000	CADILLAC	ELDORADO	
1996-2000	CADILLAC	SEVILLE	
1996-1999	CADILLAC	DEVILLE	
2000-2003	CHEVROLET	IMPALA	
1997-2003	CHEVROLET	MONTE CARLO	
2000-2002	CHEVROLET	SUBURBAN 1500	
1999-2002	CHEVROLET	SILVERADO 1500	
1997-2002	CHEVROLET	CAMARO	
1996-2002	CHEVROLET	EXPRESS 1500	
1996-2002	CHEVROLET	EXPRESS 2500	
1996-2002	CHEVROLET	EXPRESS 3500	
1996-2002	CHEVROLET	TAHOE	
2002	CHEVROLET	AVALANCHE 1500	
2000-2001	CHEVROLET	SUBURBAN 2500	
1999-2001	CHEVROLET	SILVERADO 2500	
1997-2001	CHEVROLET	LUMINA	
2001	CHEVROLET	SILVERADO 1500 HD	
2001	CHEVROLET	SILVERADO 2500 HD	
2001	CHEVROLET	SILVERADO 3500	
1997-2000	CHEVROLET	MALIBU	
1997-2000	CHEVROLET	VENTURE	
1996-2000	CHEVROLET	C2500 TRUCK	
1996-2000	CHEVROLET	C3500 TRUCK	
1996-2000	CHEVROLET	K2500 TRUCK	
1996-2000	CHEVROLET	K3500 TRUCK	
1996-1999	CHEVROLET	C1500 SUBURBAN	
1996-1999	CHEVROLET	C1500 TRUCK	
1996-1999	CHEVROLET	C2500 SUBURBAN	
1996-1999	CHEVROLET	K1500 SUBURBAN	
1996-1999	CHEVROLET	K1500 TRUCK	
1996-1999	CHEVROLET	K2500 SUBURBAN	
1996-1999	CHEVROLET	P30 VAN	
1996-1997	CHEVROLET	ASTRO	
1996	CHEVROLET	G30 VAN	
2000-2002	GMC	YUKON XL 1500	
1999-2002	GMC	SIERRA 1500	
1996-2002	GMC	SAVANA 1500	
1996-2002	GMC	SAVANA 2500	
1996-2002	GMC	SAVANA 3500	
1996-2002	GMC	YUKON	
2000-2001	GMC	YUKON XL 2500	
1999-2001	GMC	SIERRA 2500	
2001	GMC	SIERRA 1500 HD	
2001	GMC	SIERRA 2500 HD	
2001	GMC	SIERRA 3500	
1996-2000	GMC	C25/C2500 PICKUP	
1996-2000	GMC	C35/C3500 PICKUP	
1996-2000	GMC	K25/K2500 TRUCK	

#PART PIECE PARTE	MFR / MARQUE FABRICANTE	MODEL MODELE MODELO	A
<b>234-4018 (CONT.)</b>			
1996-2000	GMC	K35/K3500 TRUCK	
1996-1999	GMC	C15/C1500 PICKUP	
1996-1999	GMC	C15/C1500	
1996-1999	GMC	C25/C2500	
1996-1999	GMC	K15/K1500	
1996-1999	GMC	K15/K1500 TRUCK	
1996-1999	GMC	K25/K2500	
1996-1999	GMC	P35/P3500 VAN	
1996-1997	GMC	SAFARI	
1996	GMC	G35/G3500 VAN	
1999-2000	OLDSMOBILE	ALERO	
1997-2000	OLDSMOBILE	SILHOUETTE	
1998-1999	OLDSMOBILE	INTRIGUE	
1997-1999	OLDSMOBILE	88	
1997-1999	OLDSMOBILE	CUTLASS	
1997-1999	OLDSMOBILE	LSS	
1996-1999	OLDSMOBILE	AURORA	
1997-1998	OLDSMOBILE	ACHIEVA	
1997-1998	OLDSMOBILE	REGENCY	
1997	OLDSMOBILE	CUTLASS SUPREME	
1997-2003	PONTIAC	BONNEVILLE	
1997-2003	PONTIAC	GRAND PRIX	
1997-2002	PONTIAC	FIREBIRD	
1999-2000	PONTIAC	MONTANA	
1997-2000	PONTIAC	GRAND AM	
1997-1999	PONTIAC	TRANS SPORT	
<b>234-4019</b>			
<b>A</b>			
1996-2002	CHEVROLET	EXPRESS 1500	
1996-2002	CHEVROLET	EXPRESS 2500	
1996-2002	CHEVROLET	EXPRESS 3500	
1999-2000	CHEVROLET	SILVERADO 2500	
1996-2000	CHEVROLET	C2500 TRUCK	
1996-2000	CHEVROLET	C3500 TRUCK	
1996-2000	CHEVROLET	K3500 TRUCK	
2000	CHEVROLET	SUBURBAN 2500	
1996-1999	CHEVROLET	C1500 SUBURBAN	
1996-1999	CHEVROLET	C1500 TRUCK	
1996-1999	CHEVROLET	C2500 SUBURBAN	
1996-1999	CHEVROLET	K1500 SUBURBAN	
1996-1999	CHEVROLET	K1500 TRUCK	
1996-1999	CHEVROLET	K2500 SUBURBAN	
1996-1999	CHEVROLET	P30 VAN	
1996-1999	CHEVROLET	C1500 SUBURBAN	
1996-1999	CHEVROLET	C1500 TRUCK	
1996-1999	CHEVROLET	C2500 SUBURBAN	
1996-1999	CHEVROLET	K1500 SUBURBAN	
1996-1999	CHEVROLET	K1500 TRUCK	
1996-1999	CHEVROLET	K2500 SUBURBAN	
1996-1999	CHEVROLET	P30 VAN	
1996-1999	CHEVROLET	TAHOE	
1996	CHEVROLET	G30 VAN	
1996-2002	GMC	SAVANA 1500	
1996-2002	GMC	SAVANA 2500	
1996-2002	GMC	SAVANA 3500	
1999-2000	GMC	SIERRA 2500	
1996-2000	GMC	C25/C2500 PICKUP	
1996-2000	GMC	C35/C3500 PICKUP	
1996-2000	GMC	C35/C3500 PICKUP	

#PART PIECE PARTE	MFR / MARQUE FABRICANTE	MODEL MODELE MODELO	A
<b>234-4019 (CONT.)</b>			
1996-2000	GMC	K25/K2500 TRUCK	
1996-2000	GMC	K35/K3500 TRUCK	
2000	GMC	YUKON XL 2500	
1996-1999	GMC	C15/C1500 PICKUP	
1996-1999	GMC	C15/C1500	
1996-1999	GMC	C25/C2500	
1996-1999	GMC	K15/K1500	
1996-1999	GMC	K15/K1500 TRUCK	
1996-1999	GMC	K25/K2500	
1996-1999	GMC	P35/P3500 VAN	
1996-1998	GMC	YUKON	
1996	GMC	G35/G3500 VAN	
<b>234-4020</b>			
<b>C</b>			
1993-1995	DODGE	COLT	
1993-1996	EAGLE	SUMMIT	
1993-1996	MITSUBISHI	MIRAGE	
1993-1995	PLYMOUTH	COLT	
<b>234-4021</b>			
<b>C</b>			
1996-2000	CHRYSLER	TOWN & COUNTRY	
2000	CHRYSLER	GRAND VOYAGER	
2000	CHRYSLER	VOYAGER	
1996-2000	DODGE	CARAVAN	
1996-2000	DODGE	GRAND CARAVAN	
1996-2000	PLYMOUTH	GRAND VOYAGER	
1996-2000	PLYMOUTH	VOYAGER	
<b>234-4022</b>			
<b>C</b>			
2001-2002	CHRYSLER	VOYAGER	
2001-2002	DODGE	CARAVAN	
<b>234-4023</b>			
<b>C</b>			
1986-1987	BMW	735i	
1986-1987	BMW	L7	
<b>234-4024</b>			
<b>D</b>			
2000-2001	CHEVROLET	SUBURBAN 2500	
1999-2001	CHEVROLET	SILVERADO 2500	
2001	CHEVROLET	SILVERADO 1500 HD	
2001	CHEVROLET	SILVERADO 2500 HD	
2001	CHEVROLET	SILVERADO 3500	
2000-2001	GMC	YUKON XL 2500	
1999-2001	GMC	SIERRA 2500	
2001	GMC	SIERRA 1500	
2001	GMC	SIERRA 1500 HD	
2001	GMC	SIERRA 2500 HD	
2001	GMC	SIERRA 3500	
2001	GMC	YUKON XL 1500	
<b>234-4025</b>			
<b>A</b>			
1996-2000	CADILLAC	ELDORADO	
1996-2000	CADILLAC	SEVILLE	
1996-1999	CADILLAC	DEVILLE	
1998-2002	CHEVROLET	CAMARO	
1998-2002	PONTIAC	FIREBIRD	



#PART PIECE PARTE	MFR/ MARQUE FABRICANTE	MODEL MODELE MODELO	
<b>234-4026</b>			<b>C</b>
1995-1998	EAGLE	TALON	
2006-2012	MITSUBISHI	ECLIPSE	
2004-2012	MITSUBISHI	GALANT	
1997-1999	MITSUBISHI	MONTERO SPORT	
1995-1999	MITSUBISHI	ECLIPSE	
1995-1996	MITSUBISHI	MONTERO	
1994-1996	MITSUBISHI	DIAMANTE	
<b>234-4027</b>			<b>C</b>
1993	DODGE	COLT	
1995-1998	EAGLE	TALON	
1993	EAGLE	SUMMIT	
1995-1999	MITSUBISHI	ECLIPSE	
1993	PLYMOUTH	COLT	
<b>234-4028</b>			<b>D</b>
1996-2000	CHRYSLER	SEBRING	
<b>234-4029</b>			<b>B</b>
2001-2003	DODGE	RAM 1500 PICKUP	
2001-2003	DODGE	RAM 1500 VAN	
2001-2003	DODGE	RAM 2500 VAN	
2001-2003	DODGE	RAM 3500 VAN	
2001-2002	DODGE	RAM 2500 PICKUP	
2001-2002	DODGE	RAM 3500 PICKUP	
2002-2003	JEEP	LIBERTY	
2001-2003	JEEP	GRAND CHEROKEE	
<b>234-4030</b>			<b>C</b>
2002-2003	DODGE	DURANGO	
2001-2003	DODGE	DAKOTA	
2001-2003	DODGE	RAM 1500 PICKUP	
2001-2003	DODGE	RAM 1500 VAN	
2001-2003	DODGE	RAM 2500 VAN	
2001-2003	DODGE	RAM 3500 VAN	
2001-2002	DODGE	RAM 2500 PICKUP	
2001-2002	DODGE	RAM 3500 PICKUP	
2001-2004	JEEP	WRANGLER	
2002-2003	JEEP	LIBERTY	
2001-2003	JEEP	GRAND CHEROKEE	
2001-2003	JEEP	TJ	
<b>234-4031</b>			<b>C</b>
1996-1998	SUZUKI	SIDEKICK	
<b>234-4032</b>			<b>C</b>
1995	DODGE	COLT	
1995-1996	EAGLE	SUMMIT	
1995-1996	MITSUBISHI	MIRAGE	
1995	PLYMOUTH	COLT	
<b>234-4033</b>			<b>C</b>
1999-2000	SUZUKI	GRAND VITARA	
<b>234-4034</b>			<b>C</b>
1994-1998	HYUNDAI	SONATA	
1993-1995	HYUNDAI	ELANTRA	
<b>234-4035</b>			<b>C</b>
1996-1998	HYUNDAI	SONATA	

#PART PIECE PARTE	MFR/ MARQUE FABRICANTE	MODEL MODELE MODELO	
<b>234-4036</b>			<b>D</b>
1997-2000	MAZDA	MILLENNIA	
<b>234-4037</b>			<b>D</b>
1996-1997	FORD	ASPIRE	
1997-2000	MAZDA	MILLENNIA	
1991-1995	MAZDA	MPV	
<b>234-4038</b>			<b>C</b>
1997-2000	MAZDA	MILLENNIA	
<b>234-4039</b>			<b>D</b>
1995-2002	MAZDA	MILLENNIA	
1997-2000	MAZDA	626	
1997	MAZDA	MX-6	
<b>234-4040</b>			<b>D</b>
2003-2005	MAZDA	6	
2000-2002	MAZDA	626	
<b>234-4041</b>			<b>D</b>
1996-1997	FORD	PROBE	
1998-2000	MAZDA	626	
<b>234-4042</b>			<b>C</b>
1993-2005	HYUNDAI	SONATA	
1993-1995	HYUNDAI	ELANTRA	
1992-1994	HYUNDAI	EXCEL	
1992-1994	MITSUBISHI	PRECIS	
<b>234-4043</b>			<b>D</b>
2000-2002	MAZDA	626	
<b>234-4044</b>			<b>D</b>
2007-2012	MAZDA	CX-7	
2000-2002	MAZDA	626	
<b>234-4045</b>			<b>A</b>
2005-2007	FORD	FIVE HUNDRED	
2005-2007	FORD	FREESTYLE	
2005-2007	FORD	TAURUS	
2005-2006	FORD	GT	
2001-2006	FORD	ESCAPE	
1999-2006	FORD	CROWN VICTORIA	
2000-2005	FORD	EXCURSION	
2000-2004	FORD	E-150 VAN	
2000-2004	FORD	F-250 SUPER DUTY	
2000-2004	FORD	F-350 SUPER DUTY	
2000-2004	FORD	FOCUS	
1999-2004	FORD	E-250 VAN	
1999-2004	FORD	E-350 SUPER DUTY	
1999-2004	FORD	E-350 VAN	
2004	FORD	E-250 SUPER DUTY	
2001-2003	FORD	ESCORT	
2000-2002	FORD	E-450 ECONOLINE	
2000-2002	FORD	F-150	
1999-2000	FORD	CONTOUR	
1999-2000	FORD	TAURUS	
1998-2006	LINCOLN	TOWN CAR	
2001-2006	MAZDA	TRIBUTE	
2005-2007	MERCURY	MONTEGO	

#PART PIECE PARTE	MFR/ MARQUE FABRICANTE	MODEL MODELE MODELO	
<b>234-4045 (CONT.)</b>			<b>A</b>
2005-2006	MERCURY	MARINER	
1999-2006	MERCURY	GRAND MARQUIS	
2005	MERCURY	SABLE	
2003-2004	MERCURY	MARAUDER	
1999-2002	MERCURY	COUGAR	
1999-2000	MERCURY	MYSTIQUE	
1999-2000	MERCURY	SABLE	
<b>234-4046</b>			<b>A</b>
1999-2010	FORD	MUSTANG	
2001-2008	FORD	ESCAPE	
2005-2007	FORD	FIVE HUNDRED	
2005-2007	FORD	FREESTYLE	
2001-2007	FORD	TAURUS	
2002-2005	FORD	THUNDERBIRD	
1999-2004	FORD	EXPEDITION	
2004	FORD	F-150 HERITAGE	
2001-2003	FORD	EXPLORER	
1999-2003	FORD	F-150	
1999-2002	FORD	E-150 VAN	
1999-2001	FORD	E-250 VAN	
2000	FORD	ESCORT	
1998-1999	FORD	CROWN VICTORIA	
1999	FORD	F-250	
2000-2002	JAGUAR	S-TYPE	
2000-2006	LINCOLN	LS	
2003-2005	LINCOLN	AVIATOR	
2003-2004	LINCOLN	NAVIGATOR	
1998-2002	LINCOLN	CONTINENTAL	
2002	LINCOLN	BLACKWOOD	
1999-2000	LINCOLN	NAVIGATOR	
1998-1999	LINCOLN	TOWN CAR	
2008	MAZDA	TRIBUTE	
2001-2006	MAZDA	TRIBUTE	
2005-2008	MERCURY	MARINER	
2005-2007	MERCURY	MONTEGO	
2001-2005	MERCURY	SABLE	
2002-2003	MERCURY	MOUNTAINEER	
1998	MERCURY	GRAND MARQUIS	
<b>234-4048</b>			<b>A</b>
1995-1996	JAGUAR	XJ12	
1995	JAGUAR	XJS	
1998-2005	LEXUS	GS300	
2001-2003	TOYOTA	HIGHLANDER	
2001-2003	TOYOTA	RAV4	
<b>234-4049</b>			<b>B</b>
1998-2001	CHEVROLET	METRO	
1999-2000	CHEVROLET	TRACKER	
1994-1997	GEO	METRO	
1994-2000	PONTIAC	FIREFLY	
1994-2001	SUZUKI	SWIFT	
1999-2000	SUZUKI	VITARA	



#PART PIECE PARTE	MFR / MARQUE FABRICANTE	MODEL MODELE MODELO	
<b>234-4050</b>			<b>D</b>
1988	CHEVROLET	NOVA	
1990-1991	LEXUS	ES250	
1993-1997	TOYOTA	T100	
1991-1995	TOYOTA	MR2	
1991-1995	TOYOTA	PREVIA	
1988-1995	TOYOTA	4RUNNER	
1988-1995	TOYOTA	PICKUP	
1988-1993	TOYOTA	CELICA	
1989-1992	TOYOTA	CRESSIDA	
1985-1992	TOYOTA	LAND CRUISER	
1988-1991	TOYOTA	CAMRY	
1988-1989	TOYOTA	MR2	
1988-1989	TOYOTA	VAN	
1988	TOYOTA	COROLLA	
1988	TOYOTA	VAN WAGON	
<b>234-4051</b>			<b>C</b>
1990-1991	LEXUS	ES250	
1990-1992	TOYOTA	LAND CRUISER	
1989-1991	TOYOTA	PICKUP	
1988-1991	TOYOTA	CAMRY	
1988-1989	TOYOTA	CELICA	
1988-1989	TOYOTA	MR2	
<b>234-4052</b>			<b>B</b>
1992-1995	TOYOTA	4RUNNER	
1992-1995	TOYOTA	PICKUP	
<b>234-4053</b>			<b>D</b>
1988	TOYOTA	PICKUP	
<b>234-4054</b>			<b>C</b>
1989-1992	TOYOTA	CRESSIDA	
<b>234-4055</b>			<b>C</b>
1990-1991	TOYOTA	4RUNNER	
1989-1991	TOYOTA	PICKUP	
1988-1989	TOYOTA	VAN	
1988	TOYOTA	VAN WAGON	
<b>234-4056</b>			<b>D</b>
1990-1991	TOYOTA	4RUNNER	
1989-1991	TOYOTA	PICKUP	
1988-1989	TOYOTA	LAND CRUISER	
1988-1989	TOYOTA	MR2	
<b>234-4057</b>			<b>D</b>
1994-1996	MERCEDES-BENZ	C280	
1994-1995	MERCEDES-BENZ	E420	
1994-1995	MERCEDES-BENZ	S420	
1994-1995	MERCEDES-BENZ	S500	
1994-1995	MERCEDES-BENZ	SL500	
1994	MERCEDES-BENZ	E500	
1992-1993	MERCEDES-BENZ	500SEL	
1993	MERCEDES-BENZ	300E	
1993	MERCEDES-BENZ	300SE	
1993	MERCEDES-BENZ	400E	
1993	MERCEDES-BENZ	400SEL	

#PART PIECE PARTE	MFR / MARQUE FABRICANTE	MODEL MODELE MODELO	
<b>234-4057 (CONT.)</b>			<b>D</b>
1993	MERCEDES-BENZ	500E	
1993	MERCEDES-BENZ	500SEC	
1993	MERCEDES-BENZ	500SL	
1992	MERCEDES-BENZ	400SE	
<b>234-4058</b>			<b>C</b>
1995-1996	MERCEDES-BENZ	C36 AMG	
1994-1996	MERCEDES-BENZ	C220	
1994-1995	MERCEDES-BENZ	S320	
<b>234-4059</b>			<b>C</b>
1990-1992	GEO	PRIZM	
1988-1991	TOYOTA	COROLLA	
<b>234-4060</b>			<b>C</b>
1993	ASUNA	SUNRUNNER	
1998	CHEVROLET	TRACKER	
1993-1997	GEO	TRACKER	
1994-1997	PONTIAC	SUNRUNNER	
1995-2002	SUZUKI	ESTEEM	
1996-1998	SUZUKI	X-90	
1992-1998	SUZUKI	SIDEKICK	
<b>234-4061</b>			<b>A</b>
1998-2002	CHEVROLET	PRIZM	
1995-1997	GEO	PRIZM	
1995-2004	TOYOTA	AVALON	
1995-2002	TOYOTA	COROLLA	
1995-1999	TOYOTA	PASEO	
1995-1999	TOYOTA	TERCEL	
<b>234-4062</b>			<b>D</b>
1993	ASUNA	SUNFIRE	
1992-1993	GEO	STORM	
1994-1995	HONDA	PASSPORT	
1993-1995	ISUZU	RODEO	
1992-1995	ISUZU	TROOPER	
1992	ISUZU	IMPULSE	
1992	ISUZU	STYLUS	
<b>234-4063</b>			<b>C</b>
2001	HONDA	PASSPORT	
2002-2003	ISUZU	AXIOM	
2000-2002	ISUZU	TROOPER	
2001	ISUZU	RODEO	
2001	ISUZU	RODEO SPORT	
2004-2006	PONTIAC	GTO	
<b>234-4064</b>			<b>C</b>
2007-2014	LEXUS	ES350	
2010-2013	LEXUS	GX460	
2004-2006	LEXUS	ES330	
2002-2003	LEXUS	ES300	
2005-2014	TOYOTA	AVALON	
2002-2014	TOYOTA	CAMRY	
2010	TOYOTA	4RUNNER	
2004-2008	TOYOTA	SOLARA	

#PART PIECE PARTE	MFR / MARQUE FABRICANTE	MODEL MODELE MODELO	
<b>234-4065</b>			<b>A</b>
1996-2003	ACURA	RL	
1996-1999	ACURA	TL	
1991-1999	ACURA	NSX	
1991-1995	ACURA	LEGEND	
1996-2000	HONDA	CIVIC	
1996-1997	HONDA	CIVIC DEL SOL	
1995-1997	HONDA	ACCORD	
<b>234-4066</b>			<b>A</b>
2006-2011	CHEVROLET	HHR	
2005-2010	CHEVROLET	COBALT	
2007-2010	PONTIAC	G5	
2005-2006	PONTIAC	PURSUIT	
2006-2007	SATURN	VUE	
2005-2007	SATURN	ION	
2004	SATURN	L300	
2002-2003	SATURN	L200	
2002-2003	SATURN	LW200	
2002-2003	SATURN	VUE	
2000-2002	SATURN	SC1	
2000-2002	SATURN	SC2	
2000-2002	SATURN	SL	
2000-2002	SATURN	SL1	
2000-2002	SATURN	SL2	
2002	SATURN	L100	
2000-2001	SATURN	SW2	
<b>234-4067</b>			<b>D</b>
1993-1997	FORD	PROBE	
1993-2000	MAZDA	626	
1993-1997	MAZDA	MX-6	
1992-1995	MAZDA	929	
<b>234-4068</b>			<b>D</b>
1993-1996	FORD	PROBE	
1993-2000	MAZDA	626	
1993-1997	MAZDA	MX-6	
1992-1995	MAZDA	929	
<b>234-4069</b>			<b>C</b>
2004-2006	SCION	XA	
2004-2006	SCION	XB	
2006-2014	TOYOTA	YARIS	
2000-2005	TOYOTA	ECHO	
<b>234-4070</b>			<b>A</b>
1990-2011	FORD	RANGER	
1996-2000	FORD	EXPLORER	
1990-1997	FORD	AEROSTAR	
1990-1997	FORD	F-250	
1990-1997	FORD	F-350	
1990-1996	FORD	E-350 VAN	
1990-1996	FORD	F-150	
1996	FORD	BRONCO	
1996	FORD	E-150 VAN	
1996	FORD	E-250 VAN	





#PART PIECE PARTE	MFR/ MARQUE FABRICANTE	MODEL MODELE MODELO
<b>234-4070 (CONT.) A</b>		
1996	FORD	ECONOLINE SUPER
1992-1994	FORD	EXPLORER
1990-1994	FORD	E-250 VAN
1992-1993	FORD	ESCORT
1990-1992	FORD	BRONCO
1990	FORD	E-150 VAN
2004-2010	MAZDA	B2300
1994-2006	MAZDA	B3000
1994-2006	MAZDA	B4000
1998-2001	MAZDA	B2500
1991-1994	MAZDA	NAVAJO
1998	MERCURY	MOUNTAINEER
1992-1993	MERCURY	TRACER
<b>234-4071 A</b>		
1997-2011	FORD	RANGER
1996-2005	FORD	EXPLORER
2001-2003	FORD	EXPLORER SPORT
1995-2003	FORD	WINDSTAR
1991-2001	FORD	E-150 VAN
1991-2001	FORD	E-250 VAN
2001	FORD	MUSTANG
1991-2000	FORD	F-150
1998-1999	FORD	E-350 VAN
1998-1999	FORD	ECONOLINE SUPER
1991-1999	FORD	F-250
1999	FORD	E-350 SUPER DUTY
1999	FORD	F-250 SUPER DUTY
1999	FORD	F-350 SUPER DUTY
1999	FORD	MUSTANG
1997-1998	FORD	EXPEDITION
1996-1997	FORD	F-350
1991-1996	FORD	BRONCO
1991-1996	FORD	E-350 VAN
1996	FORD	ECONOLINE SUPER
1992-1995	FORD	AEROSTAR
2000-2002	JAGUAR	S-TYPE
1998	LINCOLN	NAVIGATOR
2001-2010	MAZDA	B2300
1997-2010	MAZDA	B4000
1998-2008	MAZDA	B3000
1999-2001	MAZDA	B2500
2004-2005	MERCURY	MOUNTAINEER
1997-2002	MERCURY	MOUNTAINEER
<b>234-4072 C</b>		
1992-1995	TOYOTA	PICKUP
1991-1995	TOYOTA	PREVIA
1992-1993	TOYOTA	CELICA
1992	TOYOTA	4RUNNER
<b>234-4073 C</b>		
2007-2008	DODGE	SPRINTER 2500
2007-2008	DODGE	SPRINTER 3500

#PART PIECE PARTE	MFR/ MARQUE FABRICANTE	MODEL MODELE MODELO
<b>234-4073 (CONT.) C</b>		
2007-2008	FREIGHTLINER	SPRINTER 2500
2007-2008	FREIGHTLINER	SPRINTER 3500
<b>234-4074 B</b>		
1998-2003	HONDA	CIVIC
<b>234-4075 D</b>		
1996-2000	CHRYSLER	SEBRING
1997-2000	DODGE	AVENGER
<b>234-4076 A</b>		
1997-2000	CHRYSLER	SEBRING
1996-2002	DODGE	VIPER
1997-2000	DODGE	AVENGER
1997-2000	DODGE	RAM 2500 PICKUP
1997-2000	DODGE	RAM 3500 PICKUP
1998-1999	DODGE	DAKOTA
1997-1999	DODGE	RAM 1500 PICKUP
1996	DODGE	CARAVAN
1996	DODGE	GRAND CARAVAN
1995	DODGE	RAM 1500 PICKUP
1995	DODGE	RAM 2500 PICKUP
1995	DODGE	RAM 3500 PICKUP
1997-1998	EAGLE	TALON
1996-2001	JEEP	CHEROKEE
1996-2000	JEEP	GRAND CHEROKEE
1997-1999	JEEP	TJ
1997-1999	JEEP	WRANGLER
1997-1999	MITSUBISHI	ECLIPSE
1996	PLYMOUTH	GRAND VOYAGER
1996	PLYMOUTH	VOYAGER
<b>234-4077 A</b>		
1997-2000	CHRYSLER	SEBRING
1995-2000	CHRYSLER	TOWN & COUNTRY
2000	CHRYSLER	GRAND VOYAGER
2000	CHRYSLER	VOYAGER
1994-1997	CHRYSLER	LHS
1993-1997	CHRYSLER	CONCORDE
1993-1997	CHRYSLER	INTREPID
1997	CHRYSLER	CIRRUS
1994-1996	CHRYSLER	NEW YORKER
1996-2001	DODGE	RAM 1500 PICKUP
1996-2001	DODGE	RAM 2500 PICKUP
1996-2001	DODGE	RAM 3500 PICKUP
1999-2000	DODGE	RAM 1500 VAN
1999-2000	DODGE	RAM 2500 VAN
1999-2000	DODGE	RAM 3500 VAN
1998-2000	DODGE	AVENGER
1998-2000	DODGE	DURANGO
1996-2000	DODGE	DAKOTA
1995-2000	DODGE	CARAVAN
1995-2000	DODGE	GRAND CARAVAN
1997-1999	DODGE	NEON
1996-1998	DODGE	B1500 VAN

#PART PIECE PARTE	MFR/ MARQUE FABRICANTE	MODEL MODELE MODELO
<b>234-4077 (CONT.) A</b>		
1996-1998	DODGE	B2500 VAN
1996-1998	DODGE	B3500 VAN
1993-1997	DODGE	INTREPID
1997	DODGE	STRATUS
1993-1997	EAGLE	VISION
1997-2001	JEEP	CHEROKEE
1999-2000	JEEP	TJ
1999-2000	JEEP	WRANGLER
1996-1999	JEEP	GRAND CHEROKEE
1997	JEEP	TJ
1997	JEEP	WRANGLER
1995-2000	PLYMOUTH	GRAND VOYAGER
1995-2000	PLYMOUTH	VOYAGER
1997-1999	PLYMOUTH	NEON
1999	PLYMOUTH	PROWLER
1997	PLYMOUTH	BREEZE
1997	PLYMOUTH	PROWLER
<b>234-4078 A</b>		
2001-2004	CHRYSLER	SEBRING
1999-2004	CHRYSLER	300M
1998-2004	CHRYSLER	CONCORDE
1998-2004	CHRYSLER	INTREPID
2001-2002	CHRYSLER	PROWLER
2000-2002	CHRYSLER	NEON
1999-2001	CHRYSLER	LHS
1999-2000	CHRYSLER	CIRRUS
1998	CHRYSLER	SEBRING
1998-2004	DODGE	INTREPID
1998-2004	DODGE	STRATUS
2000-2002	DODGE	NEON
1998-2000	DODGE	DURANGO
1997-2000	DODGE	DAKOTA
1996-1997	DODGE	B3500 VAN
1997	DODGE	B1500 VAN
1997	DODGE	B2500 VAN
1996-2001	JEEP	CHEROKEE
1997-2000	JEEP	TJ
1997-2000	JEEP	WRANGLER
1994-2000	JEEP	GRAND CHEROKEE
2000-2001	PLYMOUTH	NEON
1999-2001	PLYMOUTH	PROWLER
1998-2000	PLYMOUTH	BREEZE
1997	PLYMOUTH	PROWLER
<b>234-4079 A</b>		
1998-2004	CHRYSLER	SEBRING
1998-2000	CHRYSLER	CIRRUS
1998-2004	DODGE	STRATUS
1995-2002	DODGE	VIPER
1996-2001	DODGE	RAM 2500 PICKUP
1996-2001	DODGE	RAM 3500 PICKUP
1999-2000	DODGE	RAM 1500 VAN



#PART PIECE PARTE	MFR / MARQUE FABRICANTE	MODEL MODELE MODELO	
<b>234-4079 (CONT.)</b>			<b>A</b>
1999-2000	DODGE	RAM 2500 VAN	
1999-2000	DODGE	RAM 3500 VAN	
1996-2000	DODGE	RAM 1500 PICKUP	
1996-1999	DODGE	DAKOTA	
1996-1998	DODGE	B3500 VAN	
1998	DODGE	B1500 VAN	
1998	DODGE	B2500 VAN	
1996	DODGE	B1500 VAN	
1996	DODGE	B2500 VAN	
1999-2000	JEEP	GRAND CHEROKEE	
2000	JEEP	TJ	
2000	JEEP	WRANGLER	
1998-2000	PLYMOUTH	BREEZE	
<b>234-4080</b>			<b>D</b>
2001-2004	CHEVROLET	TRACKER	
2001-2005	SUZUKI	GRAND VITARA	
2004	SUZUKI	VITARA	
<b>234-4081</b>			<b>C</b>
1993-1995	DODGE	COLT	
1993-1996	EAGLE	SUMMIT	
1993-1996	MITSUBISHI	MIRAGE	
1993-1995	PLYMOUTH	COLT	
<b>234-4082</b>			<b>D</b>
1996-2000	CHRYSLER	TOWN & COUNTRY	
2000	CHRYSLER	GRAND VOYAGER	
2000	CHRYSLER	VOYAGER	
1996-2000	DODGE	CARAVAN	
1996-2000	DODGE	GRAND CARAVAN	
1996-2000	PLYMOUTH	GRAND VOYAGER	
1996-2000	PLYMOUTH	VOYAGER	
<b>234-4083</b>			<b>D</b>
1995-1999	CHRYSLER	SEBRING	
1995-1999	DODGE	AVENGER	
1995-1998	EAGLE	TALON	
1995-1999	MITSUBISHI	ECLIPSE	
<b>234-4084</b>			<b>B</b>
2002-2006	SUZUKI	XL-7	
2001	SUZUKI	GRAND VITARA	
1999-2000	SUZUKI	VITARA	
<b>234-4086</b>			<b>C</b>
1990-1991	MAZDA	929	
<b>234-4087</b>			<b>A</b>
2002-2004	BUICK	RENDEZVOUS	
1996-2004	BUICK	CENTURY	
1996-2003	BUICK	LESABRE	
1996-2003	BUICK	PARK AVENUE	
1996-2003	BUICK	REGAL	
1996-1999	BUICK	RIVIERA	
2000-2004	CHEVROLET	IMPALA	
1997-2004	CHEVROLET	VENTURE	
1996-2004	CHEVROLET	MONTE CARLO	

#PART PIECE PARTE	MFR / MARQUE FABRICANTE	MODEL MODELE MODELO	
<b>234-4087 (CONT.)</b>			<b>A</b>
1997-2003	CHEVROLET	S10	
1996-2002	CHEVROLET	CAMARO	
1996-2001	CHEVROLET	LUMINA	
1996	CHEVROLET	LUMINA APV	
1997-2003	GMC	SONOMA	
1997-2000	ISUZU	HOMBRE	
1996-2004	OLDSMOBILE	SILHOUETTE	
1998-1999	OLDSMOBILE	INTRIGUE	
1996-1999	OLDSMOBILE	88	
1996-1999	OLDSMOBILE	AURORA	
1996-1999	OLDSMOBILE	LSS	
1997-1998	OLDSMOBILE	REGENCY	
1996-1997	OLDSMOBILE	CUTLASS SUPREME	
1996	OLDSMOBILE	98	
1996	OLDSMOBILE	CUTLASS CIERA	
2001-2004	PONTIAC	AZTEK	
1999-2004	PONTIAC	MONTANA	
1996-2003	PONTIAC	BONNEVILLE	
1996-2003	PONTIAC	GRAND PRIX	
1996-2002	PONTIAC	FIREBIRD	
1996-1999	PONTIAC	TRANS SPORT	
<b>234-4088</b>			<b>C</b>
1987-1988	BMW	325I	
1987-1988	BMW	325IS	
1988	BMW	325IX	
1988	BMW	528E	
<b>234-4089</b>			<b>C</b>
1999-2001	CHEVROLET	CAVALIER	
1999-2001	PONTIAC	SUNFIRE	
<b>234-4090</b>			<b>D</b>
2001	SATURN	L100	
2001	SATURN	L200	
2001	SATURN	LW200	
2000	SATURN	LS	
2000	SATURN	LS1	
2000	SATURN	LW1	
<b>234-4092</b>			<b>A</b>
1995-1999	ACURA	NSX	
2001-2005	HONDA	CIVIC	
1997-2001	HONDA	PRELUDE	
1996-1998	HONDA	ODYSSEY	
1996-1999	ISUZU	OASIS	
<b>234-4093</b>			<b>D</b>
1991-2005	ACURA	NSX	
1996-2003	ACURA	RL	
1996-1998	ACURA	TL	
1991-1995	ACURA	LEGEND	
<b>234-4094</b>			<b>A</b>
1999-2004	HONDA	ODYSSEY	
2000	HONDA	INSIGHT	
1992-1995	HONDA	PRELUDE	

#PART PIECE PARTE	MFR / MARQUE FABRICANTE	MODEL MODELE MODELO	
<b>234-4095</b>			<b>A</b>
1997-1999	ACURA	CL	
1995-1998	HONDA	ODYSSEY	
1990-1997	HONDA	ACCORD	
1996	HONDA	PRELUDE	
1990-1991	HONDA	PRELUDE	
1996-1999	ISUZU	OASIS	
<b>234-4097</b>			<b>B</b>
1996-2004	ACURA	RL	
1995-1998	ACURA	TL	
<b>234-4098</b>			<b>B</b>
1999-2000	ACURA	EL	
1997-2001	HONDA	CR-V	
1999-2000	HONDA	CIVIC	
<b>234-4099</b>			<b>A</b>
1997-1999	ACURA	CL	
1995-1999	ACURA	NSX	
1997-1998	ACURA	EL	
1992-1993	ACURA	INTEGRA	
1999-2000	HONDA	ODYSSEY	
1992-2000	HONDA	CIVIC	
1998-1999	HONDA	ACCORD	
1993-1997	HONDA	CIVIC DEL SOL	
<b>234-4100</b>			<b>C</b>
1997-1999	ACURA	NSX	
<b>234-4102</b>			<b>D</b>
2001-2002	CHEVROLET	SILVERADO 2500 HD	
2001-2002	CHEVROLET	SILVERADO 3500	
2001-2002	CHEVROLET	SUBURBAN 2500	
2002	CHEVROLET	AVALANCHE 2500	
2001-2002	GMC	SIERRA 2500 HD	
2001-2002	GMC	SIERRA 3500	
2001-2002	GMC	YUKON XL 2500	
<b>234-4103</b>			<b>A</b>
2008-2009	BUICK	ALLURE	
2008-2009	BUICK	LACROSSE	
2002	CADILLAC	ESCALADE	
2002	CADILLAC	ESCALADE EXT	
2001-2002	CHEVROLET	EXPRESS 3500	
2001-2002	CHEVROLET	SILVERADO 1500 HD	
2001-2002	CHEVROLET	SILVERADO 2500	
2001-2002	CHEVROLET	SILVERADO 2500 HD	
2001-2002	CHEVROLET	SILVERADO 3500	
2001-2002	CHEVROLET	SUBURBAN 2500	
2002	CHEVROLET	AVALANCHE 2500	
2000	CHEVROLET	C2500 TRUCK	
2000	CHEVROLET	C3500 TRUCK	
2000	CHEVROLET	K2500 TRUCK	
2000	CHEVROLET	K3500 TRUCK	
2001-2002	GMC	SAVANA 3500	
2001-2002	GMC	SIERRA 1500	
2001-2002	GMC	SIERRA 1500 HD	



#PART PIECE PARTE	MFR/ MARQUE FABRICANTE	MODEL MODELE MODELO
<b>234-4103 (CONT.) A</b>		
2001-2002	GMC	SIERRA 2500
2001-2002	GMC	SIERRA 2500 HD
2001-2002	GMC	SIERRA 3500
2001-2002	GMC	YUKON
2001-2002	GMC	YUKON XL 1500
2001-2002	GMC	YUKON XL 2500
2000	GMC	C25/C2500 PICKUP
2000	GMC	C35/C3500 PICKUP
2000	GMC	K25/K2500 TRUCK
2000	GMC	K35/K3500 TRUCK
2008	PONTIAC	GRAND PRIX
<b>234-4104 D</b>		
2004-2005	CHEVROLET	CLASSIC
2004-2005	CHEVROLET	MALIBU
2004	CHEVROLET	CORVETTE
2002-2004	OLDSMOBILE	ALERO
2002-2005	PONTIAC	GRAND AM
<b>234-4105 D</b>		
2001-2004	CHEVROLET	TRACKER
2002-2007	SUZUKI	AERIO
1999-2005	SUZUKI	GRAND VITARA
2004	SUZUKI	VITARA
2000	SUZUKI	ESTEEM
<b>234-4106 D</b>		
2008-2010	FORD	F-250 SUPER DUTY
2008-2010	FORD	F-350 SUPER DUTY
2007-2009	FORD	FUSION
2009	FORD	ESCAPE
2009	MAZDA	TRIBUTE
2007-2009	MERCURY	MILAN
2009	MERCURY	MARINER
<b>234-4107 C</b>		
2010-2013	FORD	TRANSIT CONNECT
2006-2011	FORD	FOCUS
<b>234-4108 C</b>		
2002-2005	CHEVROLET	CAVALIER
2002-2005	PONTIAC	SUNFIRE
2005	PONTIAC	GRAND AM
<b>234-4112 A</b>		
2007	CADILLAC	ESCALADE
2007	CADILLAC	ESCALADE ESV
2007	CADILLAC	ESCALADE EXT
2006	CADILLAC	CTS
2006-2007	CHEVROLET	SILVERADO 1500
2006-2007	CHEVROLET	TAHOE
2007	CHEVROLET	AVALANCHE
2007	CHEVROLET	SILVERADO 1500
2007	CHEVROLET	SUBURBAN 1500
2007	CHEVROLET	SUBURBAN 2500
2002-2003	CHEVROLET	TRAILBLAZER
2002-2003	CHEVROLET	TRAILBLAZER EXT

#PART PIECE PARTE	MFR/ MARQUE FABRICANTE	MODEL MODELE MODELO
<b>234-4112 (CONT.) A</b>		
2006-2007	GMC	SIERRA 1500
2006-2007	GMC	YUKON
2007	GMC	SIERRA 1500 CLASSIC
2007	GMC	YUKON XL 1500
2007	GMC	YUKON XL 2500
2002-2003	GMC	ENVOY
2002-2003	GMC	ENVOY XL
2007	HUMMER	H2
2003	ISUZU	ASCENDER
2002-2003	OLDSMOBILE	BRAVADA
<b>234-4114 C</b>		
2008-2015	MINI	LANCER
2015	MINI	OUTLANDER SPORT
2015	MINI	RVR
2011-2013	MINI	OUTLANDER SPORT
2011-2013	MINI	RVR
2008-2013	MINI	OUTLANDER
<b>234-4115 C</b>		
2001-2002	CHRYSLER	PT CRUISER
2000	CHRYSLER	NEON
2000	DODGE	NEON
1999-2000	JEEP	GRAND CHEROKEE
2000	JEEP	TJ
2000	JEEP	WRANGLER
2000	PLYMOUTH	NEON
<b>234-4116 D</b>		
2014-2015	MINI	OUTLANDER
2008-2015	MINI	LANCER
2014	MINI	OUTLANDER SPORT
2011-2012	MINI	OUTLANDER SPORT
2008-2010	MINI	OUTLANDER
<b>234-4117 C</b>		
2001-2003	KIA	RIO
2000-2002	MAZDA	626
2004-2005	SUZUKI	FORENZA
2005	SUZUKI	RENO
<b>234-4118 C</b>		
2008-2010	MAZDA	5
<b>234-4119 B</b>		
2004-2005	BUICK	RAINIER
2004-2005	CHEVROLET	COLORADO
2004-2005	CHEVROLET	TRAILBLAZER
2004-2005	CHEVROLET	TRAILBLAZER EXT
2004-2005	GMC	CANYON
2004-2005	GMC	ENVOY
2004-2005	GMC	ENVOY XL
2004-2005	GMC	ENVOY XUV
2004-2005	ISUZU	ASCENDER
2004	OLDSMOBILE	BRAVADA
2005	SAAB	9-7X

#PART PIECE PARTE	MFR/ MARQUE FABRICANTE	MODEL MODELE MODELO
<b>234-4120 C</b>		
2014-2015	AUDI	SQ5
2012-2015	AUDI	A6 QUATTRO
2012-2015	AUDI	A7 QUATTRO
2009-2015	AUDI	Q5
2013-2014	AUDI	A8 QUATTRO
2010-2014	AUDI	S4
2010-2014	AUDI	S5
2008-2010	AUDI	A5 QUATTRO
2009	AUDI	A4 QUATTRO
<b>234-4121 D</b>		
2001-2003	KIA	RIO
2001-2002	MAZDA	MILLENNIA
<b>234-4122 B</b>		
2002-2004	ACURA	RSX
2001-2003	ACURA	EL
2001-2005	HONDA	CIVIC
2000-2002	HONDA	ACCORD
<b>234-4123 D</b>		
2001-2005	HONDA	CIVIC
<b>234-4124 C</b>		
2000-2003	HONDA	S2000
<b>234-4125 D</b>		
2002-2004	HONDA	CR-V
<b>234-4126 D</b>		
2000-2002	MAZDA	626
<b>234-4127 A</b>		
2002-2014	FORD	E-350 SUPER DUTY
1996-2014	FORD	E-150 VAN
1996-2014	FORD	E-250 VAN
2005-2012	FORD	F-250 SUPER DUTY
2005-2011	FORD	F-350 SUPER DUTY
2004-2011	FORD	RANGER
1997-2011	FORD	EXPEDITION
2009-2010	FORD	F-150
2007-2010	FORD	EXPLORER SPORT
2004-2010	FORD	EXPLORER
2004-2005	FORD	E-250 SUPER DUTY
2002-2005	FORD	E-350 VAN
2004	FORD	F-150 HERITAGE
1997-2003	FORD	F-150
2002	FORD	E-450 ECONOLINE
1997-2000	FORD	RANGER
1996-1999	FORD	ECONOLINE SUPER
1994-1999	FORD	E-350 VAN
1994-1999	FORD	F-250
1999	FORD	E-350 SUPER DUTY
1999	FORD	F-250 SUPER DUTY
1999	FORD	F-350 SUPER DUTY
1995-1998	FORD	EXPLORER
1993-1998	FORD	TAURUS
1996-1997	FORD	AEROSTAR



#PART PIECE PARTE	MFR / MARQUE FABRICANTE	MODEL MODELE MODELO	
<b>234-4127 (CONT.)</b>			<b>A</b>
1994-1997	FORD	F-350	
1994-1995	FORD	MUSTANG	
1993-1995	FORD	F-150	
1995	FORD	RANGER	
1998-2011	LINCOLN	NAVIGATOR	
2002	LINCOLN	BLACKWOOD	
2004-2010	MAZDA	B2300	
2004-2010	MAZDA	B4000	
2004-2008	MAZDA	B3000	
1995-2000	MAZDA	B3000	
1995-2000	MAZDA	B4000	
1998	MAZDA	B2500	
1995-1997	MAZDA	B2300	
2004-2010	MERCURY	MOUNTAINEER	
1997-1998	MERCURY	MOUNTAINEER	
<b>234-4128</b>			<b>C</b>
1994-1998	MITSUBISHI	GALANT	
<b>234-4129</b>			<b>D</b>
1999-2000	CHEVROLET	TRACKER	
<b>234-4130</b>			<b>D</b>
1994-1998	MITSUBISHI	GALANT	
<b>234-4131</b>			<b>C</b>
1992-1993	HYUNDAI	ELANTRA	
1992-1993	HYUNDAI	SONATA	
<b>234-4132</b>			<b>C</b>
2003-2006	SUBARU	BAJA	
2000-2004	SUBARU	OUTBACK	
1999-2004	SUBARU	LEGACY	
<b>234-4133</b>			<b>C</b>
1997-2000	MERCEDES-BENZ	C230	
<b>234-4134</b>			<b>C</b>
1998-1999	MERCEDES-BENZ	SLK230	
<b>234-4135</b>			<b>D</b>
1998-2002	MITSUBISHI	MIRAGE	
1994-1998	MITSUBISHI	GALANT	
<b>234-4136</b>			<b>C</b>
2008-2012	LAND ROVER	LR2	
<b>234-4137</b>			<b>A</b>
1997-2001	LEXUS	ES300	
1998-2000	LEXUS	LS400	
1999-2003	TOYOTA	SOLARA	
1997-2001	TOYOTA	CAMRY	
<b>234-4138</b>			<b>B</b>
2002-2010	LEXUS	SC430	
2001-2007	LEXUS	GS430	
2001-2006	LEXUS	LS430	
2003-2005	LEXUS	LX470	
2003-2004	LEXUS	GX470	
2010-2012	TOYOTA	4RUNNER	
2010-2012	TOYOTA	FJ CRUISER	
2003-2005	TOYOTA	LAND CRUISER	

#PART PIECE PARTE	MFR / MARQUE FABRICANTE	MODEL MODELE MODELO	
<b>234-4138 (CONT.)</b>			<b>B</b>
2003-2004	TOYOTA	4RUNNER	
<b>234-4139</b>			<b>D</b>
1998-2000	LEXUS	SC300	
2000-2005	TOYOTA	CELICA	
<b>234-4140</b>			<b>D</b>
1996-1997	KIA	SEPHIA	
1995-1998	MAZDA	PROTEGE	
<b>234-4141</b>			<b>C</b>
2000-2006	MAZDA	MPV	
1996-1998	MAZDA	MPV	
<b>234-4142</b>			<b>D</b>
2002-2006	MAZDA	MPV	
1996-1998	MAZDA	MPV	
<b>234-4143</b>			<b>D</b>
2000-2001	MAZDA	MPV	
1999-2000	MAZDA	PROTEGE	
1992-1995	MAZDA	MX-3	
<b>234-4144</b>			<b>D</b>
1999-2000	MAZDA	MIATA	
1994-1997	MAZDA	MIATA	
1993-1995	MAZDA	323	
1993-1994	MAZDA	PROTEGE	
<b>234-4145</b>			<b>D</b>
1996	MAZDA	MIATA	
<b>234-4146</b>			<b>D</b>
1999-2000	MAZDA	PROTEGE	
<b>234-4147</b>			<b>D</b>
1996-1998	MAZDA	MPV	
<b>234-4148</b>			<b>D</b>
2001-2002	MAZDA	MILLENNIA	
2000-2002	MAZDA	626	
<b>234-4149</b>			<b>B</b>
2009-2013	LEXUS	LS460	
2007-2009	LEXUS	RX350	
2006-2008	LEXUS	RX400H	
2005-2010	SCION	TC	
2006-2013	TOYOTA	HIGHLANDER	
2007-2010	TOYOTA	SIENNA	
2002-2003	TOYOTA	CAMRY	
2002-2003	TOYOTA	SOLARA	
<b>234-4150</b>			<b>D</b>
1988	CHEVROLET	NOVA	
1990-1992	TOYOTA	LAND CRUISER	
1989-1991	TOYOTA	PICKUP	
1988	TOYOTA	COROLLA	
1985-1987	TOYOTA	LAND CRUISER	
<b>234-4151</b>			<b>D</b>
1993-1997	TOYOTA	T100	
1993-1995	TOYOTA	4RUNNER	
1993-1995	TOYOTA	PICKUP	

#PART PIECE PARTE	MFR / MARQUE FABRICANTE	MODEL MODELE MODELO	
<b>234-4152</b>			<b>D</b>
1988-1989	TOYOTA	4RUNNER	
1988	TOYOTA	PICKUP	
<b>234-4153</b>			<b>A</b>
1996-1997	LEXUS	LX450	
1996-2000	TOYOTA	4RUNNER	
1995-2000	TOYOTA	TACOMA	
1994-1998	TOYOTA	T100	
1995-1997	TOYOTA	LAND CRUISER	
1994-1997	TOYOTA	PREVIA	
<b>234-4154</b>			<b>A</b>
1998-2005	LEXUS	LX470	
1998-2005	TOYOTA	LAND CRUISER	
2000-2002	TOYOTA	TUNDRA	
1995-2000	TOYOTA	TACOMA	
1993-2000	TOYOTA	4RUNNER	
1996-1998	TOYOTA	T100	
1993-1995	TOYOTA	PICKUP	
<b>234-4155</b>			<b>D</b>
1999-2000	TOYOTA	4RUNNER	
1994-1997	TOYOTA	PREVIA	
1993-1994	TOYOTA	T100	
<b>234-4156</b>			<b>D</b>
1991-1995	TOYOTA	MR2	
1990-1993	TOYOTA	CELICA	
<b>234-4157</b>			<b>D</b>
1996-1997	LEXUS	LX450	
1995-1997	TOYOTA	LAND CRUISER	
<b>234-4158</b>			<b>C</b>
1990-1991	TOYOTA	CELICA	
<b>234-4159</b>			<b>D</b>
1998-2000	TOYOTA	TACOMA	
<b>234-4160</b>			<b>C</b>
1994-1995	TOYOTA	T100	
1992	TOYOTA	4RUNNER	
1992	TOYOTA	PICKUP	
<b>234-4161</b>			<b>A</b>
2001-2004	TOYOTA	SEQUOIA	
2000-2004	TOYOTA	TUNDRA	
1995-2000	TOYOTA	TACOMA	
1994-2000	TOYOTA	4RUNNER	
1995-1998	TOYOTA	T100	
<b>234-4162</b>			<b>A</b>
2001-2004	TOYOTA	SEQUOIA	
2000-2004	TOYOTA	TUNDRA	
1996-2000	TOYOTA	4RUNNER	
1995-2000	TOYOTA	TACOMA	
1995-1998	TOYOTA	T100	
1994-1995	TOYOTA	PICKUP	
<b>234-4163</b>			<b>A</b>
2001-2003	TOYOTA	SIENNA	



#PART PIECE PARTE	MFR/ MARQUE FABRICANTE	MODEL MODELE MODELO
<b>234-4164</b> C		
1997	HYUNDAI	TIBURON
<b>234-4165</b> C		
2008-2013 2012	SUZUKI SUZUKI	SX4 SX4 CROSSOVER
<b>234-4166</b> D		
2003-2006 2003-2006	HYUNDAI KIA	SANTA FE SORENTO
<b>234-4167</b> D		
2001-2006 2002-2005	LEXUS LEXUS	LS430 SC430
<b>234-4168</b> C		
2004-2006 2008-2015 2004-2007 2004-2006	LEXUS SCION TOYOTA TOYOTA	RX330 XB HIGHLANDER SIENNA
<b>234-4169</b> A		
2008-2015 2013 2008-2011 1998-2002 1998-2000 1996-2000 1995-2000 2013 2008-2011 2010 2001-2004 2000-2004 1998-2002	LEXUS LEXUS LEXUS LEXUS LEXUS LEXUS TOYOTA TOYOTA TOYOTA TOYOTA TOYOTA TOYOTA	LS600H LX570 LX570 LX470 GS400 SC400 LS400 LAND CRUISER LAND CRUISER 4RUNNER SEQUOIA TUNDRA LAND CRUISER
<b>234-4171</b> C		
1996	MERCEDES-BENZ	SL320
<b>234-4172</b> D		
2000-2003 1996-2002 1999-2000 1998-2000 1998-1999 1998-1999 1998-1999 1996-1999 1996-1999 1996-1999 1997 1997 1997 1997	MERCEDES-BENZ MERCEDES-BENZ MERCEDES-BENZ MERCEDES-BENZ MERCEDES-BENZ MERCEDES-BENZ MERCEDES-BENZ MERCEDES-BENZ MERCEDES-BENZ MERCEDES-BENZ MERCEDES-BENZ MERCEDES-BENZ MERCEDES-BENZ MERCEDES-BENZ MERCEDES-BENZ	ML55 AMG SL600 ML430 ML320 CL500 CL600 SLK230 S420 S500 S600 SL500 C36 AMG C280 E420 SL320
<b>234-4173</b> C		
1999-2000 1998-2000 1998-2000	MERCEDES-BENZ MERCEDES-BENZ MERCEDES-BENZ	CLK430 C43 AMG C280

#PART PIECE PARTE	MFR/ MARQUE FABRICANTE	MODEL MODELE MODELO
<b>234-4173 (CONT.)</b> C		
1998-2000	MERCEDES-BENZ	CLK320
<b>234-4174</b> D		
2000-2003 1999-2001 1998-2000 1998-2000 1998-2000 2000 2000 2000 2000 1998-1999 1997-1999 1996-1999 1996-1998 1997	MERCEDES-BENZ MERCEDES-BENZ MERCEDES-BENZ MERCEDES-BENZ MERCEDES-BENZ MERCEDES-BENZ MERCEDES-BENZ MERCEDES-BENZ MERCEDES-BENZ MERCEDES-BENZ MERCEDES-BENZ MERCEDES-BENZ MERCEDES-BENZ MERCEDES-BENZ	ML55 AMG E55 AMG E320 E430 ML320 CL500 ML430 S430 S500 CL600 S320 S600 SL500 SL320
<b>234-4175</b> D		
1999-2002 1999-2001 1998-2000 1998-2000 1997-2000 1997-2000 1996-2000 2000 1997-1999 1996-1999 1997 1997 1997	MERCEDES-BENZ MERCEDES-BENZ MERCEDES-BENZ MERCEDES-BENZ MERCEDES-BENZ MERCEDES-BENZ MERCEDES-BENZ MERCEDES-BENZ MERCEDES-BENZ MERCEDES-BENZ MERCEDES-BENZ MERCEDES-BENZ MERCEDES-BENZ	SL500 E55 AMG CL500 E430 C230 E320 S500 S430 S320 S420 C36 AMG C280 E420
<b>234-4176</b> C		
1996 1996	MERCEDES-BENZ MERCEDES-BENZ	E320 S320
<b>234-4177</b> C		
1995-1996	MERCEDES-BENZ	S320
<b>234-4178</b> C		
1999-2000 1998-2000 1998-2000 1998-2000	MERCEDES-BENZ MERCEDES-BENZ MERCEDES-BENZ MERCEDES-BENZ	CLK430 C43 AMG C280 CLK320
<b>234-4179</b> C		
1999-2000 1998-2000 1998-2000 1998-2000	MERCEDES-BENZ MERCEDES-BENZ MERCEDES-BENZ MERCEDES-BENZ	CLK430 C43 AMG C280 CLK320
<b>234-4180</b> C		
2001-2006 2001-2002 2000-2002 1999-2000 1998-2000	BMW BMW MERCEDES-BENZ MERCEDES-BENZ MERCEDES-BENZ	M3 Z3 SL500 CLK430 C43 AMG

#PART PIECE PARTE	MFR/ MARQUE FABRICANTE	MODEL MODELE MODELO
<b>234-4180 (CONT.)</b> C		
1998-2000 1998-2000 1996-1998	MERCEDES-BENZ MERCEDES-BENZ MERCEDES-BENZ	C280 CLK320 SL500
<b>234-4181</b> C		
1996-1997	SAAB	900
<b>234-4182</b> D		
1999-2001 1996-1997 1996-1998 1996-1997 1993-1995	PORSCHE PORSCHE SAAB SAAB VOLVO	911 911 9000 900 850
<b>234-4183</b> C		
1999 1996-1997 1996-1997	SAAB SAAB SAAB	9-5 900 9000
<b>234-4184</b> D		
1995-1999 1999 1999 1996-1998	PORSCHE SAAB SAAB SAAB	911 9-3 9-5 900
<b>234-4185</b> D		
1994-1998 1999 1996-1998 1996-1998	PORSCHE SAAB SAAB SAAB	911 9-3 900 9000
<b>234-4186</b> C		
1997-2002	PORSCHE	BOXSTER
<b>234-4187</b> D		
2003-2005	LINCOLN	AVIATOR
<b>234-4188</b> C		
2008-2010	MITSUBISHI	LANCER
<b>234-4189</b> A		
2000-2004	TOYOTA	TACOMA
<b>234-4190</b> D		
2004-2005 2003-2008	KIA MAZDA	RIO 6
<b>234-4191</b> B		
2005-2009 2003-2008 2003-2006 2002-2005 2005-2010 2002-2006 2002-2006	HYUNDAI HYUNDAI HYUNDAI HYUNDAI KIA KIA KIA	TUCSON TIBURON SANTA FE SONATA SPORTAGE MAGENTIS OPTIMA
<b>234-4192</b> D		
2005-2009 2003-2008 2003-2006 2002-2005 2005-2010 2002-2006	HYUNDAI HYUNDAI HYUNDAI HYUNDAI KIA KIA	TUCSON TIBURON SANTA FE SONATA SPORTAGE MAGENTIS



#PART PIECE PARTE	MFR / MARQUE FABRICANTE	MODEL MODELE MODELO	
<b>234-4192 (CONT.)</b>			<b>D</b>
2002-2006	KIA	OPTIMA	
<b>234-4193</b>			<b>C</b>
2005-2009	HYUNDAI	TUCSON	
2003-2008	HYUNDAI	TIBURON	
2003-2006	HYUNDAI	SANTA FE	
2002-2005	HYUNDAI	SONATA	
2005-2010	KIA	SPORTAGE	
2002-2006	KIA	MAGENTIS	
2002-2006	KIA	OPTIMA	
<b>234-4194</b>			<b>B</b>
2003-2009	HYUNDAI	SANTA FE	
2002-2005	HYUNDAI	XG350	
2007-2012	KIA	RONDO	
2007-2010	KIA	MAGENTIS	
2006-2010	KIA	OPTIMA	
2004-2006	KIA	AMANTI	
2003-2006	KIA	SORENTO	
2002-2005	KIA	SEDONA	
<b>234-4195</b>			<b>C</b>
2015	SUBARU	LEGACY	
2013-2014	SUBARU	WRX	
2008-2014	SUBARU	IMPREZA	
2009-2013	SUBARU	FORESTER	
<b>234-4197</b>			<b>C</b>
2004	NISSAN	FRONTIER	
2004	NISSAN	XTERRA	
<b>234-4198</b>			<b>C</b>
2004	NISSAN	FRONTIER	
2004	NISSAN	XTERRA	
<b>234-4199</b>			<b>D</b>
2003-2006	HYUNDAI	SANTA FE	
2003-2005	HYUNDAI	XG350	
2004-2006	KIA	AMANTI	
<b>234-4200</b>			<b>C</b>
1997-2000	AUDI	A4 QUATTRO	
1998-1999	AUDI	A6	
1998-1999	AUDI	A6 QUATTRO	
1997-1999	AUDI	A4	
1997-1999	AUDI	A8	
1997-1999	AUDI	A8 QUATTRO	
1994-1995	BMW	530I	
1994-1995	BMW	540I	
1994-1995	BMW	840CI	
1994-1995	BMW	850CSI	
1994-1995	BMW	M3	
1993-1995	BMW	740I	
1993-1995	BMW	740IL	
1991-1995	BMW	318I	
1991-1995	BMW	318IS	
1989-1995	BMW	525I	
1988-1995	BMW	325I	

#PART PIECE PARTE	MFR / MARQUE FABRICANTE	MODEL MODELE MODELO	
<b>234-4200 (CONT.)</b>			<b>C</b>
1988-1995	BMW	325IS	
1995	BMW	318TI	
1993-1994	BMW	850CI	
1988-1994	BMW	750IL	
1993	BMW	525IT	
1991-1992	BMW	850I	
1988-1991	BMW	325IX	
1995-1996	MERCEDES-BENZ	S320	
1996	MERCEDES-BENZ	E320	
1999-2001	VOLKSWAGEN	EUROVAN	
1995-1999	VOLKSWAGEN	JETTA	
1995-1999	VOLKSWAGEN	PASSAT	
1995-1998	VOLKSWAGEN	GOLF	
1997	VOLKSWAGEN	EUROVAN	
1993-1994	VOLVO	850	
<b>234-4201</b>			<b>D</b>
1996-2000	AUDI	A4 QUATTRO	
1997-1999	AUDI	A8	
1997-1999	AUDI	A8 QUATTRO	
1996-1999	AUDI	A4	
1996-1999	AUDI	A6	
1996-1999	AUDI	A6 QUATTRO	
1994-1998	AUDI	CABRIOLET	
1994	AUDI	100 QUATTRO	
1994	AUDI	100 SERIES	
2006-2010	BMW	M5	
2006-2010	BMW	M6	
2007-2008	BMW	ALPINA B7	
2003-2008	BMW	Z4	
2004-2006	BMW	760I	
2004-2006	BMW	X3	
2003-2006	BMW	760LI	
2001-2006	BMW	325CI	
2001-2006	BMW	330CI	
2001-2006	BMW	M3	
2000-2006	BMW	X5	
2004-2005	BMW	545I	
2004-2005	BMW	645CI	
2002-2005	BMW	745I	
2002-2005	BMW	745LI	
2001-2005	BMW	320I	
2001-2005	BMW	325I	
2001-2005	BMW	325XI	
2001-2005	BMW	330I	
2001-2005	BMW	330XI	
2001-2005	BMW	525I	
2001-2005	BMW	530I	
2000-2003	BMW	M5	
2000-2003	BMW	Z8	
1997-2003	BMW	540I	
1996-2002	BMW	Z3	

#PART PIECE PARTE	MFR / MARQUE FABRICANTE	MODEL MODELE MODELO	
<b>234-4201 (CONT.)</b>			<b>D</b>
1997-2001	BMW	740I	
1996-2001	BMW	740IL	
1995-2001	BMW	750IL	
1999-2000	BMW	323I	
1999-2000	BMW	328I	
1999-2000	BMW	528I	
2000	BMW	323CI	
2000	BMW	328CI	
1996-1999	BMW	318I	
1996-1999	BMW	318IS	
1996-1999	BMW	318TI	
1996-1997	BMW	840CI	
1995-1997	BMW	850CI	
1997-1998	CADILLAC	CATERA	
1997-2001	HYUNDAI	TIBURON	
1996-2000	HYUNDAI	ELANTRA	
1995-1999	HYUNDAI	ACCENT	
2000-2002	KIA	SPECTRA	
1996-2002	KIA	SPORTAGE	
1998-2001	KIA	SEPHIA	
2002-2005	LAND ROVER	FREELANDER	
1999-2005	LAND ROVER	RANGE ROVER	
1999-2004	LAND ROVER	DISCOVERY	
2000-2003	MERCEDES-BENZ	ML55 AMG	
1996-2002	MERCEDES-BENZ	SL500	
1996-2002	MERCEDES-BENZ	SL600	
1999-2001	MERCEDES-BENZ	E55 AMG	
1999-2000	MERCEDES-BENZ	CLK430	
1999-2000	MERCEDES-BENZ	ML430	
1998-2000	MERCEDES-BENZ	C43 AMG	
1998-2000	MERCEDES-BENZ	CL500	
1998-2000	MERCEDES-BENZ	CLK320	
1998-2000	MERCEDES-BENZ	E430	
1998-2000	MERCEDES-BENZ	ML320	
1997-2000	MERCEDES-BENZ	C230	
1997-2000	MERCEDES-BENZ	C280	
1997-2000	MERCEDES-BENZ	E320	
1996-2000	MERCEDES-BENZ	S500	
2000	MERCEDES-BENZ	S430	
1998-1999	MERCEDES-BENZ	CL600	
1998-1999	MERCEDES-BENZ	SLK230	
1997-1999	MERCEDES-BENZ	S320	
1996-1999	MERCEDES-BENZ	S420	
1996-1999	MERCEDES-BENZ	S600	
1996-1997	MERCEDES-BENZ	SL320	
1997	MERCEDES-BENZ	C36 AMG	
1997	MERCEDES-BENZ	E420	
1997-2002	PORSCHE	BOXSTER	
1994-2001	PORSCHE	911	
2004-2007	ROLLS-ROYCE	PHANTOM	
1999	SAAB	9-3	



#PART PIECE PARTE	MFR/ MARQUE FABRICANTE	MODEL MODELE MODELO	
<b>234-4201 (CONT.)</b>			<b>D</b>
1999	SAAB	9-5	
1996-1998	SAAB	900	
1996-1998	SAAB	9000	
1999-2001	VOLKSWAGEN	EUROVAN	
1993-2001	VOLKSWAGEN	PASSAT	
1995-1999	VOLKSWAGEN	CABRIO	
1993-1999	VOLKSWAGEN	GOLF	
1993-1999	VOLKSWAGEN	JETTA	
1997	VOLKSWAGEN	EUROVAN	
1992-1995	VOLKSWAGEN	CORRADO	
1997-1998	VOLVO	S90	
1997-1998	VOLVO	V90	
1998	VOLVO	C70	
1998	VOLVO	S70	
1998	VOLVO	V70	
1995-1997	VOLVO	960	
1993-1997	VOLVO	850	
<b>234-4202</b>			<b>C</b>
1988	TOYOTA	SUPRA	
<b>234-4204</b>			<b>C</b>
1989-1992	TOYOTA	SUPRA	
<b>234-4205</b>			<b>A</b>
1998-2002	CHEVROLET	PRIZM	
1998-2002	TOYOTA	COROLLA	
<b>234-4206</b>			<b>C</b>
1998-2005	LEXUS	LX470	
1999-2003	LEXUS	RX300	
1996-1997	LEXUS	LX450	
1992-1997	LEXUS	SC300	
1995-2005	TOYOTA	LAND CRUISER	
2001-2004	TOYOTA	SEQUOIA	
2000-2004	TOYOTA	TUNDRA	
1995-2004	TOYOTA	TACOMA	
2001-2003	TOYOTA	HIGHLANDER	
2001-2003	TOYOTA	SIENNA	
1998-2000	TOYOTA	RAV4	
1993-2000	TOYOTA	4RUNNER	
1993-1998	TOYOTA	SUPRA	
1993-1998	TOYOTA	T100	
1994-1997	TOYOTA	PREVIA	
1993-1995	TOYOTA	PICKUP	
<b>234-4207</b>			<b>C</b>
1998-2002	CHEVROLET	PRIZM	
1998-2002	TOYOTA	COROLLA	
<b>234-4208</b>			<b>C</b>
1990-1992	GEO	PRIZM	
1988-1992	TOYOTA	SUPRA	
1988-1991	TOYOTA	COROLLA	
<b>234-4209</b>			<b>A</b>
1997-2005	ACURA	EL	
1991-2005	ACURA	NSX	

#PART PIECE PARTE	MFR/ MARQUE FABRICANTE	MODEL MODELE MODELO	
<b>234-4209 (CONT.)</b>			<b>A</b>
1996-2004	ACURA	RL	
2001-2003	ACURA	CL	
1995-2003	ACURA	TL	
2001-2002	ACURA	MDX	
1992-2001	ACURA	INTEGRA	
1997-1999	ACURA	CL	
1991-1995	ACURA	LEGEND	
1992-1994	ACURA	VIGOR	
1993	ASUNA	SUNFIRE	
1993	ASUNA	SUNRUNNER	
2005-2009	BUICK	ALLURE	
2005-2009	BUICK	LACROSSE	
2006-2008	BUICK	LUCERNE	
2005-2007	BUICK	TERRAZA	
2002-2007	BUICK	RENDEZVOUS	
2004-2005	BUICK	LESABRE	
2004-2005	BUICK	PARK AVENUE	
2004-2005	BUICK	RAINIER	
2001-2005	BUICK	CENTURY	
2004	BUICK	REGAL	
2004-2007	CADILLAC	CTS	
2007	CADILLAC	ESCALADE	
2007	CADILLAC	ESCALADE ESV	
2007	CADILLAC	ESCALADE EXT	
2001-2003	CADILLAC	SEVILLE	
2000-2003	CADILLAC	DEVILLE	
2001-2002	CADILLAC	ELDORADO	
2002	CADILLAC	ESCALADE	
2002	CADILLAC	ESCALADE EXT	
2006-2011	CHEVROLET	HHR	
2005-2010	CHEVROLET	COBALT	
2006-2007	CHEVROLET	SILVERADO 1500	
2006-2007	CHEVROLET	TAHOE	
2005-2007	CHEVROLET	EQUINOX	
2005-2007	CHEVROLET	UPLANDER	
2004-2007	CHEVROLET	CORVETTE	
2001-2007	CHEVROLET	IMPALA	
2001-2007	CHEVROLET	MALIBU	
2001-2007	CHEVROLET	MONTE CARLO	
2007	CHEVROLET	AVALANCHE	
2007	CHEVROLET	SILVERADO 1500	
2007	CHEVROLET	SILVERADO 2500 HD	
2007	CHEVROLET	SILVERADO 3500 HD	
2007	CHEVROLET	SUBURBAN 1500	
2007	CHEVROLET	SUBURBAN 2500	
2004-2005	CHEVROLET	CLASSIC	
2003-2005	CHEVROLET	SSR	
2002-2005	CHEVROLET	CAVALIER	
2002-2005	CHEVROLET	TRAILBLAZER EXT	
2001-2005	CHEVROLET	VENTURE	
2002-2003	CHEVROLET	TRAILBLAZER	

#PART PIECE PARTE	MFR/ MARQUE FABRICANTE	MODEL MODELE MODELO	
<b>234-4209 (CONT.)</b>			<b>A</b>
1998-2003	CHEVROLET	TRACKER	
2001-2002	CHEVROLET	EXPRESS 3500	
2001-2002	CHEVROLET	SILVERADO 1500 HD	
2001-2002	CHEVROLET	SILVERADO 2500 HD	
2001-2002	CHEVROLET	SILVERADO 3500	
2001-2002	CHEVROLET	SUBURBAN 2500	
2000-2002	CHEVROLET	SILVERADO 1500	
2000-2002	CHEVROLET	SILVERADO 2500	
2000-2002	CHEVROLET	SUBURBAN 1500	
2000-2002	CHEVROLET	TAHOE	
1998-2002	CHEVROLET	ASTRO	
1998-2002	CHEVROLET	PRIZM	
2002	CHEVROLET	AVALANCHE 1500	
2002	CHEVROLET	AVALANCHE 2500	
2002	CHEVROLET	BLAZER	
2002	CHEVROLET	S10	
1998-2001	CHEVROLET	METRO	
2000	CHEVROLET	C2500 TRUCK	
2000	CHEVROLET	C3500 TRUCK	
2000	CHEVROLET	K2500 TRUCK	
2000	CHEVROLET	K3500 TRUCK	
2001-2005	CHRYSLER	SEBRING	
2001-2005	DODGE	STRATUS	
2000-2002	DODGE	DAKOTA	
2000-2002	DODGE	DURANGO	
2002	DODGE	RAM 1500 PICKUP	
1993-1996	DODGE	STEALTH	
1993-1994	DODGE	COLT	
1993	DODGE	RAM 50	
1989-1990	DODGE	2000 GTX	
1989	DODGE	COLT	
1990-1998	EAGLE	TALON	
1993-1996	EAGLE	SUMMIT	
1991-1992	EAGLE	2000 GTX	
1995-1996	FORD	ESCORT	
1995-1997	GEO	PRIZM	
1994-1997	GEO	METRO	
1993-1997	GEO	TRACKER	
1992-1993	GEO	STORM	
2006-2007	GMC	SIERRA 1500	
2006-2007	GMC	YUKON	
2007	GMC	SIERRA 1500 CLASSIC	
2007	GMC	SIERRA 2500 HD	
2007	GMC	SIERRA 3500 HD	
2007	GMC	YUKON XL 1500	
2007	GMC	YUKON XL 2500	
2004-2005	GMC	ENVOY XUV	
2002-2005	GMC	ENVOY XL	
2005	GMC	ENVOY	
2002-2003	GMC	ENVOY	
2001-2002	GMC	SAVANA 3500	



#PART PIECE PARTE	MFR / MARQUE FABRICANTE	MODEL MODELE MODELO	A
<b>234-4209 (CONT.)</b>			
2001-2002	GMC	SIERRA 1500 HD	
2001-2002	GMC	SIERRA 2500 HD	
2001-2002	GMC	SIERRA 3500	
2001-2002	GMC	YUKON XL 2500	
2000-2002	GMC	SIERRA 1500	
2000-2002	GMC	SIERRA 2500	
2000-2002	GMC	YUKON	
2000-2002	GMC	YUKON XL 1500	
1998-2002	GMC	SAFARI	
2002	GMC	JIMMY	
2002	GMC	SONOMA	
2000	GMC	C25/C2500 PICKUP	
2000	GMC	C35/C3500 PICKUP	
2000	GMC	K25/K2500 TRUCK	
2000	GMC	K35/K3500 TRUCK	
1992-2005	HONDA	CIVIC	
2003-2004	HONDA	PILOT	
1995-2004	HONDA	ODYSSEY	
2000-2003	HONDA	S2000	
2001-2002	HONDA	PASSPORT	
1990-2002	HONDA	ACCORD	
2000-2001	HONDA	INSIGHT	
1997-2001	HONDA	CR-V	
1990-2001	HONDA	PRELUDE	
1993-1997	HONDA	CIVIC DEL SOL	
1994-1995	HONDA	PASSPORT	
2007	HUMMER	H2	
1992-1994	HYUNDAI	EXCEL	
1990-1994	HYUNDAI	SONATA	
2003-2005	ISUZU	ASCENDER	
2002-2004	ISUZU	AXIOM	
2001-2004	ISUZU	RODEO	
2001-2003	ISUZU	RODEO SPORT	
2000-2002	ISUZU	TROOPER	
1996-1999	ISUZU	OASIS	
1993-1995	ISUZU	RODEO	
1992-1995	ISUZU	TROOPER	
1992	ISUZU	IMPULSE	
1992	ISUZU	STYLUS	
1995-1996	JAGUAR	XJ12	
1995	JAGUAR	XJS	
1999-2004	JEEP	GRAND CHEROKEE	
1995-1997	KIA	SEPHIA	
2008-2015	LEXUS	LS600H	
2007-2014	LEXUS	ES350	
2010-2013	LEXUS	GX460	
2009-2013	LEXUS	LS460	
2013	LEXUS	LX570	
2008-2011	LEXUS	GS460	
2008-2011	LEXUS	LX570	
2002-2010	LEXUS	SC430	

#PART PIECE PARTE	MFR / MARQUE FABRICANTE	MODEL MODELE MODELO	A
<b>234-4209 (CONT.)</b>			
2007-2009	LEXUS	RX350	
2003-2009	LEXUS	GX470	
2006-2008	LEXUS	RX400H	
2001-2007	LEXUS	GS430	
1998-2007	LEXUS	LX470	
2004-2006	LEXUS	ES330	
2004-2006	LEXUS	RX330	
2001-2006	LEXUS	LS430	
2001-2005	LEXUS	IS300	
1993-2005	LEXUS	GS300	
1992-2003	LEXUS	ES300	
1998-2000	LEXUS	GS400	
1996-2000	LEXUS	SC400	
1995-2000	LEXUS	LS400	
1994-2000	LEXUS	SC300	
2005-2008	MAZDA	6	
2000-2006	MAZDA	MPV	
2002-2003	MAZDA	PROTEGE5	
1993-2003	MAZDA	PROTEGE	
1999-2000	MAZDA	MIATA	
1996-1998	MAZDA	MPV	
1994-1997	MAZDA	MIATA	
1993-1995	MAZDA	323	
1992-1995	MAZDA	MX-3	
1995-1996	MERCURY	TRACER	
2003-2015	MITSUBISHI	OUTLANDER	
1999-2012	MITSUBISHI	GALANT	
1990-2012	MITSUBISHI	ECLIPSE	
2010-2011	MITSUBISHI	ENDEAVOR	
2004-2008	MITSUBISHI	ENDEAVOR	
2002-2006	MITSUBISHI	LANCER	
1992-2006	MITSUBISHI	MONTERO	
1997-2004	MITSUBISHI	MONTERO SPORT	
1992-2004	MITSUBISHI	DIAMANTE	
1993-2002	MITSUBISHI	MIRAGE	
1993-1999	MITSUBISHI	3000GT	
1993-1996	MITSUBISHI	MIGHTY MAX	
1993-1995	MITSUBISHI	EXPO	
1993-1994	MITSUBISHI	EXPO LRV	
1992-1994	MITSUBISHI	PRECIS	
1989-1992	MITSUBISHI	GALANT	
1989	MITSUBISHI	MIRAGE	
2001-2004	OLDSMOBILE	ALERO	
2001-2004	OLDSMOBILE	SILHOUETTE	
2002-2003	OLDSMOBILE	BRAVADA	
2001-2003	OLDSMOBILE	AURORA	
2000-2002	OLDSMOBILE	INTRIGUE	
1993-1994	PLYMOUTH	COLT	
1990-1994	PLYMOUTH	LASER	
1989	PLYMOUTH	COLT	
2007-2010	PONTIAC	G5	

#PART PIECE PARTE	MFR / MARQUE FABRICANTE	MODEL MODELE MODELO	A
<b>234-4209 (CONT.)</b>			
2003-2010	PONTIAC	VIBE	
2001-2008	PONTIAC	GRAND PRIX	
2006-2007	PONTIAC	TORRENT	
2005-2007	PONTIAC	G6	
2001-2007	PONTIAC	MONTANA	
2005-2006	PONTIAC	PURSUIT	
2004-2006	PONTIAC	GTO	
2004-2005	PONTIAC	BONNEVILLE	
2002-2005	PONTIAC	SUNFIRE	
2001-2005	PONTIAC	AZTEK	
2001-2005	PONTIAC	GRAND AM	
1994-2000	PONTIAC	FIREFLY	
1994-1997	PONTIAC	SUNRUNNER	
2005	SAAB	9-7X	
2005-2007	SATURN	RELAY	
2003-2007	SATURN	ION	
2002-2007	SATURN	VUE	
2007	SATURN	AURA	
2004	SATURN	L300	
2002-2003	SATURN	L200	
2002-2003	SATURN	LW200	
2000-2002	SATURN	SC1	
2000-2002	SATURN	SC2	
2000-2002	SATURN	SL	
2000-2002	SATURN	SL1	
2000-2002	SATURN	SL2	
2002	SATURN	L100	
2000-2001	SATURN	SW2	
2008-2015	SCION	XB	
2008-2014	SCION	XD	
2005-2010	SCION	TC	
2004-2006	SCION	XA	
2004-2006	SCION	XB	
2002-2006	SUZUKI	XL-7	
1999-2003	SUZUKI	VITARA	
1995-2002	SUZUKI	ESTEEM	
1994-2001	SUZUKI	SWIFT	
2001	SUZUKI	GRAND VITARA	
1996-1998	SUZUKI	X-90	
1992-1998	SUZUKI	SIDEKICK	
2001-2016	TOYOTA	SEQUOIA	
2000-2015	TOYOTA	TUNDRA	
2009-2014	TOYOTA	VENZA	
2006-2014	TOYOTA	YARIS	
1995-2014	TOYOTA	AVALON	
1992-2014	TOYOTA	CAMRY	
2003-2013	TOYOTA	MATRIX	
2001-2013	TOYOTA	HIGHLANDER	
2013	TOYOTA	LAND CRUISER	
2007-2012	TOYOTA	FJ CRUISER	
2006-2012	TOYOTA	RAV4	





#PART PIECE PARTE	MFR/ MARQUE FABRICANTE	MODEL MODELE MODELO
<b>234-4209 (CONT.)</b>		<b>A</b>
2005-2012	TOYOTA	TACOMA
1999-2012	TOYOTA	4RUNNER
1995-2012	TOYOTA	COROLLA
1998-2011	TOYOTA	LAND CRUISER
2004-2010	TOYOTA	SIENNA
2001-2009	TOYOTA	PRIUS
1999-2008	TOYOTA	SOLARA
2000-2005	TOYOTA	CELICA
2000-2005	TOYOTA	ECHO
2000-2005	TOYOTA	MR2 SPYDER
1998-2003	TOYOTA	RAV4
1998-2000	TOYOTA	SIENNA
1995-1999	TOYOTA	PASEO
1995-1999	TOYOTA	TERCEL
1993-1998	TOYOTA	SUPRA
1996-1997	TOYOTA	CELICA
<b>234-4210</b>		<b>B</b>
2001-2004	CHEVROLET	TRACKER
1999-2004	CHRYSLER	300M
1995-2004	CHRYSLER	SEBRING
1993-2004	CHRYSLER	CONCORDE
1993-2004	CHRYSLER	INTREPID
2000-2003	CHRYSLER	VOYAGER
1990-2003	CHRYSLER	TOWN & COUNTRY
2001-2002	CHRYSLER	PROWLER
2001-2002	CHRYSLER	PT CRUISER
2000-2002	CHRYSLER	NEON
1999-2001	CHRYSLER	LHS
1995-2000	CHRYSLER	CIRRUS
2000	CHRYSLER	GRAND VOYAGER
1994-1997	CHRYSLER	LHS
1989-1996	CHRYSLER	NEW YORKER
1989-1995	CHRYSLER	LEBARON
1990-1993	CHRYSLER	IMPERIAL
1989-1993	CHRYSLER	DAYTONA
1988-1993	CHRYSLER	DYNASTY
1989-1991	CHRYSLER	TC MASERATI
1994-2006	DODGE	RAM 1500 PICKUP
1992-2006	DODGE	VIPER
2005	DODGE	NEON
2005	DODGE	SX 2.0
1998-2004	DODGE	DURANGO
1995-2004	DODGE	STRATUS
1994-2004	DODGE	RAM 2500 PICKUP
1994-2004	DODGE	RAM 3500 PICKUP
1993-2004	DODGE	INTREPID
1988-2004	DODGE	DAKOTA
1999-2003	DODGE	RAM 1500 VAN
1999-2003	DODGE	RAM 2500 VAN
1999-2003	DODGE	RAM 3500 VAN
1989-2003	DODGE	CARAVAN

#PART PIECE PARTE	MFR/ MARQUE FABRICANTE	MODEL MODELE MODELO
<b>234-4210 (CONT.)</b>		<b>B</b>
1989-2003	DODGE	GRAND CARAVAN
1995-2002	DODGE	NEON
1995-2000	DODGE	AVENGER
1995-1998	DODGE	B1500 VAN
1995-1998	DODGE	B2500 VAN
1995-1998	DODGE	B3500 VAN
1993-1995	DODGE	COLT
1989-1995	DODGE	SPIRIT
1989-1994	DODGE	SHADOW
1988-1994	DODGE	B150 VAN
1988-1994	DODGE	B250 VAN
1988-1994	DODGE	B350 VAN
1989-1993	DODGE	DAYTONA
1989-1993	DODGE	DYNASTY
1988-1993	DODGE	D150 PICKUP
1988-1993	DODGE	D250 PICKUP
1988-1993	DODGE	D350 PICKUP
1988-1993	DODGE	RAMCHARGER
1988-1993	DODGE	W150 PICKUP
1988-1993	DODGE	W250 PICKUP
1988-1993	DODGE	W350 PICKUP
1991-1992	DODGE	MONACO
1989-1990	DODGE	OMNI
1988-1989	DODGE	D100 PICKUP
1988-1989	DODGE	W100 PICKUP
1989	DODGE	ARIES
1989	DODGE	LANCER
1991-1998	EAGLE	TALON
1993-1997	EAGLE	VISION
1993-1996	EAGLE	SUMMIT
1991-1992	EAGLE	PREMIER
1992-2011	FORD	CROWN VICTORIA
2009-2010	FORD	FLEX
2007-2010	FORD	EDGE
2006-2010	FORD	FUSION
2001-2010	FORD	ESCAPE
1996-2010	FORD	MUSTANG
1991-2010	FORD	TAURUS
2008-2009	FORD	TAURUS X
2005-2007	FORD	FIVE HUNDRED
2005-2007	FORD	FREESTYLE
2004-2007	FORD	FREESTAR
2005-2006	FORD	GT
2002-2005	FORD	THUNDERBIRD
2000-2005	FORD	EXCURSION
2000-2004	FORD	FOCUS
1999-2004	FORD	F-250 SUPER DUTY
1999-2004	FORD	F-350 SUPER DUTY
2001-2003	FORD	EXPLORER
1994-2003	FORD	ESCORT
2000-2002	FORD	E-150 VAN

#PART PIECE PARTE	MFR/ MARQUE FABRICANTE	MODEL MODELE MODELO
<b>234-4210 (CONT.)</b>		<b>B</b>
2002	FORD	F-150
2000-2001	FORD	E-450 ECONOLINE
1999-2001	FORD	E-350 SUPER DUTY
1997-2001	FORD	E-250 VAN
1997-2001	FORD	E-350 VAN
1995-2000	FORD	CONTOUR
1997-1999	FORD	F-250
1999	FORD	ECONOLINE SUPER
1998	FORD	F-150
1996-1997	FORD	ASPIRE
1996-1997	FORD	THUNDERBIRD
1993-1997	FORD	PROBE
1989-1997	FORD	RANGER
1995	FORD	AEROSTAR
1992-1994	FORD	TEMPO
1991-1993	FORD	THUNDERBIRD
1990-1993	FORD	MUSTANG
1993	FORD	AEROSTAR
1990-1992	FORD	BRONCO
1990-1992	FORD	E-350 VAN
1990-1992	FORD	F-150
1990-1992	FORD	F-250
1990-1992	FORD	F-350
1990-1991	FORD	AEROSTAR
1990-1991	FORD	E-250 VAN
1991	FORD	EXPLORER
1990	FORD	BRONCO II
1990	FORD	E-150 VAN
2001-2005	HONDA	CIVIC
2003-2006	HYUNDAI	SANTA FE
2003-2005	HYUNDAI	XG350
1993-2005	HYUNDAI	SONATA
1993-1995	HYUNDAI	ELANTRA
1992-1994	HYUNDAI	EXCEL
2006-2010	INFINITI	M45
2003-2008	INFINITI	FX45
2003-2007	INFINITI	G35
2003-2006	INFINITI	FX35
2002-2006	INFINITI	Q45
2006	INFINITI	M35
2003-2004	INFINITI	M45
2002	INFINITI	G20
2000	JAGUAR	S-TYPE
2002-2004	JEEP	LIBERTY
1997-2004	JEEP	TJ
1997-2004	JEEP	WRANGLER
1993-2004	JEEP	GRAND CHEROKEE
1991-2001	JEEP	CHEROKEE
1991-1995	JEEP	WRANGLER
1993	JEEP	GRAND WAGONEER
1991-1992	JEEP	COMANCHE

**NUMERICAL LISTING**



#PART PIECE PARTE	MFR / MARQUE FABRICANTE	MODEL MODELE MODELO
<b>234-4210 (CONT.)</b>		<b>B</b>
2004-2006	KIA	AMANTI
2003-2006	KIA	SORENTO
1996-1997	KIA	SEPHIA
2009-2015	LINCOLN	MKS
1991-2011	LINCOLN	TOWN CAR
2007-2010	LINCOLN	MKX
2007-2010	LINCOLN	MKZ
2010	LINCOLN	MKT
2000-2006	LINCOLN	LS
2006	LINCOLN	ZEPHYR
1991-2002	LINCOLN	CONTINENTAL
1993-1998	LINCOLN	MARK VIII
2008-2011	MAZDA	TRIBUTE
2009-2010	MAZDA	6
2007-2010	MAZDA	CX-9
2001-2006	MAZDA	TRIBUTE
2003-2005	MAZDA	6
1995-2002	MAZDA	MILLENNIA
1993-2002	MAZDA	626
1995-1998	MAZDA	PROTEGE
1995-1997	MAZDA	B2300
1993-1997	MAZDA	MX-6
1996	MAZDA	MX-3
1991-1995	MAZDA	MPV
1990-1995	MAZDA	929
1992-2011	MERCURY	GRAND MARQUIS
2006-2010	MERCURY	MILAN
2005-2010	MERCURY	MARINER
2008-2009	MERCURY	SABLE
2005-2007	MERCURY	MONTEGO
2004-2007	MERCURY	MONTEREY
1991-2005	MERCURY	SABLE
2003-2004	MERCURY	MARAUDER
2002-2003	MERCURY	MOUNTAINEER
1999-2002	MERCURY	COUGAR
1995-2000	MERCURY	MYSTIQUE
1994-1999	MERCURY	TRACER
1996-1997	MERCURY	COUGAR
1992-1994	MERCURY	TOPAZ
1991-1993	MERCURY	COUGAR
1991-1999	MITSUBISHI	ECLIPSE
1993-1996	MITSUBISHI	MIRAGE
1992-1994	MITSUBISHI	PRECIS
1991-1992	MITSUBISHI	GALANT
2004-2009	NISSAN	QUEST
2004-2008	NISSAN	MAXIMA
2003-2007	NISSAN	MURANO
2003-2006	NISSAN	350Z
2002-2006	NISSAN	ALTIMA
2002-2006	NISSAN	SENTRA
2003	NISSAN	PATHFINDER

#PART PIECE PARTE	MFR / MARQUE FABRICANTE	MODEL MODELE MODELO
<b>234-4210 (CONT.)</b>		<b>B</b>
1999-2001	PLYMOUTH	PROWLER
1995-2001	PLYMOUTH	NEON
1996-2000	PLYMOUTH	BREEZE
1989-2000	PLYMOUTH	GRAND VOYAGER
1989-2000	PLYMOUTH	VOYAGER
1997	PLYMOUTH	PROWLER
1993-1995	PLYMOUTH	COLT
1989-1995	PLYMOUTH	ACCLAIM
1991-1994	PLYMOUTH	LASER
1989-1994	PLYMOUTH	SUNDANCE
1989-1990	PLYMOUTH	HORIZON
1989	PLYMOUTH	EXPO
1989	PLYMOUTH	RELIANT
2002-2006	SUZUKI	XL-7
1999-2005	SUZUKI	GRAND VITARA
2004	SUZUKI	VITARA
1999-2000	SUZUKI	VITARA
1996-1998	SUZUKI	SIDEKICK
<b>234-4211</b>		<b>C</b>
1992-1995	LEXUS	SC400
1990-1994	LEXUS	LS400
<b>234-4212</b>		<b>C</b>
2012-2016	BUICK	VERANO
2011-2015	BUICK	REGAL
2015	BUICK	LACROSSE
2005-2013	BUICK	LACROSSE
2007-2011	BUICK	LUCERNE
2005-2010	BUICK	ALLURE
2008	BUICK	ENCLAVE
2006-2007	BUICK	RENDEZVOUS
2005-2007	BUICK	TERRAZA
2005	BUICK	RAINIER
2009-2015	CADILLAC	CTS
2008-2014	CADILLAC	ESCALADE
2008-2014	CADILLAC	ESCALADE ESV
2008-2013	CADILLAC	ESCALADE EXT
2007-2010	CADILLAC	STS
2007-2009	CADILLAC	SRX
2003-2006	CADILLAC	ESCALADE
2003-2006	CADILLAC	ESCALADE ESV
2003-2006	CADILLAC	ESCALADE EXT
2004-2005	CADILLAC	DEVILLE
2004	CADILLAC	SEVILLE
2014-2015	CHEVROLET	SS
2011-2015	CHEVROLET	CAPRICE
2010-2015	CHEVROLET	CAMARO
2008-2014	CHEVROLET	SUBURBAN 1500
2008-2014	CHEVROLET	TAHOE
2007-2014	CHEVROLET	SILVERADO 3500 HD
2004-2014	CHEVROLET	MALIBU
2014	CHEVROLET	IMPALA

#PART PIECE PARTE	MFR / MARQUE FABRICANTE	MODEL MODELE MODELO
<b>234-4212 (CONT.)</b>		<b>C</b>
2012-2013	CHEVROLET	ORLANDO
2009-2013	CHEVROLET	CORVETTE
2008-2013	CHEVROLET	AVALANCHE
2003-2013	CHEVROLET	SILVERADO 1500
2013	CHEVROLET	SUBURBAN 2500
2003-2012	CHEVROLET	SILVERADO 2500 HD
2008-2011	CHEVROLET	SUBURBAN 2500
2007-2011	CHEVROLET	HHR
2006-2011	CHEVROLET	IMPALA
2007-2010	CHEVROLET	COBALT
2005-2009	CHEVROLET	EQUINOX
2005-2009	CHEVROLET	UPLANDER
2006-2007	CHEVROLET	MONTE CARLO
2007	CHEVROLET	SILVERADO 1500
2007	CHEVROLET	SILVERADO 1500 HD
2007	CHEVROLET	SILVERADO 2500 HD
2007	CHEVROLET	SILVERADO 3500
2005-2006	CHEVROLET	SILVERADO 1500 HD
2003-2006	CHEVROLET	AVALANCHE 2500
2003-2006	CHEVROLET	SILVERADO 3500
2003-2006	CHEVROLET	SUBURBAN 1500
2003-2006	CHEVROLET	SUBURBAN 2500
2003-2005	CHEVROLET	AVALANCHE 1500
2003-2005	CHEVROLET	TAHOE
2005	CHEVROLET	SSR
2005	CHEVROLET	TRAILBLAZER EXT
2003-2004	CHEVROLET	SILVERADO 2500
2004	CHEVROLET	CORVETTE
2003	CHEVROLET	SILVERADO 1500 HD
1999-2000	CHEVROLET	TRACKER
2007	CHRYSLER	ASPEN
2005-2006	CHRYSLER	PACIFICA
2003	CHRYSLER	PT CRUISER
2003-2007	DODGE	DAKOTA
2003-2007	DODGE	RAM 1500 PICKUP
2002-2007	DODGE	DURANGO
2003-2005	DODGE	NEON
2003-2005	DODGE	SX 2.0
2002-2014	FORD	E-350 SUPER DUTY
1990-2014	FORD	E-150 VAN
1990-2014	FORD	E-250 VAN
2005-2012	FORD	F-250 SUPER DUTY
2005-2011	FORD	F-350 SUPER DUTY
1997-2011	FORD	EXPEDITION
1990-2011	FORD	RANGER
2009-2010	FORD	F-150
2007-2010	FORD	EXPLORER SPORT
1992-2010	FORD	EXPLORER
2004-2005	FORD	E-250 SUPER DUTY
2002-2005	FORD	E-350 VAN
2004	FORD	F-150 HERITAGE



#PART PIECE PARTE	MFR/ MARQUE FABRICANTE	MODEL MODELE MODELO	
<b>234-4212 (CONT.)</b>			<b>C</b>
2001-2003	FORD	EXPLORER SPORT	
1995-2003	FORD	WINDSTAR	
1990-2003	FORD	F-150	
2002	FORD	E-450 ECONOLINE	
2001	FORD	MUSTANG	
1996-1999	FORD	ECONOLINE SUPER	
1990-1999	FORD	E-350 VAN	
1990-1999	FORD	F-250	
1999	FORD	E-350 SUPER DUTY	
1999	FORD	F-250 SUPER DUTY	
1999	FORD	F-350 SUPER DUTY	
1999	FORD	MUSTANG	
1993-1998	FORD	TAURUS	
1990-1997	FORD	AEROSTAR	
1990-1997	FORD	F-350	
1990-1996	FORD	BRONCO	
1994-1995	FORD	MUSTANG	
1994-1995	FORD	THUNDERBIRD	
1992-1993	FORD	ESCORT	
2008-2014	GMC	YUKON	
2008-2014	GMC	YUKON XL 1500	
2007-2014	GMC	SIERRA 3500 HD	
2008-2013	GMC	YUKON XL 2500	
2003-2013	GMC	SIERRA 1500	
2003-2012	GMC	SIERRA 2500 HD	
2007-2008	GMC	ACADIA	
2007	GMC	SIERRA 1500 CLASSIC	
2007	GMC	SIERRA 1500 HD	
2007	GMC	SIERRA 2500 HD	
2007	GMC	SIERRA 3500 CLASSIC	
2005-2006	GMC	SIERRA 1500 HD	
2003-2006	GMC	SIERRA 3500	
2003-2006	GMC	YUKON	
2003-2006	GMC	YUKON XL 1500	
2003-2006	GMC	YUKON XL 2500	
2005	GMC	ENVOY	
2005	GMC	ENVOY XL	
2005	GMC	ENVOY XUV	
2003-2004	GMC	SIERRA 2500	
2003	GMC	SIERRA 1500 HD	
2003-2006	HUMMER	H2	
1992-1993	HYUNDAI	ELANTRA	
1992-1993	HYUNDAI	SONATA	
2005	ISUZU	ASCENDER	
2000-2002	JAGUAR	S-TYPE	
2006-2007	JEEP	COMMANDER	
2005-2007	JEEP	GRAND CHEROKEE	
1998-2011	LINCOLN	NAVIGATOR	
2002	LINCOLN	BLACKWOOD	
2001-2010	MAZDA	B2300	
1994-2010	MAZDA	B4000	

#PART PIECE PARTE	MFR/ MARQUE FABRICANTE	MODEL MODELE MODELO	
<b>234-4212 (CONT.)</b>			<b>C</b>
1994-2008	MAZDA	B3000	
1998-2001	MAZDA	B2500	
1994-1997	MAZDA	B2300	
1991-1994	MAZDA	NAVAJO	
1997-2000	MERCEDES-BENZ	C230	
1998-1999	MERCEDES-BENZ	SLK230	
2004-2010	MERCURY	MOUNTAINEER	
1997-2002	MERCURY	MOUNTAINEER	
1994-1995	MERCURY	COUGAR	
1992-1993	MERCURY	TRACER	
2006-2007	MITSUBISHI	RAIDER	
1998-2002	MITSUBISHI	MIRAGE	
1994-1998	MITSUBISHI	GALANT	
2007-2010	PONTIAC	G5	
2005-2010	PONTIAC	G6	
2008-2009	PONTIAC	G8	
2006-2009	PONTIAC	TORRENT	
2005-2009	PONTIAC	MONTANA	
2005-2008	PONTIAC	GRAND PRIX	
2004-2006	PONTIAC	GTO	
2004-2005	PONTIAC	BONNEVILLE	
2011	SAAB	9-5	
2008-2010	SATURN	VUE	
2007-2009	SATURN	AURA	
2007-2008	SATURN	OUTLOOK	
2005-2007	SATURN	RELAY	
2007	SATURN	ION	
2003-2006	SUBARU	BAJA	
2000-2004	SUBARU	OUTBACK	
1999-2004	SUBARU	LEGACY	
2002-2007	SUZUKI	AERIO	
<b>234-4213</b>			<b>C</b>
2009-2015	MERCEDES-BENZ	G550	
<b>234-4214</b>			<b>C</b>
1992-1997	LEXUS	SC300	
1998-2000	TOYOTA	RAV4	
<b>234-4215</b>			<b>A</b>
1999-2003	LEXUS	RX300	
2001-2003	TOYOTA	HIGHLANDER	
1993-1998	TOYOTA	SUPRA	
<b>234-4216</b>			<b>A</b>
2001-2003	CHRYSLER	TOWN & COUNTRY	
2001-2003	CHRYSLER	VOYAGER	
2001-2003	DODGE	CARAVAN	
2001-2003	DODGE	GRAND CARAVAN	
<b>234-4217</b>			<b>D</b>
2002-2003	JEEP	LIBERTY	
<b>234-4218</b>			<b>C</b>
2009-2014	HONDA	FIT	
<b>234-4219</b>			<b>C</b>
2010-2011	HONDA	INSIGHT	

#PART PIECE PARTE	MFR/ MARQUE FABRICANTE	MODEL MODELE MODELO	
<b>234-4220</b>			<b>C</b>
2004-2005	ACURA	EL	
2004-2005	HONDA	CIVIC	
<b>234-4221</b>			<b>C</b>
1999-2002	DAEWOO	NUBIRA	
<b>234-4222</b>			<b>D</b>
2001-2003	CHEVROLET	TRACKER	
2002-2006	SUZUKI	XL-7	
2001-2003	SUZUKI	VITARA	
2001	SUZUKI	GRAND VITARA	
<b>234-4224</b>			<b>C</b>
2003-2005	HONDA	CIVIC	
<b>234-4225</b>			<b>C</b>
2002-2007	SUZUKI	AERIO	
<b>234-4226</b>			<b>C</b>
1996-1998	SUZUKI	SIDEKICK	
<b>234-4227</b>			<b>C</b>
2001-2002	SUZUKI	ESTEEM	
<b>234-4228</b>			<b>D</b>
2002-2003	JEEP	LIBERTY	
<b>234-4229</b>			<b>D</b>
2001-2003	JEEP	TJ	
2001-2003	JEEP	WRANGLER	
<b>234-4230</b>			<b>C</b>
2005	DODGE	NEON	
2005	DODGE	SX 2.0	
<b>234-4231</b>			<b>C</b>
2009-2010	AUDI	A4	
2009-2010	AUDI	A4 QUATTRO	
2010	AUDI	A5	
2010	AUDI	A5 QUATTRO	
2011-2014	PORSCHE	CAYENNE	
<b>234-4232</b>			<b>D</b>
2003	CHRYSLER	PT CRUISER	
2003-2005	DODGE	NEON	
2003-2005	DODGE	SX 2.0	
<b>234-4233</b>			<b>B</b>
2003-2008	PONTIAC	VIBE	
2003-2008	TOYOTA	COROLLA	
2003-2008	TOYOTA	MATRIX	
<b>234-4234</b>			<b>C</b>
1996-2002	SUZUKI	ESTEEM	
<b>234-4235</b>			<b>D</b>
2004-2005	SATURN	VUE	
2003-2004	SATURN	ION	
<b>234-4236</b>			<b>C</b>
2008-2009	BUICK	ALLURE	
2008-2009	BUICK	LACROSSE	
2006-2007	CADILLAC	CTS	
2006-2009	CHEVROLET	IMPALA	
2006-2007	CHEVROLET	MONTE CARLO	
2005-2008	PONTIAC	GRAND PRIX	



#PART PIECE PARTE	MFR / MARQUE FABRICANTE	MODEL MODELE MODELO	
<b>234-4237</b>			<b>C</b>
2009-2010	HYUNDAI	SONATA	
2012-2013	KIA	FORTES	
2010-2013	KIA	FORTE	
2010-2013	KIA	FORTE KOUP	
2009-2012	KIA	RONDO	
2010	KIA	MAGENTIS	
2010	KIA	OPTIMA	
<b>234-4238</b>			<b>C</b>
2010-2015	HYUNDAI	SANTA FE	
2010-2014	HYUNDAI	GENESIS COUPE	
2010-2014	HYUNDAI	TUCSON	
2009-2014	HYUNDAI	SONATA	
2011-2015	KIA	OPTIMA	
2011-2015	KIA	SORENTO	
2011-2014	KIA	SPORTAGE	
2012-2013	KIA	FORTES	
2010-2013	KIA	FORTE	
2010-2013	KIA	FORTE KOUP	
2009-2012	KIA	RONDO	
<b>234-4239</b>			<b>C</b>
2011-2015	HYUNDAI	EQUUS	
2009-2015	HYUNDAI	GENESIS	
2015	KIA	K900	
2010-2011	KIA	SOUL	
2009-2011	KIA	BORREGO	
<b>234-4240</b>			<b>C</b>
2009-2012	HYUNDAI	GENESIS	
2011	HYUNDAI	EQUUS	
2009-2011	KIA	BORREGO	
<b>234-4241</b>			<b>C</b>
2002-2004	INFINITI	I35	
2002-2003	NISSAN	MAXIMA	
2001-2002	NISSAN	SENTRA	
<b>234-4242</b>			<b>D</b>
2012-2015	CHEVROLET	CAPTIVA SPORT	
2010-2015	CHEVROLET	EQUINOX	
2008-2010	CHEVROLET	MALIBU	
2008	CHEVROLET	HHR	
2010-2015	GMC	TERRAIN	
2008-2010	PONTIAC	G6	
2008-2009	PONTIAC	SOLSTICE	
2008-2010	SATURN	SKY	
2008-2010	SATURN	VUE	
2007-2009	SATURN	AURA	
<b>234-4243</b>			<b>D</b>
2008-2015	CHEVROLET	EXPRESS 2500	
2008-2015	CHEVROLET	EXPRESS 3500	
2008-2014	CHEVROLET	EXPRESS 1500	
2009-2012	CHEVROLET	COLORADO	
2008-2009	CHEVROLET	TRAILBLAZER	
2008-2015	GMC	SAVANA 2500	

#PART PIECE PARTE	MFR / MARQUE FABRICANTE	MODEL MODELE MODELO	
<b>234-4243 (CONT.)</b>			<b>D</b>
2008-2015	GMC	SAVANA 3500	
2008-2014	GMC	SAVANA 1500	
2009-2012	GMC	CANYON	
2008-2009	GMC	ENVOY	
2009-2010	HUMMER	H3T	
2008-2010	HUMMER	H3	
2008-2009	SAAB	9-7X	
<b>234-4244</b>			<b>C</b>
2008-2014	CADILLAC	CTS	
2008-2011	CADILLAC	STS	
2010-2015	CHEVROLET	CAMARO	
<b>234-4245</b>			<b>C</b>
2008-2010	CHEVROLET	COBALT	
2008-2010	CHEVROLET	HHR	
2007-2009	PONTIAC	SOLSTICE	
2007-2010	SATURN	SKY	
<b>234-4246</b>			<b>C</b>
2008-2009	CHEVROLET	TRAILBLAZER	
2008-2009	GMC	ENVOY	
2008-2009	SAAB	9-7X	
<b>234-4247</b>			<b>C</b>
2008-2009	SATURN	ASTRA	
<b>234-4248</b>			<b>C</b>
2008-2009	SATURN	ASTRA	
<b>234-4249</b>			<b>C</b>
2008-2009	BUICK	ALLURE	
2008-2009	BUICK	LACROSSE	
2008-2009	CHEVROLET	IMPALA	
2008	PONTIAC	GRAND PRIX	
<b>234-4250</b>			<b>C</b>
2008-2010	CHEVROLET	MALIBU	
2008-2010	PONTIAC	G6	
2008-2009	SATURN	AURA	
<b>234-4251</b>			<b>C</b>
2010	BUICK	ALLURE	
2010	BUICK	LACROSSE	
2008-2012	CHEVROLET	MALIBU	
2010	CHEVROLET	EQUINOX	
2010	GMC	TERRAIN	
2008-2009	PONTIAC	SOLSTICE	
2009	PONTIAC	G6	
2008-2010	SATURN	SKY	
2010	SATURN	VUE	
2007-2009	SATURN	AURA	
<b>234-4252</b>			<b>C</b>
2009-2015	CADILLAC	CTS	
2008-2010	CHEVROLET	SILVERADO 2500 HD	
2008-2010	CHEVROLET	SILVERADO 3500 HD	
2008-2010	GMC	SIERRA 2500 HD	
2008-2010	GMC	SIERRA 3500 HD	

#PART PIECE PARTE	MFR / MARQUE FABRICANTE	MODEL MODELE MODELO	
<b>234-4253</b>			<b>C</b>
2011-2014	CHEVROLET	CAPRICE	
2008-2009	PONTIAC	G8	
<b>234-4254</b>			<b>D</b>
2008-2012	CHEVROLET	MALIBU	
2008-2011	CHEVROLET	IMPALA	
2008-2009	PONTIAC	G6	
2008-2009	SATURN	AURA	
<b>234-4255</b>			<b>D</b>
2008-2010	CHEVROLET	MALIBU	
2008-2009	CHEVROLET	EQUINOX	
2008-2009	CHEVROLET	UPLANDER	
2008-2010	PONTIAC	G6	
2008-2009	PONTIAC	MONTANA	
2008-2009	PONTIAC	TORRENT	
2008-2010	SATURN	VUE	
2008	SATURN	AURA	
<b>234-4256</b>			<b>D</b>
2008-2014	CADILLAC	ESCALADE	
2008-2014	CADILLAC	ESCALADE ESV	
2008-2013	CADILLAC	ESCALADE EXT	
2014-2015	CHEVROLET	SS	
2010-2015	CHEVROLET	CAMARO	
2008-2015	CHEVROLET	SILVERADO 2500 HD	
2008-2015	CHEVROLET	SILVERADO 3500 HD	
2015	CHEVROLET	CAPRICE	
2008-2014	CHEVROLET	SUBURBAN 1500	
2008-2014	CHEVROLET	TAHOE	
2008-2013	CHEVROLET	AVALANCHE	
2008-2013	CHEVROLET	CORVETTE	
2008-2013	CHEVROLET	SILVERADO 1500	
2008-2013	CHEVROLET	SUBURBAN 2500	
2008-2015	GMC	SIERRA 2500 HD	
2008-2015	GMC	SIERRA 3500 HD	
2008-2014	GMC	YUKON	
2008-2014	GMC	YUKON XL 1500	
2008-2013	GMC	SIERRA 1500	
2008-2013	GMC	YUKON XL 2500	
<b>234-4257</b>			<b>D</b>
2011-2012	CHEVROLET	EXPRESS 2500	
2008-2012	CHEVROLET	EXPRESS 3500	
2011-2012	GMC	SAVANA 2500	
2008-2012	GMC	SAVANA 3500	
<b>234-4258</b>			<b>D</b>
2008-2013	CHEVROLET	SILVERADO 1500	
2008-2013	GMC	SIERRA 1500	
2008-2009	HUMMER	H2	
<b>234-4260</b>			<b>B</b>
2007-2014	LEXUS	ES350	
2010-2013	LEXUS	GX460	
2013	LEXUS	LX570	
2008-2011	LEXUS	LX570	



#PART PIECE PARTE	MFR/ MARQUE FABRICANTE	MODEL MODELE MODELO	
<b>234-4260 (CONT.)</b>			<b>B</b>
2005-2007	LEXUS	LX470	
2003-2004	LEXUS	GX470	
2005-2016	TOYOTA	SEQUOIA	
2005-2015	TOYOTA	TUNDRA	
2009-2014	TOYOTA	VENZA	
2007-2014	TOYOTA	CAMRY	
2005-2014	TOYOTA	AVALON	
2013	TOYOTA	LAND CRUISER	
2007-2012	TOYOTA	FJ CRUISER	
2005-2012	TOYOTA	TACOMA	
2003-2012	TOYOTA	4RUNNER	
2005-2011	TOYOTA	LAND CRUISER	
2007-2008	TOYOTA	SOLARA	
<b>234-4261</b>			<b>A</b>
2003-2009	LEXUS	GX470	
2004-2006	LEXUS	ES330	
2002-2003	LEXUS	ES300	
2006-2012	TOYOTA	RAV4	
2001-2009	TOYOTA	4RUNNER	
2004-2008	TOYOTA	SOLARA	
2007	TOYOTA	FJ CRUISER	
2005-2006	TOYOTA	TACOMA	
2002-2006	TOYOTA	CAMRY	
<b>234-4262</b>			<b>C</b>
2011-2015	HYUNDAI	EQUUS	
2009-2015	HYUNDAI	GENESIS	
2015	KIA	K900	
<b>234-4263</b>			<b>C</b>
2009-2011	HYUNDAI	GENESIS	
<b>234-4264</b>			<b>C</b>
2007-2009	LAND ROVER	LR3	
2007-2009	LAND ROVER	RANGE ROVER SPORT	
<b>234-4265</b>			<b>D</b>
2007-2009	LAND ROVER	RANGE ROVER	
2005-2006	LAND ROVER	LR3	
2006	LAND ROVER	RANGE ROVER SPORT	
<b>234-4266</b>			<b>D</b>
2006-2009	LAND ROVER	RANGE ROVER	
2005-2006	LAND ROVER	LR3	
2006	LAND ROVER	RANGE ROVER SPORT	
<b>234-4267</b>			<b>C</b>
2003	SAAB	9-3	
<b>234-4268</b>			<b>C</b>
2003	SAAB	9-3	
<b>234-4269</b>			<b>C</b>
2000-2002	PORSCHE	BOXSTER	
<b>234-4270</b>			<b>C</b>
2002-2004	INFINITI	I35	
2002-2003	NISSAN	MAXIMA	
2001-2002	NISSAN	SENTRA	

#PART PIECE PARTE	MFR/ MARQUE FABRICANTE	MODEL MODELE MODELO	
<b>234-4271</b>			<b>C</b>
2000-2002	PORSCHE	BOXSTER	
<b>234-4272</b>			<b>C</b>
2009-2011	HYUNDAI	GENESIS	
<b>234-4273</b>			<b>D</b>
2002-2004	NISSAN	ALTIMA	
<b>234-4277</b>			<b>C</b>
2004-2005	NISSAN	ALTIMA	
2004-2005	NISSAN	ALTIMA	
<b>234-4278</b>			<b>C</b>
2009-2011	MAZDA	RX-8	
<b>234-4279</b>			<b>C</b>
2009-2013	MAZDA	6	
<b>234-4280</b>			<b>D</b>
2010-2011	MITSUBISHI	ENDEAVOR	
2009	MITSUBISHI	GALANT	
2004-2008	MITSUBISHI	ENDEAVOR	
2004-2007	MITSUBISHI	GALANT	
<b>234-4281</b>			<b>C</b>
2004-2005	MITSUBISHI	LANCER	
<b>234-4282</b>			<b>C</b>
2004-2006	MITSUBISHI	OUTLANDER	
<b>234-4283</b>			<b>C</b>
2008-2009	PONTIAC	G8	
<b>234-4284</b>			<b>D</b>
2004-2005	CHEVROLET	AVEO	
2005	PONTIAC	WAVE	
2005	PONTIAC	WAVE5	
2004-2005	SUZUKI	SWIFT+	
<b>234-4285</b>			<b>A</b>
2004-2006	BUICK	RAINIER	
2004-2008	CHEVROLET	MALIBU	
2003-2007	CHEVROLET	EXPRESS 1500	
2003-2007	CHEVROLET	EXPRESS 2500	
2003-2007	CHEVROLET	EXPRESS 3500	
2002-2006	CHEVROLET	TRAILBLAZER	
2002-2006	CHEVROLET	TRAILBLAZER EXT	
2006	CHEVROLET	SSR	
2004-2005	CHEVROLET	COLORADO	
2003-2007	GMC	SAVANA 1500	
2003-2007	GMC	SAVANA 2500	
2003-2007	GMC	SAVANA 3500	
2002-2006	GMC	ENVOY	
2002-2006	GMC	ENVOY XL	
2004-2005	GMC	CANYON	
2004-2005	GMC	ENVOY XUV	
2003-2005	ISUZU	ASCENDER	
2002-2004	OLDSMOBILE	BRAVADA	
2006-2007	PONTIAC	G6	
2005-2006	SAAB	9-7X	
<b>234-4286</b>			<b>A</b>
2003-2006	CADILLAC	ESCALADE ESV	
2002-2007	CHEVROLET	SILVERADO 2500 HD	

#PART PIECE PARTE	MFR/ MARQUE FABRICANTE	MODEL MODELE MODELO	
<b>234-4286 (CONT.)</b>			<b>A</b>
2007	CHEVROLET	SILVERADO 1500	
2007	CHEVROLET	SILVERADO 1500 HD	
2007	CHEVROLET	SILVERADO 2500 HD	
2007	CHEVROLET	SILVERADO 3500	
2007	CHEVROLET	SILVERADO 3500 HD	
2005-2006	CHEVROLET	SILVERADO 1500 HD	
2002-2006	CHEVROLET	SILVERADO 3500	
2002-2006	CHEVROLET	SUBURBAN 2500	
2002-2004	CHEVROLET	SILVERADO 2500	
2002-2003	CHEVROLET	SILVERADO 1500 HD	
2002-2007	GMC	SIERRA 2500 HD	
2007	GMC	SIERRA 1500 HD	
2007	GMC	SIERRA 2500 HD	
2007	GMC	SIERRA 3500 CLASSIC	
2007	GMC	SIERRA 3500 HD	
2005-2006	GMC	SIERRA 1500 HD	
2002-2006	GMC	SIERRA 3500	
2002-2006	GMC	YUKON XL 1500	
2002-2006	GMC	YUKON XL 2500	
2002-2004	GMC	SIERRA 2500	
2002-2003	GMC	SIERRA 1500 HD	
2002	GMC	SIERRA 1500	
2007	PONTIAC	G6	
2007	SATURN	AURA	
<b>234-4287</b>			<b>D</b>
2004-2006	CHEVROLET	MALIBU	
<b>234-4288</b>			<b>C</b>
2006-2008	CHEVROLET	AVEO	
2006-2008	CHEVROLET	AVEO5	
2006-2008	PONTIAC	WAVE	
2006-2007	PONTIAC	WAVE5	
2006-2008	SUZUKI	SWIFT+	
<b>234-4289</b>			<b>C</b>
2006-2007	PONTIAC	SOLSTICE	
2007	SATURN	SKY	
<b>234-4290</b>			<b>C</b>
2009-2011	CHEVROLET	AVEO	
2009-2011	CHEVROLET	AVEO5	
2009-2010	PONTIAC	G3	
2009	PONTIAC	G3 WAVE	
<b>234-4291</b>			<b>C</b>
2009-2011	BUICK	LUCERNE	
<b>234-4292</b>			<b>D</b>
2004-2007	SATURN	VUE	
<b>234-4293</b>			<b>D</b>
2006-2008	CHEVROLET	AVEO	
2006-2008	CHEVROLET	AVEO5	
2006-2008	PONTIAC	WAVE	
2006-2007	PONTIAC	WAVE5	
2006-2009	SUZUKI	SWIFT+	



#PART PIECE PARTE	MFR / MARQUE FABRICANTE	MODEL MODELE MODELO	
<b>234-4294</b>			<b>D</b>
2008	BUICK	ENCLAVE	
2007	BUICK	RAINIER	
2007-2012	CHEVROLET	COLORADO	
2007-2009	CHEVROLET	TRAILBLAZER	
2008	CHEVROLET	MALIBU	
2007-2012	GMC	CANYON	
2007-2009	GMC	ENVOY	
2007-2008	GMC	ACADIA	
2009-2010	HUMMER	H3T	
2007-2010	HUMMER	H3	
2007-2008	ISUZU	I-290	
2007-2008	ISUZU	I-370	
2006-2008	ISUZU	ASCENDER	
2008	PONTIAC	G6	
2007-2009	SAAB	9-7X	
2008-2009	SATURN	VUE	
2007-2008	SATURN	AURA	
2007-2008	SATURN	OUTLOOK	
<b>234-4295</b>			<b>D</b>
2003-2004	NISSAN	PATHFINDER	
<b>234-4296</b>			<b>C</b>
2002-2006	INFINITI	Q45	
2003-2005	INFINITI	FX45	
2003-2004	INFINITI	M45	
2005-2006	NISSAN	X-TRAIL	
2002-2004	NISSAN	SENTRA	
2002-2003	NISSAN	ALTIMA	
2003	NISSAN	MURANO	
<b>234-4297</b>			<b>D</b>
2005-2015	NISSAN	FRONTIER	
2012-2014	NISSAN	NV1500	
2012-2014	NISSAN	NV2500	
2012-2014	NISSAN	NV3500	
2005-2012	NISSAN	PATHFINDER	
2005-2012	NISSAN	XTERRA	
2009-2012	SUZUKI	EQUATOR	
<b>234-4298</b>			<b>C</b>
2009-2011	CHEVROLET	AVEO	
2009-2011	CHEVROLET	AVEO5	
2009-2010	PONTIAC	G3	
2009	PONTIAC	G3 WAVE	
2009	SUZUKI	SWIFT+	
<b>234-4300</b>			<b>C</b>
2009-2013	SUZUKI	GRAND VITARA	
<b>234-4301</b>			<b>C</b>
2002-2006	INFINITI	Q45	
2003-2004	INFINITI	M45	
2004-2009	NISSAN	QUEST	
2004-2008	NISSAN	MAXIMA	
2003-2007	NISSAN	MURANO	
2004-2006	NISSAN	ALTIMA	

#PART PIECE PARTE	MFR / MARQUE FABRICANTE	MODEL MODELE MODELO	
<b>234-4301 (CONT.)</b>			<b>C</b>
2004-2006	NISSAN	SENTRA	
<b>234-4302</b>			<b>D</b>
2006-2010	INFINITI	M45	
2003-2008	INFINITI	FX45	
2003-2007	INFINITI	G35	
2003-2006	INFINITI	FX35	
2006	INFINITI	M35	
2002	INFINITI	G20	
2003-2006	NISSAN	350Z	
<b>234-4303</b>			<b>C</b>
2010-2013	SUZUKI	KIZASHI	
2009-2010	SUZUKI	GRAND VITARA	
<b>234-4304</b>			<b>C</b>
2009-2010	SUZUKI	GRAND VITARA	
<b>234-4305</b>			<b>C</b>
2009-2010	PONTIAC	VIBE	
2009-2014	TOYOTA	MATRIX	
2009-2013	TOYOTA	COROLLA	
<b>234-4306</b>			<b>C</b>
2009-2010	PONTIAC	VIBE	
2009-2016	TOYOTA	VENZA	
2009-2013	TOYOTA	MATRIX	
<b>234-4308</b>			<b>D</b>
2002-2006	INFINITI	Q45	
2003-2005	INFINITI	FX45	
2003-2004	INFINITI	FX35	
2003-2004	INFINITI	G35	
2003-2004	INFINITI	M45	
2003-2004	NISSAN	350Z	
2003-2004	NISSAN	PATHFINDER	
<b>234-4309</b>			<b>C</b>
2002-2003	NISSAN	ALTIMA	
2002-2003	NISSAN	SENTRA	
<b>234-4310</b>			<b>C</b>
2003	NISSAN	PATHFINDER	
<b>234-4311</b>			<b>C</b>
2003	NISSAN	PATHFINDER	
<b>234-4312</b>			<b>D</b>
2006-2010	INFINITI	M45	
2003-2008	INFINITI	FX45	
2003-2007	INFINITI	G35	
2003-2006	INFINITI	FX35	
2002-2006	INFINITI	Q45	
2006	INFINITI	M35	
2003-2004	INFINITI	M45	
2004-2009	NISSAN	QUEST	
2004-2006	NISSAN	ALTIMA	
2004-2006	NISSAN	MAXIMA	
2003-2006	NISSAN	350Z	
<b>234-4313</b>			<b>D</b>
2012-2014	NISSAN	NV1500	

#PART PIECE PARTE	MFR / MARQUE FABRICANTE	MODEL MODELE MODELO	
<b>234-4313 (CONT.)</b>			<b>D</b>
2012-2014	NISSAN	NV2500	
2012-2014	NISSAN	NV3500	
2005-2012	NISSAN	FRONTIER	
2005-2012	NISSAN	PATHFINDER	
2005-2012	NISSAN	XTERRA	
2009-2012	SUZUKI	EQUATOR	
<b>234-4314</b>			<b>C</b>
2004	NISSAN	PATHFINDER	
<b>234-4315</b>			<b>C</b>
2004	NISSAN	PATHFINDER	
<b>234-4316</b>			<b>D</b>
2006-2012	MITSUBISHI	ECLIPSE	
2004-2012	MITSUBISHI	GALANT	
<b>234-4317</b>			<b>D</b>
2006-2012	MITSUBISHI	ECLIPSE	
2004-2012	MITSUBISHI	GALANT	
<b>234-4318</b>			<b>D</b>
2006-2012	MITSUBISHI	ECLIPSE	
2007-2009	MITSUBISHI	GALANT	
<b>234-4319</b>			<b>C</b>
2007-2013	MITSUBISHI	OUTLANDER	
<b>234-4320</b>			<b>C</b>
1996-1997	INFINITI	J30	
<b>234-4321</b>			<b>C</b>
1996	INFINITI	Q45	
<b>234-4322</b>			<b>C</b>
1996-1997	INFINITI	J30	
<b>234-4323</b>			<b>C</b>
2000-2004	NISSAN	XTERRA	
1998-2004	NISSAN	FRONTIER	
1998-1999	NISSAN	SENTRA	
<b>234-4324</b>			<b>D</b>
2000	NISSAN	MAXIMA	
<b>234-4325</b>			<b>D</b>
1997-2001	INFINITI	Q45	
<b>234-4326</b>			<b>D</b>
2000-2001	INFINITI	G20	
<b>234-4327</b>			<b>D</b>
2001	INFINITI	QX4	
2001	NISSAN	PATHFINDER	
<b>234-4328</b>			<b>C</b>
2000-2002	NISSAN	SENTRA	
<b>234-4329</b>			<b>D</b>
2011-2014	MAZDA	2	
2004-2009	MAZDA	3	
2006-2008	MAZDA	6	
<b>234-4330</b>			<b>D</b>
2001-2005	MAZDA	MIATA	
<b>234-4331</b>			<b>A</b>
2006-2007	BUICK	RAINIER	
2006-2012	CHEVROLET	COLORADO	



#PART PIECE PARTE	MFR/ MARQUE FABRICANTE	MODEL MODELE MODELO	
<b>234-4331 (CONT.)</b>			<b>A</b>
2006-2009	CHEVROLET	TRAILBLAZER	
2006	CHEVROLET	TRAILBLAZER EXT	
2006-2012	GMC	CANYON	
2006-2009	GMC	ENVOY	
2006	GMC	ENVOY XL	
2009-2010	HUMMER	H3T	
2006-2010	HUMMER	H3	
2007-2008	ISUZU	I-290	
2007-2008	ISUZU	I-370	
2006-2008	ISUZU	ASCENDER	
2006	ISUZU	I-280	
2006	ISUZU	I-350	
2006-2009	SAAB	9-7X	
<b>234-4332</b>			<b>D</b>
2005-2013	CHEVROLET	CORVETTE	
2006-2007	CHEVROLET	HHR	
<b>234-4333</b>			<b>D</b>
1999-2000	MAZDA	MIATA	
1997	MAZDA	MIATA	
<b>234-4334</b>			<b>C</b>
2006-2009	CADILLAC	STS	
<b>234-4335</b>			<b>C</b>
2006-2009	CADILLAC	XLR	
<b>234-4336</b>			<b>C</b>
2008-2015	CHEVROLET	EXPRESS 2500	
2008-2015	CHEVROLET	EXPRESS 3500	
2007-2014	CHEVROLET	EXPRESS 1500	
2007	CHEVROLET	SILVERADO 1500	
2006	CHEVROLET	AVALANCHE 1500	
2006	CHEVROLET	SILVERADO 1500	
2006	CHEVROLET	SUBURBAN 1500	
2006	CHEVROLET	TAHOE	
2008-2015	GMC	SAVANA 2500	
2008-2015	GMC	SAVANA 3500	
2007-2014	GMC	SAVANA 1500	
2007	GMC	SIERRA 1500 CLASSIC	
2006	GMC	SIERRA 1500	
2006	GMC	YUKON	
2006	GMC	YUKON XL 1500	
<b>234-4337</b>			<b>A</b>
2006-2011	BUICK	LUCERNE	
2006-2011	CADILLAC	DTS	
2007	CADILLAC	ESCALADE	
2007	CADILLAC	ESCALADE ESV	
2007	CADILLAC	ESCALADE EXT	
2006-2013	CHEVROLET	SILVERADO 1500	
2009-2012	CHEVROLET	COLORADO	
2006-2007	CHEVROLET	SUBURBAN 1500	
2006-2007	CHEVROLET	TAHOE	
2007	CHEVROLET	AVALANCHE	
2007	CHEVROLET	SILVERADO 1500	

#PART PIECE PARTE	MFR/ MARQUE FABRICANTE	MODEL MODELE MODELO	
<b>234-4337 (CONT.)</b>			<b>A</b>
2007	CHEVROLET	SUBURBAN 2500	
2006	CHEVROLET	AVALANCHE 1500	
2006-2013	GMC	SIERRA 1500	
2009-2012	GMC	CANYON	
2006-2007	GMC	YUKON	
2006-2007	GMC	YUKON XL 1500	
2007	GMC	SIERRA 1500 CLASSIC	
2007	GMC	YUKON XL 2500	
2009-2010	HUMMER	H3T	
2008-2010	HUMMER	H3	
2007-2009	HUMMER	H2	
<b>234-4338</b>			<b>C</b>
2007-2010	CADILLAC	STS	
2007-2009	CADILLAC	SRX	
2006-2009	CADILLAC	XLR	
<b>234-4339</b>			<b>C</b>
2006-2011	BUICK	LUCERNE	
2006-2007	BUICK	RAINIER	
2006-2011	CADILLAC	DTS	
2006-2009	CHEVROLET	TRAILBLAZER	
2006	CHEVROLET	SSR	
2006	CHEVROLET	TRAILBLAZER EXT	
2006-2009	GMC	ENVOY	
2006	GMC	ENVOY XL	
2006	ISUZU	ASCENDER	
2006-2009	SAAB	9-7X	
<b>234-4340</b>			<b>C</b>
2006-2015	MAZDA	MX-5 MIATA	
<b>234-4341</b>			<b>C</b>
2006-2010	CADILLAC	STS	
2007-2009	CADILLAC	SRX	
2008-2012	CHEVROLET	MALIBU	
2008-2009	PONTIAC	G6	
2008-2009	SATURN	AURA	
<b>234-4342</b>			<b>B</b>
2007-2008	CHEVROLET	MALIBU	
2005-2008	CHEVROLET	COBALT	
2006	CHEVROLET	HHR	
2007-2008	PONTIAC	G5	
2006-2007	PONTIAC	G6	
2006-2007	PONTIAC	SOLSTICE	
2005-2006	PONTIAC	PURSUIT	
2006-2007	SATURN	VUE	
2005-2007	SATURN	ION	
2007	SATURN	SKY	
<b>234-4343</b>			<b>A</b>
2005	BUICK	CENTURY	
2005	BUICK	RENDEZVOUS	
2003-2005	CHEVROLET	BLAZER	
2005	CHEVROLET	IMPALA	
2005	CHEVROLET	MONTE CARLO	

#PART PIECE PARTE	MFR/ MARQUE FABRICANTE	MODEL MODELE MODELO	
<b>234-4343 (CONT.)</b>			<b>A</b>
2005	CHEVROLET	VENTURE	
2003-2004	CHEVROLET	S10	
2003-2005	GMC	JIMMY	
2003-2004	GMC	SONOMA	
2005	PONTIAC	AZTEK	
2005	PONTIAC	GRAND AM	
2005	PONTIAC	MONTANA	
<b>234-4344</b>			<b>D</b>
2003-2005	CHEVROLET	ASTRO	
2003-2005	GMC	SAFARI	
<b>234-4345</b>			<b>D</b>
2003-2005	CHEVROLET	ASTRO	
2003-2005	GMC	SAFARI	
<b>234-4346</b>			<b>D</b>
2004-2005	CADILLAC	DEVILLE	
2004	CADILLAC	SEVILLE	
2004-2005	PONTIAC	BONNEVILLE	
<b>234-4347</b>			<b>C</b>
2006	HUMMER	H3	
<b>234-4348</b>			<b>D</b>
2006	BUICK	RAINIER	
2006	CHEVROLET	COLORADO	
2006	CHEVROLET	TRAILBLAZER	
2006	CHEVROLET	TRAILBLAZER EXT	
2006	GMC	CANYON	
2006	GMC	ENVOY	
2006	GMC	ENVOY XL	
2006	ISUZU	ASCENDER	
2006	ISUZU	I-280	
2006	ISUZU	I-350	
2006	SAAB	9-7X	
<b>234-4349</b>			<b>D</b>
2004-2011	MAZDA	RX-8	
<b>234-4350</b>			<b>D</b>
2013-2014	ACURA	ILX	
2006-2015	HONDA	CIVIC	
<b>234-4351</b>			<b>C</b>
2009-2012	ACURA	RL	
2007-2012	ACURA	RDX	
2007-2009	ACURA	MDX	
2007-2008	ACURA	TL	
2012	HONDA	CROSSTOUR	
2010-2011	HONDA	ACCORD CROSSTOUR	
<b>234-4352</b>			<b>D</b>
2005-2006	HONDA	CR-V	
2003-2005	HONDA	CIVIC	
<b>234-4353</b>			<b>C</b>
2006-2009	HONDA	S2000	
<b>234-4354</b>			<b>C</b>
2005-2006	ACURA	RSX	



#PART PIECE PARTE	MFR / MARQUE FABRICANTE	MODEL MODELE MODELO	
<b>234-4355</b>			<b>D</b>
2005-2008	ACURA	RL	
2004-2006	ACURA	TL	
2003-2006	ACURA	MDX	
2005-2010	HONDA	ODYSSEY	
2006-2008	HONDA	RIDGELINE	
2005-2008	HONDA	PILOT	
2003-2007	HONDA	ACCORD	
2003	HONDA	CIVIC	
<b>234-4358</b>			<b>D</b>
2006-2011	ACURA	CSX	
2006-2011	HONDA	CIVIC	
2007-2008	HONDA	FIT	
<b>234-4359</b>			<b>C</b>
2007-2009	HONDA	CR-V	
<b>234-4360</b>			<b>D</b>
2002-2004	ACURA	RSX	
<b>234-4361</b>			<b>C</b>
2001-2006	HONDA	INSIGHT	
<b>234-4362</b>			<b>C</b>
2003-2006	MITSUBISHI	OUTLANDER	
<b>234-4363</b>			<b>C</b>
2004-2008	ACURA	TSX	
2003-2007	HONDA	ACCORD	
<b>234-4364</b>			<b>C</b>
2004-2005	HONDA	S2000	
<b>234-4368</b>			<b>D</b>
2005-2008	ACURA	RL	
2004-2006	ACURA	TL	
2001-2006	ACURA	MDX	
2005-2010	HONDA	ODYSSEY	
2006-2008	HONDA	RIDGELINE	
2003-2008	HONDA	PILOT	
2003-2007	HONDA	ACCORD	
2004-2005	HONDA	S2000	
<b>234-4370</b>			<b>D</b>
2003-2011	FORD	FOCUS	
<b>234-4371</b>			<b>D</b>
2003-2007	FORD	FOCUS	
<b>234-4372</b>			<b>D</b>
2010	FORD	FUSION	
2008-2009	FORD	TAURUS	
2008-2009	FORD	TAURUS X	
2007-2009	FORD	EDGE	
2007-2010	LINCOLN	MKZ	
2007-2009	LINCOLN	MKX	
2007-2010	MAZDA	CX-9	
2008-2009	MERCURY	SABLE	
<b>234-4373</b>			<b>D</b>
2006-2011	FORD	CROWN VICTORIA	
2006-2011	LINCOLN	TOWN CAR	
2006-2011	MERCURY	GRAND MARQUIS	

#PART PIECE PARTE	MFR / MARQUE FABRICANTE	MODEL MODELE MODELO	
<b>234-4374</b>			<b>C</b>
2006-2010	FORD	FUSION	
2005-2010	FORD	ESCAPE	
2005-2009	FORD	F-250 SUPER DUTY	
2005-2009	FORD	F-350 SUPER DUTY	
2005-2008	FORD	E-150 VAN	
2005-2008	FORD	E-250 VAN	
2005-2008	FORD	E-350 SUPER DUTY	
2005	FORD	E-250 SUPER DUTY	
2005	FORD	E-350 VAN	
2006	LINCOLN	ZEPHYR	
2008-2010	MAZDA	TRIBUTE	
2005-2006	MAZDA	TRIBUTE	
2006-2010	MERCURY	MILAN	
2005-2009	MERCURY	MARINER	
<b>234-4375</b>			<b>D</b>
2003-2006	FORD	FOCUS	
<b>234-4376</b>			<b>C</b>
2005	MAZDA	6	
<b>234-4377</b>			<b>C</b>
2006	MITSUBISHI	OUTLANDER	
<b>234-4378</b>			<b>D</b>
2003-2006	MITSUBISHI	OUTLANDER	
<b>234-4379</b>			<b>C</b>
2006	MITSUBISHI	OUTLANDER	
<b>234-4380</b>			<b>D</b>
2014-2015	INFINITI	Q70	
2015	INFINITI	Q70L	
2014	INFINITI	QX50	
2014	INFINITI	QX70	
2011-2013	INFINITI	M37	
2011-2013	INFINITI	M56	
2009-2013	INFINITI	FX50	
2008-2013	INFINITI	G37	
2013	INFINITI	EX37	
2013	INFINITI	FX37	
2013	INFINITI	M35H	
2011-2012	INFINITI	G25	
2008-2012	INFINITI	EX35	
2007-2012	INFINITI	FX35	
2007-2010	INFINITI	M35	
2007-2008	INFINITI	G35	
2014-2015	NISSAN	ROGUE SELECT	
2009-2014	NISSAN	CUBE	
2009-2014	NISSAN	MAXIMA	
2009-2013	NISSAN	370Z	
2008-2013	NISSAN	ROGUE	
2007-2013	NISSAN	ALTIMA	
2007-2012	NISSAN	SENTRA	
2007-2012	NISSAN	VERSA	
2009-2011	NISSAN	MURANO	
2011	NISSAN	QUEST	

#PART PIECE PARTE	MFR / MARQUE FABRICANTE	MODEL MODELE MODELO	
<b>234-4380 (CONT.)</b>			<b>D</b>
2007-2009	NISSAN	350Z	
<b>234-4381</b>			<b>D</b>
2014-2015	INFINITI	QX80	
2011-2013	INFINITI	QX56	
2009-2015	NISSAN	GT-R	
2012-2014	NISSAN	NV2500	
2012-2014	NISSAN	NV3500	
2009-2014	NISSAN	MAXIMA	
2007-2013	NISSAN	ALTIMA	
2009-2011	NISSAN	MURANO	
2011	NISSAN	QUEST	
<b>234-4382</b>			<b>D</b>
2007-2013	NISSAN	ALTIMA	
2008-2012	NISSAN	ROGUE	
<b>234-4383</b>			<b>C</b>
2006	MITSUBISHI	LANCER	
2004	MITSUBISHI	OUTLANDER	
<b>234-4385</b>			<b>C</b>
2006	MITSUBISHI	LANCER	
<b>234-4386</b>			<b>C</b>
2011-2012	MITSUBISHI	OUTLANDER SPORT	
2008-2012	MITSUBISHI	LANCER	
2007-2010	MITSUBISHI	OUTLANDER	
<b>234-4387</b>			<b>D</b>
2006-2008	SUZUKI	GRAND VITARA	
2001-2002	SUZUKI	ESTEEM	
<b>234-4388</b>			<b>C</b>
2007	SUZUKI	SX4	
<b>234-4389</b>			<b>C</b>
2009-2014	TOYOTA	VENZA	
<b>234-4390</b>			<b>C</b>
2006-2007	MAZDA	5	
2004-2005	MAZDA	3	
<b>234-4391</b>			<b>C</b>
2007-2013	MAZDA	3	
<b>234-4392</b>			<b>C</b>
2006-2009	MAZDA	3	
2009	MAZDA	3 SPORT	
<b>234-4393</b>			<b>C</b>
2003-2008	MAZDA	6	
<b>234-4394</b>			<b>C</b>
2006-2008	MAZDA	6	
<b>234-4395</b>			<b>C</b>
2006-2007	MAZDA	6	
<b>234-4396</b>			<b>D</b>
2006-2007	MAZDA	5	
2004-2005	MAZDA	3	
<b>234-4397</b>			<b>C</b>
2003-2005	MAZDA	6	
<b>234-4398</b>			<b>D</b>
2003-2008	MAZDA	6	





#PART PIECE PARTE	MFR/ MARQUE FABRICANTE	MODEL MODELE MODELO
<b>234-4399</b> C		
2003-2005	MAZDA	6
<b>234-4400</b> C		
2011-2016	LEXUS	CT200H
2010-2015	LEXUS	RX350
2010-2015	LEXUS	RX450H
2015-2016	TOYOTA	SIENNA
2012-2016	TOYOTA	PRIUS V
2011-2016	TOYOTA	HIGHLANDER
2010-2015	TOYOTA	PRIUS
<b>234-4401</b> A		
2009-2012	FORD	E-350 SUPER DUTY
2001-2011	FORD	RANGER
2007-2010	FORD	EXPLORER SPORT
2004-2010	FORD	EXPLORER
2005-2008	FORD	EXPEDITION
2000-2008	FORD	F-150
2004-2007	FORD	FREESTAR
2004-2005	FORD	EXPLORER SPORT
2004	FORD	F-150 HERITAGE
2002-2003	FORD	E-150 VAN
2002-2003	FORD	E-250 VAN
1999-2003	FORD	WINDSTAR
2001-2002	FORD	EXPEDITION
1999-2001	FORD	EXPLORER
2006-2008	LINCOLN	MARK LT
2005-2008	LINCOLN	NAVIGATOR
2001-2002	LINCOLN	NAVIGATOR
2001-2010	MAZDA	B2300
2001-2008	MAZDA	B3000
2004-2010	MERCURY	MOUNTAINEER
2004-2007	MERCURY	MONTEREY
1999-2001	MERCURY	MOUNTAINEER
<b>234-4403</b> B		
2009-2012	FORD	E-350 SUPER DUTY
2001-2011	FORD	RANGER
2007-2008	FORD	EXPEDITION
2001-2005	FORD	EXPLORER SPORT
1999-2003	FORD	EXPLORER
2007-2008	LINCOLN	NAVIGATOR
2001-2010	MAZDA	B4000
2007-2008	MAZDA	B3000
1999-2002	MERCURY	MOUNTAINEER
<b>234-4407</b> A		
2003-2006	CADILLAC	ESCALADE
2003-2006	CADILLAC	ESCALADE ESV
2003-2006	CADILLAC	ESCALADE EXT
2003-2007	CHEVROLET	EXPRESS 1500
2003-2007	CHEVROLET	EXPRESS 2500
2003-2007	CHEVROLET	EXPRESS 3500
2002-2007	CHEVROLET	SILVERADO 2500 HD
2007	CHEVROLET	SILVERADO 1500

#PART PIECE PARTE	MFR/ MARQUE FABRICANTE	MODEL MODELE MODELO
<b>234-4407 (CONT.)</b> A		
2007	CHEVROLET	SILVERADO 1500 HD
2007	CHEVROLET	SILVERADO 2500 HD
2007	CHEVROLET	SILVERADO 3500
2007	CHEVROLET	SILVERADO 3500 HD
2005-2006	CHEVROLET	SILVERADO 1500 HD
2003-2006	CHEVROLET	SILVERADO 1500
2002-2006	CHEVROLET	SILVERADO 3500
2002-2006	CHEVROLET	SUBURBAN 2500
2006	CHEVROLET	SUBURBAN 1500
2003-2005	CHEVROLET	TAHOE
2002-2004	CHEVROLET	SILVERADO 2500
2002-2003	CHEVROLET	SILVERADO 1500 HD
2003-2007	GMC	SAVANA 1500
2003-2007	GMC	SAVANA 2500
2003-2007	GMC	SAVANA 3500
2002-2007	GMC	SIERRA 2500 HD
2007	GMC	SIERRA 1500 CLASSIC
2007	GMC	SIERRA 1500 HD
2007	GMC	SIERRA 2500 HD
2007	GMC	SIERRA 3500 CLASSIC
2007	GMC	SIERRA 3500 HD
2005-2006	GMC	SIERRA 1500 HD
2003-2006	GMC	YUKON
2002-2006	GMC	SIERRA 1500
2002-2006	GMC	SIERRA 3500
2002-2006	GMC	YUKON XL 1500
2002-2006	GMC	YUKON XL 2500
2002-2004	GMC	SIERRA 2500
2002-2003	GMC	SIERRA 1500 HD
2003-2006	HUMMER	H2
<b>234-4408</b> C		
2010-2011	AUDI	A6
2009	AUDI	A6 QUATTRO
2005-2006	AUDI	A4 QUATTRO
2006	AUDI	A4
<b>234-4409</b> C		
2010-2011	AUDI	A6
2009	AUDI	A6 QUATTRO
2005-2006	AUDI	A4 QUATTRO
2006	AUDI	A4
<b>234-4410</b> A		
2004-2005	CHRYSLER	TOWN & COUNTRY
2005	CHRYSLER	PACIFICA
2004-2005	DODGE	CARAVAN
2004-2005	DODGE	GRAND CARAVAN
<b>234-4411</b> D		
2004	CHRYSLER	PACIFICA
<b>234-4412</b> D		
2004	CHRYSLER	PACIFICA
<b>234-4413</b> C		
2005-2011	AUDI	A6 QUATTRO

#PART PIECE PARTE	MFR/ MARQUE FABRICANTE	MODEL MODELE MODELO
<b>234-4413 (CONT.)</b> C		
2006-2009	AUDI	A4 QUATTRO
2006-2009	AUDI	A6
2006-2008	AUDI	A4
<b>234-4414</b> C		
2011-2015	AUDI	Q7
2005-2011	AUDI	A6 QUATTRO
2006-2009	AUDI	A4 QUATTRO
2006-2009	AUDI	A6
2006-2008	AUDI	A4
<b>234-4416</b> C		
2011-2014	TOYOTA	SIENNA
<b>234-4417</b> C		
2011	DODGE	DURANGO
2010-2011	JEEP	WRANGLER
2011	JEEP	GRAND CHEROKEE
<b>234-4418</b> C		
2007	CHRYSLER	300
2007	DODGE	CHARGER
2007	DODGE	MAGNUM
<b>234-4419</b> C		
2010-2013	FORD	TRANSIT CONNECT
<b>234-4420</b> C		
2006	CHEVROLET	EPICA
2006	SUZUKI	VERONA
<b>234-4421</b> D		
2004-2005	CHEVROLET	EPICA
2004-2005	SUZUKI	VERONA
<b>234-4422</b> D		
2004-2005	CHEVROLET	EPICA
2004-2005	SUZUKI	VERONA
<b>234-4423</b> D		
2006-2007	CHEVROLET	OPTRA
2006-2008	SUZUKI	FORENZA
2006-2008	SUZUKI	RENO
<b>234-4424</b> C		
2000	SUZUKI	ESTEEM
<b>234-4425</b> C		
2006	CHEVROLET	EPICA
2006	SUZUKI	VERONA
<b>234-4426</b> C		
2006	CHEVROLET	EPICA
2006	SUZUKI	VERONA
<b>234-4427</b> C		
2004-2005	SUZUKI	FORENZA
2005	SUZUKI	RENO
<b>234-4428</b> C		
1995-1997	HYUNDAI	ACCENT
<b>234-4429</b> C		
2007-2009	HYUNDAI	SANTA FE
2007-2012	KIA	RONDO
2007-2010	KIA	MAGENTIS



#PART PIECE PARTE	MFR / MARQUE FABRICANTE	MODEL MODELE MODELO	
<b>234-4429 (CONT.)</b>			<b>C</b>
2006-2010	KIA	OPTIMA	
<b>234-4430</b>			<b>C</b>
2006-2007	MITSUBISHI	LANCER	
<b>234-4431</b>			<b>C</b>
2003	HYUNDAI	TIBURON	
2001-2002	HYUNDAI	SANTA FE	
1999-2002	HYUNDAI	SONATA	
2001-2002	KIA	MAGENTIS	
2001-2002	KIA	OPTIMA	
<b>234-4432</b>			<b>D</b>
2003	HYUNDAI	TIBURON	
2001-2002	HYUNDAI	SANTA FE	
1999-2002	HYUNDAI	SONATA	
2001-2002	KIA	MAGENTIS	
2001-2002	KIA	OPTIMA	
<b>234-4433</b>			<b>C</b>
2006-2008	HYUNDAI	SONATA	
2007-2009	KIA	MAGENTIS	
2006-2009	KIA	OPTIMA	
2007-2008	KIA	RONDO	
<b>234-4434</b>			<b>D</b>
2001-2006	HYUNDAI	SANTA FE	
1999-2005	HYUNDAI	SONATA	
2002-2003	HYUNDAI	XG350	
2001	HYUNDAI	XG300	
2001-2006	KIA	MAGENTIS	
2001-2006	KIA	OPTIMA	
2002-2005	KIA	SEDONA	
<b>234-4435</b>			<b>C</b>
2002-2005	HYUNDAI	XG350	
2001	HYUNDAI	XG300	
2004-2006	KIA	AMANTI	
<b>234-4436</b>			<b>D</b>
2001-2006	HYUNDAI	SANTA FE	
1999-2005	HYUNDAI	SONATA	
2001	HYUNDAI	XG300	
2001-2006	KIA	MAGENTIS	
2001-2006	KIA	OPTIMA	
<b>234-4437</b>			<b>C</b>
2007-2009	HYUNDAI	SANTA FE	
<b>234-4438</b>			<b>C</b>
2007-2009	HYUNDAI	SANTA FE	
2007-2012	KIA	RONDO	
2007-2010	KIA	MAGENTIS	
2006-2010	KIA	OPTIMA	
<b>234-4439</b>			<b>D</b>
2006-2008	HYUNDAI	SONATA	
2007-2009	KIA	MAGENTIS	
2006-2009	KIA	OPTIMA	
2007-2008	KIA	RONDO	

#PART PIECE PARTE	MFR / MARQUE FABRICANTE	MODEL MODELE MODELO	
<b>234-4440</b>			<b>C</b>
1993	VOLVO	850	
<b>234-4441</b>			<b>C</b>
2013-2015	CADILLAC	ATS	
2010-2015	CADILLAC	CTS	
2010-2015	CHEVROLET	CAMARO	
<b>234-4442</b>			<b>C</b>
2010-2011	HONDA	CR-V	
<b>234-4443</b>			<b>C</b>
2004	ACURA	RL	
<b>234-4444</b>			<b>C</b>
2010-2013	HYUNDAI	TUCSON	
2011-2014	KIA	SPORTAGE	
<b>234-4445</b>			<b>D</b>
2006	SAAB	9-2X	
2006-2012	SUBARU	LEGACY	
2006-2012	SUBARU	OUTBACK	
2006-2011	SUBARU	IMPREZA	
2006-2010	SUBARU	FORESTER	
<b>234-4446</b>			<b>C</b>
2004-2009	SUBARU	LEGACY	
2004-2009	SUBARU	OUTBACK	
2002	SUBARU	IMPREZA	
<b>234-4447</b>			<b>C</b>
2008-2014	SUBARU	LEGACY	
2008-2014	SUBARU	TRIBECA	
2005-2014	SUBARU	OUTBACK	
2006-2007	SUBARU	B9 TRIBECA	
<b>234-4448</b>			<b>C</b>
2011	HYUNDAI	SONATA	
2011-2014	KIA	OPTIMA	
<b>234-4449</b>			<b>C</b>
2010-2012	HYUNDAI	GENESIS COUPE	
<b>234-4450</b>			<b>D</b>
2012-2015	JAGUAR	XKR-S	
2010-2015	JAGUAR	XK	
2010-2015	JAGUAR	XKR	
2010-2013	JAGUAR	XJ	
2011-2012	JAGUAR	XF	
2011-2012	JAGUAR	XFR	
2007-2014	VOLVO	XC90	
2003-2007	VOLVO	V70	
2005-2006	VOLVO	S40	
2005-2006	VOLVO	V50	
2003-2005	VOLVO	S60	
<b>234-4451</b>			<b>C</b>
2005-2014	VOLVO	XC90	
2007-2010	VOLVO	S80	
<b>234-4452</b>			<b>D</b>
2002	VOLVO	S60	
2002	VOLVO	V70	

#PART PIECE PARTE	MFR / MARQUE FABRICANTE	MODEL MODELE MODELO	
<b>234-4453</b>			<b>C</b>
2014-2015	VOLVO	S60	
2014-2015	VOLVO	XC70	
2010-2015	VOLVO	XC60	
2015	VOLVO	V60	
2014	VOLVO	S80	
2011-2012	VOLVO	S60	
2005-2011	VOLVO	XC90	
2009-2010	VOLVO	XC70	
2007-2010	VOLVO	S80	
2010	VOLVO	V70	
2005-2007	VOLVO	V70	
2005	VOLVO	S60	
<b>234-4454</b>			<b>C</b>
2010-2013	LAND ROVER	LR4	
2010-2013	LAND ROVER	RANGE ROVER SPORT	
2010-2015	VOLVO	XC60	
2008-2015	VOLVO	XC70	
2007-2015	VOLVO	S80	
2015	VOLVO	S60	
2015	VOLVO	V60	
2013	VOLVO	S60	
2008-2010	VOLVO	V70	
2007-2010	VOLVO	C30	
2005-2010	VOLVO	V50	
2004-2010	VOLVO	S40	
<b>234-4455</b>			<b>C</b>
2013-2015	HYUNDAI	SANTA FE XL	
2010-2015	HYUNDAI	SANTA FE	
2011-2015	KIA	SORENTO	
<b>234-4456</b>			<b>C</b>
2013-2015	HYUNDAI	GENESIS COUPE	
2013-2015	HYUNDAI	SANTA FE XL	
2012-2015	HYUNDAI	AZERA	
2012-2015	HYUNDAI	GENESIS	
2010-2015	HYUNDAI	SANTA FE	
2014-2015	KIA	CADENZA	
2011-2015	KIA	SORENTO	
2014	KIA	SEDONA	
2011-2012	KIA	SEDONA	
<b>234-4457</b>			<b>D</b>
2002-2008	MINI	COOPER	
<b>234-4458</b>			<b>C</b>
2013-2015	HYUNDAI	GENESIS COUPE	
2013-2015	HYUNDAI	SANTA FE XL	
2012-2015	HYUNDAI	AZERA	
2010-2015	HYUNDAI	SANTA FE	
2014-2015	KIA	CADENZA	
2011-2015	KIA	SORENTO	
2014	KIA	SEDONA	
2011-2012	KIA	SEDONA	



#PART PIECE PARTE	MFR/ MARQUE FABRICANTE	MODEL MODELE MODELO
<b>234-4461</b> C		
2013-2015	ACURA	RDX
2010-2014	ACURA	TSX
2009-2014	ACURA	TL
2010-2013	ACURA	MDX
2010-2013	ACURA	ZDX
2009-2012	ACURA	RL
2009-2015	HONDA	PILOT
2009-2014	HONDA	RIDGELINE
2008-2013	HONDA	ODYSSEY
2008-2012	HONDA	ACCORD
2012	HONDA	CROSSTOUR
2010-2011	HONDA	ACCORD CROSSTOUR
<b>234-4462</b> C		
2009-2014	ACURA	TSX
2008-2012	HONDA	ACCORD
<b>234-4463</b> C		
2013-2015	HYUNDAI	SANTA FE XL
2012-2015	HYUNDAI	GENESIS
2010-2015	HYUNDAI	SANTA FE
2011-2014	KIA	SORENTO
<b>234-4464</b> C		
2010-2012	HYUNDAI	GENESIS COUPE
<b>234-4465</b> C		
2010-2013	LAND ROVER	LR4
2010-2013	LAND ROVER	RANGE ROVER SPORT
2010-2012	LAND ROVER	RANGE ROVER
<b>234-4466</b> C		
2010-2012	MAZDA	CX-7
<b>234-4467</b> C		
2012-2013	MAZDA	3 SPORT
2010-2013	MAZDA	3
2010	MAZDA	3 SPORT
<b>234-4468</b> C		
2002	NISSAN	SENTRA
<b>234-4470</b> C		
2006-2010	BMW	M5
2006-2010	BMW	M6
2007-2008	BMW	ALPINA B7
2004-2006	BMW	760I
2004-2006	BMW	X5
2003-2006	BMW	760LI
2004-2005	BMW	545I
2004-2005	BMW	645CI
2002-2005	BMW	745I
2002-2005	BMW	745LI
2004-2007	ROLLS-ROYCE	PHANTOM
<b>234-4472</b> C		
2004-2006	BMW	X5
<b>234-4473</b> C		
2004-2006	BMW	X3
2003-2006	BMW	325CI

#PART PIECE PARTE	MFR/ MARQUE FABRICANTE	MODEL MODELE MODELO
<b>234-4473 (CONT.)</b> C		
2003-2006	BMW	330CI
2004-2005	BMW	525I
2004-2005	BMW	530I
2003-2005	BMW	325I
2003-2005	BMW	330I
<b>234-4474</b> C		
2014-2015	PORSCHE	CAYMAN
2013-2015	PORSCHE	BOXSTER
2010-2015	PORSCHE	PANAMERA
<b>234-4475</b> C		
2010-2015	PORSCHE	PANAMERA
2015	PORSCHE	918 SPYDER
2009-2014	PORSCHE	911
<b>234-4476</b> C		
2010-2012	LEXUS	HS250H
<b>234-4477</b> C		
2010-2012	BMW	X3
<b>234-4478</b> C		
2010-2012	BMW	X3
2011	BMW	528I
<b>234-4479</b> C		
2013-2015	BMW	740I
2013-2015	BMW	740LI
2013-2015	BMW	740LI XDRIVE
2013-2015	BMW	ACTIVEHYBRID 7
2011-2015	BMW	535I
2011-2015	BMW	535I GT XDRIVE
2011-2015	BMW	535I XDRIVE
2011-2015	BMW	X3
2010-2015	BMW	535I GT
2015	BMW	X4
2013-2014	BMW	640I GRAN COUPE
2012-2014	BMW	640I
2011-2014	BMW	X6
2014	BMW	335I GT XDRIVE
2014	BMW	640I XDRIVE
2014	BMW	640I XDRIVE GRAN
2012-2013	BMW	ACTIVEHYBRID 5
2011-2013	BMW	135I
2011-2013	BMW	335I
2011-2013	BMW	X5
2013	BMW	135IS
2013	BMW	ACTIVEHYBRID 3
2011	BMW	528I
<b>234-4480</b> C		
2013-2015	BMW	X1
2011-2013	BMW	335I XDRIVE
<b>234-4481</b> C		
1992-1995	BMW	320I
<b>234-4482</b> C		
1992-1995	BMW	320I

#PART PIECE PARTE	MFR/ MARQUE FABRICANTE	MODEL MODELE MODELO
<b>234-4483</b> C		
2012-2014	FIAT	500
<b>234-4484</b> C		
2011-2015	AUDI	Q7
<b>234-4485</b> C		
2013-2015	AUDI	R55
2008-2012	AUDI	S5
2007-2012	AUDI	A8 QUATTRO
2007-2011	AUDI	A6 QUATTRO
2007-2011	AUDI	S6
2007-2010	AUDI	Q7
2007-2009	AUDI	S8
2008-2015	PORSCHE	CAYENNE
2011-2015	VOLKSWAGEN	JETTA
2009-2015	VOLKSWAGEN	CC
2009-2010	VOLKSWAGEN	PASSAT CC
2007-2010	VOLKSWAGEN	TOUAREG
2006-2010	VOLKSWAGEN	PASSAT
2007-2008	VOLKSWAGEN	EOS
2008	VOLKSWAGEN	R32
<b>234-4487</b> C		
2010-2015	VOLVO	XC70
2010-2014	VOLVO	S80
2010-2014	VOLVO	XC60
2010	VOLVO	V70
<b>234-4488</b> C		
2013-2015	MINI	COOPER PACEMAN
2011-2015	MINI	COOPER
2007-2015	MINI	COOPER
<b>234-4489</b> C		
2011-2015	FORD	EXPLORER
2011-2015	FORD	FLEX
2011-2015	FORD	TAURUS
2015	FORD	TRANSIT-150
2015	FORD	TRANSIT-250
2015	FORD	TRANSIT-350
2013-2014	FORD	POLICE INTERCEPTOR
2011-2014	FORD	EDGE
2011-2012	FORD	FUSION
2011-2015	LINCOLN	MKT
2011-2014	LINCOLN	MKX
2011-2012	LINCOLN	MKS
2011-2012	LINCOLN	MKZ
2011-2015	MAZDA	CX-9
2011-2013	MAZDA	6
2011	MERCURY	MILAN
<b>234-4490</b> C		
2013-2015	FORD	EXPLORER
2013-2015	FORD	FLEX
2013-2015	FORD	TAURUS
2015	FORD	TRANSIT-150
2015	FORD	TRANSIT-250

**NUMERICAL LISTING**



#PART PIECE PARTE	MFR / MARQUE FABRICANTE	MODEL MODELE MODELO	
<b>234-4490 (CONT.)</b>			<b>C</b>
2015	FORD	TRANSIT-350	
2013-2014	FORD	POLICE INTERCEPTOR	
2013-2014	FORD	POLICE INTERCEPTOR	
2011-2014	FORD	F-150	
2011-2014	FORD	MUSTANG	
2011-2012	FORD	ESCAPE	
2011-2012	FORD	FUSION	
2013-2015	LINCOLN	MKS	
2013-2015	LINCOLN	MKT	
2011-2015	LINCOLN	MKZ	
2011	MERCURY	MARINER	
2011	MERCURY	MILAN	
<b>234-4491</b>			<b>C</b>
2013-2015	FORD	EXPLORER	
2011-2015	FORD	FLEX	
2011-2015	FORD	TAURUS	
2013-2014	FORD	POLICE INTERCEPTOR	
2011-2015	LINCOLN	MKS	
2011-2015	LINCOLN	MKT	
<b>234-4492</b>			<b>C</b>
2011-2012	LINCOLN	MKZ	
<b>234-4493</b>			<b>C</b>
2011-2015	FORD	FIESTA	
<b>234-4494</b>			<b>C</b>
2011-2014	FORD	F-150	
<b>234-4495</b>			<b>C</b>
2011-2014	FORD	E-350 SUPER DUTY	
<b>234-4496</b>			<b>C</b>
2011-2015	PORSCHE	CAYENNE	
2006-2012	PORSCHE	CAYMAN	
2005-2012	PORSCHE	BOXSTER	
2010-2011	PORSCHE	911	
2007-2008	PORSCHE	911	
<b>234-4497</b>			<b>D</b>
2015	PORSCHE	PANAMERA	
<b>234-4498</b>			<b>C</b>
2011-2015	PORSCHE	CAYENNE	
<b>234-4499</b>			<b>C</b>
2011-2014	PORSCHE	CAYENNE	
<b>234-4501</b>			<b>D</b>
2006-2012	TOYOTA	RAV4	
<b>234-4502</b>			<b>C</b>
2006-2008	LEXUS	RX400H	
2006-2010	TOYOTA	HIGHLANDER	
<b>234-4503</b>			<b>C</b>
2004-2005	TOYOTA	RAV4	
<b>234-4504</b>			<b>D</b>
2004-2007	TOYOTA	HIGHLANDER	
<b>234-4505</b>			<b>C</b>
2012-2014	MAZDA	5	
2012-2013	MAZDA	3 SPORT	

#PART PIECE PARTE	MFR / MARQUE FABRICANTE	MODEL MODELE MODELO	
<b>234-4505 (CONT.)</b>			<b>C</b>
2011-2013	MAZDA	3	
<b>234-4506</b>			<b>D</b>
2006-2010	LEXUS	SC430	
<b>234-4507</b>			<b>C</b>
1990-1991	TOYOTA	PICKUP	
<b>234-4508</b>			<b>C</b>
1990-1992	GEO	PRIZM	
1989-1991	TOYOTA	COROLLA	
<b>234-4509</b>			<b>D</b>
2007-2015	LEXUS	RX350	
2010-2013	LEXUS	RX450H	
2004-2006	LEXUS	RX330	
2004-2016	TOYOTA	HIGHLANDER	
<b>234-4511</b>			<b>C</b>
1992-1993	TOYOTA	PICKUP	
<b>234-4512</b>			<b>D</b>
2004-2010	TOYOTA	SIENNA	
<b>234-4513</b>			<b>C</b>
2013-2015	SUBARU	XV CROSSTREK	
2012-2015	SUBARU	IMPREZA	
2011-2015	SUBARU	FORESTER	
<b>234-4514</b>			<b>C</b>
1993-1998	TOYOTA	SUPRA	
<b>234-4515</b>			<b>C</b>
2008-2015	LEXUS	LS600H	
2007-2013	LEXUS	LS460	
<b>234-4516</b>			<b>C</b>
2004-2010	TOYOTA	SIENNA	
<b>234-4517</b>			<b>C</b>
2001-2005	LEXUS	IS300	
<b>234-4518</b>			<b>D</b>
2011-2013	LEXUS	IS350	
2006-2013	LEXUS	IS250	
<b>234-4519</b>			<b>D</b>
2013	LEXUS	GS350	
2007-2011	LEXUS	GS350	
<b>234-4520</b>			<b>C</b>
1993-1995	TOYOTA	LAND CRUISER	
<b>234-4521</b>			<b>D</b>
2008-2014	LEXUS	IS F	
2006-2013	LEXUS	IS250	
2006-2013	LEXUS	IS350	
2013	LEXUS	GS350	
2007-2011	LEXUS	GS350	
2007-2011	LEXUS	GS450H	
2005-2007	LEXUS	GS430	
<b>234-4522</b>			<b>C</b>
2011-2015	MERCEDES-BENZ	SLS AMG	
2010-2011	MERCEDES-BENZ	ML450	
<b>234-4523</b>			<b>C</b>
2005-2009	MERCEDES-BENZ	SL65 AMG	

#PART PIECE PARTE	MFR / MARQUE FABRICANTE	MODEL MODELE MODELO	
<b>234-4524</b>			<b>D</b>
2004-2006	SCION	XA	
2004-2006	SCION	XB	
2003-2005	TOYOTA	ECHO	
<b>234-4526</b>			<b>C</b>
2011-2015	BUICK	REGAL	
2015	BUICK	LACROSSE	
2014	BUICK	VERANO	
2011-2013	BUICK	LACROSSE	
2013-2014	CHEVROLET	MALIBU	
2014	CHEVROLET	IMPALA	
2011	SAAB	9-5	
<b>234-4527</b>			<b>C</b>
2012-2015	CHEVROLET	SONIC	
2011-2015	CHEVROLET	CRUZE	
2010-2011	SAAB	9-5	
<b>234-4528</b>			<b>C</b>
2012-2015	CHEVROLET	SONIC	
2011-2015	CHEVROLET	CRUZE	
2013-2014	CHEVROLET	TRAX	
<b>234-4529</b>			<b>C</b>
2013	BUICK	ENCORE	
2014	CADILLAC	ELR	
2011-2015	CHEVROLET	CRUZE	
2011-2015	CHEVROLET	VOLT	
2012-2013	CHEVROLET	SONIC	
2013	CHEVROLET	TRAX	
<b>234-4530</b>			<b>C</b>
2012-2015	CHEVROLET	CAPTIVA SPORT	
2015	CHEVROLET	EQUINOX	
2011-2013	CHEVROLET	EQUINOX	
2011-2015	GMC	TERRAIN	
<b>234-4533</b>			<b>C</b>
1995	VOLKSWAGEN	PASSAT	
<b>234-4534</b>			<b>C</b>
2014-2015	INFINITI	Q50	
2014-2015	INFINITI	Q70	
2012	INFINITI	M35H	
2014-2015	NISSAN	VERSA NOTE	
2012-2015	NISSAN	VERSA	
2015	NISSAN	MICRA	
<b>234-4535</b>			<b>C</b>
2014-2015	INFINITI	Q60	
2014-2015	INFINITI	Q70	
2015	INFINITI	Q40	
2015	INFINITI	Q50	
2015	INFINITI	Q70L	
2015	INFINITI	QX50	
2015	INFINITI	QX70	
2014-2015	NISSAN	370Z	
2011-2015	NISSAN	JUKE	



#PART PIECE PARTE	MFR/ MARQUE FABRICANTE	MODEL MODELE MODELO	
<b>234-4536</b>			C
2011-2014	NISSAN	CUBE	
<b>234-4537</b>			C
2011-2013	TOYOTA	SIENNA	
<b>234-4538</b>			C
2012-2015	SCION	IQ	
<b>234-4539</b>			C
2011-2014	TOYOTA	SIENNA	
<b>234-4540</b>			C
2011-2014	TOYOTA	SIENNA	
<b>234-4543</b>			C
2010-2014	ACURA	TL	
<b>234-4544</b>			C
2011-2015	HONDA	CR-Z	
2012-2014	HONDA	INSIGHT	
<b>234-4545</b>			C
2011-2015	CHRYSLER	200	
2011-2015	CHRYSLER	TOWN & COUNTRY	
2011-2014	CHRYSLER	300	
2013-2015	DODGE	DART	
2011-2015	DODGE	CHALLENGER	
2011-2015	DODGE	GRAND CARAVAN	
2015	DODGE	VIPER	
2011-2014	DODGE	AVENGER	
2011-2014	DODGE	CHARGER	
2011-2014	DODGE	DURANGO	
2011-2014	DODGE	JOURNEY	
2014-2015	JEEP	CHEROKEE	
2011-2015	JEEP	GRAND CHEROKEE	
2015	JEEP	RENEGADE	
2012-2014	JEEP	WRANGLER	
2014-2015	RAM	PROMASTER 1500	
2014-2015	RAM	PROMASTER 2500	
2014-2015	RAM	PROMASTER 3500	
2012-2015	RAM	1500	
2012-2015	RAM	2500	
2012-2015	RAM	3500	
2012-2015	RAM	C/V	
2015	RAM	PROMASTER CITY	
2013-2014	SRT	VIPER	
2011-2014	VOLKSWAGEN	ROUTAN	
<b>234-4546</b>			C
2011	RAM	2500	
2011	RAM	3500	
<b>234-4547</b>			C
2011-2015	CHRYSLER	200	
2011-2015	CHRYSLER	TOWN & COUNTRY	
2014	CHRYSLER	300	
2011-2015	DODGE	GRAND CARAVAN	
2012-2014	DODGE	DURANGO	
2011-2014	DODGE	AVENGER	
2011-2014	DODGE	JOURNEY	

#PART PIECE PARTE	MFR/ MARQUE FABRICANTE	MODEL MODELE MODELO	
<b>234-4547 (CONT.)</b>			C
2014	DODGE	CHARGER	
2011-2012	DODGE	CALIBER	
2014-2015	JEEP	CHEROKEE	
2012-2015	JEEP	GRAND CHEROKEE	
2011-2015	JEEP	COMPASS	
2011-2015	JEEP	PATRIOT	
2012-2014	JEEP	WRANGLER	
2012-2015	RAM	1500	
2012-2015	RAM	2500	
2012-2015	RAM	3500	
2012-2015	RAM	C/V	
<b>234-4548</b>			C
2011-2012	KIA	SEDONA	
<b>234-4549</b>			C
2010-2011	KIA	SOUL	
<b>234-4550</b>			C
2013-2014	HYUNDAI	ELANTRA COUPE	
2013-2014	HYUNDAI	ELANTRA GT	
2011-2014	HYUNDAI	ELANTRA	
<b>234-4551</b>			C
2011-2014	HYUNDAI	SONATA	
<b>234-4552</b>			C
2013-2014	HYUNDAI	ELANTRA COUPE	
2013-2014	HYUNDAI	ELANTRA GT	
2011-2014	HYUNDAI	ELANTRA	
2014	KIA	FORTE	
2014	KIA	FORTE KOUP	
<b>234-4553</b>			C
2011-2014	VOLKSWAGEN	ROUTAN	
<b>234-4555</b>			C
2011-2015	FORD	FIESTA	
<b>234-4557</b>			C
2011-2013	SCION	TC	
<b>234-4559</b>			C
2014-2015	MERCEDES-BENZ	CLS63 AMG S	
2014-2015	MERCEDES-BENZ	E63 AMG S	
2013-2015	MERCEDES-BENZ	GL63 AMG	
2013-2015	MERCEDES-BENZ	GLK350	
2013-2015	MERCEDES-BENZ	SL63 AMG	
2013-2015	MERCEDES-BENZ	SL550	
2012-2015	MERCEDES-BENZ	C350	
2012-2015	MERCEDES-BENZ	CLS550	
2012-2015	MERCEDES-BENZ	E63 AMG	
2012-2015	MERCEDES-BENZ	E350	
2012-2015	MERCEDES-BENZ	E550	
2012-2015	MERCEDES-BENZ	ML63 AMG	
2012-2015	MERCEDES-BENZ	SLK350	
2015	MERCEDES-BENZ	CLS400	
2015	MERCEDES-BENZ	E400	
2015	MERCEDES-BENZ	GL550	
2013-2014	MERCEDES-BENZ	C300	

#PART PIECE PARTE	MFR/ MARQUE FABRICANTE	MODEL MODELE MODELO	
<b>234-4559 (CONT.)</b>			C
2013-2014	MERCEDES-BENZ	GL450	
2012-2014	MERCEDES-BENZ	CLS63 AMG	
2012-2014	MERCEDES-BENZ	ML550	
2014	MERCEDES-BENZ	CL63 AMG	
2012-2013	MERCEDES-BENZ	E300	
2012-2013	MERCEDES-BENZ	S550	
2011-2013	MERCEDES-BENZ	S63 AMG	
2013	MERCEDES-BENZ	GL550	
<b>234-4560</b>			C
2014-2015	MERCEDES-BENZ	S63 AMG	
2014-2015	MERCEDES-BENZ	S550	
2011-2014	MERCEDES-BENZ	CL550	
2011-2013	MERCEDES-BENZ	CL63 AMG	
2012	MERCEDES-BENZ	S550	
<b>234-4561</b>			C
2006-2007	BUICK	RAINIER	
2006-2007	CHEVROLET	TRAILBLAZER	
2007	CHEVROLET	EXPRESS 1500	
2006	CHEVROLET	SSR	
2006	CHEVROLET	TRAILBLAZER EXT	
2006-2007	GMC	ENVOY	
2007	GMC	SAVANA 1500	
2006	GMC	ENVOY XL	
2006	ISUZU	ASCENDER	
2006-2007	SAAB	9-7X	
<b>234-4562</b>			C
2014-2015	BMW	228I	
2014-2015	BMW	328I GT XDRIVE	
2014-2015	BMW	428I	
2014-2015	BMW	428I XDRIVE	
2013-2015	BMW	320I XDRIVE	
2013-2015	BMW	328I XDRIVE	
2013-2015	BMW	X3	
2012-2015	BMW	320I	
2012-2015	BMW	328I	
2012-2015	BMW	528I	
2012-2015	BMW	528I XDRIVE	
2012-2015	BMW	X1	
2012-2015	BMW	Z4	
2015	BMW	228I XDRIVE	
2015	BMW	428I GRAN COUPE	
2015	BMW	428I XDRIVE GRAN	
2015	BMW	X4	
<b>234-4563</b>			C
2012-2015	CHEVROLET	SILVERADO 2500 HD	
2012-2015	CHEVROLET	SILVERADO 3500 HD	
2012	CHEVROLET	SUBURBAN 2500	
2012-2015	GMC	SIERRA 2500 HD	
2012-2015	GMC	SIERRA 3500 HD	
<b>234-4564</b>			C
2012-2015	BUICK	LACROSSE	

**NUMERICAL LISTING**



#PART PIECE PARTE	MFR / MARQUE FABRICANTE	MODEL MODELE MODELO	
<b>234-4564 (CONT.)</b>			<b>C</b>
2012-2015	CADILLAC	SRX	
2014-2015	CHEVROLET	IMPALA LIMITED	
2013-2015	CHEVROLET	EQUINOX	
2012-2014	CHEVROLET	IMPALA	
2012	CHEVROLET	CAPTIVA SPORT	
2012-2015	GMC	TERRAIN	
<b>234-4565</b>			<b>C</b>
2012-2015	BUICK	ENCLAVE	
2013-2015	CADILLAC	ATS	
2012-2015	CADILLAC	CTS	
2012-2015	CHEVROLET	CAPRICE	
2012-2015	CHEVROLET	TRAVERSE	
2012	CHEVROLET	CAMARO	
2012-2015	GMC	ACADIA	
<b>234-4566</b>			<b>C</b>
2012-2015	BUICK	ENCLAVE	
2013-2015	CADILLAC	XTS	
2013-2015	CHEVROLET	CAMARO	
2012-2015	CHEVROLET	TRAVERSE	
2015	CHEVROLET	IMPALA	
2012-2015	GMC	ACADIA	
<b>234-4567</b>			<b>C</b>
2012-2016	BUICK	VERANO	
<b>234-4568</b>			<b>C</b>
2012-2014	HYUNDAI	ACCENT	
2012-2014	HYUNDAI	VELOSTER	
2012-2015	KIA	SOUL	
2012-2014	KIA	RIO	
<b>234-4569</b>			<b>C</b>
2012-2013	KIA	SOUL	
<b>234-4570</b>			<b>C</b>
2012-2015	HYUNDAI	GENESIS	
<b>234-4571</b>			<b>C</b>
2013-2015	HYUNDAI	GENESIS COUPE	
2013-2015	HYUNDAI	SANTA FE	
2013-2015	HYUNDAI	SANTA FE XL	
2012-2015	HYUNDAI	AZERA	
2014-2015	KIA	CADENZA	
2014-2015	KIA	SORENTO	
2014	KIA	SEDONA	
<b>234-4572</b>			<b>C</b>
2012-2015	HYUNDAI	AZERA	
2014-2015	KIA	CADENZA	
<b>234-4573</b>			<b>C</b>
2012-2015	HYUNDAI	EQUUS	
2012-2015	HYUNDAI	GENESIS	
2015	KIA	K900	
<b>234-4574</b>			<b>C</b>
2012-2015	HONDA	CROSSTOUR	
<b>234-4575</b>			<b>C</b>
2013-2015	FORD	ESCAPE	

#PART PIECE PARTE	MFR / MARQUE FABRICANTE	MODEL MODELE MODELO	
<b>234-4575 (CONT.)</b>			<b>C</b>
2013-2015	FORD	FUSION	
2012-2015	FORD	EXPLORER	
2013-2014	FORD	TAURUS	
2012-2014	FORD	EDGE	
2012-2014	FORD	FOCUS	
2013-2015	LINCOLN	MKZ	
2015	LINCOLN	MKC	
2013-2014	LINCOLN	MKT	
<b>234-4576</b>			<b>C</b>
2013-2015	FORD	F-250 SUPER DUTY	
2012-2015	FORD	F-350 SUPER DUTY	
2012-2014	FORD	EXPEDITION	
2012-2014	LINCOLN	NAVIGATOR	
<b>234-4577</b>			<b>C</b>
2014-2015	FORD	TRANSIT CONNECT	
2013-2015	FORD	ESCAPE	
<b>234-4578</b>			<b>C</b>
2014-2015	FORD	TRANSIT CONNECT	
2013-2015	FORD	ESCAPE	
2013-2015	FORD	FUSION	
2013-2014	FORD	C-MAX	
2013-2015	LINCOLN	MKZ	
<b>234-4579</b>			<b>C</b>
2013-2015	DODGE	DART	
2015	DODGE	VIPER	
2012-2015	RAM	1500	
2012-2015	RAM	2500	
2012-2015	RAM	3500	
2013-2014	SRT	VIPER	
<b>234-4580</b>			<b>C</b>
2012-2015	HONDA	PILOT	
2012-2014	HONDA	RIDGELINE	
<b>234-4581</b>			<b>C</b>
2013-2015	ACURA	ILX	
2012-2015	HONDA	CIVIC	
<b>234-4582</b>			<b>C</b>
2015	LAND ROVER	RANGE ROVER	
2013-2014	LAND ROVER	LR2	
2012-2013	LAND ROVER	RANGE ROVER	
<b>234-4583</b>			<b>C</b>
2013-2015	MAZDA	CX-5	
<b>234-4584</b>			<b>C</b>
2012-2013	MAZDA	3	
2012-2013	MAZDA	3 SPORT	
<b>234-4585</b>			<b>C</b>
2012-2015	MERCEDES-BENZ	C250	
2012-2015	MERCEDES-BENZ	SLK250	
<b>234-4586</b>			<b>C</b>
2012-2015	MERCEDES-BENZ	ML350	
2015	MERCEDES-BENZ	C400	
2015	MERCEDES-BENZ	GL450	

#PART PIECE PARTE	MFR / MARQUE FABRICANTE	MODEL MODELE MODELO	
<b>234-4586 (CONT.)</b>			<b>C</b>
2015	MERCEDES-BENZ	ML400	
2015	MERCEDES-BENZ	SL400	
2012	MERCEDES-BENZ	R350	
<b>234-4587</b>			<b>A</b>
2005-2012	CHRYSLER	300	
2008-2010	CHRYSLER	TOWN & COUNTRY	
2004-2010	CHRYSLER	SEBRING	
2003-2010	CHRYSLER	PT CRUISER	
2007-2009	CHRYSLER	ASPEN	
2007-2008	CHRYSLER	PACIFICA	
2008-2012	DODGE	CHALLENGER	
2006-2012	DODGE	CHARGER	
2007-2011	DODGE	NITRO	
2009-2010	DODGE	JOURNEY	
2008-2010	DODGE	AVENGER	
2008-2010	DODGE	GRAND CARAVAN	
2007-2010	DODGE	RAM 2500 PICKUP	
2004-2010	DODGE	DAKOTA	
2004-2010	DODGE	RAM 1500 PICKUP	
2007-2009	DODGE	RAM 3500 PICKUP	
2004-2009	DODGE	DURANGO	
2005-2008	DODGE	MAGNUM	
2004-2007	DODGE	CARAVAN	
2004-2006	DODGE	STRATUS	
2003-2005	DODGE	NEON	
2003-2004	DODGE	RAM 2500 PICKUP	
2003-2004	DODGE	RAM 3500 PICKUP	
2003-2004	DODGE	SX 2.0	
2004-2012	JEEP	LIBERTY	
2004-2011	JEEP	WRANGLER	
2006-2010	JEEP	COMMANDER	
2004-2010	JEEP	GRAND CHEROKEE	
2004-2006	JEEP	TJ	
2006-2009	MITSUBISHI	RAIDER	
2011-2014	RAM	1500	
2011	RAM	2500	
2011	RAM	3500	
2011	RAM	DAKOTA	
2009-2010	VOLKSWAGEN	ROUTAN	
<b>234-4588</b>			<b>A</b>
2005-2010	CHRYSLER	300	
2004-2010	CHRYSLER	PT CRUISER	
2004-2010	CHRYSLER	TOWN & COUNTRY	
2008-2009	CHRYSLER	ASPEN	
2005-2008	CHRYSLER	PACIFICA	
2004-2007	CHRYSLER	SEBRING	
2009-2010	DODGE	CHALLENGER	
2009-2010	DODGE	RAM 1500 PICKUP	
2008-2010	DODGE	VIPER	
2006-2010	DODGE	CHARGER	
2005-2010	DODGE	DAKOTA	



#PART PIECE PARTE	MFR/ MARQUE FABRICANTE	MODEL MODELE MODELO	
<b>234-4588 (CONT.)</b>			<b>A</b>
2005-2010	DODGE	RAM 2500 PICKUP	
2004-2010	DODGE	GRAND CARAVAN	
2007-2009	DODGE	DURANGO	
2005-2009	DODGE	RAM 3500 PICKUP	
2005-2008	DODGE	MAGNUM	
2004-2007	DODGE	CARAVAN	
2004-2006	DODGE	RAM 1500 PICKUP	
2004-2006	DODGE	STRATUS	
2004-2005	DODGE	NEON	
2004-2005	DODGE	SX 2.0	
2005	DODGE	DURANGO	
2004-2006	JEEP	TJ	
2004-2006	JEEP	WRANGLER	
2004	JEEP	GRAND CHEROKEE	
2004	JEEP	LIBERTY	
2006-2009	MITSUBISHI	RAIDER	
2011-2012	RAM	1500	
2011	RAM	2500	
2011	RAM	3500	
2011	RAM	DAKOTA	
2009-2010	VOLKSWAGEN	ROUTAN	
<b>234-4589</b>			<b>C</b>
2012-2013	AUDI	A8 QUATTRO	
<b>234-4590</b>			<b>C</b>
2003	CHRYSLER	VOYAGER	
2003	DODGE	CARAVAN	
<b>234-4591</b>			<b>C</b>
2012-2014	AUDI	A8 QUATTRO	
<b>234-4592</b>			<b>C</b>
2002-2004	CHRYSLER	300M	
2002-2004	CHRYSLER	CONCORDE	
2002-2004	CHRYSLER	INTREPID	
2002-2004	DODGE	INTREPID	
<b>234-4593</b>			<b>C</b>
2005-2006	CHRYSLER	300	
2005-2006	DODGE	DAKOTA	
2005-2006	DODGE	DURANGO	
2005-2006	DODGE	MAGNUM	
2005-2006	DODGE	RAM 1500 PICKUP	
2005-2006	DODGE	RAM 2500 PICKUP	
2005-2006	DODGE	RAM 3500 PICKUP	
2006	DODGE	CHARGER	
2005-2006	JEEP	GRAND CHEROKEE	
2005-2006	JEEP	LIBERTY	
2005-2006	JEEP	TJ	
2005-2006	JEEP	WRANGLER	
2006	JEEP	COMMANDER	
2006	MITSUBISHI	RAIDER	
<b>234-4595</b>			<b>C</b>
2014	INFINITI	QX60	
2013	INFINITI	JX35	

#PART PIECE PARTE	MFR/ MARQUE FABRICANTE	MODEL MODELE MODELO	
<b>234-4595 (CONT.)</b>			<b>C</b>
2013-2014	NISSAN	ALTIMA	
2013-2014	NISSAN	PATHFINDER	
2012-2014	NISSAN	MURANO	
2012-2014	NISSAN	QUEST	
<b>234-4596</b>			<b>D</b>
2001-2004	CHRYSLER	SEBRING	
2001-2004	DODGE	STRATUS	
<b>234-4597</b>			<b>C</b>
1998-2000	CHRYSLER	SEBRING	
1998-2000	DODGE	AVENGER	
<b>234-4598</b>			<b>D</b>
2008-2010	DODGE	VIPER	
2006	DODGE	DAKOTA	
2005-2006	JEEP	TJ	
2005-2006	JEEP	WRANGLER	
2006	MITSUBISHI	RAIDER	
<b>234-4599</b>			<b>C</b>
2014	INFINITI	QX60	
2013	INFINITI	JX35	
2013-2015	NISSAN	NV200	
2013-2014	NISSAN	ALTIMA	
2013-2014	NISSAN	PATHFINDER	
2012-2014	NISSAN	MURANO	
2012-2014	NISSAN	QUEST	
<b>234-4600</b>			<b>D</b>
2015	VOLVO	S60	
2015	VOLVO	S80	
2015	VOLVO	V60	
2015	VOLVO	XC60	
2015	VOLVO	XC70	
<b>234-4601</b>			<b>A</b>
2001-2002	ACURA	MDX	
1997-1999	ACURA	CL	
1999	ACURA	TL	
2003-2004	HONDA	PILOT	
2000-2003	HONDA	S2000	
1995-1999	HONDA	ACCORD	
1996	HONDA	PRELUDE	
<b>234-4602</b>			<b>C</b>
2000	DODGE	DAKOTA	
2000	DODGE	DURANGO	
1999-2000	JEEP	GRAND CHEROKEE	
<b>234-4603</b>			<b>A</b>
1998-2005	LEXUS	GS300	
1996-2000	LEXUS	SC400	
1995-1997	LEXUS	LS400	
2003-2006	TOYOTA	CAMRY	
2000-2005	TOYOTA	MR2 SPYDER	
<b>234-4604</b>			<b>C</b>
2000-2002	TOYOTA	CELICA	

#PART PIECE PARTE	MFR/ MARQUE FABRICANTE	MODEL MODELE MODELO	
<b>234-4605</b>			<b>C</b>
1996	FORD	ESCORT	
1996	MERCURY	TRACER	
<b>234-4606</b>			<b>D</b>
1995-1996	FORD	ESCORT	
1995-1997	KIA	SEPHIA	
1999-2000	MAZDA	MIATA	
1995-1998	MAZDA	PROTEGE	
1992-1995	MAZDA	MX-3	
1995-1996	MERCURY	TRACER	
<b>234-4607</b>			<b>D</b>
1995-1999	FORD	CONTOUR	
1995-1999	MERCURY	MYSTIQUE	
1999	MERCURY	COUGAR	
<b>234-4608</b>			<b>D</b>
2001-2004	FORD	ESCAPE	
2001-2003	FORD	FOCUS	
2001-2004	MAZDA	TRIBUTE	
<b>234-4609</b>			<b>A</b>
1994-2011	FORD	CROWN VICTORIA	
2006-2010	FORD	FUSION	
2001-2010	FORD	ESCAPE	
2010	FORD	FLEX	
2010	FORD	TAURUS	
2005-2007	FORD	FIVE HUNDRED	
2005-2007	FORD	FREESTYLE	
2000-2004	FORD	FOCUS	
2001-2003	FORD	EXPLORER	
2000-2002	FORD	E-150 VAN	
2000-2001	FORD	E-450 ECONOLINE	
1999-2001	FORD	E-350 SUPER DUTY	
1997-2001	FORD	E-250 VAN	
1997-2001	FORD	E-350 VAN	
1996-2000	FORD	CONTOUR	
1997-1999	FORD	F-250	
1991-1999	FORD	TAURUS	
1999	FORD	ECONOLINE SUPER	
1998	FORD	F-150	
1996-1997	FORD	THUNDERBIRD	
1995-1997	FORD	RANGER	
1992-1994	FORD	TEMPO	
1990-1992	FORD	BRONCO	
1990-1992	FORD	F-150	
1990-1992	FORD	F-250	
1990	FORD	BRONCO II	
1990	FORD	E-150 VAN	
1990	FORD	E-250 VAN	
1990	FORD	E-350 VAN	
1990	FORD	MUSTANG	
1989	FORD	RANGER	
2000	JAGUAR	S-TYPE	
1994-2011	LINCOLN	TOWN CAR	



#PART PIECE PARTE	MFR / MARQUE FABRICANTE	MODEL MODELE MODELO
<b>234-4609 (CONT.) A</b>		
2010	LINCOLN	MKS
2010	LINCOLN	MKT
2000-2003	LINCOLN	LS
1992-1996	LINCOLN	CONTINENTAL
1993-1994	LINCOLN	MARK VIII
2008-2011	MAZDA	TRIBUTE
2001-2006	MAZDA	TRIBUTE
1994-2011	MERCURY	GRAND MARQUIS
2006-2010	MERCURY	MILAN
2005-2010	MERCURY	MARINER
2005-2007	MERCURY	MONTEGO
2003-2004	MERCURY	MARAUDER
2002-2003	MERCURY	MOUNTAINEER
1999-2001	MERCURY	COUGAR
1996-2000	MERCURY	MYSTIQUE
1991-1999	MERCURY	SABLE
1996-1997	MERCURY	COUGAR
1992-1994	MERCURY	TOPAZ
<b>234-4610 A</b>		
2009-2010	FORD	FLEX
2007-2010	FORD	EDGE
2006-2010	FORD	FUSION
2000-2010	FORD	TAURUS
1996-2010	FORD	MUSTANG
2008-2009	FORD	TAURUS X
2005-2007	FORD	FIVE HUNDRED
2005-2007	FORD	FREESTYLE
2004-2007	FORD	FREESTAR
2005-2006	FORD	GT
2002-2005	FORD	THUNDERBIRD
2000-2005	FORD	EXCURSION
1999-2004	FORD	F-250 SUPER DUTY
1999-2004	FORD	F-350 SUPER DUTY
2001-2003	FORD	EXPLORER
1994-2002	FORD	ESCORT
2002	FORD	F-150
1999-2000	FORD	CONTOUR
2000	FORD	E-250 VAN
2000	FORD	E-350 SUPER DUTY
2000	FORD	E-350 VAN
2000	FORD	E-450 ECONOLINE
1996-1997	FORD	THUNDERBIRD
1991-1995	FORD	TAURUS
1992-1994	FORD	CROWN VICTORIA
1992-1994	FORD	TEMPO
1990-1994	FORD	RANGER
1991-1993	FORD	MUSTANG
1991-1993	FORD	THUNDERBIRD
2009-2015	LINCOLN	MKS
2007-2010	LINCOLN	MKX
2007-2010	LINCOLN	MKZ

#PART PIECE PARTE	MFR / MARQUE FABRICANTE	MODEL MODELE MODELO
<b>234-4610 (CONT.) A</b>		
2010	LINCOLN	MKT
2000-2006	LINCOLN	LS
2006	LINCOLN	ZEPHYR
1997-2002	LINCOLN	CONTINENTAL
1993-1998	LINCOLN	MARK VIII
1991-1994	LINCOLN	CONTINENTAL
1991-1994	LINCOLN	TOWN CAR
2009-2010	MAZDA	6
2007-2010	MAZDA	CX-9
2006-2010	MERCURY	MILAN
2008-2009	MERCURY	SABLE
2005-2007	MERCURY	MONTEGO
2004-2007	MERCURY	MONTEREY
2000-2005	MERCURY	SABLE
2002-2003	MERCURY	MOUNTAINEER
1999-2002	MERCURY	COUGAR
1999-2000	MERCURY	MYSTIQUE
1994-1999	MERCURY	TRACER
1996-1997	MERCURY	COUGAR
1991-1995	MERCURY	SABLE
1992-1994	MERCURY	GRAND MARQUIS
1992-1994	MERCURY	TOPAZ
1991-1993	MERCURY	COUGAR
<b>234-4611 A</b>		
1996-2003	FORD	ESCORT
1995-1997	FORD	RANGER
1995	FORD	AEROSTAR
1993	FORD	AEROSTAR
1990-1992	FORD	E-350 VAN
1990-1992	FORD	F-250
1990-1992	FORD	F-350
1990-1992	FORD	RANGER
1990-1991	FORD	AEROSTAR
1990-1991	FORD	E-250 VAN
1991	FORD	EXPLORER
1990	FORD	BRONCO
1990	FORD	E-150 VAN
1990	FORD	F-150
1995-1997	MAZDA	B2300
1996-1999	MERCURY	TRACER
<b>234-4612 D</b>		
1996-1997	KIA	SEPHIA
1995-2002	MAZDA	MILLENNIA
1995-1998	MAZDA	PROTEGE
1996	MAZDA	MX-3
<b>234-4613 D</b>		
2001-2005	HONDA	CIVIC
<b>234-4614 D</b>		
1998-2000	CHRYSLER	SEBRING
2000	CHRYSLER	NEON
1998-2000	DODGE	AVENGER

#PART PIECE PARTE	MFR / MARQUE FABRICANTE	MODEL MODELE MODELO
<b>234-4614 (CONT.) D</b>		
1997-2000	DODGE	NEON
1997-2000	PLYMOUTH	NEON
<b>234-4615 D</b>		
1996	CHEVROLET	BERETTA
1996	CHEVROLET	CORSICA
<b>234-4616 A</b>		
1996-1998	BUICK	SKYLARK
1995-2002	CHEVROLET	CAVALIER
1996-1998	OLDSMOBILE	ACHIEVA
1998	OLDSMOBILE	CUTLASS
1995-2002	PONTIAC	SUNFIRE
1996-1998	PONTIAC	GRAND AM
<b>234-4617 B</b>		
1997-2003	CHEVROLET	CORVETTE
1997-2003	CHEVROLET	MALIBU
1999-2004	OLDSMOBILE	ALERO
1999	OLDSMOBILE	CUTLASS
1997	OLDSMOBILE	CUTLASS
1999-2004	PONTIAC	GRAND AM
<b>234-4618 C</b>		
1996-1999	SATURN	SC1
1996-1999	SATURN	SC2
1996-1999	SATURN	SL
1996-1999	SATURN	SL1
1996-1999	SATURN	SL2
1996-1999	SATURN	SW1
1996-1999	SATURN	SW2
<b>234-4619 D</b>		
1992-1995	LEXUS	SC400
<b>234-4620 A</b>		
1994-2002	HONDA	ACCORD
2001	HONDA	INSIGHT
<b>234-4621 A</b>		
2000-2005	ACURA	NSX
2001-2003	ACURA	CL
2001-2003	ACURA	EL
1999-2003	ACURA	TL
2001-2003	HONDA	CIVIC
1998-2002	HONDA	ACCORD
1997-2001	HONDA	PRELUDE
1990-1993	HONDA	ACCORD
<b>234-4622 A</b>		
1995-1998	LEXUS	ES300
2009-2010	PONTIAC	VIBE
2009-2013	TOYOTA	MATRIX
2009-2012	TOYOTA	COROLLA
2006-2012	TOYOTA	RAV4
2004-2011	TOYOTA	CAMRY
1999-2003	TOYOTA	SOLARA
1994-2001	TOYOTA	CAMRY
1999-2000	TOYOTA	4RUNNER





#PART PIECE PARTE	MFR/ MARQUE FABRICANTE	MODEL MODELE MODELO	
<b>234-4622 (CONT.)</b>			<b>A</b>
1998-2000	TOYOTA	SIENNA	
1995-1999	TOYOTA	AVALON	
1995-1996	TOYOTA	PASEO	
1995-1996	TOYOTA	TERCEL	
<b>234-4623</b>			<b>A</b>
2008-2011	LEXUS	GS460	
2001-2004	LEXUS	GS430	
1998-2000	LEXUS	GS400	
1993-1997	LEXUS	GS300	
1992-1996	LEXUS	ES300	
2003-2006	PONTIAC	VIBE	
2008-2014	SCION	XD	
2001-2009	TOYOTA	PRIUS	
2003-2006	TOYOTA	MATRIX	
2000-2005	TOYOTA	CELICA	
1998-2000	TOYOTA	SIENNA	
1998	TOYOTA	SUPRA	
1996-1997	TOYOTA	CELICA	
1992-1996	TOYOTA	CAMRY	
<b>234-4624</b>			<b>A</b>
1993-1997	LEXUS	GS300	
2008-2016	TOYOTA	SEQUOIA	
2007-2015	TOYOTA	TUNDRA	
2005-2012	TOYOTA	TACOMA	
2004-2006	TOYOTA	SOLARA	
2003-2006	TOYOTA	CAMRY	
2000-2005	TOYOTA	MR2 SPYDER	
2001-2003	TOYOTA	PRIUS	
2000-2002	TOYOTA	ECHO	
1998-2000	TOYOTA	RAV4	
<b>234-4626</b>			<b>A</b>
2001-2005	LEXUS	IS300	
1998-2005	LEXUS	GS300	
1994-2000	LEXUS	SC300	
1997-2001	TOYOTA	CAMRY	
1999-2000	TOYOTA	SOLARA	
1993-1998	TOYOTA	SUPRA	
<b>234-4627</b>			<b>D</b>
1996-1997	FORD	PROBE	
1996	MAZDA	626	
1996	MAZDA	MX-6	
<b>234-4628</b>			<b>C</b>
1996-1997	FORD	PROBE	
1996	MAZDA	626	
1996	MAZDA	MX-6	
<b>234-4629</b>			<b>D</b>
1995-2002	MAZDA	MILLENNIA	
1996-2000	MAZDA	626	
1996-1997	MAZDA	MX-6	
<b>234-4630</b>			<b>A</b>
2002-2010	LEXUS	SC430	

#PART PIECE PARTE	MFR/ MARQUE FABRICANTE	MODEL MODELE MODELO	
<b>234-4630 (CONT.)</b>			<b>A</b>
2001-2007	LEXUS	GS430	
2001-2006	LEXUS	LS430	
2001-2005	LEXUS	IS300	
1998-2005	LEXUS	GS300	
1998-2000	LEXUS	SC300	
1998	TOYOTA	SUPRA	
<b>234-4631</b>			<b>D</b>
1993-1996	DODGE	STEALTH	
2007-2015	MITSUBISHI	OUTLANDER	
2006-2012	MITSUBISHI	ECLIPSE	
2004-2012	MITSUBISHI	GALANT	
1994-2000	MITSUBISHI	MONTERO	
1993-1999	MITSUBISHI	3000GT	
1997-1998	MITSUBISHI	MONTERO SPORT	
1994-1995	MITSUBISHI	DIAMANTE	
<b>234-4633</b>			<b>A</b>
1993-1996	DODGE	STEALTH	
1995-1996	EAGLE	SUMMIT	
1995-2006	MITSUBISHI	MONTERO	
1999-2004	MITSUBISHI	DIAMANTE	
1997-2004	MITSUBISHI	MONTERO SPORT	
1995-2002	MITSUBISHI	MIRAGE	
1993-1999	MITSUBISHI	3000GT	
1994-1996	MITSUBISHI	DIAMANTE	
1995	MITSUBISHI	EXPO	
<b>234-4634</b>			<b>B</b>
2000	DODGE	DAKOTA	
2000	DODGE	DURANGO	
1999-2000	JEEP	GRAND CHEROKEE	
<b>234-4635</b>			<b>D</b>
1999-2000	JEEP	GRAND CHEROKEE	
<b>234-4636</b>			<b>C</b>
1993	DODGE	RAM 50	
1998-1999	MITSUBISHI	ECLIPSE	
1993-1996	MITSUBISHI	MIGHTY MAX	
<b>234-4637</b>			<b>C</b>
1993	DODGE	RAM 50	
1995-1996	EAGLE	SUMMIT	
1992-1994	HYUNDAI	EXCEL	
1993-1996	MITSUBISHI	MIGHTY MAX	
1995	MITSUBISHI	EXPO	
1993-1994	MITSUBISHI	EXPO LRV	
1992-1994	MITSUBISHI	PRECIS	
<b>234-4638</b>			<b>D</b>
1993-1994	DODGE	COLT	
1993-1996	EAGLE	SUMMIT	
1996-1999	MITSUBISHI	ECLIPSE	
1993-1996	MITSUBISHI	MIRAGE	
1993-1995	MITSUBISHI	EXPO	
1993-1994	MITSUBISHI	EXPO LRV	
1993-1994	PLYMOUTH	COLT	

#PART PIECE PARTE	MFR/ MARQUE FABRICANTE	MODEL MODELE MODELO	
<b>234-4639</b>			<b>D</b>
2003	MITSUBISHI	OUTLANDER	
1999-2000	MITSUBISHI	GALANT	
<b>234-4640</b>			<b>C</b>
1993-1995	DODGE	STEALTH	
1993-1995	MITSUBISHI	3000GT	
<b>234-4641</b>			<b>C</b>
1993-1994	DODGE	COLT	
1995-1998	EAGLE	TALON	
1993-1996	EAGLE	SUMMIT	
2003	MITSUBISHI	OUTLANDER	
1999-2000	MITSUBISHI	GALANT	
1997-2000	MITSUBISHI	DIAMANTE	
1995-2000	MITSUBISHI	ECLIPSE	
1993-2000	MITSUBISHI	MIRAGE	
1993-1994	PLYMOUTH	COLT	
<b>234-4642</b>			<b>C</b>
2002-2006	MITSUBISHI	LANCER	
1997-2000	MITSUBISHI	DIAMANTE	
2000	MITSUBISHI	ECLIPSE	
1992-1993	MITSUBISHI	DIAMANTE	
<b>234-4643</b>			<b>C</b>
1989	DODGE	COLT	
1990	EAGLE	TALON	
1990	MITSUBISHI	ECLIPSE	
1989	MITSUBISHI	MIRAGE	
1990	PLYMOUTH	LASER	
1989	PLYMOUTH	COLT	
<b>234-4644</b>			<b>C</b>
1989-1990	DODGE	2000 GTX	
1990-1994	EAGLE	TALON	
1991-1992	EAGLE	2000 GTX	
1990-1994	HYUNDAI	SONATA	
1990-1994	MITSUBISHI	ECLIPSE	
1989-1992	MITSUBISHI	GALANT	
1990-1994	PLYMOUTH	LASER	
<b>234-4645</b>			<b>D</b>
1997-2000	MITSUBISHI	MIRAGE	
1997-2000	MITSUBISHI	MONTERO SPORT	
1997-1999	MITSUBISHI	3000GT	
1992-1995	MITSUBISHI	MONTERO	
<b>234-4646</b>			<b>A</b>
2005-2009	BUICK	ALLURE	
2005-2009	BUICK	LACROSSE	
2006-2008	BUICK	LUCERNE	
2004-2005	BUICK	LESABRE	
2004-2005	BUICK	PARK AVENUE	
2004	BUICK	REGAL	
2005-2007	CHEVROLET	COBALT	
2004-2005	CHEVROLET	CLASSIC	
2004-2005	CHEVROLET	IMPALA	
2004-2005	CHEVROLET	MALIBU	



#PART PIECE PARTE	MFR / MARQUE FABRICANTE	MODEL MODELE MODELO
<b>234-4646 (CONT.) A</b>		
2004-2005	CHEVROLET	MONTE CARLO
2002-2005	CHEVROLET	CAVALIER
1998-1999	CHEVROLET	ASTRO
1998-1999	GMC	SAFARI
2002-2004	OLDSMOBILE	ALERO
2004-2008	PONTIAC	GRAND PRIX
2004-2005	PONTIAC	BONNEVILLE
2002-2005	PONTIAC	GRAND AM
2002-2005	PONTIAC	SUNFIRE
2003-2007	SATURN	ION
2002-2005	SATURN	VUE
2004	SATURN	L300
2002-2003	SATURN	L200
2002-2003	SATURN	LW200
2002	SATURN	L100
<b>234-4647 A</b>		
2006-2008	BUICK	LUCERNE
2005-2007	BUICK	ALLURE
2005-2007	BUICK	LACROSSE
2005-2007	BUICK	RENDEZVOUS
2005-2007	BUICK	TERRAZA
2004-2005	BUICK	LESABRE
2004-2005	BUICK	PARK AVENUE
2005	BUICK	CENTURY
2004	BUICK	RAINIER
2004	BUICK	REGAL
2006-2007	CHEVROLET	MALIBU
2005-2007	CHEVROLET	CORVETTE
2005-2007	CHEVROLET	EQUINOX
2005-2007	CHEVROLET	UPLANDER
2004-2007	CHEVROLET	IMPALA
2004-2007	CHEVROLET	MONTE CARLO
2005	CHEVROLET	VENTURE
2003-2004	CHEVROLET	SSR
2003-2004	CHEVROLET	TRAILBLAZER EXT
2000-2002	CHEVROLET	ASTRO
2003-2004	GMC	ENVOY XL
2004	GMC	ENVOY XUV
2000-2002	GMC	SAFARI
2003-2004	ISUZU	ASCENDER
2001-2003	OLDSMOBILE	AURORA
2000-2002	OLDSMOBILE	INTRIGUE
2006-2007	PONTIAC	G6
2006-2007	PONTIAC	TORRENT
2005-2007	PONTIAC	MONTANA
2004-2007	PONTIAC	GRAND PRIX
2004-2005	PONTIAC	BONNEVILLE
2005	PONTIAC	AZTEK
2005-2007	SATURN	RELAY
2007	SATURN	AURA

#PART PIECE PARTE	MFR / MARQUE FABRICANTE	MODEL MODELE MODELO
<b>234-4648 D</b>		
1998-2001	CHEVROLET	METRO
1999-2000	CHEVROLET	TRACKER
1996-1997	GEO	METRO
1996-2000	PONTIAC	FIREFLY
1996-2001	SUZUKI	SWIFT
1999-2000	SUZUKI	VITARA
<b>234-4649 D</b>		
1998-2000	CHEVROLET	TRACKER
1996-1997	GEO	TRACKER
1996-1997	PONTIAC	SUNRUNNER
1999-2000	SUZUKI	VITARA
1996-1998	SUZUKI	SIDEKICK
1996-1998	SUZUKI	X-90
<b>234-4650 A</b>		
2002-2004	BUICK	RENDEZVOUS
2001-2004	BUICK	CENTURY
2004	BUICK	RAINIER
2001-2003	CADILLAC	SEVILLE
2000-2003	CADILLAC	DEVILLE
2001-2002	CADILLAC	ELDORADO
2002	CADILLAC	ESCALADE
2003-2004	CHEVROLET	SSR
2003-2004	CHEVROLET	TRAILBLAZER EXT
2001-2004	CHEVROLET	IMPALA
2001-2004	CHEVROLET	MONTE CARLO
2001-2004	CHEVROLET	VENTURE
2001-2003	CHEVROLET	MALIBU
2000-2002	CHEVROLET	ASTRO
2000-2002	CHEVROLET	SILVERADO 1500
2000-2002	CHEVROLET	SUBURBAN 1500
2000-2002	CHEVROLET	TAHOE
2002	CHEVROLET	AVALANCHE 1500
2002	CHEVROLET	BLAZER
2002	CHEVROLET	S10
2000	CHEVROLET	SILVERADO 2500
2003-2004	GMC	ENVOY XL
2004	GMC	ENVOY XUV
2000-2002	GMC	SAFARI
2000-2002	GMC	SIERRA 1500
2000-2002	GMC	YUKON
2000-2002	GMC	YUKON XL 1500
2002	GMC	JIMMY
2002	GMC	SONOMA
2000	GMC	SIERRA 2500
2002	HONDA	PASSPORT
2003-2004	ISUZU	ASCENDER
2002-2004	ISUZU	RODEO
2004	ISUZU	AXIOM
2002-2003	ISUZU	RODEO SPORT
2001-2004	OLDSMOBILE	ALERO
2001-2004	OLDSMOBILE	SILHOUETTE

#PART PIECE PARTE	MFR / MARQUE FABRICANTE	MODEL MODELE MODELO
<b>234-4650 (CONT.) A</b>		
2001-2003	OLDSMOBILE	AURORA
2000-2002	OLDSMOBILE	INTRIGUE
2001-2004	PONTIAC	AZTEK
2001-2004	PONTIAC	GRAND AM
2001-2004	PONTIAC	MONTANA
2001-2003	PONTIAC	GRAND PRIX
<b>234-4651 B</b>		
2005	BUICK	RAINIER
2007	CADILLAC	CTS
2004-2005	CADILLAC	CTS
2001-2003	CADILLAC	SEVILLE
2000-2003	CADILLAC	DEVILLE
2001-2002	CADILLAC	ELDORADO
2004-2007	CHEVROLET	MALIBU
2007	CHEVROLET	SILVERADO 1500
2007	CHEVROLET	SILVERADO 2500 HD
2007	CHEVROLET	SILVERADO 3500 HD
2005	CHEVROLET	SSR
2005	CHEVROLET	TRAILBLAZER EXT
2007	GMC	SIERRA 1500
2007	GMC	SIERRA 2500 HD
2007	GMC	SIERRA 3500 HD
2005	GMC	ENVOY
2005	GMC	ENVOY XL
2005	GMC	ENVOY XUV
2005	ISUZU	ASCENDER
2005-2007	PONTIAC	G6
2005	SAAB	9-7X
2007	SATURN	AURA
<b>234-4652 B</b>		
2001-2005	CHRYSLER	SEBRING
2001-2005	DODGE	STRATUS
2000-2005	MITSUBISHI	ECLIPSE
1999-2003	MITSUBISHI	GALANT
<b>234-4653 B</b>		
2002	DODGE	RAM 1500 PICKUP
2001-2004	JEEP	GRAND CHEROKEE
<b>234-4654 A</b>		
2001-2002	DODGE	DAKOTA
2001-2002	DODGE	DURANGO
2002	DODGE	RAM 1500 PICKUP
2001-2004	JEEP	GRAND CHEROKEE
<b>234-4655 C</b>		
1994-1996	DODGE	STEALTH
2010-2011	MITSUBISHI	ENDEAVOR
2004-2008	MITSUBISHI	ENDEAVOR
1994-1999	MITSUBISHI	3000GT
1997	MITSUBISHI	MONTERO
1994-1996	MITSUBISHI	DIAMANTE
<b>234-4656 A</b>		
2001-2005	CHRYSLER	SEBRING



#PART PIECE PARTE	MFR/ MARQUE FABRICANTE	MODEL MODELE MODELO	
<b>234-4656 (CONT.)</b>			<b>A</b>
2001-2005	DODGE	STRATUS	
2007-2015	MITSUBISHI	OUTLANDER	
2000-2012	MITSUBISHI	ECLIPSE	
1999-2009	MITSUBISHI	GALANT	
1995-2006	MITSUBISHI	MONTERO	
1999-2004	MITSUBISHI	DIAMANTE	
1997-1999	MITSUBISHI	MONTERO SPORT	
<b>234-4657</b>			<b>D</b>
1997-2004	MITSUBISHI	MONTERO SPORT	
2000	MITSUBISHI	MONTERO	
1995	MITSUBISHI	MONTERO	
<b>234-4658</b>			<b>C</b>
1993	DODGE	RAM 50	
1993-1996	MITSUBISHI	MIGHTY MAX	
<b>234-4659</b>			<b>C</b>
1996-2001	ACURA	INTEGRA	
1997-1998	ACURA	EL	
1996-1998	HONDA	CIVIC	
<b>234-4660</b>			<b>C</b>
1996-1998	AUDI	A6	
1994	AUDI	100 QUATTRO	
1994	AUDI	100 SERIES	
<b>234-4661</b>			<b>D</b>
1998-1999	AUDI	A6	
1998-1999	AUDI	A6 QUATTRO	
1996-1999	AUDI	A4	
1996-1999	AUDI	A4 QUATTRO	
1994-1998	AUDI	CABRIOLET	
1998-1999	VOLKSWAGEN	PASSAT	
<b>234-4662</b>			<b>C</b>
1997-1999	AUDI	A8	
1997-1999	AUDI	A8 QUATTRO	
1996-1998	AUDI	A6 QUATTRO	
<b>234-4663</b>			<b>D</b>
1996-1999	VOLKSWAGEN	CABRIO	
1996-1999	VOLKSWAGEN	GOLF	
1996-1999	VOLKSWAGEN	JETTA	
<b>234-4664</b>			<b>D</b>
1997-2000	AUDI	A4 QUATTRO	
1998-1999	AUDI	A6	
1998-1999	AUDI	A6 QUATTRO	
1997-1999	AUDI	A4	
1997-1999	AUDI	A8	
1997-1999	AUDI	A8 QUATTRO	
1999-2001	VOLKSWAGEN	EUROVAN	
1995-1999	VOLKSWAGEN	JETTA	
1995-1999	VOLKSWAGEN	PASSAT	
1995-1998	VOLKSWAGEN	GOLF	
1997	VOLKSWAGEN	EUROVAN	
<b>234-4665</b>			<b>D</b>
1993-1999	VOLKSWAGEN	GOLF	

#PART PIECE PARTE	MFR/ MARQUE FABRICANTE	MODEL MODELE MODELO	
<b>234-4665 (CONT.)</b>			<b>D</b>
1993-1999	VOLKSWAGEN	JETTA	
1993-1995	VOLKSWAGEN	PASSAT	
1992-1995	VOLKSWAGEN	CORRADO	
1995	VOLKSWAGEN	CABRIO	
<b>234-4666</b>			<b>C</b>
1997-2000	AUDI	A4 QUATTRO	
1997-1999	AUDI	A4	
1999-2001	VOLKSWAGEN	EUROVAN	
1994-2001	VOLKSWAGEN	PASSAT	
1996-1999	VOLKSWAGEN	CABRIO	
1996-1999	VOLKSWAGEN	GOLF	
1996-1999	VOLKSWAGEN	JETTA	
1997	VOLKSWAGEN	EUROVAN	
<b>234-4668</b>			<b>A</b>
2007-2011	BUICK	LUCERNE	
2005-2009	BUICK	ALLURE	
2005-2009	BUICK	LACROSSE	
2008	BUICK	ENCLAVE	
2006-2007	BUICK	RENDEZVOUS	
2005-2007	BUICK	TERRAZA	
2005	BUICK	RAINIER	
2009-2015	CADILLAC	CTS	
2008-2014	CADILLAC	ESCALADE	
2008-2014	CADILLAC	ESCALADE ESV	
2008-2013	CADILLAC	ESCALADE EXT	
2004-2005	CADILLAC	DEVILLE	
2003-2005	CADILLAC	ESCALADE	
2004	CADILLAC	SEVILLE	
2008-2014	CHEVROLET	SUBURBAN 1500	
2008-2014	CHEVROLET	TAHOE	
2011-2013	CHEVROLET	CAPRICE	
2008-2013	CHEVROLET	AVALANCHE	
2007-2013	CHEVROLET	SILVERADO 1500	
2013	CHEVROLET	SUBURBAN 2500	
2004-2012	CHEVROLET	MALIBU	
2008-2011	CHEVROLET	SUBURBAN 2500	
2007-2011	CHEVROLET	HHR	
2007-2011	CHEVROLET	SILVERADO 2500 HD	
2007-2011	CHEVROLET	SILVERADO 3500 HD	
2006-2011	CHEVROLET	IMPALA	
2007-2010	CHEVROLET	COBALT	
2005-2009	CHEVROLET	EQUINOX	
2005-2009	CHEVROLET	UPLANDER	
2006-2007	CHEVROLET	MONTE CARLO	
2003-2005	CHEVROLET	AVALANCHE 1500	
2003-2005	CHEVROLET	SILVERADO 1500	
2003-2005	CHEVROLET	SUBURBAN 1500	
2003-2005	CHEVROLET	TAHOE	
2005	CHEVROLET	SSR	
2005	CHEVROLET	TRAILBLAZER EXT	
2004	CHEVROLET	CORVETTE	

#PART PIECE PARTE	MFR/ MARQUE FABRICANTE	MODEL MODELE MODELO	
<b>234-4668 (CONT.)</b>			<b>A</b>
2008-2014	GMC	YUKON	
2008-2014	GMC	YUKON XL 1500	
2008-2013	GMC	YUKON XL 2500	
2007-2013	GMC	SIERRA 1500	
2007-2011	GMC	SIERRA 2500 HD	
2007-2011	GMC	SIERRA 3500 HD	
2007-2008	GMC	ACADIA	
2003-2005	GMC	SIERRA 1500	
2003-2005	GMC	YUKON	
2003-2005	GMC	YUKON XL 1500	
2005	GMC	ENVOY	
2005	GMC	ENVOY XL	
2005	GMC	ENVOY XUV	
2005	ISUZU	ASCENDER	
2007-2010	PONTIAC	G5	
2005-2010	PONTIAC	G6	
2008-2009	PONTIAC	G8	
2006-2009	PONTIAC	TORRENT	
2005-2009	PONTIAC	MONTANA	
2005-2008	PONTIAC	GRAND PRIX	
2004-2006	PONTIAC	GTO	
2004-2005	PONTIAC	BONNEVILLE	
2008-2010	SATURN	VUE	
2007-2009	SATURN	AURA	
2007-2008	SATURN	OUTLOOK	
2005-2007	SATURN	RELAY	
2007	SATURN	ION	
<b>234-4669</b>			<b>A</b>
2003-2006	CADILLAC	ESCALADE	
2003-2006	CADILLAC	ESCALADE ESV	
2003-2006	CADILLAC	ESCALADE EXT	
2014-2015	CHEVROLET	CAPRICE	
2014-2015	CHEVROLET	SS	
2010-2015	CHEVROLET	CAMARO	
2007-2014	CHEVROLET	SILVERADO 3500 HD	
2009-2013	CHEVROLET	CORVETTE	
2003-2012	CHEVROLET	SILVERADO 2500 HD	
2007	CHEVROLET	SILVERADO 1500	
2007	CHEVROLET	SILVERADO 1500 HD	
2007	CHEVROLET	SILVERADO 2500 HD	
2007	CHEVROLET	SILVERADO 3500	
2005-2006	CHEVROLET	SILVERADO 1500 HD	
2003-2006	CHEVROLET	AVALANCHE 2500	
2003-2006	CHEVROLET	SILVERADO 1500	
2003-2006	CHEVROLET	SILVERADO 3500	
2003-2006	CHEVROLET	SUBURBAN 2500	
2006	CHEVROLET	SUBURBAN 1500	
2003-2004	CHEVROLET	SILVERADO 2500	
2003	CHEVROLET	SILVERADO 1500 HD	
2007-2014	GMC	SIERRA 3500 HD	
2003-2012	GMC	SIERRA 2500 HD	



#PART PIECE PARTE	MFR / MARQUE FABRICANTE	MODEL MODELE MODELO
<b>234-4669 (CONT.) A</b>		
2007	GMC	SIERRA 1500 CLASSIC
2007	GMC	SIERRA 1500 HD
2007	GMC	SIERRA 2500 HD
2007	GMC	SIERRA 3500 CLASSIC
2005-2006	GMC	SIERRA 1500 HD
2003-2006	GMC	SIERRA 1500
2003-2006	GMC	SIERRA 3500
2003-2006	GMC	YUKON
2003-2006	GMC	YUKON XL 1500
2003-2006	GMC	YUKON XL 2500
2003-2004	GMC	SIERRA 2500
2003	GMC	SIERRA 1500 HD
2003-2006	HUMMER	H2
<b>234-4670 D</b>		
1994-1995	BMW	M3
1992-1995	BMW	318I
1992-1995	BMW	318IS
1992-1995	BMW	325I
1992-1995	BMW	325IS
1995	BMW	318TI
1994	BMW	530I
<b>234-4671 C</b>		
1994-1995	BMW	530I
1994-1995	BMW	540I
1994-1995	BMW	840CI
1993-1994	BMW	740I
1993-1994	BMW	740IL
<b>234-4672 B</b>		
2004-2006	BMW	X3
2000-2006	BMW	X5
2003-2005	BMW	Z4
2001-2005	BMW	320I
2001-2005	BMW	325XI
2001-2005	BMW	330XI
2001-2003	BMW	325CI
2001-2003	BMW	325I
2001-2003	BMW	330CI
2001-2003	BMW	330I
2001-2003	BMW	525I
2001-2003	BMW	530I
2000-2003	BMW	M5
2000-2003	BMW	Z8
1997-2003	BMW	540I
1996-2002	BMW	Z3
1997-2001	BMW	740I
1996-2001	BMW	740IL
1995-2001	BMW	750IL
1999-2000	BMW	323I
1999-2000	BMW	328I
1999-2000	BMW	528I
2000	BMW	323CI

#PART PIECE PARTE	MFR / MARQUE FABRICANTE	MODEL MODELE MODELO
<b>234-4672 (CONT.) B</b>		
2000	BMW	328CI
1996-1999	BMW	318I
1996-1999	BMW	318IS
1996-1999	BMW	318TI
1996-1997	BMW	840CI
1995-1997	BMW	850CI
2003-2005	LAND ROVER	RANGE ROVER
<b>234-4673 D</b>		
2012-2016	BUICK	VERANO
2011-2015	BUICK	REGAL
2015	BUICK	LACROSSE
2010-2013	BUICK	LACROSSE
2010	BUICK	ALLURE
2007-2010	CADILLAC	STS
2007-2009	CADILLAC	SRX
2009-2014	CHEVROLET	MALIBU
2014	CHEVROLET	IMPALA
2012-2013	CHEVROLET	ORLANDO
2007	CHEVROLET	SILVERADO 2500 HD
2007	CHEVROLET	SILVERADO 3500
2003-2006	CHEVROLET	AVALANCHE 2500
2003-2006	CHEVROLET	SILVERADO 2500 HD
2003-2006	CHEVROLET	SILVERADO 3500
2003-2006	CHEVROLET	SUBURBAN 2500
2007	GMC	SIERRA 2500 HD
2007	GMC	SIERRA 3500 CLASSIC
2003-2006	GMC	SIERRA 2500 HD
2003-2006	GMC	SIERRA 3500
2003-2006	GMC	YUKON XL 2500
2009	PONTIAC	G6
2011	SAAB	9-5
2009	SATURN	AURA
<b>234-4674 C</b>		
1994-1995	BMW	850CSI
1988-1993	BMW	325I
1991-1992	BMW	318I
1991-1992	BMW	318IS
1988-1991	BMW	325IS
1988-1991	BMW	325IX
1989-1990	BMW	525I
<b>234-4675 D</b>		
1994-1995	BMW	M3
1992-1995	BMW	325I
1992-1995	BMW	325IS
<b>234-4676 C</b>		
1993-1994	BMW	850CI
1988-1994	BMW	750IL
1994	BMW	530I
1994	BMW	840CI
1991-1992	BMW	850I

#PART PIECE PARTE	MFR / MARQUE FABRICANTE	MODEL MODELE MODELO
<b>234-4677 C</b>		
2001-2006	BMW	M3
2001-2002	BMW	Z3
<b>234-4678 C</b>		
2006-2008	BMW	Z4
2001-2006	BMW	M3
2001-2002	BMW	Z3
<b>234-4679 C</b>		
2006-2008	BMW	Z4
2001-2006	BMW	M3
2001-2002	BMW	Z3
<b>234-4680 C</b>		
1995	BMW	740I
1995	BMW	740IL
<b>234-4681 D</b>		
2000-2003	BMW	M5
1997-2003	BMW	540I
1997-2001	BMW	740I
1996-2001	BMW	740IL
1996-1998	BMW	Z3
1995-1998	BMW	750IL
<b>234-4682 D</b>		
2000-2003	BMW	X5
1998-2001	BMW	750IL
1996-1999	BMW	318I
1996-1999	BMW	318IS
1996-1999	BMW	318TI
<b>234-4683 D</b>		
2004-2006	BMW	X3
2001-2006	BMW	X5
2003-2005	BMW	Z4
2001-2005	BMW	320I
2001-2005	BMW	325XI
2001-2005	BMW	330XI
2001-2003	BMW	325CI
2001-2003	BMW	325I
2001-2003	BMW	330CI
2001-2003	BMW	330I
2001-2003	BMW	525I
2001-2003	BMW	530I
1998-2002	BMW	Z3
1999-2000	BMW	323I
1999-2000	BMW	328I
1999-2000	BMW	528I
2000	BMW	323CI
2000	BMW	328CI
2003-2005	LAND ROVER	RANGE ROVER
<b>234-4684 C</b>		
2000-2003	BMW	Z8
1996-1997	BMW	840CI
1995-1997	BMW	850CI



#PART PIECE PARTE	MFR/ MARQUE FABRICANTE	MODEL MODELE MODELO	
<b>234-4685</b>			<b>C</b>
1991-1995	BMW	525I	
1993	BMW	525IT	
<b>234-4686</b>			<b>A</b>
2000-2002	KIA	SPECTRA	
1996-2002	KIA	SPORTAGE	
1998-2001	KIA	SEPHIA	
<b>234-4687</b>			<b>D</b>
2000-2002	KIA	SPECTRA	
2000-2001	KIA	SEPHIA	
<b>234-4688</b>			<b>D</b>
1997-1998	CADILLAC	CATERA	
<b>234-4689</b>			<b>D</b>
1997-1998	VOLVO	S90	
1997-1998	VOLVO	V90	
1998	VOLVO	S70	
1998	VOLVO	V70	
1996-1997	VOLVO	960	
1994-1997	VOLVO	850	
<b>234-4690</b>			<b>D</b>
1998-2001	HYUNDAI	TIBURON	
1998-2000	HYUNDAI	ELANTRA	
1997-1999	HYUNDAI	ACCENT	
<b>234-4691</b>			<b>D</b>
1996-1997	HYUNDAI	ELANTRA	
1995-1997	HYUNDAI	ACCENT	
1997	HYUNDAI	TIBURON	
<b>234-4692</b>			<b>D</b>
1996-1997	HYUNDAI	ELANTRA	
1995-1997	HYUNDAI	ACCENT	
1997	HYUNDAI	TIBURON	
<b>234-4693</b>			<b>D</b>
1998-2001	HYUNDAI	TIBURON	
1998-2000	HYUNDAI	ELANTRA	
1997-1999	HYUNDAI	ACCENT	
<b>234-4694</b>			<b>D</b>
1999-2004	LAND ROVER	DISCOVERY	
<b>234-4695</b>			<b>D</b>
2002-2004	LAND ROVER	FREELANDER	
1999-2002	LAND ROVER	RANGE ROVER	
<b>234-4696</b>			<b>D</b>
2002-2005	LAND ROVER	FREELANDER	
1999-2004	LAND ROVER	DISCOVERY	
1999-2002	LAND ROVER	RANGE ROVER	
<b>234-4697</b>			<b>C</b>
1993-1994	VOLVO	850	
<b>234-4698</b>			<b>D</b>
1998	VOLVO	C70	
1998	VOLVO	S70	
1998	VOLVO	V70	
1994-1997	VOLVO	850	

#PART PIECE PARTE	MFR/ MARQUE FABRICANTE	MODEL MODELE MODELO	
<b>234-4699</b>			<b>C</b>
1997-1998	VOLVO	S90	
1997-1998	VOLVO	V90	
1995-1997	VOLVO	960	
<b>234-4700</b>			<b>D</b>
1991-1993	BMW	M5	
1988-1993	BMW	535I	
1988-1992	BMW	735I	
1988-1992	BMW	735IL	
1988-1989	BMW	635CSI	
1988	BMW	535IS	
2002-2004	INFINITI	I35	
1997-2003	INFINITI	QX4	
1996-2001	INFINITI	I30	
1999	INFINITI	G20	
1996	INFINITI	Q45	
1995-1996	MERCEDES-BENZ	C36 AMG	
1994-1996	MERCEDES-BENZ	C220	
1994-1996	MERCEDES-BENZ	C280	
1994-1996	MERCEDES-BENZ	SL320	
1994-1995	MERCEDES-BENZ	E320	
1994-1995	MERCEDES-BENZ	S500	
1994-1995	MERCEDES-BENZ	S600	
1994-1995	MERCEDES-BENZ	SL600	
1994	MERCEDES-BENZ	S320	
1994	MERCEDES-BENZ	S420	
1992-1993	MERCEDES-BENZ	500SEL	
1992-1993	MERCEDES-BENZ	600SEL	
1990-1993	MERCEDES-BENZ	300E	
1993	MERCEDES-BENZ	300CE	
1993	MERCEDES-BENZ	300TE	
1993	MERCEDES-BENZ	400SEL	
1993	MERCEDES-BENZ	500SEC	
1993	MERCEDES-BENZ	600SEC	
1993	MERCEDES-BENZ	600SL	
1992	MERCEDES-BENZ	300SE	
1992	MERCEDES-BENZ	400E	
1992	MERCEDES-BENZ	400SE	
1992	MERCEDES-BENZ	500E	
1996-2002	MERCURY	VILLAGER	
1996-2004	NISSAN	ALTIMA	
2000-2003	NISSAN	XTERRA	
1998-2003	NISSAN	FRONTIER	
1997-2003	NISSAN	MAXIMA	
1997-2002	NISSAN	SENTRA	
1996-2002	NISSAN	PATHFINDER	
1996-2002	NISSAN	QUEST	
1997-1998	NISSAN	200SX	
1997-1998	NISSAN	240SX	
1996-1997	NISSAN	PICKUP	
1996	NISSAN	300ZX	
1999-2004	SUBARU	FORESTER	

#PART PIECE PARTE	MFR/ MARQUE FABRICANTE	MODEL MODELE MODELO	
<b>234-4700 (CONT.)</b>			<b>D</b>
1999-2004	SUBARU	IMPREZA	
1995	VOLKSWAGEN	PASSAT	
<b>234-4701</b>			<b>B</b>
1999-2002	MERCURY	VILLAGER	
1999-2002	NISSAN	QUEST	
<b>234-4702</b>			<b>D</b>
1996-1997	MERCURY	VILLAGER	
1996-1997	NISSAN	QUEST	
<b>234-4703</b>			<b>B</b>
1997-2000	INFINITI	QX4	
2000-2003	NISSAN	XTERRA	
1999-2003	NISSAN	FRONTIER	
1996-2000	NISSAN	PATHFINDER	
1996-1997	NISSAN	PICKUP	
<b>234-4704</b>			<b>C</b>
1997-2000	INFINITI	QX4	
2000-2003	NISSAN	XTERRA	
1999-2003	NISSAN	FRONTIER	
1996-2000	NISSAN	PATHFINDER	
<b>234-4705</b>			<b>C</b>
1997-1999	NISSAN	SENTRA	
1996-1999	NISSAN	ALTIMA	
1997-1998	NISSAN	200SX	
1997-1998	NISSAN	240SX	
<b>234-4706</b>			<b>B</b>
1999-2004	SUBARU	FORESTER	
1999-2004	SUBARU	IMPREZA	
<b>234-4707</b>			<b>C</b>
1991-1993	BMW	M5	
1988-1993	BMW	535I	
1988-1992	BMW	735I	
1988-1992	BMW	735IL	
1988-1989	BMW	635CSI	
1988	BMW	535IS	
<b>234-4708</b>			<b>C</b>
1996	MERCEDES-BENZ	E320	
<b>234-4709</b>			<b>C</b>
1995	VOLKSWAGEN	PASSAT	
<b>234-4710</b>			<b>C</b>
1994-1996	MERCEDES-BENZ	C220	
<b>234-4711</b>			<b>C</b>
1995-1996	MERCEDES-BENZ	C36 AMG	
1994-1996	MERCEDES-BENZ	C280	
1994-1996	MERCEDES-BENZ	SL320	
1994-1995	MERCEDES-BENZ	S500	
1994-1995	MERCEDES-BENZ	S600	
1994-1995	MERCEDES-BENZ	SL600	
1994	MERCEDES-BENZ	S320	
1994	MERCEDES-BENZ	S420	
1992-1993	MERCEDES-BENZ	500SEL	
1992-1993	MERCEDES-BENZ	600SEL	



#PART PIECE PARTE	MFR / MARQUE FABRICANTE	MODEL MODELE MODELO	
<b>234-4711 (CONT.)</b>			<b>C</b>
1993	MERCEDES-BENZ	400SEL	
1993	MERCEDES-BENZ	500SEC	
1993	MERCEDES-BENZ	600SEC	
1993	MERCEDES-BENZ	600SL	
1990-1992	MERCEDES-BENZ	300E	
1992	MERCEDES-BENZ	300SE	
1992	MERCEDES-BENZ	400E	
1992	MERCEDES-BENZ	400SE	
1992	MERCEDES-BENZ	500E	
<b>234-4712</b>			<b>C</b>
1994-1995	MERCEDES-BENZ	E320	
1993	MERCEDES-BENZ	300CE	
1993	MERCEDES-BENZ	300E	
1993	MERCEDES-BENZ	300TE	
<b>234-4713</b>			<b>B</b>
2002-2003	INFINITI	QX4	
2001-2002	NISSAN	PATHFINDER	
<b>234-4714</b>			<b>D</b>
1998-2000	NISSAN	FRONTIER	
2000	NISSAN	XTERRA	
<b>234-4715</b>			<b>C</b>
1996	INFINITI	Q45	
1996	NISSAN	300ZX	
<b>234-4716</b>			<b>A</b>
1996-1999	INFINITI	I30	
1999	INFINITI	G20	
1997-1999	NISSAN	MAXIMA	
1998	NISSAN	200SX	
<b>234-4717</b>			<b>C</b>
2012-2014	AUDI	A8 QUATTRO	
<b>234-4718</b>			<b>A</b>
2003-2004	DODGE	DAKOTA	
2003-2004	DODGE	RAM 1500 PICKUP	
2002-2004	DODGE	DURANGO	
<b>234-4719</b>			<b>D</b>
2003	DODGE	DAKOTA	
2003	DODGE	DURANGO	
2003	DODGE	RAM 1500 PICKUP	
<b>234-4720</b>			<b>D</b>
1997-1999	JAGUAR	XK8	
1998	JAGUAR	VANDEN PLAS	
1998	JAGUAR	XJ8	
1998	JAGUAR	XJR	
<b>234-4721</b>			<b>C</b>
2002-2003	MAZDA	PROTEGE5	
2001-2003	MAZDA	PROTEGE	
<b>234-4722</b>			<b>C</b>
2004-2005	MAZDA	MIATA	
1999-2003	MAZDA	PROTEGE	
2000-2001	MAZDA	MPV	

#PART PIECE PARTE	MFR / MARQUE FABRICANTE	MODEL MODELE MODELO	
<b>234-4723</b>			<b>D</b>
2001-2005	MAZDA	MIATA	
<b>234-4724</b>			<b>C</b>
2002-2006	MAZDA	MPV	
<b>234-4725</b>			<b>A</b>
2000-2006	MAZDA	MPV	
2006-2008	SUZUKI	FORENZA	
2006-2008	SUZUKI	RENO	
<b>234-4726</b>			<b>D</b>
1995-1998	ACURA	TL	
<b>234-4727</b>			<b>A</b>
2001-2003	ACURA	CL	
2000-2003	ACURA	TL	
2001-2004	HONDA	ODYSSEY	
2000-2002	HONDA	ACCORD	
<b>234-4729</b>			<b>C</b>
2000-2005	ACURA	NSX	
<b>234-4730</b>			<b>C</b>
2000-2005	ACURA	NSX	
<b>234-4731</b>			<b>C</b>
2001-2003	CHEVROLET	TRACKER	
2001-2003	SUZUKI	VITARA	
<b>234-4732</b>			<b>B</b>
2005-2006	SAAB	9-2X	
2013-2015	SUBARU	WRX STI	
2002-2014	SUBARU	IMPREZA	
2004-2012	SUBARU	LEGACY	
2001-2009	SUBARU	OUTBACK	
2004-2008	SUBARU	FORESTER	
2004-2006	SUBARU	BAJA	
<b>234-4733</b>			<b>B</b>
1999-2000	ACURA	EL	
2003-2011	HONDA	ELEMENT	
1999-2000	HONDA	CIVIC	
<b>234-4734</b>			<b>D</b>
2005-2010	VOLVO	S40	
2005-2010	VOLVO	V50	
1999-2000	VOLVO	S70	
1999-2000	VOLVO	V70	
<b>234-4736</b>			<b>D</b>
2000-2001	SUBARU	OUTBACK	
1999-2001	SUBARU	IMPREZA	
1999-2001	SUBARU	LEGACY	
<b>234-4737</b>			<b>C</b>
2012-2014	AUDI	A8 QUATTRO	
<b>234-4738</b>			<b>A</b>
2001-2005	CHRYSLER	SEBRING	
2001-2005	DODGE	STRATUS	
2007-2013	MITSUBISHI	OUTLANDER	
1998-2012	MITSUBISHI	ECLIPSE	
1999-2009	MITSUBISHI	GALANT	
1999-2004	MITSUBISHI	DIAMANTE	

#PART PIECE PARTE	MFR / MARQUE FABRICANTE	MODEL MODELE MODELO	
<b>234-4738 (CONT.)</b>			<b>A</b>
1998-2002	MITSUBISHI	MIRAGE	
1998-2000	MITSUBISHI	MONTERO	
<b>234-4739</b>			<b>A</b>
2001-2005	CHRYSLER	SEBRING	
2001-2005	DODGE	STRATUS	
2000-2012	MITSUBISHI	ECLIPSE	
2010-2011	MITSUBISHI	ENDEAVOR	
1999-2009	MITSUBISHI	GALANT	
2004-2008	MITSUBISHI	ENDEAVOR	
2002-2007	MITSUBISHI	LANCER	
1999-2004	MITSUBISHI	DIAMANTE	
<b>234-4740</b>			<b>C</b>
2011-2012	FORD	ESCAPE	
2011-2012	FORD	FUSION	
2011	MERCURY	MILAN	
<b>234-4741</b>			<b>A</b>
2010-2011	MITSUBISHI	ENDEAVOR	
2004-2008	MITSUBISHI	ENDEAVOR	
2003-2006	MITSUBISHI	LANCER	
2001-2006	MITSUBISHI	MONTERO	
1999-2004	MITSUBISHI	MONTERO SPORT	
<b>234-4742</b>			<b>A</b>
1998-2006	MITSUBISHI	MONTERO	
1999-2004	MITSUBISHI	MONTERO SPORT	
<b>234-4743</b>			<b>C</b>
2013-2015	ACURA	RDX	
2013-2014	ACURA	ILX	
2012-2015	HONDA	CIVIC	
2012-2013	HONDA	CR-V	
<b>234-4744</b>			<b>B</b>
2007	CHRYSLER	ASPEN	
2005-2006	CHRYSLER	PACIFICA	
2005-2007	DODGE	DAKOTA	
2005-2007	DODGE	DURANGO	
2005-2007	DODGE	RAM 1500 PICKUP	
2006-2007	JEEP	COMMANDER	
2005-2007	JEEP	GRAND CHEROKEE	
2006-2007	MITSUBISHI	RAIDER	
<b>234-4745</b>			<b>D</b>
2004	DODGE	DAKOTA	
2004	DODGE	DURANGO	
<b>234-4746</b>			<b>B</b>
2001-2004	JEEP	GRAND CHEROKEE	
<b>234-4747</b>			<b>C</b>
2001-2004	JEEP	GRAND CHEROKEE	
<b>234-4748</b>			<b>C</b>
2013-2015	DODGE	DART	
2014-2015	FIAT	500L	
<b>234-4749</b>			<b>B</b>
2001-2002	DODGE	DAKOTA	
2001-2002	DODGE	DURANGO	



#PART PIECE PARTE	MFR/ MARQUE FABRICANTE	MODEL MODELE MODELO
<b>234-4749 (CONT.)</b>		<b>B</b>
2002	DODGE	RAM 1500 PICKUP
<b>234-4750</b>		<b>D</b>
2000-2001	MAZDA	MPV
<b>234-4751</b>		<b>D</b>
1999-2003	MAZDA	PROTEGE
<b>234-4752</b>		<b>A</b>
2005-2008	MAZDA	6
2002-2003	MAZDA	PROTEGES
1999-2003	MAZDA	PROTEGE
2000-2001	MAZDA	MPV
<b>234-4753</b>		<b>C</b>
2000-2006	AUDI	TT QUATTRO
2004-2005	VOLKSWAGEN	JETTA
<b>234-4754</b>		<b>C</b>
2013-2015	AUDI	A4 ALLROAD
2013-2015	AUDI	A6 QUATTRO
2013-2015	AUDI	ALLROAD
2012-2015	AUDI	A6
2011-2015	AUDI	A4
2011-2015	AUDI	A4 QUATTRO
2011-2015	AUDI	A5 QUATTRO
2011-2015	AUDI	Q5
2015	AUDI	Q3
2015	AUDI	Q3 QUATTRO
2011-2014	AUDI	A5
2012-2013	AUDI	TT QUATTRO
2009-2013	AUDI	A3 QUATTRO
2006-2013	AUDI	A3
2015	BENTLEY	CONTINENTAL
2011-2015	VOLKSWAGEN	TOUAREG
2009-2015	VOLKSWAGEN	CC
2009-2015	VOLKSWAGEN	TIGUAN
2007-2015	VOLKSWAGEN	EOS
2012-2014	VOLKSWAGEN	BEETLE
2012-2014	VOLKSWAGEN	PASSAT
2010-2014	VOLKSWAGEN	GOLF
2006-2014	VOLKSWAGEN	GTI
2005-2014	VOLKSWAGEN	JETTA
2009-2010	VOLKSWAGEN	PASSAT CC
2006-2010	VOLKSWAGEN	PASSAT
2006-2009	VOLKSWAGEN	RABBIT
<b>234-4755</b>		<b>D</b>
2001	VOLVO	S60
2001	VOLVO	V70
<b>234-4756</b>		<b>C</b>
2007	CHRYSLER	ASPEN
2005-2006	CHRYSLER	PACIFICA
2005-2007	DODGE	DAKOTA
2005-2007	DODGE	DURANGO
2006-2007	MITSUBISHI	RAIDER

#PART PIECE PARTE	MFR/ MARQUE FABRICANTE	MODEL MODELE MODELO
<b>234-4757</b>		<b>C</b>
2015-2016	LEXUS	NX200T
2015-2016	LEXUS	NX300H
2013-2016	LEXUS	ES300H
2013-2016	TOYOTA	AVALON
2013-2016	TOYOTA	RAV4
2012-2016	TOYOTA	CAMRY
<b>234-4758</b>		<b>C</b>
2014	LEXUS	GX460
2014	LEXUS	LX570
2013-2016	TOYOTA	4RUNNER
2012-2015	TOYOTA	TACOMA
2013-2014	TOYOTA	FJ CRUISER
2013-2014	TOYOTA	TUNDRA
2014	TOYOTA	LAND CRUISER
2014	TOYOTA	SEQUOIA
<b>234-4759</b>		<b>C</b>
2012-2014	TOYOTA	YARIS
<b>234-4760</b>		<b>C</b>
2012-2016	TOYOTA	PRIUS C
<b>234-4761</b>		<b>D</b>
2000	DODGE	DAKOTA
2000	DODGE	DURANGO
<b>234-4762</b>		<b>C</b>
2014-2015	BUICK	REGAL
2014-2015	CADILLAC	CTS
2013-2015	CADILLAC	ATS
2014-2015	CHEVROLET	IMPALA
2013-2015	CHEVROLET	MALIBU
<b>234-4763</b>		<b>C</b>
2014-2015	BUICK	REGAL
2014-2015	CADILLAC	CTS
2013-2015	CADILLAC	ATS
2014-2015	CHEVROLET	CORVETTE
2014-2015	CHEVROLET	IMPALA
2013-2015	CHEVROLET	MALIBU
<b>234-4764</b>		<b>B</b>
2001-2002	DODGE	DAKOTA
2001-2002	DODGE	DURANGO
2002	DODGE	RAM 1500 PICKUP
<b>234-4765</b>		<b>C</b>
2013-2015	CHEVROLET	SPARK
<b>234-4766</b>		<b>D</b>
2003-2006	DODGE	VIPER
2001-2003	DODGE	DAKOTA
2001-2003	DODGE	DURANGO
2003	DODGE	RAM 2500 PICKUP
2003	DODGE	RAM 3500 PICKUP
<b>234-4767</b>		<b>B</b>
2003-2006	DODGE	VIPER
2001-2006	DODGE	RAM 1500 PICKUP
2001-2004	DODGE	DAKOTA

#PART PIECE PARTE	MFR/ MARQUE FABRICANTE	MODEL MODELE MODELO
<b>234-4767 (CONT.)</b>		<b>B</b>
2001-2004	DODGE	DURANGO
2004	DODGE	RAM 2500 PICKUP
2004	DODGE	RAM 3500 PICKUP
2001-2002	DODGE	RAM 2500 PICKUP
2001-2002	DODGE	RAM 3500 PICKUP
2004	JEEP	GRAND CHEROKEE
<b>234-4768</b>		<b>C</b>
2001-2004	JEEP	GRAND CHEROKEE
2001-2004	JEEP	TJ
2001-2004	JEEP	WRANGLER
<b>234-4769</b>		<b>C</b>
2001-2003	DODGE	RAM 1500 PICKUP
2001-2002	DODGE	RAM 2500 PICKUP
2001-2002	DODGE	RAM 3500 PICKUP
2001-2003	JEEP	GRAND CHEROKEE
2001-2003	JEEP	TJ
2001-2003	JEEP	WRANGLER
<b>234-4770</b>		<b>C</b>
2001-2003	DODGE	DAKOTA
2001-2003	DODGE	DURANGO
2001-2003	DODGE	RAM 1500 PICKUP
2001-2003	DODGE	RAM 2500 PICKUP
2001-2003	DODGE	RAM 3500 PICKUP
2001-2002	DODGE	RAM 1500 VAN
2001-2002	DODGE	RAM 2500 VAN
2001-2002	DODGE	RAM 3500 VAN
<b>234-4771</b>		<b>B</b>
2004-2006	DODGE	RAM 1500 PICKUP
2001-2004	DODGE	DAKOTA
2001-2004	DODGE	DURANGO
2003	DODGE	RAM 2500 PICKUP
2003	DODGE	RAM 3500 PICKUP
2001-2002	DODGE	RAM 1500 VAN
2001-2002	DODGE	RAM 2500 VAN
2001-2002	DODGE	RAM 3500 VAN
2004	JEEP	LIBERTY
2004	JEEP	TJ
2004	JEEP	WRANGLER
<b>234-4772</b>		<b>C</b>
2001-2003	DODGE	DAKOTA
2001-2003	DODGE	DURANGO
2003	DODGE	RAM 1500 PICKUP
2001-2004	JEEP	WRANGLER
2002-2003	JEEP	LIBERTY
2001-2003	JEEP	TJ
<b>234-4773</b>		<b>C</b>
2013-2015	CHEVROLET	SPARK
<b>234-4774</b>		<b>C</b>
2013-2015	CHEVROLET	SPARK
<b>234-4775</b>		<b>D</b>
2001-2004	NISSAN	ALTIMA



#PART PIECE PARTE	MFR / MARQUE FABRICANTE	MODEL MODELE MODELO	
<b>234-4776</b>			<b>B</b>
1999-2001	INFINITI	I30	
2001	INFINITI	QX4	
2000-2001	NISSAN	SENTRA	
1998-2001	NISSAN	MAXIMA	
2001	NISSAN	PATHFINDER	
<b>234-4777</b>			<b>B</b>
1999-2001	INFINITI	I30	
2000-2001	NISSAN	SENTRA	
1998-2001	NISSAN	MAXIMA	
<b>234-4778</b>			<b>D</b>
2000-2002	NISSAN	SENTRA	
2000-2001	NISSAN	ALTIMA	
<b>234-4779</b>			<b>D</b>
1998-2000	MERCURY	VILLAGER	
1998-2000	NISSAN	QUEST	
<b>234-4780</b>			<b>C</b>
2013-2015	BUICK	ENCORE	
2013-2015	CHEVROLET	TRAX	
2013-2014	CHEVROLET	SONIC	
<b>234-4781</b>			<b>C</b>
2014-2016	ACURA	MDX	
2014-2016	ACURA	RLX	
2015	ACURA	TLX	
2016	HONDA	PILOT	
2013-2015	HONDA	ACCORD	
2013-2015	HONDA	CROSSTOUR	
<b>234-4782</b>			<b>C</b>
2013-2014	HONDA	ACCORD	
<b>234-4783</b>			<b>D</b>
1996-1999	LAND ROVER	DISCOVERY	
1997-1998	LAND ROVER	RANGE ROVER	
1997	LAND ROVER	DEFENDER 90	
1993	LAND ROVER	DEFENDER 110	
<b>234-4784</b>			<b>C</b>
1998-2000	BMW	Z3	
<b>234-4785</b>			<b>C</b>
1998-1999	BMW	323I	
1998-1999	BMW	323IS	
1997-1998	BMW	Z3	
<b>234-4786</b>			<b>C</b>
2016	ACURA	ILX	
2015	ACURA	TLX	
2013-2015	HONDA	ACCORD	
2015	HONDA	CIVIC	
<b>234-4787</b>			<b>C</b>
2013	ACURA	ZDX	
<b>234-4788</b>			<b>C</b>
1996-1999	LAND ROVER	DISCOVERY	
1995-1997	LAND ROVER	RANGE ROVER	
1997	LAND ROVER	DEFENDER 90	

#PART PIECE PARTE	MFR / MARQUE FABRICANTE	MODEL MODELE MODELO	
<b>234-4789</b>			<b>C</b>
1997-2000	BMW	Z3	
1998-1999	BMW	323I	
1998-1999	BMW	323IS	
1996-1999	BMW	328I	
1996-1999	BMW	328IS	
1996-1999	BMW	M3	
1997-1998	BMW	528I	
<b>234-4790</b>			<b>C</b>
2014-2016	ACURA	MDX	
2014-2016	ACURA	RLX	
2016	ACURA	RDX	
2015	ACURA	TLX	
2016	HONDA	PILOT	
2013-2015	HONDA	ACCORD	
2013-2015	HONDA	CROSSTOUR	
<b>234-4791</b>			<b>C</b>
2014-2015	JAGUAR	F-TYPE	
2013-2015	JAGUAR	XF	
2013-2014	JAGUAR	XFR	
2013-2014	JAGUAR	XFR-S	
2013-2014	JAGUAR	XJ	
2014	JAGUAR	XJR	
2014-2015	LAND ROVER	LR4	
<b>234-4792</b>			<b>C</b>
2013-2015	JAGUAR	XF	
2013-2014	JAGUAR	XJ	
<b>234-4793</b>			<b>C</b>
2013-2014	JAGUAR	XF	
<b>234-4794</b>			<b>C</b>
2014-2015	JAGUAR	F-TYPE	
2013-2015	JAGUAR	XF	
2013-2014	JAGUAR	XFR	
2013-2014	JAGUAR	XFR-S	
2013-2014	JAGUAR	XJ	
2014	JAGUAR	XJR	
2014-2015	LAND ROVER	RANGE ROVER SPORT	
2013-2015	LAND ROVER	RANGE ROVER	
<b>234-4795</b>			<b>C</b>
2014-2015	LAND ROVER	LR4	
2014-2015	LAND ROVER	RANGE ROVER SPORT	
2013-2015	LAND ROVER	RANGE ROVER	
<b>234-4796</b>			<b>C</b>
2013-2015	MERCEDES-BENZ	E400	
2012-2015	MERCEDES-BENZ	SLK55 AMG	
<b>234-4797</b>			<b>A</b>
2003-2007	HONDA	ACCORD	
<b>234-4798</b>			<b>C</b>
2002-2008	JAGUAR	X-TYPE	
2003-2005	JAGUAR	S-TYPE	
2000-2005	JAGUAR	XK8	
2000-2005	JAGUAR	XKR	

#PART PIECE PARTE	MFR / MARQUE FABRICANTE	MODEL MODELE MODELO	
<b>234-4798 (CONT.)</b>			<b>C</b>
1999-2005	JAGUAR	VANDEN PLAS	
1999-2005	JAGUAR	XJ8	
1999-2005	JAGUAR	XJR	
2005	JAGUAR	SUPER V8	
<b>234-4799</b>			<b>C</b>
2013-2015	MERCEDES-BENZ	G63 AMG	
<b>234-4800</b>			<b>A</b>
2003-2004	PONTIAC	VIBE	
2003-2004	TOYOTA	COROLLA	
2003-2004	TOYOTA	MATRIX	
<b>234-4801</b>			<b>D</b>
2003-2006	PONTIAC	VIBE	
2003-2006	TOYOTA	MATRIX	
<b>234-4802</b>			<b>D</b>
2004-2006	PONTIAC	VIBE	
2005-2006	TOYOTA	COROLLA	
2004-2006	TOYOTA	MATRIX	
<b>234-4803</b>			<b>D</b>
2003-2005	TOYOTA	CELICA	
<b>234-4804</b>			<b>D</b>
2003-2004	TOYOTA	4RUNNER	
<b>234-4805</b>			<b>D</b>
2003-2004	TOYOTA	4RUNNER	
<b>234-4806</b>			<b>C</b>
2006	LEXUS	GS300	
<b>234-4808</b>			<b>C</b>
2007-2010	AUDI	A8 QUATTRO	
2005-2006	AUDI	A4 QUATTRO	
2004-2006	AUDI	TT QUATTRO	
2005	AUDI	A4	
2004-2006	PORSCHE	CAYENNE	
2007-2010	VOLKSWAGEN	GOLF CITY	
2007-2009	VOLKSWAGEN	JETTA CITY	
2002-2006	VOLKSWAGEN	GOLF	
2001-2005	VOLKSWAGEN	BEETLE	
2001-2005	VOLKSWAGEN	JETTA	
<b>234-4809</b>			<b>C</b>
2005-2009	AUDI	A8 QUATTRO	
2005-2006	AUDI	A4 QUATTRO	
2004-2006	AUDI	TT QUATTRO	
2005	AUDI	A4	
2015	BENTLEY	CONTINENTAL	
2003-2006	PORSCHE	CAYENNE	
2004-2006	VOLKSWAGEN	PHAETON	
2004-2006	VOLKSWAGEN	TOUAREG	
2002-2005	VOLKSWAGEN	GOLF	
2002-2004	VOLKSWAGEN	JETTA	
2002-2004	VOLKSWAGEN	PASSAT	
<b>234-4810</b>			<b>C</b>
2006	LEXUS	GS300	





#PART PIECE PARTE	MFR/ MARQUE FABRICANTE	MODEL MODELE MODELO	
<b>234-4812</b>			<b>C</b>
2003-2004	AUDI	RS6	
2000-2004	AUDI	A6 QUATTRO	
2002-2003	AUDI	S6	
2001-2003	AUDI	S8	
2000-2003	AUDI	A8 QUATTRO	
2000-2002	AUDI	S4	
2000-2001	AUDI	A4	
2000-2001	AUDI	A4 QUATTRO	
2000-2001	AUDI	A6	
2001	AUDI	ALLROAD QUATTRO	
2000-2005	VOLKSWAGEN	PASSAT	
<b>234-4814</b>			<b>C</b>
2003	NISSAN	SENTRA	
<b>234-4815</b>			<b>C</b>
2010-2011	BUICK	LACROSSE	
2009-2011	BUICK	ENCLAVE	
2010	BUICK	ALLURE	
2005-2008	BUICK	ALLURE	
2005-2008	BUICK	LACROSSE	
2005-2006	BUICK	RENDEZVOUS	
2014	CADILLAC	ELR	
2010-2011	CADILLAC	SRX	
2011-2015	CHEVROLET	VOLT	
2010-2012	CHEVROLET	EQUINOX	
2009-2011	CHEVROLET	TRAVERSE	
2010-2011	GMC	TERRAIN	
2009-2011	GMC	ACADIA	
2011	SAAB	9-4X	
2009-2010	SATURN	OUTLOOK	
<b>234-4816</b>			<b>D</b>
2009-2011	BUICK	ENCLAVE	
2011	BUICK	LACROSSE	
2004-2005	CADILLAC	XLR	
2004	CADILLAC	CTS	
2004	CADILLAC	SRX	
2009-2011	CHEVROLET	TRAVERSE	
2009-2011	GMC	ACADIA	
2009-2010	SATURN	OUTLOOK	
<b>234-4817</b>			<b>C</b>
2005-2006	CADILLAC	XLR	
<b>234-4818</b>			<b>D</b>
2005-2011	CADILLAC	STS	
2004-2011	CADILLAC	CTS	
2004-2009	CADILLAC	SRX	
2010-2011	CHEVROLET	CAMARO	
<b>234-4819</b>			<b>D</b>
2008-2011	CADILLAC	CTS	
2008-2011	CADILLAC	STS	
2007-2009	CADILLAC	SRX	
2008-2009	CHEVROLET	EQUINOX	
2008-2009	PONTIAC	TORRENT	

#PART PIECE PARTE	MFR/ MARQUE FABRICANTE	MODEL MODELE MODELO	
<b>234-4819 (CONT.)</b>			<b>D</b>
2007-2009	SUZUKI	XL-7	
<b>234-4820</b>			<b>C</b>
2007-2008	PONTIAC	SOLSTICE	
2007-2008	SATURN	SKY	
<b>234-4821</b>			<b>C</b>
2013-2015	BUICK	ENCORE	
2004	BUICK	RENDEZVOUS	
2010-2011	CADILLAC	SRX	
2003-2004	CADILLAC	CTS	
2015	CHEVROLET	TRAX	
2008-2009	PONTIAC	G8	
2010-2011	SAAB	9-5	
2011	SAAB	9-4X	
2006-2009	SAAB	9-3	
2002-2003	SATURN	VUE	
<b>234-4822</b>			<b>D</b>
2001-2005	SATURN	L300	
2001-2003	SATURN	LW300	
2000	SATURN	LS2	
2000	SATURN	LW2	
<b>234-4828</b>			<b>C</b>
2005	LAND ROVER	FREELANDER	
<b>234-4829</b>			<b>C</b>
2014-2015	AUDI	R8	
2008-2014	AUDI	TT QUATTRO	
2008-2013	AUDI	A3	
2008-2012	AUDI	R8	
2008-2009	AUDI	TT	
2005-2009	AUDI	A4	
2005-2009	AUDI	A4 QUATTRO	
2009	AUDI	A3 QUATTRO	
2015	BENTLEY	CONTINENTAL	
2015	PORSCHE	CAYENNE	
2011-2015	VOLKSWAGEN	TOUAREG	
2010-2015	VOLKSWAGEN	CC	
2009-2015	VOLKSWAGEN	EOS	
2005-2015	VOLKSWAGEN	JETTA	
2012-2014	VOLKSWAGEN	BEETLE	
2012-2014	VOLKSWAGEN	PASSAT	
2010-2014	VOLKSWAGEN	GOLF	
2008-2014	VOLKSWAGEN	GTI	
2010	VOLKSWAGEN	PASSAT	
2008-2009	VOLKSWAGEN	RABBIT	
<b>234-4830</b>			<b>C</b>
1999-2001	CADILLAC	CATERA	
<b>234-4832</b>			<b>C</b>
2007-2010	AUDI	A6 QUATTRO	
2006-2009	AUDI	A3 QUATTRO	
2007-2008	AUDI	RS4	
2006-2007	VOLKSWAGEN	PASSAT	

#PART PIECE PARTE	MFR/ MARQUE FABRICANTE	MODEL MODELE MODELO	
<b>234-4833</b>			<b>C</b>
2014-2015	AUDI	RS7	
2013-2015	AUDI	A8 QUATTRO	
2013-2015	AUDI	S6	
2013-2015	AUDI	S7	
2013-2015	AUDI	S8	
2007-2010	AUDI	Q7	
2005-2006	AUDI	A6 QUATTRO	
2012-2015	VOLKSWAGEN	PASSAT	
2009-2015	VOLKSWAGEN	CC	
2009-2010	VOLKSWAGEN	PASSAT CC	
2006-2010	VOLKSWAGEN	PASSAT	
2007-2009	VOLKSWAGEN	TOUAREG	
<b>234-4834</b>			<b>C</b>
2007-2011	AUDI	S6	
2007-2009	AUDI	S8	
<b>234-4835</b>			<b>D</b>
2004-2010	INFINITI	QX56	
2005-2015	NISSAN	ARMADA	
2004-2015	NISSAN	TITAN	
2008-2012	NISSAN	PATHFINDER	
2003-2006	NISSAN	SENTRA	
2004	NISSAN	PATHFINDER	
<b>234-4836</b>			<b>C</b>
2008-2009	AUDI	TT QUATTRO	
<b>234-4837</b>			<b>C</b>
1990-1991	MITSUBISHI	MONTERO	
<b>234-4839</b>			<b>C</b>
2014-2015	MERCEDES-BENZ	CLA45 AMG	
2014-2015	MERCEDES-BENZ	CLA250	
2013-2015	MERCEDES-BENZ	B250	
2013-2015	MERCEDES-BENZ	SL65 AMG	
2015	MERCEDES-BENZ	GLA45 AMG	
2015	MERCEDES-BENZ	GLA250	
2015	MERCEDES-BENZ	S65 AMG	
2015	MERCEDES-BENZ	S600	
<b>234-4840</b>			<b>C</b>
2008-2009	CHEVROLET	EQUINOX	
2008-2009	PONTIAC	TORRENT	
2007-2009	SUZUKI	XL-7	
<b>234-4843</b>			<b>C</b>
2007-2010	AUDI	Q7	
2007-2009	VOLKSWAGEN	TOUAREG	
<b>234-4844</b>			<b>C</b>
2001-2003	AUDI	A8 QUATTRO	
<b>234-4846</b>			<b>C</b>
2005-2009	AUDI	A8 QUATTRO	
<b>234-4849</b>			<b>C</b>
2007-2011	AUDI	S6	
2006-2009	AUDI	A3 QUATTRO	
2007-2008	AUDI	RS4	
2006-2007	VOLKSWAGEN	PASSAT	



#PART PIECE PARTE	MFR / MARQUE FABRICANTE	MODEL MODELE MODELO	
<b>234-4850</b>			<b>C</b>
2005-2010	VOLKSWAGEN	BEETLE	
2004-2006	VOLKSWAGEN	TOUAREG	
2004-2005	VOLKSWAGEN	JETTA	
<b>234-4851</b>			<b>C</b>
2001-2012	HYUNDAI	ELANTRA	
2000-2011	HYUNDAI	ACCENT	
2005-2009	HYUNDAI	TUCSON	
2003-2008	HYUNDAI	TIBURON	
2010-2011	KIA	SOUL	
2006-2011	KIA	RIO	
2006-2011	KIA	RIOS	
2005-2010	KIA	SPORTAGE	
2005-2009	KIA	SPECTRA5	
2004-2009	KIA	SPECTRA	
<b>234-4852</b>			<b>C</b>
2005-2009	HYUNDAI	TUCSON	
2003-2007	HYUNDAI	TIBURON	
2001-2006	HYUNDAI	ELANTRA	
2005-2010	KIA	SPORTAGE	
<b>234-4854</b>			<b>D</b>
2010-2012	HYUNDAI	GENESIS COUPE	
2007-2012	HYUNDAI	VERACRUZ	
2009-2011	HYUNDAI	GENESIS	
2006-2011	HYUNDAI	AZERA	
2007-2010	HYUNDAI	ENTOURAGE	
2006-2010	HYUNDAI	SONATA	
2007-2009	HYUNDAI	SANTA FE	
2009-2011	KIA	BORREGO	
2006-2010	KIA	SEDONA	
2007-2009	KIA	AMANTI	
2007-2009	KIA	SORENTO	
<b>234-4855</b>			<b>D</b>
2006-2011	HYUNDAI	AZERA	
2007-2010	HYUNDAI	ENTOURAGE	
2006-2010	HYUNDAI	SONATA	
2006-2010	KIA	SEDONA	
2007-2009	KIA	AMANTI	
2007-2009	KIA	SORENTO	
<b>234-4856</b>			<b>C</b>
2007-2012	HYUNDAI	VERACRUZ	
2007-2009	HYUNDAI	SANTA FE	
2007-2009	KIA	SORENTO	
<b>234-4857</b>			<b>C</b>
2009-2011	KIA	BORREGO	
2007-2009	KIA	SORENTO	
<b>234-4858</b>			<b>D</b>
2002-2004	KIA	SPECTRA	
<b>234-4859</b>			<b>C</b>
2002-2005	AUDI	ALLROAD QUATTRO	
2002-2004	AUDI	A6 QUATTRO	
2000-2001	AUDI	TT	

#PART PIECE PARTE	MFR / MARQUE FABRICANTE	MODEL MODELE MODELO	
<b>234-4859 (CONT.)</b>			<b>C</b>
2005-2010	VOLKSWAGEN	BEETLE	
1999-2001	VOLKSWAGEN	GOLF	
1999-2001	VOLKSWAGEN	JETTA	
1998-2001	VOLKSWAGEN	BEETLE	
<b>234-4860</b>			<b>D</b>
2000-2004	VOLVO	S40	
2000-2004	VOLVO	V40	
<b>234-4861</b>			<b>C</b>
2007-2013	VOLVO	C30	
2006-2013	VOLVO	C70	
2012	VOLVO	S60	
2005-2011	VOLVO	V50	
2004-2011	VOLVO	S40	
2005-2009	VOLVO	S60	
2005-2007	VOLVO	V70	
2005-2007	VOLVO	XC70	
2005-2006	VOLVO	XC90	
2003-2006	VOLVO	S80	
<b>234-4862</b>			<b>C</b>
2000-2004	VOLVO	S40	
2000-2004	VOLVO	V40	
<b>234-4863</b>			<b>C</b>
2001-2004	VOLVO	S60	
1999-2004	VOLVO	C70	
1999-2004	VOLVO	V70	
1999-2000	VOLVO	S70	
<b>234-4864</b>			<b>C</b>
2003-2004	VOLVO	S60	
2003-2004	VOLVO	V70	
2003-2004	VOLVO	XC70	
2003-2004	VOLVO	XC90	
2004	VOLVO	S80	
<b>234-4865</b>			<b>C</b>
2003-2005	VOLVO	XC90	
2002-2005	VOLVO	S80	
<b>234-4866</b>			<b>C</b>
1999-2001	VOLVO	S80	
<b>234-4867</b>			<b>C</b>
2000-2002	VOLVO	S80	
<b>234-4871</b>			<b>C</b>
2007-2011	AUDI	S6	
<b>234-4872</b>			<b>C</b>
2001-2003	AUDI	S8	
2000-2003	AUDI	A8 QUATTRO	
<b>234-4874</b>			<b>C</b>
2004-2009	AUDI	S4	
2004-2006	AUDI	A8 QUATTRO	
2000-2006	AUDI	A4	
2000-2006	AUDI	TT	
2002-2005	AUDI	ALLROAD QUATTRO	
2000-2005	AUDI	A4 QUATTRO	

#PART PIECE PARTE	MFR / MARQUE FABRICANTE	MODEL MODELE MODELO	
<b>234-4874 (CONT.)</b>			<b>C</b>
2002-2004	AUDI	A6	
2002-2004	AUDI	A6 QUATTRO	
2000-2001	AUDI	TT QUATTRO	
2004-2007	VOLKSWAGEN	TOUAREG	
2004-2006	VOLKSWAGEN	PHAETON	
1999-2006	VOLKSWAGEN	GOLF	
2000-2005	VOLKSWAGEN	PASSAT	
1999-2005	VOLKSWAGEN	JETTA	
1998-2004	VOLKSWAGEN	BEETLE	
2001-2003	VOLKSWAGEN	EUROVAN	
2000-2002	VOLKSWAGEN	CABRIO	
<b>234-4875</b>			<b>C</b>
2010-2014	BMW	X6	
2008-2013	BMW	M3	
2007-2013	BMW	X5	
2006-2010	BMW	550I	
2006-2010	BMW	650I	
2007-2008	BMW	760LI	
2006-2008	BMW	750I	
2006-2008	BMW	750LI	
2007-2015	ROLLS-ROYCE	PHANTOM	
<b>234-4876</b>			<b>C</b>
2013-2015	BMW	650I GRAN COUPE	
2013-2015	BMW	650I XDRIVE GRAN	
2012-2015	BMW	650I	
2012-2015	BMW	650I XDRIVE	
2011-2015	BMW	550I	
2011-2015	BMW	550I XDRIVE	
2011-2015	BMW	ALPINA B7	
2011-2015	BMW	ALPINA B7L	
2011-2015	BMW	ALPINA B7L XDRIVE	
2011-2015	BMW	ALPINA B7 XDRIVE	
2010-2015	BMW	550I GT	
2010-2015	BMW	550I GT XDRIVE	
2010-2015	BMW	750I XDRIVE	
2010-2015	BMW	750LI XDRIVE	
2009-2015	BMW	750I	
2009-2015	BMW	750LI	
2008-2015	BMW	X6	
2007-2015	BMW	X5	
2006-2015	BMW	Z4	
2015	BMW	ALPINA B6 XDRIVE	
2011-2013	BMW	335IS	
2009-2013	BMW	328I XDRIVE	
2008-2013	BMW	128I	
2007-2013	BMW	328I	
2010-2011	BMW	323I	
2011	BMW	1 SERIES M	
2009-2010	BMW	335I XDRIVE	
2009-2010	BMW	528I XDRIVE	
2009-2010	BMW	535I XDRIVE	



#PART PIECE PARTE	MFR/ MARQUE FABRICANTE	MODEL MODELE MODELO	
<b>234-4876 (CONT.)</b>			<b>C</b>
2008-2010	BMW	135I	
2008-2010	BMW	528I	
2008-2010	BMW	535I	
2007-2010	BMW	335I	
2007-2010	BMW	X3	
2007-2008	BMW	328XI	
2007-2008	BMW	335XI	
2008	BMW	528XI	
2008	BMW	535XI	
2006	BMW	325I	
2006	BMW	325XI	
2006	BMW	330I	
2006	BMW	330XI	
<b>234-4877</b>			<b>C</b>
2006-2010	BMW	550I	
2006-2010	BMW	650I	
2006-2009	BMW	323I	
2006-2008	BMW	750I	
2006-2008	BMW	750LI	
2006-2007	BMW	525I	
2006-2007	BMW	525XI	
2006-2007	BMW	530I	
2006-2007	BMW	530XI	
<b>234-4878</b>			<b>C</b>
2015	PORSCHE	MACAN	
2008-2010	PORSCHE	CAYENNE	
2001-2005	PORSCHE	911	
<b>234-4879</b>			<b>C</b>
2015	PORSCHE	MACAN	
2014	PORSCHE	911	
2011	PORSCHE	911	
2006-2009	PORSCHE	911	
<b>234-4880</b>			<b>C</b>
2005-2008	CHRYSLER	PACIFICA	
2005-2008	CHRYSLER	TOWN & COUNTRY	
2008	DODGE	CALIBER	
2005-2007	DODGE	CARAVAN	
2005-2007	DODGE	GRAND CARAVAN	
2007-2009	JEEP	WRANGLER	
<b>234-4881</b>			<b>D</b>
2008-2010	CHRYSLER	SEBRING	
2008-2010	CHRYSLER	TOWN & COUNTRY	
2009-2010	DODGE	JOURNEY	
2008-2010	DODGE	AVENGER	
2008-2010	DODGE	GRAND CARAVAN	
2007-2010	DODGE	CALIBER	
2007-2010	JEEP	COMPASS	
2007-2010	JEEP	PATRIOT	
2007-2010	JEEP	WRANGLER	
2008-2015	MERCEDES-BENZ	C63 AMG	
2010-2013	MERCEDES-BENZ	S400	

#PART PIECE PARTE	MFR/ MARQUE FABRICANTE	MODEL MODELE MODELO	
<b>234-4881 (CONT.)</b>			<b>D</b>
2013	MERCEDES-BENZ	R350	
2010-2012	MERCEDES-BENZ	GLK350	
2009-2012	MERCEDES-BENZ	SL63 AMG	
2008-2012	MERCEDES-BENZ	GL550	
2007-2012	MERCEDES-BENZ	GL450	
2007-2012	MERCEDES-BENZ	SL550	
2010-2011	MERCEDES-BENZ	C250	
2009-2011	MERCEDES-BENZ	SLK300	
2008-2011	MERCEDES-BENZ	C300	
2008-2011	MERCEDES-BENZ	ML550	
2007-2011	MERCEDES-BENZ	CLS550	
2007-2011	MERCEDES-BENZ	E550	
2006-2011	MERCEDES-BENZ	B200	
2006-2011	MERCEDES-BENZ	C350	
2006-2011	MERCEDES-BENZ	E350	
2006-2011	MERCEDES-BENZ	ML350	
2006-2011	MERCEDES-BENZ	R350	
2005-2011	MERCEDES-BENZ	SLK350	
2007-2010	MERCEDES-BENZ	S550	
2007-2009	MERCEDES-BENZ	CLK63 AMG	
2007-2009	MERCEDES-BENZ	CLK550	
2006-2009	MERCEDES-BENZ	C230	
2006-2009	MERCEDES-BENZ	CLK350	
2006-2008	MERCEDES-BENZ	SLK280	
2008	MERCEDES-BENZ	R550	
2008	MERCEDES-BENZ	S450	
2006-2007	MERCEDES-BENZ	C280	
2005-2006	MERCEDES-BENZ	ML500	
2008-2015	SMART	FORTWO	
2009-2010	VOLKSWAGEN	ROUTAN	
<b>234-4882</b>			<b>D</b>
2000-2002	CHRYSLER	NEON	
2000-2002	DODGE	NEON	
2000-2001	PLYMOUTH	NEON	
<b>234-4883</b>			<b>D</b>
2004-2008	CHRYSLER	CROSSFIRE	
2008-2009	MERCEDES-BENZ	E300	
2007-2009	MERCEDES-BENZ	E550	
2006-2009	MERCEDES-BENZ	E350	
2003-2008	MERCEDES-BENZ	SL55 AMG	
2007	MERCEDES-BENZ	E280	
2005-2006	MERCEDES-BENZ	C55 AMG	
2005-2006	MERCEDES-BENZ	CL65 AMG	
2003-2006	MERCEDES-BENZ	CLK55 AMG	
2003-2006	MERCEDES-BENZ	CLK500	
2003-2006	MERCEDES-BENZ	E55 AMG	
2003-2006	MERCEDES-BENZ	E500	
2003-2006	MERCEDES-BENZ	SL500	
2001-2006	MERCEDES-BENZ	CL600	
2001-2006	MERCEDES-BENZ	S600	
2006	MERCEDES-BENZ	CLS55 AMG	

#PART PIECE PARTE	MFR/ MARQUE FABRICANTE	MODEL MODELE MODELO	
<b>234-4883 (CONT.)</b>			<b>D</b>
2006	MERCEDES-BENZ	CLS500	
2006	MERCEDES-BENZ	S65 AMG	
2003-2005	MERCEDES-BENZ	CLK320	
2003-2005	MERCEDES-BENZ	E320	
2001-2005	MERCEDES-BENZ	C240	
2001-2005	MERCEDES-BENZ	C320	
2002-2004	MERCEDES-BENZ	C32 AMG	
2002-2004	MERCEDES-BENZ	SLK32 AMG	
2001-2004	MERCEDES-BENZ	SLK320	
2004	MERCEDES-BENZ	SL600	
2002	MERCEDES-BENZ	C230	
2001	MERCEDES-BENZ	E55 AMG	
<b>234-4884</b>			<b>C</b>
2004-2008	CHRYSLER	CROSSFIRE	
2003-2005	MERCEDES-BENZ	ML350	
2002-2004	MERCEDES-BENZ	ML500	
2000-2004	MERCEDES-BENZ	SLK230	
2001-2003	MERCEDES-BENZ	ML320	
2001	MERCEDES-BENZ	ML430	
<b>234-4886</b>			<b>C</b>
1991-1992	DODGE	STEALTH	
1991-1992	MITSUBISHI	3000GT	
<b>234-4887</b>			<b>C</b>
1991-1992	DODGE	STEALTH	
1991-1992	MITSUBISHI	3000GT	
<b>234-4888</b>			<b>C</b>
1990-1991	DODGE	RAM 50	
1990-1994	MITSUBISHI	MIGHTY MAX	
1989-1990	MITSUBISHI	SIGMA	
1988	MITSUBISHI	GALANT	
<b>234-4889</b>			<b>C</b>
1991-1992	DODGE	STEALTH	
1991-1992	MITSUBISHI	3000GT	
<b>234-4890</b>			<b>C</b>
2001-2003	MERCEDES-BENZ	CLK320	
2001-2003	MERCEDES-BENZ	CLK430	
2001-2002	MERCEDES-BENZ	CLK55 AMG	
<b>234-4891</b>			<b>C</b>
2011-2012	BMW	740I	
2011-2012	BMW	740LI	
2008-2010	BMW	X6	
2003-2005	MERCEDES-BENZ	C240	
2003-2005	MERCEDES-BENZ	C320	
2001-2003	MERCEDES-BENZ	CLK320	
2001-2003	MERCEDES-BENZ	CLK430	
2001-2002	MERCEDES-BENZ	CLK55 AMG	
<b>234-4892</b>			<b>C</b>
2014-2015	BMW	M6 GRAN COUPE	
2012-2015	BMW	M5	
2012-2015	BMW	M6	
2006-2015	BMW	Z4	



#PART PIECE PARTE	MFR / MARQUE FABRICANTE	MODEL MODELE MODELO	
<b>234-4892 (CONT.)</b>			<b>C</b>
2011-2013	BMW	335IS	
2009-2013	BMW	328I XDRIVE	
2008-2013	BMW	128I	
2007-2013	BMW	328I	
2006-2011	BMW	323I	
2011	BMW	1 SERIES M	
2009-2010	BMW	335I XDRIVE	
2009-2010	BMW	528I XDRIVE	
2009-2010	BMW	535I XDRIVE	
2008-2010	BMW	135I	
2008-2010	BMW	528I	
2008-2010	BMW	535I	
2007-2010	BMW	335I	
2007-2010	BMW	X3	
2007-2010	BMW	X5	
2007-2008	BMW	328XI	
2007-2008	BMW	335XI	
2008	BMW	528XI	
2008	BMW	535XI	
2006-2007	BMW	525I	
2006-2007	BMW	525XI	
2006-2007	BMW	530I	
2006-2007	BMW	530XI	
2006	BMW	325I	
2006	BMW	325XI	
2006	BMW	330I	
2006	BMW	330XI	
<b>234-4893</b>			<b>D</b>
2005-2011	MERCEDES-BENZ	SLK55 AMG	
2006-2007	MERCEDES-BENZ	C280	
2006-2007	MERCEDES-BENZ	C350	
2006-2007	MERCEDES-BENZ	R500	
2007	MERCEDES-BENZ	ML500	
2004-2006	MERCEDES-BENZ	E500	
2006	MERCEDES-BENZ	CLK500	
2004-2005	MERCEDES-BENZ	E320	
2003-2005	MERCEDES-BENZ	C240	
2003-2005	MERCEDES-BENZ	C320	
2002-2005	MERCEDES-BENZ	C230	
2001-2003	MERCEDES-BENZ	CLK320	
2001-2003	MERCEDES-BENZ	CLK430	
2001-2002	MERCEDES-BENZ	CLK55 AMG	
2001-2002	MERCEDES-BENZ	E55 AMG	
2001-2002	MERCEDES-BENZ	E320	
2001-2002	MERCEDES-BENZ	E430	
<b>234-4894</b>			<b>C</b>
2008-2014	MERCEDES-BENZ	CL65 AMG	
2001-2014	MERCEDES-BENZ	CL600	
2006-2013	MERCEDES-BENZ	S65 AMG	
2001-2013	MERCEDES-BENZ	S600	
2005-2011	MERCEDES-BENZ	SL65 AMG	

#PART PIECE PARTE	MFR / MARQUE FABRICANTE	MODEL MODELE MODELO	
<b>234-4894 (CONT.)</b>			<b>C</b>
2004-2011	MERCEDES-BENZ	SL600	
2006-2007	MERCEDES-BENZ	C280	
2006-2007	MERCEDES-BENZ	C350	
2005-2006	MERCEDES-BENZ	CL65 AMG	
2000-2004	MERCEDES-BENZ	SLK230	
<b>234-4895</b>			<b>C</b>
2005-2009	MERCEDES-BENZ	SLR MCLAREN	
2001-2006	MERCEDES-BENZ	CL55 AMG	
2001-2006	MERCEDES-BENZ	S55 AMG	
2001-2006	MERCEDES-BENZ	S430	
2001-2006	MERCEDES-BENZ	S500	
2000-2006	MERCEDES-BENZ	CL500	
2001-2002	MERCEDES-BENZ	E320	
2001-2002	MERCEDES-BENZ	E430	
2002	MERCEDES-BENZ	E55 AMG	
<b>234-4896</b>			<b>C</b>
2010-2013	MERCEDES-BENZ	S400	
2013	MERCEDES-BENZ	R350	
2010-2012	MERCEDES-BENZ	C250	
2010-2012	MERCEDES-BENZ	GLK350	
2008-2012	MERCEDES-BENZ	C300	
2008-2012	MERCEDES-BENZ	GL550	
2007-2012	MERCEDES-BENZ	GL450	
2010-2011	MERCEDES-BENZ	E350	
2010-2011	MERCEDES-BENZ	E550	
2008-2011	MERCEDES-BENZ	C350	
2008-2011	MERCEDES-BENZ	ML550	
2008-2011	MERCEDES-BENZ	S450	
2007-2011	MERCEDES-BENZ	CLS63 AMG	
2007-2011	MERCEDES-BENZ	E63 AMG	
2007-2011	MERCEDES-BENZ	ML63 AMG	
2007-2011	MERCEDES-BENZ	S550	
2006-2011	MERCEDES-BENZ	ML350	
2006-2011	MERCEDES-BENZ	R350	
2008-2010	MERCEDES-BENZ	CL63 AMG	
2008-2010	MERCEDES-BENZ	S63 AMG	
2007-2010	MERCEDES-BENZ	CL550	
2006-2009	MERCEDES-BENZ	C230	
2008	MERCEDES-BENZ	R550	
2006-2007	MERCEDES-BENZ	C280	
2007	MERCEDES-BENZ	R63 AMG	
2005-2006	MERCEDES-BENZ	ML500	
2006	MERCEDES-BENZ	S350	
<b>234-4897</b>			<b>C</b>
2005-2011	MERCEDES-BENZ	SLK55 AMG	
2003-2011	MERCEDES-BENZ	G55 AMG	
2002-2008	MERCEDES-BENZ	G500	
2006-2007	MERCEDES-BENZ	R500	
2007	MERCEDES-BENZ	ML500	
2005-2006	MERCEDES-BENZ	C55 AMG	
2004-2006	MERCEDES-BENZ	CLK55 AMG	

#PART PIECE PARTE	MFR / MARQUE FABRICANTE	MODEL MODELE MODELO	
<b>234-4897 (CONT.)</b>			<b>C</b>
2003-2006	MERCEDES-BENZ	CLK500	
2001-2005	MERCEDES-BENZ	C240	
2001-2005	MERCEDES-BENZ	C320	
2001-2005	MERCEDES-BENZ	CLK320	
2002-2004	MERCEDES-BENZ	C32 AMG	
2001-2003	MERCEDES-BENZ	CLK430	
2001-2002	MERCEDES-BENZ	CLK55 AMG	
<b>234-4898</b>			<b>C</b>
2006-2007	MERCEDES-BENZ	R500	
2007	MERCEDES-BENZ	ML500	
2005-2006	MERCEDES-BENZ	C55 AMG	
2003-2006	MERCEDES-BENZ	CLK55 AMG	
2003-2006	MERCEDES-BENZ	CLK500	
2003-2005	MERCEDES-BENZ	CLK320	
2001-2005	MERCEDES-BENZ	C240	
2001-2005	MERCEDES-BENZ	C320	
2002-2004	MERCEDES-BENZ	C32 AMG	
<b>234-4899</b>			<b>C</b>
2005-2011	MERCEDES-BENZ	SLK55 AMG	
2005-2009	MERCEDES-BENZ	SLR MCLAREN	
2003-2008	MERCEDES-BENZ	SL55 AMG	
2006-2007	MERCEDES-BENZ	R500	
2007	MERCEDES-BENZ	ML500	
2003-2006	MERCEDES-BENZ	E55 AMG	
2003-2006	MERCEDES-BENZ	E500	
2003-2006	MERCEDES-BENZ	SL500	
2006	MERCEDES-BENZ	CLS55 AMG	
2006	MERCEDES-BENZ	CLS500	
2003-2005	MERCEDES-BENZ	E320	
<b>234-4900</b>			<b>C</b>
2010-2015	BMW	760LI	
2011-2012	BMW	740I	
2011-2012	BMW	740LI	
2008-2010	BMW	X6	
2010-2015	ROLLS-ROYCE	GHOST	
<b>234-4901</b>			<b>C</b>
2003-2011	MERCEDES-BENZ	G55 AMG	
2002-2008	MERCEDES-BENZ	G500	
<b>234-4902</b>			<b>C</b>
2004-2008	CHRYSLER	CROSSFIRE	
2001-2006	MERCEDES-BENZ	CL55 AMG	
2001-2006	MERCEDES-BENZ	S55 AMG	
2001-2006	MERCEDES-BENZ	S430	
2001-2006	MERCEDES-BENZ	S500	
2000-2006	MERCEDES-BENZ	CL500	
2003-2005	MERCEDES-BENZ	ML350	
2002-2004	MERCEDES-BENZ	ML500	
2002-2004	MERCEDES-BENZ	SLK32 AMG	
2001-2004	MERCEDES-BENZ	SLK320	
2001-2003	MERCEDES-BENZ	ML320	
2001-2002	MERCEDES-BENZ	E55 AMG	



#PART PIECE PARTE	MFR/ MARQUE FABRICANTE	MODEL MODELE MODELO	
<b>234-4902 (CONT.)</b>			<b>C</b>
2001-2002	MERCEDES-BENZ	E320	
2001-2002	MERCEDES-BENZ	E430	
2001	MERCEDES-BENZ	ML430	
<b>234-4903</b>			<b>C</b>
2007-2012	HYUNDAI	VERACRUZ	
2007-2009	HYUNDAI	SANTA FE	
<b>234-4904</b>			<b>C</b>
2013-2015	NISSAN	SENTRA	
<b>234-4905</b>			<b>C</b>
2013-2015	NISSAN	ALTIMA	
<b>234-4906</b>			<b>C</b>
2014-2015	NISSAN	ROGUE	
2013-2015	NISSAN	FRONTIER	
2013-2015	NISSAN	XTERRA	
2014	NISSAN	PATHFINDER	
<b>234-4907</b>			<b>C</b>
2013-2015	SUBARU	LEGACY	
2013-2015	SUBARU	OUTBACK	
<b>234-4908</b>			<b>C</b>
2013-2016	SCION	FR-S	
2013-2015	SUBARU	BRZ	
<b>234-4909</b>			<b>C</b>
2014-2016	SCION	TC	
<b>234-4910</b>			<b>C</b>
2010-2011	SAAB	9-3X	
2004-2011	SAAB	9-3	
<b>234-4911</b>			<b>C</b>
2004-2005	PORSCHE	CARRERA GT	
2002-2005	PORSCHE	911	
2000-2009	SAAB	9-5	
2000-2003	SAAB	9-3	
<b>234-4912</b>			<b>C</b>
2010-2011	SAAB	9-3X	
2004-2011	SAAB	9-3	
<b>234-4913</b>			<b>C</b>
2000-2009	SAAB	9-5	
2000-2003	SAAB	9-3	
<b>234-4914</b>			<b>C</b>
2000-2003	SAAB	9-5	
<b>234-4916</b>			<b>C</b>
2003-2004	PORSCHE	BOXSTER	
<b>234-4917</b>			<b>C</b>
2003-2004	PORSCHE	BOXSTER	
<b>234-4920</b>			<b>C</b>
2003-2004	PORSCHE	BOXSTER	
<b>234-4921</b>			<b>C</b>
2014-2016	TOYOTA	COROLLA	
<b>234-4922</b>			<b>C</b>
2014	LEXUS	IS250	
2014	LEXUS	IS350	
2013	LEXUS	GS450H	

#PART PIECE PARTE	MFR/ MARQUE FABRICANTE	MODEL MODELE MODELO	
<b>234-4923</b>			<b>C</b>
2002-2005	PORSCHE	911	
1994	PORSCHE	911	
<b>234-4924</b>			<b>C</b>
2014-2016	LEXUS	LS460	
2013-2016	LEXUS	GS450H	
<b>234-4925</b>			<b>C</b>
2014-2016	LEXUS	GX460	
2015-2016	TOYOTA	AVALON	
2015-2016	TOYOTA	CAMRY	
<b>234-4926</b>			<b>C</b>
2014-2016	TOYOTA	SEQUOIA	
2013-2016	TOYOTA	TUNDRA	
2013-2015	TOYOTA	TACOMA	
<b>234-4927</b>			<b>C</b>
2015-2016	LEXUS	ES350	
2015-2016	LEXUS	GX460	
2015-2016	LEXUS	LX570	
2015-2016	TOYOTA	AVALON	
2015-2016	TOYOTA	CAMRY	
2015-2016	TOYOTA	LAND CRUISER	
2015-2016	TOYOTA	SEQUOIA	
2015-2016	TOYOTA	TUNDRA	
2013-2015	TOYOTA	TACOMA	
<b>234-4928</b>			<b>C</b>
2014-2015	LEXUS	RX450H	
2014-2016	TOYOTA	HIGHLANDER	
<b>234-4929</b>			<b>C</b>
2014-2016	LEXUS	LS460	
<b>234-4930</b>			<b>C</b>
2015-2016	LEXUS	RC350	
2014-2016	LEXUS	IS350	
2016	LEXUS	IS300	
2014-2015	LEXUS	GS350	
2014-2015	LEXUS	IS250	
<b>234-4931</b>			<b>C</b>
2014-2016	LEXUS	LX570	
2014-2016	TOYOTA	LAND CRUISER	
2013-2016	TOYOTA	4RUNNER	
2013-2014	TOYOTA	FJ CRUISER	
<b>234-4932</b>			<b>C</b>
2015	VOLVO	XC60	
2013-2014	VOLVO	S60	
<b>234-4933</b>			<b>C</b>
2013-2015	VOLKSWAGEN	JETTA	
<b>234-4934</b>			<b>C</b>
2013-2014	VOLKSWAGEN	JETTA	
<b>234-4935</b>			<b>C</b>
2015	AUDI	A8 QUATTRO	
2014-2015	VOLKSWAGEN	PASSAT	
2013-2015	VOLKSWAGEN	BEETLE	
2013-2015	VOLKSWAGEN	JETTA	

#PART PIECE PARTE	MFR/ MARQUE FABRICANTE	MODEL MODELE MODELO	
<b>234-4936</b>			<b>C</b>
2013-2014	LINCOLN	MKT	
<b>234-4938</b>			<b>D</b>
2009-2012	HYUNDAI	ELANTRA	
2008	HYUNDAI	TIBURON	
2010-2011	KIA	SOUL	
<b>234-4939</b>			<b>D</b>
2014-2015	MAZDA	3	
2014-2015	MAZDA	6	
2014	MAZDA	3 SPORT	
<b>234-4940</b>			<b>D</b>
2015	CADILLAC	ESCALADE	
2015	CADILLAC	ESCALADE ESV	
2014-2015	CHEVROLET	SILVERADO 1500	
2015	CHEVROLET	SUBURBAN	
2015	CHEVROLET	TAHOE	
2014-2015	GMC	SIERRA 1500	
2015	GMC	YUKON	
2015	GMC	YUKON XL	
<b>234-4941</b>			<b>D</b>
2015	VOLVO	S60	
2015	VOLVO	S80	
2015	VOLVO	V60	
2015	VOLVO	XC60	
2015	VOLVO	XC70	
<b>234-4944</b>			<b>D</b>
2015	LINCOLN	NAVIGATOR	
<b>234-4945</b>			<b>D</b>
2015-2016	LEXUS	IS350	
2015-2016	LEXUS	RC350	
2015-2016	LEXUS	RC F	
2014-2016	LEXUS	GS450H	
2016	LEXUS	GS F	
2016	LEXUS	IS300	
2014-2015	LEXUS	GS350	
2015	LEXUS	IS250	
<b>234-4946</b>			<b>D</b>
2015-2016	TOYOTA	SIENNA	
<b>234-4947</b>			<b>D</b>
2015-2016	TOYOTA	VENZA	
<b>234-4948</b>			<b>D</b>
2014-2016	TOYOTA	HIGHLANDER	
<b>234-4949</b>			<b>D</b>
2015-2016	TOYOTA	VENZA	
<b>234-4950</b>			<b>C</b>
1995-1996	JAGUAR	XJ12	
1995	JAGUAR	XJS	
<b>234-4951</b>			<b>C</b>
2010-2011	JAGUAR	XFR	
2009-2011	JAGUAR	XF	
2007-2009	JAGUAR	XK	
2006-2009	JAGUAR	SUPER V8	

**NUMERICAL LISTING**



#PART PIECE PARTE	MFR / MARQUE FABRICANTE	MODEL MODELE MODELO	
<b>234-4951 (CONT.)</b>			<b>C</b>
2006-2009	JAGUAR	VANDEN PLAS	
2006-2009	JAGUAR	XJ8	
2006-2009	JAGUAR	XJR	
2006-2009	JAGUAR	XKR	
2006-2008	JAGUAR	S-TYPE	
2006	JAGUAR	XK8	
<b>234-4952</b>			<b>D</b>
2014-2015	MITSUBISHI	MIRAGE	
<b>234-4953</b>			<b>C</b>
1995-1997	JAGUAR	VANDEN PLAS	
1995-1997	JAGUAR	XJ6	
1995-1997	JAGUAR	XJR	
1995-1996	JAGUAR	XJS	
<b>234-4954</b>			<b>C</b>
2002-2006	HONDA	INSIGHT	
<b>234-4955</b>			<b>C</b>
2002-2006	HONDA	INSIGHT	
<b>234-4956</b>			<b>D</b>
2013-2015	HYUNDAI	SANTA FE	
<b>234-4957</b>			<b>D</b>
2014	KIA	SEDONA	
<b>234-4958</b>			<b>D</b>
2014-2015	KIA	SOUL	
2014	KIA	FORTE	
2014	KIA	FORTE KOUP	
<b>234-4959</b>			<b>D</b>
2014	KIA	FORTE	
2014	KIA	FORTE KOUP	
<b>234-4960</b>			<b>D</b>
2014-2015	FORD	FUSION	
<b>234-4961</b>			<b>D</b>
2015	FORD	F-150	
2015	FORD	MUSTANG	
<b>234-4962</b>			<b>D</b>
2014-2015	FORD	FIESTA	
<b>234-4963</b>			<b>D</b>
2014-2015	FORD	FIESTA	
<b>234-4964</b>			<b>D</b>
2015	FORD	TRANSIT-150	
2015	FORD	TRANSIT-250	
2015	FORD	TRANSIT-350	
<b>234-4965</b>			<b>D</b>
2015	FORD	TRANSIT-150	
2015	FORD	TRANSIT-250	
2015	FORD	TRANSIT-350	
<b>234-4966</b>			<b>D</b>
2015	FORD	MUSTANG	
<b>234-4967</b>			<b>D</b>
2015	FORD	MUSTANG	
<b>234-4968</b>			<b>D</b>
2015	FORD	F-150	

#PART PIECE PARTE	MFR / MARQUE FABRICANTE	MODEL MODELE MODELO	
<b>234-4968 (CONT.)</b>			<b>D</b>
2015	FORD	MUSTANG	
<b>234-4969</b>			<b>D</b>
2014-2015	PORSCHE	PANAMERA	
<b>234-4970</b>			<b>D</b>
2014-2015	BMW	I3	
<b>234-4971</b>			<b>D</b>
2014-2015	BMW	335I	
2014-2015	BMW	335I XDRIVE	
2014-2015	BMW	435I	
2014-2015	BMW	435I XDRIVE	
2014-2015	BMW	ACTIVEHYBRID 3	
2014-2015	BMW	ACTIVEHYBRID 5	
2014-2015	BMW	M235I	
2014-2015	BMW	X5	
2015	BMW	335I GT XDRIVE	
2015	BMW	435I GRAN COUPE	
2015	BMW	435I XDRIVE GRAN	
2015	BMW	640I	
2015	BMW	640I GRAN COUPE	
2015	BMW	640I XDRIVE	
2015	BMW	640I XDRIVE GRAN	
2015	BMW	M235I XDRIVE	
2015	BMW	X6	
2014-2015	MINI	COOPER	
<b>234-4972</b>			<b>D</b>
2015	BMW	M3	
2015	BMW	M4	
<b>234-4973</b>			<b>D</b>
2014-2015	BMW	I8	
2015	BMW	M3	
2015	BMW	M4	
<b>234-4974</b>			<b>D</b>
2015	CADILLAC	ESCALADE	
2015	CADILLAC	ESCALADE ESV	
2014-2015	CHEVROLET	CORVETTE	
2014-2015	CHEVROLET	SILVERADO 1500	
2015	CHEVROLET	SUBURBAN	
2015	CHEVROLET	TAHOE	
2014-2015	GMC	SIERRA 1500	
2015	GMC	YUKON	
2015	GMC	YUKON XL	
<b>234-4975</b>			<b>D</b>
2015-2016	BUICK	VERANO	
<b>234-4976</b>			<b>D</b>
2014-2015	HONDA	ODYSSEY	
<b>234-4977</b>			<b>D</b>
2014	HONDA	CR-V	
<b>234-4978</b>			<b>D</b>
2015-2016	HONDA	FIT	
<b>234-4979</b>			<b>D</b>
2015	ACURA	ILX	

#PART PIECE PARTE	MFR / MARQUE FABRICANTE	MODEL MODELE MODELO	
<b>234-4979 (CONT.)</b>			<b>D</b>
2016	HONDA	HR-V	
2014	HONDA	CIVIC	
<b>234-4980</b>			<b>D</b>
2015	HONDA	CR-V	
<b>234-4981</b>			<b>D</b>
2014-2015	LAND ROVER	LR4	
2014	LAND ROVER	RANGE ROVER	
<b>234-4982</b>			<b>D</b>
2015	LAND ROVER	RANGE ROVER	
<b>234-4983</b>			<b>D</b>
2015	MERCEDES-BENZ	GL450	
2015	MERCEDES-BENZ	ML400	
<b>234-4984</b>			<b>D</b>
2015-2016	MERCEDES-BENZ	C300	
<b>234-4985</b>			<b>D</b>
2015	INFINITI	QX60	
2015	NISSAN	ALTIMA	
2015	NISSAN	JUKE	
2015	NISSAN	MURANO	
2015	NISSAN	PATHFINDER	
2015	NISSAN	QUEST	
<b>234-4986</b>			<b>D</b>
2015	INFINITI	QX60	
2015	NISSAN	ALTIMA	
2015	NISSAN	JUKE	
2015	NISSAN	MURANO	
2015	NISSAN	PATHFINDER	
<b>234-4987</b>			<b>D</b>
2015	NISSAN	QUEST	
<b>234-4988</b>			<b>D</b>
2014-2015	SUBARU	FORESTER	
2015	SUBARU	WRX	
<b>234-4989</b>			<b>D</b>
2015	SUBARU	LEGACY	
<b>234-4990</b>			<b>D</b>
2015	AUDI	A8 QUATTRO	
<b>234-4991</b>			<b>D</b>
2015	AUDI	A8 QUATTRO	
<b>234-4992</b>			<b>D</b>
2015	AUDI	A3 QUATTRO	
2015	AUDI	S3	
2015	VOLKSWAGEN	GOLF	
2015	VOLKSWAGEN	GOLF SPORTWAGEN	
2015	VOLKSWAGEN	GTI	
<b>234-4993</b>			<b>D</b>
2015	AUDI	A8 QUATTRO	
<b>234-4994</b>			<b>D</b>
2015	AUDI	A8 QUATTRO	
<b>234-4995</b>			<b>D</b>
2015	AUDI	A8 QUATTRO	



#PART PIECE PARTE	MFR/ MARQUE FABRICANTE	MODEL MODELE MODELO
<b>234-4996</b> D		
2015-2016	TOYOTA	YARIS
<b>234-5001</b> D		
2005-2006	CADILLAC	XLR
<b>234-5002</b> D		
2005-2006	CADILLAC	STS
2004-2006	CADILLAC	SRX
2004-2005	CADILLAC	CTS
<b>234-5003</b> A		
2004-2005	CADILLAC	XLR
2000-2002	SUBARU	FORESTER
2000-2002	SUBARU	IMPREZA
2000-2002	SUBARU	LEGACY
2000-2002	SUBARU	OUTBACK
<b>234-5004</b> D		
2004-2006	BUICK	RENDEZVOUS
<b>234-5005</b> D		
2005-2008	BUICK	ALLURE
2005-2008	BUICK	LACROSSE
<b>234-5006</b> D		
1999-2001	CADILLAC	CATERA
2001-2005	SATURN	L300
2001-2003	SATURN	LW300
2000	SATURN	LS2
2000	SATURN	LW2
<b>234-5007</b> D		
2008-2010	CHEVROLET	COBALT
2008-2010	CHEVROLET	HHR
2014	KIA	FORTE
2014	KIA	FORTE KOUP
2007-2009	PONTIAC	SOLSTICE
2007-2010	SATURN	SKY
<b>234-5008</b> D		
2008-2009	AUDI	A8 QUATTRO
2008-2009	AUDI	S8
<b>234-5009</b> D		
2015	AUDI	A8 QUATTRO
2012-2013	AUDI	TT QUATTRO
2008-2011	AUDI	S6
<b>234-5010</b> C		
2005-2008	ACURA	RL
2004-2008	ACURA	TL
2003-2006	ACURA	MDX
2006-2008	HONDA	RIDGELINE
2005-2008	HONDA	PILOT
2003-2007	HONDA	ACCORD
2005-2006	HONDA	ODYSSEY
2004-2007	SATURN	VUE
<b>234-5011</b> D		
2006-2008	MAZDA	6
<b>234-5012</b> D		
2007-2012	MAZDA	CX-7

#PART PIECE PARTE	MFR/ MARQUE FABRICANTE	MODEL MODELE MODELO
<b>234-5013</b> D		
2007-2009	MAZDA	3
<b>234-5014</b> D		
2006-2007	MAZDA	6
<b>234-5015</b> D		
2006-2011	MAZDA	3
2009-2010	MAZDA	3 SPORT
2008-2010	MAZDA	5
<b>234-5018</b> D		
2009-2010	ACURA	RL
<b>234-5019</b> D		
2014-2015	AUDI	R8
2013-2015	AUDI	A4 ALLROAD
2013-2015	AUDI	A6 QUATTRO
2013-2015	AUDI	ALLROAD
2012-2015	AUDI	A6
2011-2015	AUDI	Q5
2010-2015	AUDI	A5 QUATTRO
2009-2015	AUDI	A4
2009-2015	AUDI	A4 QUATTRO
2015	AUDI	A8 QUATTRO
2010-2014	AUDI	A5
2010-2012	AUDI	R8
2008-2011	AUDI	S6
2007-2010	AUDI	Q7
2008-2009	AUDI	A8 QUATTRO
2008-2009	AUDI	S8
2013-2015	VOLKSWAGEN	JETTA
2012-2015	VOLKSWAGEN	PASSAT
2007-2015	VOLKSWAGEN	TOUAREG
<b>234-5022</b> D		
2008-2009	AUDI	S8
<b>234-5023</b> D		
2014-2015	PORSCHE	PANAMERA
2008-2014	PORSCHE	CAYENNE
2009-2012	PORSCHE	911
2009-2012	PORSCHE	BOXSTER
2009-2012	PORSCHE	CAYMAN
<b>234-5024</b> D		
2008-2015	PORSCHE	CAYENNE
<b>234-5025</b> D		
2011-2012	BMW	740I
2011-2012	BMW	740LI
2009-2010	BMW	535I XDRIVE
2008-2010	BMW	535I
2008-2010	BMW	X6
2008	BMW	535XI
<b>234-5026</b> D		
2014-2015	BMW	M6 GRAN COUPE
2013-2015	BMW	650I GRAN COUPE
2013-2015	BMW	650I XDRIVE GRAN
2012-2015	BMW	650I

#PART PIECE PARTE	MFR/ MARQUE FABRICANTE	MODEL MODELE MODELO
<b>234-5026 (CONT.)</b> D		
2012-2015	BMW	650I XDRIVE
2012-2015	BMW	M5
2012-2015	BMW	M6
2011-2015	BMW	550I
2011-2015	BMW	550I XDRIVE
2011-2015	BMW	ALPINA B7
2011-2015	BMW	ALPINA B7L
2011-2015	BMW	ALPINA B7L XDRIVE
2011-2015	BMW	ALPINA B7 XDRIVE
2010-2015	BMW	550I GT
2010-2015	BMW	550I GT XDRIVE
2010-2015	BMW	750I XDRIVE
2010-2015	BMW	750LI XDRIVE
2010-2015	BMW	X5
2009-2015	BMW	750I
2009-2015	BMW	750LI
2008-2015	BMW	X6
2015	BMW	ALPINA B6 XDRIVE
2013-2015	MINI	COOPER PACEMAN
2011-2015	MINI	COOPER
2011-2015	MINI	COOPER
<b>234-5027</b> D		
2011-2012	BMW	740I
2011-2012	BMW	740LI
2010-2012	BMW	X3
2011	BMW	528I
2009-2010	BMW	535I XDRIVE
2008-2010	BMW	535I
2008-2010	BMW	X6
2008	BMW	535XI
<b>234-5028</b> D		
2004-2009	AUDI	S4
2003-2006	AUDI	TT QUATTRO
2002-2006	AUDI	A4 QUATTRO
2003-2005	AUDI	ALLROAD QUATTRO
2002-2005	AUDI	A4
2002-2004	AUDI	A6
2002-2004	AUDI	A6 QUATTRO
2004-2006	PORSCHE	CAYENNE
1999-2001	VOLKSWAGEN	BETLE
<b>234-5029</b> D		
2010-2015	HYUNDAI	SANTA FE
2010-2014	HYUNDAI	TUCSON
2009-2014	HYUNDAI	SONATA
2011-2015	KIA	OPTIMA
2011-2015	KIA	SORENTO
2011-2014	KIA	SPORTAGE
2012-2013	KIA	FORTE5
2010-2013	KIA	FORTE
2010-2013	KIA	FORTE KOUP
2009-2012	KIA	RONDO



#PART PIECE PARTE	MFR / MARQUE FABRICANTE	MODEL MODELE MODELO	D
<b>234-5030</b>			<b>D</b>
2011-2013	HYUNDAI	SONATA	
2012-2013	KIA	FORTES	
2010-2013	KIA	FORTE	
2010-2013	KIA	FORTE KOUP	
2010-2013	KIA	OPTIMA	
2009-2012	KIA	RONDO	
2010	KIA	MAGENTIS	
<b>234-5032</b>			<b>D</b>
2010	FORD	FUSION	
2009-2010	MAZDA	6	
2010	MERCURY	MILAN	
<b>234-5033</b>			<b>D</b>
2009-2013	MAZDA	6	
<b>234-5034</b>			<b>D</b>
2015	AUDI	Q3	
2015	AUDI	Q3 QUATTRO	
2011-2015	PORSCHE	CAYENNE	
2015	PORSCHE	PANAMERA	
2012-2013	PORSCHE	PANAMERA	
2009-2015	VOLKSWAGEN	TIGUAN	
<b>234-5036</b>			<b>D</b>
2014-2015	AUDI	A6 QUATTRO	
2014-2015	AUDI	A7 QUATTRO	
2014-2015	AUDI	A8 QUATTRO	
2014-2015	AUDI	Q5	
2014-2015	AUDI	R8	
2009-2015	AUDI	Q7	
2015	AUDI	A3	
2008-2013	AUDI	A3	
2010-2012	AUDI	R8	
2008-2011	AUDI	S6	
2009	AUDI	A3 QUATTRO	
2010-2015	PORSCHE	PANAMERA	
2015	PORSCHE	CAYENNE	
2014	PORSCHE	911	
2013-2015	VOLKSWAGEN	BEETLE	
2012-2015	VOLKSWAGEN	PASSAT	
2010-2015	VOLKSWAGEN	CC	
2009-2015	VOLKSWAGEN	EOS	
2009-2015	VOLKSWAGEN	TOUAREG	
2008-2015	VOLKSWAGEN	JETTA	
2015	VOLKSWAGEN	GOLF SPORTWAGEN	
2010-2014	VOLKSWAGEN	GOLF	
2008-2014	VOLKSWAGEN	GTI	
2010	VOLKSWAGEN	PASSAT	
2005-2006	VOLKSWAGEN	JETTA	
<b>234-5037</b>			<b>D</b>
2010-2015	BMW	760LI	
2013-2015	MINI	COOPER PACEMAN	
2011-2015	MINI	COOPER	
2011-2015	MINI	COOPER	

#PART PIECE PARTE	MFR / MARQUE FABRICANTE	MODEL MODELE MODELO	D
<b>234-5037 (CONT.)</b>			<b>D</b>
2010-2015	ROLLS-ROYCE	GHOST	
<b>234-5038</b>			<b>D</b>
2013-2015	FORD	FLEX	
2013-2015	FORD	TAURUS	
2011-2015	FORD	EXPLORER	
2015	FORD	TRANSIT-150	
2015	FORD	TRANSIT-250	
2015	FORD	TRANSIT-350	
2013-2014	FORD	POLICE INTERCEPTOR	
2013-2014	FORD	POLICE INTERCEPTOR	
2011-2014	FORD	EDGE	
2011-2014	FORD	F-150	
2011-2014	FORD	MUSTANG	
2010-2012	FORD	ESCAPE	
2010-2012	FORD	FUSION	
2013-2015	LINCOLN	MKT	
2013-2015	LINCOLN	MKZ	
2013-2014	LINCOLN	MKS	
2012-2014	LINCOLN	MKX	
2011-2015	MAZDA	CX-9	
2011-2013	MAZDA	6	
2010-2011	MAZDA	TRIBUTE	
2010-2011	MERCURY	MARINER	
2010-2011	MERCURY	MILAN	
<b>234-5039</b>			<b>D</b>
2010-2013	FORD	ESCAPE	
2010-2012	FORD	FUSION	
2010-2011	MAZDA	TRIBUTE	
2010-2011	MERCURY	MARINER	
2010-2011	MERCURY	MILAN	
<b>234-5040</b>			<b>D</b>
2010-2011	MAZDA	3	
<b>234-5041</b>			<b>D</b>
2010-2011	MAZDA	3	
2010	MAZDA	3 SPORT	
<b>234-5042</b>			<b>D</b>
2010-2013	MAZDA	3	
<b>234-5043</b>			<b>D</b>
2010-2012	MAZDA	CX-7	
<b>234-5044</b>			<b>D</b>
2013-2014	HYUNDAI	GENESIS COUPE	
2010-2013	HYUNDAI	TUCSON	
2011-2013	KIA	SPORTAGE	
<b>234-5045</b>			<b>D</b>
2007-2010	AUDI	Q7	
2005-2007	AUDI	A8 QUATTRO	
2004-2006	AUDI	TT QUATTRO	
2003-2006	PORSCHE	CAYENNE	
2007-2010	VOLKSWAGEN	GOLF CITY	
2007-2009	VOLKSWAGEN	JETTA CITY	
2007-2009	VOLKSWAGEN	TOUAREG	

#PART PIECE PARTE	MFR / MARQUE FABRICANTE	MODEL MODELE MODELO	D
<b>234-5045 (CONT.)</b>			<b>D</b>
2002-2006	VOLKSWAGEN	GOLF	
2001-2005	VOLKSWAGEN	BEETLE	
2001-2005	VOLKSWAGEN	JETTA	
2002-2004	VOLKSWAGEN	PASSAT	
2004	VOLKSWAGEN	TOUAREG	
<b>234-5046</b>			<b>D</b>
2014-2015	FREIGHTLINER	SPRINTER 2500	
2014-2015	FREIGHTLINER	SPRINTER 3500	
2014-2015	MERCEDES-BENZ	SPRINTER 2500	
2014-2015	MERCEDES-BENZ	SPRINTER 3500	
2011-2015	MERCEDES-BENZ	GL350	
2011-2014	MERCEDES-BENZ	ML350	
2010-2013	MERCEDES-BENZ	R350	
<b>234-5047</b>			<b>D</b>
2010	HYUNDAI	ELANTRA	
<b>234-5048</b>			<b>D</b>
2014-2015	BMW	435I	
2014-2015	BMW	435I XDRIVE	
2014-2015	BMW	535I XDRIVE	
2014-2015	BMW	640I	
2014-2015	BMW	640I XDRIVE	
2014-2015	BMW	640I XDRIVE GRAN	
2014-2015	BMW	M235I	
2012-2015	BMW	ACTIVEHYBRID 5	
2011-2015	BMW	535I	
2011-2015	BMW	535I GT XDRIVE	
2011-2015	BMW	X5	
2011-2015	BMW	X6	
2010-2015	BMW	535I GT	
2015	BMW	435I GRAN COUPE	
2015	BMW	435I XDRIVE GRAN	
2015	BMW	640I GRAN COUPE	
2015	BMW	M3	
2015	BMW	M4	
2015	BMW	M235I XDRIVE	
2014	BMW	335I	
2014	BMW	335I XDRIVE	
2014	BMW	ACTIVEHYBRID 3	
<b>234-5049</b>			<b>D</b>
2015	MINI	LANCER	
2011-2013	MITSUBISHI	OUTLANDER SPORT	
2011-2012	MITSUBISHI	LANCER	
<b>234-5050</b>			<b>D</b>
2000-2001	HONDA	INSIGHT	
<b>234-5051</b>			<b>D</b>
2015	MITSUBISHI	LANCER	
2011-2013	MITSUBISHI	OUTLANDER	
2011-2013	MITSUBISHI	RVR	
2011-2012	MITSUBISHI	LANCER	
2011-2012	MITSUBISHI	OUTLANDER SPORT	





#PART PIECE PARTE	MFR/ MARQUE FABRICANTE	MODEL MODELE MODELO
<b>234-5052</b> D		
1992-2000	HONDA	CIVIC
<b>234-5053</b> D		
2007-2009	ACURA	MDX
2007-2010	HONDA	ODYSSEY
<b>234-5054</b> D		
2014-2015	BMW	228I
2014-2015	BMW	328I GT XDRIVE
2014-2015	BMW	428I
2014-2015	BMW	428I XDRIVE
2013-2015	BMW	320I XDRIVE
2013-2015	BMW	328I XDRIVE
2013-2015	BMW	X3
2012-2015	BMW	320I
2012-2015	BMW	328I
2012-2015	BMW	528I
2012-2015	BMW	528I XDRIVE
2012-2015	BMW	X1
2012-2015	BMW	Z4
2015	BMW	228I XDRIVE
2015	BMW	428I GRAN COUPE
2015	BMW	428I XDRIVE GRAN
2015	BMW	X4
<b>234-5055</b> D		
2012-2014	HYUNDAI	ACCENT
2012-2014	HYUNDAI	VELOSTER
2012-2015	KIA	SOUL
2012-2014	KIA	RIO
<b>234-5056</b> D		
2014-2016	ACURA	MDX
2014-2016	ACURA	RLX
2013-2016	ACURA	RDX
2015	ACURA	TLX
2012-2016	HONDA	PILOT
2014-2015	HONDA	ODYSSEY
2013-2015	HONDA	ACCORD
2013-2015	HONDA	CROSSTOUR
2012-2014	HONDA	RIDGELINE
<b>234-5057</b> D		
2013-2014	LAND ROVER	LR2
2012-2013	LAND ROVER	RANGE ROVER
<b>234-5058</b> D		
2012-2013	MAZDA	3
2012-2013	MAZDA	3 SPORT
<b>234-5059</b> D		
2014-2015	MAZDA	3
2014-2015	MAZDA	6
2013-2015	MAZDA	CX-5
2014	MAZDA	3 SPORT
<b>234-5060</b> C		
2006-2010	INFINITI	M45
2006-2008	INFINITI	FX45

#PART PIECE PARTE	MFR/ MARQUE FABRICANTE	MODEL MODELE MODELO
<b>234-5060 (CONT.)</b> C		
2004-2006	INFINITI	QX56
2006	INFINITI	Q45
2004-2009	NISSAN	QUEST
2004-2008	NISSAN	MAXIMA
2004-2007	NISSAN	MURANO
2005-2006	NISSAN	ARMADA
2005-2006	NISSAN	FRONTIER
2005-2006	NISSAN	XTERRA
2004-2006	NISSAN	ALTIMA
2004-2006	NISSAN	PATHFINDER
2004-2006	NISSAN	TITAN
2000-2002	NISSAN	SENTRA
<b>234-5061</b> C		
2006-2008	INFINITI	M35
2004-2008	INFINITI	FX35
2004-2007	INFINITI	G35
2005-2006	NISSAN	350Z
2004-2006	NISSAN	ALTIMA
2003-2006	NISSAN	SENTRA
<b>234-5062</b> D		
2005-2009	NISSAN	FRONTIER
2009	SUZUKI	EQUATOR
<b>234-5063</b> D		
2012-2013	MAZDA	3
2012-2013	MAZDA	3 SPORT
<b>234-5064</b> D		
2012-2015	MERCEDES-BENZ	C250
2012-2015	MERCEDES-BENZ	SLK250
<b>234-5065</b> D		
2014	MERCEDES-BENZ	C300
2014	MERCEDES-BENZ	C350
2014	MERCEDES-BENZ	GLK350
2012-2013	MERCEDES-BENZ	E300
2012	MERCEDES-BENZ	C350
2012	MERCEDES-BENZ	E350
<b>234-5066</b> D		
2012-2014	MERCEDES-BENZ	E63 AMG
2014	MERCEDES-BENZ	E63 AMG S
2012-2013	MERCEDES-BENZ	CLS63 AMG
2012-2013	MERCEDES-BENZ	CLS550
2012-2013	MERCEDES-BENZ	E550
<b>234-5067</b> D		
2012-2015	MERCEDES-BENZ	SLK55 AMG
2012-2015	MERCEDES-BENZ	SLK350
<b>234-5068</b> D		
2013-2015	FORD	ESCAPE
2013-2015	FORD	FUSION
2014	FORD	C-MAX
2013-2015	LINCOLN	MKZ
<b>234-5069</b> D		
2012-2014	PORSCHE	911

#PART PIECE PARTE	MFR/ MARQUE FABRICANTE	MODEL MODELE MODELO
<b>234-5071</b> D		
2008-2015	SMART	FORTWO
<b>234-5072</b> D		
2001-2005	PORSCHE	911
<b>234-5073</b> D		
2004-2006	PORSCHE	CAYENNE
<b>234-5074</b> D		
2003-2006	PORSCHE	CAYENNE
<b>234-5075</b> D		
2013-2015	DODGE	DART
2012-2014	FIAT	500
2014-2015	MITSUBISHI	OUTLANDER
<b>234-5076</b> D		
2014-2015	FORD	FIESTA
2010-2015	FORD	F-150
2015	FORD	TRANSIT-150
2015	FORD	TRANSIT-250
2015	FORD	TRANSIT-350
2011-2014	FORD	EXPEDITION
2011-2015	LINCOLN	NAVIGATOR
<b>234-5077</b> D		
2012-2014	MAZDA	5
<b>234-5078</b> D		
2012-2013	MAZDA	3 SPORT
2011-2013	MAZDA	3
<b>234-5079</b> D		
2014-2015	BMW	335I GT XDRIVE
2013-2015	BMW	X1
2015	BMW	335I
2015	BMW	335I XDRIVE
2015	BMW	ACTIVEHYBRID 3
2011-2013	BMW	135I
2011-2013	BMW	335I
2011-2013	BMW	335I XDRIVE
2013	BMW	135IS
2013	BMW	ACTIVEHYBRID 3
<b>234-5080</b> D		
2013-2015	BMW	740I
2013-2015	BMW	740LI
2013-2015	BMW	740LI XDRIVE
2013-2015	BMW	ACTIVEHYBRID 7
2011-2015	BMW	X3
2015	BMW	X4
2013-2014	BMW	640I GRAN COUPE
2012-2013	BMW	640I
2011-2013	BMW	535I XDRIVE
<b>234-5081</b> D		
2009-2010	HYUNDAI	SONATA
<b>234-5082</b> D		
2013-2014	HYUNDAI	ELANTRA COUPE
2013-2014	HYUNDAI	ELANTRA GT
2011-2014	HYUNDAI	ELANTRA



#PART PIECE PARTE	MFR / MARQUE FABRICANTE	MODEL MODELE MODELO	D
<b>234-5082 (CONT.)</b>			<b>D</b>
2014	KIA	FORTE	
2014	KIA	FORTE KOUP	
<b>234-5083</b>			<b>D</b>
2013-2014	HYUNDAI	ELANTRA COUPE	
2013-2014	HYUNDAI	ELANTRA GT	
2011-2014	HYUNDAI	ELANTRA	
2014-2015	KIA	RONDO	
2012-2015	KIA	SOUL	
2014	KIA	FORTE	
2014	KIA	FORTE KOUP	
<b>234-5084</b>			<b>D</b>
2010-2015	FREIGHTLINER	SPRINTER 2500	
2010-2015	FREIGHTLINER	SPRINTER 3500	
2010-2015	MERCEDES-BENZ	SPRINTER 2500	
2010-2015	MERCEDES-BENZ	SPRINTER 3500	
2011-2013	MERCEDES-BENZ	E350	
<b>234-5085</b>			<b>D</b>
2013-2015	MERCEDES-BENZ	SL65 AMG	
2015	MERCEDES-BENZ	C400	
2015	MERCEDES-BENZ	E400	
2015	MERCEDES-BENZ	GL450	
2015	MERCEDES-BENZ	ML400	
2015	MERCEDES-BENZ	S65 AMG	
2015	MERCEDES-BENZ	S600	
2011-2014	MERCEDES-BENZ	CL63 AMG	
2011-2014	MERCEDES-BENZ	CL550	
2011-2013	MERCEDES-BENZ	S63 AMG	
2012	MERCEDES-BENZ	S550	
<b>234-5086</b>			<b>D</b>
2007-2009	MERCEDES-BENZ	E320	
<b>234-5087</b>			<b>D</b>
2011-2015	PORSCHE	CAYENNE	
<b>234-5090</b>			<b>D</b>
2007-2010	DODGE	RAM 2500 PICKUP	
2007-2010	DODGE	RAM 3500 PICKUP	
2011-2012	RAM	2500	
2011-2012	RAM	3500	
<b>234-5091</b>			<b>D</b>
2003-2009	DODGE	SPRINTER 2500	
2003-2009	DODGE	SPRINTER 3500	
2002-2009	FREIGHTLINER	SPRINTER 2500	
2002-2009	FREIGHTLINER	SPRINTER 3500	
2011-2015	MERCEDES-BENZ	SLS AMG	
2009-2012	MERCEDES-BENZ	SL63 AMG	
2007-2011	MERCEDES-BENZ	CLS63 AMG	
2007-2011	MERCEDES-BENZ	E63 AMG	
2008-2010	MERCEDES-BENZ	CL63 AMG	
2008-2010	MERCEDES-BENZ	S63 AMG	
2010	MERCEDES-BENZ	ML450	
2008-2009	MERCEDES-BENZ	E300	
2007-2009	MERCEDES-BENZ	CLK63 AMG	

#PART PIECE PARTE	MFR / MARQUE FABRICANTE	MODEL MODELE MODELO	D
<b>234-5091 (CONT.)</b>			<b>D</b>
2007-2009	MERCEDES-BENZ	CLK550	
2007-2009	MERCEDES-BENZ	E550	
2006-2009	MERCEDES-BENZ	CLK350	
2006-2009	MERCEDES-BENZ	E350	
2006-2007	MERCEDES-BENZ	C230	
2006-2007	MERCEDES-BENZ	C280	
2006-2007	MERCEDES-BENZ	C350	
2007	MERCEDES-BENZ	E280	
<b>234-5092</b>			<b>D</b>
2011-2015	AUDI	Q7	
<b>234-5093</b>			<b>D</b>
2013-2015	AUDI	RS5	
2011-2012	AUDI	A8 QUATTRO	
<b>234-5094</b>			<b>D</b>
2011-2012	AUDI	A8 QUATTRO	
<b>234-5095</b>			<b>D</b>
2014	INFINITI	Q70	
2014	INFINITI	QX80	
2011-2013	INFINITI	M56	
2011-2013	INFINITI	QX56	
<b>234-5096</b>			<b>D</b>
2007-2008	DODGE	SPRINTER 2500	
2007-2008	DODGE	SPRINTER 3500	
2007-2008	FREIGHTLINER	SPRINTER 2500	
2007-2008	FREIGHTLINER	SPRINTER 3500	
2012-2015	MERCEDES-BENZ	SLK55 AMG	
2009-2015	MERCEDES-BENZ	G550	
2008-2015	MERCEDES-BENZ	C63 AMG	
2010-2013	MERCEDES-BENZ	S400	
2006-2013	MERCEDES-BENZ	R350	
2010-2012	MERCEDES-BENZ	C250	
2010-2012	MERCEDES-BENZ	GLK350	
2008-2012	MERCEDES-BENZ	C300	
2008-2012	MERCEDES-BENZ	GL550	
2007-2012	MERCEDES-BENZ	GL450	
2007-2012	MERCEDES-BENZ	SL550	
2009-2011	MERCEDES-BENZ	SLK300	
2008-2011	MERCEDES-BENZ	ML550	
2008-2011	MERCEDES-BENZ	S450	
2007-2011	MERCEDES-BENZ	CLS63 AMG	
2007-2011	MERCEDES-BENZ	CLS550	
2007-2011	MERCEDES-BENZ	E550	
2007-2011	MERCEDES-BENZ	ML63 AMG	
2007-2011	MERCEDES-BENZ	S550	
2006-2011	MERCEDES-BENZ	C350	
2006-2011	MERCEDES-BENZ	E350	
2006-2011	MERCEDES-BENZ	ML350	
2005-2011	MERCEDES-BENZ	SLK350	
2007-2010	MERCEDES-BENZ	CL550	
2010	MERCEDES-BENZ	GL350	
2010	MERCEDES-BENZ	ML450	

#PART PIECE PARTE	MFR / MARQUE FABRICANTE	MODEL MODELE MODELO	D
<b>234-5096 (CONT.)</b>			<b>D</b>
2008-2009	MERCEDES-BENZ	C230	
2007-2009	MERCEDES-BENZ	E63 AMG	
2007-2009	MERCEDES-BENZ	E320	
2007-2009	MERCEDES-BENZ	GL320	
2007-2008	MERCEDES-BENZ	ML320	
2007-2008	MERCEDES-BENZ	R320	
2006-2008	MERCEDES-BENZ	SLK280	
2008	MERCEDES-BENZ	R550	
2006-2007	MERCEDES-BENZ	C280	
2007	MERCEDES-BENZ	R63 AMG	
2005-2006	MERCEDES-BENZ	ML500	
2006	MERCEDES-BENZ	S350	
<b>234-5097</b>			<b>D</b>
2013-2015	FORD	ESCAPE	
2012-2015	FORD	EXPLORER	
2011-2015	FORD	F-250 SUPER DUTY	
2011-2015	FORD	F-350 SUPER DUTY	
2011-2015	FORD	FUSION	
2015	FORD	TRANSIT-150	
2015	FORD	TRANSIT-250	
2015	FORD	TRANSIT-350	
2013-2014	FORD	E-350 SUPER DUTY	
2013-2014	FORD	FOCUS	
2012-2014	FORD	EDGE	
2011-2014	FORD	MUSTANG	
2008-2014	FORD	TAURUS	
2009-2012	FORD	FLEX	
2010	FORD	EDGE	
2008-2009	FORD	TAURUS X	
2013-2015	LINCOLN	MKZ	
2015	LINCOLN	MKC	
2010-2014	LINCOLN	MKT	
2009-2012	LINCOLN	MKS	
2010-2011	LINCOLN	MKX	
2008-2009	MERCURY	SABLE	
<b>234-5098</b>			<b>D</b>
2010-2014	ACURA	TSX	
2009-2014	ACURA	TL	
2010-2013	ACURA	MDX	
2010-2013	ACURA	ZDX	
2011-2012	ACURA	RL	
2011-2013	HONDA	ODYSSEY	
2008-2012	HONDA	ACCORD	
2012	HONDA	CROSSTOUR	
2010-2011	HONDA	ACCORD CROSSTOUR	
2009-2011	HONDA	PILOT	
2009-2011	HONDA	RIDGELINE	
<b>234-5099</b>			<b>D</b>
2008-2010	HONDA	ACCORD	
<b>234-5102</b>			<b>D</b>
2015	AUDI	A8 QUATTRO	



#PART PIECE PARTE	MFR/ MARQUE FABRICANTE	MODEL MODELE MODELO
<b>234-5102 (CONT.)</b> D		
2008-2009	AUDI	TT QUATTRO
2006-2009	AUDI	A3 QUATTRO
2005-2009	AUDI	A4
2005-2009	AUDI	A4 QUATTRO
2015	BENTLEY	CONTINENTAL
2014-2015	PORSCHE	CAYMAN
2013-2015	PORSCHE	BOXSTER
2015	PORSCHE	918 SPYDER
2015	PORSCHE	CAYENNE
2015	PORSCHE	MACAN
2012-2015	VOLKSWAGEN	PASSAT
2012-2014	VOLKSWAGEN	BEETLE
2010-2014	VOLKSWAGEN	GOLF
2004-2014	VOLKSWAGEN	JETTA
2006-2009	VOLKSWAGEN	RABBIT
2007-2008	VOLKSWAGEN	EOS
2008	VOLKSWAGEN	R32
2004-2006	VOLKSWAGEN	BEETLE
2004-2006	VOLKSWAGEN	GOLF
2006	VOLKSWAGEN	PHAETON
2005	VOLKSWAGEN	TOUAREG
<b>234-5103</b> D		
2007-2009	AUDI	A8 QUATTRO
<b>234-5104</b> D		
2007	AUDI	S6
2008-2010	PORSCHE	CAYENNE
<b>234-5105</b> D		
2007	AUDI	S8
2006-2008	VOLKSWAGEN	TOUAREG
<b>234-5106</b> D		
2004-2006	AUDI	TT QUATTRO
<b>234-5107</b> D		
2009-2014	AUDI	TT QUATTRO
2009-2013	AUDI	A3 QUATTRO
2006-2013	AUDI	A3
2008-2009	AUDI	TT
2006-2008	PORSCHE	911
2009-2015	VOLKSWAGEN	CC
2007-2015	VOLKSWAGEN	EOS
2006-2014	VOLKSWAGEN	GTI
2012-2013	VOLKSWAGEN	GOLF
2009-2010	VOLKSWAGEN	PASSAT CC
2006-2010	VOLKSWAGEN	JETTA
2006-2010	VOLKSWAGEN	PASSAT
<b>234-5108</b> D		
2014-2015	AUDI	R8
2008-2012	AUDI	R8
2007	AUDI	S6
2009-2011	FORD	EXPEDITION
2009-2010	FORD	F-150
2009-2011	LINCOLN	NAVIGATOR

#PART PIECE PARTE	MFR/ MARQUE FABRICANTE	MODEL MODELE MODELO
<b>234-5108 (CONT.)</b> D		
2011-2015	PORSCHE	CAYENNE
2007-2013	PORSCHE	911
2006-2008	PORSCHE	CAYMAN
2005-2008	PORSCHE	BOXSTER
2006-2009	SAAB	9-3
2009-2015	VOLKSWAGEN	CC
2009-2010	VOLKSWAGEN	PASSAT CC
2006-2010	VOLKSWAGEN	PASSAT
2006	VOLKSWAGEN	PHAETON
<b>234-5110</b> D		
2008-2012	AUDI	S5
2007	AUDI	S6
2005-2007	CADILLAC	STS
2004-2007	CADILLAC	CTS
2004-2006	CADILLAC	SRX
<b>234-5113</b> D		
2014-2015	FORD	FIESTA
2014-2015	FORD	TRANSIT CONNECT
2013-2015	FORD	EXPLORER
2010-2015	FORD	FLEX
2010-2015	FORD	FUSION
2010-2015	FORD	TAURUS
2009-2015	FORD	F-150
2013-2014	FORD	POLICE INTERCEPTOR
2012-2014	FORD	FOCUS
2012-2014	FORD	MUSTANG
2009-2014	FORD	E-150 VAN
2009-2014	FORD	E-250 VAN
2009-2014	FORD	E-350 SUPER DUTY
2009-2014	FORD	EXPEDITION
2013	FORD	C-MAX
2009-2012	FORD	ESCAPE
2010-2015	LINCOLN	MKS
2010-2015	LINCOLN	MKT
2015	LINCOLN	MKC
2009-2014	LINCOLN	NAVIGATOR
2011-2012	LINCOLN	MKZ
2009-2010	MAZDA	TRIBUTE
2010-2011	MERCURY	MILAN
2009-2011	MERCURY	MARINER
<b>234-5114</b> D		
2014-2015	AUDI	R8
2008-2012	AUDI	R8
2007-2010	AUDI	A8 QUATTRO
2007-2008	AUDI	RS4
2007	AUDI	S8
2011-2015	VOLKSWAGEN	TOUAREG
<b>234-5115</b> D		
2004-2006	AUDI	A8 QUATTRO
2001-2006	AUDI	A4
2001-2006	AUDI	TT

#PART PIECE PARTE	MFR/ MARQUE FABRICANTE	MODEL MODELE MODELO
<b>234-5115 (CONT.)</b> D		
2001-2005	AUDI	A4 QUATTRO
2001-2002	AUDI	TT QUATTRO
2004-2007	VOLKSWAGEN	TOUAREG
2004-2006	VOLKSWAGEN	PHAETON
1999-2006	VOLKSWAGEN	GOLF
2001-2005	VOLKSWAGEN	PASSAT
1999-2005	VOLKSWAGEN	JETTA
2001-2004	VOLKSWAGEN	BEETLE
2001-2003	VOLKSWAGEN	EUROVAN
<b>234-5116</b> D		
2010-2013	AUDI	A3
2009-2015	VOLKSWAGEN	JETTA
2013-2014	VOLKSWAGEN	BEETLE
2010-2014	VOLKSWAGEN	GOLF
2006-2008	VOLKSWAGEN	BEETLE
2006-2008	VOLKSWAGEN	TOUAREG
2004-2005	VOLKSWAGEN	PASSAT
<b>234-5117</b> D		
2003-2005	MERCEDES-BENZ	C230
2003-2006	PORSCHE	CAYENNE
2004-2005	VOLKSWAGEN	PHAETON
<b>234-5118</b> D		
2007	AUDI	S6
2009-2015	VOLKSWAGEN	CC
2009-2010	VOLKSWAGEN	PASSAT CC
2006-2010	VOLKSWAGEN	PASSAT
<b>234-5119</b> D		
2008-2009	AUDI	A8 QUATTRO
2015	BENTLEY	CONTINENTAL
2010-2015	PORSCHE	PANAMERA
2011-2014	PORSCHE	CAYENNE
2008-2010	VOLKSWAGEN	BEETLE
2006	VOLKSWAGEN	PHAETON
<b>234-5120</b> D		
2008-2010	AUDI	A5 QUATTRO
2006-2009	AUDI	A6
2005-2009	AUDI	A4 QUATTRO
2009	AUDI	Q5
2006-2008	AUDI	A4
2005-2008	AUDI	A6 QUATTRO
<b>234-5125</b> D		
2007-2010	AUDI	Q7
2008-2009	AUDI	TT QUATTRO
2006-2009	AUDI	A3 QUATTRO
2008-2010	PORSCHE	CAYENNE
2007-2010	VOLKSWAGEN	TOUAREG
2007-2008	VOLKSWAGEN	EOS
2008	VOLKSWAGEN	R32
<b>234-5127</b> D		
2004-2005	VOLKSWAGEN	PHAETON



#PART PIECE PARTE	MFR / MARQUE FABRICANTE	MODEL MODELE MODELO	D
<b>234-5128</b>			
2006	VOLKSWAGEN	PHAETON	
<b>234-5129</b>			
2005-2011	AUDI	A6 QUATTRO	
2005-2007	AUDI	A8 QUATTRO	
2007	AUDI	S8	
2004-2006	VOLKSWAGEN	TOUAREG	
2002-2004	VOLKSWAGEN	PASSAT	
<b>234-5131</b>			
2007	AUDI	S8	
<b>234-5132</b>			
2004-2006	BMW	X5	
<b>234-5133</b>			
2007-2008	BMW	ALPINA B7	
2004-2006	BMW	760I	
2003-2006	BMW	760LI	
2004-2005	BMW	545I	
2004-2005	BMW	645CI	
2002-2005	BMW	745I	
2002-2005	BMW	745LI	
<b>234-5134</b>			
2004-2006	BMW	X5	
2003-2006	BMW	325CI	
2004-2005	BMW	545I	
2004-2005	BMW	645CI	
2003-2005	BMW	325I	
<b>234-5135</b>			
2008-2013	BMW	M3	
2006	BMW	323I	
2006	BMW	325I	
2006	BMW	325XI	
2006	BMW	330I	
2006	BMW	330XI	
2006	BMW	525I	
2006	BMW	525XI	
2006	BMW	530I	
2006	BMW	530XI	
2012-2014	MERCEDES-BENZ	ML350	
2010-2013	MERCEDES-BENZ	S400	
2013	MERCEDES-BENZ	G63 AMG	
2008-2011	MERCEDES-BENZ	S450	
2007-2011	MERCEDES-BENZ	S550	
2009-2010	MERCEDES-BENZ	CL550	
2010	MERCEDES-BENZ	ML350	
2007-2009	MERCEDES-BENZ	E320	
2009	MERCEDES-BENZ	ML320	
2009	MERCEDES-BENZ	R320	
2007-2010	MINI	COOPER	
<b>234-5136</b>			
2007-2010	BMW	X5	
2006-2010	BMW	550I	
2006-2010	BMW	650I	

#PART PIECE PARTE	MFR / MARQUE FABRICANTE	MODEL MODELE MODELO	D
<b>234-5136 (CONT.)</b>			
2007-2008	BMW	760LI	
2006-2008	BMW	750I	
2006-2008	BMW	750LI	
2015-2016	MERCEDES-BENZ	C300	
2009-2015	MERCEDES-BENZ	G550	
2010-2011	MERCEDES-BENZ	ML450	
2007-2012	MINI	COOPER	
2007-2015	ROLLS-ROYCE	PHANTOM	
<b>234-5137</b>			
2004-2006	BMW	X3	
2003-2006	BMW	325CI	
2003-2006	BMW	330CI	
2004-2005	BMW	525I	
2004-2005	BMW	530I	
2003-2005	BMW	325I	
2003-2005	BMW	330I	
<b>234-5138</b>			
2006-2015	BMW	Z4	
2011-2013	BMW	335IS	
2009-2013	BMW	328I XDRIVE	
2008-2013	BMW	128I	
2007-2013	BMW	328I	
2007-2012	BMW	X3	
2008-2011	BMW	528I	
2006-2011	BMW	323I	
2011	BMW	1 SERIES M	
2009-2010	BMW	335I XDRIVE	
2009-2010	BMW	528I XDRIVE	
2008-2010	BMW	135I	
2007-2010	BMW	335I	
2007-2010	BMW	X5	
2006-2010	BMW	550I	
2006-2010	BMW	650I	
2007-2008	BMW	328XI	
2007-2008	BMW	335XI	
2008	BMW	528XI	
2006-2007	BMW	525I	
2006-2007	BMW	525XI	
2006-2007	BMW	530I	
2006-2007	BMW	530XI	
2006	BMW	325I	
2006	BMW	325XI	
2006	BMW	330I	
2006	BMW	330XI	
<b>234-5139</b>			
2006-2015	BMW	Z4	
2011-2013	BMW	335IS	
2009-2013	BMW	328I XDRIVE	
2008-2013	BMW	128I	
2007-2013	BMW	328I	
2006-2011	BMW	323I	

#PART PIECE PARTE	MFR / MARQUE FABRICANTE	MODEL MODELE MODELO	D
<b>234-5139 (CONT.)</b>			
2011	BMW	1 SERIES M	
2009-2010	BMW	335I XDRIVE	
2009-2010	BMW	528I XDRIVE	
2008-2010	BMW	135I	
2008-2010	BMW	528I	
2007-2010	BMW	335I	
2007-2010	BMW	X3	
2007-2010	BMW	X5	
2007-2008	BMW	328XI	
2007-2008	BMW	335XI	
2008	BMW	528XI	
2006-2007	BMW	525I	
2006-2007	BMW	525XI	
2006-2007	BMW	530I	
2006-2007	BMW	530XI	
2006	BMW	325I	
2006	BMW	325XI	
2006	BMW	330I	
2006	BMW	330XI	
2007-2009	MERCEDES-BENZ	CLK63 AMG	
2005-2006	MERCEDES-BENZ	E320	
<b>234-5140</b>			
2009-2012	BMW	X5	
2009-2011	BMW	335D	
2006-2010	BMW	M5	
2006-2010	BMW	M6	
<b>234-5141</b>			
2012-2013	VOLKSWAGEN	BEETLE	
2012-2013	VOLKSWAGEN	JETTA	
<b>234-5142</b>			
2012-2013	VOLKSWAGEN	BEETLE	
2012-2013	VOLKSWAGEN	JETTA	
<b>234-5143</b>			
2015	AUDI	A3	
2012-2014	AUDI	A8 QUATTRO	
2015	BENTLEY	MULSANNE	
2015	VOLKSWAGEN	GOLF SPORTWAGEN	
<b>234-5144</b>			
2012-2014	AUDI	A8 QUATTRO	
<b>234-5145</b>			
2012-2014	AUDI	A8 QUATTRO	
2015	VOLKSWAGEN	BEETLE	
2015	VOLKSWAGEN	JETTA	
<b>234-5146</b>			
2012-2014	AUDI	A8 QUATTRO	
<b>234-5147</b>			
2013-2015	HYUNDAI	SANTA FE	
2011-2014	HYUNDAI	SONATA	
2011-2014	KIA	OPTIMA	
2011-2014	KIA	SPORTAGE	



#PART PIECE PARTE	MFR/ MARQUE FABRICANTE	MODEL MODELE MODELO
<b>234-5148</b> D		
2005-2007	AUDI	A8 QUATTRO
2004	VOLKSWAGEN	GOLF
<b>234-5150</b> D		
2015	CHRYSLER	200
2013-2015	DODGE	DART
2014-2015	JEEP	CHEROKEE
2015	JEEP	RENEGADE
2015	RAM	PROMASTER CITY
<b>234-5151</b> D		
2015	FORD	TRANSIT-150
2015	FORD	TRANSIT-250
2015	FORD	TRANSIT-350
2013	FORD	FUSION
2015	LINCOLN	MKS
<b>234-5152</b> D		
2016	ACURA	RLX
2014	ACURA	RLX
2013-2014	HONDA	ACCORD
<b>234-5153</b> D		
2014-2015	JAGUAR	F-TYPE
2013-2015	JAGUAR	XF
2013-2014	JAGUAR	XFR
2013-2014	JAGUAR	XFR-S
2013-2014	JAGUAR	XJ
2014	JAGUAR	XJR
2014	LAND ROVER	RANGE ROVER
<b>234-5154</b> D		
2013-2015	JAGUAR	XF
2013-2014	JAGUAR	XJ
<b>234-5155</b> D		
2013-2014	JAGUAR	XF
<b>234-5156</b> D		
2014-2015	LAND ROVER	LR4
2014-2015	LAND ROVER	RANGE ROVER SPORT
2013-2015	LAND ROVER	RANGE ROVER
<b>234-5157</b> D		
2014-2015	MERCEDES-BENZ	E250
2013-2015	MERCEDES-BENZ	GLK250
2015	MERCEDES-BENZ	ML250
2012-2013	MERCEDES-BENZ	S350
<b>234-5158</b> D		
2014-2015	MERCEDES-BENZ	CLA45 AMG
2014-2015	MERCEDES-BENZ	CLA250
2014-2015	MERCEDES-BENZ	CLS63 AMG S
2014-2015	MERCEDES-BENZ	CLS550
2014-2015	MERCEDES-BENZ	E550
2014-2015	MERCEDES-BENZ	G63 AMG
2014-2015	MERCEDES-BENZ	S63 AMG
2014-2015	MERCEDES-BENZ	SLK350
2013-2015	MERCEDES-BENZ	B250
2013-2015	MERCEDES-BENZ	C350

#PART PIECE PARTE	MFR/ MARQUE FABRICANTE	MODEL MODELE MODELO
<b>234-5158 (CONT.)</b> D		
2013-2015	MERCEDES-BENZ	E350
2013-2015	MERCEDES-BENZ	E400
2013-2015	MERCEDES-BENZ	GL63 AMG
2013-2015	MERCEDES-BENZ	GL450
2013-2015	MERCEDES-BENZ	GL550
2013-2015	MERCEDES-BENZ	S550
2013-2015	MERCEDES-BENZ	SL63 AMG
2013-2015	MERCEDES-BENZ	SL550
2012-2015	MERCEDES-BENZ	ML63 AMG
2015	MERCEDES-BENZ	C400
2015	MERCEDES-BENZ	E63 AMG
2015	MERCEDES-BENZ	E63 AMG S
2015	MERCEDES-BENZ	GLA45 AMG
2015	MERCEDES-BENZ	GLA250
2015	MERCEDES-BENZ	GLK350
2015	MERCEDES-BENZ	ML350
2015	MERCEDES-BENZ	ML400
2015	MERCEDES-BENZ	SL400
2012-2014	MERCEDES-BENZ	ML550
2014	MERCEDES-BENZ	CLS63 AMG
2013	MERCEDES-BENZ	C300
2013	MERCEDES-BENZ	GLK350
<b>234-5159</b> D		
2013	PORSCHE	CAYENNE
<b>234-5160</b> D		
2013-2014	AUDI	A8 QUATTRO
<b>234-5161</b> D		
2014-2015	AUDI	RS7
2013-2015	AUDI	A8 QUATTRO
2013-2015	AUDI	S6
2013-2015	AUDI	S7
2013-2015	AUDI	S8
<b>234-5162</b> D		
2014-2015	AUDI	RS7
2013-2015	AUDI	A8 QUATTRO
2013-2015	AUDI	S6
2013-2015	AUDI	S7
2013-2015	AUDI	S8
2015	BENTLEY	CONTINENTAL
2014-2015	VOLKSWAGEN	BEETLE
2015	VOLKSWAGEN	JETTA
2015	VOLKSWAGEN	PASSAT
<b>234-5163</b> D		
2013-2015	AUDI	Q5
2015	BENTLEY	CONTINENTAL
2014	VOLKSWAGEN	BEETLE
2014	VOLKSWAGEN	JETTA
2014	VOLKSWAGEN	PASSAT
<b>234-5164</b> D		
2014-2015	AUDI	SQ5
2012-2015	AUDI	A7 QUATTRO

#PART PIECE PARTE	MFR/ MARQUE FABRICANTE	MODEL MODELE MODELO
<b>234-5164 (CONT.)</b> D		
2011-2015	AUDI	Q7
2010-2015	AUDI	S4
2010-2015	AUDI	S5
2009-2015	AUDI	A6 QUATTRO
2009-2015	AUDI	Q5
2010-2011	AUDI	A6
2008-2010	AUDI	A5 QUATTRO
2009	AUDI	A4 QUATTRO
<b>234-5165</b> D		
2015	BMW	M3
2015	BMW	M4
<b>234-5166</b> D		
2014-2015	MINI	COOPER
<b>234-5167</b> D		
2014-2015	BMW	I8
<b>234-5168</b> D		
2014-2015	BMW	I3
<b>234-5169</b> D		
2015	CHEVROLET	CRUZE
<b>234-5170</b> D		
2014-2015	RAM	1500
2014	RAM	PROMASTER 1500
2014	RAM	PROMASTER 2500
2014	RAM	PROMASTER 3500
<b>234-5171</b> D		
2014-2015	FIAT	500L
<b>234-5172</b> D		
2014-2015	FORD	FUSION
<b>234-5173</b> D		
2015	FORD	F-150
2015	FORD	MUSTANG
<b>234-5174</b> D		
2015	FORD	F-150
<b>234-5175</b> D		
2015	FORD	MUSTANG
<b>234-5176</b> D		
2014-2015	FORD	ESCAPE
2014-2015	FORD	FUSION
2014-2015	FORD	TRANSIT CONNECT
2015	FORD	F-150
2015	FORD	MUSTANG
<b>234-5177</b> D		
2015	FORD	F-150
<b>234-5178</b> D		
2014-2015	SUBARU	FORESTER
2015	SUBARU	WRX
<b>234-5180</b> D		
2014-2015	MITSUBISHI	OUTLANDER
2014-2015	MITSUBISHI	OUTLANDER SPORT
2015	MITSUBISHI	RVR



#PART PIECE PARTE	MFR / MARQUE FABRICANTE	MODEL MODELE MODELO
<b>234-5181</b> D		
2014-2015	MITSUBISHI	MIRAGE
<b>234-5182</b> D		
2014-2015	MITSUBISHI	OUTLANDER
<b>234-5183</b> D		
2015	AUDI	A8 QUATTRO
<b>234-5184</b> D		
2013-2014	VOLKSWAGEN	BEETLE
2013-2014	VOLKSWAGEN	JETTA
<b>234-5185</b> D		
2015	AUDI	A3 QUATTRO
2015	AUDI	S3
2015	VOLKSWAGEN	GOLF
2015	VOLKSWAGEN	GTI
<b>234-5430</b> C		
2003-2009	HYUNDAI	ELANTRA
2005-2009	KIA	SPECTRA5
2004-2009	KIA	SPECTRA
<b>234-5700</b> D		
2001-2009	VOLVO	S60
2003-2007	VOLVO	XC70
2000-2007	VOLVO	V70
2004-2006	VOLVO	S80
2003-2006	VOLVO	XC90
2000-2004	VOLVO	C70
2000	VOLVO	S70
<b>234-5701</b> D		
2003-2005	VOLVO	XC90
2002-2005	VOLVO	S80
<b>234-5702</b> D		
2007-2013	VOLVO	C30
2006-2013	VOLVO	C70
2012	VOLVO	S60
2005-2011	VOLVO	V50
2004-2011	VOLVO	S40
2000-2001	VOLVO	S80
1999	VOLVO	C70
1999	VOLVO	S70
1999	VOLVO	V70
<b>234-5703</b> D		
2003-2005	VOLVO	XC90
1999-2005	VOLVO	S80
<b>234-5705</b> D		
2000-2001	VOLVO	S80
<b>234-9001</b> A		
2000-2004	TOYOTA	TACOMA
2000-2004	TOYOTA	TUNDRA
2000	TOYOTA	4RUNNER
<b>234-9002</b> A		
2000-2003	TOYOTA	TACOMA
1999-2002	TOYOTA	4RUNNER

#PART PIECE PARTE	MFR / MARQUE FABRICANTE	MODEL MODELE MODELO
<b>234-9003</b> B		
2000-2004	TOYOTA	TACOMA
2000-2004	TOYOTA	TUNDRA
1999-2000	TOYOTA	4RUNNER
<b>234-9004</b> C		
2002-2004	ACURA	RSX
2002-2005	HONDA	CIVIC
<b>234-9005</b> A		
2002-2004	ACURA	RSX
2001-2005	HONDA	CIVIC
2002-2004	HONDA	CR-V
<b>234-9006</b> D		
2002-2004	ACURA	RSX
<b>234-9007</b> A		
1998-1999	LEXUS	ES300
1999-2000	TOYOTA	SIENNA
1999-2000	TOYOTA	SOLARA
1998-2000	TOYOTA	CAMRY
1998-2000	TOYOTA	RAV4
1997-1999	TOYOTA	AVALON
<b>234-9008</b> D		
2008-2011	LEXUS	ES350
2007-2009	LEXUS	RX350
2009-2010	PONTIAC	VIBE
2009-2013	TOYOTA	MATRIX
2009-2012	TOYOTA	COROLLA
2009-2011	TOYOTA	VENZA
2008-2011	TOYOTA	AVALON
2008-2011	TOYOTA	CAMRY
2011	TOYOTA	SIENNA
2008-2010	TOYOTA	HIGHLANDER
<b>234-9009</b> A		
1999-2003	LEXUS	RX300
1998-1999	LEXUS	ES300
2001-2003	TOYOTA	HIGHLANDER
1999-2000	TOYOTA	SIENNA
1999-2000	TOYOTA	SOLARA
1998-2000	TOYOTA	CAMRY
1997-1999	TOYOTA	AVALON
<b>234-9010</b> A		
2001-2004	SUBARU	OUTBACK
2000-2003	TOYOTA	CAMRY
2000-2003	TOYOTA	SOLARA
<b>234-9011</b> B		
2005	SAAB	9-2X
2002-2005	SUBARU	IMPREZA
<b>234-9012</b> D		
2004-2010	TOYOTA	SIENNA
<b>234-9013</b> D		
2001-2006	HONDA	INSIGHT
<b>234-9014</b> A		
2000-2002	HONDA	ACCORD

#PART PIECE PARTE	MFR / MARQUE FABRICANTE	MODEL MODELE MODELO
<b>234-9015</b> A		
2003-2006	SUBARU	BAJA
2003-2004	SUBARU	FORESTER
2003-2004	SUBARU	IMPREZA
2003-2004	SUBARU	LEGACY
2003-2004	SUBARU	OUTBACK
<b>234-9016</b> D		
1999-2003	JAGUAR	VANDEN PLAS
1999-2003	JAGUAR	XJ8
1999-2003	JAGUAR	XJR
2000-2002	JAGUAR	XK8
2000-2002	JAGUAR	XKR
<b>234-9017</b> A		
2004-2005	ACURA	EL
2004-2005	HONDA	CIVIC
<b>234-9018</b> A		
2000-2001	SUBARU	OUTBACK
1999-2001	SUBARU	IMPREZA
1999-2001	SUBARU	LEGACY
<b>234-9019</b> C		
2001-2002	VOLVO	S60
2001-2002	VOLVO	V70
<b>234-9020</b> C		
1999-2000	VOLVO	S70
1999-2000	VOLVO	V70
<b>234-9021</b> A		
2000-2001	LEXUS	ES300
2000-2004	TOYOTA	AVALON
2001-2003	TOYOTA	SIENNA
2001-2003	TOYOTA	SOLARA
2001	TOYOTA	CAMRY
<b>234-9022</b> D		
2008-2011	LEXUS	ES350
2010	LEXUS	RX450H
2007-2009	LEXUS	RX350
2011-2012	TOYOTA	TACOMA
2006-2012	TOYOTA	RAV4
2009-2011	TOYOTA	VENZA
2008-2011	TOYOTA	AVALON
2008-2011	TOYOTA	CAMRY
2011	TOYOTA	SIENNA
2008-2010	TOYOTA	HIGHLANDER
2010	TOYOTA	4RUNNER
<b>234-9023</b> A		
2001-2003	TOYOTA	RAV4
<b>234-9024</b> A		
1997-1999	TOYOTA	CAMRY
1999	TOYOTA	SOLARA
<b>234-9025</b> A		
1998-2000	HONDA	ACCORD
<b>234-9026</b> D		
2010-2013	LEXUS	GX460



#PART PIECE PARTE	MFR/ MARQUE FABRICANTE	MODEL MODELE MODELO	
<b>234-9026 (CONT.)</b>			<b>D</b>
2008-2011	LEXUS	LX570	
2005-2013	TOYOTA	TUNDRA	
2008-2012	TOYOTA	SEQUOIA	
2008-2011	TOYOTA	LAND CRUISER	
2008-2009	TOYOTA	FJ CRUISER	
2007-2009	TOYOTA	4RUNNER	
2005-2008	TOYOTA	TACOMA	
<b>234-9027</b>			<b>D</b>
2008-2012	LAND ROVER	LR2	
<b>234-9028</b>			<b>A</b>
2001-2003	TOYOTA	RAV4	
<b>234-9029</b>			<b>C</b>
2002-2008	JAGUAR	X-TYPE	
2003-2005	JAGUAR	XK8	
2003-2005	JAGUAR	XKR	
<b>234-9030</b>			<b>C</b>
2004-2005	JAGUAR	VANDEN PLAS	
2004-2005	JAGUAR	XJ8	
2004-2005	JAGUAR	XJR	
2003-2005	JAGUAR	S-TYPE	
2005	JAGUAR	SUPER V8	
<b>234-9031</b>			<b>D</b>
2007-2008	SUZUKI	GRAND VITARA	
<b>234-9032</b>			<b>D</b>
2006	SUZUKI	GRAND VITARA	
<b>234-9033</b>			<b>D</b>
2007-2009	SUZUKI	SX4	
<b>234-9034</b>			<b>D</b>
2013-2015	SUBARU	WRX STI	
2008-2014	SUBARU	IMPREZA	
<b>234-9035</b>			<b>D</b>
2009-2010	SUBARU	IMPREZA	
2008-2009	SUBARU	LEGACY	
2008-2009	SUBARU	OUTBACK	
<b>234-9036</b>			<b>D</b>
2009-2011	INFINITI	FX35	
2011	INFINITI	M37	
2009-2010	INFINITI	G37	
2009-2010	INFINITI	M35	
2008-2010	INFINITI	EX35	
2008	INFINITI	G35	
2014-2015	NISSAN	ROGUE SELECT	
2010-2013	NISSAN	ALTIMA	
2010-2013	NISSAN	MAXIMA	
2010-2013	NISSAN	ROGUE	
2011-2012	NISSAN	FRONTIER	
2011-2012	NISSAN	PATHFINDER	
2011-2012	NISSAN	XTERRA	
2009-2010	NISSAN	370Z	
2008-2009	NISSAN	350Z	
2011-2012	SUZUKI	EQUATOR	

#PART PIECE PARTE	MFR/ MARQUE FABRICANTE	MODEL MODELE MODELO	
<b>234-9037</b>			<b>D</b>
2008	INFINITI	G37	
2009-2010	NISSAN	MURANO	
<b>234-9038</b>			<b>D</b>
2008-2010	INFINITI	QX56	
2008-2013	NISSAN	ARMADA	
2008-2012	NISSAN	FRONTIER	
2008-2012	NISSAN	PATHFINDER	
2008-2012	NISSAN	TITAN	
2008-2011	NISSAN	ALTIMA	
2008-2010	NISSAN	XTERRA	
2010	NISSAN	ROGUE	
2009	NISSAN	MAXIMA	
2009-2012	SUZUKI	EQUATOR	
<b>234-9039</b>			<b>D</b>
2008-2012	NISSAN	SENTRA	
2008-2009	NISSAN	ALTIMA	
2008-2009	NISSAN	VERSA	
2009	NISSAN	CUBE	
2009	NISSAN	MAXIMA	
<b>234-9040</b>			<b>A</b>
2003-2007	HONDA	ACCORD	
<b>234-9041</b>			<b>A</b>
2010-2011	LEXUS	RX350	
2010	LEXUS	RX450H	
2007	LEXUS	ES350	
2007	LEXUS	RX350	
2008-2010	SCION	XB	
2005-2010	SCION	TC	
2003-2011	TOYOTA	CAMRY	
2004-2008	TOYOTA	RAV4	
2005-2007	TOYOTA	AVALON	
2004-2007	TOYOTA	SOLARA	
2001-2003	TOYOTA	HIGHLANDER	
<b>234-9042</b>			<b>A</b>
2010-2011	LEXUS	RX350	
2006-2007	LEXUS	RX400H	
2007	LEXUS	RX350	
2004-2006	LEXUS	ES330	
2004-2006	LEXUS	RX330	
2002-2003	LEXUS	ES300	
2004-2008	TOYOTA	SOLARA	
2004-2007	TOYOTA	HIGHLANDER	
2004-2006	TOYOTA	SIENNA	
2002-2006	TOYOTA	CAMRY	
<b>234-9047</b>			<b>A</b>
2002-2003	LEXUS	ES300	
2008-2009	SUBARU	LEGACY	
2008-2009	SUBARU	TRIBECA	
2005-2009	SUBARU	OUTBACK	
2006-2007	SUBARU	B9 TRIBECA	
2002-2006	TOYOTA	CAMRY	

#PART PIECE PARTE	MFR/ MARQUE FABRICANTE	MODEL MODELE MODELO	
<b>234-9047 (CONT.)</b>			<b>A</b>
2003-2004	TOYOTA	4RUNNER	
<b>234-9048</b>			<b>D</b>
2010-2013	LEXUS	LS460	
2010-2012	LEXUS	HS250H	
2008-2012	LEXUS	IS350	
2008-2012	LEXUS	IS F	
2008-2011	LEXUS	GS350	
2008-2011	LEXUS	GS460	
2008-2011	LEXUS	IS250	
<b>234-9049</b>			<b>D</b>
2011-2015	SCION	XB	
2006-2012	TOYOTA	RAV4	
2007-2010	TOYOTA	SIENNA	
2008-2009	TOYOTA	CAMRY	
2008	TOYOTA	SOLARA	
<b>234-9050</b>			<b>C</b>
2007	LEXUS	ES350	
2005-2012	TOYOTA	TACOMA	
2005-2007	TOYOTA	AVALON	
2007	TOYOTA	CAMRY	
<b>234-9051</b>			<b>B</b>
2009-2013	LEXUS	LS460	
2008-2012	LEXUS	LS600H	
2007-2011	LEXUS	GS450H	
2005-2009	LEXUS	GX470	
2007-2008	LEXUS	GS350	
2006-2008	LEXUS	IS250	
2006-2008	LEXUS	IS350	
2005-2007	LEXUS	LX470	
2006	LEXUS	GS300	
2005-2009	TOYOTA	4RUNNER	
2005-2007	TOYOTA	LAND CRUISER	
2005-2007	TOYOTA	SEQUOIA	
2007	TOYOTA	FJ CRUISER	
2005-2006	TOYOTA	TUNDRA	
<b>234-9052</b>			<b>A</b>
2007-2009	LEXUS	LS460	
2005-2008	PONTIAC	VIBE	
2006-2014	TOYOTA	YARIS	
2005-2008	TOYOTA	COROLLA	
2005-2008	TOYOTA	MATRIX	
<b>234-9054</b>			<b>D</b>
2004-2007	TOYOTA	HIGHLANDER	
<b>234-9056</b>			<b>D</b>
2008-2009	SCION	XD	
2009-2010	TOYOTA	COROLLA	
2009-2010	TOYOTA	MATRIX	
2004-2009	TOYOTA	PRIUS	
<b>234-9057</b>			<b>D</b>
2004-2006	LEXUS	ES330	
2004-2008	TOYOTA	SOLARA	



#PART PIECE PARTE	MFR / MARQUE FABRICANTE	MODEL MODELE MODELO	
<b>234-9057 (CONT.)</b>			<b>D</b>
2004-2006	TOYOTA	CAMRY	
<b>234-9058</b>			<b>D</b>
2013-2014	LEXUS	IS F	
2007-2011	LEXUS	GS450H	
2007-2009	LEXUS	LS460	
2007-2008	LEXUS	GS350	
2006-2008	LEXUS	IS250	
2006	LEXUS	GS300	
2001-2003	TOYOTA	HIGHLANDER	
<b>234-9059</b>			<b>D</b>
2009-2011	MAZDA	RX-8	
<b>234-9060</b>			<b>D</b>
2007-2008	HONDA	FIT	
<b>234-9061</b>			<b>D</b>
2007-2012	ACURA	RDX	
<b>234-9062</b>			<b>C</b>
2007-2009	HONDA	CR-V	
<b>234-9063</b>			<b>D</b>
2006-2011	HONDA	CIVIC	
<b>234-9064</b>			<b>A</b>
2005-2006	ACURA	RSX	
2003-2011	HONDA	ELEMENT	
2005-2006	HONDA	CR-V	
<b>234-9065</b>			<b>D</b>
2005-2006	ACURA	RSX	
2006-2009	HONDA	S2000	
<b>234-9066</b>			<b>D</b>
2004-2008	ACURA	TSX	
<b>234-9067</b>			<b>D</b>
2011-2012	LEXUS	IS250	
2008	LEXUS	RX400H	
2009-2011	TOYOTA	TACOMA	
2008-2010	TOYOTA	HIGHLANDER	
<b>234-9068</b>			<b>D</b>
2013-2015	LEXUS	LS600H	
2008-2012	LEXUS	IS250	
2008-2012	LEXUS	IS350	
2008-2011	LEXUS	GS350	
2008-2011	LEXUS	GS460	
2008	LEXUS	RX400H	
2008-2010	TOYOTA	HIGHLANDER	
<b>234-9069</b>			<b>D</b>
2006-2011	HONDA	CIVIC	
<b>234-9070</b>			<b>C</b>
2007	NISSAN	ALTIMA	
2007	NISSAN	SENTRA	
2007	NISSAN	VERSA	
<b>234-9071</b>			<b>D</b>
2009-2015	NISSAN	GT-R	
2008-2009	NISSAN	ROGUE	
2007-2009	NISSAN	ALTIMA	

#PART PIECE PARTE	MFR / MARQUE FABRICANTE	MODEL MODELE MODELO	
<b>234-9072</b>			<b>D</b>
2007	INFINITI	G35	
2007	INFINITI	QX56	
2007	NISSAN	350Z	
2007	NISSAN	ALTIMA	
2007	NISSAN	ARMADA	
2007	NISSAN	FRONTIER	
2007	NISSAN	PATHFINDER	
2007	NISSAN	TITAN	
2007	NISSAN	XTERRA	
<b>234-9073</b>			<b>C</b>
2008-2009	NISSAN	ROGUE	
2007-2009	NISSAN	ALTIMA	
<b>234-9074</b>			<b>D</b>
2006-2009	LAND ROVER	RANGE ROVER	
<b>234-9075</b>			<b>D</b>
2006-2009	LAND ROVER	RANGE ROVER SPORT	
2005-2009	LAND ROVER	LR3	
<b>234-9076</b>			<b>D</b>
2006-2011	ACURA	CSX	
2006-2011	HONDA	CIVIC	
<b>234-9077</b>			<b>D</b>
2009-2010	HONDA	FIT	
<b>234-9078</b>			<b>D</b>
2010	HONDA	INSIGHT	
<b>234-9079</b>			<b>D</b>
2009-2012	INFINITI	FX50	
<b>234-9080</b>			<b>D</b>
2009-2015	NISSAN	GT-R	
<b>234-9081</b>			<b>D</b>
2009-2010	NISSAN	MURANO	
<b>234-9082</b>			<b>D</b>
2011-2014	NISSAN	CUBE	
2009-2012	NISSAN	SENTRA	
<b>234-9083</b>			<b>D</b>
2009-2011	NISSAN	VERSA	
<b>234-9084</b>			<b>D</b>
2009-2011	TOYOTA	TACOMA	
<b>234-9085</b>			<b>D</b>
2004-2009	MAZDA	3	
<b>234-9086</b>			<b>D</b>
2005	MAZDA	6	
<b>234-9087</b>			<b>D</b>
2006-2008	MAZDA	6	
<b>234-9088</b>			<b>D</b>
2006-2008	MAZDA	MX-5 MIATA	
<b>234-9089</b>			<b>D</b>
2009-2012	TOYOTA	VENZA	
2010-2011	TOYOTA	CAMRY	
<b>234-9090</b>			<b>D</b>
2015-2016	LEXUS	CT200H	
2009-2010	PONTIAC	VIBE	

#PART PIECE PARTE	MFR / MARQUE FABRICANTE	MODEL MODELE MODELO	
<b>234-9090 (CONT.)</b>			<b>D</b>
2015-2016	TOYOTA	PRIUS V	
2015	TOYOTA	PRIUS	
2011-2013	TOYOTA	COROLLA	
2010	TOYOTA	PRIUS	
<b>234-9091</b>			<b>D</b>
2009-2014	ACURA	TSX	
2008-2012	HONDA	ACCORD	
2010-2011	HONDA	CR-V	
<b>234-9092</b>			<b>D</b>
2010-2014	SUBARU	LEGACY	
2010-2014	SUBARU	OUTBACK	
2010-2014	SUBARU	TRIBECA	
2009-2013	TOYOTA	HIGHLANDER	
<b>234-9093</b>			<b>D</b>
2009-2015	MAZDA	MX-5 MIATA	
<b>234-9094</b>			<b>D</b>
2012-2015	JAGUAR	XKR-S	
2010-2015	JAGUAR	XK	
2010-2015	JAGUAR	XKR	
2010-2013	JAGUAR	XJ	
2011-2012	JAGUAR	XF	
2011-2012	JAGUAR	XFR	
<b>234-9095</b>			<b>D</b>
2010-2013	LAND ROVER	LR4	
2010-2013	LAND ROVER	RANGE ROVER SPORT	
2010-2012	LAND ROVER	RANGE ROVER	
<b>234-9096</b>			<b>D</b>
2010-2013	NISSAN	ALTIMA	
2010-2013	NISSAN	MAXIMA	
2010-2012	NISSAN	SENTRA	
2010-2012	NISSAN	VERSA	
2010	NISSAN	CUBE	
<b>234-9097</b>			<b>D</b>
2010-2012	SUBARU	LEGACY	
2010-2012	SUBARU	OUTBACK	
<b>234-9098</b>			<b>D</b>
2010-2012	SUBARU	LEGACY	
<b>234-9099</b>			<b>D</b>
2010-2013	SUZUKI	KIZASHI	
2010-2013	SUZUKI	SX4	
2012	SUZUKI	SX4 CROSSOVER	
<b>234-9100</b>			<b>D</b>
2010-2013	LEXUS	LS460	
<b>234-9101</b>			<b>D</b>
2010-2012	TOYOTA	4RUNNER	
2010-2012	TOYOTA	FJ CRUISER	
<b>234-9102</b>			<b>D</b>
2004-2008	MAZDA	RX-8	
<b>234-9103</b>			<b>D</b>
2011-2014	MAZDA	2	





#PART PIECE PARTE	MFR/ MARQUE FABRICANTE	MODEL MODELE MODELO	
<b>234-9104</b>			<b>D</b>
2011-2012	INFINITI	G25	
2012-2014	NISSAN	NV2500	
2012-2014	NISSAN	NV3500	
<b>234-9105</b>			<b>D</b>
2011-2015	NISSAN	JUKE	
<b>234-9106</b>			<b>D</b>
2011-2014	NISSAN	CUBE	
2011-2014	NISSAN	MURANO	
2014	NISSAN	MAXIMA	
2011-2013	NISSAN	QUEST	
<b>234-9107</b>			<b>D</b>
2011-2013	NISSAN	ALTIMA	
<b>234-9108</b>			<b>D</b>
2013-2014	SUBARU	WRX	
2010-2014	SUBARU	IMPREZA	
2011-2013	SUBARU	FORESTER	
<b>234-9109</b>			<b>D</b>
2013-2014	SUBARU	XV CROSSTREK	
2012-2014	SUBARU	IMPREZA	
2011-2013	SUBARU	FORESTER	
<b>234-9111</b>			<b>D</b>
2013	LEXUS	LX570	
2012-2015	TOYOTA	SEQUOIA	
2011-2015	TOYOTA	TUNDRA	
2012-2014	TOYOTA	TACOMA	
2013	TOYOTA	LAND CRUISER	
<b>234-9112</b>			<b>D</b>
2011-2014	LEXUS	CT200H	
2012-2015	SCION	IQ	
2010-2014	SCION	XD	
2012-2014	TOYOTA	PRIUS V	
2011-2014	TOYOTA	MATRIX	
2011-2014	TOYOTA	PRIUS	
2011-2013	TOYOTA	COROLLA	
<b>234-9113</b>			<b>D</b>
2011-2013	TOYOTA	SIENNA	
<b>234-9114</b>			<b>D</b>
2011-2015	LEXUS	RX450H	
2011-2014	LEXUS	RX350	
2011-2016	SCION	TC	
2013-2016	TOYOTA	RAV4	
2011-2016	TOYOTA	HIGHLANDER	
2012-2014	TOYOTA	SIENNA	
2012-2014	TOYOTA	VENZA	
<b>234-9115</b>			<b>D</b>
2011-2015	LEXUS	RX450H	
2011-2014	LEXUS	RX350	
2011-2016	TOYOTA	HIGHLANDER	
<b>234-9116</b>			<b>D</b>
2011	HONDA	CR-Z	

#PART PIECE PARTE	MFR/ MARQUE FABRICANTE	MODEL MODELE MODELO	
<b>234-9117</b>			<b>D</b>
2013-2014	ACURA	ILX	
2012-2015	HONDA	CIVIC	
2012-2015	HONDA	CR-Z	
2011-2014	HONDA	FIT	
2011-2014	HONDA	INSIGHT	
<b>234-9118</b>			<b>D</b>
2013-2015	ACURA	ILX	
2012-2015	HONDA	CIVIC	
2012-2015	HONDA	CROSSTOUR	
2012-2014	HONDA	CR-V	
<b>234-9119</b>			<b>D</b>
2013-2015	ACURA	ILX	
2016	HONDA	HR-V	
2014-2015	HONDA	ACCORD	
2012-2015	HONDA	CIVIC	
<b>234-9120</b>			<b>C</b>
2006	SAAB	9-2X	
2004-2010	SUBARU	FORESTER	
2004-2008	SUBARU	IMPREZA	
2005-2007	SUBARU	LEGACY	
2005-2007	SUBARU	OUTBACK	
<b>234-9121</b>			<b>D</b>
2004-2006	SUBARU	BAJA	
<b>234-9122</b>			<b>B</b>
2005	SAAB	9-2X	
2004-2005	SUBARU	LEGACY	
2004-2005	SUBARU	OUTBACK	
2005	SUBARU	FORESTER	
2005	SUBARU	IMPREZA	
<b>234-9123</b>			<b>C</b>
2006	SAAB	9-2X	
2006-2011	SUBARU	IMPREZA	
2006-2010	SUBARU	FORESTER	
2006-2009	SUBARU	LEGACY	
2006-2009	SUBARU	OUTBACK	
<b>234-9124</b>			<b>D</b>
2007-2011	HONDA	CIVIC	
<b>234-9125</b>			<b>D</b>
2010-2011	JAGUAR	XFR	
2009-2011	JAGUAR	XF	
2007-2009	JAGUAR	XK	
2006-2009	JAGUAR	SUPER V8	
2006-2009	JAGUAR	VANDEN PLAS	
2006-2009	JAGUAR	XJ8	
2006-2009	JAGUAR	XJR	
2006-2009	JAGUAR	XKR	
2006-2008	JAGUAR	S-TYPE	
2006	JAGUAR	XK8	
<b>234-9126</b>			<b>D</b>
2006	HONDA	CIVIC	

#PART PIECE PARTE	MFR/ MARQUE FABRICANTE	MODEL MODELE MODELO	
<b>234-9127</b>			<b>D</b>
2014-2015	NISSAN	VERSA NOTE	
2013-2015	NISSAN	FRONTIER	
2012-2015	NISSAN	VERSA	
2015	NISSAN	MICRA	
2014	NISSAN	PATHFINDER	
<b>234-9128</b>			<b>D</b>
2013-2016	LEXUS	ES300H	
2012-2014	LEXUS	ES350	
2012-2016	TOYOTA	AVALON	
2012-2016	TOYOTA	CAMRY	
2012-2016	TOYOTA	VENZA	
2013-2015	TOYOTA	TACOMA	
2012-2014	TOYOTA	SIENNA	
2013	TOYOTA	HIGHLANDER	
<b>234-9129</b>			<b>D</b>
2013-2014	LEXUS	GS450H	
2013	LEXUS	GS350	
2013	LEXUS	IS250	
2013	LEXUS	IS350	
2012-2016	TOYOTA	YARIS	
<b>234-9130</b>			<b>D</b>
2012-2016	TOYOTA	PRIUS C	
<b>234-9131</b>			<b>D</b>
2016	ACURA	ILX	
2015	ACURA	TLX	
2013-2015	HONDA	ACCORD	
2015	HONDA	CIVIC	
2015	HONDA	CR-V	
<b>234-9132</b>			<b>D</b>
2015	INFINITI	Q70	
2015	INFINITI	Q70L	
2013-2015	NISSAN	SENTRA	
<b>234-9133</b>			<b>D</b>
2013-2015	NISSAN	ALTIMA	
<b>234-9134</b>			<b>D</b>
2013-2015	NISSAN	ALTIMA	
<b>234-9135</b>			<b>D</b>
2014	INFINITI	Q60	
2014	INFINITI	QX50	
2014	INFINITI	QX60	
2014	INFINITI	QX70	
2012-2013	INFINITI	M35H	
2011-2013	INFINITI	G37	
2011-2013	INFINITI	M37	
2013	INFINITI	EX37	
2013	INFINITI	FX37	
2013	INFINITI	FX50	
2013	INFINITI	JX35	
2011-2012	INFINITI	EX35	
2011-2012	INFINITI	FX35	
2014-2015	NISSAN	ARMADA	



#PART PIECE PARTE	MFR / MARQUE FABRICANTE	MODEL MODELE MODELO	D
<b>234-9135 (CONT.)</b>			<b>D</b>
2013-2015	NISSAN	NV200	
2013-2015	NISSAN	SENTRA	
2013-2015	NISSAN	TITAN	
2013-2014	NISSAN	ALTIMA	
2013-2014	NISSAN	FRONTIER	
2013-2014	NISSAN	PATHFINDER	
2013-2014	NISSAN	XTERRA	
2012-2014	NISSAN	NV1500	
2012-2014	NISSAN	NV2500	
2012-2014	NISSAN	NV3500	
2011-2014	NISSAN	370Z	
2011-2014	NISSAN	MURANO	
2011-2014	NISSAN	QUEST	
2014	NISSAN	MAXIMA	
<b>234-9136</b>			<b>D</b>
2013-2016	SCION	FR-S	
2013-2015	SUBARU	BRZ	
2013-2014	SUBARU	LEGACY	
2013-2014	SUBARU	OUTBACK	
<b>234-9137</b>			<b>D</b>
2015	VOLVO	XC60	
2013-2014	VOLVO	S60	
<b>234-9138</b>			<b>D</b>
2014-2015	SUBARU	FORESTER	
2014-2015	SUBARU	XV CROSSTREK	
2015	SUBARU	IMPREZA	
2015	SUBARU	LEGACY	
2015	SUBARU	OUTBACK	
<b>234-9139</b>			<b>D</b>
2015	SUBARU	LEGACY	
<b>234-9140</b>			<b>D</b>
2015-2016	LEXUS	GS450H	
2015-2016	LEXUS	RC350	
2015-2016	LEXUS	RC F	
2014-2016	LEXUS	IS350	
2016	LEXUS	GS F	
2016	LEXUS	IS300	
2014-2015	LEXUS	GS350	
2014-2015	LEXUS	IS250	
2014-2016	TOYOTA	COROLLA	
<b>234-9141</b>			<b>D</b>
2013-2016	TOYOTA	VENZA	
<b>234-9142</b>			<b>D</b>
2014-2016	LEXUS	LS460	
<b>234-9143</b>			<b>D</b>
2015-2016	LEXUS	GS450H	
2015-2016	LEXUS	NX200T	
2015-2016	LEXUS	RC350	
2015-2016	LEXUS	RC F	
2014-2016	LEXUS	IS350	
2014-2016	LEXUS	LS460	

#PART PIECE PARTE	MFR / MARQUE FABRICANTE	MODEL MODELE MODELO	D
<b>234-9143 (CONT.)</b>			<b>D</b>
2016	LEXUS	GS F	
2016	LEXUS	IS300	
2014-2015	LEXUS	GS350	
2014-2015	LEXUS	IS250	
2015-2016	TOYOTA	4RUNNER	
<b>234-9144</b>			<b>D</b>
2013	LEXUS	GS350	
2013	LEXUS	IS250	
2013	LEXUS	IS350	
2012-2015	TOYOTA	SEQUOIA	
2012-2015	TOYOTA	TUNDRA	
2013-2014	TOYOTA	4RUNNER	
2013-2014	TOYOTA	FJ CRUISER	
<b>234-9145</b>			<b>D</b>
2015-2016	LEXUS	RC350	
2014-2016	LEXUS	GX460	
2014-2016	LEXUS	IS350	
2014-2016	LEXUS	LS460	
2014-2016	LEXUS	LX570	
2016	LEXUS	LS600H	
2014-2015	LEXUS	GS350	
2014-2015	LEXUS	IS250	
2014-2016	TOYOTA	LAND CRUISER	
2014-2016	TOYOTA	SEQUOIA	
2013-2016	TOYOTA	TUNDRA	
2015	TOYOTA	TACOMA	
<b>234-9146</b>			<b>D</b>
2015-2016	HONDA	FIT	
<b>234-9147</b>			<b>D</b>
2015	NISSAN	JUKE	
<b>234-9148</b>			<b>D</b>
2014-2015	INFINITI	Q50	
2014-2015	INFINITI	Q70	
2015	INFINITI	Q40	
2015	INFINITI	Q60	
2015	INFINITI	Q70L	
2015	INFINITI	QX50	
2015	INFINITI	QX60	
2015	INFINITI	QX70	
2015	INFINITI	QX80	
2015	NISSAN	370Z	
2015	NISSAN	ALTIMA	
2015	NISSAN	FRONTIER	
2015	NISSAN	MURANO	
2015	NISSAN	PATHFINDER	
2015	NISSAN	QUEST	
2015	NISSAN	XTERRA	
<b>234-9149</b>			<b>D</b>
2014-2015	NISSAN	ROGUE	
<b>234-9150</b>			<b>D</b>
2007-2010	VOLVO	C30	

#PART PIECE PARTE	MFR / MARQUE FABRICANTE	MODEL MODELE MODELO	D
<b>234-9150 (CONT.)</b>			<b>D</b>
2005-2010	VOLVO	V50	
2004-2010	VOLVO	S40	
2005-2006	VOLVO	V70	
2005	VOLVO	S60	
2003	VOLVO	S60	
2003	VOLVO	V70	
<b>234-9151</b>			<b>D</b>
2011-2015	VOLVO	S60	
2010-2015	VOLVO	XC60	
2008-2015	VOLVO	XC70	
2007-2015	VOLVO	S80	
2015	VOLVO	V60	
2007-2014	VOLVO	XC90	
2003-2010	VOLVO	V70	
2003-2005	VOLVO	S60	
<b>234-9152</b>			<b>D</b>
2005-2011	VOLVO	XC90	
2007-2010	VOLVO	S80	
<b>234-9153</b>			<b>D</b>
2014-2016	TOYOTA	HIGHLANDER	
<b>234-9154</b>			<b>D</b>
2015-2016	LEXUS	ES350	
2015-2016	LEXUS	NX300H	
2015	LEXUS	RX350	
2015-2016	TOYOTA	AVALON	
2015-2016	TOYOTA	CAMRY	
2015-2016	TOYOTA	SIENNA	
2015-2016	TOYOTA	VENZA	
2014-2016	TOYOTA	HIGHLANDER	
2016	TOYOTA	RAV4	
<b>234-9155</b>			<b>D</b>
2015	LEXUS	RX350	
2015-2016	TOYOTA	AVALON	
2015-2016	TOYOTA	CAMRY	
2015-2016	TOYOTA	SIENNA	
2015-2016	TOYOTA	VENZA	
2014-2016	TOYOTA	HIGHLANDER	
<b>234-9156</b>			<b>D</b>
2015	VOLVO	S60	
2015	VOLVO	S80	
2015	VOLVO	V60	
2015	VOLVO	XC60	
2015	VOLVO	XC70	
<b>234-9299</b>			<b>D</b>
2009-2013	SUZUKI	GRAND VITARA	



AC DELCO	DENSO
213-9	234-3074
213-15	234-1001
213-16	234-3094
213-27	234-3005
213-322	234-2001
213-360	234-4646
213-368	234-1023
213-369	234-1023
213-370	234-2060
213-375	234-2057
213-403	234-1009
213-404	234-4060
213-405	234-4648
213-406	234-4062
213-407	234-4205
213-408	234-4061
213-409	234-4508
213-410	234-4059
213-412	234-4649
213-415	234-4222
213-432	234-4049
213-433	234-2005
213-434	234-2051
213-437	234-1053
213-502	234-1001
213-536	234-4088
213-541	234-3034
213-629	234-3074
213-630	234-1025
213-631	234-1001
213-632	234-3094
213-633	234-3005
213-634	234-3004
213-800	234-4647
213-801	234-4651
213-802	234-4650
213-803	234-2060
213-804	234-2060
213-805	234-5006
213-810	234-4617
213-813	234-1023
213-816	234-4647
213-817	234-4650
213-818	234-4647
213-819	234-4650
213-921	234-4103
213-922	234-4103
213-925	234-2060
213-932	234-4830
213-939	234-4103
213-940	234-4102
213-941	234-4103

AC DELCO	DENSO
213-949	234-4084
213-950	234-4049
213-954	234-4731
213-957	234-4616
213-968	234-4646
213-1062	234-4061
213-1143	234-4285
213-1148	234-4285
213-1149	234-4286
213-1152	234-4104
213-1153	234-4108
213-1156	234-2003
213-1161	234-4669
213-1162	234-4673
213-1164	234-1011
213-1165	234-1001
213-1166	234-1002
213-1167	234-1003
213-1168	234-1003
213-1169	234-1005
213-1171	234-1007
213-1172	234-1006
213-1173	234-1010
213-1174	234-1011
213-1175	234-1012
213-1176	234-1011
213-1177	234-1014
213-1178	234-1011
213-1179	234-1016
213-1180	234-1019
213-1181	234-1020
213-1182	234-1000
213-1184	234-1020
213-1186	234-1022
213-1187	234-1029
213-1188	234-1030
213-1189	234-1034
213-1191	234-1008
213-1192	234-1020
213-1193	234-1024
213-1196	234-1051
213-1198	234-1053
213-1199	234-1055
213-1200	234-1055
213-1201	234-1008
213-1203	234-2002
213-1204	234-2003
213-1205	234-2004
213-1206	234-2006
213-1207	234-2007
213-1208	234-2008
213-1210	234-2010

AC DELCO	DENSO
213-1212	234-2051
213-1213	234-2052
213-1214	234-2055
213-1215	234-2057
213-1216	234-2010
213-1217	234-2005
213-1218	234-2062
213-1220	234-2064
213-1221	234-2065
213-1222	234-2014
213-1223	234-2067
213-1224	234-2068
213-1226	234-2067
213-1227	234-3001
213-1228	234-1020
213-1229	234-3003
213-1230	234-3004
213-1232	234-3007
213-1233	234-3013
213-1234	234-3013
213-1235	234-3023
213-1237	234-3016
213-1238	234-3018
213-1239	234-3019
213-1240	234-3023
213-1241	234-3000
213-1242	234-3000
213-1243	234-3027
213-1244	234-3028
213-1245	234-3060
213-1246	234-3032
213-1247	234-3033
213-1248	234-3034
213-1251	234-3081
213-1253	234-3042
213-1255	234-3019
213-1257	234-3051
213-1258	234-3052
213-1259	234-3030
213-1260	234-3073
213-1261	234-3103
213-1262	234-3082
213-1264	234-3135
213-1265	234-3070
213-1267	234-3081
213-1268	234-3075
213-1269	234-3078
213-1270	234-3048
213-1271	234-3070
213-1272	234-3083
213-1273	234-3084
213-1274	234-3085



AC DELCO	DENSO
213-1275	234-3086
213-1276	234-3087
213-1277	234-3088
213-1278	234-3087
213-1280	234-3014
213-1281	234-3079
213-1282	234-3093
213-1283	234-3012
213-1284	234-3009
213-1285	234-3010
213-1286	234-3008
213-1288	234-3092
213-1289	234-3019
213-1290	234-3083
213-1291	234-3095
213-1294	234-3097
213-1295	234-3102
213-1298	234-3005
213-1299	234-3116
213-1300	234-1011
213-1301	234-3121
213-1302	234-3122
213-1303	234-3120
213-1305	234-3123
213-1306	234-3201
213-1307	234-3126
213-1308	234-3310
213-1313	234-3130
213-1314	234-3132
213-1317	234-4001
213-1318	234-4002
213-1319	234-4003
213-1320	234-4002
213-1321	234-4062
213-1322	234-1007
213-1324	234-4011
213-1325	234-4012
213-1326	234-4013
213-1327	234-4011
213-1328	234-4607
213-1329	234-4016
213-1330	234-4130
213-1333	234-4020
213-1335	234-4023
213-1336	234-4088
213-1337	234-4674
213-1338	234-4026
213-1342	234-4057
213-1343	234-4712
213-1344	234-4676
213-1346	234-4057
213-1350	234-4058

AC DELCO	DENSO
213-1353	234-4181
213-1354	234-4031
213-1356	234-2069
213-1357	234-4052
213-1358	234-4053
213-1359	234-4055
213-1360	234-4051
213-1362	234-4060
213-1363	234-4061
213-1364	234-3018
213-1365	234-4037
213-1366	234-4068
213-1367	234-4070
213-1368	234-4037
213-1369	234-4028
213-1370	234-4075
213-1371	234-4076
213-1372	234-4077
213-1373	234-4008
213-1374	234-4079
213-1375	234-4005
213-1376	234-4021
213-1377	234-4082
213-1378	234-4003
213-1379	234-4086
213-1382	234-4131
213-1383	234-4065
213-1384	234-4097
213-1386	234-4097
213-1387	234-4011
213-1388	234-4602
213-1389	234-4703
213-1390	234-4703
213-1391	234-4325
213-1393	234-4098
213-1394	234-4626
213-1395	234-4697
213-1397	234-4115
213-1399	234-4634
213-1400	234-4614
213-1401	234-4635
213-1403	234-4092
213-1404	234-4042
213-1405	234-4144
213-1406	234-4681
213-1407	234-4020
213-1408	234-3007
213-1409	234-4140
213-1410	234-4145
213-1411	234-4141
213-1412	234-4142
213-1414	234-4185

AC DELCO	DENSO
213-1415	234-4182
213-1416	234-4182
213-1417	234-4182
213-1418	234-4048
213-1419	234-4325
213-1420	234-4039
213-1421	234-4177
213-1422	234-4176
213-1424	234-4175
213-1427	234-4666
213-1428	234-4664
213-1429	234-4661
213-1431	234-1056
213-1432	234-1056
213-1433	234-4152
213-1434	234-4153
213-1435	234-4153
213-1436	234-4155
213-1437	234-4156
213-1438	234-4157
213-1439	234-4158
213-1440	234-4189
213-1442	234-4185
213-1443	234-4138
213-1445	234-4619
213-1447	234-4661
213-1449	234-4183
213-1450	234-4182
213-1451	234-4710
213-1452	234-4649
213-1455	234-4211
213-1458	234-4017
213-1459	234-4001
213-1460	234-4045
213-1461	234-4511
213-1463	234-3309
213-1464	234-3308
213-1466	234-4051
213-1468	234-4601
213-1470	234-4671
213-1471	234-4670
213-1472	234-4134
213-1473	234-4174
213-1474	234-4672
213-1475	234-4674
213-1476	234-4614
213-1480	234-4618
213-1481	234-4094
213-1482	234-4094
213-1483	234-4064
213-1484	234-4139
213-1486	234-4058



AC DELCO	DENSO
213-1487	234-4702
213-1488	234-4627
213-1489	234-4041
213-1490	234-4427
213-1491	234-4738
213-1492	234-4703
213-1493	234-4032
213-1494	234-4143
213-1495	234-4161
213-1498	234-4788
213-1499	234-4784
213-1501	234-4953
213-1505	234-4233
213-1506	234-4801
213-1507	234-4623
213-1508	234-4233
213-1509	234-4233
213-1515	234-4821
213-1516	234-4821
213-1521	234-2052
213-1527	234-4650
213-1528	234-4647
213-1529	234-4343
213-1530	234-4668
213-1531	234-4344
213-1532	234-4345
213-1538	234-4674
213-1540	234-4508
213-1542	234-5010
213-1551	234-4112
213-1552	234-4647
213-1553	234-4646
213-1559	234-4816
213-1560	234-5003
213-1567	234-4346
213-1568	234-4668
213-1570	234-4119
213-1571	234-4651
213-1572	234-5002
213-1573	234-4816
213-1574	234-4285
213-1582	234-4821
213-1583	234-5004
213-1589	234-4802
213-1590	234-4233
213-1596	234-4027
213-1597	234-4054
213-1598	234-4159
213-1601	234-4146
213-1602	234-4605
213-1603	234-4026
213-1605	234-3129

AC DELCO	DENSO
213-1607	234-4015
213-1608	234-1057
213-1609	234-4204
213-1611	234-4292
213-1614	234-4104
213-1615	234-4668
213-1630	234-4063
213-1633	234-4285
213-1637	234-4108
213-1638	234-4104
213-1641	234-4647
213-1643	234-4287
213-1648	234-4049
213-1658	234-3014
213-1676	234-4648
213-1680	234-4617
213-1681	234-4087
213-1685	234-4731
213-1687	234-4668
213-1688	234-4651
213-1691	234-4108
213-1692	234-4647
213-1693	234-4342
213-1694	234-4332
213-1695	234-4815
213-1698	234-4119
213-1699	234-4668
213-1700	234-5005
213-1702	234-4668
213-1703	234-4108
213-2821	234-4816
213-2823	234-4818
213-2824	234-4233
213-2825	234-9052
213-2826	234-4343
213-2827	234-4668
213-2830	234-4344
213-2831	234-4345
213-2839	234-1025
213-2840	234-9007
213-2841	234-9010
213-2842	234-4622
213-2843	234-9011
213-2844	234-9013
213-2845	234-4048
213-2846	234-4048
213-2847	234-9047
213-2848	234-9019
213-2849	234-9020
213-2850	234-9015
213-2852	234-9004
213-2853	234-9005

AC DELCO	DENSO
213-2854	234-4736
213-2855	234-9016
213-2856	234-9040
213-2857	234-9001
213-2858	234-9002
213-2859	234-2001
213-2860	234-1052
213-2862	234-2060
213-2863	234-1000
213-2864	234-2038
213-2866	234-1058
213-2871	234-2011
213-2872	234-4010
213-2873	234-4087
213-2874	234-4651
213-2877	234-4650
213-2878	234-4043
213-2879	234-4716
213-2880	234-4044
213-2882	234-4302
213-2883	234-4006
213-2884	234-3150
213-2885	234-4321
213-2887	234-3075
213-2888	234-4323
213-2889	234-4852
213-2890	234-4224
213-2891	234-4858
213-2892	234-4301
213-2893	234-4363
213-2894	234-4233
213-2896	234-4166
213-2897	234-4875
213-2898	234-4322
213-2899	234-4320
213-2900	234-4470
213-2901	234-4323
213-2902	234-3110
213-2904	234-4718
213-2906	234-4716
213-2907	234-4327
213-2908	234-4457
213-2909	234-4694
213-2910	234-4637
213-2911	234-4638
213-2913	234-4670
213-2914	234-4701
213-2915	234-4112
213-2916	234-4179
213-2917	234-4178
213-2922	234-4074
213-2924	234-4268



AC DELCO	DENSO
213-2925	234-4696
213-2926	234-4633
213-2927	234-4026
213-2928	234-4655
213-2929	234-4126
213-2932	234-4173
213-2933	234-4265
213-2935	234-4804
213-2936	234-4769
213-2938	234-3108
213-2940	234-4060
213-2942	234-3306
213-2943	234-4746
213-2944	234-4653
213-2945	234-4654
213-2946	234-4034
213-2947	234-4176
213-2948	234-4470
213-2949	234-4226
213-2950	234-4660
213-2951	234-4445
213-2952	234-4310
213-2953	234-4311
213-2954	234-4678
213-2955	234-4450
213-2958	234-4631
213-2959	234-4133
213-2960	234-4074
213-2961	234-4890
213-2962	234-3106
213-2963	234-3128
213-2965	234-4411
213-2966	234-4217
213-2967	234-4746
213-2968	234-4767
213-2969	234-4030
213-2970	234-4851
213-2971	234-4036
213-2972	234-4771
213-2973	234-4132
213-2974	234-4040
213-2975	234-4750
213-2976	234-4235
213-2977	234-4707
213-2978	234-4175
213-2979	234-4295
213-2980	234-4191
213-2984	234-4645
213-2985	234-4636
213-2986	234-4747
213-2987	234-4718
213-2988	234-4029

AC DELCO	DENSO
213-2989	234-4768
213-2991	234-4749
213-2993	234-4604
213-2994	234-4626
213-2996	234-4216
213-2997	234-4597
213-2998	234-4624
213-2999	234-4597
213-3000	234-4727
213-3001	234-4022
213-3004	234-4080
213-3006	234-3100
213-3008	234-4090
213-3009	234-4428
213-3010	234-4822
213-3011	234-4066
213-3012	234-4693
213-3013	234-4690
213-3014	234-4691
213-3015	234-4154
213-3016	234-4041
213-3017	234-4035
213-3018	234-4041
213-3020	234-4164
213-3021	234-4048
213-3022	234-4776
213-3023	234-4308
213-3024	234-4121
213-3025	234-4064
213-3027	234-4122
213-3028	234-4324
213-3030	234-4030
213-3031	234-4215
213-3032	234-4189
213-3034	234-4709
213-3037	234-4048
213-3038	234-4326
213-3039	234-4892
213-3040	234-4891
213-3041	234-4893
213-3042	234-4883
213-3043	234-4362
213-3044	234-4809
213-3045	234-3307
213-3046	234-4222
213-3047	234-4682
213-3049	234-4533
213-3050	234-4630
213-3051	234-1055
213-3055	234-4662
213-3056	234-4270
213-3057	234-4524

AC DELCO	DENSO
213-3059	234-3028
213-3060	234-4738
213-3061	234-4065
213-3063	234-4809
213-3064	234-4808
213-3065	234-4296
213-3066	234-4313
213-3067	234-4270
213-3068	234-4273
213-3069	234-3029
213-3071	234-4641
213-3072	234-4658
213-3073	234-4149
213-3074	234-4633
213-3075	234-4742
213-3076	234-4652
213-3078	234-4049
213-3079	234-4752
213-3080	234-4105
213-3081	234-4117
213-3082	234-4872
213-3084	234-4812
213-3086	234-4185
213-3087	234-4864
213-3088	234-4812
213-3089	234-4860
213-3090	234-4661
213-3091	234-4454
213-3092	234-4809
213-3093	234-4798
213-3095	234-4241
213-3096	234-4063
213-3098	234-4410
213-3100	234-4687
213-3102	234-4811
213-3103	234-4221
213-3104	234-4621
213-3105	234-3113
213-3106	234-4140
213-3107	234-4225
213-3108	234-4167
213-3109	234-4689
213-3110	234-4433
213-3112	234-4648
213-3113	234-4033
213-3114	234-3070
213-3115	234-3131
213-3116	234-4751
213-3117	234-4302
213-3118	234-4132
213-3119	234-4734
213-3120	234-4125



AC DELCO	DENSO
213-3121	234-4431
213-3122	234-4432
213-3123	234-4194
213-3124	234-4352
213-3127	234-4730
213-3128	234-4679
213-3129	234-4677
213-3130	234-4850
213-3131	234-4060
213-3133	234-4233
213-3135	234-5007
213-3137	234-4816
213-3138	234-4066
213-3139	234-4348
213-3206	234-4236
213-3207	234-4331
213-3237	234-4668
213-3240	234-5007
213-3528	234-4668
213-3530	234-4289
213-3532	234-4334
213-3533	234-4337
213-3536	234-4339
213-3537	234-4285
213-3538	234-4112
213-3539	234-4331
213-3540	234-4286
213-3541	234-4342
213-3542	234-4347
213-3544	234-4337
213-3545	234-4339
213-3546	234-9052
213-3626	234-5001
213-3627	234-4817
213-3628	234-4668
213-3629	234-4341
213-3630	234-4335
213-3631	234-4338
213-3632	234-4336
213-3673	234-4336
213-3823	234-4332
213-3824	234-4561
213-3839	234-4339
213-3844	234-5007
213-3846	234-4820
213-3850	234-4819
213-3851	234-4818
213-3858	234-4840
213-3863	234-5002
213-3866	234-4668
213-3867	234-4651
213-3868	234-4294

AC DELCO	DENSO
213-3870	234-1021
213-3871	234-4081
213-3873	234-4502
213-3874	234-4503
213-3875	234-4950
213-3878	234-4186
213-3879	234-4370
213-3881	234-4281
213-3884	234-4371
213-3885	234-4472
213-3886	234-4166
213-3887	234-4281
213-3888	234-4396
213-3889	234-4390
213-3892	234-4394
213-3893	234-5028
213-3894	234-5028
213-3895	234-5074
213-3896	234-4308
213-3897	234-4867
213-3898	234-5073
213-3900	234-5703
213-3901	234-5703
213-3902	234-5430
213-3904	234-9064
213-3905	234-9120
213-3908	234-4294
213-3909	234-4289
213-3910	234-4649
213-3911	234-4222
213-3912	234-4049
213-3913	234-4294
213-3917	234-4232
213-3918	234-4008
213-3919	234-4668
213-3920	234-4880
213-3922	234-4473
213-3923	234-4375
213-3924	234-4598
213-3925	234-4593
213-3927	234-4828
213-3928	234-4881
213-3929	234-4603
213-3932	234-4854
213-3933	234-5107
213-3934	234-5091
213-3935	234-5120
213-3936	234-5119
213-3937	234-5137
213-3940	234-5702
213-3941	234-9122
213-3942	234-9075

AC DELCO	DENSO
213-3950	234-4413
213-3951	234-4414
213-3952	234-4829
213-3953	234-4831
213-3954	234-4806
213-3955	234-4810
213-3956	234-4421
213-3957	234-4827
213-4116	234-4673
213-4120	234-4063
213-4138	234-3048
213-4156	234-4341
213-4157	234-4668
213-4158	234-5006
213-4159	234-3105
213-4187	234-1033
213-4188	234-4330
213-4191	234-4289
213-4195	234-4668
213-4197	234-4338
213-4203	234-4669
213-4203-	234-4561
213-4215	234-4243
213-4224	234-4251
213-4225	234-4244
213-4226	234-4254
213-4227	234-4341
213-4228	234-4258
213-4229	234-4256
213-4230	234-4256
213-4240	234-4243
213-4241	234-4246
213-4243	234-4245
213-4244	234-4257
213-4245	234-4255
213-4246	234-4243
213-4247	234-4293
213-4248	234-4288
213-4252	234-4249
213-4253	234-4103
213-4254	234-4245
213-4255	234-4255
213-4256	234-4286
213-4257	234-4252
213-4264	234-4251
213-4267	234-4800
213-4268	234-4688
213-4269	234-4688
213-4272	234-4284
213-4278	234-4080
213-4279	234-4105
213-4282	234-4648

# INTERCHANGE



AC DELCO	DENSO
213-4283	234-2062
213-4284	234-4006
213-4285	234-9090
213-4288	234-4622
213-4289	234-4306
213-4292	234-4305
213-4299	234-4673
213-4321	234-4250
213-4325	234-4253
213-4326	234-4283
213-4349	234-4831
213-4355	234-4876
213-4357	234-4896
213-4358	234-4843
213-4365	234-5104
213-4366	234-5102
213-4367	234-5105
213-4370	234-9008
213-4403	234-4668
213-4406	234-4815
213-4407	234-4816
213-4408	234-4669
213-4413	234-4291
213-4526	234-4283
213-4537	234-4242
213-4546	234-4821
213-4548	234-4255
213-4551	234-4298
213-4553	234-4815
213-4574	234-4441
213-4575	234-4244
213-4576	234-4818
213-4579	234-4284
213-4580	234-4251
213-4643	234-4250
213-4644	234-4821
213-4648	234-4251
213-4698	234-4528
213-4699	234-4527
213-4703	234-4567
213-4764	234-4529
213-4768	234-4530
213-4769	234-4526
213-4772	234-4526
213-5951	234-4732
25165119	234-2001
AFS5P	234-2001
AFS20	234-1001
AFS21	234-1001
AFS22	234-1001
AFS23	234-2001
AFS33	234-1001

AC DELCO	DENSO
AFS48	234-3004
AFS73	234-4006
AFS74	234-3005
AFS75	234-4012
AFS76	234-3011
AFS81	234-1001
AFS87	234-2013
AFS90	234-4012
AFS90W	234-4012
AFS93	234-4019
AFS95	234-4018
AFS96	234-4616
AFS97	234-4087
AFS98	234-4025
AFS101	234-4615
AFS105	234-4012
AFS106	234-4018
AFS108	234-4617
AFS109	234-4018
AFS110	234-4616
AFS113	234-4617
AFS116	234-4087
AFS120	234-4616
AFS121	234-4616
AFS123	234-4087
AFS125	234-4018
AFS129	234-4616
AFS130	234-4089
AFS135	234-4018
AFS136	234-4019
AFS137	234-4024
AFS138	234-4012
AFS141	234-4087
BORG WARNER	DENSO
OS100	234-1003
OS101	234-1002
OS102	234-1001
OS103	234-2001
OS104	234-1004
OS105	234-2007
OS106	234-1011
OS107	234-1017
OS108	234-1025
OS109	234-3002
OS110	234-3001
OS111	234-1011
OS112	234-1019
OS113	234-1012
OS114	234-1014
OS115	234-3003
OS116	234-3007

BORG WARNER	DENSO
OS117	234-3005
OS118	234-3116
OS119	234-4130
OS120	234-3005
OS121	234-4070
OS122	234-4071
OS123	234-4070
OS124	234-4001
OS125	234-4004
OS126	234-4014
OS127	234-4013
OS128	234-4012
OS129	234-3004
OS130	234-3074
OS133	234-4006
OS136	234-4070
OS137	234-1020
OS138	234-3042
OS139	234-4068
OS141	234-4003
OS142	234-4004
OS143	234-4083
OS145	234-4013
OS148	234-3011
OS152	234-4001
OS155	234-4026
OS156	234-4641
OS157	234-4027
OS159	234-4002
OS160	234-4002
OS161	234-4003
OS163	234-4070
OS167	234-4001
OS170	234-4127
OS171	234-4607
OS172	234-4016
OS173	234-3084
OS176	234-4127
OS177	234-4002
OS180	234-4003
OS183	234-4083
OS185	234-4003
OS186	234-4075
OS188	234-4003
OS189	234-4002
OS190	234-4611
OS192	234-4076
OS194	234-4078
OS196	234-4082
OS197	234-4021
OS198	234-4068
OS199	234-4041





BORG WARNER	DENSO
OS200	234-4605
OS203	234-4078
OS205	234-4076
OS207	234-4039
OS208	234-4067
OS209	234-4071
OS212	234-4688
OS213	234-4688
OS214	234-4616
OS216	234-4018
OS219	234-4070
OS221	234-4037
OS223	234-3084
OS225	234-4627
OS228	234-4611
OS230	234-4615
OS231	234-4617
OS244	234-4001
OS323	234-4222
OS506	234-1008
OS507	234-1005
OS508	234-1008
OS509	234-1005
OS510	234-1006
OS511	234-3016
OS515	234-3031
OS516	234-3000
OS517	234-3028
OS518	234-3029
OS519	234-3030
OS521	234-3000
OS522	234-3019
OS525	234-3032
OS526	234-3033
OS527	234-4023
OS528	234-4088
OS530	234-3034
OS532	234-3019
OS536	234-4676
OS540	234-3081
OS541	234-3048
OS543	234-3028
OS544	234-3018
OS547	234-4674
OS548	234-3082
OS549	234-3073
OS551	234-3031
OS552	234-3030
OS555	234-3060
OS557	234-3103
OS565	234-4057
OS566	234-3104

BORG WARNER	DENSO
OS567	234-3070
OS568	234-4712
OS569	234-1000
OS570	234-3105
OS572	234-1018
OS577	234-3104
OS578	234-4711
OS579	234-4711
OS581	234-3105
OS584	234-3302
OS586	234-3135
OS590	234-1016
OS591	234-3083
OS593	234-2052
OS595	234-2052
OS596	234-4072
OS597	234-4053
OS601	234-4051
OS602	234-1056
OS605	234-4185
OS608	234-4698
OS615	234-4049
OS616	234-4060
OS617	234-1053
OS619	234-2051
OS620	234-2052
OS621	234-4508
OS622	234-2055
OS623	234-4059
OS624	234-1001
OS626	234-2003
OS627	234-4061
OS628	234-4067
OS629	234-4011
OS630	234-4093
OS633	234-4093
OS634	234-1010
OS636	234-3013
OS637	234-3013
OS638	234-3023
OS639	234-4664
OS640	234-4507
OS641	234-4177
OS642	234-4676
OS646	234-4011
OS649	234-4011
OS650	234-3101
OS652	234-4670
OS656	234-1018
OS659	234-4182
OS660	234-3092
OS663	234-4685

BORG WARNER	DENSO
OS669	234-1007
OS670	234-4699
OS673	234-4671
OS675	234-4606
OS676	234-3085
OS677	234-3042
OS678	234-4144
OS679	234-1020
OS680	234-4067
OS681	234-4068
OS682	234-2006
OS683	234-4037
OS684	234-4143
OS685	234-4606
OS687	234-1053
OS688	234-1053
OS689	234-1055
OS690	234-2010
OS691	234-2010
OS692	234-1055
OS693	234-3008
OS694	234-4140
OS695	234-4006
OS696	234-3098
OS697	234-3123
OS698	234-3089
OS699	234-3087
OS700	234-1001
OS707	234-4609
OS800	234-3075
OS801	234-3093
OS803	234-3120
OS806	234-4185
OS808	234-4666
OS810	234-4666
OS811	234-4182
OS816	234-4184
OS819	234-4182
OS820	234-4012
OS822	234-4019
OS823	234-4018
OS824	234-4018
OS825	234-4087
OS827	234-4641
OS829	234-4099
OS830	234-4099
OS832	234-4095
OS834	234-4094
OS835	234-1034
OS837	234-4135
OS839	234-4018
OS840	234-4025



BORG WARNER	DENSO
OS841	234-4079
OS842	234-4076
OS844	234-4671
OS849	234-3012
OS850	234-3008
OS851	234-4039
OS853	234-4070
OS854	234-4020
OS855	234-3088
OS856	234-4017
OS857	234-4638
OS858	234-4026
OS859	234-4631
OS860	234-4032
OS861	234-4633
OS862	234-4128
OS864	234-4710
OS866	234-4645
OS867	234-4011
OS869	234-4726
OS872	234-1013
OS873	234-3083
OS876	234-2004
OS877	234-3086
OS879	234-4086
OS880	234-3301
OS881	234-3302
OS883	234-1022
OS884	234-4077
OS885	234-4028
OS888	234-4633
OS890	234-4007
OS891	234-4171
OS892	234-4708
OS893	234-3018
OS894	234-3309
OS895	234-4081
OS896	234-4640
OS897	234-1020
OS898	234-2004
OS899	234-3122
OS900	234-3120
OS902	234-4011
OS903	234-5052
OS904	234-3150
OS905	234-3107
OS906	234-4042
OS907	234-4637
OS908	234-4042
OS909	234-4034
OS910	234-3107
OS911	234-4664

BORG WARNER	DENSO
OS914	234-4131
OS915	234-4655
OS916	234-4633
OS917	234-4633
OS918	234-4631
OS919	234-4655
OS920	234-4631
OS921	234-4657
OS922	234-4637
OS923	234-4026
OS924	234-4709
OS925	234-4664
OS928	234-4656
OS932	234-3126
OS933	234-4055
OS935	234-4623
OS936	234-4151
OS937	234-4661
OS938	234-4661
OS940	234-4174
OS941	234-3101
OS942	234-3102
OS944	234-3129
OS945	234-4520
OS946	234-3089
OS950	234-3129
OS951	234-4704
OS954	234-4703
OS957	234-4624
OS959	234-1053
OS961	234-4169
OS964	234-4157
OS966	234-4052
OS967	234-4072
OS968	234-4622
OS972	234-3302
OS973	234-3096
OS974	234-4716
OS975	234-3087
OS980	234-4703
OS981	234-4322
OS982	234-3087
OS983	234-3087
OS986	234-3091
OS987	234-4061
OS990	234-3121
OS991	234-4094
OS992	234-4704
OS993	234-4644
OS998	234-4783
OS999	234-3075
OS1001	234-4630

BORG WARNER	DENSO
OS1002	234-3120
OS1003	234-3201
OS1004	234-3310
OS1005	234-4037
OS1006	234-4672
OS1007	234-4024
OS1008	234-4012
OS1009	234-1023
OS1010	234-1023
OS1011	234-4646
OS1012	234-3096
OS1013	234-4401
OS1016	234-4701
OS1020	234-4075
OS1022	234-4078
OS1025	234-4115
OS1026	234-4635
OS1029	234-4077
OS1032	234-4145
OS1033	234-3086
OS1034	234-4659
OS1035	234-4681
OS1036	234-4691
OS1037	234-4692
OS1038	234-4154
OS1039	234-4052
OS1040	234-4716
OS1041	234-4705
OS1044	234-4092
OS1045	234-4621
OS1046	234-3308
OS1047	234-4099
OS1048	234-4601
OS1049	234-4601
OS1050	234-4161
OS1051	234-4621
OS1052	234-4601
OS1053	234-4097
OS1055	234-4153
OS1056	234-4097
OS1057	234-4659
OS1059	234-4606
OS1060	234-4681
OS1061	234-4672
OS1063	234-4779
OS1064	234-4703
OS1065	234-4704
OS1066	234-3089
OS1067	234-4662
OS1068	234-4686
OS1069	234-4612
OS1070	234-4142



BORG WARNER	DENSO
OS1071	234-4089
OS1074	234-4019
OS1075	234-3126
OS1076	234-4401
OS1088	234-4323
OS1089	234-4714
OS1091	234-9025
OS1092	234-4601
OS1094	234-4176
OS1095	234-4134
OS1096	234-4180
OS1097	234-4172
OS1098	234-4174
OS1099	234-4176
OS1100	234-4175
OS1101	234-4177
OS1102	234-4175
OS1103	234-4175
OS1104	234-4174
OS1105	234-4172
OS1106	234-4133
OS1107	234-4180
OS1108	234-4173
OS1109	234-4178
OS1110	234-4179
OS1111	234-4684
OS1113	234-4177
OS1115	234-4323
OS1117	234-4637
OS1118	234-4636
OS1119	234-4130
OS1120	234-3095
OS1121	234-4716
OS1130	234-4612
OS1131	234-4638
OS1133	234-4115
OS1135	234-4602
OS1137	234-4078
OS1139	234-4614
OS1140	234-4079
OS1145	234-4092
OS1146	234-4098
OS1147	234-4065
OS1148	234-2008
OS1149	234-2008
OS1152	234-4031
OS1153	234-4092
OS1154	234-4035
OS1155	234-4038
OS1156	234-4714
OS1157	234-4705
OS1161	234-4141

BORG WARNER	DENSO
OS1165	234-4065
OS1167	234-4626
OS1170	234-3307
OS1171	234-4325
OS1172	234-4321
OS1173	234-4714
OS1175	234-3083
OS1176	234-3089
OS1186	234-4048
OS1190	234-4656
OS1198	234-4155
OS1200	234-4137
OS1201	234-4623
OS1207	234-1008
OS1208	234-4623
OS1214	234-2058
OS1226	234-2068
OS1228	234-4150
OS1231	234-4061
OS1232	234-4162
OS1241	234-4623
OS1271	234-4686
OS1272	234-4686
OS1283	234-1030
OS1290	234-1029
OS1357	234-3099
OS1388	234-4809
OS1416	234-4772
OS1418	234-4214
OS1421	234-4749
OS1422	234-4160
OS1424	234-4215
OS1426	234-9023
OS1430	234-2058
OS1432	234-1020
OS1433	234-3019
OS1435	234-4764
OS1436	234-9021
OS1437	234-4211
OS1438	234-4511
OS1439	234-1058
OS1441	234-4809
OS1443	234-3113
OS1444	234-3109
OS1445	234-4642
OS1446	234-4204
OS1449	234-4211
OS1453	234-3302
OS1457	234-4646
OS1458	234-4104
OS1461	234-4112
OS1462	234-4108

BORG WARNER	DENSO
OS1463	234-4837
OS1464	234-3088
OS1465	234-3091
OS1468	234-4769
OS1469	234-4653
OS1470	234-4772
OS1471	234-4029
OS1472	234-4217
OS1473	234-4647
OS1474	234-4650
OS1476	234-4611
OS1477	234-4608
OS1478	234-4609
OS1479	234-4046
OS1480	234-4008
OS1481	234-4008
OS1482	234-4229
OS1483	234-4768
OS1484	234-4747
OS1485	234-4115
OS1486	234-4771
OS1487	234-4228
OS1489	234-4770
OS1490	234-4746
OS1491	234-4029
OS1492	234-4216
OS1493	234-4766
OS1494	234-4719
OS1495	234-4718
OS1496	234-4718
OS1497	234-4692
OS1499	234-9021
OS1500	234-4233
OS1501	234-4233
OS1502	234-4623
OS1503	234-4233
OS1504	234-4801
OS1505	234-4324
OS1506	234-4733
OS1507	234-4800
OS1508	234-4888
OS1509	234-4767
OS1510	234-9010
OS1511	234-9042
OS1512	234-2008
OS1513	234-4622
OS1514	234-9001
OS1515	234-9001
OS1516	234-9001
OS1517	234-9047
OS1518	234-9003
OS1519	234-4080



BORG WARNER	DENSO
OS1520	234-4105
OS1521	234-5006
OS1522	234-4064
OS1523	234-2005
OS1524	234-2066
OS1525	234-4821
OS1526	234-4821
OS1527	234-4830
OS1528	234-4619
OS1529	234-1055
OS1530	234-4149
OS1531	234-9010
OS1532	234-9002
OS1533	234-9021
OS1534	234-4162
OS1535	234-4153
OS1536	234-4189
OS1537	234-4153
OS1538	234-4189
OS1540	234-4154
OS1541	234-4261
OS1542	234-4189
OS1543	234-4189
OS1545	234-4154
OS1546	234-4061
OS1547	234-4163
OS1550	234-4161
OS1551	234-4159
OS1552	234-4162
OS1553	234-4162
OS1554	234-4159
OS1556	234-4260
OS1557	234-2003
OS1558	234-4261
OS1559	234-4153
OS1560	234-4161
OS1561	234-4514
OS1563	234-4623
OS1565	234-9047
OS1566	234-9001
OS1567	234-4154
OS1568	234-4139
OS1569	234-4803
OS1570	234-4604
OS1571	234-4604
OS1572	234-4524
OS1574	234-4260
OS1575	234-4155
OS1576	234-4069
OS1578	234-4162
OS1579	234-4623
OS1580	234-3052

BORG WARNER	DENSO
OS1581	234-4285
OS1582	234-4154
OS1583	234-4603
OS1584	234-9002
OS1585	234-4161
OS1586	234-4189
OS1587	234-4153
OS1589	234-4153
OS1590	234-9003
OS1591	234-4804
OS1592	234-4805
OS1593	234-4162
OS1594	234-4161
OS1595	234-4161
OS1596	234-4189
OS1597	234-4154
OS1598	234-4189
OS1599	234-4161
OS1600	234-4189
OS1601	234-4069
OS1602	234-9009
OS1603	234-4138
OS1604	234-4137
OS1605	234-9024
OS1606	234-4852
OS1607	234-4851
OS1609	234-4042
OS1610	234-4431
OS1611	234-4851
OS1612	234-4432
OS1613	234-4042
OS1614	234-4436
OS1615	234-4434
OS1616	234-4436
OS1618	234-4431
OS1619	234-4431
OS1620	234-4022
OS1621	234-4232
OS1622	234-4596
OS1623	234-4590
OS1624	234-4596
OS1625	234-4587
OS1626	234-4078
OS1627	234-4642
OS1628	234-4641
OS1629	234-4652
OS1630	234-4738
OS1631	234-4641
OS1632	234-4738
OS1633	234-4738
OS1634	234-4641
OS1635	234-4639

BORG WARNER	DENSO
OS1638	234-4738
OS1640	234-4812
OS1641	234-4652
OS1644	234-4809
OS1645	234-5028
OS1646	234-4094
OS1648	234-4368
OS1650	234-4809
OS1651	234-5117
OS1652	234-4152
OS1653	234-4683
OS1654	234-4727
OS1655	234-4808
OS1656	234-4668
OS1657	234-4862
OS1658	234-4860
OS1659	234-4641
OS1660	234-4601
OS1662	234-4361
OS1663	234-9004
OS1664	234-9013
OS1665	234-4122
OS1666	234-4620
OS1670	234-5010
OS1671	234-4601
OS1672	234-4094
OS1674	234-9005
OS1675	234-9005
OS1676	234-4727
OS1677	234-9040
OS1678	234-4368
OS1680	234-5010
OS1681	234-5050
OS1682	234-4093
OS1683	234-4659
OS1684	234-9006
OS1685	234-4360
OS1686	234-4797
OS1687	234-4729
OS1688	234-4065
OS1689	234-4673
OS1690	234-4345
OS1691	234-4344
OS1692	234-4621
OS1693	234-9005
OS1694	234-4727
OS1695	234-4727
OS1696	234-4095
OS1697	234-4065
OS1698	234-4368
OS1699	234-4621
OS1700	234-4302



BORG WARNER	DENSO
OS1701	234-3087
OS1702	234-4325
OS1703	234-4716
OS1704	234-4325
OS1705	234-3089
OS1706	234-4705
OS1707	234-4775
OS1709	234-3098
OS1711	234-4835
OS1713	234-4270
OS1715	234-4273
OS1716	234-4814
OS1718	234-5061
OS1719	234-4778
OS1720	234-4776
OS1722	234-4703
OS1724	234-4286
OS1725	234-4363
OS1726	234-4626
OS1727	234-9041
OS1728	234-4048
OS1729	234-4048
OS1730	234-4215
OS1732	234-4626
OS1733	234-4630
OS1739	234-4044
OS1740	234-4399
OS1741	234-4068
OS1742	234-4397
OS1743	234-4713
OS1744	234-4776
OS1746	234-4041
OS1747	234-4148
OS1748	234-4044
OS1749	234-9058
OS1750	234-4713
OS1751	234-4606
OS1752	234-4724
OS1753	234-4137
OS1754	234-4626
OS1756	234-4603
OS1757	234-4626
OS1758	234-4603
OS1759	234-4715
OS1760	234-4143
OS1761	234-3108
OS1763	234-4139
OS1764	234-4626
OS1765	234-4623
OS1766	234-4152
OS1767	234-4137
OS1768	234-4167

BORG WARNER	DENSO
OS1770	234-4777
OS1771	234-4777
OS1773	234-4048
OS1774	234-4015
OS1775	234-4138
OS1776	234-4630
OS1780	234-4603
OS1781	234-4015
OS1782	234-4626
OS1783	234-4603
OS1785	234-4714
OS1786	234-3089
OS1788	234-3085
OS1789	234-4043
OS1790	234-4146
OS1791	234-4722
OS1792	234-4722
OS1793	234-4141
OS1794	234-4721
OS1795	234-4040
OS1796	234-4330
OS1797	234-4629
OS1799	234-4036
OS1800	234-4144
OS1801	234-4140
OS1802	234-4144
OS1803	234-4141
OS1806	234-4067
OS1807	234-4040
OS1810	234-3009
OS1813	234-4147
OS1814	234-4723
OS1816	234-4751
OS1817	234-4725
OS1820	234-4669
OS1821	234-4094
OS1823	234-3014
OS1824	234-4914
OS1825	234-4184
OS1826	234-4911
OS1827	234-4913
OS1829	234-3080
OS1830	234-5705
OS1831	234-5702
OS1832	234-4148
OS1833	234-4629
OS1835	234-4629
OS1836	234-4752
OS1837	234-4132
OS1838	234-4629
OS1839	234-4117
OS1840	234-4117

BORG WARNER	DENSO
OS1841	234-4125
OS1842	234-4592
OS1843	234-5003
OS1844	234-4867
OS1845	234-5700
OS1848	234-4863
OS1851	234-4911
OS1853	234-4725
OS1854	234-4739
OS1855	234-4186
OS1858	234-4642
OS1859	234-4674
OS1863	234-4789
OS1866	234-4677
OS1867	234-4633
OS1868	234-4742
OS1869	234-4738
OS1871	234-4656
OS1873	234-4641
OS1874	234-4633
OS1875	234-4642
OS1876	234-4738
OS1877	234-4889
OS1878	234-4641
OS1879	234-4886
OS1880	234-4887
OS1881	234-4742
OS1882	234-4656
OS1883	234-4325
OS1884	234-4655
OS1885	234-4633
OS1886	234-4633
OS1888	234-4655
OS1889	234-4645
OS1890	234-4655
OS1891	234-4656
OS1895	234-4891
OS1896	234-4883
OS1897	234-4712
OS1898	234-4180
OS1899	234-4893
OS1900	234-4884
OS1901	234-4895
OS1902	234-4893
OS1904	234-4902
OS1905	234-4883
OS1910	234-4894
OS1911	234-4176
OS1912	234-4897
OS1913	234-4898
OS1915	234-4058
OS1916	234-4066



BORG WARNER	DENSO
0S1917	234-4618
0S1918	234-2060
0S1919	234-4752
0S1920	234-4612
0S1921	234-4517
0S1922	234-4162
0S1923	234-4633
0S1924	234-4808
0S1926	234-4811
0S1927	234-4812
0S1928	234-5129
0S1930	234-4874
0S1931	234-4812
0S1932	234-4809
0S1936	234-4874
0S1937	234-4846
0S1939	234-4039
0S1940	234-9015
0S1941	234-9011
0S1942	234-9010
0S1946	234-3110
0S1947	234-4682
0S1948	234-9007
0S1949	234-4045
0S1950	234-4706
0S1951	234-4608
0S1952	234-4180
0S1953	234-4679
0S1954	234-4601
0S1955	234-4004
0S1956	234-3042
0S1957	234-4070
0S1958	234-4607
0S1959	234-3042
0S1960	234-1020
0S1961	234-4013
0S1962	234-4075
0S1963	234-4002
0S1964	234-4068
0S1965	234-4067
0S1966	234-4078
0S1969	234-4003
0S1970	234-4002
0S1973	234-1005
0S1975	234-2067
0S1977	234-4046
0S1978	234-4098
0S1980	234-4621
0S1981	234-4156
0S1982	234-4072
0S1983	234-2008
0S1985	234-4072

BORG WARNER	DENSO
0S1986	234-4052
0S1987	234-4154
0S1988	234-4162
0S1989	234-4154
0S1990	234-4882
0S1991	234-4001
0S1992	234-4045
0S1994	234-2060
0S1995	234-4205
0S1996	234-4061
0S1997	234-2060
0S1998	234-4651
0S1999	234-4701
0S2000	234-4070
0S2001	234-3034
0S2004	234-4010
0S2006	234-4129
0S2007	234-4102
0S2008	234-4647
0S2009	234-4650
0S2010	234-4103
0S2011	234-4647
0S2012	234-4647
0S2013	234-4650
0S2014	234-4052
0S2015	234-4161
0S2016	234-4052
0S2017	234-1055
0S2018	234-4152
0S2019	234-2010
0S2020	234-4631
0S2021	234-4215
0S2022	234-4153
0S2023	234-9014
0S2024	234-9005
0S2025	234-4648
0S2026	234-4074
0S2028	234-3120
0S2029	234-3100
0S2030	234-4122
0S2033	234-4092
0S2034	234-4621
0S2035	234-4153
0S2036	234-4052
0S2037	234-4078
0S2039	234-4052
0S2040	234-4052
0S2041	234-1053
0S2042	234-4052
0S2043	234-1000
0S2044	234-3104
0S2045	234-4610

BORG WARNER	DENSO
0S2046	234-4204
0S2047	234-4592
0S2048	234-4029
0S2049	234-2002
0S2050	234-4428
0S2051	234-4692
0S2052	234-4164
0S2053	234-4692
0S2054	234-4140
0S2055	234-4140
0S2057	234-4727
0S2058	234-4098
0S2059	234-4606
0S2060	234-3098
0S2061	234-4030
0S2062	234-4065
0S2063	234-4065
0S2064	234-4689
0S2065	234-4609
0S2066	234-4613
0S2068	234-4092
0S2069	234-9009
0S2071	234-3111
0S2072	234-4654
0S2073	234-9028
0S2074	234-1024
0S2075	234-4626
0S2077	234-2062
0S2079	234-4055
0S2080	234-4099
0S2082	234-3013
0S2083	234-4160
0S2085	234-1015
0S2087	234-3074
0S2091	234-4154
0S2094	234-5117
0S2095	234-4809
0S2096	234-4812
0S2097	234-4393
0S2098	234-4308
0S2099	234-4609
0S2100	234-4167
0S2101	234-4633
0S2102	234-4784
0S2104	234-4328
0S2105	234-3113
0S2107	234-4270
0S2108	234-4241
0S2109	234-4327
0S2110	234-3106
0S2111	234-4776
0S2112	234-4326



BORG WARNER	DENSO
OS2113	234-3305
OS2114	234-3113
OS2116	234-5060
OS2118	234-3109
OS2119	234-4704
OS2120	234-3098
OS2122	234-4775
OS2123	234-3113
OS2124	234-4775
OS2125	234-4311
OS2126	234-4295
OS2127	234-4310
OS2128	234-4645
OS2129	234-4222
OS2130	234-4084
OS2131	234-4346
OS2132	234-4647
OS2133	234-4285
OS2134	234-4646
OS2135	234-4647
OS2136	234-2015
OS2138	234-4693
OS2139	234-4309
OS2140	234-4296
OS2141	234-4074
OS2142	234-4778
OS2143	234-4301
OS2144	234-4812
OS2146	234-4812
OS2147	234-4122
OS2148	234-4332
OS2149	234-4100
OS2150	234-4104
OS2152	234-4623
OS2162	234-4690
OS2167	234-4172
OS2168	234-4643
OS2169	234-3112
OS2170	234-4730
OS2171	234-4609
OS2175	234-4603
OS2180	234-4470
OS2181	234-3083
OS2182	234-3083
OS2183	234-3087
OS2184	234-4471
OS2186	234-4715
OS2188	234-4261
OS2189	234-4471
OS2190	234-4099
OS2191	234-4633
OS2192	234-4656

BORG WARNER	DENSO
OS2193	234-4368
OS2194	234-9005
OS2195	234-9017
OS2196	234-4220
OS2197	234-4352
OS2198	234-4729
OS2199	234-4108
OS2200	234-4092
OS2203	234-9066
OS2205	234-4730
OS2207	234-9041
OS2210	234-9057
OS2211	234-9042
OS2212	234-5003
OS2213	234-4816
OS2214	234-4411
OS2215	234-4412
OS2217	234-4651
OS2220	234-4587
OS2221	234-4588
OS2222	234-4771
OS2223	234-4767
OS2224	234-4718
OS2225	234-4745
OS2226	234-4587
OS2227	234-4588
OS2228	234-4410
OS2229	234-4768
OS2232	234-4656
OS2239	234-4668
OS2240	234-4668
OS2241	234-4121
OS2242	234-4119
OS2244	234-4370
OS2245	234-4286
OS2246	234-4617
OS2247	234-4119
OS2248	234-4343
OS2249	234-4668
OS2250	234-4284
OS2251	234-4649
OS2252	234-4063
OS2254	234-4802
OS2255	234-4233
OS2256	234-4284
OS2257	234-4434
OS2258	234-4651
OS2260	234-4287
OS2264	234-4168
OS2265	234-4509
OS2266	234-9042
OS2308	234-4503

BORG WARNER	DENSO
OS2309	234-4623
OS2311	234-9041
OS2312	234-9056
OS2313	234-4222
OS2328	234-5430
OS2329	234-4190
OS2330	234-4190
OS2333	234-4191
OS2335	234-4192
OS2336	234-4191
OS2337	234-4193
OS2338	234-4435
OS2341	234-4194
OS2343	234-4194
OS2350	234-4672
OS2351	234-4683
OS2359	234-4822
OS2361	234-4822
OS2362	234-4872
OS2366	234-4809
OS2369	234-5007
OS2371	234-4809
OS2373	234-4844
OS2376	234-4809
OS2377	234-4850
OS2378	234-4233
OS2381	234-4809
OS2385	234-4816
OS2387	234-4859
OS2388	234-4809
OS2389	234-4809
OS2390	234-4811
OS2391	234-4809
OS2393	234-5028
OS2394	234-5028
OS2395	234-5127
OS2396	234-5117
OS2397	234-5115
OS2399	234-5117
OS2400	234-5133
OS2401	234-5133
OS2402	234-5126
OS2403	234-5060
OS2407	234-5002
OS2408	234-5133
OS2409	234-5028
OS2410	234-5129
OS2411	234-5117
OS2413	234-5117
OS2415	234-4816
OS2416	234-9052
OS2418	234-4818



BORG WARNER	DENSO
0S2419	234-4653
0S2420	234-4654
0S2421	234-4747
0S2424	234-4746
0S2426	234-4375
0S2427	234-4233
0S2428	234-4355
0S2429	234-4368
0S2430	234-4045
0S2431	234-4126
0S2432	234-4099
0S2433	234-4616
0S2434	234-2011
0S2435	234-2069
0S2436	234-4158
0S2437	234-4054
0S2438	234-2013
0S2439	234-4371
0S2441	234-4593
0S2442	234-4371
0S2443	234-4370
0S2446	234-2005
0S2447	234-4693
0S2449	234-4293
0S2452	234-5004
0S2453	234-4610
0S2454	234-4320
0S2455	234-4732
0S2459	234-4817
0S2460	234-4614
0S2461	234-4744
0S2466	234-4112
0S2467	234-4651
0S2471	234-4066
0S2479	234-4851
0S2480	234-4852
0S2481	234-4193
0S2482	234-4193
0S2483	234-4435
0S2484	234-4434
0S2485	234-4199
0S2486	234-4192
0S2487	234-4192
0S2488	234-4436
0S2489	234-4191
BOSCH	DENSO
11027	234-1000
11032	234-1000
11051	234-1000
11964	234-1000
12002	234-1058

BOSCH	DENSO
12006	234-1025
12007	234-2007
12008	234-3005
12013	234-1001
12014	234-1001
12019	234-2004
12022	234-2002
12023	234-2002
12028	234-2001
12035	234-2006
12038	234-1010
12039	234-1016
12040	234-1000
12041	234-2067
12043	234-2004
12046	234-1013
12050	234-1006
12051	234-1008
12053	234-1005
12054	234-1012
12061	234-1020
12100	234-2062
12102	234-1053
12105	234-2058
12106	234-2005
12108	234-2003
12109	234-2008
12111	234-2002
12112	234-1053
12113	234-1024
12114	234-1053
12200	234-2008
12201	234-2051
12202	234-2055
12203	234-1014
12205	234-2051
12919	234-1002
13003	234-3000
13005	234-3027
13007	234-4065
13008	234-3016
13010	234-3074
13011	234-3029
13012	234-3031
13019	234-3019
13021	234-3129
13022	234-1022
13025	234-5052
13026	234-4012
13027	234-4019
13029	234-4024
13030	234-4062

BOSCH	DENSO
13032	234-3048
13034	234-3033
13035	234-4225
13037	234-4023
13038	234-4088
13039	234-3302
13041	234-4033
13043	234-1029
13045	234-4088
13047	234-3060
13048	234-3031
13049	234-3034
13050	234-1030
13051	234-4161
13052	234-4707
13053	234-1022
13054	234-3073
13055	234-4618
13056	234-4061
13058	234-3060
13059	234-3034
13060	234-4095
13068	234-4674
13071	234-4092
13073	234-4060
13074	234-4659
13075	234-4094
13077	234-3005
13081	234-4520
13091	234-3087
13093	234-4097
13095	234-4153
13096	234-4726
13100	234-4005
13101	234-3048
13104	234-4153
13108	234-4670
13109	234-4674
13111	234-4617
13114	234-4351
13115	234-4016
13116	234-4266
13117	234-4401
13118	234-9150
13119	234-3033
13120	234-4440
13122	234-4077
13123	234-4005
13127	234-4609
13130	234-4635
13131	234-4611
13132	234-4634





BOSCH	DENSO
13134	234-4602
13136	234-4153
13138	234-4078
13139	234-4602
13141	234-4153
13142	234-4155
13144	234-3082
13146	234-3104
13148	234-3103
13149	234-4021
13151	234-4028
13152	234-3105
13153	234-4003
13155	234-4013
13156	234-3082
13160	234-3105
13164	234-4159
13165	234-3023
13176	234-4601
13178	234-4647
13181	234-3023
13184	234-4093
13190	234-3003
13191	234-2060
13193	234-4650
13198	234-4072
13200	234-4052
13211	234-3013
13218	234-4131
13224	234-3087
13226	234-4704
13228	234-3097
13231	234-4670
13232	234-3013
13242	234-3098
13245	234-3079
13246	234-5052
13249	234-4099
13250	234-3083
13252	234-3121
13254	234-4621
13255	234-3202
13256	234-4292
13257	234-4703
13258	234-4092
13260	234-3304
13261	234-4320
13262	234-3089
13264	234-4704
13267	234-4665
13268	234-4715
13271	234-4705

BOSCH	DENSO
13272	234-4008
13273	234-4716
13275	234-4004
13276	234-3302
13278	234-4716
13279	234-4152
13280	234-4078
13281	234-4152
13284	234-3084
13287	234-4067
13289	234-4041
13299	234-3070
13300	234-4152
13301	234-3090
13302	234-4061
13306	234-4627
13308	234-3135
13311	234-3089
13312	234-4083
13313	234-3019
13314	234-4712
13315	234-4614
13316	234-4008
13318	234-4710
13320	234-4115
13322	234-4094
13326	234-4057
13327	234-3087
13329	234-3087
13338	234-4215
13340	234-4154
13342	234-4160
13348	234-4777
13350	234-3111
13353	234-4137
13354	234-4261
13355	234-4261
13358	234-4192
13361	234-4066
13362	234-3085
13363	234-4098
13364	234-3086
13366	234-4086
13367	234-4690
13369	234-4185
13370	234-3078
13371	234-4733
13373	234-4182
13374	234-4328
13376	234-3080
13377	234-4727
13378	234-3070

BOSCH	DENSO
13380	234-3070
13381	234-3070
13383	234-4020
13385	234-3122
13387	234-3126
13388	234-3309
13391	234-4852
13392	234-4150
13394	234-4693
13395	234-4182
13396	234-3101
13399	234-4005
13401	234-4055
13404	234-4686
13405	234-4051
13407	234-4083
13408	234-4639
13410	234-4738
13412	234-4655
13413	234-4075
13414	234-4660
13416	234-3075
13417	234-4641
13418	234-3093
13420	234-3089
13421	234-4053
13422	234-4156
13425	234-4026
13427	234-4057
13428	234-4027
13429	234-4711
13431	234-4058
13433	234-4171
13436	234-4082
13437	234-9061
13439	234-4665
13441	234-4138
13444	234-2013
13445	234-3088
13446	234-4193
13447	234-4055
13448	234-4511
13450	234-4615
13453	234-4680
13455	234-4646
13456	234-4641
13457	234-4020
13458	234-4428
13459	234-4164
13460	234-4636
13461	234-4851
13463	234-4191



BOSCH	DENSO
13466	234-4193
13468	234-4081
13469	234-4706
13470	234-4211
13471	234-2009
13473	234-4032
13474	234-4018
13475	234-4681
13476	234-4264
13477	234-4672
13480	234-4641
13482	234-3075
13483	234-4089
13487	234-4092
13489	234-4137
13493	234-9025
13494	234-4837
13498	234-4265
13500	234-4049
13504	234-3110
13505	234-3098
13508	234-3032
13509	234-4266
13511	234-4427
13512	234-9014
13514	234-9150
13515	234-4710
13516	234-4734
13517	234-4697
13519	234-4059
13520	234-4214
13522	234-4671
13523	234-4671
13524	234-3102
13525	234-4508
13528	234-4450
13529	234-4135
13531	234-3111
13532	234-4122
13534	234-4220
13538	234-4732
13539	234-4011
13540	234-9021
13544	234-4630
13547	234-3010
13548	234-4533
13549	234-3086
13550	234-4661
13552	234-4661
13557	234-9018
13558	234-4603
13559	234-4672

BOSCH	DENSO
13562	234-3087
13564	234-4182
13565	234-4852
13566	234-4163
13571	234-4034
13572	234-3008
13574	234-4039
13576	234-3012
13577	234-4183
13578	234-4605
13579	234-4629
13580	234-4172
13581	234-4612
13582	234-4174
13583	234-3008
13584	234-4709
13588	234-4048
13589	234-3009
13591	234-4702
13595	234-4142
13596	234-4141
13597	234-4176
13598	234-4007
13599	234-4708
13610	234-4718
13613	234-9001
13617	234-3087
13618	234-4189
13619	234-4604
13621	234-4376
13622	234-4623
13626	234-9019
13630	234-3108
13632	234-4630
13634	234-4139
13635	234-3087
13640	234-4180
13641	234-3087
13642	234-4175
13643	234-4015
13644	234-4517
13646	234-4626
13647	234-4630
13650	234-4713
13651	234-4713
13652	234-3089
13653	234-4716
13654	234-4182
13656	234-4621
13657	234-3087
13658	234-3087
13659	234-4325

BOSCH	DENSO
13661	234-4183
13662	234-4185
13663	234-3089
13664	234-4030
13666	234-3087
13670	234-4217
13671	234-4772
13672	234-4029
13674	234-4010
13675	234-4302
13676	234-4360
13678	234-9006
13679	234-4509
13680	234-9004
13682	234-4104
13685	234-4094
13686	234-4103
13687	234-4029
13688	234-4752
13689	234-4185
13690	234-4661
13692	234-4662
13694	234-4651
13695	234-4882
13701	234-4102
13702	234-3091
13703	234-3099
13704	234-4797
13706	234-9005
13707	234-4613
13709	234-4216
13710	234-4022
13714	234-4772
13715	234-4351
13717	234-4747
13718	234-4229
13720	234-4149
13721	234-4185
13723	234-4184
13725	234-4703
13727	234-4703
13732	234-4015
13733	234-9010
13735	234-9022
13736	234-4664
13737	234-9012
13740	234-4666
13743	234-4608
13744	234-4351
13745	234-4042
13746	234-4182
13747	234-4432



BOSCH	DENSO
13748	234-4431
13749	234-4431
13751	234-4239
13752	234-4681
13753	234-4435
13754	234-4042
13755	234-4682
13756	234-4037
13761	234-4785
13762	234-4587
13766	234-4225
13767	234-4450
13768	234-4624
13769	234-4396
13770	234-4390
13772	234-4349
13773	234-4166
13774	234-4199
13775	234-4756
13777	234-4351
13779	234-4668
13781	234-4351
13782	234-4172
13783	234-3123
13784	234-4176
13785	234-4378
13788	234-4177
13789	234-4953
13791	234-3120
13796	234-4652
13797	234-3099
13798	234-4175
13801	234-4135
13804	234-4641
13805	234-4642
13806	234-4186
13807	234-4886
13808	234-4887
13809	234-4631
13812	234-4640
13815	234-4655
13816	234-4633
13817	234-4184
13818	234-4631
13822	234-4280
13823	234-4662
13830	234-4017
13832	234-4638
13836	234-1055
13838	234-4148
13839	234-3150
13841	234-3107

BOSCH	DENSO
13842	234-4664
13843	234-4042
13844	234-4637
13847	234-4119
13848	234-3123
13850	234-4037
13851	234-4368
13852	234-4284
13853	234-4355
13854	234-4038
13857	234-4145
13859	234-4140
13860	234-4175
13862	234-4175
13863	234-4606
13864	234-4174
13866	234-4330
13868	234-4752
13869	234-4593
13870	234-4721
13871	234-4597
13872	234-4108
13877	234-4230
13878	234-4457
13879	234-4036
13884	234-4789
13885	234-4751
13886	234-4146
13887	234-4722
13890	234-4130
13891	234-4130
13892	234-4148
13893	234-4134
13894	234-4121
13896	234-2009
13897	234-4313
13898	234-2003
13900	234-4048
13902	234-4215
13903	234-1055
13904	234-4159
13906	234-4626
13907	234-4626
13908	234-4623
13909	234-3051
13910	234-3052
13911	234-4167
13912	234-4619
13913	234-3001
13914	234-4619
13915	234-3082
13916	234-4214

BOSCH	DENSO
13917	234-4603
13918	234-3000
13919	234-4603
13920	234-4214
13921	234-4139
13922	234-5120
13923	234-4783
13924	234-3031
13925	234-3081
13926	234-3081
13927	234-4788
13928	234-2014
13930	234-3104
13933	234-4633
13936	234-3018
13937	234-4654
13938	234-4065
13940	234-9063
13942	234-3002
13944	234-4408
13946	234-3130
13947	234-1034
13948	234-3095
13949	234-4677
13951	234-4679
13952	234-4180
13953	234-3007
13954	234-5053
13955	234-4409
13957	234-3019
13958	234-5018
13959	234-4124
13960	234-4039
13961	234-4350
13962	234-4147
13963	234-1018
13964	234-3085
13965	234-5010
13967	234-4041
13968	234-3113
13969	234-4302
13970	234-4143
13971	234-4629
13972	234-3126
13974	234-4729
13977	234-4099
13978	234-4093
13979	234-4621
13981	234-4784
13982	234-9126
13983	234-4061
13986	234-4189



BOSCH	DENSO
13988	234-4153
13989	234-4189
13996	234-9026
13997	234-9041
13998	234-4153
15000	234-4332
15001	234-4610
15003	234-4175
15004	234-4613
15005	234-4172
15009	234-4350
15011	234-9120
15013	234-9047
15015	234-9018
15017	234-9063
15019	234-9120
15021	234-4282
15024	234-4663
15025	234-4446
15026	234-4666
15027	234-4358
15028	234-4195
15030	234-4447
15031	234-4446
15032	234-4732
15033	234-4436
15034	234-4434
15035	234-4734
15036	234-4268
15037	234-4267
15039	234-4222
15040	234-4105
15041	234-4080
15042	234-9035
15043	234-4349
15044	234-4235
15045	234-4076
15046	234-4614
15047	234-4597
15048	234-4720
15050	234-4435
15051	234-4424
15052	234-9064
15055	234-4450
15056	234-4755
15057	234-9020
15058	234-4058
15059	234-4234
15061	234-4517
15062	234-4689
15063	234-4698
15064	234-4954

BOSCH	DENSO
15065	234-4315
15066	234-4314
15068	234-4636
15069	234-4738
15070	234-5010
15071	234-4626
15072	234-4658
15073	234-4054
15074	234-4950
15075	234-2065
15076	234-4687
15079	234-4355
15080	234-4368
15082	234-9065
15083	234-4133
15084	234-4353
15085	234-4368
15086	234-4364
15087	234-4603
15088	234-4180
15090	234-4173
15092	234-4178
15093	234-9041
15094	234-4179
15095	234-9042
15097	234-4698
15098	234-4699
15099	234-4689
15101	234-9051
15103	234-4261
15104	234-4260
15105	234-4502
15106	234-4261
15107	234-4149
15108	234-9042
15109	234-4683
15110	234-9051
15112	234-4260
15113	234-4294
15114	234-4673
15116	234-9041
15117	234-9051
15118	234-9058
15119	234-4806
15120	234-4521
15121	234-4810
15122	234-4880
15123	234-4598
15124	234-4881
15125	234-4521
15126	234-4518
15127	234-4506

BOSCH	DENSO
15128	234-4258
15129	234-4285
15130	234-4561
15131	234-4331
15132	234-4249
15133	234-4668
15136	234-4258
15137	234-4337
15138	234-4678
15139	234-4236
15140	234-4112
15141	234-4338
15142	234-4651
15143	234-5002
15144	234-4335
15145	234-4338
15146	234-5001
15147	234-4817
15148	234-4293
15149	234-4288
15150	234-4246
15151	234-4250
15152	234-4342
15153	234-4331
15154	234-4332
15155	234-4668
15156	234-4668
15157	234-4414
15158	234-4413
15159	234-4347
15160	234-4666
15161	234-4342
15163	234-9052
15164	234-4334
15165	234-4252
15167	234-4876
15168	234-5138
15169	234-9123
15170	234-4445
15171	234-9123
15172	234-4445
15173	234-4453
15174	234-4450
15175	234-4694
15176	234-5702
15177	234-9150
15178	234-4454
15179	234-9152
15181	234-4453
15182	234-4271
15183	234-4269
15184	234-4695



BOSCH	DENSO
15187	234-4316
15188	234-4317
15189	234-4631
15190	234-4026
15191	234-4318
15193	234-4741
15194	234-4383
15199	234-4068
15200	234-4668
15201	234-4668
15202	234-4172
15207	234-3307
15208	234-4159
15209	234-3310
15210	234-4189
15211	234-4189
15214	234-4393
15215	234-4623
15217	234-9007
15218	234-4078
15220	234-4026
15222	234-4631
15223	234-4657
15224	234-4241
15225	234-4270
15228	234-4074
15232	234-4422
15233	234-4425
15235	234-4181
15236	234-4426
15237	234-4150
15239	234-4623
15240	234-4420
15242	234-1055
15243	234-4623
15244	234-4048
15245	234-4035
15246	234-4603
15247	234-4624
15248	234-4561
15250	234-4182
15251	234-4294
15252	234-4393
15253	234-4392
15254	234-4250
15255	234-4183
15257	234-4142
15260	234-9060
15261	234-4183
15263	234-4044
15264	234-9060
15265	234-4043

BOSCH	DENSO
15266	234-4722
15268	234-9119
15269	234-4048
15270	234-4048
15271	234-1020
15272	234-4167
15273	234-4069
15274	234-4524
15275	234-4069
15276	234-4069
15278	234-4126
15280	234-4820
15282	234-4243
15283	234-4257
15284	234-4668
15285	234-4112
15286	234-9062
15287	234-4031
15290	234-4233
15293	234-4355
15294	234-4080
15295	234-4105
15296	234-4358
15297	234-4079
15298	234-4592
15299	234-4596
15300	234-4590
15306	234-4766
15308	234-4767
15309	234-4801
15313	234-4626
15314	234-4068
15315	234-4141
15316	234-4750
15318	234-4359
15319	234-4035
15320	234-4439
15321	234-4470
15322	234-4606
15323	234-4041
15325	234-4044
15326	234-4040
15327	234-4126
15330	234-4039
15334	234-4433
15335	234-4472
15337	234-4854
15339	234-4470
15340	234-3113
15341	234-4272
15342	234-3111
15343	234-3305

BOSCH	DENSO
15346	234-4854
15347	234-4637
15348	234-4637
15349	234-4633
15351	234-4645
15352	234-4655
15353	234-4633
15355	234-3306
15357	234-4738
15358	234-4239
15359	234-4641
15360	234-4642
15362	234-3087
15363	234-3106
15364	234-4429
15365	234-4468
15366	234-4470
15367	234-4194
15368	234-9069
15369	234-4296
15370	234-4380
15371	234-4329
15373	234-4951
15374	234-5011
15375	234-9125
15376	234-4851
15377	234-4776
15378	234-4715
15379	234-4488
15380	234-4293
15381	234-9071
15382	234-9073
15384	234-4381
15385	234-4715
15386	234-4394
15387	234-4380
15388	234-5007
15389	234-4241
15393	234-5050
15394	234-9013
15396	234-1009
15398	234-4368
15400	234-9040
15401	234-4363
15403	234-4601
15405	234-4361
15406	234-4092
15407	234-4224
15408	234-4354
15409	234-4797
15410	234-4363
15413	234-4368



BOSCH	DENSO
15414	234-4189
15415	234-4189
15416	234-4189
15417	234-4161
15418	234-4161
15423	234-4260
15426	234-4393
15427	234-4121
15428	234-4397
15429	234-4040
15430	234-4398
15431	234-4190
15432	234-4688
15433	234-4688
15436	234-4328
15437	234-4326
15439	234-4596
15442	234-4470
15445	234-4327
15446	234-4321
15447	234-4481
15448	234-3201
15449	234-4289
15452	234-4633
15454	234-4633
15456	234-4633
15458	234-4742
15462	234-4742
15463	234-9087
15465	234-4008
15466	234-3109
15467	234-3113
15468	234-4286
15471	234-4368
15473	234-9017
15476	234-4125
15477	234-4729
15478	234-4100
15479	234-4092
15482	234-9066
15484	234-4730
15486	234-9008
15487	234-4064
15489	234-9057
15490	234-9042
15491	234-4422
15492	234-4421
15493	234-5003
15494	234-4816
15497	234-4411
15498	234-4412
15501	234-9015

BOSCH	DENSO
15503	234-4090
15504	234-4587
15505	234-4588
15506	234-4771
15508	234-4718
15510	234-4029
15511	234-4546
15512	234-4410
15514	234-4739
15515	234-4738
15518	234-4309
15521	234-4312
15522	234-4312
15523	234-4302
15524	234-4308
15525	234-4296
15526	234-4310
15527	234-4311
15529	234-4295
15532	234-4520
15533	234-4732
15534	234-4150
15535	234-4204
15536	234-4121
15537	234-9011
15539	234-4732
15540	234-3107
15541	234-4644
15542	234-4732
15543	234-4285
15545	234-4119
15549	234-4108
15555	234-4752
15558	234-9020
15561	234-4063
15562	234-4434
15564	234-4668
15568	234-4167
15569	234-4168
15570	234-4502
15571	234-9022
15572	234-9042
15574	234-9064
15576	234-4655
15578	234-4738
15580	234-4631
15581	234-4026
15582	234-4316
15583	234-4656
15584	234-4149
15586	234-9122
15588	234-4281

BOSCH	DENSO
15589	234-4741
15590	234-4281
15591	234-4277
15592	234-4642
15593	234-4633
15599	234-4742
15600	234-4741
15601	234-4657
15602	234-4633
15603	234-4742
15605	234-4383
15606	234-4362
15607	234-4383
15608	234-4378
15609	234-4639
15610	234-4362
15611	234-4641
15613	234-4316
15614	234-4652
15615	234-4738
15617	234-4624
15620	234-4503
15621	234-4623
15622	234-9042
15624	234-9056
15626	234-4798
15627	234-9016
15630	234-4696
15633	234-2038
15634	234-4084
15635	234-4222
15636	234-9122
15637	234-4221
15638	234-4736
15640	234-4233
15642	234-4624
15643	234-4858
15644	234-4858
15645	234-4371
15646	234-5430
15647	234-4190
15648	234-4190
15649	234-4260
15651	234-4191
15652	234-4192
15653	234-4192
15655	234-4191
15656	234-4435
15657	234-4166
15658	234-4166
15659	234-4194
15664	234-4401



BOSCH	DENSO
15665	234-4308
15667	234-5061
15668	234-4672
15669	234-4683
15672	234-4260
15675	234-4037
15677	234-4516
15680	234-4473
15681	234-4473
15682	234-4470
15683	234-4512
15684	234-4149
15686	234-4624
15687	234-4069
15691	234-9041
15695	234-4452
15696	234-4289
15697	234-4242
15698	234-4255
15699	234-4245
15700	234-3011
15701	234-3004
15702	234-4006
15703	234-4012
15704	234-4002
15705	234-4077
15706	234-4014
15707	234-4013
15708	234-4067
15709	234-3042
15710	234-4074
15711	234-4051
15712	234-4621
15716	234-4001
15717	234-4001
15718	234-4070
15719	234-4001
15724	234-4609
15735	234-3000
15752	234-4609
15753	234-4370
15755	234-4372
15756	234-4149
15757	234-4325
15758	234-4509
15759	234-4519
15762	234-4515
15763	234-9042
15767	234-9052
15768	234-9058
15769	234-4701
15772	234-4329

BOSCH	DENSO
15776	234-4390
15782	234-5012
15783	234-4395
15784	234-9088
15786	234-4340
15788	234-5015
15790	234-4392
15792	234-4738
15793	234-4656
15794	234-4631
15795	234-4319
15796	234-9032
15798	234-4387
15799	234-4423
15800	234-4450
15801	234-4734
15802	234-4371
15804	234-4375
15806	234-9150
15814	234-4132
15815	234-9152
15816	234-4451
15817	234-9027
15818	234-4136
15819	234-3075
15820	234-3089
15821	234-3098
15822	234-4454
15823	234-4451
15824	234-9074
15825	234-4653
15846	234-9030
15848	234-4117
15857	234-4779
15867	234-4703
15871	234-4714
15873	234-4714
15881	234-4779
15894	234-4285
15895	234-1055
15896	234-4343
15897	234-4066
15898	234-4112
15899	234-4287
15900	234-4104
15901	234-4286
15906	234-5010
15910	234-5010
15912	234-4292
15914	234-4329
15916	234-4329
15918	234-9085

BOSCH	DENSO
15922	234-4390
15924	234-4281
15926	234-9010
15928	234-9121
15930	234-9122
15934	234-9042
15936	234-4798
15937	234-4273
15942	234-4732
15943	234-4270
15944	234-4368
15946	234-9064
15948	234-4122
15949	234-4775
15950	234-9065
15951	234-3113
15953	234-3109
15954	234-9064
15955	234-3109
15957	234-4703
15959	234-4704
15960	234-9008
15961	234-4703
15962	234-9022
15963	234-4778
15964	234-9047
15965	234-4777
15966	234-9042
15967	234-4776
15968	234-9057
15971	234-3112
15972	234-4139
15973	234-4323
15974	234-9026
15975	234-4323
15983	234-3098
15984	234-9054
15986	234-4504
15988	234-9026
15996	234-9026
15998	234-9050
16002	234-4231
16008	234-4839
16017	234-4244
16021	234-4795
16022	234-4794
16025	234-4795
16030	234-4891
16031	234-4900
16034	234-4808
16052	234-4935
16057	234-4879



BOSCH	DENSO
16063	234-4830
16064	234-4822
16065	234-5006
16066	234-5006
16070	234-4815
16073	234-4812
16075	234-4753
16088	234-4815
16089	234-4815
16100	234-4865
16101	234-4861
16109	234-4859
16114	234-4522
16116	234-4896
16118	234-4881
16123	234-4884
16125	234-4894
16132	234-4441
16133	234-4244
16134	234-4818
16136	234-4485
16140	234-4474
16145	234-4475
16146	234-4822
16147	234-4496
16151	234-4536
16162	234-4479
16167	234-4883
16173	234-4914
16174	234-4911
16175	234-4913
16177	234-4475
16179	234-4897
16181	234-4523
16183	234-4898
16197	234-4863
16198	234-4866
16199	234-4863
16200	234-4867
16203	234-4480
16205	234-4878
16207	234-4496
16213	234-4859
16218	234-4478
16239	234-4562
16246	234-4575
16256	234-4582
16268	234-4893
16272	234-4883
16273	234-4575
16274	234-4895
16276	234-4902

BOSCH	DENSO
16285	234-4475
16291	234-4860
16292	234-4862
16318	234-4897
16320	234-4893
16322	234-4891
16324	234-4890
16327	234-4833
16328	234-4899
16329	234-4833
16330	234-4901
16348	234-4897
16349	234-4527
16353	234-4893
16359	234-4893
16373	234-4808
16378	234-4821
16379	234-4283
16383	234-4849
16392	234-4753
16420	234-4899
16428	234-4900
16433	234-4911
16435	234-4923
16438	234-4883
16446	234-4863
16447	234-4867
16448	234-4865
16449	234-4565
16451	234-4566
16453	234-4244
16454	234-4564
16456	234-4893
16471	234-4891
16473	234-4894
16475	234-4893
16488	234-4864
16498	234-4809
16506	234-4916
16507	234-4920
16508	234-4917
16511	234-4814
16513	234-4297
16532	234-4816
16536	234-4582
16541	234-4865
16546	234-4821
16552	234-4441
16575	234-4850
16586	234-4808
16587	234-4809
16589	234-4809

BOSCH	DENSO
16595	234-4821
16596	234-4296
16622	234-4863
16623	234-4912
16624	234-4910
16643	234-4575
16671	234-4828
16682	234-4861
16691	234-4073
16693	234-4213
16698	234-4829
16702	234-4850
16704	234-4859
16726	234-4816
16733	234-4821
16734	234-4529
16735	234-4527
16736	234-4528
16737	234-4529
16743	234-4821
16744	234-4577
16746	234-4818
16747	234-4896
16749	234-4881
16751	234-4895
16753	234-4899
16789	234-4892
16790	234-4876
16792	234-4892
16793	234-4875
16794	234-4877
16795	234-4876
16796	234-4892
16797	234-4808
16808	234-4877
16809	234-4892
16810	234-4496
16825	234-4879
16826	234-4879
16828	234-4818
16829	234-4849
16839	234-4485
16861	234-4819
16862	234-4832
16864	234-4875
16893	234-4871
16895	234-4849
16926	234-4933
16938	234-4840
16946	234-4964
16962	234-4878
16977	234-4876





BOSCH	DENSO
16978	234-4874
16980	234-4753
16982	234-4809
16984	234-4833
16986	234-4498
17000	234-5080
17004	234-5135
17005	234-5115
17006	234-5095
17008	234-5079
17010	234-5037
17011	234-5055
17014	234-5115
17015	234-5048
17016	234-5096
17018	234-5003
17019	234-5091
17020	234-5139
17024	234-5102
17028	234-5136
17029	234-5136
17034	234-5702
17035	234-5705
17036	234-5703
17037	234-5135
17038	234-5702
17039	234-5135
17044	234-5072
17049	234-5156
17051	234-5140
17055	234-5108
17056	234-5161
17057	234-5128
17062	234-5153
17066	234-5097
17068	234-5108
17069	234-5154
17070	234-5700
17071	234-5118
17082	234-5125
17085	234-5045
17091	234-5138
17093	234-5136
17094	234-5138
17098	234-5139
17099	234-5138
17101	234-5127
17102	234-5138
17105	234-5117
17107	234-5157
17108	234-5136
17112	234-5136

BOSCH	DENSO
17117	234-5139
17124	234-5138
17126	234-5136
17135	234-5703
17136	234-5701
17137	234-5700
17148	234-5034
17151	234-5009
17154	234-5023
17155	234-5036
17156	234-5023
17157	234-5045
17158	234-5074
17160	234-5133
17169	234-5034
17174	234-5117
17175	234-5134
17176	234-5134
17178	234-5019
17179	234-5061
17182	234-5008
17186	234-5700
17187	234-5026
17188	234-5701
17196	234-5108
17200	234-5046
17201	234-5004
17202	234-5027
17203	234-5064
17204	234-5060
17205	234-5002
17206	234-5027
17208	234-5133
17212	234-5090
17215	234-5137
17216	234-5137
17217	234-5135
17218	234-5036
17220	234-5119
17224	234-5023
17225	234-5093
17226	234-5024
17228	234-5023
17230	234-5138
17231	234-5027
17232	234-5094
17233	234-5028
17234	234-5073
17235	234-5106
17236	234-5086
17237	234-5045
17242	234-5117

BOSCH	DENSO
17243	234-5134
17245	234-5036
17254	234-5132
17255	234-5134
17263	234-5113
17264	234-5060
17266	234-5036
17270	234-5083
17272	234-5054
17274	234-5097
17275	234-5005
17276	234-5108
17277	234-5125
17278	234-5133
17279	234-5097
17280	234-5076
17281	234-5065
17283	234-5085
17287	234-5062
17288	234-5066
17290	234-5133
17300	234-5110
17305	234-5141
17307	234-5107
17308	234-5142
17319	234-5057
17320	234-5131
17321	234-5097
17323	234-5076
17324	234-5118
17326	234-5108
17328	234-5104
17329	234-5023
17330	234-5110
17331	234-5069
17332	234-5702
17339	234-5158
17341	234-5158
17347	234-5158
17351	234-5045
17353	234-5028
17357	234-5129
17358	234-5068
17359	234-5148
17361	234-5045
17363	234-5103
17403	234-5045
17444	234-5071
17447	234-5025
17466	234-5140
17475	234-5113
17480	234-5102



BOSCH	DENSO
18001	234-3006
18002	234-3015
18003	234-4198
18004	234-4198
18005	234-4197
18010	234-4938
18011	234-4064
18013	234-4305
18014	234-4501
18016	234-4306
18017	234-4260
18018	234-4149
18019	234-4465
18020	234-4188
18021	234-4455
18022	234-4291
18023	234-4250
18024	234-4464
18025	234-4263
18026	234-4120
18027	234-4247
18028	234-4165
18029	234-4107
18030	234-4351
18031	234-4351
18032	234-4253
18033	234-4509
18034	234-4298
18035	234-4218
18036	234-4303
18037	234-9092
18038	234-4444
18039	234-4400
18040	234-4466
18041	234-4467
18042	234-4419
18043	234-4238
18044	234-4458
18045	234-4456
18046	234-4448
18047	234-4537
18048	234-4461
18049	234-4449
18050	234-4442
18052	234-5030
18053	234-5040
18054	234-4492
18055	234-4444
18056	234-5012
18057	234-9090
18058	234-9008
18059	234-9033

BOSCH	DENSO
18060	234-9036
18061	234-9036
18062	234-9036
18063	234-9037
18064	234-9060
18066	234-9097
18067	234-5041
18068	234-4495
18069	234-4494
18070	234-4576
18071	234-9112
18073	234-4391
18074	234-4114
18075	234-4513
18076	234-5049
18077	234-4239
18078	234-4505
18079	234-4254
18080	234-9035
18081	234-9109
18082	234-5012
18083	234-5056
18084	234-9103
18085	234-4237
18086	234-4585
18087	234-4120
18088	234-4572
18089	234-4570
18091	234-9099
18092	234-4304
18093	234-9034
18095	234-9059
18099	234-4382
18100	234-4462
18103	234-4550
18104	234-5029
18105	234-4456
18106	234-5092
18107	234-4414
18108	234-4484
18109	234-4483
18110	234-4922
18111	234-4924
18115	234-9094
18116	234-5032
18117	234-4044
18118	234-5013
18120	234-4279
18121	234-9095
18124	234-4106
18125	234-4417
18126	234-4579

BOSCH	DENSO
18128	234-4489
CARQUEST	DENSO
75-1500	234-1004
75-1502	234-2001
75-1503	234-1025
75-1504	234-1001
75-1505	234-1002
75-1506	234-1000
75-1509	234-1017
75-1511	234-1005
75-1513	234-1056
75-1514	234-3005
75-1515	234-3116
75-1516	234-3003
75-1517	234-3007
75-1518	234-3001
75-1519	234-4004
75-1521	234-4070
75-1522	234-1010
75-1524	234-1012
75-1525	234-4013
75-1527	234-3023
75-1530	234-3019
75-1531	234-3016
75-1534	234-3019
75-1535	234-4707
75-1536	234-2002
75-1541	234-3030
75-1545	234-3000
75-1547	234-3027
75-1549	234-3029
75-1550	234-3030
75-1551	234-3031
75-1552	234-3048
75-1553	234-3033
75-1554	234-4023
75-1555	234-4088
75-1556	234-3034
75-1557	234-4670
75-1558	234-1000
75-1559	234-3082
75-1560	234-3000
75-1561	234-2052
75-1562	234-1000
75-1563	234-3048
75-1564	234-3081
75-1565	234-3104
75-1566	234-1020
75-1569	234-3005
75-1570	234-3073
75-1572	234-3074



CARQUEST	DENSO
75-1577	234-3013
75-1579	234-3078
75-1580	234-4710
75-1581	234-4057
75-1584	234-3101
75-1585	234-4680
75-1586	234-4058
75-1587	234-1013
75-1590	234-1016
75-1591	234-3302
75-1596	234-4003
75-1600	234-4689
75-1603	234-3032
75-1605	234-3129
75-1609	234-2004
75-1610	234-4086
75-1611	234-2004
75-1614	234-3122
75-1615	234-3309
75-1617	234-4081
75-1620	234-4611
75-1624	234-3084
75-1625	234-4083
75-1626	234-4013
75-1627	234-3085
75-1629	234-4068
75-1631	234-3086
75-1633	234-1014
75-1634	234-1020
75-1636	234-3126
75-1639	234-3090
75-1641	234-3089
75-1642	234-4130
75-1644	234-4182
75-1645	234-3075
75-1646	234-3093
75-1647	234-3089
75-1648	234-3088
75-1649	234-4045
75-1651	234-4046
75-1652	234-4697
75-1653	234-4135
75-1654	234-4130
75-1655	234-4533
75-1656	234-4182
75-1657	234-4183
75-1658	234-4689
75-1659	234-4045
75-1660	234-4182
75-1662	234-4185
75-1663	234-3091
75-1664	234-4185

CARQUEST	DENSO
75-1665	234-4184
75-1666	234-4703
75-1667	234-4703
75-1668	234-4666
75-1671	234-2006
75-1673	234-3014
75-1674	234-4708
75-1675	234-4171
75-1676	234-4665
75-1678	234-4077
75-1679	234-4002
75-1680	234-4083
75-1686	234-4115
75-1694	234-4076
75-1697	234-4002
75-1700	234-4082
75-1701	234-4012
75-1705	234-2003
75-1706	234-3011
75-1707	234-4661
75-1709	234-4698
75-1710	234-4671
75-1712	234-4661
75-1713	234-3075
75-1714	234-4174
75-1716	234-4078
75-1717	234-4076
75-1718	234-3060
75-1719	234-4051
75-1721	234-4001
75-1722	234-4078
75-1724	234-4003
75-1726	234-4018
75-1730	234-4006
75-1733	234-4019
75-1734	234-3087
75-1735	234-3302
75-1736	234-4953
75-1737	234-3097
75-1739	234-3083
75-1741	234-4715
75-1743	234-3070
75-1744	234-3098
75-1745	234-3087
75-1747	234-4699
75-1748	234-4704
75-1749	234-4704
75-1751	234-4702
75-1753	234-3202
75-1754	234-4099
75-1755	234-4007
75-1756	234-2067

CARQUEST	DENSO
75-1757	234-3042
75-1760	234-4666
75-1761	234-4724
75-1762	234-4641
75-1763	234-4027
75-1764	234-4026
75-1767	234-4605
75-1768	234-4049
75-1770	234-4646
75-1771	234-4089
75-1772	234-4615
75-1774	234-5052
75-1775	234-4074
75-1776	234-4620
75-1777	234-4601
75-1781	234-4621
75-1783	234-4703
75-1784	234-4626
75-1785	234-4623
75-1787	234-2010
75-1790	234-4157
75-1791	234-2055
75-1800	234-4151
75-1801	234-4052
75-1804	234-4162
75-1805	234-4153
75-1809	234-4520
75-1810	234-2058
75-1811	234-4059
75-1813	234-3004
75-1814	234-4093
75-1816	234-4062
75-1817	234-4507
75-1820	234-1053
75-1821	234-4641
75-1825	234-4060
75-1829	234-4726
75-1830	234-4649
75-1831	234-1022
75-1832	234-4618
75-1833	234-4131
75-1834	234-4882
75-1837	234-1029
75-1838	234-1030
75-1842	234-3121
75-1843	234-4021
75-1847	234-4705
75-1848	234-4665
75-1849	234-4012
75-1853	234-4635
75-1854	234-4078
75-1855	234-4602



CARQUEST	DENSO
75-1857	234-4205
75-1858	234-4061
75-1860	234-2060
75-1861	234-4647
75-1862	234-4024
75-1863	234-4067
75-1864	234-4779
75-1865	234-3075
75-1870	234-1023
75-1871	234-4164
75-1872	234-4428
75-1874	234-3082
75-1877	234-4670
75-1879	234-3034
75-1880	234-3082
75-1881	234-3105
75-1883	234-3102
75-1884	234-4097
75-1885	234-4709
75-1887	234-3023
75-1888	234-4628
75-1889	234-4010
75-1890	234-3103
75-1891	234-3105
75-1892	234-4182
75-1894	234-3135
75-1898	234-4129
75-1899	234-4102
75-1900	234-4343
75-1901	234-4103
75-1903	234-4014
75-1906	234-4663
75-1909	234-4025
75-1911	234-4041
75-1912	234-4067
75-1915	234-3060
75-1916	234-3013
75-1921	234-3081
75-1927	234-4095
75-1931	234-4057
75-1932	234-4711
75-1934	234-3104
75-1937	234-4440
75-1950	234-4094
75-1953	234-4640
75-1954	234-4115
75-1955	234-4710
75-1966	234-1034
75-1968	234-4789
75-1970	234-4788
75-1973	234-4672
75-1975	234-4633

CARQUEST	DENSO
75-1976	234-4655
75-1982	234-2007
75-1987	234-4065
75-2005	234-1058
75-2007	234-1007
75-2008	234-2002
75-2011	234-2062
75-2013	234-2005
75-2014	234-2008
75-2015	234-2008
75-2022	234-4088
75-2023	234-4648
75-2026	234-4095
75-2032	234-4659
75-2040	234-4617
75-2042	234-3033
75-2044	234-4634
75-2045	234-4602
75-2046	234-4153
75-2048	234-4153
75-2049	234-4155
75-2056	234-4159
75-2058	234-4162
75-2076	234-3079
75-2078	234-3308
75-2080	234-4621
75-2081	234-4727
75-2082	234-4092
75-2084	234-3304
75-2085	234-4320
75-2086	234-3089
75-2091	234-4705
75-2092	234-4716
75-2093	234-4716
75-2094	234-4152
75-2095	234-4152
75-2102	234-4161
75-2104	234-3070
75-2105	234-4152
75-2106	234-4061
75-2110	234-4712
75-2111	234-4614
75-2113	234-4094
75-2114	234-3087
75-2116	234-3087
75-2118	234-9009
75-2119	234-4215
75-2121	234-4154
75-2122	234-4160
75-2126	234-4777
75-2127	234-3111
75-2131	234-4066

CARQUEST	DENSO
75-2132	234-4098
75-2134	234-4690
75-2135	234-4733
75-2136	234-4776
75-2138	234-3080
75-2140	234-4011
75-2142	234-4150
75-2143	234-4693
75-2145	234-4641
75-2146	234-4055
75-2149	234-4686
75-2150	234-4051
75-2152	234-4639
75-2154	234-4738
75-2155	234-4656
75-2157	234-4053
75-2160	234-4169
75-2161	234-4055
75-2162	234-4511
75-2167	234-4020
75-2168	234-4637
75-2169	234-4851
75-2171	234-4706
75-2172	234-4211
75-2173	234-2015
75-2174	234-4681
75-2177	234-4092
75-2178	234-4137
75-2179	234-9025
75-2180	234-4837
75-2181	234-3110
75-2182	234-3098
75-2185	234-9014
75-2188	234-4214
75-2189	234-4671
75-2191	234-3111
75-2192	234-4122
75-2193	234-4621
75-2197	234-4630
75-2200	234-4144
75-2202	234-4624
75-2204	234-4069
75-2205	234-4603
75-2207	234-3098
75-2209	234-4852
75-2210	234-4163
75-2212	234-3008
75-2214	234-4039
75-2215	234-4162
75-2216	234-3012
75-2217	234-4723
75-2218	234-3008



CARQUEST	DENSO
75-2220	234-4048
75-2222	234-4048
75-2223	234-3009
75-2224	234-9023
75-2225	234-4142
75-2226	234-4141
75-2227	234-4176
75-2228	234-9028
75-2230	234-9002
75-2233	234-9001
75-2234	234-4061
75-2237	234-4189
75-2238	234-4604
75-2239	234-4623
75-2244	234-3108
75-2245	234-4138
75-2246	234-4630
75-2247	234-4604
75-2248	234-4139
75-2249	234-3087
75-2252	234-4601
75-2253	234-4180
75-2254	234-3087
75-2255	234-4175
75-2256	234-4015
75-2257	234-4517
75-2259	234-4626
75-2260	234-4630
75-2263	234-4713
75-2264	234-4713
75-2265	234-3089
75-2266	234-4716
75-2268	234-4621
75-2269	234-3087
75-2270	234-3087
75-2271	234-4325
75-2272	234-3089
75-2273	234-4030
75-2274	234-4029
75-2275	234-3087
75-2279	234-4030
75-2281	234-4029
75-2283	234-4302
75-2284	234-4122
75-2286	234-9006
75-2287	234-9004
75-2289	234-4104
75-2292	234-4094
75-2293	234-4719
75-2295	234-4661
75-2297	234-4662
75-2304	234-3100

CARQUEST	DENSO
75-2305	234-9005
75-2306	234-9005
75-2307	234-4613
75-2308	234-4125
75-2309	234-4216
75-2310	234-4022
75-2311	234-4718
75-2312	234-4764
75-2313	234-4749
75-2314	234-4768
75-2316	234-4654
75-2317	234-4747
75-2318	234-4232
75-2319	234-4653
75-2320	234-4149
75-2325	234-4015
75-2326	234-9010
75-2327	234-9042
75-2328	234-4664
75-2329	234-9047
75-2331	234-4608
75-2332	234-4042
75-2333	234-4431
75-2334	234-4432
75-2335	234-4431
75-2336	234-4431
75-2338	234-4434
75-2339	234-4681
75-2340	234-4435
75-2341	234-4042
75-2342	234-4682
75-2343	234-4172
75-2344	234-4176
75-2345	234-4177
75-2349	234-4738
75-2350	234-4652
75-2351	234-3099
75-2354	234-4175
75-2355	234-4032
75-2356	234-4672
75-2358	234-4641
75-2359	234-4642
75-2360	234-4186
75-2361	234-4886
75-2362	234-4887
75-2363	234-4631
75-2367	234-4184
75-2368	234-4631
75-2371	234-4645
75-2372	234-4662
75-2377	234-4017
75-2379	234-4638

CARQUEST	DENSO
75-2382	234-1055
75-2388	234-4038
75-2389	234-4145
75-2391	234-4140
75-2392	234-4175
75-2394	234-4175
75-2395	234-4606
75-2396	234-4174
75-2398	234-4330
75-2400	234-4752
75-2401	234-4721
75-2402	234-4036
75-2406	234-4751
75-2407	234-4146
75-2408	234-4722
75-2411	234-4148
75-2412	234-4134
75-2413	234-4121
75-2415	234-2003
75-2417	234-4048
75-2419	234-4215
75-2420	234-1055
75-2421	234-4514
75-2423	234-4626
75-2424	234-4626
75-2425	234-4623
75-2426	234-3052
75-2427	234-4167
75-2428	234-4619
75-2429	234-4619
75-2430	234-4204
75-2431	234-4603
75-2432	234-4603
75-2433	234-4214
75-2434	234-4139
75-2435	234-4783
75-2436	234-2014
75-2441	234-3095
75-2442	234-4677
75-2444	234-4679
75-2445	234-4180
75-2447	234-3085
75-2448	234-3113
75-2449	234-4324
75-2450	234-4629
75-2451	234-3126
75-2452	234-4729
75-2454	234-4092
75-2456	234-4093
75-2457	234-4621
75-2463	234-4189
75-2465	234-4153



CARQUEST	DENSO
75-2466	234-4189
75-2469	234-4137
75-2470	234-9024
75-2472	234-9058
75-2473	234-9041
75-2474	234-9003
75-2476	234-4175
75-2477	234-4172
75-2478	234-4666
75-2479	234-4058
75-2480	234-4698
75-2481	234-4133
75-2482	234-4180
75-2483	234-4173
75-2484	234-4178
75-2485	234-4179
75-2487	234-4683
75-2488	234-4172
75-2494	234-4189
75-2495	234-4189
75-2497	234-4137
75-2498	234-4623
75-2500	234-9007
75-2501	234-4241
75-2502	234-4270
75-2504	234-4074
75-2506	234-4622
75-2508	234-4150
75-2509	234-4803
75-2510	234-4623
75-2511	234-1055
75-2512	234-4623
75-2513	234-4035
75-2514	234-4626
75-2519	234-4629
75-2520	234-4044
75-2521	234-4043
75-2522	234-4722
75-2523	234-4752
75-2524	234-4048
75-2525	234-4048
75-2527	234-4167
75-2528	234-4069
75-2529	234-4524
75-2530	234-4069
75-2533	234-4126
75-2535	234-4820
75-2537	234-4669
75-2538	234-4673
75-2539	234-4668
75-2540	234-4112
75-2542	234-4651

CARQUEST	DENSO
75-2543	234-4623
75-2544	234-4233
75-2548	234-4105
75-2549	234-4078
75-2550	234-4592
75-2551	234-4596
75-2552	234-4590
75-2555	234-4718
75-2558	234-4766
75-2560	234-4767
75-2561	234-4801
75-2562	234-4800
75-2565	234-4626
75-2566	234-4725
75-2567	234-4141
75-2568	234-4750
75-2571	234-4148
75-2572	234-4117
75-2573	234-4044
75-2574	234-4040
75-2575	234-4041
75-2576	234-4067
75-2578	234-4039
75-2583	234-4642
75-2584	234-3113
75-2586	234-3305
75-2588	234-4633
75-2589	234-4645
75-2590	234-4655
75-2591	234-4633
75-2592	234-4655
75-2593	234-3306
75-2595	234-4738
75-2596	234-4633
75-2597	234-4642
75-2598	234-4739
75-2599	234-3087
75-2600	234-4468
75-2601	234-4468
75-2603	234-4776
75-2604	234-4715
75-2606	234-4715
75-2607	234-4241
75-2609	234-4124
75-2610	234-4727
75-2611	234-5050
75-2612	234-9013
75-2614	234-9005
75-2615	234-4368
75-2617	234-9040
75-2618	234-5010
75-2620	234-4601

CARQUEST	DENSO
75-2622	234-4361
75-2623	234-4092
75-2625	234-4613
75-2626	234-4797
75-2627	234-4363
75-2628	234-4355
75-2630	234-4368
75-2631	234-4189
75-2632	234-4189
75-2633	234-4189
75-2634	234-4161
75-2635	234-4161
75-2638	234-4804
75-2639	234-4805
75-2640	234-4260
75-2643	234-4393
75-2644	234-4399
75-2645	234-4397
75-2646	234-4040
75-2647	234-4398
75-2648	234-4190
75-2649	234-4688
75-2650	234-4688
75-2651	234-4344
75-2653	234-4328
75-2654	234-4326
75-2655	234-4115
75-2656	234-4596
75-2657	234-4746
75-2658	234-4470
75-2661	234-4327
75-2662	234-4321
75-2675	234-4701
75-2679	234-4132
75-2680	234-3089
75-2681	234-3098
75-2685	234-4703
75-2686	234-4714
75-2687	234-4714
75-2691	234-4779
75-2693	234-4273
75-2695	234-4270
75-2696	234-4775
75-2697	234-3109
75-2698	234-3109
75-2699	234-4703
75-2700	234-4704
75-2701	234-4703
75-2702	234-4778
75-2703	234-4777
75-2704	234-4776
75-2706	234-3112



CARQUEST	DENSO
75-2707	234-4323
75-2708	234-4323
75-2709	234-3098
75-2713	234-4830
75-2714	234-4822
75-2719	234-4441
75-2721	234-4809
75-2722	234-4884
75-2723	234-4894
75-2724	234-4822
75-2726	234-4883
75-2727	234-4914
75-2728	234-4911
75-2729	234-4913
75-2731	234-4898
75-2732	234-4863
75-2733	234-4866
75-2734	234-4863
75-2735	234-4867
75-2737	234-4859
75-2742	234-4808
75-2745	234-4895
75-2746	234-4902
75-2750	234-4812
75-2751	234-4860
75-2752	234-4862
75-2756	234-4897
75-2757	234-4891
75-2759	234-4893
75-2760	234-4808
75-2761	234-4821
75-2762	234-4283
75-2771	234-4814
75-2772	234-4835
75-2773	234-5115
75-2774	234-5003
75-2776	234-5702
75-2777	234-5705
75-2778	234-5703
75-2779	234-5072
75-2786	234-5133
75-2788	234-5061
75-2790	234-4674
75-2792	234-4674
75-2794	234-4016
75-2795	234-4403
75-2796	234-5052
75-2799	234-4727
75-2800	234-4079
75-2801	234-9021
75-2805	234-4037
75-2806	234-3123

CARQUEST	DENSO
75-2807	234-3120
75-2812	234-4664
75-2813	234-4042
75-2815	234-4037
75-2818	234-2068
75-2822	234-4633
75-2823	234-3018
75-2824	234-4065
75-2826	234-3002
75-2827	234-3130
75-2831	234-4147
75-2834	234-4143
75-2835	234-4784
75-2837	234-4159
75-2839	234-4026
75-2840	234-4656
75-2841	234-4631
75-2850	234-4048
75-2851	234-4603
75-2862	234-4035
75-2863	234-4606
75-2871	234-4637
75-2872	234-4637
75-2873	234-4645
75-2874	234-4641
75-2875	234-3106
75-2889	234-1009
75-2895	234-4742
75-2896	234-4633
75-2897	234-4656
75-2898	234-4633
75-2899	234-4656
75-2900	234-4633
75-2901	234-4656
75-2902	234-4742
75-2903	234-4738
75-2904	234-4633
75-2905	234-4656
75-2908	234-4742
75-2909	234-4008
75-2917	234-5006
75-2918	234-4893
75-2919	234-4883
75-2920	234-4874
75-2927	234-4753
75-2928	234-5700
75-2972	234-4368
75-2973	234-9005
75-2974	234-9017
75-2975	234-4220
75-2976	234-4352
75-2977	234-4729

CARQUEST	DENSO
75-2978	234-4730
75-2979	234-4092
75-2980	234-4443
75-2982	234-9066
75-2984	234-4730
75-2986	234-9041
75-2987	234-4064
75-2989	234-9057
75-2990	234-9042
75-2993	234-5003
75-2994	234-4816
75-2997	234-4411
75-2998	234-4412
75-2999	234-4587
75-3000	234-4588
75-3001	234-4771
75-3003	234-4718
75-3004	234-4745
75-3005	234-4587
75-3006	234-4546
75-3007	234-4410
75-3009	234-4739
75-3010	234-4738
75-3011	234-4656
75-3013	234-4309
75-3015	234-4296
75-3016	234-4312
75-3017	234-4312
75-3018	234-4301
75-3019	234-4308
75-3020	234-4301
75-3021	234-4310
75-3022	234-4311
75-3023	234-4308
75-3024	234-4295
75-3025	234-1011
75-3027	234-4285
75-3029	234-4119
75-3031	234-4346
75-3033	234-4108
75-3045	234-4063
75-3047	234-4668
75-3048	234-4287
75-3049	234-4064
75-3051	234-4167
75-3052	234-4168
75-3053	234-4509
75-3054	234-9042
75-3055	234-9042
75-3058	234-4733
75-3059	234-4655
75-3060	234-4280



CARQUEST	DENSO
75-3061	234-4741
75-3063	234-4631
75-3064	234-4026
75-3065	234-4317
75-3066	234-4656
75-3070	234-4642
75-3071	234-4281
75-3072	234-4741
75-3073	234-4281
75-3074	234-4277
75-3075	234-4642
75-3076	234-4633
75-3077	234-4656
75-3079	234-4741
75-3080	234-4633
75-3082	234-4742
75-3083	234-4741
75-3084	234-4657
75-3085	234-4633
75-3086	234-4742
75-3088	234-4383
75-3089	234-4362
75-3090	234-4383
75-3091	234-4378
75-3092	234-4639
75-3094	234-4641
75-3096	234-4316
75-3097	234-4652
75-3098	234-4741
75-3103	234-4503
75-3104	234-4623
75-3105	234-9042
75-3107	234-9056
75-3112	234-4858
75-3113	234-4858
75-3114	234-4371
75-3115	234-5430
75-3116	234-4190
75-3117	234-4190
75-3120	234-4191
75-3121	234-4192
75-3122	234-4192
75-3123	234-4191
75-3124	234-4193
75-3125	234-4435
75-3126	234-4166
75-3127	234-4166
75-3128	234-4194
75-3129	234-4434
75-3130	234-4194
75-3131	234-4194
75-3133	234-4401

CARQUEST	DENSO
75-3136	234-5061
75-3203	234-4916
75-3208	234-1055
75-3209	234-1024
75-3210	234-1053
75-3211	234-2051
75-3214	234-4261
75-3216	234-3150
75-3217	234-3107
75-3218	234-4042
75-3219	234-4034
75-3221	234-3123
75-3228	234-4271
75-3229	234-4269
75-3230	234-3307
75-3231	234-3310
75-3232	234-4078
75-3234	234-1056
75-3235	234-4181
75-3236	234-4182
75-3237	234-4183
75-3238	234-4183
75-3239	234-4031
75-3240	234-4226
75-3241	234-4470
75-3242	234-4470
75-3247	234-3113
75-3248	234-4719
75-3250	234-9015
75-3252	234-4090
75-3255	234-4204
75-3256	234-4121
75-3257	234-9011
75-3258	234-2002
75-3260	234-3107
75-3263	234-9020
75-3264	234-4434
75-3266	234-4798
75-3267	234-9016
75-3270	234-4696
75-3272	234-4816
75-3273	234-2038
75-3274	234-4084
75-3275	234-4222
75-3276	234-4221
75-3277	234-4736
75-3278	234-4672
75-3279	234-4683
75-3288	234-4899
75-3291	234-4812
75-3295	234-4809
75-3296	234-4911

CARQUEST	DENSO
75-3297	234-4923
75-3311	234-5702
75-3314	234-5127
75-3315	234-5117
75-3326	234-5060
75-3327	234-5002
75-3328	234-5133
75-3338	234-4695
75-3341	234-1000
75-3348	234-9150
75-3350	234-4028
75-3355	234-4154
75-3359	234-4732
75-3361	234-9018
75-3362	234-9019
75-3363	234-4509
75-3364	234-4797
75-3366	234-4105
75-3367	234-4033
75-3369	234-4785
75-3370	234-4587
75-3371	234-4105
75-3372	234-4225
75-3373	234-4450
75-3374	234-4396
75-3376	234-9102
75-3377	234-4349
75-3378	234-4166
75-3379	234-4199
75-3380	234-4756
75-3381	234-4746
75-3384	234-4668
75-3386	234-4378
75-3389	234-4119
75-3390	234-4593
75-3391	234-4597
75-3392	234-4108
75-3396	234-4230
75-3397	234-4457
75-3398	234-4297
75-3399	234-4313
75-3400	234-3051
75-3401	234-5120
75-3403	234-4408
75-3404	234-4409
75-3405	234-4368
75-3407	234-5010
75-3409	234-4041
75-3410	234-4332
75-3413	234-4613
75-3416	234-9120
75-3417	234-9047





CARQUEST	DENSO
75-3418	234-9018
75-3419	234-9120
75-3420	234-4282
75-3422	234-4732
75-3423	234-4732
75-3424	234-4732
75-3425	234-4447
75-3426	234-4446
75-3427	234-4732
75-3429	234-4434
75-3430	234-4734
75-3431	234-4268
75-3432	234-4267
75-3433	234-4731
75-3434	234-4222
75-3435	234-4105
75-3436	234-4080
75-3437	234-4349
75-3438	234-4349
75-3439	234-4235
75-3440	234-4076
75-3441	234-4614
75-3443	234-4720
75-3445	234-4424
75-3448	234-4450
75-3449	234-4755
75-3450	234-9020
75-3451	234-4234
75-3453	234-4315
75-3454	234-4314
75-3456	234-4636
75-3457	234-4738
75-3458	234-4626
75-3459	234-4658
75-3460	234-4202
75-3461	234-4950
75-3462	234-2065
75-3463	234-4694
75-3464	234-4142
75-3465	234-4472
75-3466	234-3109
75-3467	234-4422
75-3468	234-4421
75-3469	234-4150
75-3471	234-4624
75-3472	234-4048
75-3474	234-4037
75-3475	234-4473
75-3476	234-4473
75-3477	234-4470
75-3479	234-4371
75-3480	234-4375

CARQUEST	DENSO
75-3481	234-9030
75-3482	234-4117
75-3487	234-5010
75-3489	234-5010
75-3490	234-4292
75-3492	234-4329
75-3493	234-9085
75-3495	234-4390
75-3496	234-4282
75-3497	234-9010
75-3498	234-9121
75-3499	234-9122
75-3501	234-4798
75-3502	234-4732
75-3504	234-9064
75-3506	234-9065
75-3507	234-3113
75-3509	234-9064
75-3510	234-4354
75-3511	234-9041
75-3512	234-9042
75-3513	234-9047
75-3514	234-9042
75-3515	234-9057
75-3516	234-4803
75-3517	234-4139
75-3518	234-9052
75-3520	234-4802
75-3523	234-9054
75-3524	234-4504
75-3525	234-9051
75-3526	234-4260
75-3529	234-9051
75-3530	234-5006
75-3531	234-4865
75-3532	234-4861
75-3536	234-4901
75-3537	234-4897
75-3538	234-4893
75-3539	234-4899
75-3541	234-4883
75-3542	234-4863
75-3543	234-4894
75-3544	234-4893
75-3545	234-4864
75-3546	234-4809
75-3547	234-4865
75-3548	234-4808
75-3549	234-4809
75-3552	234-4835
75-3553	234-4912
75-3554	234-4910

CARQUEST	DENSO
75-3557	234-4828
75-3559	234-4850
75-3560	234-4815
75-3561	234-4816
75-3564	234-4818
75-3565	234-4881
75-3567	234-5096
75-3571	234-5703
75-3572	234-5700
75-3573	234-5045
75-3574	234-5074
75-3576	234-5701
75-3578	234-5004
75-3579	234-5137
75-3580	234-5137
75-3581	234-5028
75-3582	234-5073
75-3585	234-5132
75-3586	234-5134
75-3588	234-5060
75-3589	234-5005
75-3590	234-5108
75-3592	234-4624
75-3593	234-4284
75-3595	234-9050
75-3596	234-4687
75-3597	234-4481
75-3598	234-5134
75-3599	234-5134
75-3603	234-4479
75-3604	234-5048
75-3607	234-4169
75-3608	234-3201
75-3609	234-5091
75-3611	234-4192
75-3612	234-4852
75-3613	234-4191
75-3614	234-4191
75-3615	234-4191
75-3616	234-9075
75-3617	234-4265
75-3618	234-4266
75-3619	234-4427
75-3620	234-9150
75-3621	234-4734
75-3622	234-4450
75-3628	234-4376
75-3629	234-4752
75-3633	234-4292
75-3634	234-4292
75-3635	234-9063
75-3637	234-9126



CARQUEST	DENSO
75-3638	234-4350
75-3639	234-9063
75-3640	234-4358
75-3641	234-9064
75-3643	234-5010
75-3646	234-9040
75-3647	234-9065
75-3648	234-4353
75-3649	234-4368
75-3650	234-4364
75-3651	234-4603
75-3654	234-9041
75-3655	234-9050
75-3657	234-4260
75-3658	234-9051
75-3659	234-4261
75-3660	234-4260
75-3661	234-4502
75-3662	234-4261
75-3663	234-4149
75-3664	234-9042
75-3665	234-9051
75-3666	234-4260
75-3667	234-4260
75-3669	234-9041
75-3670	234-9051
75-3671	234-9058
75-3672	234-4806
75-3673	234-4521
75-3674	234-4810
75-3675	234-4880
75-3676	234-4598
75-3677	234-4881
75-3678	234-4521
75-3679	234-4518
75-3680	234-4506
75-3681	234-4339
75-3682	234-4285
75-3683	234-4561
75-3684	234-4331
75-3685	234-4249
75-3686	234-4668
75-3688	234-4339
75-3689	234-4337
75-3690	234-4678
75-3691	234-4236
75-3692	234-4112
75-3693	234-5002
75-3694	234-4335
75-3695	234-4338
75-3696	234-5001
75-3697	234-4817

CARQUEST	DENSO
75-3698	234-4293
75-3699	234-4288
75-3700	234-4337
75-3701	234-4336
75-3702	234-4342
75-3703	234-4331
75-3704	234-4332
75-3705	234-4668
75-3706	234-4668
75-3707	234-4414
75-3708	234-4413
75-3709	234-4347
75-3710	234-4285
75-3713	234-4334
75-3714	234-4341
75-3715	234-4341
75-3716	234-4876
75-3717	234-5138
75-3718	234-9123
75-3719	234-4445
75-3720	234-9123
75-3721	234-4445
75-3722	234-4453
75-3723	234-4450
75-3724	234-5702
75-3726	234-4454
75-3729	234-4453
75-3730	234-4452
75-3732	234-4313
75-3733	234-4317
75-3734	234-4631
75-3735	234-4026
75-3736	234-4318
75-3737	234-4741
75-3738	234-4383
75-3739	234-4470
75-3740	234-4893
75-3741	234-4890
75-3742	234-4849
75-3748	234-4861
75-3749	234-4829
75-3751	234-4859
75-3754	234-4892
75-3755	234-4875
75-3756	234-4877
75-3757	234-4876
75-3758	234-4478
75-3759	234-4877
75-3760	234-4892
75-3763	234-4849
75-3767	234-4485
75-3772	234-5135

CARQUEST	DENSO
75-3773	234-5136
75-3774	234-5136
75-3776	234-5135
75-3778	234-5135
75-3781	234-5140
75-3783	234-5108
75-3787	234-5108
75-3788	234-5118
75-3789	234-5125
75-3793	234-5138
75-3794	234-5136
75-3795	234-5139
75-3796	234-5138
75-3798	234-5134
75-3802	234-5133
75-3803	234-5007
75-3804	234-5107
75-3806	234-4850
75-3808	234-4893
75-3810	234-4896
75-3811	234-4895
75-3812	234-4899
75-3813	234-5139
75-3814	234-5117
75-3816	234-4260
75-3817	234-4501
75-3818	234-9049
75-3819	234-9050
75-3820	234-9064
75-3821	234-4718
75-3822	234-4744
75-3823	234-9061
75-3825	234-4351
75-3826	234-4351
75-3828	234-4351
75-3829	234-5053
75-3830	234-5053
75-3835	234-4808
75-3843	234-5131
75-3845	234-5118
75-3846	234-5108
75-3847	234-5104
75-3848	234-5110
75-3852	234-4871
75-3858	234-5138
75-3859	234-5139
75-3860	234-5138
75-3861	234-4875
75-3862	234-5136
75-3865	234-4819
75-3866	234-4818
75-3867	234-4673



CARQUEST	DENSO
75-3868	234-4338
75-3869	234-4651
75-3872	234-4668
75-3873	234-4668
75-3881	234-4336
75-3883	234-4294
75-3886	234-4250
75-3887	234-9060
75-3888	234-9060
75-3889	234-9124
75-3891	234-9062
75-3892	234-4731
75-3893	234-4358
75-3894	234-4359
75-3895	234-4439
75-3896	234-4433
75-3897	234-4854
75-3898	234-4272
75-3899	234-4854
75-3900	234-4438
75-3901	234-4194
75-3902	234-9072
75-3903	234-4380
75-3905	234-4951
75-3906	234-5700
75-3907	234-9125
75-3908	234-4851
75-3909	234-4488
75-3910	234-5136
75-3912	234-5062
75-3913	234-9070
75-3914	234-9071
75-3915	234-9073
75-3917	234-4381
75-3919	234-4380
75-3922	234-4289
75-3929	234-9122
75-3930	234-4732
75-3931	234-4732
75-3932	234-4732
75-3933	234-4149
75-3934	234-9122
75-3935	234-9122
75-3936	234-4233
75-3938	234-4624
75-3939	234-4260
75-3942	234-4260
75-3944	234-4516
75-3945	234-4512
75-3946	234-4149
75-3948	234-4624
75-3949	234-4069

CARQUEST	DENSO
75-3952	234-9052
75-3953	234-4041
75-3954	234-9008
75-3960	234-5115
75-3962	234-5102
75-3965	234-4452
75-3967	234-4242
75-3968	234-4256
75-3974	234-4001
75-3975	234-4609
75-3979	234-4370
75-3981	234-4372
75-3982	234-4149
75-3983	234-4509
75-3984	234-4519
75-3986	234-4064
75-3987	234-4515
75-3988	234-9042
75-3989	234-9041
75-3990	234-9050
75-3991	234-9052
75-3992	234-9058
75-3993	234-5097
75-3998	234-4373
75-4002	234-4266
75-4003	234-9074
75-4007	234-4724
75-4008	234-5702
75-4009	234-4393
75-4010	234-4393
75-4012	234-4329
75-4013	234-5011
75-4014	234-4394
75-4015	234-9087
75-4016	234-4752
75-4019	234-4390
75-4020	234-5014
75-4021	234-4395
75-4022	234-9088
75-4023	234-4340
75-4024	234-5015
75-4025	234-4392
75-4026	234-4738
75-4027	234-4656
75-4028	234-4631
75-4029	234-4319
75-4030	234-9032
75-4031	234-4387
75-4032	234-4423
75-4033	234-4450
75-4034	234-4734
75-4035	234-9150

CARQUEST	DENSO
75-4037	234-9152
75-4038	234-4453
75-4039	234-4452
75-4041	234-9152
75-4042	234-4452
75-4043	234-9151
75-4044	234-4454
75-4045	234-4454
75-4046	234-4451
75-4047	234-4653
75-4048	234-5129
75-4049	234-4446
75-4051	234-4920
75-4052	234-4917
75-4053	234-5115
75-4054	234-5036
75-4055	234-4285
75-4056	234-4407
75-4057	234-4650
75-4058	234-4066
75-4059	234-4345
75-4060	234-4646
75-4061	234-4104
75-4062	234-4286
75-4063	234-4647
75-4064	234-4108
75-4065	234-4867
75-4066	234-4865
75-4067	234-5701
75-4068	234-5028
75-4070	234-5148
75-4071	234-4812
75-4072	234-4874
75-4073	234-5103
75-4074	234-4808
75-4075	234-4753
75-4076	234-4441
75-4077	234-4485
75-4079	234-4753
75-4080	234-4809
75-4081	234-4833
75-4082	234-4498
75-4083	234-5102
75-4084	234-5117
75-4085	234-4858
75-4086	234-5019
75-4087	234-5008
75-4088	234-4231
75-4089	234-5045
75-4094	234-4891
75-4095	234-4900
75-4099	234-4879



CARQUEST	DENSO
75-4100	234-4815
75-4101	234-4815
75-4103	234-4522
75-4104	234-4896
75-4105	234-4881
75-4106	234-4818
75-4107	234-4474
75-4110	234-4475
75-4111	234-4523
75-4116	234-4821
75-4118	234-4073
75-4119	234-4213
75-4120	234-4821
75-4121	234-4892
75-4122	234-4876
75-4128	234-4878
75-4130	234-4876
75-4131	234-5108
75-4133	234-5138
75-4134	234-5136
75-4141	234-5009
75-4142	234-5036
75-4147	234-5034
75-4151	234-5026
75-4154	234-5027
75-4155	234-5036
75-4156	234-5119
75-4158	234-5023
75-4159	234-5024
75-4160	234-5086
75-4165	234-5107
75-4167	234-5076
75-4172	234-3070
75-4175	234-5135
75-4176	234-5023
75-4178	234-5025
75-4179	234-5140
75-4180	234-5113
75-4182	234-4185
75-4185	234-3006
75-4186	234-3015
75-4187	234-4198
75-4188	234-1006
75-4189	234-1008
75-4190	234-1051
75-4191	234-4054
75-4192	234-4056
75-4193	234-4066
75-4194	234-4072
75-4195	234-4100
75-4197	234-4114
75-4198	234-4116

CARQUEST	DENSO
75-4199	234-4136
75-4200	234-4156
75-4201	234-4158
75-4202	234-4165
75-4203	234-4188
75-4204	234-4195
75-4205	234-4227
75-4206	234-4254
75-4207	234-4255
75-4208	234-4257
75-4209	234-4264
75-4210	234-4278
75-4211	234-4291
75-4212	234-4300
75-4213	234-4303
75-4214	234-4304
75-4215	234-4305
75-4216	234-4306
75-4217	234-4377
75-4218	234-4379
75-4219	234-4385
75-4220	234-4386
75-4221	234-4388
75-4222	234-4400
75-4223	234-4416
75-4224	234-4430
75-4225	234-4465
75-4226	234-4476
75-4227	234-4487
75-4228	234-4513
75-4229	234-4539
75-4230	234-4540
75-4231	234-4643
75-4232	234-4644
75-4233	234-4745
75-4234	234-4761
75-4235	234-9012
75-4236	234-9022
75-4237	234-9026
75-4238	234-9027
75-4239	234-9029
75-4240	234-9031
75-4241	234-9033
75-4242	234-9034
75-4243	234-9035
75-4244	234-9036
75-4245	234-9037
75-4246	234-9038
75-4247	234-9039
75-4248	234-9048
75-4249	234-9059
75-4250	234-9067

CARQUEST	DENSO
75-4251	234-9068
75-4252	234-9069
75-4253	234-9076
75-4254	234-9077
75-4255	234-9078
75-4256	234-9079
75-4257	234-9080
75-4258	234-9081
75-4259	234-9082
75-4260	234-9083
75-4261	234-9084
75-4262	234-9086
75-4263	234-9089
75-4264	234-9090
75-4265	234-9091
75-4266	234-9092
75-4267	234-9093
75-4268	234-9094
75-4269	234-9095
75-4270	234-9096
75-4271	234-9097
75-4272	234-9098
75-4273	234-9099
75-4274	234-9100
75-4275	234-9101
75-4276	234-9103
75-4277	234-9104
75-4278	234-9105
75-4279	234-9106
75-4280	234-9107
75-4281	234-9108
75-4282	234-9109
75-4283	234-9111
75-4284	234-9112
75-4285	234-9113
75-4286	234-9114
75-4287	234-9115
75-4288	234-9116
75-4289	234-9117
75-4290	234-9118
75-4291	234-9119
75-4292	234-9299
75-4293	234-4650
75-4294	234-4243
75-4295	234-4246
75-4296	234-4252
75-4297	234-4253
75-4298	234-4258
75-4299	234-4612
75-4300	234-4106
75-4301	234-3002
75-4302	234-4107



CARQUEST	DENSO
75-4303	234-4045
75-4304	234-4609
75-4305	234-4607
75-4306	234-4612
75-4307	234-4041
75-4308	234-4612
75-4309	234-4045
75-4310	234-4279
75-4311	234-4610
75-4312	234-4419
75-4313	234-4490
75-4314	234-4611
75-4315	234-4021
75-4316	234-4082
75-4317	234-4002
75-4318	234-4075
75-4319	234-4078
75-4320	234-4078
75-4321	234-4076
75-4322	234-4418
75-4323	234-4013
75-4324	234-4002
75-4325	234-4005
75-4326	234-4767
75-4327	234-4417
75-4328	234-4614
75-4329	234-4075
75-4330	234-4075
75-4331	234-4076
75-4332	234-4008
75-4333	234-4077
75-4334	234-4078
75-4335	234-4587
75-4336	234-4077
75-4337	234-4768
75-4338	234-3129
75-4339	234-4622
75-4340	234-3129
75-4342	234-4442
75-4343	234-4461
75-4344	234-4351
75-4345	234-4544
75-4346	234-4537
75-4347	234-4535
75-4348	234-4534
75-4349	234-4011
75-4350	234-4466
75-4351	234-4039
75-4352	234-4355
75-4353	234-4296
75-4354	234-4352
75-4355	234-4092

CARQUEST	DENSO
75-4356	234-4094
75-4357	234-4122
75-4358	234-5430
75-4359	234-5012
75-4360	234-5013
75-4361	234-5033
75-4362	234-5018
75-4363	234-5047
75-4364	234-5043
75-4365	234-5164
75-4366	234-5029
75-4367	234-5081
75-4368	234-5032
75-4369	234-5098
75-4370	234-5099
75-4371	234-5038
75-4372	234-5039
75-4373	234-5030
75-4374	234-5030
75-4375	234-5040
75-4376	234-5012
75-4377	234-5042
75-4378	234-4363
75-4380	234-4123
75-4381	234-4954
75-4382	234-4462
75-4383	234-4461
75-4384	234-4461
75-4385	234-4461
75-4386	234-4461
75-4387	234-4218
75-4388	234-4351
75-4390	234-4391
75-4391	234-4118
75-4392	234-4382
75-4393	234-4504
75-4394	234-4260
75-4395	234-4389
75-4396	234-4622
75-4397	234-4306
75-4398	234-4467
75-4399	234-4543
75-4400	234-3128
75-4402	234-3132
75-4404	234-4117
75-4405	234-4432
75-4406	234-4425
75-4407	234-4426
75-4408	234-4420
75-4409	234-4247
75-4410	234-4120
75-4411	234-4238

CARQUEST	DENSO
75-4412	234-4237
75-4413	234-4448
75-4414	234-4444
75-4415	234-4449
75-4416	234-4458
75-4417	234-4456
75-4418	234-4463
75-4419	234-4455
75-4420	234-5007
75-4421	234-4245
75-4422	234-4244
75-4423	234-4283
75-4424	234-4815
75-4425	234-4244
75-4427	234-4891
75-4428	234-4821
75-4429	234-4863
75-4430	234-4832
75-4432	234-4840
75-4433	234-5108
75-4434	234-5090
75-4437	234-5036
75-4441	234-5071
75-4442	234-4198
75-4443	234-4197
75-4444	234-1007
75-4446	234-4889
75-4447	234-4284
75-4448	234-5097
75-4449	234-5065
75-4450	234-5133
75-4451	234-5076
75-4452	234-1040
75-4453	234-4837
75-4454	234-3131
75-4455	234-3019
75-4456	234-4429
75-4457	234-4856
75-4458	234-4855
75-4459	234-4298
75-4460	234-4290
75-4461	234-1003
75-4462	234-2011
75-4463	234-2013
75-4464	234-2057
75-4465	234-2066
75-4466	234-2069
75-4467	234-4025
75-4468	234-4263
75-4469	234-4284
75-4470	234-4464
75-4471	234-4561



CARQUEST	DENSO
75-4472	234-4616
75-4473	234-4857
75-4474	234-4903
75-4475	234-4414
75-4476	234-4482
75-4477	234-4347
75-4478	234-4001
75-4479	234-3010
75-4480	234-4003
75-4481	234-4078
75-4482	234-4767
75-4483	234-4217
75-4484	234-4092
75-4485	234-4224
75-4486	234-4438
75-4487	234-4478
75-4488	234-4575
75-4489	234-4575
75-4490	234-4821
75-4491	234-4529
75-4492	234-4527
75-4493	234-4528
75-4494	234-4529
75-4495	234-5095
75-4496	234-5079
75-4497	234-5037
75-4498	234-5128
75-4499	234-5046
75-4500	234-5064
75-4501	234-5093
75-4502	234-5138
75-4503	234-5027
75-4504	234-5094
75-4505	234-5036
75-4506	234-5068
75-4507	234-5097
75-4508	234-5023
75-4509	234-5069
75-4510	234-4536
75-4511	234-5097
75-4512	234-4719
75-4514	234-4495
75-4515	234-4563
75-4516	234-4583
75-4517	234-4584
75-4518	234-4758
75-4519	234-4239
75-4520	234-4494
75-4521	234-4576
75-4522	234-4239
75-4523	234-4550
75-4524	234-4660

CARQUEST	DENSO
75-9127	234-9127
75-9128	234-9128
75-9129	234-9129
75-9130	234-9130
DELPHI	DENSO
ES20316	234-4001
ES2000	234-4222
ES10003	234-1025
ES10005	234-3005
ES10007	234-3011
ES10047	234-3004
ES10131	234-1003
ES10132	234-1003
ES10133	234-3002
ES10134	234-3001
ES10135	234-3007
ES10143	234-3042
ES10146	234-1010
ES10179	234-1002
ES10180	234-3003
ES10182	234-3116
ES10220	234-1012
ES10221	234-1012
ES10222	234-1014
ES10224	234-1051
ES10226	234-1008
ES10227	234-1005
ES10229	234-3000
ES10234	234-3016
ES10240	234-3019
ES10241	234-3000
ES10242	234-3019
ES10246	234-4088
ES10254	234-4674
ES10258	234-3082
ES10259	234-3081
ES10260	234-3081
ES10261	234-3028
ES10262	234-3018
ES10264	234-3023
ES10276	234-4712
ES10277	234-1000
ES10289	234-3028
ES10290	234-4670
ES10295	234-3079
ES10301	234-3083
ES10309	234-4661
ES10317	234-2051
ES10318	234-2052
ES10320	234-2055
ES10323	234-1003

DELPHI	DENSO
ES10331	234-3013
ES10333	234-4665
ES10348	234-2002
ES10353	234-4671
ES10358	234-4670
ES10366	234-3085
ES10377	234-3087
ES10383	234-3093
ES10384	234-3095
ES10387	234-3123
ES10392	234-1053
ES10394	234-2010
ES10399	234-4185
ES10403	234-4663
ES10406	234-4182
ES10421	234-1034
ES10439	234-3088
ES10449	234-4057
ES10456	234-3006
ES10462	234-3309
ES10465	234-2004
ES10477	234-3107
ES10497	234-3126
ES10533	234-1020
ES10559	234-2062
ES10568	234-4664
ES10574	234-4176
ES10579	234-4174
ES10580	234-4175
ES10581	234-4180
ES10582	234-4173
ES10583	234-4178
ES10584	234-4179
ES10587	234-1000
ES10590	234-3091
ES10591	234-4115
ES10596	234-4411
ES10628	234-1029
ES10629	234-3129
ES10632	234-4172
ES10638	234-2057
ES10649	234-4511
ES10650	234-2058
ES10657	234-4164
ES10659	234-3107
ES10664	234-2008
ES10671	234-1011
ES10672	234-1006
ES10674	234-1011
ES10675	234-1022
ES10676	234-2060
ES10677	234-2014



DELPHI	DENSO
ES10678	234-2067
ES10680	234-3075
ES10681	234-3086
ES10685	234-3010
ES10686	234-3015
ES10687	234-3108
ES10688	234-3106
ES10689	234-1011
ES10690	234-3121
ES10694	234-3128
ES10718	234-4037
ES10730	234-3099
ES10735	234-4036
ES10740	234-4041
ES10743	234-4687
ES10744	234-3307
ES10751	234-5010
ES10820	234-4697
ES10822	234-1056
ES10826	234-4183
ES10827	234-4211
ES10835	234-4596
ES10840	234-4216
ES10841	234-4045
ES10844	234-4022
ES10849	234-1005
ES10852	234-4693
ES10853	234-4690
ES10856	234-4117
ES10857	234-4683
ES10880	234-4296
ES10882	234-4410
ES10883	234-4191
ES10888	234-4074
ES10890	234-4125
ES10895	234-4694
ES10896	234-4696
ES10897	234-4431
ES10898	234-4432
ES10899	234-4672
ES10903	234-4147
ES10908	234-4412
ES10909	234-4119
ES10910	234-4371
ES10914	234-4473
ES10915	234-4375
ES10916	234-4598
ES10917	234-4545
ES10918	234-4785
ES10920	234-5004
ES10921	234-5028
ES10922	234-5045

DELPHI	DENSO
ES10923	234-5002
ES10924	234-5001
ES10925	234-5702
ES10926	234-5006
ES10927	234-5430
ES10928	234-5027
ES10929	234-9007
ES10930	234-9010
ES10931	234-9021
ES10932	234-9013
ES10933	234-9026
ES10934	234-9008
ES10935	234-9012
ES10936	234-9015
ES10937	234-9004
ES10938	234-9018
ES10939	234-9016
ES10940	234-9040
ES10941	234-9064
ES10942	234-9034
ES10943	234-9122
ES10944	234-9001
ES10945	234-9002
ES10946	234-1055
ES10947	234-2015
ES10948	234-2011
ES10949	234-1020
ES10950	234-1030
ES10951	234-1024
ES10952	234-1055
ES10953	234-2013
ES10954	234-2005
ES10955	234-2068
ES10956	234-2069
ES10957	234-3033
ES10958	234-3113
ES10959	234-3110
ES10960	234-3130
ES10961	234-3131
ES10962	234-4181
ES10963	234-3004
ES10964	234-1008
ES10966	234-1001
ES11003	234-4587
ES11071	234-4439
ES11072	234-4433
ES11073	234-4380
ES11074	234-4381
ES11075	234-4107
ES11076	234-4382
ES11077	234-4858
ES11079	234-5036

DELPHI	DENSO
ES11080	234-5136
ES11081	234-5138
ES11082	234-5102
ES11083	234-5116
ES11084	234-3306
ES20000	234-4018
ES20001	234-4018
ES20002	234-4087
ES20003	234-4617
ES20004	234-4090
ES20005	234-4233
ES20006	234-4222
ES20007	234-4342
ES20008	234-4243
ES20009	234-4332
ES20011	234-4528
ES20012	234-4153
ES20013	234-4668
ES20014	234-4001
ES20015	234-4002
ES20016	234-4003
ES20017	234-4004
ES20018	234-4006
ES20019	234-1007
ES20020	234-4011
ES20022	234-4012
ES20023	234-4012
ES20024	234-4013
ES20025	234-4607
ES20026	234-4016
ES20027	234-4130
ES20028	234-4019
ES20029	234-4020
ES20030	234-4026
ES20031	234-4031
ES20032	234-4051
ES20033	234-4052
ES20034	234-4053
ES20035	234-4055
ES20036	234-4055
ES20037	234-4067
ES20038	234-4068
ES20039	234-4070
ES20040	234-4037
ES20041	234-4028
ES20042	234-4075
ES20043	234-4076
ES20044	234-4077
ES20045	234-4008
ES20046	234-4079
ES20047	234-4005
ES20048	234-4021



DELPHI	DENSO
ES20049	234-4082
ES20050	234-4083
ES20051	234-4025
ES20052	234-4065
ES20053	234-4065
ES20054	234-4602
ES20055	234-4703
ES20056	234-4197
ES20057	234-4325
ES20058	234-4098
ES20059	234-4015
ES20060	234-4061
ES20061	234-4634
ES20062	234-4635
ES20063	234-4092
ES20064	234-4046
ES20065	234-4612
ES20066	234-4145
ES20067	234-4141
ES20068	234-4142
ES20069	234-4039
ES20070	234-1056
ES20071	234-4153
ES20072	234-4153
ES20073	234-4649
ES20074	234-4133
ES20075	234-4024
ES20076	234-4017
ES20077	234-4637
ES20078	234-4027
ES20079	234-4639
ES20080	234-4633
ES20081	234-4026
ES20082	234-4280
ES20083	234-4656
ES20084	234-4655
ES20085	234-4652
ES20086	234-4048
ES20087	234-4140
ES20088	234-4103
ES20089	234-4029
ES20090	234-4768
ES20091	234-4654
ES20092	234-4769
ES20093	234-4030
ES20094	234-4255
ES20095	234-4244
ES20096	234-4287
ES20097	234-4102
ES20098	234-4089
ES20099	234-4328
ES20100	234-4043

DELPHI	DENSO
ES20101	234-4706
ES20102	234-4597
ES20103	234-4069
ES20104	234-4045
ES20105	234-4764
ES20106	234-4767
ES20107	234-4104
ES20108	234-4830
ES20109	234-4033
ES20110	234-4108
ES20111	234-4648
ES20112	234-4049
ES20113	234-4285
ES20114	234-4292
ES20115	234-4822
ES20116	234-4066
ES20117	234-4112
ES20118	234-4260
ES20119	234-4154
ES20120	234-4751
ES20121	234-4126
ES20122	234-4041
ES20123	234-4752
ES20124	234-4105
ES20125	234-4707
ES20126	234-4062
ES20127	234-4074
ES20128	234-4224
ES20129	234-4323
ES20130	234-4065
ES20131	234-4323
ES20132	234-4701
ES20133	234-4081
ES20134	234-4252
ES20135	234-4063
ES20136	234-4601
ES20137	234-4614
ES20138	234-4615
ES20139	234-4616
ES20140	234-4618
ES20141	234-4094
ES20142	234-4094
ES20143	234-4702
ES20144	234-4067
ES20145	234-4041
ES20146	234-4298
ES20147	234-4198
ES20148	234-4032
ES20149	234-4614
ES20151	234-4401
ES20152	234-4144
ES20154	234-4288

DELPHI	DENSO
ES20156	234-4048
ES20157	234-4064
ES20158	234-4851
ES20159	234-4035
ES20160	234-4812
ES20161	234-4297
ES20162	234-4267
ES20163	234-4864
ES20164	234-4812
ES20165	234-4860
ES20166	234-4809
ES20167	234-4862
ES20168	234-4753
ES20169	234-4808
ES20170	234-4852
ES20171	234-4423
ES20172	234-4297
ES20173	234-4892
ES20174	234-4893
ES20175	234-4523
ES20176	234-4363
ES20177	234-4661
ES20178	234-4753
ES20179	234-4143
ES20180	234-4503
ES20181	234-4880
ES20182	234-4152
ES20184	234-4701
ES20185	234-4710
ES20186	234-4040
ES20187	234-4716
ES20188	234-4132
ES20189	234-4134
ES20190	234-4302
ES20191	234-4060
ES20192	234-4155
ES20193	234-4189
ES20194	234-4138
ES20195	234-4317
ES20196	234-4747
ES20197	234-4587
ES20198	234-4230
ES20199	234-4746
ES20200	234-4653
ES20201	234-4749
ES20202	234-4215
ES20203	234-4034
ES20204	234-4042
ES20205	234-4727
ES20206	234-4217
ES20207	234-4010
ES20208	234-4771





DELPHI	DENSO
ES20209	234-4621
ES20210	234-4772
ES20211	234-4035
ES20212	234-4734
ES20213	234-4149
ES20214	234-4434
ES20215	234-4122
ES20216	234-4326
ES20217	234-4776
ES20218	234-4775
ES20219	234-4445
ES20220	234-4301
ES20221	234-4166
ES20222	234-4457
ES20223	234-4447
ES20224	234-4139
ES20225	234-4509
ES20226	234-4502
ES20227	234-4166
ES20228	234-4232
ES20316	234-4070
ES20317	234-4012
ES20318	234-4001
ES20319	234-4343
ES20320	234-4254
ES20321	234-4008
ES20322	234-4099
ES20324	234-4137
ES20325	234-4260
ES20326	234-4260
ES20327	234-4260
ES20328	234-4401
ES20352	234-4236
ES20354	234-4881
ES20355	234-4331
ES20356	234-4350
ES20357	234-4854
ES20358	234-4370
ES20359	234-4798
ES20360	234-4624
ES20361	234-4272
ES20362	234-4329
ES20363	234-4241
ES20364	234-4136
ES20365	234-4231
ES20366	234-4235
ES20367	234-4754
ES20368	234-4876
ES20369	234-4351
ES20370	234-4270
ES20371	234-4390
ES20372	234-4167

DELPHI	DENSO
ES20373	234-4225
ES20374	234-4485
ES20375	234-4040
ES20376	234-4875
ES20377	234-4450
ES20378	234-4485
ES20380	234-4359
ES20381	234-4462
ES20382	234-4257
ES20383	234-4103
ES20385	234-4855
ES20386	234-4399
ES20387	234-4750
ES20389	234-4396
ES20390	234-4392
ES20391	234-4097
ES20393	234-4140
ES20394	234-4327
ES20395	234-4713
ES20396	234-4324
ES20397	234-4903
ES20403	234-4358
ES20407	234-4490
ES20408	234-4442
ES20409	234-4489
ES20410	234-4400
ES20411	234-4218
ES20412	234-4316
ES20413	234-4488
ES20414	234-4114
ES20415	234-4537
ES20416	234-4529
ES20418	234-4876
ES20419	234-4165
ES20420	234-4518
ES20421	234-4479
ES20422	234-4340
MOTORCRAFT	DENSO
DY568	234-3002
DY569	234-3001
DY570	234-3001
DY571	234-3001
DY572	234-1003
DY573	234-1004
DY574	234-3073
DY575	234-3002
DY576	234-3007
DY577	234-3007
DY578	234-1019
DY580	234-1003
DY582	234-1019

MOTORCRAFT	DENSO
DY583	234-1019
DY584	234-3073
DY585	234-4609
DY586	234-4611
DY595	234-1020
DY598	234-1020
DY599	234-4609
DY600	234-3002
DY601	234-4609
DY604	234-3007
DY605	234-3002
DY606	234-3002
DY607	234-3007
DY608	234-3073
DY609	234-3073
DY613	234-1010
DY618	234-4070
DY619	234-4611
DY622	234-1019
DY628	234-1010
DY638	234-4070
DY641	234-4001
DY642	234-4071
DY643	234-4070
DY649	234-4001
DY658	234-4071
DY659	234-4070
DY661	234-4609
DY664	234-3126
DY665	234-3126
DY666	234-3126
DY671	234-4068
DY672	234-4068
DY673	234-4067
DY684	234-4127
DY686	234-4127
DY698	234-4001
DY699	234-4001
DY703	234-4001
DY705	234-4071
DY706	234-4070
DY709	234-4127
DY710	234-4071
DY711	234-4070
DY712	234-4071
DY713	234-4070
DY721	234-4610
DY722	234-4609
DY728	234-4071
DY729	234-4070
DY730	234-4001
DY731	234-4071



MOTORCRAFT	DENSO
DY732	234-4127
DY733	234-4070
DY734	234-4127
DY737	234-4016
DY738	234-4607
DY743	234-4606
DY744	234-4127
DY745	234-4609
DY749	234-4127
DY758	234-4702
DY760	234-4605
DY761	234-4610
DY762	234-4609
DY764	234-4127
DY775	234-4016
DY776	234-3084
DY781	234-4037
DY782	234-4067
DY783	234-3010
DY784	234-4041
DY785	234-3084
DY786	234-4628
DY787	234-4627
DY788	234-3075
DY790	234-4068
DY791	234-4067
DY800	234-4127
DY804	234-4070
DY805	234-4071
DY806	234-4127
DY811	234-4702
DY813	234-4037
DY815	234-4071
DY816	234-4068
DY817	234-4039
DY820	234-4779
DY821	234-4046
DY823	234-4045
DY828	234-4607
DY829	234-3002
DY831	234-4127
DY832	234-4071
DY834	234-4046
DY835	234-4401
DY843	234-4070
DY847	234-4403
DY850	234-4045
DY854	234-4701
DY856	234-4702
DY857	234-4779
DY858	234-4701
DY859	234-4779

MOTORCRAFT	DENSO
DY862	234-4070
DY877	234-4046
DY878	234-4045
DY891	234-4701
DY992	234-4401
DY993	234-4371
DY994	234-4370
DY997	234-4374
DY1005	234-4187
DY1009	234-4371
DY1011	234-4610
DY1013	234-4609
DY1015	234-4609
DY1017	234-4609
DY1018	234-4610
DY1021	234-4610
DY1026	234-4610
DY1028	234-4107
DY1031	234-4375
DY1033	234-4610
DY1034	234-4609
DY1036	234-4370
DY1037	234-4371
DY1038	234-4610
DY1039	234-4046
DY1040	234-4045
DY1042	234-4374
DY1043	234-4375
DY1045	234-4106
DY1047	234-4609
DY1048	234-4609
DY1052	234-4609
DY1053	234-4610
DY1056	234-4610
DY1057	234-4071
DY1058	234-4610
DY1060	234-4373
DY1063	234-4127
DY1064	234-4372
DY1065	234-4370
DY1066	234-4371
DY1068	234-4401
DY1069	234-4403
DY1070	234-4609
DY1071	234-4609
DY1072	234-4609
DY1081	234-4071
DY1083	234-4611
DY1084	234-4609
DY1085	234-4611
DY1086	234-4610
DY1087	234-4609

MOTORCRAFT	DENSO
DY1088	234-4611
DY1089	234-4609
DY1090	234-4610
DY1091	234-4609
DY1092	234-4070
DY1093	234-4127
DY1094	234-4070
DY1095	234-4070
DY1096	234-3075
DY1097	234-3089
DY1098	234-4071
DY1099	234-4610
DY1100	234-4611
DY1101	234-4609
DY1102	234-4608
DY1103	234-4608
DY1104	234-4610
DY1110	234-4609
DY1111	234-5097
DY1119	234-4609
DY1120	234-5113
DY1122	234-5108
DY1130	234-5032
DY1131	234-4609
DY1132	234-4609
DY1140	234-5038
DY1141	234-5039
DY1142	234-4419
DY1150	234-4493
DY1152	234-4555
DY1153	234-4490
DY1155	234-4489
DY1158	234-4493
DY1161	234-4494
DY1162	234-4490
DY1163	234-4575
DY1165	234-5113
DY1166	234-5076
DY1167	234-4491
DY1168	234-4492
DY1169	234-4575
DY1170	234-5097
DY1172	234-4740
DY1173	234-4491
DY1174	234-4490
DY1175	234-4489
DY1176	234-4490
DY1178	234-5038
DY1179	234-4575
DY1180	234-4495
DY1181	234-4576
DY1182	234-5097



MOTORCRAFT	DENSO
DY1183	234-5113
DY1184	234-5076
DY1185	234-5113
DY1189	234-4575
DY1192	234-4936
DY1193	234-5097
DY1199	234-5068
DY1200	234-4493
DY1202	234-4577
DY1203	234-4578
DY1252	234-5097
DY1255	234-5039
DYE693	234-1020
DYE702	234-3042
DYE704	234-3042
NTK	DENSO
21002	234-1001
21003	234-3005
21004	234-3011
21006	234-4012
21023	234-4249
21035	234-4289
21039	234-1022
21040	234-2060
21041	234-4235
21042	234-4108
21043	234-4066
21044	234-4285
21045	234-4646
21047	234-4650
21048	234-4647
21049	234-4112
21053	234-4104
21054	234-4119
21055	234-4287
21058	234-4294
21059	234-4243
21060	234-4246
21061	234-4252
21062	234-4253
21063	234-4347
21064	234-4250
21065	234-4258
21066	234-4256
21067	234-4526
21068	234-4530
21069	234-4526
21071	234-4762
21072	234-4762
21500	234-1025
21502	234-1029

NTK	DENSO
21503	234-1030
21504	234-2013
21506	234-4006
21507	234-4084
21508	234-4060
21509	234-4649
21510	234-4024
21511	234-4639
21512	234-4738
21513	234-4103
21514	234-4346
21516	234-4343
21517	234-4646
21518	234-4102
21519	234-4089
21521	234-4830
21523	234-4108
21524	234-4648
21525	234-4222
21527	234-4049
21528	234-4087
21529	234-4688
21530	234-4090
21531	234-4822
21532	234-4066
21533	234-4112
21535	234-4688
21536	234-4615
21537	234-4617
21538	234-4618
21539	234-4018
21541	234-3004
21543	234-4019
21544	234-4025
21545	234-4285
21546	234-4342
21547	234-4233
21548	234-4286
21549	234-4669
21550	234-4616
21553	234-2001
21555	234-4257
21556	234-4564
21558	234-4242
21559	234-4236
21560	234-4291
21561	234-4331
21562	234-4820
21563	234-4817
21564	234-4245
21565	234-4338
21566	234-4341

NTK	DENSO
21567	234-4335
21568	234-4254
21569	234-4244
21571	234-4565
21572	234-4283
21573	234-4647
21574	234-4441
21575	234-4819
21576	234-4561
21577	234-4529
22000	234-4628
22001	234-4612
22007	234-4371
22009	234-4609
22010	234-4016
22012	234-4106
22013	234-3002
22014	234-3001
22015	234-4107
22016	234-4001
22018	234-4394
22027	234-3126
22032	234-4606
22033	234-3010
22034	234-3084
22043	234-1010
22045	234-4373
22046	234-4372
22047	234-3073
22056	234-4611
22060	234-4045
22062	234-3009
22064	234-3085
22065	234-3008
22071	234-4609
22074	234-4607
22075	234-3086
22082	234-1014
22085	234-2006
22088	234-4067
22089	234-4067
22090	234-4041
22091	234-4041
22092	234-4068
22093	234-4612
22094	234-4039
22095	234-4037
22096	234-4044
22097	234-4040
22098	234-4041
22099	234-4612
22100	234-4397



NTK	DENSO
22101	234-4393
22102	234-4044
22103	234-4629
22104	234-4043
22106	234-4608
22113	234-4045
22114	234-4126
22115	234-4398
22116	234-4399
22117	234-4148
22118	234-4117
22119	234-4148
22120	234-4121
22124	234-4370
22125	234-4375
22126	234-4037
22129	234-4279
22130	234-4610
22132	234-4419
22133	234-4490
22134	234-4489
22135	234-4490
22136	234-4740
22137	234-4492
22138	234-4493
22139	234-4491
22500	234-4001
22501	234-4070
22502	234-4144
22503	234-4070
22504	234-4145
22505	234-4141
22506	234-4142
22507	234-4605
22510	234-4751
22513	234-4722
22514	234-4752
22516	234-4701
22519	234-4750
22521	234-4702
22523	234-4143
22524	234-4401
22528	234-4724
22531	234-4146
22532	234-4725
22533	234-4721
22534	234-1003
22535	234-4494
22536	234-4575
22537	234-4576
22538	234-4577
23001	234-4083

NTK	DENSO
23002	234-4021
23004	234-1002
23005	234-3003
23006	234-4082
23007	234-4002
23008	234-4075
23014	234-4078
23016	234-4078
23018	234-4598
23020	234-4083
23021	234-2007
23023	234-4003
23025	234-4076
23026	234-4412
23030	234-4418
23032	234-4013
23035	234-4014
23036	234-4002
23039	234-4077
23041	234-4005
23044	234-1000
23047	234-4082
23048	234-4078
23051	234-4410
23055	234-4614
23069	234-4767
23070	234-4417
23088	234-4078
23093	234-4002
23094	234-4013
23097	234-4614
23098	234-4078
23099	234-4078
23100	234-4075
23101	234-4075
23102	234-4076
23105	234-4021
23106	234-4079
23108	234-4028
23110	234-4008
23114	234-4597
23115	234-4076
23118	234-4002
23119	234-4003
23121	234-4076
23122	234-4115
23123	234-4614
23124	234-4008
23125	234-4232
23126	234-4077
23127	234-4115
23128	234-4078

NTK	DENSO
23129	234-4596
23130	234-4022
23131	234-4115
23132	234-4767
23133	234-4078
23134	234-4010
23135	234-4587
23137	234-4588
23138	234-4030
23139	234-4217
23140	234-4029
23141	234-4768
23142	234-4029
23143	234-4587
23144	234-4590
23145	234-4592
23146	234-4596
23148	234-4013
23151	234-4076
23152	234-4587
23155	234-4230
23158	234-4546
23159	234-4587
23160	234-4593
23161	234-4547
23162	234-4545
23163	234-4483
23164	234-4748
23165	234-4579
23500	234-1052
23501	234-2067
23502	234-3005
23506	234-4077
23509	234-4602
23511	234-4634
23512	234-4635
23513	234-4017
23514	234-4637
23515	234-4637
23516	234-4633
23517	234-4645
23518	234-4631
23519	234-4636
23520	234-4658
23521	234-4280
23522	234-4656
23523	234-4655
23524	234-4317
23525	234-4652
23526	234-4747
23527	234-4718
23529	234-4746



NTK	DENSO
23531	234-4768
23532	234-4653
23533	234-4654
23537	234-4749
23538	234-4216
23544	234-4764
23549	234-4633
23550	234-4741
23551	234-4135
23552	234-1003
23556	234-4719
23557	234-1021
23558	234-4026
23559	234-4027
23566	234-4880
23567	234-4073
23569	234-4411
24002	234-3122
24003	234-1011
24004	234-3309
24005	234-3121
24006	234-1012
24007	234-3129
24009	234-3086
24010	234-1020
24012	234-2004
24014	234-2006
24015	234-4086
24019	234-1020
24022	234-3042
24023	234-3085
24024	234-3123
24025	234-3129
24026	234-4358
24027	234-4067
24029	234-4037
24031	234-4081
24033	234-1006
24035	234-4035
24036	234-1040
24037	234-4035
24038	234-1008
24039	234-3087
24042	234-4094
24043	234-3075
24044	234-4511
24047	234-4622
24048	234-4350
24050	234-4631
24051	234-4837
24052	234-4020
24058	234-4032

NTK	DENSO
24059	234-4507
24061	234-4092
24062	234-3120
24063	234-3129
24064	234-3126
24065	234-3310
24066	234-4042
24071	234-3308
24075	234-3123
24076	234-4038
24079	234-3051
24080	234-4520
24086	234-1007
24092	234-3008
24097	234-3012
24101	234-3201
24102	234-2002
24105	234-1008
24106	234-1057
24109	234-2014
24111	234-4055
24112	234-4152
24113	234-4442
24114	234-4461
24115	234-4351
24116	234-4544
24118	234-4053
24122	234-1033
24129	234-2065
24131	234-4806
24132	234-4810
24135	234-2069
24137	234-3052
24141	234-1005
24144	234-4537
24145	234-3302
24154	234-3087
24157	234-3093
24166	234-1034
24167	234-4535
24168	234-4534
24169	234-4011
24172	234-4065
24173	234-4466
24176	234-1024
24194	234-1007
24201	234-4042
24202	234-4034
24203	234-4042
24225	234-4007
24229	234-4039
24230	234-4036

NTK	DENSO
24231	234-4039
24232	234-4390
24234	234-4396
24235	234-4094
24236	234-4503
24237	234-4504
24238	234-4031
24239	234-4443
24240	234-4352
24241	234-4355
24242	234-4220
24243	234-4092
24244	234-4297
24245	234-4314
24246	234-4315
24247	234-4313
24248	234-4296
24249	234-4368
24250	234-4364
24251	234-4352
24254	234-4354
24255	234-4292
24258	234-4363
24259	234-4292
24266	234-4359
24267	234-4351
24269	234-4351
24277	234-4226
24278	234-4033
24279	234-4424
24280	234-4080
24281	234-4105
24282	234-4092
24283	234-4621
24284	234-4092
24285	234-4092
24286	234-4621
24287	234-4601
24288	234-4094
24289	234-4074
24290	234-4122
24291	234-4122
24292	234-4361
24293	234-4149
24294	234-4069
24295	234-4069
24296	234-4105
24297	234-4468
24298	234-4296
24299	234-4308
24300	234-5052
24301	234-5050



NTK	DENSO
24302	234-5010
24304	234-5430
24305	234-5010
24306	234-5702
24307	234-5703
24308	234-5120
24309	234-5129
24310	234-5045
24312	234-5001
24313	234-5006
24314	234-5073
24315	234-5137
24316	234-5004
24317	234-5045
24318	234-5074
24319	234-5108
24320	234-5002
24321	234-5028
24322	234-5064
24323	234-5009
24324	234-5069
24325	234-5007
24326	234-5019
24327	234-5110
24328	234-5019
24329	234-5071
24330	234-5065
24331	234-5136
24332	234-5027
24333	234-5027
24334	234-5087
24335	234-5118
24336	234-5104
24337	234-5025
24338	234-5103
24339	234-5023
24341	234-5102
24342	234-5008
24343	234-5107
24344	234-5105
24345	234-5027
24346	234-5053
24347	234-5103
24348	234-5034
24349	234-5008
24350	234-5102
24351	234-5115
24352	234-5045
24353	234-5430
24354	234-5014
24355	234-5015
24356	234-5012

NTK	DENSO
24357	234-5013
24358	234-5033
24359	234-5018
24360	234-5011
24361	234-5119
24362	234-5047
24363	234-5043
24364	234-5048
24365	234-5026
24366	234-5084
24367	234-5063
24368	234-5058
24369	234-5059
24370	234-5147
24371	234-5044
24372	234-5056
24373	234-5152
24374	234-5066
24375	234-5067
24379	234-5092
24381	234-5029
24382	234-5081
24383	234-5041
24384	234-5032
24385	234-5098
24386	234-5099
24387	234-5038
24388	234-5039
24389	234-5030
24390	234-5030
24391	234-5040
24392	234-5012
24393	234-5042
24394	234-5075
24395	234-5078
24396	234-5077
24397	234-5038
24398	234-5049
24399	234-5051
24400	234-4295
24401	234-4308
24404	234-4301
24405	234-4310
24406	234-4311
24407	234-4309
24408	234-4312
24409	234-4122
24410	234-4125
24411	234-4524
24412	234-4363
24413	234-4355
24414	234-4368

NTK	DENSO
24415	234-4355
24416	234-4368
24417	234-4124
24419	234-4094
24420	234-4099
24421	234-4074
24422	234-4613
24423	234-4613
24425	234-4123
24426	234-4092
24427	234-4620
24429	234-4224
24430	234-4954
24431	234-4613
24432	234-4353
24433	234-4351
24434	234-4462
24435	234-4461
24436	234-4461
24437	234-4461
24438	234-4461
24439	234-4218
24440	234-4351
24441	234-4044
24442	234-4391
24443	234-4395
24444	234-4393
24445	234-4393
24446	234-4392
24447	234-4118
24448	234-4382
24449	234-4381
24450	234-4380
24451	234-4504
24452	234-4149
24453	234-4260
24454	234-4509
24455	234-4389
24456	234-4622
24457	234-4306
24458	234-4467
24459	234-4543
24460	234-4505
24461	234-4743
24462	234-4581
24463	234-4574
24464	234-4759
24465	234-4599
24466	234-4595
24467	234-4544
24468	234-4580
24469	234-4787



NTK	DENSO
24470	234-4757
24471	234-4760
24472	234-4904
24473	234-4786
24474	234-4781
24475	234-4790
24476	234-4782
24500	234-1016
24502	234-1053
24504	234-1055
24505	234-2003
24506	234-2008
24507	234-2015
24508	234-2010
24509	234-2011
24510	234-2051
24511	234-2052
24512	234-2055
24513	234-2057
24514	234-2058
24515	234-2005
24516	234-2062
24517	234-2064
24518	234-2009
24519	234-3075
24520	234-3088
24521	234-3087
24523	234-3091
24524	234-3202
24525	234-3098
24526	234-3097
24527	234-3108
24528	234-3106
24529	234-3107
24530	234-3099
24531	234-3128
24533	234-1007
24534	234-4644
24535	234-4130
24536	234-4051
24537	234-4052
24538	234-4055
24539	234-4055
24540	234-4097
24541	234-4097
24542	234-4065
24543	234-4703
24544	234-4703
24545	234-4325
24546	234-4098
24547	234-4626
24548	234-4061

NTK	DENSO
24549	234-4048
24550	234-4715
24551	234-1056
24552	234-1056
24553	234-4153
24554	234-4153
24555	234-4155
24556	234-4156
24557	234-4157
24558	234-4158
24559	234-4189
24560	234-4064
24561	234-4619
24563	234-4211
24564	234-4064
24565	234-4015
24566	234-4519
24567	234-4215
24568	234-4189
24569	234-4204
24570	234-4054
24571	234-4604
24572	234-4328
24573	234-4241
24574	234-4776
24575	234-4159
24576	234-4736
24577	234-4140
24578	234-4706
24579	234-4069
24581	234-4624
24582	234-4727
24583	234-4686
24584	234-4621
24585	234-4368
24586	234-4100
24587	234-4100
24588	234-4851
24589	234-4428
24591	234-4693
24592	234-4690
24593	234-4693
24594	234-4260
24595	234-4154
24598	234-4132
24599	234-4164
24600	234-4687
24601	234-4062
24602	234-3307
24603	234-4601
24605	234-4139
24606	234-4703

NTK	DENSO
24611	234-1051
24614	234-3083
24617	234-4060
24618	234-3113
24619	234-3110
24620	234-3306
24625	234-4011
24626	234-4012
24630	234-4716
24631	234-4733
24632	234-4323
24633	234-4065
24634	234-4270
24635	234-4714
24637	234-4779
24638	234-4326
24639	234-4327
24640	234-4776
24641	234-4302
24642	234-4445
24643	234-4713
24644	234-4814
24645	234-4270
24646	234-4273
24647	234-4797
24648	234-4324
24649	234-4167
24650	234-4362
24651	234-4195
24653	234-4063
24655	234-4620
24656	234-9024
24657	234-9010
24658	234-9021
24659	234-9011
24660	234-9013
24661	234-9026
24662	234-9008
24663	234-9012
24664	234-9015
24665	234-9004
24666	234-9006
24667	234-9018
24668	234-9066
24669	234-9001
24670	234-9002
24672	234-1011
24673	234-4059
24674	234-4026
24675	234-4726
24676	234-4048
24677	234-4149



NTK	DENSO
24678	234-4147
24679	234-4730
24681	234-4321
24682	234-4322
24683	234-4320
24684	234-4330
24685	234-4227
24687	234-4512
24688	234-4281
24689	234-4163
24690	234-4316
24694	234-9065
24695	234-9121
24696	234-9122
24697	234-4752
24698	234-4340
24699	234-4165
24779	234-4584
24780	234-4758
24801	234-9099
24803	234-9040
24804	234-3006
24805	234-3015
24806	234-4802
24807	234-4517
24808	234-4137
24809	234-9025
24810	234-4803
24811	234-4800
24812	234-4304
24814	234-9059
24815	234-4303
24816	234-4278
24817	234-4300
24818	234-4197
24819	234-4198
24820	234-9065
24821	234-9034
24822	234-9021
24823	234-9074
24824	234-4539
24825	234-9122
24826	234-9098
24827	234-9022
24828	234-9112
24829	234-9088
24830	234-9035
24831	234-9097
24833	234-9026
24834	234-4400
24835	234-9062
24836	234-9031

NTK	DENSO
24837	234-9041
24838	234-9064
24839	234-1055
24840	234-4521
24841	234-4305
24842	234-4518
24843	234-4387
24844	234-4501
24845	234-9064
24846	234-9103
24847	234-4306
24848	234-4804
24849	234-9111
24850	234-9113
24851	234-9109
24852	234-4536
24853	234-9079
24854	234-9107
25000	234-4431
25002	234-3131
25003	234-3132
25010	234-4481
25013	234-4789
25016	234-3130
25017	234-4788
25018	234-4953
25031	234-1000
25034	234-3019
25036	234-3032
25038	234-3082
25040	234-3048
25041	234-4670
25044	234-4783
25045	234-4785
25046	234-4674
25053	234-4712
25059	234-3090
25069	234-4191
25078	234-4482
25079	234-4413
25081	234-3081
25083	234-4414
25088	234-1000
25103	234-3023
25129	234-3082
25139	234-1000
25146	234-4268
25147	234-4267
25150	234-4434
25151	234-4435
25152	234-4434
25153	234-4042

NTK	DENSO
25154	234-4434
25155	234-4434
25156	234-4117
25157	234-4121
25158	234-4194
25160	234-4192
25162	234-4166
25163	234-4784
25166	234-4432
25167	234-4432
25169	234-4431
25170	234-4193
25173	234-4409
25174	234-4408
25175	234-4166
25176	234-4190
25177	234-4190
25178	234-4192
25180	234-4191
25181	234-4193
25182	234-4433
25183	234-4439
25184	234-4117
25185	234-4427
25186	234-4881
25187	234-4425
25188	234-4426
25189	234-4293
25190	234-4288
25191	234-4420
25192	234-4423
25193	234-4247
25194	234-4429
25195	234-4438
25196	234-4194
25197	234-4120
25198	234-4488
25199	234-4238
25200	234-4237
25201	234-4448
25202	234-4444
25210	234-4449
25211	234-4458
25212	234-4456
25213	234-4463
25214	234-4455
25215	234-4484
25216	234-4414
25217	234-4458
25218	234-4548
25219	234-4456
25220	234-4559





NTK	DENSO
25221	234-4570
25222	234-4463
25223	234-4571
25499	234-3027
25500	234-1000
25501	234-1000
25503	234-1000
25504	234-3013
25505	234-3016
25506	234-3000
25507	234-3000
25509	234-3029
25510	234-3060
25511	234-3033
25512	234-3034
25516	234-3031
25517	234-3103
25518	234-3070
25520	234-3105
25521	234-3078
25522	234-3070
25523	234-3092
25524	234-3019
25525	234-3102
25527	234-4685
25528	234-4023
25529	234-4674
25530	234-4674
25533	234-4676
25534	234-4057
25536	234-4058
25538	234-4181
25539	234-4665
25540	234-4088
25542	234-4681
25545	234-4176
25546	234-4180
25549	234-4663
25550	234-4664
25552	234-4661
25554	234-4183
25555	234-4182
25556	234-4710
25557	234-4440
25558	234-4709
25559	234-4088
25560	234-4671
25561	234-4671
25562	234-4707
25563	234-4176
25564	234-4175
25565	234-4670

NTK	DENSO
25567	234-4172
25568	234-4174
25569	234-4672
25570	234-4058
25572	234-1011
25573	234-2038
25574	234-3018
25576	234-3028
25577	234-3107
25578	234-4131
25579	234-4697
25580	234-4185
25581	234-4182
25582	234-4185
25583	234-4133
25585	234-4689
25586	234-4682
25587	234-4683
25588	234-4872
25589	234-4812
25590	234-4221
25591	234-4734
25592	234-4822
25593	234-4866
25594	234-4173
25595	234-4134
25596	234-4179
25598	234-4860
25599	234-4178
25601	234-4186
25603	234-4862
25604	234-4753
25605	234-4753
25606	234-4852
25607	234-4798
25608	234-4679
25609	234-4677
25610	234-4858
25611	234-4890
25612	234-4875
25613	234-4892
25614	234-4876
25616	234-4893
25617	234-4523
25618	234-4678
25619	234-4450
25620	234-4720
25623	234-4694
25624	234-4696
25627	234-4470
25629	234-9019
25630	234-9020

NTK	DENSO
25631	234-9029
25632	234-3079
25633	234-4182
25634	234-3135
25635	234-3100
25636	234-3079
25637	234-3070
25638	234-3150
25640	234-4533
25642	234-4660
25643	234-4662
25644	234-4661
25645	234-4844
25646	234-4136
25648	234-4457
25649	234-4850
25651	234-4950
25652	234-4269
25653	234-4527
25654	234-4916
25655	234-4472
25656	234-4485
25657	234-4485
25658	234-4473
25659	234-4496
25660	234-4828
25661	234-4846
25662	234-9150
25663	234-9151
25666	234-4422
25667	234-4421
25669	234-9085
25670	234-4329
25671	234-4854
25672	234-4272
25673	234-9102
25674	234-9086
25675	234-4485
25676	234-4876
25677	234-4171
25678	234-4263
25679	234-9038
25680	234-9060
25681	234-4829
25682	234-4499
25683	234-4938
25684	234-9033
25685	234-9036
25686	234-9087
25687	234-4829
25688	234-4498
25690	234-9037

# INTERCHANGE



NTK	DENSO
25691	234-4855
25692	234-4386
25693	234-4114
25694	234-4264
25695	234-4836
25696	234-4879
25697	234-9007
25698	234-9125
25699	234-9063
25700	234-9069
25701	234-4911
25702	234-9016
25704	234-9027
25705	234-4874
25706	234-9094
25708	234-4239
25709	234-4298
25712	234-4290
25713	234-4465
25714	234-4474
25715	234-4213
25716	234-4451
25717	234-4864
25718	234-4239
25719	234-4475
25720	234-4951
25721	234-4502
25722	234-4475
25723	234-4753
25725	234-4737
25726	234-3081
25727	234-4528
25729	234-4231
25730	234-4479
25731	234-9095
25732	234-4552
25733	234-4550
25734	234-4549
25735	234-4478
25736	234-4480
25737	234-4497
25738	234-4496
25739	234-4568
25740	234-4477
25741	234-4582
NO COVERAGE	234-1000
SMP	DENSO
250-24990	234-4549
SG1	234-1003
SG2	234-1004
SG3	234-2001

SMP	DENSO
SG5	234-1001
SG7	234-1002
SG8	234-1000
SG9	234-1011
SG10	234-2007
SG11	234-1011
SG12	234-1005
SG13	234-1006
SG14	234-1008
SG15	234-1005
SG16	234-1005
SG18	234-1008
SG20	234-3005
SG22	234-3003
SG23	234-3002
SG24	234-3001
SG25	234-4004
SG28	234-1010
SG32	234-1012
SG35	234-4014
SG37	234-3013
SG40	234-3007
SG42	234-3019
SG44	234-3016
SG45	234-3028
SG46	234-3018
SG47	234-3019
SG48	234-4707
SG49	234-1018
SG50	234-2002
SG53	234-3031
SG54	234-3031
SG57	234-3023
SG58	234-1000
SG62	234-3000
SG63	234-3000
SG66	234-3028
SG67	234-3029
SG68	234-3031
SG71	234-3033
SG72	234-4023
SG73	234-4088
SG74	234-3034
SG77	234-3082
SG78	234-3081
SG79	234-3000
SG80	234-4507
SG81	234-2052
SG83	234-1000
SG84	234-3048
SG85	234-3048
SG86	234-3104

SMP	DENSO
SG87	234-1020
SG88	234-1000
SG90	234-3019
SG91	234-3005
SG92	234-3073
SG94	234-3074
SG97	234-1010
SG102	234-3078
SG107	234-4127
SG109	234-4680
SG110	234-4058
SG112	234-1013
SG113	234-3083
SG115	234-1016
SG116	234-3302
SG118	234-4003
SG122	234-4676
SG123	234-4670
SG125	234-4689
SG127	234-3079
SG128	234-3032
SG130	234-3120
SG134	234-3042
SG135	234-2004
SG136	234-4086
SG137	234-2004
SG139	234-1020
SG140	234-3122
SG141	234-3309
SG142	234-4067
SG143	234-4081
SG144	234-4070
SG145	234-4609
SG146	234-4037
SG150	234-4607
SG151	234-3042
SG152	234-3042
SG153	234-4083
SG155	234-3085
SG156	234-4068
SG157	234-4068
SG159	234-3086
SG160	234-1020
SG161	234-1014
SG163	234-4007
SG164	234-3126
SG165	234-4071
SG167	234-3090
SG170	234-4130
SG171	234-4128
SG172	234-4182
SG173	234-3075



SMP	DENSO
SG174	234-3093
SG175	234-3089
SG176	234-3088
SG180	234-4710
SG181	234-4697
SG182	234-4130
SG183	234-4130
SG184	234-4533
SG185	234-4182
SG186	234-4185
SG189	234-4182
SG190	234-4181
SG191	234-4185
SG192	234-3091
SG193	234-4185
SG194	234-4182
SG195	234-4703
SG196	234-4703
SG197	234-4666
SG198	234-4663
SG202	234-2006
SG204	234-3074
SG205	234-4708
SG206	234-4171
SG207	234-4665
SG211	234-4083
SG213	234-4028
SG214	234-4075
SG215	234-4075
SG218	234-4068
SG219	234-4067
SG222	234-4078
SG225	234-4607
SG226	234-4016
SG240	234-2003
SG241	234-3011
SG243	234-4661
SG244	234-4893
SG246	234-4048
SG247	234-4953
SG248	234-4788
SG249	234-3130
SG251	234-4671
SG253	234-4661
SG254	234-3075
SG255	234-4174
SG256	234-4664
SG257	234-4172
SG260	234-3060
SG263	234-4051
SG265	234-4609
SG271	234-3302

SMP	DENSO
SG272	234-4018
SG274	234-4025
SG275	234-4615
SG276	234-4006
SG277	234-4087
SG280	234-4019
SG282	234-3302
SG283	234-3019
SG284	234-3087
SG285	234-3098
SG286	234-3083
SG287	234-1005
SG288	234-4715
SG291	234-3087
SG294	234-3033
SG295	234-4704
SG296	234-4704
SG298	234-4702
SG301	234-3202
SG303	234-4644
SG304	234-2067
SG305	234-3042
SG308	234-4666
SG309	234-4067
SG310	234-4641
SG311	234-4027
SG312	234-4026
SG316	234-4606
SG317	234-4605
SG320	234-4067
SG321	234-4041
SG322	234-4049
SG324	234-4648
SG326	234-4287
SG329	234-4616
SG331	234-4616
SG336	234-4011
SG341	234-4094
SG342	234-4601
SG346	234-4098
SG351	234-4703
SG353	234-4137
SG355	234-2052
SG356	234-2010
SG357	234-2008
SG358	234-4623
SG359	234-4156
SG360	234-2055
SG361	234-2052
SG362	234-2010
SG365	234-1053
SG366	234-1053

SMP	DENSO
SG367	234-2008
SG368	234-4260
SG370	234-4052
SG372	234-4154
SG377	234-4161
SG380	234-2058
SG381	234-4059
SG384	234-3004
SG388	234-4062
SG389	234-4508
SG394	234-1053
SG395	234-2051
SG396	234-4633
SG397	234-4641
SG398	234-4638
SG399	234-4135
SG401	234-4655
SG402	234-4655
SG407	234-4606
SG408	234-4143
SG409	234-4645
SG410	234-4631
SG411	234-4060
SG412	234-4032
SG413	234-4633
SG415	234-4726
SG418	234-1022
SG419	234-1022
SG420	234-4606
SG421	234-4034
SG429	234-4882
SG433	234-4077
SG434	234-1029
SG435	234-1030
SG437	234-4131
SG438	234-3123
SG443	234-1023
SG444	234-4089
SG445	234-3121
SG451	234-4065
SG452	234-4705
SG453	234-4665
SG454	234-4012
SG459	234-4401
SG462	234-4077
SG463	234-4635
SG470	234-4205
SG471	234-4061
SG472	234-4617
SG475	234-4651
SG477	234-4024
SG478	234-4019

# INTERCHANGE



SMP	DENSO
SG480	234-4627
SG481	234-4779
SG482	234-3075
SG484	234-4701
SG485	234-4403
SG487	234-1023
SG488	234-4691
SG490	234-4042
SG492	234-4070
SG493	234-4070
SG494	234-3307
SG496	234-3082
SG497	234-4057
SG498	234-3101
SG500	234-4685
SG502	234-3034
SG503	234-4711
SG505	234-3104
SG507	234-3105
SG508	234-4670
SG509	234-4698
SG510	234-3102
SG511	234-1034
SG513	234-4709
SG517	234-4068
SG518	234-4039
SG520	234-3103
SG521	234-3105
SG522	234-4182
SG524	234-3135
SG525	234-4601
SG527	234-4601
SG529	234-4049
SG530	234-4129
SG531	234-4102
SG532	234-4647
SG534	234-4103
SG535	234-4647
SG536	234-4647
SG538	234-3120
SG539	234-4053
SG541	234-4161
SG544	234-2008
SG546	234-1055
SG548	234-4152
SG549	234-3008
SG550	234-4629
SG551	234-3086
SG552	234-4017
SG553	234-4638
SG557	234-2010
SG558	234-4631

SMP	DENSO
SG559	234-4520
SG562	234-4716
SG563	234-4716
SG564	234-4322
SG566	234-9005
SG567	234-4648
SG568	234-4074
SG570	234-3083
SG571	234-4144
SG575	234-3100
SG576	234-4686
SG578	234-3070
SG579	234-4122
SG580	234-4140
SG581	234-4092
SG587	234-4150
SG588	234-3201
SG594	234-4631
SG595	234-1053
SG599	234-4712
SG600	234-1000
SG601	234-4071
SG602	234-4204
SG605	234-2002
SG606	234-4428
SG607	234-4692
SG610	234-4140
SG611	234-4140
SG614	234-4098
SG615	234-4606
SG616	234-4686
SG617	234-4686
SG618	234-3107
SG620	234-4606
SG624	234-4174
SG625	234-4689
SG626	234-4180
SG627	234-4175
SG628	234-4175
SG630	234-4177
SG632	234-4613
SG637	234-4612
SG638	234-4687
SG639	234-1007
SG640	234-4686
SG641	234-4644
SG643	234-3111
SG646	234-4020
SG647	234-3084
SG648	234-9028
SG649	234-1024
SG651	234-1053

SMP	DENSO
SG652	234-2062
SG653	234-4157
SG654	234-4624
SG656	234-4061
SG657	234-4055
SG660	234-4037
SG661	234-3013
SG662	234-3092
SG666	234-4671
SG667	234-4688
SG670	234-4662
SG676	234-4601
SG677	234-2058
SG678	234-4011
SG679	234-1020
SG681	234-3084
SG683	234-9021
SG684	234-4211
SG685	234-4511
SG687	234-1058
SG690	234-3113
SG691	234-3109
SG692	234-4642
SG694	234-4637
SG695	234-4636
SG696	234-4211
SG697	234-4664
SG698	234-4637
SG702	234-4176
SG703	234-4026
SG705	234-4104
SG708	234-4112
SG709	234-4108
SG710	234-4837
SG711	234-3088
SG712	234-3091
SG713	234-3099
SG720	234-4647
SG725	234-4609
SG727	234-4008
SG735	234-4587
SG739	234-4216
SG744	234-4688
SG745	234-9021
SG746	234-4233
SG747	234-4233
SG749	234-4233
SG750	234-4801
SG751	234-4324
SG752	234-4733
SG753	234-4800
SG754	234-4888



SMP	DENSO
SG757	234-9042
SG758	234-2008
SG761	234-9001
SG763	234-9012
SG765	234-4080
SG766	234-4105
SG767	234-5006
SG768	234-4064
SG769	234-2005
SG770	234-2066
SG771	234-4821
SG772	234-4821
SG773	234-4830
SG774	234-4619
SG775	234-1055
SG776	234-4149
SG779	234-9021
SG780	234-4162
SG788	234-4189
SG796	234-4161
SG798	234-4162
SG803	234-2003
SG807	234-4514
SG808	234-1055
SG809	234-4623
SG815	234-4803
SG816	234-4604
SG817	234-4604
SG818	234-4524
SG821	234-4155
SG822	234-4061
SG823	234-4169
SG826	234-3052
SG827	234-4407
SG831	234-4161
SG833	234-4162
SG837	234-4804
SG838	234-4805
SG845	234-4161
SG848	234-9007
SG849	234-4138
SG852	234-4852
SG853	234-4851
SG854	234-4035
SG856	234-4431
SG857	234-4851
SG858	234-4432
SG859	234-4042
SG860	234-3019
SG861	234-4434
SG862	234-4436
SG863	234-4035

SMP	DENSO
SG864	234-4431
SG865	234-4431
SG866	234-4022
SG868	234-4596
SG869	234-4590
SG870	234-4596
SG873	234-4642
SG874	234-4641
SG875	234-4652
SG876	234-4738
SG877	234-4641
SG878	234-4738
SG879	234-4738
SG880	234-4641
SG881	234-4639
SG884	234-4738
SG887	234-4652
SG888	234-4656
SG890	234-4874
SG895	234-4859
SG898	234-4152
SG899	234-4683
SG903	234-4862
SG904	234-4860
SG905	234-4641
SG907	234-4224
SG910	234-9013
SG916	234-5010
SG923	234-9040
SG926	234-5010
SG927	234-5050
SG929	234-4659
SG930	234-9006
SG932	234-4363
SG935	234-4673
SG936	234-4345
SG946	234-4302
SG948	234-4325
SG949	234-4716
SG950	234-4325
SG952	234-4052
SG953	234-4775
SG954	234-4704
SG955	234-3098
SG957	234-4835
SG958	234-4703
SG959	234-4270
SG960	234-4323
SG961	234-4273
SG962	234-4814
SG964	234-5061
SG965	234-4778

SMP	DENSO
SG966	234-4776
SG967	234-4716
SG968	234-4703
SG970	234-4286
SG977	234-4750
SG979	234-4630
SG980	234-4142
SG982	234-4190
SG983	234-4126
SG984	234-3089
SG985	234-4044
SG986	234-4399
SG987	234-4068
SG988	234-4397
SG989	234-4713
SG990	234-4776
SG991	234-4705
SG992	234-4041
SG993	234-4148
SG994	234-4044
SG995	234-9058
SG996	234-4713
SG997	234-4606
SG998	234-4724
SG999	234-4137
SG1001	234-4630
SG1002	234-4603
SG1007	234-3108
SG1008	234-3111
SG1009	234-4139
SG1012	234-4152
SG1013	234-4137
SG1014	234-4167
SG1016	234-4777
SG1018	234-3308
SG1020	234-4015
SG1021	234-4138
SG1022	234-4630
SG1024	234-4714
SG1025	234-4323
SG1027	234-4015
SG1029	234-4603
SG1030	234-4714
SG1031	234-4714
SG1033	234-4037
SG1034	234-3085
SG1035	234-4043
SG1036	234-4146
SG1037	234-4722
SG1038	234-4722
SG1039	234-4141
SG1040	234-4721



SMP	DENSO
SG1041	234-4040
SG1042	234-4330
SG1043	234-4629
SG1044	234-4038
SG1045	234-4036
SG1046	234-4144
SG1047	234-4140
SG1048	234-4144
SG1049	234-4141
SG1050	234-3012
SG1051	234-4398
SG1052	234-4067
SG1053	234-4040
SG1054	234-4039
SG1055	234-3008
SG1056	234-3009
SG1057	234-4612
SG1058	234-4145
SG1059	234-4147
SG1060	234-4723
SG1061	234-4141
SG1062	234-4751
SG1063	234-4725
SG1064	234-4714
SG1065	234-3089
SG1066	234-4669
SG1068	234-3089
SG1069	234-3014
SG1070	234-4914
SG1071	234-4184
SG1072	234-4911
SG1073	234-4267
SG1074	234-4698
SG1075	234-3080
SG1076	234-5701
SG1077	234-5702
SG1078	234-4148
SG1079	234-4629
SG1082	234-4752
SG1083	234-4132
SG1084	234-4629
SG1085	234-4117
SG1087	234-4125
SG1089	234-5003
SG1090	234-4867
SG1091	234-5700
SG1092	234-4866
SG1093	234-4863
SG1094	234-4863
SG1095	234-5703
SG1096	234-4672
SG1097	234-4911

SMP	DENSO
SG1098	234-4878
SG1099	234-4725
SG1100	234-4739
SG1101	234-4186
SG1103	234-4026
SG1104	234-4642
SG1105	234-4674
SG1106	234-4681
SG1107	234-4142
SG1108	234-4672
SG1109	234-4789
SG1110	234-4671
SG1111	234-4681
SG1112	234-4677
SG1114	234-4742
SG1115	234-4738
SG1116	234-4656
SG1117	234-4656
SG1119	234-4641
SG1120	234-4633
SG1121	234-4642
SG1122	234-4738
SG1123	234-4889
SG1124	234-4641
SG1125	234-4886
SG1126	234-4887
SG1127	234-4742
SG1128	234-4656
SG1129	234-4633
SG1130	234-4655
SG1131	234-4633
SG1132	234-4633
SG1133	234-4657
SG1134	234-4655
SG1135	234-4645
SG1136	234-4655
SG1137	234-4656
SG1139	234-4088
SG1141	234-4891
SG1142	234-4883
SG1145	234-4893
SG1146	234-4884
SG1147	234-4895
SG1148	234-4893
SG1150	234-4899
SG1151	234-4883
SG1152	234-4174
SG1153	234-4179
SG1155	234-4173
SG1156	234-4883
SG1157	234-4176
SG1158	234-4897

SMP	DENSO
SG1159	234-4898
SG1160	234-4178
SG1161	234-4058
SG1163	234-4618
SG1165	234-4752
SG1166	234-4612
SG1167	234-4517
SG1169	234-4633
SG1170	234-4753
SG1171	234-4662
SG1180	234-5045
SG1181	234-4661
SG1185	234-4039
SG1187	234-9011
SG1192	234-3110
SG1193	234-4682
SG1194	234-3129
SG1195	234-9014
SG1198	234-4045
SG1199	234-4706
SG1201	234-4180
SG1202	234-4679
SG1204	234-4172
SG1205	234-4175
SG1207	234-4121
SG1208	234-5164
SG1211	234-4393
SG1212	234-4150
SG1213	234-4185
SG1218	234-1055
SG1223	234-3150
SG1224	234-3107
SG1225	234-4633
SG1226	234-4637
SG1227	234-4055
SG1230	234-4783
SG1232	234-3310
SG1233	234-4621
SG1235	234-4779
SG1236	234-4134
SG1239	234-4133
SG1240	234-4180
SG1241	234-1000
SG1242	234-3095
SG1243	234-4031
SG1245	234-4715
SG1246	234-4321
SG1247	234-1008
SG1248	234-4623
SG1253	234-4075
SG1257	234-1012
SG1260	234-4150



SMP	DENSO
SG1261	234-3129
SG1263	234-4308
SG1265	234-2068
SG1266	234-4609
SG1267	234-4167
SG1268	234-4633
SG1269	234-4784
SG1271	234-4328
SG1272	234-3113
SG1273	234-4506
SG1274	234-4270
SG1275	234-4241
SG1276	234-4327
SG1277	234-3106
SG1278	234-4776
SG1279	234-4326
SG1280	234-3305
SG1281	234-3113
SG1282	234-3306
SG1283	234-5060
SG1284	234-3109
SG1285	234-3113
SG1288	234-4296
SG1289	234-3113
SG1290	234-3113
SG1291	234-4775
SG1292	234-4311
SG1293	234-4295
SG1294	234-4310
SG1296	234-4222
SG1297	234-4084
SG1298	234-4346
SG1299	234-4647
SG1302	234-4647
SG1303	234-2015
SG1305	234-4693
SG1306	234-4309
SG1307	234-4296
SG1309	234-3129
SG1310	234-4301
SG1315	234-4332
SG1316	234-4100
SG1319	234-4623
SG1320	234-4468
SG1321	234-4187
SG1329	234-4690
SG1334	234-4172
SG1335	234-4643
SG1336	234-3112
SG1337	234-4730
SG1338	234-4609
SG1347	234-4470

SMP	DENSO
SG1348	234-3083
SG1349	234-3083
SG1350	234-3087
SG1351	234-4470
SG1352	234-3051
SG1353	234-4715
SG1355	234-4260
SG1356	234-4470
SG1358	234-4631
SG1359	234-4656
SG1364	234-4352
SG1366	234-4108
SG1370	234-9066
SG1372	234-4730
SG1374	234-9041
SG1377	234-9057
SG1379	234-5003
SG1380	234-4816
SG1381	234-4411
SG1382	234-4412
SG1384	234-4651
SG1395	234-4410
SG1399	234-4656
SG1401	234-4296
SG1403	234-4312
SG1404	234-4302
SG1405	234-4308
SG1408	234-4121
SG1409	234-4119
SG1414	234-4119
SG1415	234-4343
SG1417	234-4063
SG1418	234-4649
SG1420	234-9020
SG1421	234-4802
SG1422	234-4233
SG1424	234-4434
SG1431	234-4168
SG1432	234-4509
SG1433	234-9042
SG1436	234-4655
SG1437	234-4280
SG1438	234-4741
SG1439	234-4739
SG1440	234-4631
SG1441	234-4026
SG1443	234-4656
SG1445	234-4738
SG1448	234-4281
SG1450	234-4281
SG1451	234-4277
SG1452	234-4642

SMP	DENSO
SG1453	234-4633
SG1454	234-4656
SG1455	234-4742
SG1456	234-4741
SG1457	234-4633
SG1459	234-4742
SG1460	234-4741
SG1466	234-4362
SG1467	234-4317
SG1468	234-4378
SG1469	234-4639
SG1471	234-4641
SG1472	234-4316
SG1475	234-4503
SG1479	234-9056
SG1480	234-4222
SG1492	234-4858
SG1493	234-4858
SG1495	234-5430
SG1496	234-4190
SG1497	234-4190
SG1500	234-4191
SG1502	234-4192
SG1503	234-4191
SG1504	234-4193
SG1505	234-4435
SG1506	234-4166
SG1507	234-4166
SG1508	234-4194
SG1509	234-4434
SG1510	234-4194
SG1511	234-4194
SG1514	234-4312
SG1516	234-5061
SG1517	234-4672
SG1518	234-4683
SG1526	234-4822
SG1528	234-4822
SG1529	234-4872
SG1536	234-5110
SG1537	234-4753
SG1540	234-4844
SG1541	234-4809
SG1543	234-4809
SG1545	234-4233
SG1552	234-4816
SG1554	234-4850
SG1558	234-4874
SG1559	234-5702
SG1562	234-5127
SG1563	234-5117
SG1565	234-5115

# INTERCHANGE



SMP	DENSO
SG1567	234-5133
SG1568	234-5133
SG1569	234-5115
SG1570	234-5060
SG1573	234-5060
SG1574	234-4334
SG1575	234-5133
SG1582	234-4816
SG1583	234-9052
SG1584	234-4731
SG1585	234-4818
SG1592	234-4155
SG1593	234-4375
SG1594	234-4233
SG1596	234-4368
SG1597	234-2011
SG1598	234-2069
SG1599	234-4158
SG1600	234-4054
SG1601	234-2013
SG1602	234-1005
SG1605	234-4371
SG1606	234-4370
SG1609	234-2005
SG1610	234-4693
SG1611	234-2009
SG1612	234-4293
SG1613	234-4815
SG1615	234-5004
SG1616	234-4610
SG1617	234-4320
SG1618	234-4732
SG1620	234-4226
SG1621	234-4348
SG1622	234-4817
SG1626	234-4331
SG1628	234-4339
SG1630	234-4651
SG1635	234-5001
SG1636	234-5002
SG1638	234-4288
SG1639	234-4335
SG1640	234-4338
SG1642	234-4851
SG1643	234-4852
SG1644	234-4193
SG1645	234-4193
SG1646	234-4435
SG1647	234-4434
SG1648	234-4199
SG1649	234-4192
SG1650	234-4192

SMP	DENSO
SG1651	234-4436
SG1652	234-4191
SG1654	234-4855
SG1655	234-4854
SG1656	234-4512
SG1657	234-4168
SG1658	234-4516
SG1659	234-4835
SG1660	234-5139
SG1661	234-9085
SG1662	234-4396
SG1663	234-5015
SG1664	234-4349
SG1665	234-9102
SG1666	234-4398
SG1667	234-4349
SG1668	234-4190
SG1669	234-4329
SG1670	234-9051
SG1673	234-9051
SG1674	234-4651
SG1676	234-4104
SG1677	234-4329
SG1678	234-4286
SG1679	234-4652
SG1680	234-4636
SG1681	234-4603
SG1682	234-4282
SG1683	234-4329
SG1684	234-4880
SG1686	234-4383
SG1687	234-4282
SG1688	234-4383
SG1689	234-4385
SG1690	234-4738
SG1691	234-4638
SG1692	234-4297
SG1693	234-4313
SG1694	234-4315
SG1695	234-4851
SG1696	234-4429
SG1697	234-4439
SG1698	234-4194
SG1699	234-4438
SG1700	234-4194
SG1702	234-4265
SG1703	234-4264
SG1704	234-9074
SG1705	234-4672
SG1706	234-4694
SG1707	234-4828
SG1708	234-4266

SMP	DENSO
SG1709	234-4695
SG1710	234-4734
SG1711	234-9020
SG1713	234-4314
SG1714	234-4296
SG1715	234-4149
SG1716	234-9018
SG1717	234-4696
SG1718	234-4266
SG1720	234-4646
SG1721	234-5010
SG1722	234-5010
SG1723	234-4292
SG1724	234-4292
SG1731	234-4235
SG1736	234-4390
SG1737	234-4392
SG1739	234-4392
SG1742	234-4368
SG1743	234-4355
SG1744	234-4368
SG1746	234-4011
SG1747	234-9065
SG1748	234-4354
SG1752	234-9042
SG1753	234-9052
SG1754	234-9054
SG1755	234-4504
SG1756	234-9019
SG1757	234-4354
SG1800	234-4045
SG1801	234-4609
SG1802	234-4046
SG1803	234-4127
SG1804	234-4127
SG1805	234-4608
SG1806	234-4001
SG1807	234-4001
SG1808	234-4071
SG1809	234-4374
SG1810	234-4070
SG1811	234-4611
SG1812	234-4070
SG1813	234-4045
SG1814	234-4046
SG1815	234-4008
SG1816	234-4002
SG1817	234-4082
SG1818	234-4076
SG1819	234-4602
SG1820	234-4078
SG1821	234-4597



## INTERCHANGE



SMP	DENSO
SG1822	234-4021
SG1823	234-4010
SG1824	234-4115
SG1825	234-4066
SG1826	234-4285
SG1827	234-4236
SG1829	234-4002
SG1830	234-4013
SG1831	234-4003
SG1832	234-4626
SG1834	234-4623
SG1835	234-4048
SG1836	234-4137
SG1837	234-4072
SG1838	234-4153
SG1839	234-4153
SG1840	234-4052
SG1841	234-4163
SG1842	234-4061
SG1843	234-4214
SG1844	234-4097
SG1845	234-9004
SG1846	234-4065
SG1847	234-4074
SG1848	234-4124
SG1849	234-4587
SG1850	234-4588
SG1851	234-4653
SG1852	234-4029
SG1853	234-4029
SG1854	234-4654
SG1855	234-4342
SG1856	234-4650
SG1857	234-4668
SG1858	234-9015
SG1859	234-4092
SG1860	234-4094
SG1861	234-4621
SG1862	234-4220
SG1863	234-9010
SG1864	234-9002
SG1865	234-9001
SG1866	234-3089
SG1867	234-3087
SG1868	234-4692
SG1869	234-4164
SG1870	234-4042
SG1871	234-2060
SG1924	234-4424
SG1944	234-9016
SG1994	234-5108
SG1996	234-5113

SMP	DENSO
SG2001	234-5097
SG2024	234-4446
SG2165	234-5052



#PART / PIECE PARTE	#WIRES / FILS CABLES	UPC-A
234-1000	1	0-42511-11000-7
234-1001	1	0-42511-11001-4
234-1002	1	0-42511-11002-1
234-1003	1	0-42511-11003-8
234-1004	1	0-42511-11004-5
234-1005	1	0-42511-11005-2
234-1006	1	0-42511-11006-9
234-1007	1	0-42511-11007-6
234-1008	1	0-42511-11008-3
234-1009	1	0-42511-11009-0
234-1010	1	0-42511-11010-6
234-1011	1	0-42511-11011-3
234-1012	1	0-42511-11012-0
234-1013	1	0-42511-11013-7
234-1014	1	0-42511-11014-4
234-1015	1	0-42511-11015-1
234-1016	1	0-42511-11016-8
234-1017	1	0-42511-11017-5
234-1018	1	0-42511-11018-2
234-1019	1	0-42511-11019-9
234-1020	1	0-42511-11020-5
234-1021	1	0-42511-11021-2
234-1022	1	0-42511-11022-9
234-1023	1	0-42511-11023-6
234-1024	1	0-42511-11024-3
234-1025	1	0-42511-11025-0
234-1029	1	0-42511-11029-8
234-1030	1	0-42511-11030-4
234-1033	1	0-42511-11344-2
234-1034	1	0-42511-11345-9
234-1040	1	0-42511-11346-6
234-1051	1	0-42511-11051-9
234-1052	1	0-42511-11052-6
234-1053	1	0-42511-11053-3
234-1055	1	0-42511-11055-7
234-1056	1	0-42511-11056-4
234-1057	1	0-42511-11057-1
234-1058	1	0-42511-11058-8
234-2000	2	0-42511-12000-6
234-2001	2	0-42511-12001-3
234-2002	2	0-42511-12002-0
234-2003	2	0-42511-12003-7
234-2004	2	0-42511-12004-4
234-2005	2	0-42511-12005-1
234-2006	2	0-42511-12006-8
234-2007	2	0-42511-12007-5
234-2008	2	0-42511-12008-2
234-2009	2	0-42511-12009-9
234-2010	2	0-42511-12010-5
234-2011	2	0-42511-12011-2
234-2013	2	0-42511-12013-6
234-2014	2	0-42511-12014-3

#PART / PIECE PARTE	#WIRES / FILS CABLES	UPC-A
234-2015	2	0-42511-11175-2
234-2038	2	0-42511-11628-3
234-2050	2	0-42511-12050-1
234-2051	2	0-42511-12051-8
234-2052	2	0-42511-12052-5
234-2055	2	0-42511-12055-6
234-2057	2	0-42511-12057-0
234-2058	2	0-42511-12058-7
234-2060	2	0-42511-12060-0
234-2062	2	0-42511-12062-4
234-2064	2	0-42511-12064-8
234-2065	2	0-42511-12065-5
234-2066	2	0-42511-12066-2
234-2067	2	0-42511-12067-9
234-2068	2	0-42511-12068-6
234-2069	2	0-42511-12069-3
234-2071	2	0-42511-12071-6
234-3000	3	0-42511-13000-5
234-3001	3	0-42511-13001-2
234-3002	3	0-42511-13002-9
234-3003	3	0-42511-13003-6
234-3004	3	0-42511-13004-3
234-3005	3	0-42511-13005-0
234-3006	3	0-42511-11755-6
234-3007	3	0-42511-13007-4
234-3008	3	0-42511-13008-1
234-3009	3	0-42511-13009-8
234-3010	3	0-42511-13010-4
234-3011	3	0-42511-13011-1
234-3012	3	0-42511-13012-8
234-3013	3	0-42511-13013-5
234-3014	3	0-42511-13014-2
234-3015	3	0-42511-13015-9
234-3016	3	0-42511-13016-6
234-3018	3	0-42511-13018-0
234-3019	3	0-42511-13019-7
234-3023	3	0-42511-13023-4
234-3027	3	0-42511-13027-2
234-3028	3	0-42511-13028-9
234-3029	3	0-42511-13029-6
234-3030	3	0-42511-13030-2
234-3031	3	0-42511-13031-9
234-3032	3	0-42511-13032-6
234-3033	3	0-42511-13033-3
234-3034	3	0-42511-13034-0
234-3042	3	0-42511-13042-5
234-3048	3	0-42511-13048-7
234-3050	3	0-42511-13050-0
234-3051	3	0-42511-13051-7
234-3052	3	0-42511-13052-4
234-3060	3	0-42511-13060-9
234-3070	3	0-42511-13070-8

#PART / PIECE PARTE	#WIRES / FILS CABLES	UPC-A
234-3073	3	0-42511-13073-9
234-3074	3	0-42511-13074-6
234-3075	3	0-42511-13075-3
234-3078	3	0-42511-13078-4
234-3079	3	0-42511-13079-1
234-3080	3	0-42511-13080-7
234-3081	3	0-42511-13081-4
234-3082	3	0-42511-13082-1
234-3083	3	0-42511-13083-8
234-3084	3	0-42511-13084-5
234-3085	3	0-42511-13085-2
234-3086	3	0-42511-13086-9
234-3087	3	0-42511-13087-6
234-3088	3	0-42511-13088-3
234-3089	3	0-42511-13089-0
234-3090	3	0-42511-13090-6
234-3091	3	0-42511-13091-3
234-3092	3	0-42511-13092-0
234-3093	3	0-42511-13093-7
234-3094	3	0-42511-13094-4
234-3095	3	0-42511-13095-1
234-3096	3	0-42511-13096-8
234-3097	3	0-42511-13097-5
234-3098	3	0-42511-13098-2
234-3099	3	0-42511-13099-9
234-3100	3	0-42511-13100-2
234-3101	3	0-42511-13101-9
234-3102	3	0-42511-13102-6
234-3103	3	0-42511-13103-3
234-3104	3	0-42511-13104-0
234-3105	3	0-42511-13105-7
234-3106	3	0-42511-13106-4
234-3107	3	0-42511-13107-1
234-3108	3	0-42511-11176-9
234-3109	3	0-42511-11177-6
234-3110	3	0-42511-11178-3
234-3111	3	0-42511-11179-0
234-3112	3	0-42511-11180-6
234-3113	3	0-42511-13113-2
234-3116	3	0-42511-11199-8
234-3120	3	0-42511-11114-1
234-3121	3	0-42511-11115-8
234-3122	3	0-42511-11116-5
234-3123	3	0-42511-11117-2
234-3126	3	0-42511-11119-6
234-3128	3	0-42511-11120-2
234-3129	3	0-42511-11121-9
234-3130	3	0-42511-11122-6
234-3131	3	0-42511-11123-3
234-3132	3	0-42511-11124-0
234-3135	3	0-42511-11535-4
234-3150	3	0-42511-11347-3



#PART / PIECE PARTE	#WIRES / FILS CABLES	UPC-A
234-3201	3	0-42511-11349-7
234-3202	3	0-42511-11350-3
234-3301	3	0-42511-11351-0
234-3302	3	0-42511-11352-7
234-3304	3	0-42511-11354-1
234-3305	3	0-42511-11355-8
234-3306	3	0-42511-11356-5
234-3307	3	0-42511-11357-2
234-3308	3	0-42511-11358-9
234-3309	3	0-42511-11359-6
234-3310	3	0-42511-11360-2
234-4000	4	0-42511-14000-4
234-4001	4	0-42511-14001-1
234-4002	4	0-42511-14002-8
234-4003	4	0-42511-14003-5
234-4004	4	0-42511-14004-2
234-4005	4	0-42511-14005-9
234-4006	4	0-42511-14006-6
234-4007	4	0-42511-14007-3
234-4008	4	0-42511-14008-0
234-4010	4	0-42511-14010-3
234-4011	4	0-42511-14011-0
234-4012	4	0-42511-14012-7
234-4013	4	0-42511-14013-4
234-4014	4	0-42511-14014-1
234-4015	4	0-42511-14015-8
234-4016	4	0-42511-14016-5
234-4017	4	0-42511-14017-2
234-4018	4	0-42511-14018-9
234-4019	4	0-42511-14019-6
234-4020	4	0-42511-14020-2
234-4021	4	0-42511-14021-9
234-4022	4	0-42511-14022-6
234-4023	4	0-42511-14023-3
234-4024	4	0-42511-14024-0
234-4025	4	0-42511-14025-7
234-4026	4	0-42511-14026-4
234-4027	4	0-42511-14027-1
234-4028	4	0-42511-14028-8
234-4029	4	0-42511-14029-5
234-4030	4	0-42511-14030-1
234-4031	4	0-42511-14031-8
234-4032	4	0-42511-14032-5
234-4033	4	0-42511-14033-2
234-4034	4	0-42511-14034-9
234-4035	4	0-42511-14035-6
234-4036	4	0-42511-14036-3
234-4037	4	0-42511-14037-0
234-4038	4	0-42511-14038-7
234-4039	4	0-42511-14039-4
234-4040	4	0-42511-14040-0
234-4041	4	0-42511-14041-7

#PART / PIECE PARTE	#WIRES / FILS CABLES	UPC-A
234-4042	4	0-42511-14042-4
234-4043	4	0-42511-14043-1
234-4044	4	0-42511-14044-8
234-4045	4	0-42511-14045-5
234-4046	4	0-42511-14046-2
234-4048	4	0-42511-14048-6
234-4049	4	0-42511-14049-3
234-4050	4	0-42511-14050-9
234-4051	4	0-42511-14051-6
234-4052	4	0-42511-14052-3
234-4053	4	0-42511-14053-0
234-4054	4	0-42511-14054-7
234-4055	4	0-42511-14055-4
234-4056	4	0-42511-14056-1
234-4057	4	0-42511-14057-8
234-4058	4	0-42511-14058-5
234-4059	4	0-42511-14059-2
234-4060	4	0-42511-14060-8
234-4061	4	0-42511-14061-5
234-4062	4	0-42511-14062-2
234-4063	4	0-42511-14063-9
234-4064	4	0-42511-11181-3
234-4065	4	0-42511-14065-3
234-4066	4	0-42511-14066-0
234-4067	4	0-42511-14067-7
234-4068	4	0-42511-14068-4
234-4069	4	0-42511-14069-1
234-4070	4	0-42511-14070-7
234-4071	4	0-42511-14071-4
234-4072	4	0-42511-14072-1
234-4073	4	0-42511-11692-4
234-4074	4	0-42511-14074-5
234-4075	4	0-42511-14075-2
234-4076	4	0-42511-14076-9
234-4077	4	0-42511-14077-6
234-4078	4	0-42511-14078-3
234-4079	4	0-42511-14079-0
234-4080	4	0-42511-14080-6
234-4081	4	0-42511-14081-3
234-4082	4	0-42511-14082-0
234-4083	4	0-42511-14083-7
234-4084	4	0-42511-14084-4
234-4086	4	0-42511-14086-8
234-4087	4	0-42511-14087-5
234-4088	4	0-42511-14088-2
234-4089	4	0-42511-14089-9
234-4090	4	0-42511-14090-5
234-4092	4	0-42511-14092-9
234-4093	4	0-42511-14093-6
234-4094	4	0-42511-14094-3
234-4095	4	0-42511-14095-0
234-4097	4	0-42511-14097-4

#PART / PIECE PARTE	#WIRES / FILS CABLES	UPC-A
234-4098	4	0-42511-14098-1
234-4099	4	0-42511-14099-8
234-4100	4	0-42511-14100-1
234-4102	4	0-42511-14102-5
234-4103	4	0-42511-14103-2
234-4104	4	0-42511-14104-9
234-4105	4	0-42511-14105-6
234-4106	4	0-42511-14106-3
234-4107	4	0-42511-11694-8
234-4108	4	0-42511-14108-7
234-4112	4	0-42511-14112-4
234-4114	4	0-42511-11723-5
234-4115	4	0-42511-14115-5
234-4116	4	0-42511-11724-2
234-4117	4	0-42511-14117-9
234-4118	4	0-42511-11721-1
234-4119	4	0-42511-11300-8
234-4120	4	0-42511-11745-7
234-4121	4	0-42511-14121-6
234-4122	4	0-42511-14122-3
234-4123	4	0-42511-11182-0
234-4124	4	0-42511-11183-7
234-4125	4	0-42511-14125-4
234-4126	4	0-42511-14126-1
234-4127	4	0-42511-14127-8
234-4128	4	0-42511-14128-5
234-4129	4	0-42511-14129-2
234-4130	4	0-42511-14130-8
234-4131	4	0-42511-14131-5
234-4132	4	0-42511-14132-2
234-4133	4	0-42511-14133-9
234-4134	4	0-42511-14134-6
234-4135	4	0-42511-14135-3
234-4136	4	0-42511-14136-0
234-4137	4	0-42511-14137-7
234-4138	4	0-42511-14138-4
234-4139	4	0-42511-14139-1
234-4140	4	0-42511-14140-7
234-4141	4	0-42511-14141-4
234-4142	4	0-42511-14142-1
234-4143	4	0-42511-14143-8
234-4144	4	0-42511-14144-5
234-4145	4	0-42511-14145-2
234-4146	4	0-42511-14146-9
234-4147	4	0-42511-14147-6
234-4148	4	0-42511-14148-3
234-4149	4	0-42511-14149-0
234-4150	4	0-42511-14150-6
234-4151	4	0-42511-14151-3
234-4152	4	0-42511-14152-0
234-4153	4	0-42511-14153-7
234-4154	4	0-42511-14154-4



#PART / PIECE PARTE	#WIRES / FILS CABLES	UPC-A
234-4155	4	0-42511-14155-1
234-4156	4	0-42511-14156-8
234-4157	4	0-42511-14157-5
234-4158	4	0-42511-14158-2
234-4159	4	0-42511-14159-9
234-4160	4	0-42511-14160-5
234-4161	4	0-42511-14161-2
234-4162	4	0-42511-14162-9
234-4163	4	0-42511-14163-6
234-4164	4	0-42511-11207-0
234-4165	4	0-42511-11736-5
234-4166	4	0-42511-11237-7
234-4167	4	0-42511-11184-4
234-4168	4	0-42511-11185-1
234-4169	4	0-42511-14169-8
234-4171	4	0-42511-14171-1
234-4172	4	0-42511-14172-8
234-4173	4	0-42511-11126-4
234-4174	4	0-42511-14174-2
234-4175	4	0-42511-14175-9
234-4176	4	0-42511-11127-1
234-4177	4	0-42511-14177-3
234-4178	4	0-42511-11128-8
234-4179	4	0-42511-11129-5
234-4180	4	0-42511-11130-1
234-4181	4	0-42511-11131-8
234-4182	4	0-42511-11132-5
234-4183	4	0-42511-11133-2
234-4184	4	0-42511-11134-9
234-4185	4	0-42511-11135-6
234-4186	4	0-42511-11136-3
234-4187	4	0-42511-11695-5
234-4188	4	0-42511-11722-8
234-4189	4	0-42511-14189-6
234-4190	4	0-42511-11239-1
234-4191	4	0-42511-11244-5
234-4192	4	0-42511-11241-4
234-4193	4	0-42511-11242-1
234-4194	4	0-42511-11250-6
234-4195	4	0-42511-11733-4
234-4197	4	0-42511-11756-3
234-4198	4	0-42511-11758-7
234-4199	4	0-42511-11236-0
234-4200	4	0-42511-11137-0
234-4201	4	0-42511-14201-5
234-4202	4	0-42511-14202-2
234-4204	4	0-42511-14204-6
234-4205	4	0-42511-14205-3
234-4206	4	0-42511-14206-0
234-4207	4	0-42511-14207-7
234-4208	4	0-42511-14208-4
234-4209	4	0-42511-14209-1

#PART / PIECE PARTE	#WIRES / FILS CABLES	UPC-A
234-4210	4	0-42511-14210-7
234-4211	4	0-42511-14211-4
234-4212	4	0-42511-14212-1
234-4213	4	0-42511-11764-8
234-4214	4	0-42511-14214-5
234-4215	4	0-42511-14215-2
234-4216	4	0-42511-14216-9
234-4217	4	0-42511-11248-3
234-4218	4	0-42511-11765-5
234-4219	4	0-42511-11766-2
234-4220	4	0-42511-11229-2
234-4221	4	0-42511-11225-4
234-4222	4	0-42511-11226-1
234-4224	4	0-42511-11227-8
234-4225	4	0-42511-11214-8
234-4226	4	0-42511-11206-3
234-4227	4	0-42511-11209-4
234-4228	4	0-42511-11249-0
234-4229	4	0-42511-11246-9
234-4230	4	0-42511-11228-5
234-4231	4	0-42511-11768-6
234-4232	4	0-42511-11247-6
234-4233	4	0-42511-11255-1
234-4234	4	0-42511-11232-2
234-4235	4	0-42511-11240-7
234-4236	4	0-42511-11301-5
234-4237	4	0-42511-11769-3
234-4238	4	0-42511-11770-9
234-4239	4	0-42511-11771-6
234-4240	4	0-42511-11772-3
234-4241	4	0-42511-11253-7
234-4242	4	0-42511-11696-2
234-4243	4	0-42511-11697-9
234-4244	4	0-42511-11698-6
234-4245	4	0-42511-11699-3
234-4246	4	0-42511-11700-6
234-4247	4	0-42511-11701-3
234-4248	4	0-42511-11702-0
234-4249	4	0-42511-11703-7
234-4250	4	0-42511-11704-4
234-4251	4	0-42511-11705-1
234-4252	4	0-42511-11706-8
234-4253	4	0-42511-11707-5
234-4254	4	0-42511-11708-2
234-4255	4	0-42511-11709-9
234-4256	4	0-42511-11710-5
234-4257	4	0-42511-11711-2
234-4258	4	0-42511-11712-9
234-4260	4	0-42511-11223-0
234-4261	4	0-42511-11251-3
234-4262	4	0-42511-11773-0
234-4263	4	0-42511-11774-7

#PART / PIECE PARTE	#WIRES / FILS CABLES	UPC-A
234-4264	4	0-42511-11633-7
234-4265	4	0-42511-11634-4
234-4266	4	0-42511-11635-1
234-4267	4	0-42511-11639-9
234-4268	4	0-42511-11640-5
234-4269	4	0-42511-11646-7
234-4270	4	0-42511-11254-4
234-4271	4	0-42511-11687-0
234-4272	4	0-42511-11775-4
234-4273	4	0-42511-11234-6
234-4277	4	0-42511-11215-5
234-4278	4	0-42511-11776-1
234-4279	4	0-42511-11777-8
234-4280	4	0-42511-11222-3
234-4281	4	0-42511-11216-2
234-4282	4	0-42511-11218-6
234-4283	4	0-42511-11778-5
234-4284	4	0-42511-11302-2
234-4285	4	0-42511-11303-9
234-4286	4	0-42511-11304-6
234-4287	4	0-42511-11305-3
234-4288	4	0-42511-11306-0
234-4289	4	0-42511-11307-7
234-4290	4	0-42511-11779-2
234-4291	4	0-42511-11780-8
234-4292	4	0-42511-11308-4
234-4293	4	0-42511-11309-1
234-4294	4	0-42511-11310-7
234-4295	4	0-42511-11363-3
234-4296	4	0-42511-11364-0
234-4297	4	0-42511-11365-7
234-4298	4	0-42511-11781-5
234-4300	4	0-42511-11783-9
234-4301	4	0-42511-14301-2
234-4302	4	0-42511-14302-9
234-4303	4	0-42511-11784-6
234-4304	4	0-42511-11785-3
234-4305	4	0-42511-11786-0
234-4306	4	0-42511-11794-5
234-4308	4	0-42511-11367-1
234-4309	4	0-42511-11252-0
234-4310	4	0-42511-11210-0
234-4311	4	0-42511-11211-7
234-4312	4	0-42511-11238-4
234-4313	4	0-42511-11368-8
234-4314	4	0-42511-11369-5
234-4315	4	0-42511-11370-1
234-4316	4	0-42511-11371-8
234-4317	4	0-42511-11372-5
234-4318	4	0-42511-11373-2
234-4319	4	0-42511-11374-9
234-4320	4	0-42511-11375-6



#PART / PIECE PARTE	#WIRES / FILS CABLES	UPC-A
234-4321	4	0-42511-11376-3
234-4322	4	0-42511-11377-0
234-4323	4	0-42511-11378-7
234-4324	4	0-42511-11379-4
234-4325	4	0-42511-11380-0
234-4326	4	0-42511-11381-7
234-4327	4	0-42511-11382-4
234-4328	4	0-42511-11383-1
234-4329	4	0-42511-11384-8
234-4330	4	0-42511-11385-5
234-4331	4	0-42511-11311-4
234-4332	4	0-42511-11312-1
234-4333	4	0-42511-11386-2
234-4334	4	0-42511-11313-8
234-4335	4	0-42511-11314-5
234-4336	4	0-42511-11315-2
234-4337	4	0-42511-11316-9
234-4338	4	0-42511-11317-6
234-4339	4	0-42511-11318-3
234-4340	4	0-42511-11387-9
234-4341	4	0-42511-11319-0
234-4342	4	0-42511-11320-6
234-4343	4	0-42511-11321-3
234-4344	4	0-42511-11322-0
234-4345	4	0-42511-11323-7
234-4346	4	0-42511-11324-4
234-4347	4	0-42511-11325-1
234-4348	4	0-42511-11326-8
234-4349	4	0-42511-11388-6
234-4350	4	0-42511-11389-3
234-4351	4	0-42511-11390-9
234-4352	4	0-42511-11391-6
234-4353	4	0-42511-11392-3
234-4354	4	0-42511-11393-0
234-4355	4	0-42511-11394-7
234-4358	4	0-42511-11397-8
234-4359	4	0-42511-11398-5
234-4360	4	0-42511-11399-2
234-4361	4	0-42511-11400-5
234-4362	4	0-42511-11401-2
234-4363	4	0-42511-11402-9
234-4364	4	0-42511-11403-6
234-4368	4	0-42511-11407-4
234-4370	4	0-42511-11409-8
234-4371	4	0-42511-11410-4
234-4372	4	0-42511-11411-1
234-4373	4	0-42511-11412-8
234-4374	4	0-42511-11413-5
234-4375	4	0-42511-11414-2
234-4376	4	0-42511-11415-9
234-4377	4	0-42511-11416-6
234-4378	4	0-42511-11417-3

#PART / PIECE PARTE	#WIRES / FILS CABLES	UPC-A
234-4379	4	0-42511-11418-0
234-4380	4	0-42511-11419-7
234-4381	4	0-42511-11420-3
234-4382	4	0-42511-11421-0
234-4383	4	0-42511-11422-7
234-4385	4	0-42511-11424-1
234-4386	4	0-42511-11425-8
234-4387	4	0-42511-11426-5
234-4388	4	0-42511-11427-2
234-4389	4	0-42511-11787-7
234-4390	4	0-42511-11428-9
234-4391	4	0-42511-11429-6
234-4392	4	0-42511-11430-2
234-4393	4	0-42511-11431-9
234-4394	4	0-42511-11432-6
234-4395	4	0-42511-11433-3
234-4396	4	0-42511-11434-0
234-4397	4	0-42511-11435-7
234-4398	4	0-42511-11436-4
234-4399	4	0-42511-11437-1
234-4400	4	0-42511-11788-4
234-4401	4	0-42511-11257-5
234-4403	4	0-42511-11258-2
234-4407	4	0-42511-11263-6
234-4408	4	0-42511-11558-3
234-4409	4	0-42511-11559-0
234-4410	4	0-42511-11438-8
234-4411	4	0-42511-11439-5
234-4412	4	0-42511-11440-1
234-4413	4	0-42511-11560-6
234-4414	4	0-42511-11561-3
234-4416	4	0-42511-11790-7
234-4417	4	0-42511-11815-7
234-4418	4	0-42511-11816-4
234-4419	4	0-42511-11817-1
234-4420	4	0-42511-11441-8
234-4421	4	0-42511-11442-5
234-4422	4	0-42511-11443-2
234-4423	4	0-42511-11444-9
234-4424	4	0-42511-11445-6
234-4425	4	0-42511-11446-3
234-4426	4	0-42511-11447-0
234-4427	4	0-42511-11448-7
234-4428	4	0-42511-11449-4
234-4429	4	0-42511-11450-0
234-4430	4	0-42511-11451-7
234-4431	4	0-42511-11452-4
234-4432	4	0-42511-11453-1
234-4433	4	0-42511-11454-8
234-4434	4	0-42511-11455-5
234-4435	4	0-42511-11456-2
234-4436	4	0-42511-11457-9

#PART / PIECE PARTE	#WIRES / FILS CABLES	UPC-A
234-4437	4	0-42511-11458-6
234-4438	4	0-42511-11459-3
234-4439	4	0-42511-11460-9
234-4440	4	0-42511-11536-1
234-4441	4	0-42511-11818-8
234-4442	4	0-42511-11819-5
234-4443	4	0-42511-11820-1
234-4444	4	0-42511-11821-8
234-4445	4	0-42511-11461-6
234-4446	4	0-42511-11462-3
234-4447	4	0-42511-11463-0
234-4448	4	0-42511-11822-5
234-4449	4	0-42511-11823-2
234-4450	4	0-42511-11537-8
234-4451	4	0-42511-11538-5
234-4452	4	0-42511-11539-2
234-4453	4	0-42511-11540-8
234-4454	4	0-42511-11541-5
234-4455	4	0-42511-11824-9
234-4456	4	0-42511-11825-6
234-4457	4	0-42511-11669-6
234-4458	4	0-42511-11826-3
234-4461	4	0-42511-11716-7
234-4462	4	0-42511-11717-4
234-4463	4	0-42511-11827-0
234-4464	4	0-42511-11828-4
234-4465	4	0-42511-11829-4
234-4466	4	0-42511-11830-0
234-4467	4	0-42511-11831-7
234-4468	4	0-42511-11832-4
234-4470	4	0-42511-11670-2
234-4471	4	0-42511-11671-9
234-4472	4	0-42511-11672-6
234-4473	4	0-42511-11673-3
234-4474	4	0-42511-11834-8
234-4475	4	0-42511-11835-5
234-4476	4	0-42511-11836-2
234-4477	4	0-42511-11861-4
234-4478	4	0-42511-11862-1
234-4479	4	0-42511-11863-8
234-4480	4	0-42511-11864-5
234-4481	4	0-42511-11865-2
234-4482	4	0-42511-11866-9
234-4483	4	0-42511-11873-7
234-4484	4	0-42511-11949-9
234-4485	4	0-42511-11950-5
234-4486	4	0-42511-11947-5
234-4487	4	0-42511-11948-2
234-4488	4	0-42511-11674-0
234-4489	4	0-42511-11875-1
234-4490	4	0-42511-11876-8
234-4491	4	0-42511-11877-5



#PART / PIECE PARTE	#WIRES / FILS CABLES	UPC-A
234-4492	4	0-42511-11878-2
234-4493	4	0-42511-11879-9
234-4494	4	0-42511-11880-5
234-4495	4	0-42511-11881-2
234-4496	4	0-42511-11924-6
234-4497	4	0-42511-11925-3
234-4498	4	0-42511-11926-0
234-4499	4	0-42511-11927-7
234-4501	4	0-42511-14501-6
234-4502	4	0-42511-14502-3
234-4503	4	0-42511-14503-0
234-4504	4	0-42511-14504-7
234-4505	4	0-42511-11909-3
234-4506	4	0-42511-14506-1
234-4507	4	0-42511-14507-8
234-4508	4	0-42511-14508-5
234-4509	4	0-42511-11272-8
234-4511	4	0-42511-11274-2
234-4512	4	0-42511-11275-9
234-4513	4	0-42511-11932-1
234-4514	4	0-42511-11276-6
234-4515	4	0-42511-11277-3
234-4516	4	0-42511-11277-3
234-4517	4	0-42511-11279-7
234-4518	4	0-42511-11280-3
234-4519	4	0-42511-11281-0
234-4520	4	0-42511-11282-7
234-4521	4	0-42511-11283-4
234-4522	4	0-42511-11903-1
234-4523	4	0-42511-11904-8
234-4524	4	0-42511-11284-1
234-4526	4	0-42511-11884-3
234-4527	4	0-42511-11885-0
234-4528	4	0-42511-11886-7
234-4529	4	0-42511-11887-4
234-4530	4	0-42511-11888-1
234-4533	4	0-42511-11626-9
234-4534	4	0-42511-11916-1
234-4535	4	0-42511-11917-8
234-4536	4	0-42511-11918-5
234-4537	4	0-42511-11935-2
234-4538	4	0-42511-11936-9
234-4539	4	0-42511-11937-6
234-4540	4	0-42511-11938-3
234-4543	4	0-42511-11889-8
234-4544	4	0-42511-11890-4
234-4545	4	0-42511-11870-6
234-4546	4	0-42511-11871-3
234-4547	4	0-42511-11872-0
234-4548	4	0-42511-11895-9
234-4549	4	0-42511-11896-6
234-4550	4	0-42511-11897-3

#PART / PIECE PARTE	#WIRES / FILS CABLES	UPC-A
234-4551	4	0-42511-11898-0
234-4552	4	0-42511-11899-7
234-4553	4	0-42511-11951-2
234-4555	4	0-42511-11882-9
234-4557	4	0-42511-11940-6
234-4559	4	0-42511-11930-7
234-4560	4	0-42511-11905-5
234-4561	4	0-42511-11958-1
234-4562	4	0-42511-12113-3
234-4563	4	0-42511-12114-0
234-4564	4	0-42511-12115-7
234-4565	4	0-42511-12116-4
234-4566	4	0-42511-12117-1
234-4567	4	0-42511-12118-8
234-4568	4	0-42511-12119-5
234-4569	4	0-42511-12120-1
234-4570	4	0-42511-12121-8
234-4571	4	0-42511-12122-5
234-4572	4	0-42511-12123-2
234-4573	4	0-42511-12124-9
234-4574	4	0-42511-12125-6
234-4575	4	0-42511-12126-3
234-4576	4	0-42511-12127-0
234-4577	4	0-42511-12128-7
234-4578	4	0-42511-12129-4
234-4579	4	0-42511-12130-0
234-4580	4	0-42511-12131-7
234-4581	4	0-42511-12132-4
234-4582	4	0-42511-12133-1
234-4583	4	0-42511-12134-8
234-4584	4	0-42511-12135-5
234-4585	4	0-42511-12136-2
234-4586	4	0-42511-12137-9
234-4587	4	0-42511-11464-7
234-4588	4	0-42511-11465-4
234-4589	4	0-42511-12138-6
234-4590	4	0-42511-11466-1
234-4591	4	0-42511-12139-3
234-4592	4	0-42511-11467-8
234-4593	4	0-42511-11468-5
234-4595	4	0-42511-12140-9
234-4596	4	0-42511-11470-8
234-4597	4	0-42511-11471-5
234-4598	4	0-42511-11472-2
234-4599	4	0-42511-12141-6
234-4600	4	0-42511-12187-4
234-4601	4	0-42511-14601-3
234-4602	4	0-42511-14602-0
234-4603	4	0-42511-14603-7
234-4604	4	0-42511-14604-4
234-4605	4	0-42511-14605-1
234-4606	4	0-42511-14606-8

#PART / PIECE PARTE	#WIRES / FILS CABLES	UPC-A
234-4607	4	0-42511-14607-5
234-4608	4	0-42511-14608-2
234-4609	4	0-42511-14609-9
234-4610	4	0-42511-14610-5
234-4611	4	0-42511-14611-2
234-4612	4	0-42511-14612-9
234-4613	4	0-42511-14613-6
234-4614	4	0-42511-14614-3
234-4615	4	0-42511-14615-0
234-4616	4	0-42511-14616-7
234-4617	4	0-42511-14617-4
234-4618	4	0-42511-14618-1
234-4619	4	0-42511-14619-8
234-4620	4	0-42511-14620-4
234-4621	4	0-42511-14621-1
234-4622	4	0-42511-14622-8
234-4623	4	0-42511-14623-5
234-4624	4	0-42511-14624-2
234-4626	4	0-42511-14626-6
234-4627	4	0-42511-14627-3
234-4628	4	0-42511-14628-0
234-4629	4	0-42511-14629-7
234-4630	4	0-42511-14630-3
234-4631	4	0-42511-14631-0
234-4633	4	0-42511-14633-4
234-4634	4	0-42511-14634-1
234-4635	4	0-42511-14635-8
234-4636	4	0-42511-14636-5
234-4637	4	0-42511-14637-2
234-4638	4	0-42511-14638-9
234-4639	4	0-42511-14639-6
234-4640	4	0-42511-14640-2
234-4641	4	0-42511-14641-9
234-4642	4	0-42511-14642-6
234-4643	4	0-42511-14643-3
234-4644	4	0-42511-14644-0
234-4645	4	0-42511-14645-7
234-4646	4	0-42511-14646-4
234-4647	4	0-42511-14647-1
234-4648	4	0-42511-14648-8
234-4649	4	0-42511-14649-5
234-4650	4	0-42511-14650-1
234-4651	4	0-42511-14651-8
234-4652	4	0-42511-14652-5
234-4653	4	0-42511-14653-2
234-4654	4	0-42511-14654-9
234-4655	4	0-42511-14655-6
234-4656	4	0-42511-14656-3
234-4657	4	0-42511-14657-0
234-4658	4	0-42511-14658-7
234-4659	4	0-42511-14659-4
234-4660	4	0-42511-11138-7



#PART / PIECE PARTE	#WIRES / FILS CABLES	UPC-A
234-4661	4	0-42511-11139-4
234-4662	4	0-42511-11140-0
234-4663	4	0-42511-11141-7
234-4664	4	0-42511-11142-4
234-4665	4	0-42511-11143-1
234-4666	4	0-42511-11144-8
234-4668	4	0-42511-11256-8
234-4669	4	0-42511-11245-2
234-4670	4	0-42511-11146-2
234-4671	4	0-42511-11147-9
234-4672	4	0-42511-11148-6
234-4673	4	0-42511-11217-9
234-4674	4	0-42511-11149-3
234-4675	4	0-42511-11150-9
234-4676	4	0-42511-11151-6
234-4677	4	0-42511-11152-3
234-4678	4	0-42511-11153-0
234-4679	4	0-42511-11154-7
234-4680	4	0-42511-11155-4
234-4681	4	0-42511-11156-1
234-4682	4	0-42511-11157-8
234-4683	4	0-42511-11158-5
234-4684	4	0-42511-11159-2
234-4685	4	0-42511-11160-8
234-4686	4	0-42511-11161-5
234-4687	4	0-42511-11162-2
234-4688	4	0-42511-11163-9
234-4689	4	0-42511-11164-6
234-4690	4	0-42511-11165-3
234-4691	4	0-42511-11166-0
234-4692	4	0-42511-11167-7
234-4693	4	0-42511-11168-4
234-4694	4	0-42511-11169-1
234-4695	4	0-42511-11170-7
234-4696	4	0-42511-11171-4
234-4697	4	0-42511-11172-1
234-4698	4	0-42511-11173-8
234-4699	4	0-42511-11174-5
234-4700	4	0-42511-14700-3
234-4701	4	0-42511-14701-0
234-4702	4	0-42511-14702-7
234-4703	4	0-42511-14703-4
234-4704	4	0-42511-14704-1
234-4705	4	0-42511-14705-8
234-4706	4	0-42511-14706-5
234-4707	4	0-42511-14707-2
234-4708	4	0-42511-11657-3
234-4709	4	0-42511-14709-6
234-4710	4	0-42511-14710-2
234-4711	4	0-42511-14711-9
234-4712	4	0-42511-14712-6
234-4713	4	0-42511-14713-3

#PART / PIECE PARTE	#WIRES / FILS CABLES	UPC-A
234-4714	4	0-42511-14714-0
234-4715	4	0-42511-14715-7
234-4716	4	0-42511-14716-4
234-4717	4	0-42511-12142-3
234-4718	4	0-42511-11093-9
234-4719	4	0-42511-11094-6
234-4720	4	0-42511-11073-1
234-4721	4	0-42511-11074-8
234-4722	4	0-42511-11075-5
234-4723	4	0-42511-11076-2
234-4724	4	0-42511-11077-9
234-4725	4	0-42511-11078-6
234-4726	4	0-42511-11079-3
234-4727	4	0-42511-11080-9
234-4729	4	0-42511-11082-3
234-4730	4	0-42511-11083-0
234-4731	4	0-42511-11084-7
234-4732	4	0-42511-11085-4
234-4733	4	0-42511-11086-1
234-4734	4	0-42511-11233-9
234-4736	4	0-42511-11088-5
234-4737	4	0-42511-12143-0
234-4738	4	0-42511-11089-2
234-4739	4	0-42511-11090-8
234-4740	4	0-42511-12144-7
234-4741	4	0-42511-11091-5
234-4742	4	0-42511-11092-2
234-4743	4	0-42511-12145-4
234-4744	4	0-42511-11231-5
234-4745	4	0-42511-11235-3
234-4746	4	0-42511-11097-7
234-4747	4	0-42511-11098-4
234-4748	4	0-42511-20877-3
234-4749	4	0-42511-11099-1
234-4750	4	0-42511-11186-8
234-4751	4	0-42511-11187-5
234-4752	4	0-42511-11188-2
234-4753	4	0-42511-12177-5
234-4754	4	0-42511-12178-2
234-4755	4	0-42511-11208-7
234-4756	4	0-42511-11224-7
234-4757	4	0-42511-12146-1
234-4758	4	0-42511-12147-8
234-4759	4	0-42511-12148-5
234-4760	4	0-42511-12149-2
234-4761	4	0-42511-11100-4
234-4762	4	0-42511-20878-0
234-4763	4	0-42511-20879-7
234-4764	4	0-42511-11101-1
234-4765	4	0-42511-20880-3
234-4766	4	0-42511-11102-8
234-4767	4	0-42511-11103-5

#PART / PIECE PARTE	#WIRES / FILS CABLES	UPC-A
234-4768	4	0-42511-11104-2
234-4769	4	0-42511-11105-9
234-4770	4	0-42511-11106-6
234-4771	4	0-42511-11107-3
234-4772	4	0-42511-11108-0
234-4773	4	0-42511-20881-0
234-4774	4	0-42511-20882-7
234-4775	4	0-42511-11189-9
234-4776	4	0-42511-11190-5
234-4777	4	0-42511-11191-2
234-4778	4	0-42511-11192-9
234-4779	4	0-42511-11193-6
234-4780	4	0-42511-20883-4
234-4781	4	0-42511-20884-1
234-4782	4	0-42511-20885-8
234-4783	4	0-42511-11109-7
234-4784	4	0-42511-11195-0
234-4785	4	0-42511-11111-0
234-4786	4	0-42511-20886-5
234-4787	4	0-42511-20887-2
234-4788	4	0-42511-11197-4
234-4789	4	0-42511-11198-1
234-4790	4	0-42511-20888-9
234-4791	4	0-42511-20889-6
234-4792	4	0-42511-20890-2
234-4793	4	0-42511-20891-9
234-4794	4	0-42511-20892-6
234-4795	4	0-42511-20893-3
234-4796	4	0-42511-20894-0
234-4797	4	0-42511-11243-8
234-4798	4	0-42511-11212-4
234-4799	4	0-42511-20895-7
234-4800	4	0-42511-11200-1
234-4801	4	0-42511-11201-8
234-4802	4	0-42511-11202-5
234-4803	4	0-42511-11203-2
234-4804	4	0-42511-11204-9
234-4805	4	0-42511-11205-6
234-4806	4	0-42511-11285-8
234-4808	4	0-42511-11563-7
234-4809	4	0-42511-11564-4
234-4810	4	0-42511-11286-5
234-4811	4	0-42511-11565-1
234-4812	4	0-42511-11566-8
234-4814	4	0-42511-11474-6
234-4815	4	0-42511-11327-5
234-4816	4	0-42511-11328-2
234-4817	4	0-42511-11329-9
234-4818	4	0-42511-11330-5
234-4819	4	0-42511-11331-2
234-4820	4	0-42511-11332-9
234-4821	4	0-42511-11333-6



#PART / PIECE PARTE	#WIRES / FILS CABLES	UPC-A
234-4822	4	0-42511-11334-3
234-4827	4	0-42511-11627-6
234-4828	4	0-42511-11636-8
234-4829	4	0-42511-11572-9
234-4830	4	0-42511-11335-0
234-4831	4	0-42511-11573-6
234-4832	4	0-42511-11574-3
234-4833	4	0-42511-11575-0
234-4834	4	0-42511-11576-7
234-4835	4	0-42511-11476-0
234-4836	4	0-42511-11746-4
234-4837	4	0-42511-11477-7
234-4839	4	0-42511-20896-4
234-4840	4	0-42511-11479-1
234-4843	4	0-42511-11579-8
234-4844	4	0-42511-11580-4
234-4846	4	0-42511-11582-8
234-4849	4	0-42511-11585-9
234-4850	4	0-42511-11586-6
234-4851	4	0-42511-11480-7
234-4852	4	0-42511-11481-4
234-4854	4	0-42511-11483-8
234-4855	4	0-42511-11484-5
234-4856	4	0-42511-11485-2
234-4857	4	0-42511-11486-9
234-4858	4	0-42511-11487-6
234-4859	4	0-42511-11587-3
234-4860	4	0-42511-11542-2
234-4861	4	0-42511-11543-9
234-4862	4	0-42511-11544-6
234-4863	4	0-42511-11545-3
234-4864	4	0-42511-11546-0
234-4865	4	0-42511-11547-7
234-4866	4	0-42511-11548-4
234-4867	4	0-42511-11549-1
234-4871	4	0-42511-11590-3
234-4872	4	0-42511-11591-0
234-4874	4	0-42511-11593-4
234-4875	4	0-42511-11196-7
234-4876	4	0-42511-11675-7
234-4877	4	0-42511-11676-4
234-4878	4	0-42511-11729-7
234-4879	4	0-42511-11730-3
234-4880	4	0-42511-11489-0
234-4881	4	0-42511-11490-6
234-4882	4	0-42511-11491-3
234-4883	4	0-42511-11492-0
234-4884	4	0-42511-11493-7
234-4886	4	0-42511-11495-1
234-4887	4	0-42511-11496-8
234-4888	4	0-42511-11497-5
234-4889	4	0-42511-11498-2

#PART / PIECE PARTE	#WIRES / FILS CABLES	UPC-A
234-4890	4	0-42511-11658-0
234-4891	4	0-42511-11659-7
234-4892	4	0-42511-11677-1
234-4893	4	0-42511-11660-3
234-4894	4	0-42511-11661-0
234-4895	4	0-42511-11662-7
234-4896	4	0-42511-11663-4
234-4897	4	0-42511-11664-1
234-4898	4	0-42511-11665-8
234-4899	4	0-42511-11666-5
234-4900	4	0-42511-11688-7
234-4901	4	0-42511-11667-2
234-4902	4	0-42511-11668-9
234-4903	4	0-42511-11719-8
234-4904	4	0-42511-20897-1
234-4905	4	0-42511-20898-8
234-4906	4	0-42511-20899-5
234-4907	4	0-42511-20900-8
234-4908	4	0-42511-20901-5
234-4909	4	0-42511-20902-2
234-4910	4	0-42511-11641-2
234-4911	4	0-42511-11642-9
234-4912	4	0-42511-11643-6
234-4913	4	0-42511-11644-3
234-4914	4	0-42511-11645-0
234-4916	4	0-42511-11648-1
234-4917	4	0-42511-11649-8
234-4920	4	0-42511-11652-8
234-4921	4	0-42511-20903-9
234-4922	4	0-42511-20904-6
234-4923	4	0-42511-11653-5
234-4924	4	0-42511-20905-3
234-4925	4	0-42511-20906-0
234-4926	4	0-42511-20907-7
234-4927	4	0-42511-20908-4
234-4928	4	0-42511-20909-1
234-4929	4	0-42511-20910-7
234-4930	4	0-42511-20911-4
234-4931	4	0-42511-20912-1
234-4932	4	0-42511-20913-8
234-4933	4	0-42511-20914-5
234-4934	4	0-42511-20915-2
234-4935	4	0-42511-20916-9
234-4936	4	0-42511-20917-6
234-4937	4	0-42511-20918-3
234-4938	4	0-42511-220072
234-4939	4	0-42511-12190-4
234-4940	4	0-42511-12188-1
234-4941		
234-4942		
234-4944	4	0-42511-12191-1
234-4945	4	0-42511-12192-8

#PART / PIECE PARTE	#WIRES / FILS CABLES	UPC-A
234-4946	4	0-42511-12193-5
234-4947	4	0-42511-12194-2
234-4948	4	0-42511-12195-9
234-4949	4	0-42511-12196-6
234-4950	4	0-42511-11629-0
234-4951	4	0-42511-11630-6
234-4952	4	0-42511-12197-3
234-4953	4	0-42511-11631-3
234-4954	4	0-42511-11759-4
234-4955	4	0-42511-11760-0
234-4956	4	0-42511-12198-0
234-4957	4	0-42511-12199-7
234-4958	4	0-42511-12200-0
234-4959	4	0-42511-12201-7
234-4960	4	0-42511-12202-4
234-4961	4	0-42511-12203-1
234-4962	4	0-42511-12204-8
234-4963	4	0-42511-12205-5
234-4964	4	0-42511-12206-2
234-4965	4	0-42511-12207-9
234-4966	4	0-42511-12208-6
234-4967	4	0-42511-12209-3
234-4968	4	0-42511-12210-9
234-4969	4	0-42511-12211-6
234-4970	4	0-42511-12212-3
234-4971	4	0-42511-12213-0
234-4972	4	0-42511-12214-7
234-4973	4	0-42511-12215-4
234-4974	4	0-42511-12216-1
234-4975	4	0-42511-12217-8
234-4976	4	0-42511-12218-5
234-4977	4	0-42511-12219-2
234-4978	4	0-42511-12220-8
234-4979	4	0-42511-12221-5
234-4980	4	0-42511-12222-2
234-4981	4	0-42511-12223-9
234-4982	4	0-42511-12224-6
234-4983	4	0-42511-12225-3
234-4984	4	0-42511-12226-0
234-4985	4	0-42511-12227-7
234-4986	4	0-42511-12228-4
234-4987	4	0-42511-12229-1
234-4988	4	0-42511-12230-7
234-4989	4	0-42511-12231-4
234-4990	4	0-42511-12232-1
234-4991	4	0-42511-12233-8
234-4992	4	0-42511-12234-5
234-4993	4	0-42511-12235-2
234-4994	4	0-42511-12236-9
234-4995	4	0-42511-12237-6
234-4996	4	0-42511-12238-3
234-5001	5	0-42511-11336-7





#PART / PIECE PARTE	#WIRES / FILS CABLES	UPC-A
234-5002	5	0-42511-11337-4
234-5003	5	0-42511-11338-1
234-5004	5	0-42511-11339-8
234-5005	5	0-42511-11340-4
234-5006	5	0-42511-11341-1
234-5007	5	0-42511-11342-8
234-5008	5	0-42511-11747-1
234-5009	5	0-42511-11748-8
234-5010	5	0-42511-11343-5
234-5011	5	0-42511-11499-9
234-5012	5	0-42511-11500-2
234-5013	5	0-42511-11501-9
234-5014	5	0-42511-11502-6
234-5015	5	0-42511-11503-3
234-5018	5	0-42511-11791-4
234-5019	5	0-42511-11751-8
234-5022	5	0-42511-11754-9
234-5023	5	0-42511-11731-0
234-5024	5	0-42511-11732-7
234-5025	5	0-42511-11689-4
234-5026	5	0-42511-11690-0
234-5027	5	0-42511-11691-7
234-5028	5	0-42511-11761-7
234-5029	5	0-42511-11792-1
234-5030	5	0-42511-11793-8
234-5032	5	0-42511-11795-2
234-5033	5	0-42511-11796-9
234-5034	5	0-42511-11797-6
234-5036	5	0-42511-11799-0
234-5037	5	0-42511-11837-9
234-5038	5	0-42511-11838-6
234-5039	5	0-42511-11839-3
234-5040	5	0-42511-11840-9
234-5041	5	0-42511-11841-6
234-5042	5	0-42511-11842-3
234-5043	5	0-42511-11843-0
234-5044	5	0-42511-11844-7
234-5045	5	0-42511-11845-4
234-5046	5	0-42511-11846-1
234-5047	5	0-42511-11847-8
234-5048	5	0-42511-11867-6
234-5049	5	0-42511-11914-7
234-5050	5	0-42511-11504-0
234-5051	5	0-42511-11915-4
234-5052	5	0-42511-11505-7
234-5053	5	0-42511-11506-4
234-5054	5	0-42511-12153-9
234-5055	5	0-42511-12154-6
234-5056	5	0-42511-12155-3
234-5057	5	0-42511-12156-0
234-5058	5	0-42511-12157-7
234-5059	5	0-42511-12158-4

#PART / PIECE PARTE	#WIRES / FILS CABLES	UPC-A
234-5060	5	0-42511-11507-1
234-5061	5	0-42511-11508-8
234-5062	5	0-42511-11509-5
234-5063	5	0-42511-12159-1
234-5064	5	0-42511-12160-7
234-5065	5	0-42511-12161-4
234-5066	5	0-42511-12162-1
234-5067	5	0-42511-12163-8
234-5068	5	0-42511-12164-5
234-5069	5	0-42511-12165-2
234-5071	5	0-42511-11931-4
234-5072	5	0-42511-1164-2
234-5073	5	0-42511-1165-9
234-5074	5	0-42511-1166-6
234-5075	5	0-42511-11874-4
234-5076	5	0-42511-11883-6
234-5077	5	0-42511-11911-6
234-5078	5	0-42511-11912-3
234-5079	5	0-42511-11868-3
234-5080	5	0-42511-11869-0
234-5081	5	0-42511-11900-0
234-5082	5	0-42511-11901-7
234-5083	5	0-42511-11902-4
234-5084	5	0-42511-11906-2
234-5085	5	0-42511-11907-9
234-5086	5	0-42511-11908-6
234-5087	5	0-42511-11928-4
234-5090	5	0-42511-11510-1
234-5091	5	0-42511-11511-8
234-5092	5	0-42511-11953-6
234-5093	5	0-42511-11954-3
234-5094	5	0-42511-11955-0
234-5095	5	0-42511-11919-2
234-5096	5	0-42511-11857-7
234-5097	5	0-42511-11858-4
234-5098	5	0-42511-11859-1
234-5099	5	0-42511-11860-7
234-5102	5	0-42511-11596-5
234-5103	5	0-42511-11597-2
234-5104	5	0-42511-11598-9
234-5105	5	0-42511-11599-6
234-5106	5	0-42511-11600-9
234-5107	5	0-42511-11601-6
234-5108	5	0-42511-11602-3
234-5110	5	0-42511-11604-7
234-5113	5	0-42511-11607-8
234-5114	5	0-42511-11608-5
234-5115	5	0-42511-11609-2
234-5116	5	0-42511-11610-8
234-5117	5	0-42511-11611-5
234-5118	5	0-42511-11612-2
234-5119	5	0-42511-11613-9

#PART / PIECE PARTE	#WIRES / FILS CABLES	UPC-A
234-5120	5	0-42511-11614-6
234-5125	5	0-42511-11619-1
234-5126	5	0-42511-11620-7
234-5127	5	0-42511-11621-4
234-5128	5	0-42511-11622-1
234-5129	5	0-42511-11623-8
234-5131	5	0-42511-11625-2
234-5132	5	0-42511-1168-8
234-5133	5	0-42511-11679-5
234-5134	5	0-42511-11680-1
234-5135	5	0-42511-11681-8
234-5136	5	0-42511-11682-5
234-5137	5	0-42511-11683-2
234-5138	5	0-42511-11684-9
234-5139	5	0-42511-11685-6
234-5140	5	0-42511-11686-3
234-5141	5	0-42511-12166-9
234-5142	5	0-42511-12167-6
234-5143	5	0-42511-12168-3
234-5144	5	0-42511-12169-0
234-5145	5	0-42511-12170-6
234-5146	5	0-42511-12171-3
234-5147	5	0-42511-12172-0
234-5148	5	0-42511-12179-9
234-5150	5	0-42511-20919-0
234-5151	5	0-42511-20920-6
234-5152	5	0-42511-20921-3
234-5153	5	0-42511-20922-0
234-5154	5	0-42511-20923-7
234-5155	5	0-42511-20924-4
234-5156	5	0-42511-20925-1
234-5157	5	0-42511-20926-8
234-5158	5	0-42511-20927-5
234-5159	5	0-42511-20928-2
234-5160	5	0-42511-20929-9
234-5161	5	0-42511-20930-5
234-5162	5	0-42511-20931-2
234-5163	5	0-42511-20932-9
234-5164	5	0-42511-20933-6
234-5165	5	0-42511-12239-0
234-5166	5	0-42511-12240-6
234-5167	5	0-42511-12241-3
234-5168	5	0-42511-12242-0
234-5169	5	0-42511-12243-7
234-5170	5	0-42511-12244-4
234-5171	5	0-42511-12245-1
234-5172	5	0-42511-12246-8
234-5173	5	0-42511-12247-5
234-5174	5	0-42511-12248-2
234-5175	5	0-42511-12249-9
234-5176	5	0-42511-12250-5
234-5177	5	0-42511-12251-2



#PART / PIECE PARTE	#WIRES / FILS CABLES	UPC-A
234-5178	5	0-42511-12252-9
234-5180	5	0-42511-12253-6
234-5181	5	0-42511-12254-3
234-5182	5	0-42511-12255-0
234-5183	5	0-42511-12256-7
234-5184	5	0-42511-12257-4
234-5185	5	0-42511-12258-1
234-5430	5	0-42511-11512-5
234-5700	5	0-42511-11550-7
234-5701	5	0-42511-11551-4
234-5702	5	0-42511-11552-1
234-5703	5	0-42511-11553-8
234-5705	5	0-42511-11554-5
234-9001	4	0-42511-11036-6
234-9002	4	0-42511-11037-3
234-9003	4	0-42511-11038-0
234-9004	4	0-42511-11039-7
234-9005	4	0-42511-11040-3
234-9006	4	0-42511-11041-0
234-9007	4	0-42511-11042-7
234-9008	4	0-42511-11737-2
234-9009	4	0-42511-11043-4
234-9010	4	0-42511-11044-1
234-9011	4	0-42511-11045-8
234-9012	4	0-42511-11738-9
234-9013	4	0-42511-11194-3
234-9014	4	0-42511-11046-5
234-9015	4	0-42511-11047-2
234-9016	4	0-42511-11048-9
234-9017	4	0-42511-11230-8
234-9018	4	0-42511-11049-6
234-9019	4	0-42511-11059-5
234-9020	4	0-42511-11060-1
234-9021	4	0-42511-11061-8
234-9022	4	0-42511-11739-6
234-9023	4	0-42511-11062-5
234-9024	4	0-42511-11063-2
234-9025	4	0-42511-11064-9
234-9026	4	0-42511-11740-2
234-9027	4	0-42511-11720-4
234-9028	4	0-42511-11065-6
234-9029	4	0-42511-11213-1
234-9030	4	0-42511-11221-6
234-9031	4	0-42511-11513-2
234-9032	4	0-42511-11514-9
234-9033	4	0-42511-11515-6
234-9034	4	0-42511-11734-1
234-9035	4	0-42511-11735-8
234-9036	4	0-42511-11725-9
234-9037	4	0-42511-11726-6
234-9038	4	0-42511-11727-3
234-9039	4	0-42511-11728-0

#PART / PIECE PARTE	#WIRES / FILS CABLES	UPC-A
234-9040	4	0-42511-11264-3
234-9041	4	0-42511-11266-7
234-9042	4	0-42511-11265-0
234-9047	4	0-42511-11270-4
234-9048	4	0-42511-11741-9
234-9049	4	0-42511-11742-6
234-9050	4	0-42511-11287-2
234-9051	4	0-42511-11288-9
234-9052	4	0-42511-11289-6
234-9054	4	0-42511-11291-9
234-9056	4	0-42511-11293-3
234-9057	4	0-42511-11294-0
234-9058	4	0-42511-11295-7
234-9059	4	0-42511-11800-3
234-9060	4	0-42511-11516-3
234-9061	4	0-42511-11517-0
234-9062	4	0-42511-11518-7
234-9063	4	0-42511-11519-4
234-9064	4	0-42511-11520-0
234-9065	4	0-42511-11521-7
234-9066	4	0-42511-11522-4
234-9067	4	0-42511-11743-3
234-9068	4	0-42511-11744-0
234-9069	4	0-42511-11801-0
234-9070	4	0-42511-11523-1
234-9071	4	0-42511-11524-8
234-9072	4	0-42511-11525-5
234-9073	4	0-42511-11526-2
234-9074	4	0-42511-11637-5
234-9075	4	0-42511-11638-2
234-9076	4	0-42511-11802-7
234-9077	4	0-42511-11803-4
234-9078	4	0-42511-11804-1
234-9079	4	0-42511-11805-8
234-9080	4	0-42511-11806-5
234-9081	4	0-42511-11807-2
234-9082	4	0-42511-11808-9
234-9083	4	0-42511-11809-6
234-9084	4	0-42511-11810-2
234-9085	4	0-42511-11527-9
234-9086	4	0-42511-11528-6
234-9087	4	0-42511-11529-3
234-9088	4	0-42511-11530-9
234-9089	4	0-42511-11811-9
234-9090	4	0-42511-11812-6
234-9091	4	0-42511-11718-1
234-9092	4	0-42511-11813-3
234-9093	4	0-42511-11814-0
234-9094	4	0-42511-11848-5
234-9095	4	0-42511-11849-2
234-9096	4	0-42511-11850-8
234-9097	4	0-42511-11851-5

#PART / PIECE PARTE	#WIRES / FILS CABLES	UPC-A
234-9098	4	0-42511-11852-2
234-9099	4	0-42511-11853-9
234-9100	4	0-42511-11854-6
234-9101	4	0-42511-11855-3
234-9102	4	0-42511-11856-0
234-9103	4	0-42511-11913-0
234-9104	4	0-42511-11920-8
234-9105	4	0-42511-11921-5
234-9106	4	0-42511-11922-2
234-9107	4	0-42511-11923-9
234-9108	4	0-42511-11933-8
234-9109	4	0-42511-11934-5
234-9111	4	0-42511-11942-0
234-9112	4	0-42511-11943-7
234-9113	4	0-42511-11944-4
234-9114	4	0-42511-11945-1
234-9115	4	0-42511-11946-8
234-9116	4	0-42511-11891-1
234-9117	4	0-42511-11892-8
234-9118	4	0-42511-11893-5
234-9119	4	0-42511-11894-2
234-9120	4	0-42511-11531-6
234-9121	4	0-42511-11532-3
234-9122	4	0-42511-11533-0
234-9123	4	0-42511-11534-7
234-9124	4	0-42511-11956-7
234-9125	4	0-42511-11632-0
234-9126	4	0-42511-11957-4
234-9127	4	0-42511-12173-7
234-9128	4	0-42511-12174-4
234-9129	4	0-42511-12175-1
234-9130	4	0-42511-12176-8
234-9131	4	0-42511-20934-3
234-9132	4	0-42511-20935-0
234-9133	4	0-42511-20936-7
234-9134	4	0-42511-20937-4
234-9135	4	0-42511-20938-1
234-9136	4	0-42511-20939-8
234-9137	4	0-42511-20940-4
234-9138	4	0-42511-12263-5
234-9139	4	0-42511-12264-2
234-9140	4	0-42511-20941-1
234-9141	4	0-42511-20942-8
234-9142	4	0-42511-20943-5
234-9143	4	0-42511-20944-2
234-9144	4	0-42511-20945-9
234-9145	4	0-42511-20946-6
234-9146	4	0-42511-12265-9
234-9147	4	0-42511-12266-6
234-9148	4	0-42511-12267-3
234-9149	4	0-42511-12268-0
234-9150	4	0-42511-11555-2



## UPC BARCODE REFERENCE



#PART / PIECE PARTE	#WIRES / FILS CABLES	UPC-A
234-9151	4	0-42511-11556-9
234-9152	4	0-42511-11557-6
234-9153	4	0-42511-12269-7
234-9154	4	0-42511-12270-3
234-9155	4	0-42511-12271-0
234-9156	4	0-42511-12272-7
234-9299	4	0-42511-11782-2

## New Part Numbers

NEW PART NUMBERS		
OXYGEN AND AIR/FUEL SENSORS		
234-4600	234-4973	234-5169
234-4939	234-4974	234-5170
234-4940	234-4975	234-5171
234-4941	234-4976	234-5172
234-4944	234-4977	234-5173
234-4945	234-4978	234-5174
234-4946	234-4979	234-5175
234-4947	234-4980	234-5176
234-4948	234-4981	234-5177
234-4949	234-4982	234-5178
234-4952	234-4983	234-5180
234-4956	234-4984	234-5181
234-4957	234-4985	234-5182
234-4958	234-4986	234-5183
234-4959	234-4987	234-5184
234-4960	234-4988	234-5185
234-4961	234-4989	234-9138
234-4962	234-4990	234-9139
234-4963	234-4991	234-9146
234-4964	234-4992	234-9147
234-4965	234-4993	234-9148
234-4966	234-4994	234-9149
234-4967	234-4995	234-9153
234-4968	234-4996	234-9154
234-4969	234-5165	234-9155
234-4970	234-5166	234-9156
234-4971	234-5167	
234-4972	234-5168	

## Superseded Part Numbers

SUPERCEDED PART NUMBERS	
Previous Part #	New Part #
234-1005	234-1018
234-2009	234-2068
234-5002	234-5060
234-5007	234-5113
234-5008	234-5119

Sellout	Reorder
234-4469	234-4475
234-4531	234-4474
234-4532	234-4475
234-4542	234-4044
234-4554	234-4545
234-4556	234-4622
234-4558	234-4069
234-4915	234-4879
234-4918	234-4496
234-4919	234-4878
234-5111	234-5045
234-5149	234-5125

# DENSO



Check out the entire family of DENSO products for the aftermarket.

Alternators • Cabin Air Filters • Compressors • Condensers • Direct Ignition Coils (COP) • Evaporators  
Air Filters • Oil Filters • Fuel Injectors • Fuel Pumps • Ignition Wire Sets • Mass Air Flow Sensors  
Oxygen & Air/Fuel Sensors • Radiators • Relays • Spark Plugs • Starters • Wiper Blades  
Engine Management Systems • Tire Pressure Monitor Systems

