

SSC1 Sport White Standard LED Pod



FEATURES

STAGE
SERIES



- Compact single-LED form factor
- High intensity LED chip
- Backlighting available in amber and red
- Durable powdercoated aluminum construction
- Integrated Deutsch-style connector
- Designed, torture tested and assembled in USA

GENERAL SPECIFICATIONS

Optic	Peak Beam Intensity (Candela)	Illuminance (lux @10m)	Measured Output (Lumens)	Raw Output (Lumens)	Output Color
Wide	2,500 cd	25 lux	1,030 lm	1,449 lm	6000K White
Flood	400 cd	4 lux	1,030 lm	1,449 lm	6000K White
Spot	50,000 cd	500 lux	1,030 lm	1,449 lm	6000K White

Functions: White Output with Amber and Red Backlight

Voltage Range: 9-16V

Current Draw (amps @ 12.8V): 1.1A (output), 24mA (backlight)

Wattage: 13.6W (output), 0.3W (backlight)

Connector Type: 4 Pin DT Connector

Driver Type: Integrated Driver

LED Type/Count: Cree XPL 6000K/1 total, 3014/3 total

Compliance Rating: J575 Durability Test

Intrusion Rating: IP67 Weatherproof

Operating Temperature: -40°C to 85°C

What's Included:

- One (1) or Two (2) SSC1 Standard LED Pods
- One (1) or Two (2) Deutsch-style wire pigtails
- One (1) or Two (2) Mounting brackets and hardware

Dimensions & Weight:

Length: 7.5" **Width:** 4.5" **Height:** 3"

Weight: 0.7 lbs (single), 1.2 lbs (pair)

SKUs: Append "S" to the end of each SKU for single and "P" for pair

DD6440 SSC1 Sport White Wide Standard ABL
DD6441 SSC1 Sport White Wide Standard RBL

DD6445 SSC1 Sport White Flood Standard ABL
DD6446 SSC1 Sport White Flood Standard RBL

DD6450 SSC1 Sport White Spot Standard ABL
DD6451 SSC1 Sport White Spot Standard RBL

All data and specifications are nominal values and may vary.

PUBLISHED: 10-24-2024

COLORIMETRIC SPECIFICATIONS

WHITE MAIN BEAM

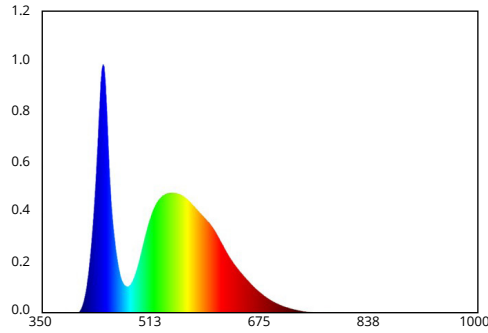

Spectral Distribution

CHROMATICITY

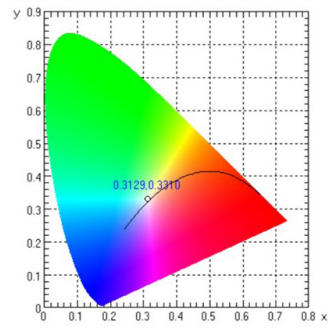

X=0.3129, Y=0.3310

AMBER BACKLIGHT

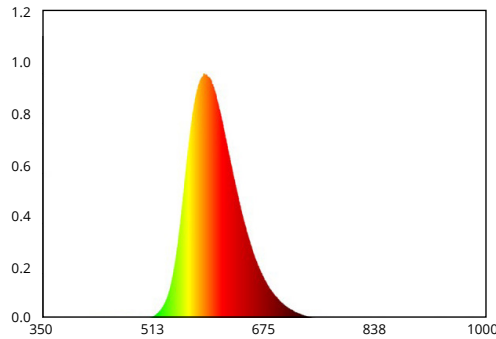

Spectral Distribution

CHROMATICITY

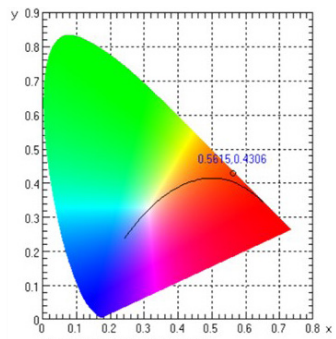

X=0.5615, Y=0.4306

RED BACKLIGHT

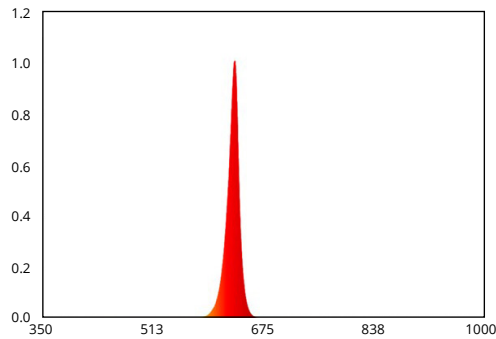

Spectral Distribution

CHROMATICITY

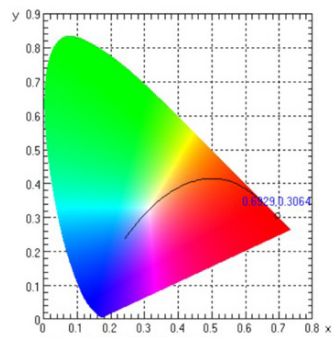

X=0.6929, Y=0.3064

PUBLISHED: 10-24-2024

PRODUCT DIMENSIONS

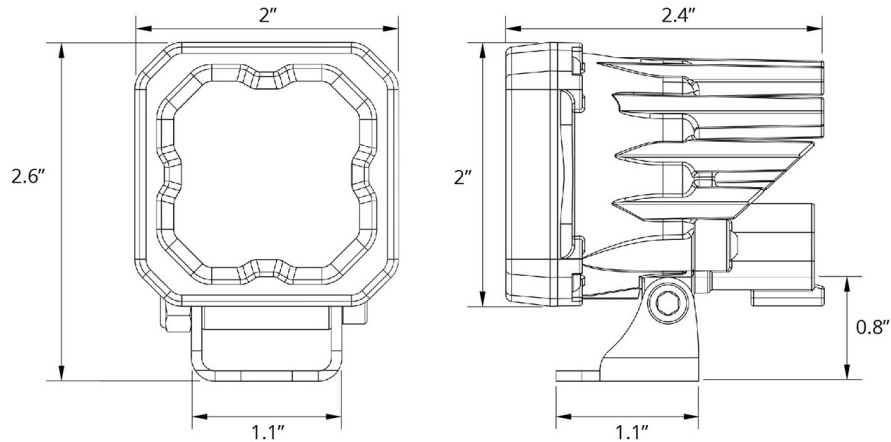

PHOTOMETRIC SPECIFICATIONS

Wide Optic Isolux

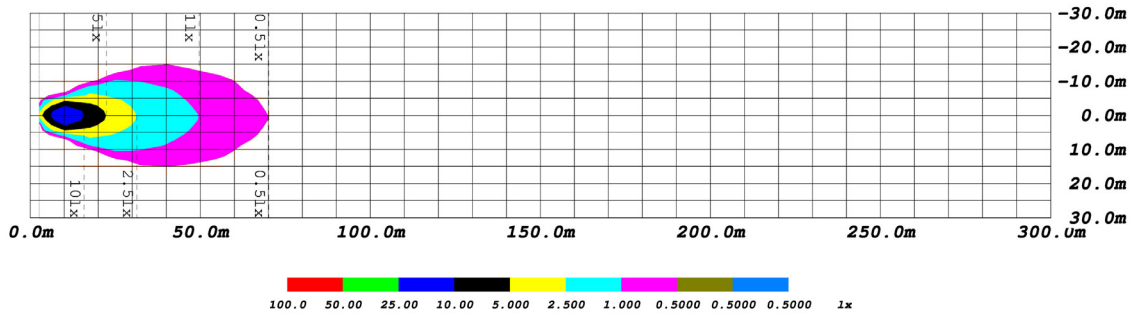

Wide Optic Perspective

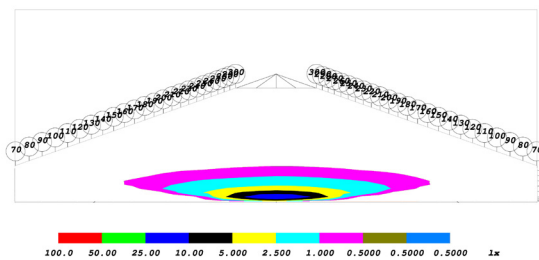

Wide Optic Isocandela

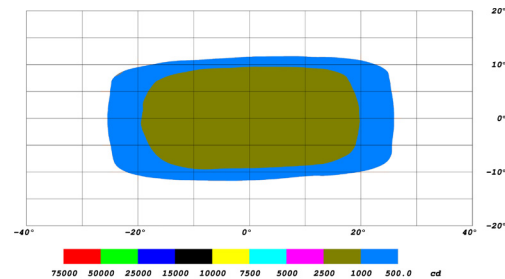

PUBLISHED: 10-24-2024

PHOTOMETRIC SPECIFICATIONS (cont.)

Flood Optic Isolux

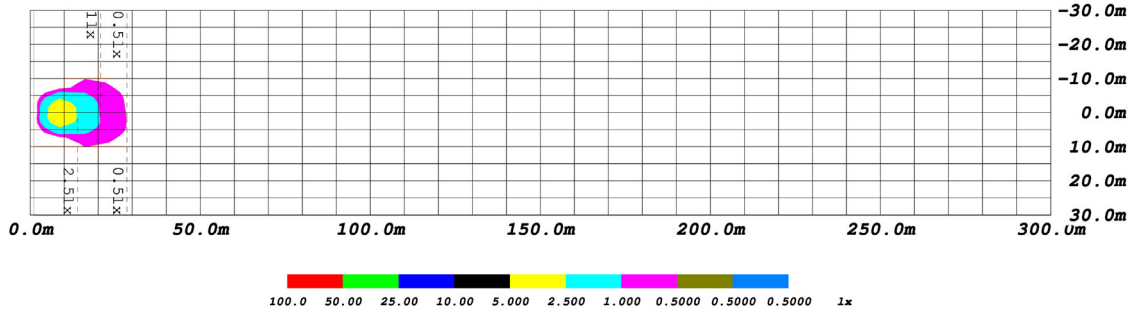

Flood Optic Perspective

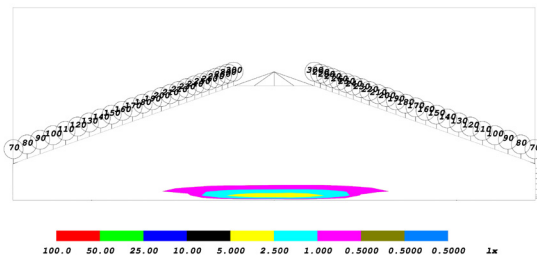

Flood Optic Isocandela

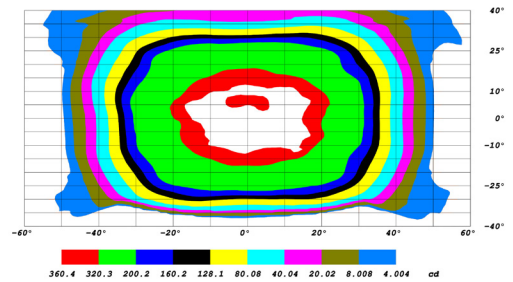

Spot Optic Isolux

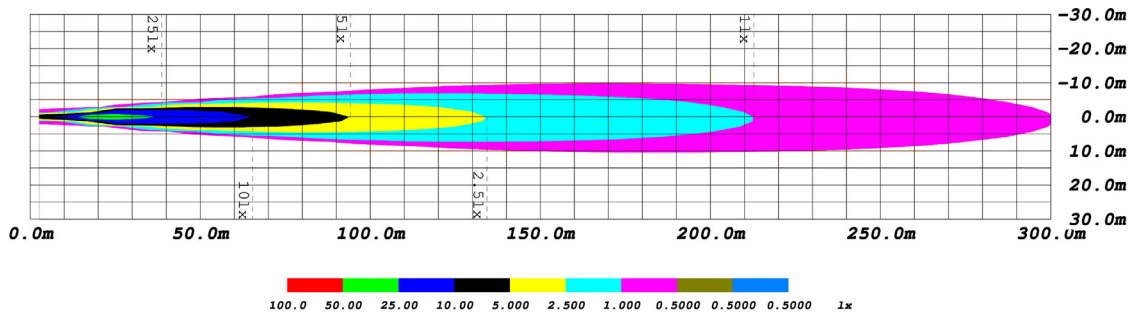

Spot Optic Perspective

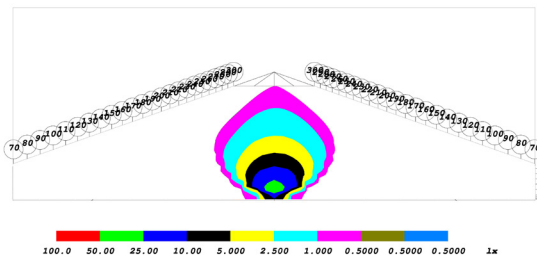

Spot Optic Isocandela

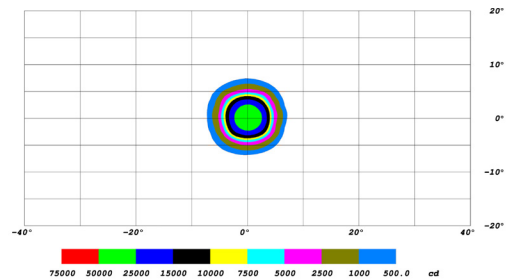

PUBLISHED: 10-24-2024