

2005-Present Ford Super Duty 250/350 **- 4x4, Front Axle, “Free Spin” Conversion Kit**

Some of the less common tools, which will be required:

- 6 point Spanner socket (OTC #7090-A or equivalent). These can be purchased from Dynatrac or a good auto parts store.
- #27 Torx bit
- Torque wrench
- Loc-tite thread locking compound

Preparation, Inspection and Clearance Checks

1. Read all instructions completely. Only perform this installation if you are an experienced, fully equipped mechanic. Inspect all boxes and packing material to expose all the parts in the kit. Using the bill of material attached, verify that the kit is complete. Contact Dynatrac about any shortages. Do not start the installation until you are sure you have everything you need. Allow yourself plenty of time. You will need anywhere from 3 to 7 hours depending on your skill and experience level.

 **WARNING: Only perform this installation if you are experienced, fully equipped mechanic.**

 **WARNING: Always wear proper safety equipment including safety glasses and gloves while working with tools. Improper use of tools and equipment can cause injury or death.**

2. If installing onto a truck with Dual Rear Wheels, fit the front wheel adapter to the Dynatrac Hub to confirm fitment. If the stock wheel adapter does not fit, contact Dynatrac immediately.
3. This kit has been designed to be compatible with:
 - a. All stock suspensions and does not interfere with most commercially available lift kits.
 - b. All stock wheels. It also does not interfere with most commercially available aftermarket wheels.
 - c. F250/350 Single Wheel (SRW) and Dual Rear Wheel (DRW) trucks equipped with the 8 on 170mm wheel pattern.
 - d. Tires up to 40” tall and 18.5” wide.

 **WARNING: Never violate the tire manufacturer’s guidelines for rim compatibility.**

 **WARNING: Never violate the vehicle manufacturer's guidelines for Gross vehicle weights (GVW) or Gross Axle weight ratings (GAWR). This Kit does NOT increase the rated load capacity of your vehicle.**

4. This kit requires that the front locking hubs be manually engaged and disengaged when 4-wheel drive is used. The auto-locking hub feature, available on some vehicles, will no longer function.

 **INFORMATION: If you had automatic vacuum hub locks they will be replaced by manual locking hubs.**

5. Inspect all parts first. If a part looks damaged or does not appear to fit or function correctly, then contact Dynatrac for a replacement part. Dynatrac cannot give any credit or refunds on altered or abused parts.
6. If your truck is ABS equipped make sure the new hubs have tone rings mounted on the short side of the new hubs.

 **WARNING: If tone rings are not installed on your hubs, the ABS system will not work.**

7. Inspect the inside of the new wheel hubs for any debris or dirt. Wash the inside thoroughly with rags, solvent or hot soapy water.
8. Compare the wheel studs in the kit with your stock wheel studs. Ford uses 2 types of wheel studs. Type 1 is 14mm x 2.0 thread pitch (coarse) and is most common. Type 2 is 14mm x 1.5 thread pitch (fine). If the studs in the kit do not match your stock studs, you may contact Dynatrac for replacements.

 **CAUTION: Confirm that you have the proper wheel studs to match your current lug nuts before pressing the wheel studs into the new hub.**

9. Raise the front axle off the ground and secure with jack stands. Remove the wheels. Remove the calipers and hang them from the frame without disconnecting the brake hoses. Remove the rotors.

 **WARNING: Always use appropriate jack stands when raising your vehicle. Never work under a vehicle that is not properly secured. Be sure to chock any wheels that are on the ground.**

10. **Single Wheel (SRW) Vehicles** - There are 2 pilot diameters machined on the outer end (long side) of the new wheel hubs. The inner pilot (larger diameter) is for the rotor and the outer pilot (next one down) locates the wheel. Make sure that the rotor and the wheel fit easily but closely around their respective pilot diameter. Trial fit the new wheel hubs on both sides of the truck with your rotors and wheels at this time.

Begin Front Axle Teardown:

11. **If truck is equipped with front ABS:** Remove the sensor and cable from the unit bearing. It is held in with only 1 screw, and pulls straight out. Tie off and out of the way. At this time make certain that the hubs included in the kit have ABS tone rings pressed on to the short side of the hub. If the hubs do not have the tone rings mounted, contact Dynatrac immediately for replacements.



WARNING: If tone rings are not installed on your hubs, the ABS system will not work.



CAUTION: Be careful not to damage the ABS sensor while removing it from the unit bearing.

12. Remove the stock locking hub. The stock locking hub is held in with **#27 Torx screws**. Once they are removed you may need to slightly pry the hub loose with a small pry bar. They should slide out easily.



CAUTION: Wear safety glasses at all times when working with tools.

13. Remove the unit bearing assembly. It is held in with (4) 14mm nuts (requires 21mm socket) located on the backside of the stock knuckle. Set aside.
14. Remove the brake dust shield and set it aside. It is only held on by the unit bearing. You will be re-installing the dust shield with the kit.
15. Remove the axle shaft assembly. It is only held in by tight seal tension at the differential. Use 1 or 2 pry bars behind the u-joint yoke, and the end of axle housing to pull straight outward. Set aside.
16. If equipped, remove the vacuum hose that activates the auto locking hub feature, from the top of the knuckle. Plug the vacuum circuit and secure the loose end of the hose. It will no longer be used.

17. Use the original nuts and studs that held the unit bearing in place to remove the 4 studs from each unit bearing. You can accomplish this by stacking 2 nuts on each stud and tightening them against each other. Then using a wrench, you can loosen the stud and unscrew it from the unit bearing assembly. Repeat this until you have all 8 studs free for re-use on the new spindle assemblies. Set them aside.
18. Separate the stock outer axle shaft stubs from the stock inner axle shafts by pressing out the U-joint. If the old joints are suspect or worn out, this is the best time to replace them. Dynatrac stocks Spicer and other high quality joints. They can usually be shipped that same day via next day air.

 INFORMATION: Replace old U-Joints if they appear worn.

Begin Axle Assembly:

19. Assemble the new 35-spline outer shafts onto the stock inner shafts by pressing in the U-joints.
20. Clean the shoulder of the outer shaft with solvent. Apply a small film of silicone gasket sealer to the shoulder. Press (usually by hand) the shaft dust boot over the shoulder on the outer axle shafts as shown in **Illustration A**. Remove any excess silicone. After the silicone sets it will help hold the boot in place.

 CAUTION: Wait 20 minutes before assembly so that the silicone will cure properly and seal fully.

21. Make certain that there is no loose dirt or debris inside the tubes of the axle housing. Clean out as needed. **DO NOT PUSH DEBRIS INTO THE GEAR HOUSING** when installing axle shafts.

 CAUTION: Clean the inside of the axle tubes so you don't contaminate the inside of the axle with dirt when you reinstall the shafts.

22. Put some grease on the splines and seal surface of the inner shaft, then insert into the axle housing. Guide the shaft up into the seal and gears. Use a rubber mallet to tap the end of the shaft inward until it stops. You may have to rotate the shaft to align the splines in the differential.
23. Apply a drop of Loc-tite to one end of the original unit bearing studs and install them into the new spindles shown in **Illustration B**. **THEY MUST BE FULLY THREADED** into the flange of the spindle.

 WARNING: The original unit bearing studs must be FULLY threaded into the flange of the new spindle.

24. If not already pre-assembled, press the small seal/thrust washer assembly into the back of the spindle. See **Illustration B**. If they have somehow separated they can be easily snapped back together.
25. Note that the spindle comes as a factory Dynatrac pre-assembled part. **DO NOT** attempt to separate the assembly.



WARNING: The spindle comes as a factory Dynatrac pre-assembled part. DO NOT attempt to separate the assembly.

26. The inner spindle needle bearing must be generously packed with grease. Coat the area over the thrust washer with plenty of grease. Also generously coat the inside of the dust boot on the outer axle shaft with grease.
27. Replace the sheet metal brake dust shield between the knuckle and the new spindle. Slide the new fixed spindle assembly over the end of the shaft and align the studs with the holes in the knuckle. Make sure the ABS sensor-mounting slot is located in the 12 o'clock position.
28. Push the spindle on until it is fully seated with the knuckle. Install the stock 14mm nuts and torque to factory specifications or 140 ft lbs.



WARNING: Use a calibrated torque wrench on all bolts.

29. If the bearing races are not already installed in the wheel hubs, use a race driver or equivalent to install them at this time. Snap-on, 9/16 race driver, #PPC14LA works great. If you don't already have one, buy it. You'll be glad you did.
30. **Review Step 7.** Do you have the correct wheel studs? If so, drive or press new wheel studs supplied in the kit, into the new wheel hubs at this time. **DO NOT** attempt to re-use the old studs. **DO NOT** pull the studs through with a lugnut as this will risk your safety and the safety of those around you on the highway. The new studs should go in very tight but be fully seated.



WARNING: DO NOT attempt to re-use the old studs. DO NOT pull the studs through with a lug nut as this will risk your safety and the safety of those around you on the highway. Improperly installed studs can cause major failures that could lead to injury or death.

31. In the new hubs, fill the area between the races with new, quality, disc brake wheel bearing grease. Fill completely to the inside edge of the inner & outer races. Don't skimp on the grease.
32. Pack the new wheel bearings with grease. Load the inner bearing into the new hub and press the seal into the back of the hub. Use your finger to fill the area between the lips of the seal with grease.
33. After fully packing with grease, install the new wheel hubs onto the spindles. Be careful not to damage the hub seal as it slides over the threaded end of the spindle. Push the hub onto the spindle until the inner bearing bottoms out. Push the outer bearing over the end of the spindle and into the open end of the hub. It must seat against the outer race in the wheel hub. **DO NOT** use the spanner nuts to force the hub and bearings onto the spindle. If necessary, you may gently use a rubber mallet to tap the outer edge of the hub.



CAUTION: Be careful not to damage the hub seal when installing it over the threaded end of the spindle.



WARNING: DO NOT use the spanner nuts to force the hub and bearings onto the spindle. If necessary, you may gently use a rubber mallet to tap the outer edge of the hub.

34. There are two identical 6-point style spanner nuts in the kit. Screw the inner spanner nut onto the end of the spindle and torque to 50 ft lbs while rotating the hub. Then back off the inner nut approximately 1/8 of a turn. See page 1 for sourcing the proper hub socket. **DO NOT** use punches to tap the nuts around.



WARNING: Use the proper tools and procedure to install the spanner nuts or you may damage the bearings.

35. Install the star shaped lock washer with the outer tabs pointing outward. Align the tab on the inside of the washer with the slot in the spindle. Put coat of grease on the back of the outer spanner nut. Screw the outer spanner nut on the spindle and tighten to 65-70 ft lbs. Then bend at least one of the tabs over the front of the outer nut into one of the 6 points on the nut. The hub should spin freely with no pre-load on the bearings, but not have more than .001" of end play.
36. Install the new premium locking hubs. The gear body just slides in, and is held in place by the big internal snap ring.



CAUTION: Further instructions are included with the locking hubs follow them for proper installation.

37. The small snap ring goes over the tip of the outer axle shaft. The cap is held on by the 6 small allen screws. Do not over tighten the small allen screws. Check the hubs by locking and unlocking several times. Rotate the wheel forward and backward while simultaneously turning the knob if you feel too much resistance.



WARNING: Never use tools to turn the knob on the locking hub; it should turn without the use of a tool.

38. **ABS Equipped Only:** Insert the ABS Sensor into the mounting hole on the spindle flange. Use the stock screw to draw the sensor fully into the flange. Make sure to tighten it slowly and rotate the hub at the same time. This rotating process is to insure that there is proper clearance between the sensor and the tone ring. If while you are tightening the ABS sensor the hub stops moving due to interference, call Dynatrac immediately for further instructions. Make sure to route the sensor harness accordingly through the brake dust shield



WARNING: Make sure that the ABS sensor does not contact the tone ring it can be damaged resulting in the ABS system to malfunction.

39. Install the stock brake rotor over the outside of the wheel hub and hold it in place with 2 lug nuts. Route the cable for the ABS sensor so it will NOT touch the inside of the rotor during vehicle operation. Secure as needed.



WARNING: Make sure that the ABS sensor cable is secure and clear of the rotor.

40. Put the caliper back over the rotor and note the space between the mounting bracket on the caliper and the mounting ears on the stock knuckle. Tighten the bolts to factory specs. Spin the rotor and make certain that the caliper has adequate clearance from the brake rotor.
41. Mount the rims and tires. When correctly installed, this kit does not affect or alter the front wheel alignment.
42. Re-checks of torque on all fasteners at 100 and 500-mile intervals is absolutely necessary for safety. Keep re-checking all bolts until torque is maintained. Especially, do not forget the following:
 - a. Wheel hub endplay and lug nut torque.
 - b. Brake caliper mounting bolts.
 - c. Wheel lug nuts.



WARNING: Check your bolt torques per instructions and replace any bolts that do not maintain torque. Loose bolts can cause a mechanical failure that could lead to injury or death.

ⓘ INFORMATION

Proper Use Of Locking Hubs and 4-Wheel Drive:

1. To Engage 4WD:
 - a. Stop the vehicle and turn the locking hub knobs clockwise to the “Lock” position.
 - b. Rock the vehicle forward and aft just a couple of feet at least twice to give the hubs a chance to fully engage.
 - c. Now you may engage the 4WD button (electric models) or by moving the transfer case shift lever to 4WD. You are ready to go.
2. To Disengage 4WD:
 - a. Stop the vehicle and shift the transfer case back to 2WD, or release the button on the dash to switch back to 2WD.
 - b. Turn the locking hub knobs counter-clockwise to the “Free” position.
 - c. Rock the vehicle forward and aft just a couple of feet at least twice to give the hubs a chance to fully disengage. You are ready to go.

Proper Wheel Bearing Maintenance:

1. NORMAL CONDITIONS - Inspect and/or adjust front wheel bearing assemblies every 30 months or 30,000 miles whichever comes first.
2. Harsh conditions may require more frequent attention.
3. If the cap of the locking hub has been submerged under water for more than 1 minute, or is frequently submerged, then the hubs should be inspected as soon as is reasonably possible. In most cases service will not be required, but if enough water penetrates the assembly, the locking hubs and or wheel bearings can be damaged if left un-attended.

Bill of Material:

**05'-Present Ford "Free Spin" Hub Kit
FO60-2X1104-C**

<u>Description</u>	<u>Quantity</u>	<u>Dynatrac P/N</u>
Hub assy	2	FO60-1104-A
Spindle assy	2	DA60-3105-AK
Thrust Washer & Seal Combo	2	DA60-1X1175-A
Boot Seal	2	DA60-1175-F
35 spline Outer Shaft	2	DA60-3B387-J
Inner Wheel bearing	2	DA60-1244-A
Outer Wheel bearing	2	DA60-1244-B
Hub Seal	2	DA60-1175-D
Spindle Nut 6 Pt.	4	DA60-1195-A
Spindle nut washer	2	DA60-1198-A
Warn Locking Hubs - 35 spline	1	DA60-3B396-B
ABS - Tone ring Mtd on hub	2	DA60-2C189-A
Wheel Studs - Stock Fine 1.5	16	FO60-1107-C

F060-2X1104-C 2005-PRESENT FORD FREE SPIN KIT

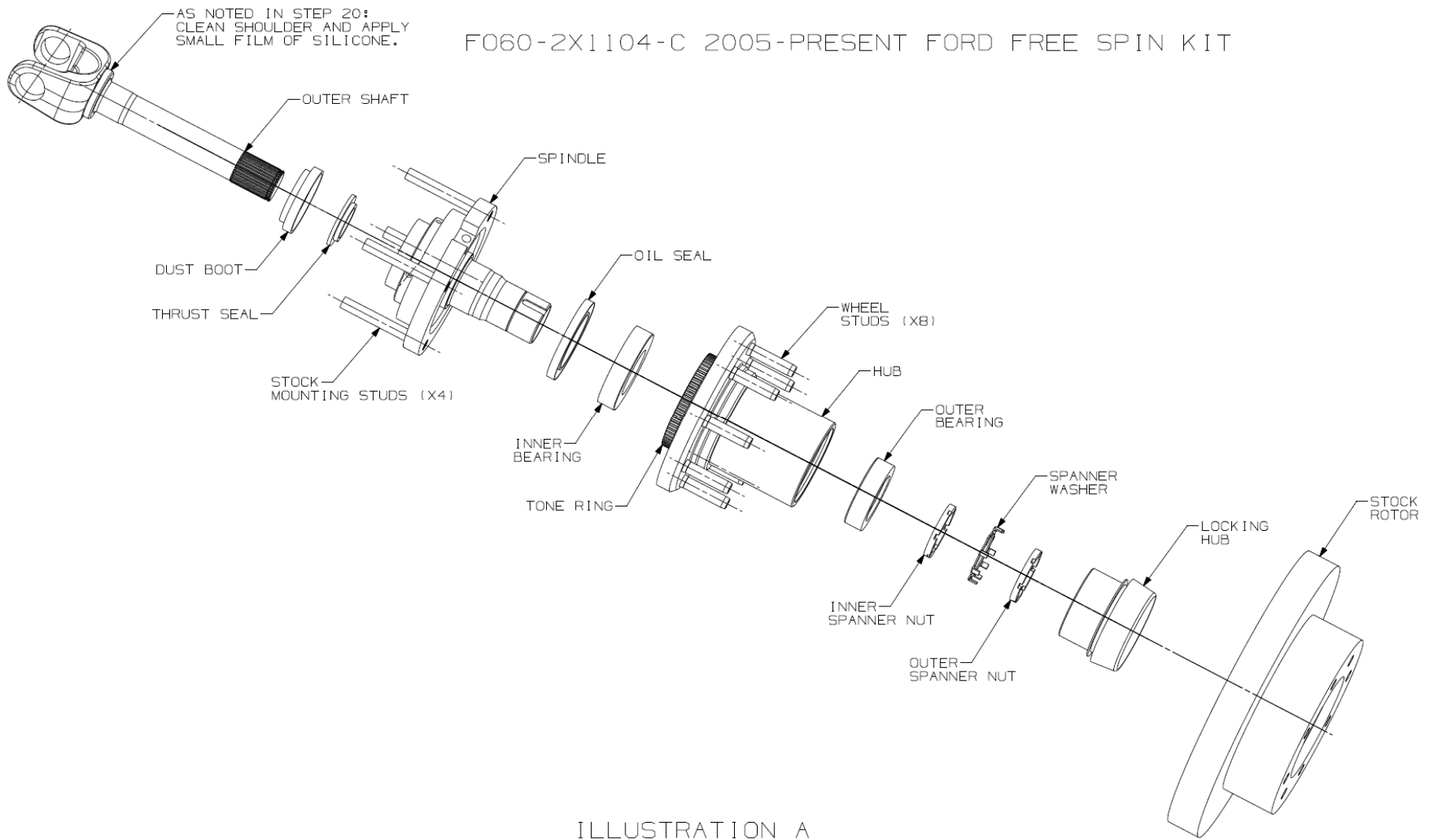

ILLUSTRATION A

DYNATRAC SPINDLE ASSEMBLY, 05+ FORD SUPERDUTY FREE SPIN

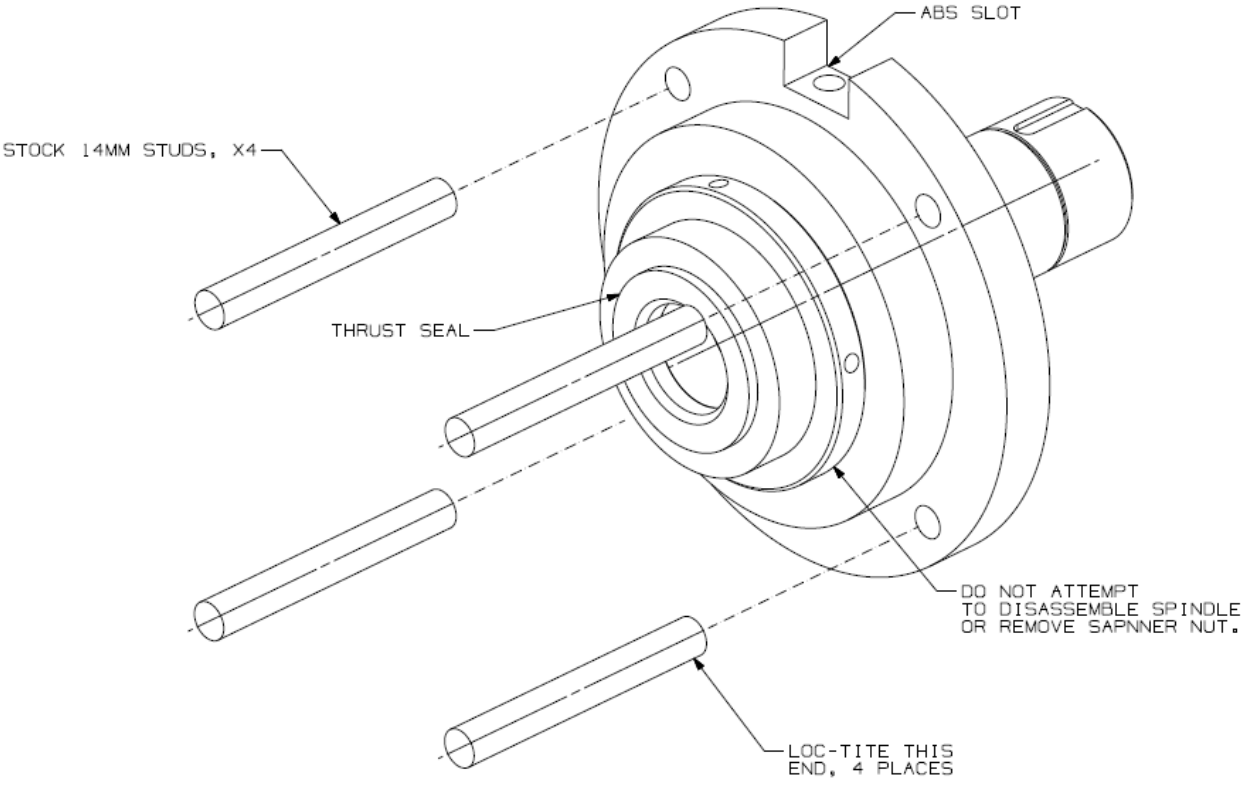

ILLUSTRATION B