

Eaton Differentials Owner's Manual

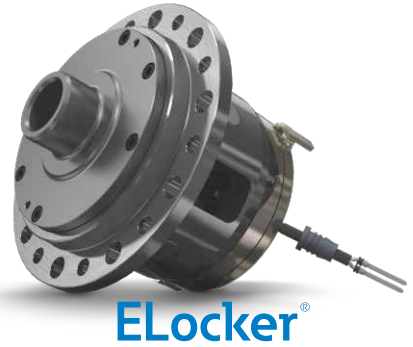

Powering Business Worldwide

Eaton Differentials Install Manual

Table of Contents

Preface.....	2
History.....	2
Warranty.....	4
Detroit Locker / NoSPIN.....	6
Detroit Truetrac.....	10
Eaton Posi.....	14
Eaton ELocker.....	18
Safety, Lubrication.....	22
Installation.....	27
Axle Identification.....	43
FAQ.....	47
Glossary.....	54

Preface

Eaton has been a leading manufacturer of premium quality OEM, military and aftermarket traction enhancing and performance differentials for more than 80 years. Each step in our manufacturing process, from design to final assembly and inspection, reflects the highest industry quality and engineering standards. This manual is intended to help provide safe and trouble-free operation for the life of the product.

Automotive Focused History of Eaton

- 1900- Viggo Torbensen develops and patents the first gear-driven rear truck axle
- 1911- Torbensen teams up with Joseph Eaton, an aspiring young businessman, to found Torbensen Gear and Axle
- 1911- Torbensen Gear and Axle manufactures just seven axles in its first year, using specialized tools to handcraft them from raw materials
- 1915- Torbensen Gear and Axle Company moves its growing operations from Newark, NJ to Cleveland, OH, which was becoming an automobile and truck manufacturing center
- 1916- US highways improve and Torbensen produces 10,068 truck axles
- 1917- Republic Motor Truck (largest US truck manufacturer at the time) acquires Torbensen Axle
- 1919- Torbensen Axle produces 70,000 axles annually
- 1919- J.O. Eaton sells off his stock in Republic Motor Truck and forms Eaton Axle Company,

- manufacturing conventional and internal gear truck axles
- 1920- Eaton Axle Company builds a new \$1 million plant in Cleveland, OH
- 1922- Eaton Axle Company buys back the Torbensen Axle division of Republic Motor Truck
- 1923- Torbensen Axle purchases two spring manufacturing plants
- 1923- Torbensen Axle officially becomes Eaton Axle and Spring, manufacturing was approaching 150,000 axles annually and 10,000 springs daily
- 1926- Eaton Axle and Spring launches production of Ruckstell Axles for Ford Motor Company passenger cars and trucks, including the Model T
- 1928- Eaton acquires Perfection Heater (first manufacturer of automotive heaters) and Easy-on Cap (manufacturer of fuel and radiator caps)
- 1930- Eaton acquires Wilcox-Rich, a leading manufacturer of sodium-cooled aircraft engine valves
- 1940- The newly renamed Eaton Manufacturing Company begins production of components for Cadillac's new Hydra-Matic and Chrysler's new Fluid Drive transmissions
- 1952- Eaton develops the first affordable automotive air system
- 1958- Eaton acquires Fuller Manufacturing, producers of medium and heavy duty transmissions
- 1963- Eaton acquires Dole Valve Company, developer of the automotive engine thermostat
- 1967- Eaton develops one of the first passenger car air bag systems
- 1970- Eaton acquires the Char-Lynn Company, manufacturer of hydraulic motors for agricultural and industrial equipment
- 1978- Eaton acquires Cutler-Hammer and enters the electronic controls market
- 1997- Eaton effectively trades its axle and brake business to Dana in exchange for their Spicer Clutch Division, manufacturer of medium and heavy duty truck clutches
- 1999- Eaton acquires Aeroquip-Vickers, entering the fluid power business
- 2002- Eaton acquires Boston Weatherhead from Dana Corporation, manufacturer of hydraulic metal fittings and hoses
- 2005- Eaton acquires Tractech Inc, manufacturer of performance, agricultural, industrial, and military vehicle powertrain differentials

Differential Limited Warranty and Information

Eaton expressly warrants each Eaton differential part to be free from defects in materials and workmanship for a period of 12 months from the date of initial retail purchase when used on private passenger cars and light trucks under normal operating conditions.

Eaton's obligation under this warranty is limited to replacement of the worn-out or defective product in accordance with this warranty. Cost of removal and installation are not included, and any incidental and consequential damages are excluded under this warranty, regardless of when the failure occurs. This warranty has no cash value. This warranty does not apply to products that have been modified, improperly applied or installed on vehicles used for commercial or racing purposes.

To make a claim under this warranty, return the worn-out or defective product with the dated original receipt to the dealer or retailer from whom it was purchased for verification and exchange under this warranty.

This warranty gives you specific legal rights, and you may also have other rights, which vary from state to state. Any implied warranties you may have under state law are limited to the same duration as this warranty. Some states do not allow limitations on how long an implied warranty lasts or do not allow the exclusion or limitation of incidental or consequential damages, so the above limitations and exclusion may not apply to you.

Eaton may contact warranty-serviced consumers to conduct customer satisfaction surveys relating to product and warranty service. Survey activity will provide valuable feedback and help measure the level of consumer satisfaction in different markets.

Qualifying Aftermarket Products

- Eaton Posi™
- Eaton ELocker®
- Detroit Locker®
- Detroit Truetrac®
- Detroit NoSPIN®

Differential Application Guide



Differentials	Selectable locking	Automatic locking	High bias limited slip	Medium bias limited slip
Detroit Locker®		●		
Detroit Truetrac®			●	
Eaton ELocker®	●			
Eaton Posi™				●
Detroit NoSPIN®		●		

Application Guide

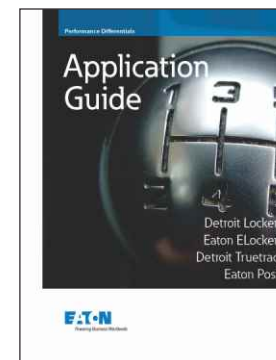

Owners Manual



Detroit Locker® / NoSPIN®

Heavy duty automatic locking differential

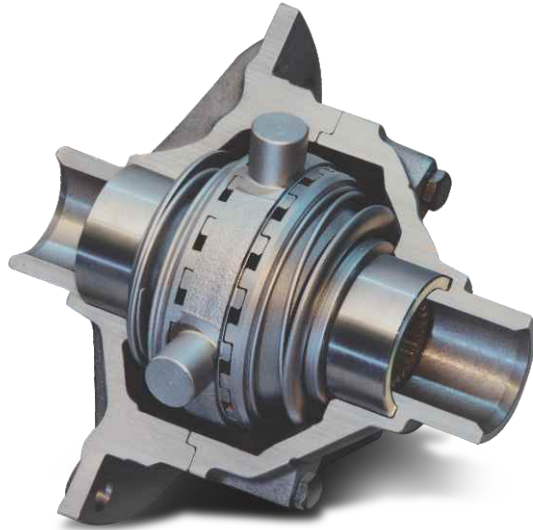

NOTES

187C145A, 187C146A, 187C147A 4.56, 4.88 and 5.13 gear ratios require some modification for install.

187S196A Designed to fit axles cut with 45-degree pressure angles.

187S196A Custom housing with 3.25" bearing bore.

187C148A, 187C149A, 187C150A All Eaton differentials made for General Motors 8.5" and 8.6" axles require special bearings. For axles with small bearing bores (race O.D. or 2.89"), usually found on vehicles prior to 1999, bearing LM102949 and race LM102911 are required. For axles with large bearing bores (race O.D. of 3.06"), usually found on vehicles from 1999 to present, bearing LM603049 and race LM603012 are required.

250SL195A 2007 and newer vehicles require model years 2003-2006 ring and pinion.

225SL58A, 225SL58B, 225SL58C, 225SL58D For Dana 70/70HD, 35 spline applications: If differential case is one-piece use Detroit Locker #225SL58 (A,B,C,D); If differential case is two-pieces use Detroit Locker #225S18.

Eaton's Detroit Locker, also known as a NoSPIN, is a fully automatic, positive-locking, traction differential. NoSPIN products are designed to replace the internal gear set of the factory or open differential, while Detroit Locker models are designed to replace the entire differential. Both the NoSPIN and Detroit Locker operate functionally identical as a locking differential. The products are known around the world for premium performance, dependable operation and unmatched durability. This differential is the culmination of more than 80 years of engineering for both original equipment and performance upgrade applications. NoSPIN is a proven performer for light, medium and heavy-duty trucks, off-highway, agricultural, forestry, military, specialty-equipment vehicles, performance off-road, circle track racing and drag racing.

The Detroit Locker / NoSPIN maximizes traction by delivering 100 percent of the torque and power to both drive wheels. It is engineered to keep both wheels in a constant drive mode, yet has the ability to automatically "unlock" to permit necessary wheel speed differentiation when negotiating turns, maintaining 100 percent of the powertrain torque to the driving wheel. The Detroit Locker / NoSPIN is maintenance free and doesn't require special lubricants or service adjustments. Conventional differentials allow vehicles to get stuck when they lose traction on one side. This superior product continues to drive your

vehicle even if one of the wheels is suspended in the air, or in the event of axle shaft failure.

Benefit

- Provides a fully locked axle that automatically unlocks when wheel speed differentiation is necessary
- Maximum torque delivery to the high traction wheels
- Maintenance free - requires no special lubrication or friction modifiers
- Extremely strong and durable unit
- 100 percent automatic locking action - even with one wheel off the ground

Technical Specifications

- Most commonly found in rear drive axle applications; however, the Detroit Locker and NoSPIN differentials also have select front, and transfer case applications
- Compatible with most advanced anti-lock brake systems
- Speed-sensitive automatic locking differential that powers both drive wheels, yet automatically permits wheel speed differentiation as needed

Applications

- Construction
- Military
- Agriculture
- Forestry
- Mining
- Torque delivery capacity of a spool with added ability to differentiate wheels in a turn
- Performance characteristics vary by application such as the M-series, N-series, R-series and race lockers
- Available for c-clip axle designs
- Detroit Locker models include the differential case
- NoSPIN models do not include the differential case
- Off-road performance
- Competition "monster" trucks
- Drag racing
- Stock car racing



NOTES

162SL60A, 162SL60B, 187SL16C, 187SL16D Applies to disconnect only.

162C66A Bearing LM102949 and race LM102911 and unique shims are required.

For Dana 61-1 full float, 1.31" axle shaft diameter, 30-spline axles: 3.31 & dn ratios use Detroit Locker #225SL19B.

225SL56A, 225SL58C, 225SL58D Full float only.

225SL105A, 225SL131A Will fit OE 3.73 thin gear sets.

225S10 differential replaces the conventional differential internals used in certain 1973 - present GM axles. If it is to be installed in a GM axle equipped with an optional Eaton differential, it will also be necessary to purchase a new gear support case assembly, GM #6258336 or #6258340, depending upon gear ratio.

187SL173A Axle serial numbers 49L11363C or 57L05188B and later.

187SL174A Axle serial numbers and later: Range Rover - suffix H, 88/109 4 cyl. ¾ ton - suffix H, 109 V8/1 ton - suffix D.

187SL173A Axle serial numbers 35S18135C or 37S08651B and later.

187SL174A Axle serial numbers and later: Range Rover - suffix F, 88 - suffix G, 109 V8/1 ton - (Salisbury standard), 109 4 cyl. ¾ ton - (Salisbury optional).

187SL61B 32010X bearing allows 913A610 in place of 913A611.

Detroit Locker® / NoSPIN® Function Check

NOTES

187SL16C, 187SL16D,
225SL29A For use of non-
thick ring gears.

Some applications
require drill modification
for fitment.

PLEASE READ COMPLETELY THROUGH AND UNDERSTAND THE INSTRUCTIONS BEFORE STARTING

Test Set-up

With the engine turned off and wheels chocked, raise Detroit Locker / NoSPIN equipped driving axle(s) until all tires are out of contact with any surface. Check both hand and foot brakes for possible drag caused by improper adjustment. Place the transmission in gear or park so that the **DRIVESHAFT IS LOCKED AND DOES NOT ROTATE.**

Step One

With two people, one on the left wheel and one on the right wheel, rotate the top of both wheels rearward, until both wheels lock and will not rotate farther in the rearward direction.

Step Two

With the top of the left wheel securely held in the rearward direction, rotate the right wheel slowly forward. A faint indexing or clicking sound should be heard as the Detroit Locker / NoSPIN disengages the right wheel. The right wheel should continue to turn freely in the forward direction.

Step Three

With the right wheel slowly rotating forward, the left wheel should be rotated forward to match the speed of the right wheel. This should re-engage both wheels and you should not be able to turn either wheel more than one additional revolution in this direction.

Step Four

Again, rotate the top of both wheels rearward, as far as possible to lock both wheels.

Step Five

With the top of the right wheel securely held in the rearward direction, rotate the left wheel slowly forward. A faint indexing or clicking sound should be heard as the Detroit Locker / NoSPIN disengages the left wheel. The left wheel should continue to turn freely in the forward direction.

Step Six

With the left wheel slowly rotating forward, the right wheel should be rotated to match the speed of the left

wheel. This should re-engage both wheels and you should not be able to turn either wheel more than one additional revolution in this direction. Repeat steps 1-6 reversing the direction of rotation in which the wheels are held and rotated. This tests for proper function in the opposite drive direction. If the above steps are completed successfully and rotating wheels disengage easily by hand, rotate freely and evenly, lock both wheels when required, and produce a faint indexing or clicking sound, then the Detroit Locker / NoSPIN is properly installed and is functioning correctly. **IF EITHER WHEEL DOES NOT ROTATE FREELY IN EITHER DIRECTION** or does not lock both wheels as required, re-check the installation of the Detroit Locker / NoSPIN in the axle (excluding the CTR series; the CTR series is designed exclusively for single direction, oval-track use only).

NOTE

Three exceptions are the R-series, N-series and Race series. The R-series does not unlock in reverse, while the N-series and Race lockers do not have holdout rings. The Detroit Locker / NoSPIN design very aggressively re-engages if the hold-out rings are not present.

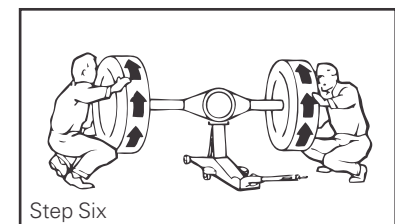
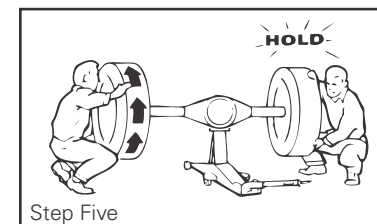
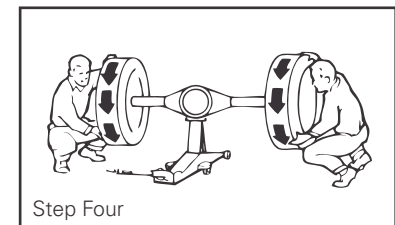
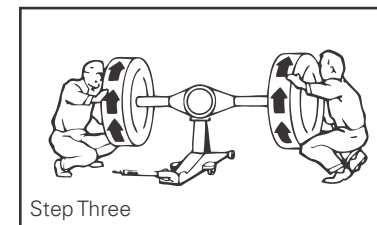
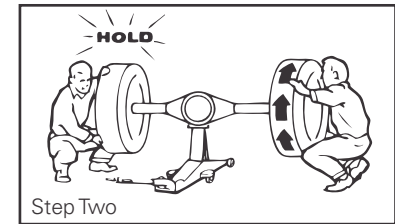
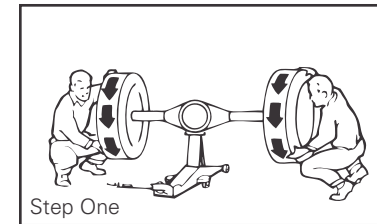

Detroit Truetrac®

High performance limited slip differential



NOTES

914A575, 914A576, 914A583 Detroit Truetrac, 33-spline units for this application are designed to fit axles cut with 45-degree pressure angles.

912A616 Bearing LM102949 and race LM102910 are required.

913A555, 914A575, 914A576 Designed to fit axles cut with 45-degree pressure angles.

912A556, 912A557, 913A481 All Eaton differentials made for General Motors 8.5" and 8.6" axles require special bearings. For axles with small bearing bores (race O.D. of 2.89"), usually found on vehicles prior to 1999, bearing LM102949 and race LM102911 are required. For axles with large bearing bores (race O.D. of 3.06"), usually found on vehicles from 1999 to present, bearing LM603049 and race LM603012 are required.

914A643, 915A568 2007 and newer vehicles require model years 2003-2006 ring and pinion.

912A584, 912A585, 913A591, 913A592 Applies to disconnect only.

915A450, 916A427 Will fit OE 3.73 thin gear sets.

The Detroit Truetrac is the leading helical gear-type limited slip differential in the industry. Eaton has a proven track record of producing the most effective and dependable traction differentials in the world. Truetrac's patented design of parallel axis, planetary helical gears, provides a smooth and quiet automatic division of torque. Power transfer is so smooth, it is typically unnoticed by the driver, even in front wheel drive axles. Although Truetracs offer the highest bias ratio in the forward direction, they also exhibit a slightly reduced bias ratio in the reverse direction or during engine braking. The bias performance of the Truetrac complements and enhances brake-based traction control systems. Under normal driving conditions, Truetrac performs like an open differential. On wet, muddy, icy or loose terrain, imbalanced gear forces automatically transfer power to the wheel with the highest traction. The Truetrac limited-slip differential responds instantly to torque feedback, providing needed traction, anytime, at any speed. Truetrac differentials are engineered to work efficiently in front and rear axles and transfer cases. Designs exist for C-clip, full-float, semi-float, and snap-ring style axle configurations. Proven design, low cost and effective performance all make the Truetrac limited-slip differential the ideal choice for a wide variety of vehicle applications, including road racing, off-road competition, emergency vehicles, motor homes and commercial trucks.

Benefit

- Patented design of parallel axis, planetary helical gears- provides a smooth and quiet automatic division of torque
- Improved traction relative to other rear-wheel and four-wheel-drive vehicles
- Maintenance free- requires no friction modifiers
- Lifetime torque bias retention
- Simple, proven design
- Smooth, quiet operation
- Limits wheel spin-out and improves handling
- Performs open, until needed

Technical Specifications

- Most designs are engineered to transfer up to 3.5 times more torque to high traction wheel
- Truetrac available in 3, 4 and 5 pinion designs
- Front, rear and transfer case applications

Applications

- Road racing vehicles
- 4x4 off-road
- Drag racing
- Emergency vehicles
- Landscape trucks
- Delivery vehicles
- Armored trucks
- Dump trucks
- Utility vehicles
- Motor homes
- Buses



NOTE

Truetrac differentials require a certain amount of resistance on the ground to start the power transfer. A Truetrac differential may not transfer power if the spinning wheel is off the ground. If spinning occurs, a light application of the brakes, while carefully applying power, will generate sufficient resistance in the spinning wheel to actuate the Truetrac differential and transfer torque to the other wheel.

NOTE

The Truetrac differential does not increase the load-carrying capacity, tow rating or payload rating of the vehicle or vehicle combination.

Detroit Truetrac® Function Check

Manual test

IMPORTANT

* For Truetrac models built with pre-load, the rotation will be restricted (depending on model).

NOTES

912A407 Axle serial numbers 49L11363C or 57L05188B and later.

910A416 Axle serial numbers and later: Range Rover - suffix H, 88/109 4 cyl. ¾ ton - suffix H, 109 V8/1 ton - suffix D.

912A383 Axle serial numbers 35S18135C or 37S08651B and later.

910A400 Axle serial numbers and later: Range Rover - suffix F, 88 - suffix G, 109 V8/1 ton - (Salisbury standard), 109 4 cyl. ¾ ton - (Salisbury optional).

913A582 All vehicles equipped with OE Electric Locker require modification.

911A342 will not fit clamshell housing.

913A610 32010X bearing allows 913A610 in place of 913A611.

911A445 Will not fit selector disconnect "shift on the fly."

911A445, 913A609 xxvi "Small" hub bearing diameter 45 mm.

911A342 "Large" hub bearing diameter 50 mm - uses Toyota bearing #90368-50006.

913A589, 913A90, 915A388, 915A550 For use of non-thick ring gears.

Step One

With the engine turned off and wheels chocked, raise Truetrac-equipped driving axle(s) until all tires are out of contact with any surface. Check both hand and foot brakes for possible drag caused by improper adjustment. Place the transmission in gear or park so that the **DRIVE-SHAFT IS LOCKED AND DOES NOT ROTATE.**

Step Two

While turning one wheel, the other should rotate in the opposite direction. Units with preload will have greater resistance to turning. Units without preload will appear to have a higher internal gear lash (tires will feel more loose during initial rotation). However all units actually have similar lash values.

Step Three

Verify correct operations during road test. Use the in-vehicle test shown on the next page.

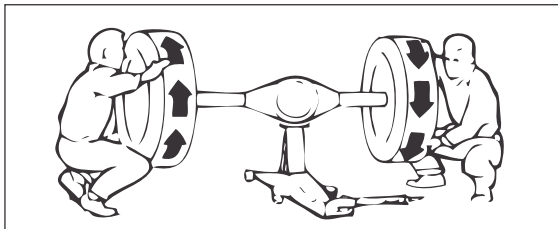

Check in both directions to verify that the Truetrac differential is operating properly.

Detroit Truetrac® Function Check

Vehicle test

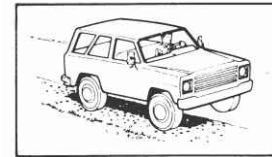

Step One



Step Two

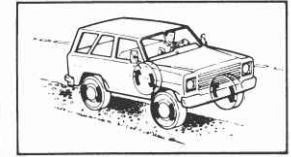

Step Three

Step One

Pull the vehicle off to the side of a paved or concrete area with the left wheels on a hard, dry surface, and the right wheels on loose gravel, dirt, etc.- any safe place where traction surfaces (ground friction coefficients) are different for the left and right wheels.

Step Two

As you accelerate, the wheel with the least traction (right wheel) should spin momentarily.

Step Three

The spinning wheel should then slow down and synchronize with the opposite wheel as the Truetrac differential transfers power from the low traction wheel to the high traction wheel.

CAUTION: PERFORM THIS TEST IN AN ISOLATED AREA WHERE THERE IS NO POSSIBLE CHANCE OF INTERFERING WITH OTHER VEHICLES OR PEOPLE.

NOTE

Some applications require drill modification for fitment.

Eaton Posi™

Performance limited slip differential



NOTES

19557-010, 19559-010 All Eaton differentials made for General Motors 8.5" and 8.6" axles require special bearings. For axles with small bearing bores (race O.D. or 2.89"), usually found on vehicles prior to 1999, bearing LM102949 and race LM102911 are required. For axles with large bearing bores (race O.D. of 3.06"), usually found on vehicles from 1999 to present, bearing LM603049 and race LM603012 are required.

19694-010 Full float only.

19557-010, 19559-010 Manual locking hubs recommended.

19610-010 Requires ring gear bolt: GM part #12479387.

QPS-70-P-20001 2006-2007 Z06 and 2008-present models require use of 28682/28621 bearing and race of the long shaft side.

19510-010, 19512-010 Includes 800# preload springs.

Some applications require drill modification for fitment.

Originally released for General Motors' Chevrolet Truck Division in 1959, the Eaton Posi limited-slip differential (then "Eaton Trac-Aide" and branded by GM as "Positraction") is designed to provide significantly enhanced traction capability for a wide variety of vehicles. The original units were strictly designed for enhanced traction. In the fall of 1959, following the results of extensive testing by GM's Cadillac Motor Division, the design was revised to provide a higher and more consistent bias ratio with reduced "chatter." Since those early days, many improvements and innovations have resulted in the Eaton Posi becoming the industry leader for high performance clutch-style limited-slip differentials.

In addition to 60 years of product engineering and testing, Eaton proprietary clutch materials, industry leading gear strength, and advanced manufacturing processes have allowed the Eaton Posi to continue to lead the way in affordable performance enhancement. All Eaton Posi designs are subjected to rigorous validation tests at our Michigan-based 700 acre proving grounds and dynamometer facilities for validating strength, durability, performance, quality and torque capacity.

The Eaton Posi has two distinct characteristics. For low-torque conditions, the preload springs apply an

initial resistance by energizing the clamp load of the clutch packs. The product design allows for different spring loads to be swapped into the differential to increase or decrease this initial bias ratio/torque transfer capability. Spring loads are often used to "tune" the handling dynamics of performance vehicles. The spring cage design also ensures this load is perfectly balanced between sides and evenly distributed to the clutch surfaces. Once additional torque is applied, the gear tooth design becomes the dominant force generator to the clutch packs. The torque is used to separate the side gears from the pinion gears, providing increasing resistance in the clutches. This resistance does two things: slows the low-traction wheel and diverts power to the wheel most able to put the power effectively to the ground.

Benefit

- Proprietary high-performance clutch material
- High-torque capacity
- Simple design
- Lowest noise plate-style LSD
- Highest durability plate-style LSD
- Predictable performance
- Safer than a spool in drag racing applications

Technical Specifications

- Superior rebuildable design
- Exclusively developed Eaton proprietary friction disc material for maximum grip, highest durability, and least LSD chatter
- Automatic limited-slip functionality
- Adjustable preload biasing

Applications

- Street rod
- Muscle car
- Drag racing
- Road racing
- Towing
- Recreational vehicles
- Light duty off-road

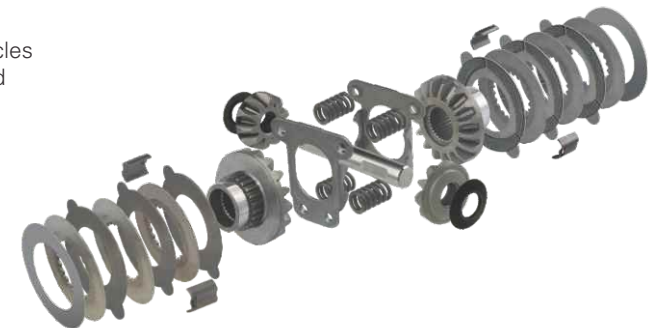

Posi™ Function Check

Manual test

Step One

With the engine turned off and wheels chocked, raise Posi-equipped driving axle(s) until all tires are out of contact with any surface. Check both hand and foot brakes for possible drag caused by improper adjustment. Place the transmission in gear or park so that the **DRIVE-SHAFT IS LOCKED AND DOES NOT ROTATE.**

Step Two

While turning one wheel, the other should rotate in the same direction. Units with preload will have greater resistance to turning and higher breakaway torque.

Step Three

Verify correct operations during road test. Use the in-vehicle test shown on the next page.

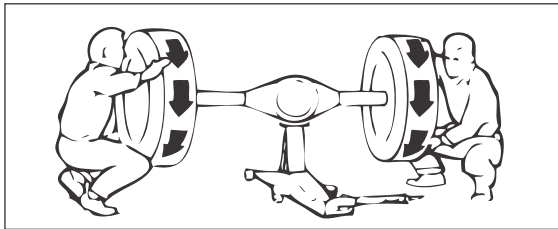

Check in both directions to verify that the Posi differential is operating properly.

Posi™ Function Check

Vehicle test

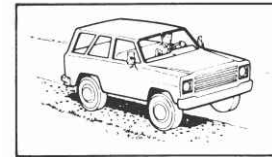

Step One



Step Two

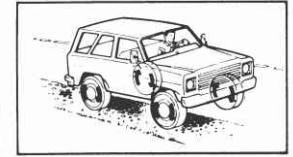

Step Three

Step One

Pull the vehicle off to the side of a paved or concrete area with the left wheels on a hard, dry surface, and the right wheels on loose gravel, dirt, etc.- any safe place where traction surfaces (ground friction coefficients) are different for the left and right wheels.

Step Two

As you accelerate, the wheel with the least traction (right wheel) should spin momentarily.

Step Three

The spinning wheel should then slow down and synchronize with the opposite wheel as the Posi differential transfers power from the low traction wheel to the high traction wheel.

CAUTION: PERFORM THIS TEST IN AN ISOLATED AREA WHERE THERE IS NO POSSIBLE CHANCE OF INTERFERING WITH OTHER VEHICLES OR PEOPLE.

Eaton ELocker®

Selectable locking differential



NOTES

19659-010 All Eaton differentials made for General Motors 8.5" and 8.6" axles require special bearings. For axles with small bearing bores (race O.D. of 2.89"), usually found on vehicles prior to 1999, bearing LM102949 and race LM102911 are required. For axles with large bearing bores (race O.D. of 3.06"), usually found on vehicles from 1999 to present, bearing LM603049 and race LM603012 are required.

19817-010, 19818-010, 19819-010, 19821-010, 19822-010 Bearing LM102949 and race LM102911 and unique shims are required.

19821-010 Bearing LM102949 and race LM102911 are required.

19761-010 For use of non-thick ring gears.

Some applications require drill modification for fitment.

This highly engineered unit allows for maximum driveline flexibility. Users can switch from a fully-open to 100 percent-locked axle at the touch of a button. Several designs of ELocker differentials are in production, with the 4-pinion ELocker 4 models providing industry leading torque capacity for highly demanding applications.

Users operate the ELocker with the flip of a dash switch. When in the "off" position the unit operates as a fully-open differential. If activated to the "on" position, an electronically-controlled mechanism locks the internal differential gear set to the differential case providing 100 percent axle lock.

The Eaton ELocker is designed for a variety of uses. Towing, off-road, rock crawling, and high-performance vehicles all benefit by installing an ELocker. Its smooth engagement and validated strength make it an ideal solution to improve traction and maneuverability. Units are available for front and rear-axle installation.

Benefit

- Provides full axle lock upon driver command
- Maintenance free, requires no lube additives
- Enhanced towing and off-road performance
- Electronic lock activated by dash-mounted switch
- Compatible with most advanced braking systems

Technical Specifications

- Maximum current draw is under 10 amps, with normal current draw between 5 and 8 amps
- Electric system consists of a switch, relay, fuse and diode (all included in a provided harness)
- Maximum delta wheel speed 50 rpm for engagement or maximum vehicle speed of 5 mph for engagement
- Military applications available for 12 and 24-volt direct current systems
- Assembly kit includes complete wiring harness and switch

Applications

- Recreational off-road vehicles
- Snow plows
- Drag racing
- Trucks
- Light / Medium-duty trucks
- Military
- Competition off-road ("Hardcore Edition" models)



Eaton ELocker® Function Check

Visual inspection: Salisbury style axles

Step One

Lift one wheel of the axle fitted with the ELocker using proper and safe methods ensuring that the wheel still in contact with the ground is properly chocked to prevent any vehicle movement.

Step Two

Remove the axle inspection cover (drain lube if filled).

Step Three

Place the driveline into “Neutral” and confirm the lifted wheel will rotate in either direction.

Step Four

Switch on the ELocker. If the installation requires the ignition to be switched on, **ENSURE THE ENGINE DOES NOT START.**

Collar style ELocker designs

Collar-style ELockers are easily identified by the three dual ramp surfaces of the ramp plate on the barrel end of the differential case. Rotate the suspended wheel until the differential engages. Engagement should occur within a few degrees of rotation. Engagement will be confirmed with the differential locking the suspended wheel to the wheel remaining on the ground. Further rotation will not occur. The movement of the pushrods can be observed as they slide up the ramps during the engagement operation. The rocker switch should have a constant-on light indicating power is being sent to the relay. Ball-ramp style ELockers are easily identified by the three dual ramp surfaces of the ramp plate on the barrel-end of the differential.

Pin-style ELocker designs

Pin-style ELockers are identified by the actuator on the ring gear end of the differential case. Rotate the suspended wheel until the differential engages. Engagement should occur within a few degrees of rotation and will be shown by the differential locking the suspended wheel with the wheel remaining on the ground. Further rotation will not occur. The engagement of the locking pins may be heard just as the unit locks. The rocker switch should have a constant-on light, indicating power is being sent to the relay. Pin-style ELockers are identifiable by the absence of the barrel-end ramp plate. The motion mechanism is contained within the differential case. All pin-style models are 2-pinion designs.

Eaton ELocker® Function Check (continued)

Dynamic inspection: all styles of axles

Directing-acting style ELocker designs

Direct-acting style ELockers are easily identified by the solid ring on the barrel-end of the differential case. Upon switching on the ELocker, the unit will activate immediately. Lacking rotation of the axle components, it is possible for the ELocker to require a slight motion of the suspended wheel to engage the locking mechanism. In service, the engagement of the locking mechanism should be transparent to the operator. The rocker switch should have a constant-on light, indicating engagement of the lock mechanism. If the rocker switch light is blinking with the switch in the “on” position, the unit is either in need of a slight wheel rotation to engage, or there is a “fault” in the electrical circuit – likely due to a damaged wire harness or a blown fuse in the harness.

Step One

Engage the ELocker on a hard, reduced traction surface such as packed dirt, but not pavement or asphalt.

Step Two

Perform this test at a slow speed.

Front axle installation: The axle should provide steering feedback indicating tire scrub. This is proof that the front axle is locked. Rear axle: The tires should scrub/drag as you turn a corner. This is proof that the rear axle is locked.



READ ALL NOTES COMPLETELY BEFORE STARTING INSTALLATION

PRIOR TO INSTALLATION!

- Read this entire manual prior to removing the differential from the box
- See any additional supplements for important information regarding your new Eaton differential
- Verify the unit is correct for your application. Primary items to note are flange position, bearing shoulder diameters, span, axle spline count and size
- Consult a vehicle or axle service manual for specific directions for installation of the product. This manual does not include specific instructions per application

For your safety while servicing an axle:

Ensure that the vehicle is parked on a level, hard, flat surface such as a concrete floor or driveway. If the vehicle is equipped with an automatic transmission, place the car in park and apply the parking brake. If it has a manual transmission, shift the vehicle into reverse and apply the parking brake.

Before performing any service on the vehicle, block the tires by placing a suitable object on both sides of at least one wheel to reduce the chance of rolling.

In lieu of a vehicle lift, a jack should be used to lift the vehicle. Jack failure is a common occurrence. Jacks are lifting tools, not a vehicle support.

Never insert any part of your body under the vehicle without first bracing the vehicle on jack stands. These should be securely positioned in the locations recommended by the manufacturer as “jack-points,” as listed in the vehicle's owner's manual or service manual. **FAILURE TO CORRECTLY POSITION THE JACK OR JACK STANDS CAN EASILY CAUSE SEVERE DAMAGE TO A WIDE VARIETY OF COMPONENTS.** When possible, jack stands should be placed under the axle or frame rails on beam axle or full-frame vehicles. **DO NOT** use items such as concrete blocks, bricks, lumber, tires, or other objects for bracing. Suitable jack stands are widely available for minimal cost. Make sure the stands are rated for the weight of the vehicle being serviced.

After the vehicle is properly braced on the jack stands, it is advisable to “wiggle” it to make certain all bracing is secure. Also re-check that all four corners of each jack stand are firmly seated on the ground. They can “walk” during jacking and installation of subsequent jack stands. Never run the engine while the wheels are off the ground.

IF WORKING WITH THE VEHICLE ELECTRICAL SYSTEM, SUCH AS AN ELOCKER INSTALLATION, DISCONNECT THE BATTERY.

When using any hammers, chisels, or power tools, personal-protection equipment such as safety glasses, gloves, and ear protection must be worn to protect the installer.

NOTE
Eaton promotes environmental consciousness. Please catch all fluids drained while servicing the vehicle. Recycling of the fluids recovered during service will greatly benefit the environment and help protect your family and community. Please recycle.

Verifying Clearance

- While Eaton designs every differential to be a direct fit into every application, we still advise the installer to verify the clearances around the differential
- Although a standard model of differential may fit a particular application, years of revisions to OEM castings and aftermarket axle housing options can create interferences not originally present in the axle's design
- Proper method for checking requires the differential assembly to be rotated in the fully assembled axle. Pay close attention to ring gear bolt heads and areas near the bearings
- Also check clearance to the axle cover – especially with non-original covers

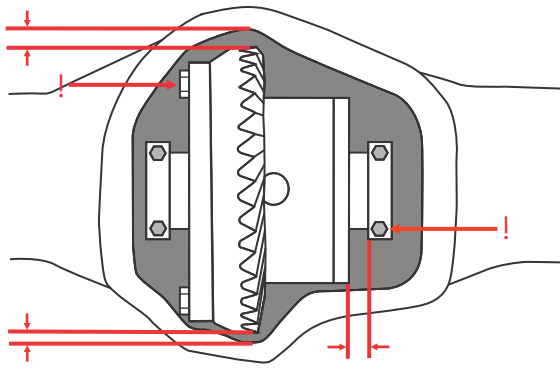

Lubrication Specifications

Detroit Locker® / NoSPIN®

A quality gear lube per the axle manufacturer's recommendation should be used.

Detroit Truetrac®

High quality mineral or synthetic gear lubes are required for use in Detroit Truetrac differentials. Regardless of the lube type, always use a GL5 rated lube with the least amount of friction modifier. Mineral lubes lacking friction modifiers (limited-slip additives) were historically recommended for all Truetrac applications because friction modifiers can slightly reduce the bias ratio (limited-slip aggressiveness) of Truetrac differentials. However, to address the continually increasing power outputs of modern powertrains, many vehicle manufacturers have switched to synthetic lubricants as a counter measure for increased axle temperatures and prolonged service intervals. In general, consult the vehicle owner's manual for the manufacturer's recommendations for lubrication type, weight and fill volume. This will ensure lube compatibility with the seal materials and bearings used in the axle. Eaton Performance technical support is available for any concerns in lube selection.

Eaton Posi™

Quality mineral or synthetic lube with sufficient friction modifier content will ensure the smoothest operating and longest life of your Eaton Posi performance differential. Eaton recommends GM Dexron LS or Castrol Carbon Mod SAF (Synthetic Axle Fluid) for all Posi applications. If using non-"LS" gear lube, add four ounces of General Motors "Limited Slip Axle Lubricant Additive" per one-and-a-half quarts of gear lube (GM P/N 88900330/10-4003). Additional friction modifier additive may be used to reduce LSD plate "chatter," but do not exceed eight ounces per one-and-a-half quarts of lube. Other brands of additives may be used. A friction modifier's purpose is to lower the static coefficient of friction (grabbing) within the clutch to match the dynamic friction (sliding) in an effort to reduce the effects of friction transition (stick, slip, chatter). Excessive amounts of a friction modifier can lower both friction values, resulting in reduction of bias ratio (performance) for plate-style limited-slip differentials such as the Eaton Posi. Many brand name gear lubes contain some limited-slip friction modifier in their formulation. If you use such a lube, additional friction modifier additives should be used sparingly to avoid accidental over-saturation resulting in performance loss.

Lubrication Specifications (continued)

LUBRICATION

Eaton recommends changing the lubricating fluid at or before the axle /vehicle manufacturer's suggested interval. At a minimum, conventional gear lube should be changed every 50,000 miles or 1,500 hours (agricultural/military use), and synthetic lube at 75,000 miles or 3,000 hours. For highly abusive applications or where water/mud/slurry submersion occurs, more frequent lubrication changes will greatly increase the life of all axle components.

Eaton ELocker®

A quality gear lube, per the axle manufacturer's recommendation should be used. However, full synthetic gear lubes can enhance the ELocker performance in extreme cold conditions due to their improved cold temperature flow characteristics. Excessively thick axle lube can create function problems with the ramp-plate style ELockers.

Installation

The following instructions should be used as "reference only" for the installation of an Eaton performance differential into a common style axle assembly. If available, the factory service manual should be referenced for complete details and specifications. The installation and proper set-up of an automotive differential should only be performed by a qualified technician due to the specialized nature of the components and operator safety risks.

Instruction Overview:

There are 3 purposes of these instructions. They are:

1. Replacement of the existing differential
2. Establishing the correct backlash between the ring and pinion gears
3. Setting a correct contact pattern of the gear teeth mesh

The physical installation of the differential pertains to the fitment, clearance to adjacent components (ribs of castings, bolt head clearance, pinion head to differential barrel), correct torque (tightening) of fasteners, bearing preload, lubrication, and most importantly, backlash and gear contact pattern.

See Glossary of Terms and Image Index in the back of this manual for term descriptions and component identifications.

Replacement of the Existing Differential

1. Prepare the Vehicle for Service

Lift the vehicle so that the tires for the axle worked on are raised off the ground (see "Safety" on page 20 for additional information) to ensure the vehicle is sufficiently immobilized. Use of wheel chocks and jack stands is critical for safety.

2. Prepare the Axle for Disassembly

Remove tires, brake calipers, brake rotors, and/or brake drums to allow the axles to slide out of the differential, permitting the differential removal. For procedures regarding a specific application, consult a factory service manual or quality aftermarket vehicle service manual.

3. Drain Axle Lube

Being cautious to prevent spillage, place a catch (drain) pan under the differential. Some axles have a

CAUTION

IT IS RECOMMENDED THAT SAFETY GLASSES BE WORN WHEN INSTALLING THE PRODUCT.

TOOL LIST

- Vehicle lift or hydraulic jack and jack stands
- ½ inch pneumatic impact wrench and sockets (recommended)
- Oil drain pan
- Funnel
- Shop light
- Combination wrench set
- Magnetic base dial indicator
- Dial caliper
- Torque wrench
- Shim driver
- Drift punch
- Dead blow hammer
- Ball peen hammer
- Large pry bar
- Telescoping mechanic's magnet
- Gasket scraper
- Hydraulic press
- Extra shims for adjustments

Installation (continued)

CAUTION
READ AND COMPLY WITH THE MANUFACTURER'S SAFETY WARNINGS AND PRECAUTIONS. DO NOT USE HEAT (TORCH) TO DISASSEMBLE THE DIFFERENTIAL. HEATING THE COMPONENTS CREATES RISK TO THE MATERIAL PROPERTIES OF THE COMPONENTS, POTENTIALLY CAUSING SEVERE REDUCTIONS IN STRENGTH, AND PHYSICAL DISTORTION.

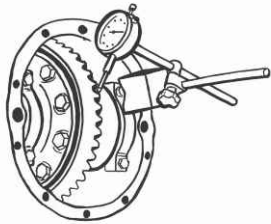

Step 4

4. Measurements Before Disassembly (required only if reusing ring and pinion)

drain plug in the lowest area of the differential housing. Others require removal of the axle housing cover to drain the fluid. The volume of the fluid will vary in each application. The vehicle owner's manual or service manual will list the fill volume of the axle. This can be important when selecting a drain pan. For most automotive service, a four-quart pan should be sufficient to contain the lube. Larger axles in commercial vehicles will have substantially more lube volume.

Using a dial indicator mounted on a magnetic base, measure the backlash of the existing assembly. Make sure the input pinion is not allowed to rotate. With the ring gear tight to one side of the input pinion, rotate the differential to the opposite side of the tooth contact. Record the value shown on the gauge. Rotate the differential a minimum of 45 degrees. Repeat the measurement and rotation. Collect a minimum of three measurements. If the majority are identical, record that value. If all of the measurements are unique but similar, use the average of the values. If the values vary more than 0.002", start over until the values begin to match. Variation in values is most often due to the input pinion rotating during inspection. Be sure to inspect the condition of the pinion fitment. The input pinion should **NOT** have noticeable axial (in and out) movement. The input pinion bearings should have some value of preload, keeping the input pinion solidly positioned and providing a small rotational drag (resistance to turn). If the input pinion shows any signs of loose fitment, your backlash values will not be useful and the issue needs to be resolved before continuing. Start by inspecting the pinion nut torque and bearing condition.

TIP: IF THE VALUE MEASURED IS NOT WITHIN THE FACTORY SPECIFICATION, THE MEASUREMENT SHOULD BE RETAKEN. IF THE DIFFERENTIAL THAT IS BEING REPLACED WAS DAMAGED IN A MANNER THAT ALTERED THE BACKLASH (BEARING OR SHIM FAILURE), CONSULT THE VEHICLE SERVICE MANUAL AND/OR RING AND PINION GEAR SET INSTALLATION MANUAL. IF SIGNIFICANT DAMAGE IS NOTICED, REPLACEMENT OF THE RING GEAR AND DRIVE PINION IS HIGHLY RECOMMENDED.

Installation (continued)

If reusing the ring and pinion gears, running a gear pattern check on the gear set also is advised. If possible, photograph the pattern of the gear set before removal. This pattern can be used as a comparative check at the completion of installing the performance differential. Consult the hypoid ring and pinion gear pattern support pages for proper techniques of generating a useable pattern.

5. Removing Axle Shafts (see image index for term descriptions)

- A. C-Clip axles
 - a. Remove the differential cross-shaft retainer bolt
 - b. Slide the cross-shaft out of the differential. The shaft is not pressed into the case, but may require a small amount of pressure or force to remove if the unit has been in service for an extended time. The differential may have to be rotated to allow removal of the cross-shaft. This can be accomplished by shifting the vehicle into neutral or removal of the drive shaft. Use caution when performing either option to ensure the vehicle is still safely immobilized.
 - c. With the cross-shaft removed, the axle shafts can be pushed inboard slightly. Looking through the differential case window, this movement will expose the c-clips by sliding them from the differential side gear pockets. The c-clips are used to retain the axle shafts (while installed, the cross-shaft keeps the c-clips positioned within the pockets of the side gears of the differential). With the clips exposed, remove them from the axle shaft. A magnet, pick or fine pliers will aid in this process.
 - d. To avoid harming the axle seals, carefully slide the axles out of the differential. Some lube will likely drip from the ends of the axle housing. Place an absorbent cloth under the end of the axle tube before disassembly to help contain leakage.
 - e. The axle shafts should be completely removed from the axle assembly and marked as to which side they were removed from.
 - f. The two shafts are often slightly different in length and swapping them could result in catastrophic failure of the axle assembly. If the axle shafts are not fully removed, take great care

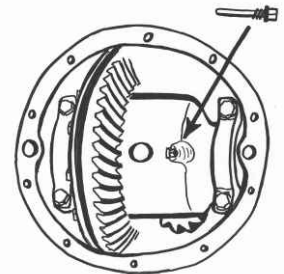

Step 5.A.a

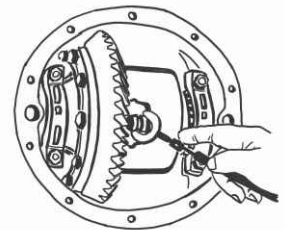

Step 5.A.c



Step 5.A.d

Installation (continued)

not to allow the axles to rest on the axle seals. The distortion will damage the seals and likely cause lube leakage. Carefully inspect the c-clips for wear. Witness marks from light rubbing are acceptable. However, if you can feel ridges on the c-clips, replace them with new components. If the c-clips are conical, there is an incorrect fit between the installed differential cross-shaft or spacer and the axle shaft tip button width. There should never be more than 0.040" clearance between the end of the axle shaft and the cross-shaft or spacer. If you suspect a problem, consult the vehicle manual or contact the Eaton customer help hotline.

B. Non-C-Clip axles

- a. Remove the axle bearing retainer plate at the wheel ends of the axle. These often are a steel plate, typically retained by four or more fasteners clamping them to the axle tube flange.
- b. With the retainer plates unfastened, the axle shaft should slide out of the axle housing. Some axle models may require the use of a slide hammer or similar tool to free the axle shaft and bearing assembly from the axle housing. Again, use caution not to harm the axle seals. Some lube will likely drip from the ends of the axle housing. Placing an absorbent cloth under the end of the axle tube before disassembly should help contain the leakage.

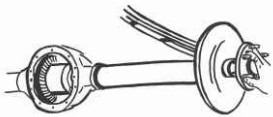

Step 5.B.b

- C. Bang Ring (expanding internal retaining rings) / CV / stub shaft / flange shaft axles (non-beam axle types IFS/IRS).
 - a. Consult the service manual to identify the appropriate method of removal for the given application.
 - b. Look for a stub shaft retaining plate or flange nut. If there are no visible retaining bolts or nuts, the axle is likely retained by an expanding internal retaining ring (bang ring).
 - c. For clipped axles (bang rings, for example), use a slide hammer or suitable pry bar and gently remove the stub shaft from the differential. Be cautious not to harm adjacent components during removal. Some lube will likely drip from the seals.

Installation (continued)

6. Removing the Differential

A. Salisbury style axle

- a. Mark the bearing caps (may be factory marked) as to which side and direction they are installed. Bearing caps are not interchangeable and must be reinstalled in the same position and orientation. Some manufacturers mark the caps with vertical and horizontally oriented letters stamped on the caps and adjacent gasket surface. Matching the symbols prevents mismatching the caps during reassembly. If no markings exist, stamp, scribe or otherwise mark the factory position and orientation of the caps so that it will not rub off during cleaning and reassembly.
- b. Loosen the bolts retaining the bearing caps. Certain manufacturers and many racing axles may also use aircraft safety wire, which must be removed as well. If bearing preload adjusters are used, back the left-hand (ring gear side) adjuster a few rounds into the axle housing to remove the preload. Moving only the left-hand adjuster will aid in setting up the new differential if reusing the ring and pinion gears. Be sure to remove the bolt retaining the adjuster positioning/retainer hardware. The retainer is typically a large gauge wire looped around a fastener near the carrier bearings with the ends positioned in the spanner holes of the adjuster.
- c. Remove the bearing caps and bolts. Use caution as the differential can now fall out of the axle, especially if it uses threaded preload spanner adjusters.
- d. When servicing axles that use shims to establish the bearing preload, a case spreader is recommended to remove the preload force. Refer to the vehicle service manual for the maximum amount of force/distance that can be applied to the housing. Excessive force or travel will permanently damage the axle housing. Many housings can be permanently damaged if the case is spread more than 0.020" of an inch. If a case spreader is not available, pry bars can be used to persuade the differential from the housing. Observe extra caution if the vehicle is suspended on a lift. When the differential "pops" out of the housing, damage to the unit and/or the mechanic can occur if the unit is not restrained.

Installation (continued)

Use extreme caution if pry bars are utilized. Only pry on the barrel of the differential, ring gear bolts or differential assembly fasteners. Alternating from side to side will “walk” the differential out of the housing. Very close attention must be given to the safety of the internals of the axle. Do not pry against the pinion or any sensors (ABS, tone wheel, factory electronic hardware, etc.). Contacting any of these parts with a pry bar can easily damage them beyond repair.

- e. Remove any loose shims and bearing cups, recording their position. These will be the starting point for shimming if the ring and pinion are being reused.
- B. Drop-out (pig / third member) style axles
- a. Unbolt the carrier housing from the axle assembly and remove it. Some lube will likely drip from the gasket area.
 - b. Refer to the “Salisbury-style” section above for completion of differential removal from the carrier.
- C. Banjo, IFS (Independent Front Suspension), IRS (Independent Rear Suspensions) and quick-change style axle.
- a. Many differing versions of these axle styles exist in the market and each manufacturer has unique methods for assembly.
 - b. Please consult the vehicle factory service manual or axle manufacturer's service manual to ensure safe disassembly without damage to components.

7. Removing Ring Gear

- A. Using a pneumatic impact gun will greatly aid in the removal of the ring gear bolts. If an impact gun is not available, clamping the differential and use of a breaker bar and socket is an alternative. Verify the thread direction. Some ring gear manufacturers use reverse threads. Use extreme caution when clamping the differential. Some styles can be easily damaged if clamped incorrectly. Never clamp on the ring gear or bearing shoulders. Use the barrel area whenever possible.
- B. Note the presence and orientation of a tone ring (a.k.a. tone wheel, reluctor ring) clamped between the ring gear and the differential flange. If a tone

Installation (continued)

wheel is present, mark the orientation of the part. Flipping the ring can cause interference and incorrectly position the reluctor teeth. This can cause severe damage and remove the functionality of the ABS (Anti-lock Brake System) sensor and traction control systems.

- C. The ring gear should be pressed onto a pilot diameter of the differential. However, some aftermarket gears are not machined with the same precision as factory gears. Although a press fit for the ring gear onto the case is highly preferred, a piloting slip fit will work. The primary function of the press fit is to guarantee the ring gear is centered to the carrier bearings, ensuring the least amount of ring and pinion gear whine. The proper centering of the ring gear also optimizes the loading of the teeth and is a major help in properly setting the gear lash between the ring and pinion. All of Eaton's performance differentials are designed and manufactured to the factory specification (or better) and result in a fit that is second to none. To remove the ring gear from the differential, a large press creating pressure around the entire ring gear is preferred. If a press is not available, two other options exist.
 - a. [Preferred] Place a punch or drift (made from nonhardened steel) into the threaded bolt hole of the ring gear. Select the largest punch possible to fit within the hole without damaging the threads. Working in an alternating crisscrossing pattern around the bolt circle pattern, gently “walk” the gear off of the differential case. Use caution not to use too much force. Excessive force can damage the strength and shape of the ring gear.
 - b. [Alternative] A lead or brass hammer (or drift) can be used, contacting the ring gear just outboard of the differential flange diameter. Use caution not to apply force directly to the teeth on the ring gear. Hammering, even with a soft-faced material, can damage the teeth of the ring gear.
 - c. Use caution while unseating the ring gear from the pilot diameter on the differential case as it will fall once free. Pad or restrain the gear as necessary to prevent damage.

Installation (continued)

8. Reassembly of Ring Gear

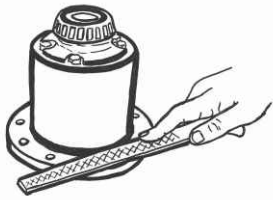

Step 8.A

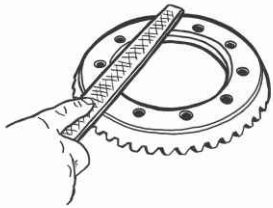

- A. Whether reusing the existing ring gear or new gear set, thoroughly clean the ring gear and differential flange. **IT IS WISE TO LIGHTLY LAP A FINE FILE OVER THE EDGES OF BOTH THE DIFFERENTIAL FLANGE AS WELL AS THE BACK FACE OF THE RING GEAR. EDGES CAN BE DISTURBED DURING SHIPPING, RAISING BURRS THAT CAN HAMPER GEAR FITMENT.** Remove any existing debris including residue of thread locker compound, lube, etc. Gently running a clean bolt or tap in the ring gear bolt holes, followed by a cleansing with brake cleaner, will typically clean the threads sufficiently. Use caution when using any aerosol products.
- B. If a tone ring is utilized on the differential, reassemble the ring as it was removed.
- C. Some Eaton performance differentials are machined with multiple ring gear bolt patterns to accommodate many models of factory ring gears and unique aftermarket ring gears. Select the pattern that offers the tightest fit to the fasteners for the intended ring gear. An example would be Dana 44 units. Ring gears exist with 3/8", 7/16", and 1/2" fasteners. Eaton performance differentials for this application are typically machined with both 7/16" and 1/2" clearance holes. This allows the fitment of the two smaller bolt sizes into the small pattern, and the larger fasteners into the larger hole pattern, thus ensuring sufficient material under the bolt heads to allow proper tensioning of the fastener. A close fit between the bolt and the differential is not required if correct ring gear bolts are used.
- D. To align the bolt holes on the ring gear, slide the ring gear onto the differential until the gear approaches the press fit pilot diameter. Using longer than stock bolts placed through the differential flange holes, lightly start the bolt threads into the ring gear. At least two fasteners should be used to align ring gear orientation. Many models of differentials use ring gear bolts that are long enough to start into the ring gear threads. After the ring gear is aligned to the differential flange, start all of the remaining bolts. **Do not tighten the bolts more than hand tight. DO NOT DRAW THE RING GEAR DOWN WITH THE BOLTS** at this time.

Installation (continued)

- E. New ring gear bolts are highly recommended on any application for performance enhancements. Quality new ring gear bolts often have dry patch thread locking compound. If reusing the ring gear bolts, clean all oil and previous retaining compound from the fasteners. Whichever fasteners are used, a thread locking compound must be used. If a lock patch is on the new fasteners, this is preferred. If it is not present, or when reusing bolts, a quality thread retaining compound such as Loctite 263 (high strength red, oil tolerant, primerless) should be used per the guidelines of the manufacturer. Do not apply the thread retaining compound until the ring gear is fully seated and the bolts are ready to be torqued to their final specification. If the ring gear bolts are drilled for aircraft safety wire, ensure the bolts are wired correctly. Several resources are available online and in manuals for best-practice techniques.
- F. To fully seat the ring gear, start by ensuring that it is parallel to the differential flange as it starts to seat onto the press-fit diameter of the differential pilot. The preferred method to finish the ring gear installation is by evenly and squarely pressing it in a shop press. If there is no access to a shop press, the ring gear can be gently seated using the old ring gear bolts. Working in a cross-pattern method (similar to wheel lug tighten sequence), tighten the bolts no more than a one-half rotation per turn. Continue this method until the ring gear is seated. To avoid permanent damage of the ring gear threads, do not tighten the bolts more than the final assembly torque value. The ring gear threads are very sensitive to torque due to the often reduced bolt engagement length.
- G. Remove the ring gear bolts after the ring gear has been seated. **BEFORE PROCEEDING, VERIFY THE CORRECT TORQUE SPECIFICATION FOR THE RING GEAR BOLTS – AND HAVE THE PROPER TOOLS READY.** If using new bolts with a thread lock patch pre-applied on the threads, thread them into the ring gear. Ensure the patch provides some resistance. If the patch does not provide resistance, remove and apply liquid thread lock. If installing the original bolts, or new bolts without a thread locking patch, apply the recommended thread locking liquid per the manufacturer's recommendation. Torque the ring gear bolts per the specifications of the service manual or ring gear manufacturer's specification.

Installation (continued)

Alternate the pattern in a cross-pattern method to draw down the ring gear.

9. Installing the Differential into the Axle

- A. For outboard shims or threaded spanner preloaders:
If the application utilizes outboard bearing shims or threaded spanner adjusters, press the carrier bearings on the differential. Exercise great care to only press on to the inner race of the bearing. If pressure is applied to the needle cage, the bearing can be easily destroyed. (Hint- use only name brand, high quality bearings. Unless the bearings have very limited service, carrier bearings should be replaced during differential installation.)
- B. Inboard shims:
Install the original shims from the old differential on to the new differential. If set-up bearings are available (bearings or simulation tools with the inner diameter machined large enough to remove the press-fit of the bearing, yet maintain a tight slip fit; Miller SPX Tooling offers an excellent variety), install them outboard of the shims. If no set-up bearing or mock bearing tools are available, the bearings will likely need to be installed and removed very carefully during the next steps of setting gear lash and gear contact pattern.
- C. Caps:
With the differential (including real bearings, set-up bearings/cups, or simulated bearings) placed in the axle, align the bearing straddle caps and start the cap bolts. Double check the orientation and placement of the bearing caps. **THE BEARING CAPS ARE NOT INTERCHANGEABLE.** If used, any outboard shims or spacers can be installed at this time. Lightly tighten the cap fasteners. The bearings need to be seated, but the cups need to be capable of sliding under the bearing straddle caps.
- D. Preload:
When installing a differential that relies on shims for the bearing preload, consult the service manual for the correct value. The preload of the carrier bearings is to ensure correct fitment and constant contact. An example of a common preload value on small Dana axles is 0.003"-0.005" total. If conical carrier bearings have too little preload, the differential will be able to "walk" or "bounce" from

Installation (continued)

side to side in the axle housing. Even the slightest motion will severely damage the bearings and likely result in severe ring gear noise. Too much preload can overstress the bearings and also result in heavily reduced bearing life. A conical-bearing-mounted differential is more sensitive to a loose fit than a slightly tighter fit. If threaded spanner adjusters are used in the axle, tighten them per the service manual's instructions. Establishing the proper preload plays a large role in preventing ring gear whine (noise), and a long bearing service life. Preload can be checked with a dial indicator mounted on a magnetic base and placed along the axis of the differential. Using a pry bar, verify the lack of lateral motion of the unit. If the needle moves when light pressure is applied, it does not have sufficient preload.

- E. Backlash:
When reusing a ring and pinion set (and only when the pinion has not been removed), the differential should be shimmed or adjusted to return the backlash to match the value measured and recorded before the original differential was removed. If the pinion was not removed from the axle assembly, the original shims should locate the differential close to the correct value. If the gear set has been changed or the pinion removed for bearing/seal service, the backlash may be substantially out of the factory tolerance range. Consult the vehicle service manual, ring gear installation guide, and/or the pattern and shimming guide included in this installation guide. Adjust the shimming to achieve the correct (factory spec) range, and match the backlash recorded if simply upgrading the existing differential to a performance differential.
- F. Pattern:
Setting the gear set to the correct backlash is the starting point for setting the contact pattern of the ring and pinion gear teeth. The positioning of the contact location of the pinion teeth on the ring gear teeth is the most important step in the installation of a performance differential. The strength, noise, and life of the gear set is totally dependent on establishing the correct contact pattern. Consult the included hypoid gear contact pattern guide for tips to resolve any issues and verify a correct pattern. If the gear set has been reused, the pattern should be nearly identical to the pattern run before removing the original differential.

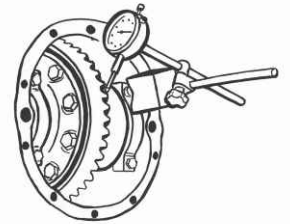

Step 9.E

TIP: THE GEAR CONTACT PATTERN OF HYPOID GEAR SETS IS EXTREMELY CRITICAL. IF THE PATTERN IS NOT DEVELOPING, SEEK HELP FROM A QUALIFIED RESOURCE.

10. Reassemble Axle

Proceed **ONLY** after the correct backlash and pattern are set on the hypoid gears.

- A. **TIP: BEFORE CONTINUING, IDENTIFY THE PROPER TORQUE VALUE FOR THE CARRIER CAP BOLTS AND HAVE THE TOOLS REQUIRED AVAILABLE.** Remove the carrier bearing cap bolts one at a time. Clean any oil from the threads and apply a medium or heavy duty thread locker (i.e. blue or red) to the threads, per the thread locker's instructions. Reinstall the carrier cap bolts and torque to the specification listed in the vehicle service manual. **TIP: RE-CHECKING THE EXISTENCE OF BEARING PRELOAD, CORRECT BACKLASH, AND GEAR CONTACT PATTERN IS HIGHLY ENCOURAGED. UPON FINAL TORQUING OF THE CARRIER BOLTS, THE DIFFERENTIAL COULD SHIFT SLIGHTLY.**

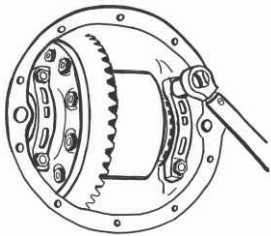

Step 10.A

B. Reinstall the axle shafts

- a. If the axles use c-clips, install them deep into the axle to expose the clip groove on the end of the axle shafts while looking through the differential case window. Insert the c-clips. **TIP: IF THE C-CLIPS SHOW SIGNS OF DAMAGE (WEAR YOU CAN FEEL OR BENDING), REPLACE THE C-CLIPS. IF THE C-CLIPS ARE FLAT AND ONLY SHOW SLIGHT MARKS OF WEAR (NO MATERIAL DISTORTION OR REMOVAL), THEY CAN BE REUSED. MANY INSTALLERS WILL FLIP THE CLIPS ON THE SHAFT TO PROVIDE "NEW" SURFACES TO THE CONTACT LOCATIONS.** Install the axle spacer. This is typically either the pinion gear cross shaft or a hardened steel plug and retaining ring (often used in c-clip models of Truetracs and Detroit Lockers). If the differential uses a cross shaft, install its retaining bolt. Use medium duty (blue) liquid thread locker on the fastener's threads. Torque the fastener to the value listed in this installation guide. The gap between the end of the axle shaft "button" and the cross shaft / spacer should be checked with a feeler gauge. The gap should be less than 0.040". If it is too large, and the original equipment axles are being

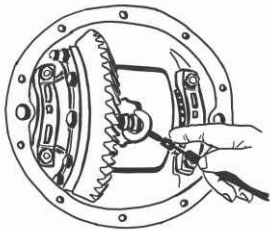

Step 10.B.a

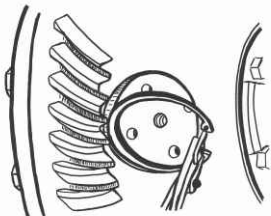

used, contact Eaton Performance. If the gap is large and aftermarket shafts are used, contact the axle shaft manufacturer to resolve the issue. Eaton performance differentials are designed to the original equipment axle gap specifications. Some models of Truetrac products may contain a selection of spacers to accommodate variations in original equipment fitments (i.e. Ford 8.8" uses multiple cross shaft diameters). If multiple spacers are included with the differential, always use the thickest spacer possible.

- b. If the axles are retained by the outer bearings and retainer plates, reinstall the axles into the axle assembly tubes. Use caution when sliding the axle seal back into position. The seals can be easily damaged during reassembly. If reusing the axle bearings and seals, a small amount of silicone/RTV around the perimeter of the seal structure may reduce chances of leakage. **TIP: WHEN POSSIBLE, REPLACEMENT OF THE AXLE BEARINGS AND SEALS IS ADVISED.** Torque the retainer fasteners to the specification from the vehicle service manual. Some retainer plates use press-in studs. Over-torquing pressed studs can cause significant problems. **TIP: WHEN REMOVED, SOME INSTALLERS PREFER TO TACK WELD PRESS-FIT STUDS TO THEIR RETAINER PLATES TO REDUCE INSTALLATION FAILURES.**
- c. If reinstalling full floating axles, ensure the sealing surfaces, o-rings (if used), and retainer bolts are clean. Non-gasket flange interfaces should be sealed with a thin layer of silicone/RTV. Apply medium or heavy duty (blue or red) liquid thread locker. If the fasteners are drilled for aircraft safety wire, reinstall per vehicle or axle manufacturer's instructions.
- d. Reinstall the differential inspection cover (non-third-member axles).
- e. Fill the axle with the appropriate volume of the correct lubrication. Consult the vehicle service manual for the volume of lube, and correct for any performance modification affecting the required volume, such as extra-capacity differential covers and axle assembly positioning for driveshaft alignment. Consult the vehicle service manual and the recommended lubricants page within this installation guide to determine the correct type of lubrication. Always use a

Installation (continued)

quality lube to ensure the highest performance from the differential and longest life of the lubricated components.

- f. Reinstall the brake system components.
- g. Reinstall the wheels and any remaining components removed for service. Consult the vehicle service manual for original equipment wheels, or aftermarket wheel manual if such wheels are installed. Proper torque values are critical to ensure safe operation of the vehicle.

11. Verify Differential Function

See the performance section for each product line for function testing methods.

Shimming For A Pattern

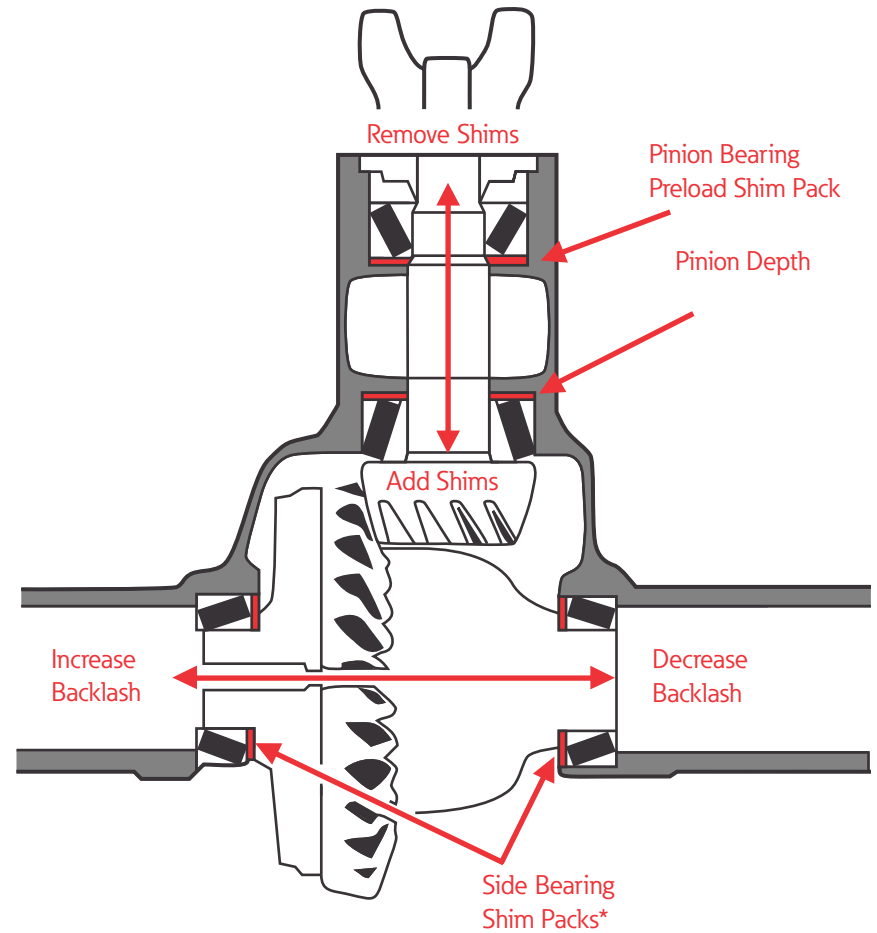

*may be out board of bearings, or utilize spanner style adjuster rings

Shimming For A Pattern (continued)



Ideal Contact

Pattern is spread evenly over the tooth's profile with concentration nearer toe than heel.

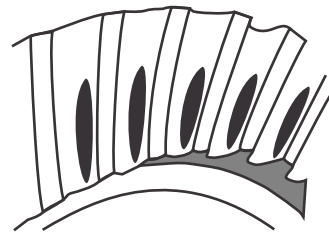

Competition Contact

Pattern concentrated just up from the toe covering one third to one half of the tooth.



Heel Contact

Pattern is concentrated off the heel end of the drive gear tooth. Move the ring gear close to the pinion (decrease backlash) while maintaining minimum backlash.

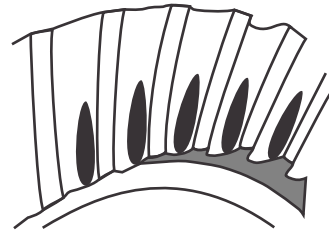

Toe Contact

Pattern is concentrated off the toe end of the drive gear. Move the ring gear away from the pinion (increase backlash) while maintaining minimum backlash.

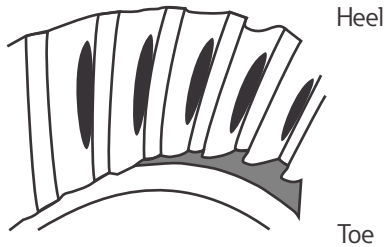

High Contact

Pattern is concentrated at the crown of the drive gear tooth. Move the pinion deeper in towards the differential carrier (add pinion shim).



Low Contact

Pattern is concentrated in the root of the drive gear tooth. Move the pinion out away from the differential carrier (subtract pinion shim).

Styles of Axle Housings

Split type

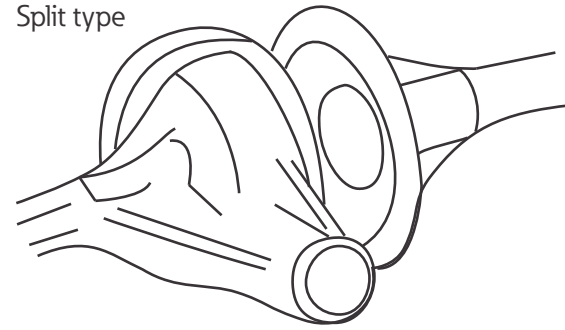

Banjo type

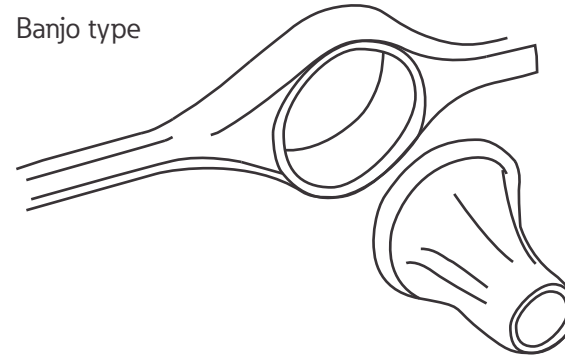

Carrier type

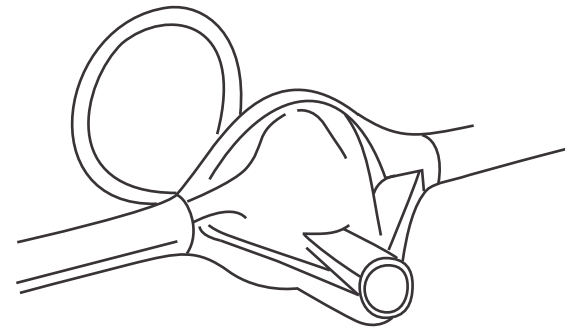

Conventional Axle Styles

Semi-floating tapered axle - Rear

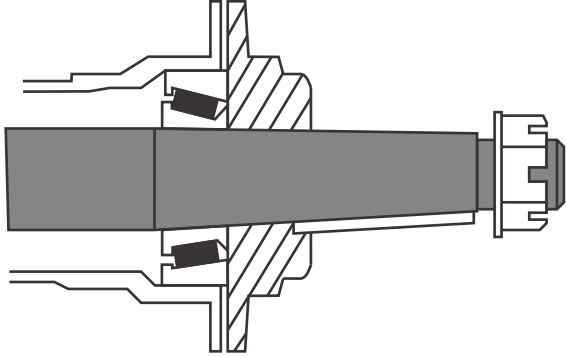

Semi floating axle - Rear

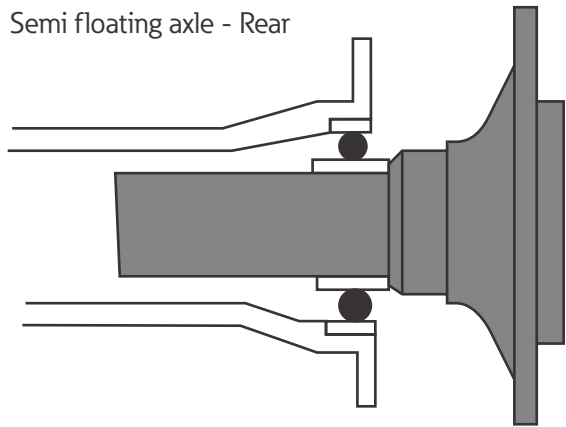

3/4 Float - Rear

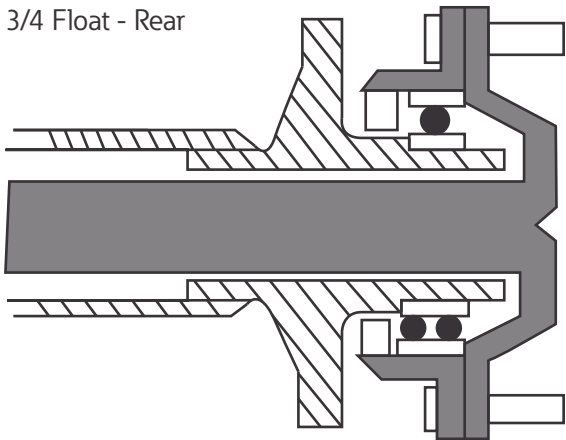

Conventional Axle Styles (continued)

Full float - Rear

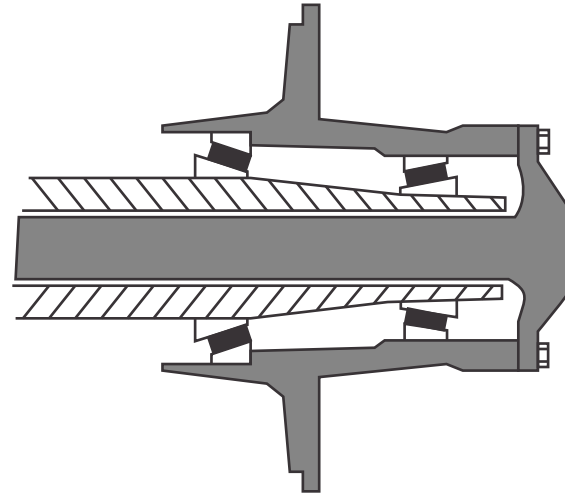

Full float - Front

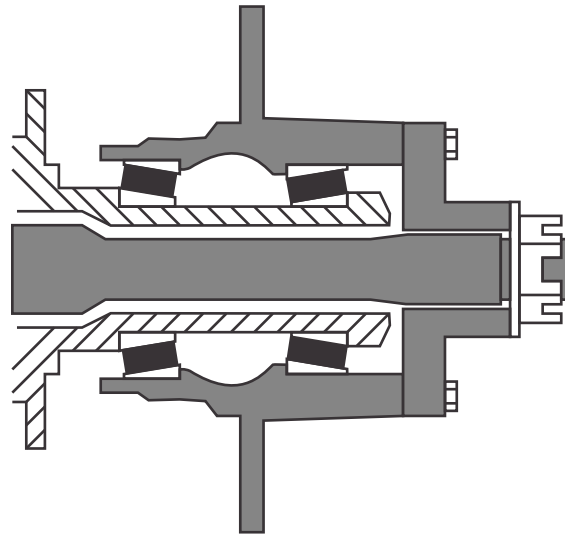

Common Axle Retention Methods

C-Clip style

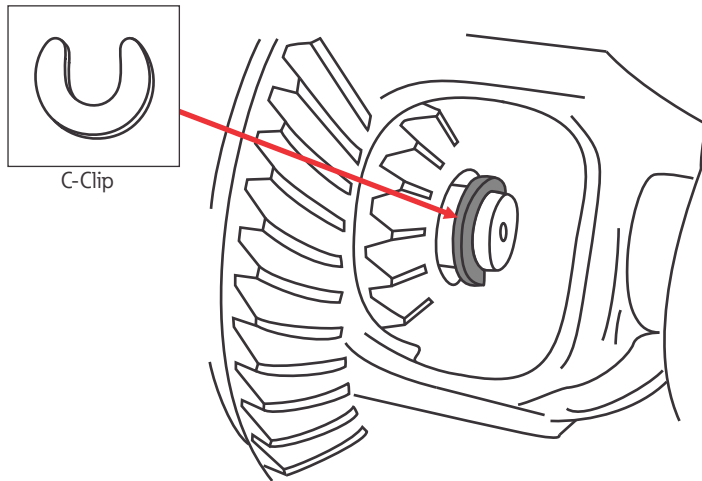

Captured bearing / Wedding ring style

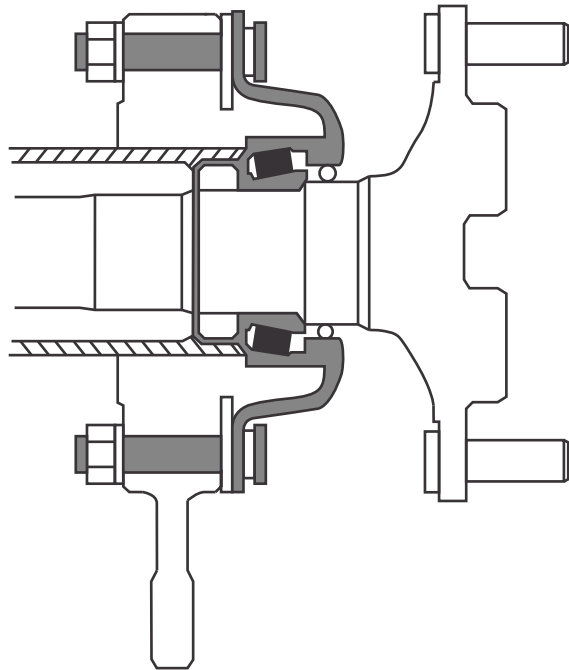

Frequently Asked Questions

Detroit Locker®

What kind of oil should I use? Can I use synthetic? Do I need friction additive/modifier?

See the "Lubrication" section of the product manual or the Eaton Performance website.

Can I use the stock bearings?

There are a few units which require non-OE carrier bearings to be used. These are indicated in the Performance Product catalog.

What kind of break-in is required?

The Eaton Detroit Lockers do not require any break-in.

When does a Detroit Locker lock?

The Eaton Detroit Locker is an "automatic locking" differential. It is locked up 100% in a straight line or if you are spinning. The unit unlocks the outside wheel in a turn (the highest speed wheel) if locked traction is not required.

When I step on and off the gas pedal, I hear the unit make a "clunking" noise. Why?

Because Eaton Detroit Lockers have "backlash" or "slack" between the drive and driven teeth and you will hear this in everyday use going through corners and when going from drive to coast. Also with the vehicle on the ground and the transmission in neutral, several degrees of lash in the driveshaft is normal. The degrees of rotation of the driveshaft is equal to: (differential internal lash X ring and pinion ratio) + ring and pinion backlash + and driveline slop such as U-joints wear.

Can I run a Detroit Locker (NoSPIN) on the street?

Many people do use the Detroit Locker during everyday street use. The Detroit Locker is a very aggressive traction aiding differential, initially developed for off-highway heavy duty applications. Eaton also makes many applications for on-highway heavy duty trucks. The Detroit NoSPIN locking differential is the locking differential found in "Rockwell" and other military axles. In the 1960's, the Detroit Locker became a factory option in some Detroit based OEM muscle cars. While most drivers of street cars will find the aggressive engagement of the Detroit Locker objectionable, drag racers enjoy the auto-locking functionality the differential delivers. The Detroit Locker allows drag racing vehicles to differentiate when turning corners, while offering strength comparable to a full spool.

Frequently Asked Questions (continued)

How much horsepower and torque will the Detroit Locker take?

Detroit Lockers have a very high “strength density.” All Detroit Locker designs are intended to handle more torque (power) than the axle shafts they drive. Horsepower has no influence on the differential. Most Detroit Locker failures are the result of axle shaft breakage causing reaction energy to “back-driving” the internals at a high rate of rotation speed. The more relevant concern is how much torque each axle shaft can transmit. Fully locking differentials are capable to deliver 100% of the full driveline torque through a single axle shaft. Open, limited slip, and non-fully locking differentials cannot transmit 100% torque – often in the range of 50-70%. This is an important point when upgrading a vehicle from a “standard” differential to a fully locking differential such as an Eaton Detroit Locker. One final point is that Eaton Detroit Lockers are capable of handling higher torque loads than older versions of the Detroit Locker. Through continual process innovation, advanced metallurgy, and ultra-modern machining methods, the strength of the Lockers has been greatly enhanced.

Can the Detroit Locker be used in the front axles?

The simple answer is “yes”; however, conditions apply. If used on-road, selectable locking hubs (not “auto-locking”) must be present on the front axle. A vehicle with a locked front differential is not only unsafe to use on an improved road, but will also cause substantial damage to the vehicle and have extremely difficult steering. The locking hubs must be in their “open” position for on-road use. For vehicles which only operate off-road, the use of selectable locking hubs is optional based on the operator’s preference and driveline / steering system strength. For off-road vehicles such as rock buggies, monster trucks, and heavy equipment, the use of a Detroit Locker offers incredible traction enhancements. The use of either full-hydraulic or hydraulic assist steering is common in vehicles using an auto-locking differential in the front axle.

What is the difference between a traditional Detroit Locker / NoSPIN and the “Soft Locker” style?

“Soft Locker” versions of the Eaton Detroit Locker / NoSPIN products were introduced in the market several years ago, but not on all models. The function of the Soft Locker is to use a spring generated preload between the side gears of the differential to generate a rotational resistance (dampening). The purpose is to

Frequently Asked Questions (continued)

dampen the re-engagement action of the Detroit Locker, enhancing the drive feel when used on-highway. This preload will cause the units to “feel” as if they have reduced internal lash due to the resistance to rotate, but preload does not have an effect on actual lash. The internal Belleville style springs and wear disks used in the Soft Locker designs are not required for the differential’s function. Soft Locker models are identified by the inclusion of “SL” in the model number. For example, 225SL58C.

Can the Detroit Locker be repaired?

Original equipment NoSPIN and Detroit Locker products can be easily repaired. Repair kits for “aftermarket” part numbers are not currently offered. Should you need to repair parts for an Eaton Detroit NoSPIN, they can be purchased from approved service centers for your vehicle. Assistance for locating a retail / service location for repair components is available through the Eaton Performance customer service hotline and the Eaton Performance website.

What is the warranty?

All Eaton Performance differentials are covered under the warranty policy listed in the “Warranty” section of the product manual.

Can the Holdout Rings be removed for racing to force a more rapid engagement?

Yes, but the operations of the differential will become much harsher and the differential’s life may be decreased.

Do the springs on a Detroit Locker / NoSPIN ever weaken or need replacing?

Theoretically, they could; but it is so extremely rare that you should not suspect a spring problem. Typically only full-race conditions would be sensitive enough to notice any reduced force from the springs.

Is there any difference between the springs? Do the colors or paint striping indicate differences?

Absolutely not. The markings are used to indicate batch lots and production dates. Historically, some retailers have painted the springs, but there is no difference in the springs.

Does Eaton manufacture the lockers sold by other companies with different brand names?

No, there are several companies making automatic locking differentials in the market. However, none of these have the 80+ years of product development

Frequently Asked Questions (continued)

history and manufacturing optimization of the Eaton Detroit Locker / NoSPIN. They are certainly not produced in our state-of-the-art manufacturing facility specifically developed for the NoSPIN product. Copying the form and appearance of a Detroit Locker / NoSPIN does not simulate the engineering, quality, or value of the product.

Eaton ELocker®

How do I activate my ELocker?

ELockers are activated by a dash (or console) mounted switch; included with all new ELockers. Any suitable 12VDC (or 24VDC for military designs) switch will work. The harness with a relay switch, chassis electrical system protecting diode, and fuse is included with all aftermarket performance ELocker differentials.

What is the warranty on the ELocker?

All Eaton Performance differentials are covered under the warranty policy listed in the "Warranty" section of the product manual.

Are ELockers rebuildable?

Yes. Depending upon your needs, several types of service kits are available including gear service kits, locking mechanism kits, stator / armature kits, and a universal wiring kit. Most service items are listed in the Eaton Performance Differential catalog.

What locking modes does an ELocker have?

The Eaton ELocker is an open differential with electronically controlled locking features. While the design of the locking components varies between models and generations of designs, they all operate by locking one of the side gears to the differential case. The ELockers operate in either "open" or "fully locked" condition.

Can I just purchase the wiring harness?

Yes, the wiring harness is universal to fit any vehicle, and can be purchased separately.

Is a relay necessary for ELocker operation?

All Eaton ELockers include a relay in the wire harness which should be used. While the current requirements of the differentials range from 5-10 amps, installers are well advised to utilize the relay to increase switch life and provide more stable current to the differential electronics.

Frequently Asked Questions (continued)

Can the ELocker be engaged "on the fly"?

Yes. You can engage it "on the fly"; however, you must be careful that the wheel speed difference (between the right and left wheel) remains under a 50 rpm. We strongly suggest engagement only when the vehicle speed is below 5 mph. While ELockers are designed to accommodate harsh use, continuous abuse and extreme speed engagement will greatly decrease the life of the ELockers. The driver needs to keep in mind that when the electrical signal is received by the ELocker, it immediately tries to lock and match wheel speeds. The differential must immediately snap (accelerate) the slow speed wheel, axle shaft, and brake component mass (weight) to the same speed as the free-spinning wheel. This is not only harsh on the differential; it is extremely harsh on the axle shaft.

Do Eaton ELockers have any special installation requirements?

Simple answer is, "a few". All Eaton ELockers require drilling a hole through the axle housing or carrier (see instruction card included with all new ELockers or the Eaton Performance website). Select models of ELockers also require the use of non-OEM bearing sizes, such as the Dana 30 and 35 models. No other "special" installation is required.

Eaton Posi™

What kind of oil should I use? Can I use synthetics? Do I need a friction additive/modifier?

Eaton Posi units perform best when using GL5 mineral/petroleum based gear oil. A four ounce bottle of friction additive/modifier is also necessary for optimum performance. See the "Lubrication" section of the product manual for further details and specifications.

Is the Eaton Posi rebuildable?

Yes, there are three main types of service kits available: internal spider and axle gear kits, clutch kits, also preload spring and plate kits.

Can I upgrade my Eaton Posi?

Yes, both the clutch disks and the preload springs can be altered for extreme off road and drag racing applications. Eaton Posi units come equipped with 400lbs of preload. They can be increased to 800lbs, or even decreased to 300 or 200lbs to tune the handling characteristics of the differential. There are several types of clutch service kits varying in friction material style and number of plates. See the Eaton Performance website for listings, or contact the Eaton Performance customer service hotline for details, part numbers, and availability.

Frequently Asked Questions (continued)

What is the warranty for the Eaton Posi?

All Eaton Performance differentials are covered under the warranty policy listed in the “Warranty” section of this product manual.

Detroit Truetrac®

What kind of oil should I use? Can I use synthetic? Do I need friction additive/modifier?

Truetrac units perform best when using GL5 mineral / petroleum based gear oil. Synthetic lubes are discouraged. Do **NOT** use friction modifier additives or lubes formulated with friction modifiers. See the “Lubrication” section of this product manual for further details and specifications.

Can I use the stock bearings?

In most cases, the Truetrac units work with the factory (stock, OE) bearings. Exceptions include the “10 bolt” 8.5 \ 8.6 GM models, the “performance” Dana 35 & 44, and GM “12 bolt” with 35 spline axles. The units require unique bearing either for retro-fitment or to accommodate larger than stock axle shafts.

What kind of break-in is required?

While Truetrac units do not require a break-in for operation, the gears do “lap” together. While the time required to fully lap the gears will vary depending on driving style and loads, the units will operate smoother with age.

When does the Truetrac lock up?

The Truetrac is a helical gear limited slip differential, not a “Locker”. The Truetrac operates by transferring power from the spinning wheel to the wheel with the most traction. If one tire breaks traction, the amount of rotation (or spin) is controlled by transferring the lost traction to the higher traction wheel. Truetracs operate on the principle of “torque biasing”. The typical Truetrac aftermarket differential will consistently deliver approximately three-fold the torque of the slipping wheel to the gripping wheel.

I use my car on the street and on the strip, will the Truetrac hold up?

On the street, the operation of the Truetrac will be transparent. You will not know it is there until you need it. In racing situations the unit will apply torque to both tires and launch straight as an arrow, time after time. The latest generations of Truetracs use forged and heat treated cases with extremely high quality gearing. The Eaton Detroit Truetrac is designed to be the strongest component in the axle assembly.

Frequently Asked Questions (continued)

How much horsepower and torque will the Truetrac take?

Eaton Detroit Truetracs are designed to handle more torque (power) than axle shafts they drive. Horsepower has little influence on the differential since it is more of a function of engine RPM. Each model of Truetrac is designed to unique torque capacity specifications; however, they are all developed to handle extreme torque loads typical in professional racing and military applications. The torque limit is largely controlled by the “barrel” diameter (ID of the ring gear), but also limited in c-clip models by the reduced pinion gear sets due to the c-clip installation pocket. Since these parameters are dictated by the axle design and ring gear strength, the Truetrac differential should not be the limiting component in the axle’s torque capacity.

Can Truetracs be used in the front axles of full time 4 wheel drive jeeps and trucks?

Yes, and front axle applications are extremely popular. Truetrac differentials are very smooth, offer near-zero steering feedback, and greatly aid in traction / mobility enhancement. Truetracs are produced for front axles, rear axles, and inter-axle drive systems.

Can I repair the Truetrac if I need to?

The helical cut gears inside a Truetrac are “maintenance free”, only requiring regular lube changes. Any failure of the Truetrac results in irreparable damage to the differential case – typically scoring the pinion gear pockets. Therefore, they are technically not rebuildable. Failure is generally the result of insufficient lubrication or poor lube quality due to age or contamination.

What is the warranty?

All Eaton Performance differentials are covered under the warranty policy listed in the “Warranty” section of this product manual.

My Truetrac has more internal “lash” than an open or plate style limited slip differential. Is this normal?

Eaton Detroit Truetrac differentials are a helical gear style limited slip differential. At a high level system view, the units are constructed similar to an open differential – except all gears are helical and the “pinion” gear is split into two intermeshed gears. Because of the three gear tooth mesh interfaces, the design must have lash. While all Truetracs (and helical gear differentials in general) have internal lash, units with preload are less noticeable. Typically, Truetracs have a maximum lash of three to four degrees side-to-side between gears. This is normal and required for the superior torque transfer design of the product.

Glossary

ACTUATOR - The wedge plate used in GA series Suretrac differentials to give enhanced bias performance.

ARTICULATED - Refers to vehicles that are joined in the middle and turn around this joint, as in "articulated farm tractor."

AUTOMATIC LOCKER - Differential which operates in the "normally locked" condition, only unlocking when sufficient traction exists in a cornering maneuver.

AXLE CARRIER - The differential, ring gear, and pinion gears are mounted on the axle carrier; the "center section" of the axle housing.

AXLE GEAR RATIO - The ratio between the number of teeth on the ring gear in relation to the number of teeth on the pinion gear (e.g., 3.92:1.00).

AXLE HOUSING - The support member of the axle which sustains the weight of the vehicle and houses the axle carrier assembly.

BACKLASH - The designed clearance between mating components in the drive line (e.g., gear sets, spline coupling, etc.)

CASE ASSEMBLY - The differential housing containing the differential assembly.

CARRIER BEARING (CASE BEARING) - The bearings that mount to the hubs on the differential support case.

CASE PILOT BORE - The locating diameter in the differential case from which the differential side gear is installed.

CENTER CAM - The control element of the NoSPIN differential. The cam is used to lift the drive members (clutches) from engagement by means of cam ramps.

CENTRAL DRIVER - An outer splined member (similar to the spider driver) having torque carrying teeth on both sides; the "center piece" of the NoSPIN differential.

CLUTCH PACK DIFFERENTIAL (PLATE STYLE LSD) - A limited-slip differential which uses friction clutch plates and/or springs to partially reduce wheel spin.

DETROIT LOCKER® DIFFERENTIAL - Trademark given to NoSPIN differentials sold with a differential case. (NoSPIN and Detroit Locker are operationally identical)

Glossary (continued)

DETROIT TRUETRAC® - Helical gear style high performance limited slip differential.

DIFFERENTIAL - Axle gear assembly which allows one axle shaft and wheel to turn slower or faster than the other when negotiating a turn.

DIFFERENTIATION - The different rate of speed between two wheels of an axle when making a turn or over uneven surfaces.

DRIVELINE - Components used to propel the vehicle drive shaft and universal joints, transmitting torque from transmission to drive axle (same as drivetrain).

DRIVEN CLUTCH - Member that is used to provide torque to another member such as to the side gear. Each NoSPIN differential has driven clutches.

DRIVETRAIN - A series of components which transmit power from the engine to the wheels/tires (i.e., transmission, propeller shafts, transfer case, axle, differential, shafts, etc.).

DOUBLE REDUCTION - Dual gear reduction used in rear axles.

ELOCKER® - Electronically controlled selectable locking performance differential.

FISHTAILING - Side slipping of the vehicle caused by traction instability.

G.C.W. - Gross Combination Weight. G.V.W. plus vehicle weight and payload of towed vehicle.

G.V.W. - Gross Vehicle Weight. Total weight of vehicle and payload.

GEAR SUPPORT CASE - Case used to support the differential. Same as case assembly.

GROUND COEFFICIENT - The horizontal force required to move a body, divided by the weight of the body. The amount of friction at the ground; the "quality" of the ground surface (e.g., ice, snow, dirt, etc.).

HELICAL - "Angled" gear tooth form.

HOLDOUT RING - Ring which assembles to NoSPIN differential clutch; maintains clutch disengagement in a turning mode.

INDEXING - A passing of one member over another, causing a slight audible sound from their contact (usually associated with NoSPIN differential).

Glossary (continued)

INPUT TORQUE - Measurement of available power.

LEAD RATIO - On unequal wheeled four wheel drive tractors and some specially designed 4WD systems, the powertrain is geared so that any difference in road speed of the two axles results in a faster speed for the front wheels (lead or overrun). This prevents the front wheels from being pushed.

LIMITED-SLIP DIFFERENTIAL (LSD) - A differential which utilizes some means of partially reducing, but not totally eliminating, individual wheel spin (e.g., clutches, springs, biasing pinion gears, etc.).

LOCKING DIFFERENTIAL - A differential that provides a locked axle condition. Can be manual or automatic, as in hydraulic locking differential, NoSPIN, Detroit Locker and ELocker differentials.

MACHINED SPLINES - Splines that have been manufactured by shaping, hopping, broaching, or slotting.

NoSPIN® - Automatic locking differential designed to replace the OEM standard differential gear set. Most commonly used for heavy duty equipment.

OVERRUN RATIO - See "Lead Ratio".

OVERSTEER - The condition of steering when making a turn that causes the vehicle to turn more sharply than expected. This over-sensitive "front end pull" condition can have many causes such as improper weight transfer or incorrect caster/camber.

PARALLEL SPLINES - Series of parallel keys cut along the axle shaft which mate with corresponding slots in the differential side gear.

PAYLOAD - Actual weight of useful cargo carried by vehicle.

PINION (INPUT) GEAR - The gear that is directly connected to the driveshaft, which propels the differential via the ring gear and provides power to the axle.

PLANETARY AXLE - Axle having a gearset arrangement in a concentric pattern consisting of a sun gear surrounded by pinion gears which mesh with an annular ring gear. This gearset provides torque multiplication in a reduced area on the same center line as the axle shaft usually located on the hub ends of the axle.

Glossary (continued)

POSI™ - Plate-style limited slip performance differential.

PRE-LOAD - Differential bearing adjustment achieved by adding or subtracting shims, eliminating clearance. Also a term regarding the static force applied to the clutch pack or gearset (as in a Posi, or Truetrac).

R.P.M. - Revolutions Per Minute. Term used to define rotation speed.

RING GEAR - The gear that is attached to the differential case and driven by the pinion gear. Also commonly referred to as a "crown gear".

ROLLED SPINES - Splines that are manufactured by use of rolling dies to form the spline configuration.

SHIM - "Spacer" used to achieve differential bearing adjustment.

SIDE GEAR - The gear that is mounted in the differential case; has the axle shaft splined to it; driven by the pinion gear.

SINGLE SPEED - Axle or transfer case having a single gear ratio.

SHOCKLOAD - A force caused by sudden impact.

SPIDER - The "center piece" of a standard clutch pack or NoSPIN differential; having a multi-trunnion spider-like shape.

SPIDER CROSS - Two or four armed member used to mount the standard differential pinion gears.

SPIDER GEAR(S) - Bevel pinion gears that are mounted on spider cross that drive the side gears of standard or clutch type differentials.

SPLINES - "Teeth" on the axles that mate with "teeth" (splines) on the differential side gear.

SNAP RING - A circular expandable ring that is used to retain two members together, as the snap ring in a NoSPIN differential that retains the spider and center cam or a Truetrac axle spacer retainer.

STANDARD DIFFERENTIAL - Open or conventional differential with no means of reaction control.

TAG AXLE (TANDEM) - Non-powered rear axle which follows the drive axle. Provides additional load-carrying capacity and distribution.

Glossary (continued)

TAPERED SPLINES - Cone shaped spline configuration.

THRUST BLOCKS - Support mechanism used to prevent ring and pinion gear deflection.

THRUST WASHER - Used in conventional differentials to reduce wear to the support case.

TORQUE - Force generated by the resistance to power.

TRUNNION - Journals allowing pivoting or turning, such as on a spider cross. On a NoSPIN differential, the arm (there are four) which supports the differential in the case assembly.

TWO-SPEED - Axle or transfer case having two selective gear ratios.

UNDERSTEER - The condition of steering when making a turn that causes the vehicle to "push" through corners with reduced sensitivity to steering input. This condition is the result of the rear drive axle having a greater "push" force than the front axles "turn" force.

WHEELBASE - Distance between center lines of front and rear axles or to the center line of tandem axles.

Gaskets

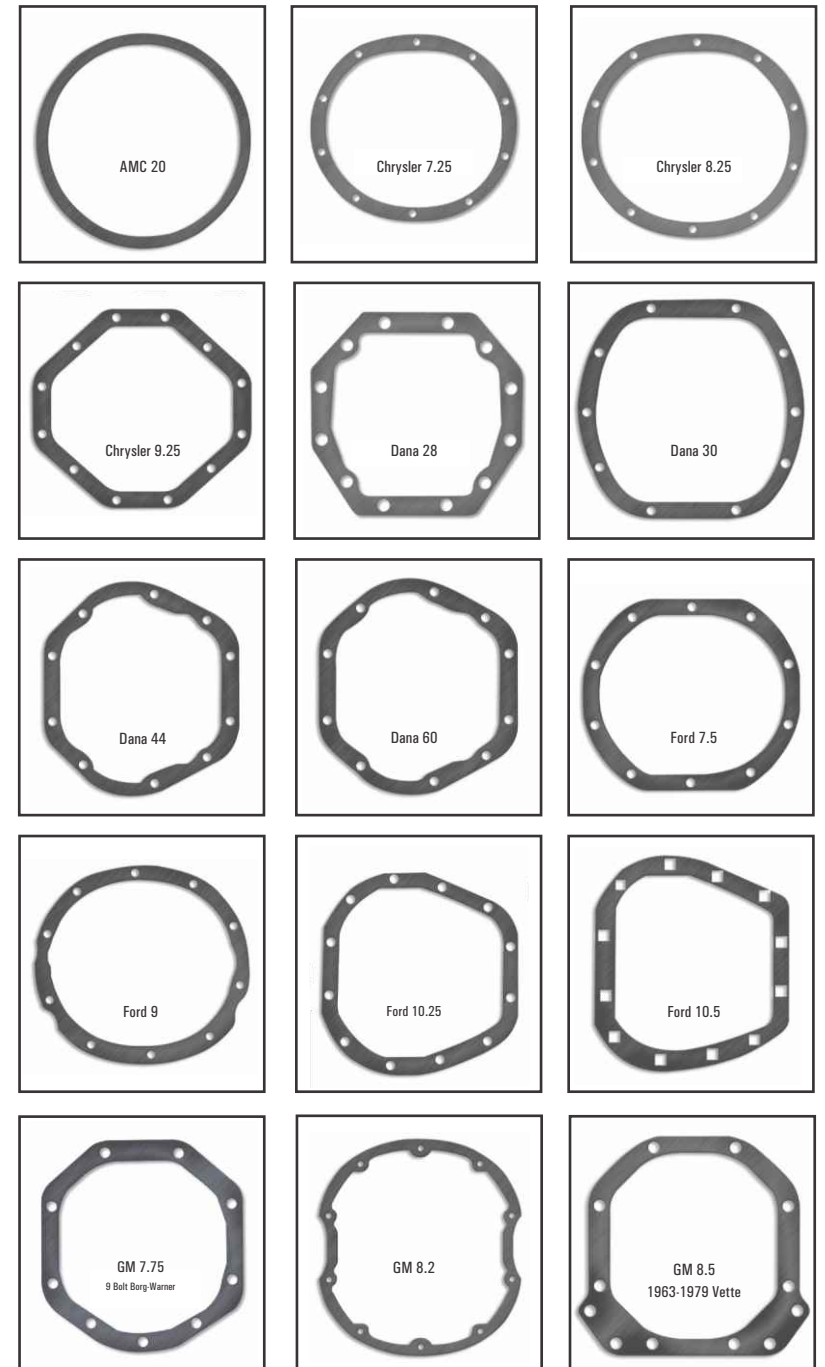

Gaskets (continued)

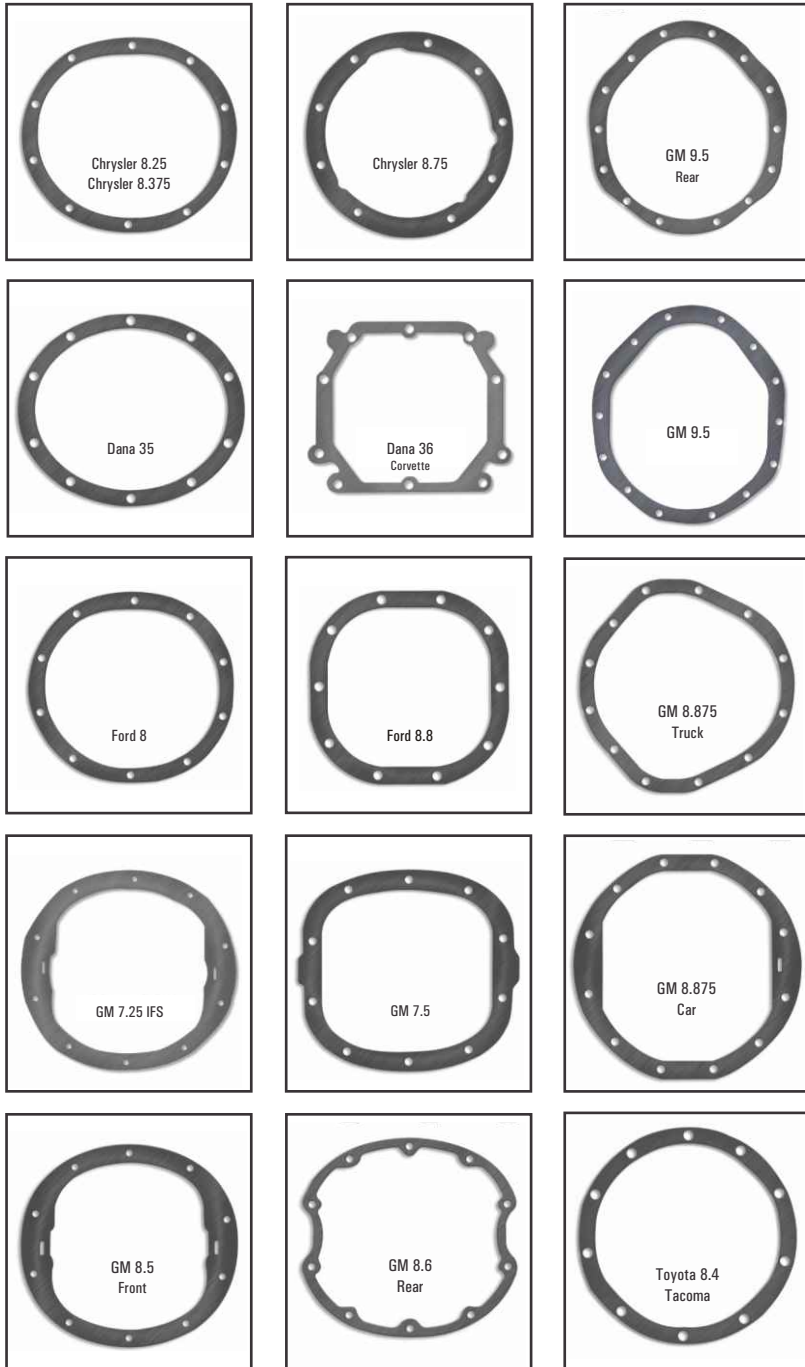

Gaskets (continued)

