



# Installation and Operation Instructions

## 12 Series Vantage™ Controller

### **WARNING!**

Failure to install or use this product according to manufacturer's recommendations may result in property damage, serious bodily/personal injury, and/or death to you and those you are seeking to protect!



**Do not install and/or operate this safety product unless you have read and understand the safety information contained in this manual.**

1. Proper installation combined with operator training in the use, care and maintenance of emergency warning devices are essential to ensure the safety of emergency personnel and the public.
2. Emergency warning devices often require high electrical voltages and/or currents. Exercise caution when working with live electrical connections.
3. This product must be properly grounded. Inadequate grounding and/or shorting of electrical connections can cause high current arcing, which can cause personal injury and/or severe vehicle damage, including fire.
4. Proper placement and installation is vital to the performance of this warning device. Install this product so that output performance of the system is maximized and the controls are placed within convenient reach of the operator so that s/he can operate the system without losing eye contact with the roadway.
5. It is the responsibility of the vehicle operator to ensure daily that all features of this product work correctly. In use, the vehicle operator should ensure the projection of the warning signal is not blocked by vehicle components (i.e., open trunks or compartment doors), people, vehicles or other obstructions.
6. The use of this or any other warning device does not ensure all drivers can or will observe or react to an emergency warning signal. Never take the right-of-way for granted. It is your responsibility to be sure you can proceed safely before entering an intersection, drive against traffic, respond at a high rate of speed, or walk on or around traffic lanes.
7. This equipment is intended for use by authorized personnel only. The user is responsible for understanding and obeying all laws regarding emergency warning devices. Therefore, the user should check all applicable city, state, and federal laws and regulations. The manufacturer assumes no liability for any loss resulting from the use of this warning device.
8. This product may contain high intensity LEDs staring directly into these lights could result in temporary and/or permanent vision impairment.



### **Caution:**

When drilling into any vehicle surface, make sure that the area is free from any electrical wires, fuel lines, vehicle upholstery, vehicle support members, etc. that could be damaged.

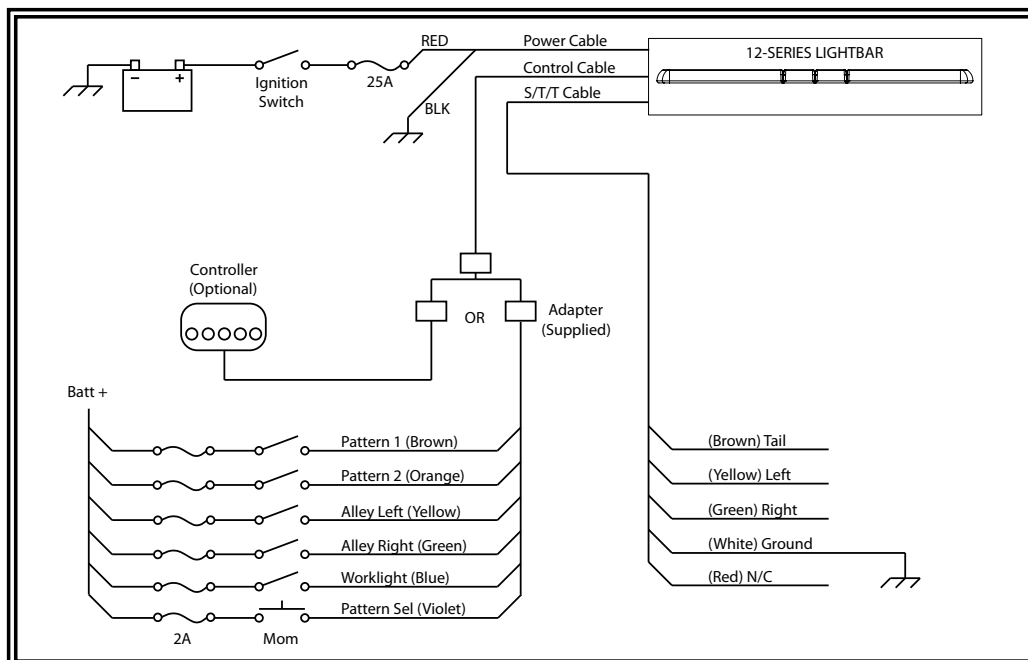

## Controller Keypad (EZ0006)

The optional in-cab controller provides convenient control of the Lightbar's 25 built-in flash patterns and features soft touch buttons and LED function indicator lights. The EZ0006 Keypad controller is designed for easy installation. Simply unplug the adapter from the control cable and plug in the controller.

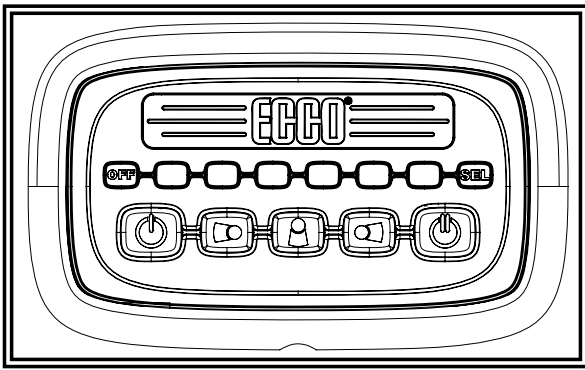

### Operation

The 12 series controller consists of 7 buttons with 5 features, and 6 indicator windows. When a feature button is selected, the corresponding clear indicator(s) will illuminate. Pressing any of the 5 feature buttons will turn that corresponding feature on, pressing it again will turn it off. There are two large flash pattern preset buttons; only one can be selected at a time. If one is on while the other is selected, it will shut the previous one off. The "OFF" and "SEL" buttons do not have illuminated indicators.



**"OFF"** - Turns the whole bar off. This is a quick way to shut everything down. Features can also be shut down individually by pushing the feature's button.

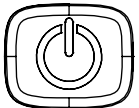

**"Power 1, Power 2"** - Turns on the flashing modules with whatever flash pattern was stored to this button.

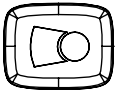
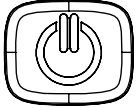

**"AL"** - Turns on left alley light, or as custom configured.

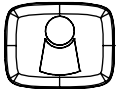

**"WL"** - Turns on center pair of takedown or worklights, or as custom configured.

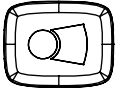

**"AR"** - Turns on right alley light, or as custom configured.



**"SEL"** - Advances to the next flash pattern whenever either power button is selected.

### Control Pad Mounting:

To mount the control pad with Velcro, separate the two circular halves, remove the backing and adhere one piece on the vehicle dashboard and adhere the other to the back of the controller. To mount the control pad using the swivel mount, first mount the swivel unit to the dashboard with either the supplied screws (note, the suction cup will not work after drilling screws through the swivel base) or by turning the lever at the base of the swivel unit to engage the suction cup. Push the controller onto swivel slide and press the control pad down onto the slide until it engages the slot in the control pad. (You may need to turn the controller clockwise once engaged with the slide to tighten it.) Turn the dial on the swivel head to tighten it against the back of the control pad. Finally, loosen the hand screw on the swivel neck to adjust the angle of the control pad. Hold the pad in the desired position while tightening the hand screw on the swivel neck.

