



INSTALLATION INSTRUCTIONS

FTS22327 2" F150 UNIBALL UCA KIT		
1	FT30613BK	UCA DRIV ASSMBLD
1	FT30614BK	UCA PASS ASSMBLD
1	FT30945	HARDWARE SUBASSEMBLY

FT30615 HARDWARE SUBASSEMBLY		
4	12008007100	ZIP TIE 8" BLACK 40 LBS
8	FT1007	BUSHING BLACK URETHANE
4	FT147	MISALIGNMENT
4	FT195	SLEEVE 1.000 X .563 X 2.450
2	FT22327i	INSTRUCTIONS
4	FT84	GREASE FITTING 1/4-28
1	FT90122	HARDWARE KIT
2	FT94503	UNIBALL ADAPTER PIN
1	FTAS12	STICKER FT BLUE 10X4
1	FTAS16	DRIVER WARNING DECAL
1	FTLUBE	URETHANE LUBE 1 PACKET
1	FTLOCK	THREAD LOCKING COMPOUND 1 MIL
1	FTREGCARD	REGISTRATION CARD

FT90122 HARDWARE KIT		
2	50200004152	1/2-20 C-LOCK NUT
2	50000005052	1/2" SAE WASHER G5 ZINC
2	75160004152	3/4-16 C-LOCK NUT ZINC

2021 FORD F150 4WD

2" UNIBALL UPPER CONTROL ARM KIT

FTS22327

NOTE: TO ORDER WEARABLE REPLACEMENT COMPONENTS DO NOT USE PART NUMBERS SHOWN ON THIS INSTRUCTION SHEET. GO TO FABTECH WEBSITE AND LOOK UP WEARABLE REPLACEMENT PARTS TO FIND THE PROPER PART NUMBER TO ORDER.

Fabtech Motorsports | 4331 Eucalyptus Ave. Chino, CA 91710

Tech Line: 909-597-7800 | Fax: 909-597-7185 | Web: www.fabtechmotorsports.com

- TOOL LIST -

Required Tools (Not Included)

- Basic Hand Tools
- Floor Jack
- Jack Stands
- Assorted Metric and S.A.E sockets, and Allen wrenches
- Torque Wrench

- PRE-INSTALLATION NOTES -

For technical assistance call: **909-597-7800** or e-mail: **info@fabtechmotorsports.com**

READ THIS BEFORE YOU BEGIN INSTALLATION -

Check all parts to the parts list above before beginning installation. If any parts are missing contact Fabtech at 909-597-7800 and a replacement part will be sent to you immediately.

This suspension and shocks has been designed to be installed on a stock vehicle.

Read all instructions thoroughly from start to finish before beginning the installation. If these instructions are not properly followed severe frame, driveline and / or suspension damage may occur.

Check your local city and state laws prior to the installation of this system for legality. Do not install if not legal in your area.

Prior to the installation of this suspension system perform a front end alignment and record. Do not install this system if the vehicle alignment is not within factory specifications. Check for frame and suspension damage prior to installation.

The installation of this suspension system should be performed by two professional mechanics.

This suspension must be installed with Fabtech shock absorbers.

Installation of all fasteners requires the use of provided thread locking compound with proper torque values as indicated throughout the installation. Apply thread locking compound upon the final torque of the fastener.

WARNING- Installation of this system will alter the center of gravity of the vehicle and may increase roll over as compared to stock.

Vehicles that receive oversized tires should check ball joints, uniballs, tie rods ends, pitman arm and idler arm every 2500-5000 miles for wear and replace as needed.

Verify differential fluid is at manufactures recommended level prior to kit installation. Installation of the kit will reposition the differential and the fill plug hole may be in a different position. (For example, if the manufacture recommends 3 quarts of fluid, make sure the diff has 3 quarts of fluid). Check your specific manual for correct amount of fluid.

FOOTNOTES:

- Does not fit models equipped with CCD (Continuously Controlled Damping) system

- INSTRUCTIONS -

FRONT SUSPENSION

1. Disconnect the negative terminal on the battery. Jack up the front end of the truck and support the frame rails with jack stands. **NEVER WORK UNDER AN UNSUPPORTED VEHICLE!** Remove the front tires.
2. Disconnect the sway bar link and the brake line bracket from the knuckle. Save hardware. **SEE FIGURES 1-2**

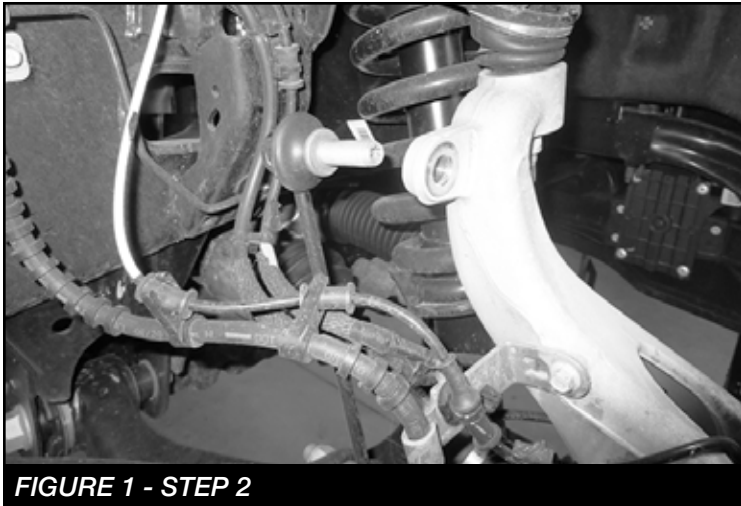

FIGURE 1 - STEP 2

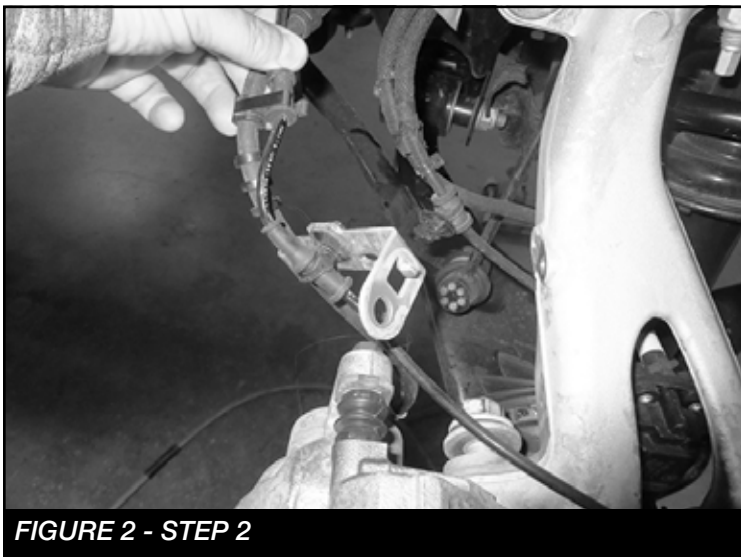

FIGURE 2 - STEP 2

3. Loosen the tie rod nut and carefully strike the knuckle with a hammer until it comes loose from the knuckle. Save hardware. **SEE FIGURE 3**

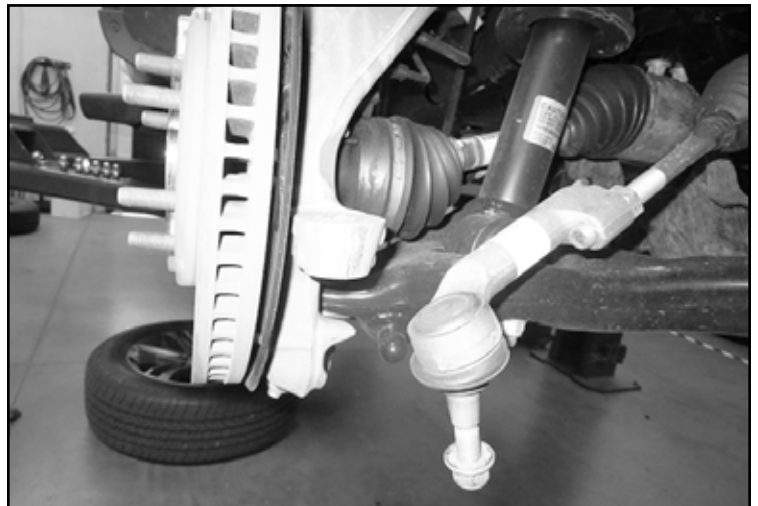

FIGURE 3 - STEP 3

4. Disconnect the brake caliper from the knuckle then remove from the rotor. Save hardware. Secure the caliper to the vehicle. Do not allow it to hang freely, this will cause damage to the brake lines. **SEE FIGURE 4**

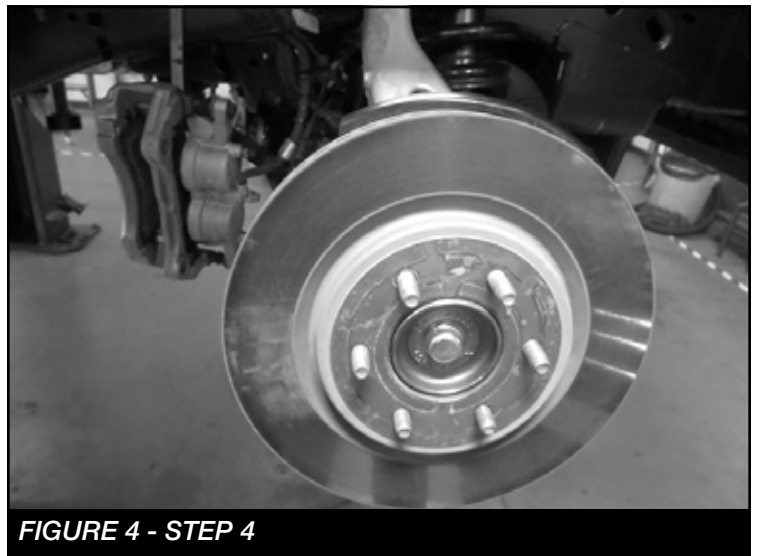

FIGURE 4 - STEP 4

5. Remove the rotor and dust shield by removing the three bolts attaching it to the knuckle. Save hardware. **SEE FIGURES 5-6**



FIGURE 5 - STEP 5

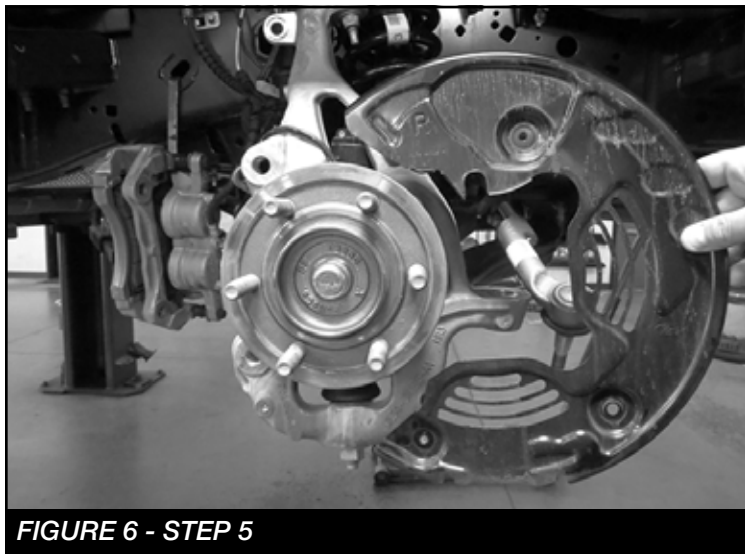

FIGURE 6 - STEP 5

6. Disconnect the ABS sensor from the knuckle and secure in a safe location. **SEE FIGURE 7**

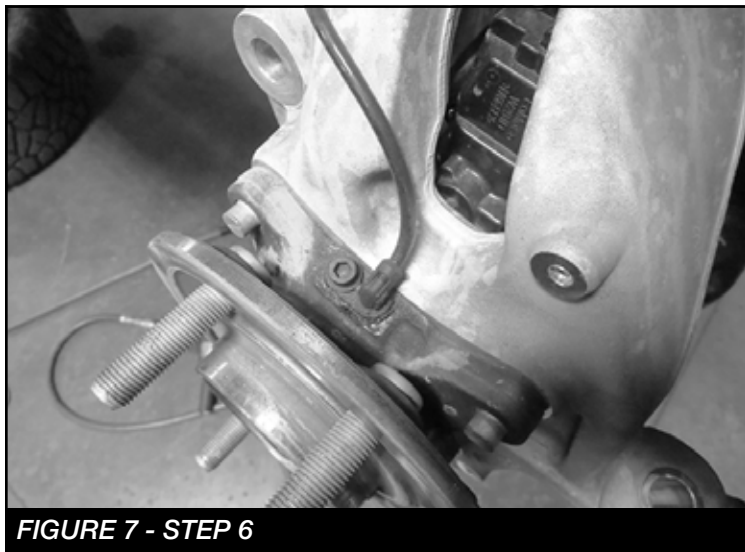

FIGURE 7 - STEP 6

7. Remove the axle shaft nut dust cover. Remove the nut and save. **SEE FIGURE 8**

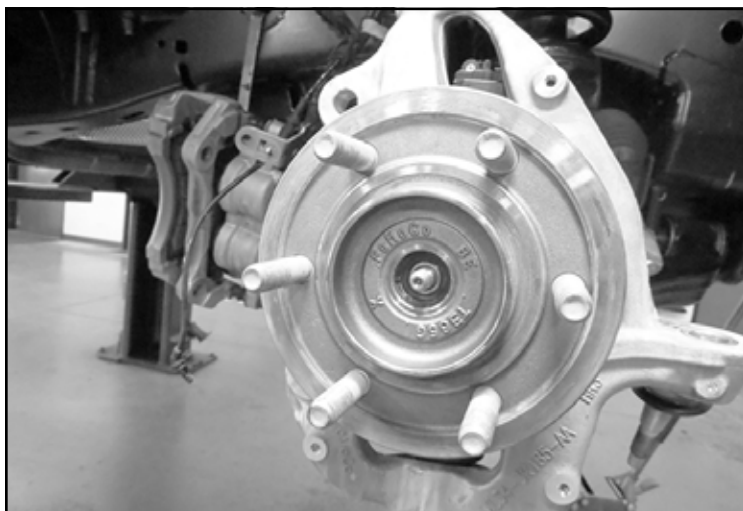

FIGURE 8 - STEP 7

8. Loosen the upper control arm ball joint nut. Using a hammer, carefully strike the knuckle until the ball joint is unseated. **SEE FIGURE 8**

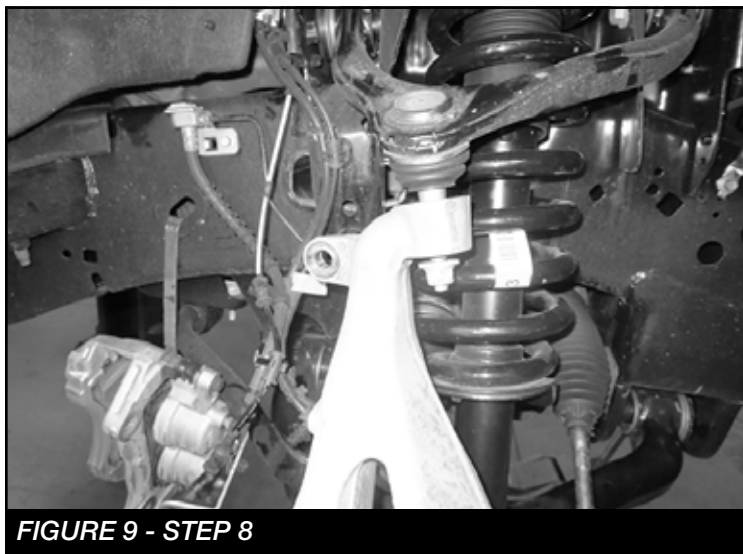

FIGURE 9 - STEP 8

9. Remove the upper ball joint nut and save. Angle the knuckle forward until the axle shaft has become detached from the hub assembly. **SEE FIGURES 10-11**

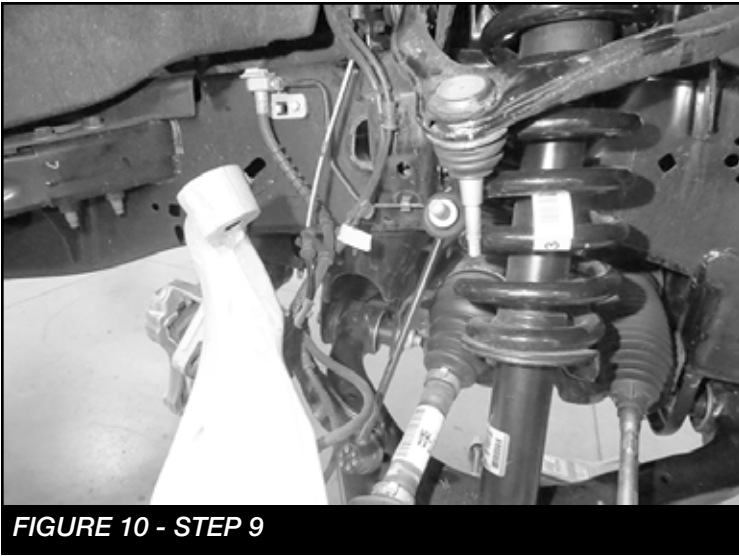

FIGURE 10 - STEP 9

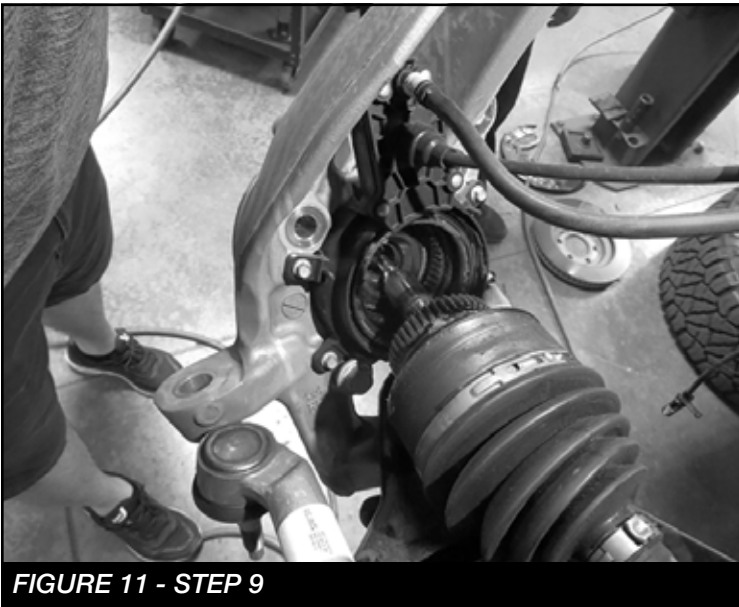

FIGURE 11 - STEP 9

10. Remove and save the four bolts attaching the hub actuator to the knuckle. Carefully secure the actuator aside. Remove the knuckle from the lower control arm ball joint by loosening the nut and carefully striking the knuckle until dislodged. Remove and save the nut. **SEE FIGURES 12-14**



FIGURE 12 - STEP 10

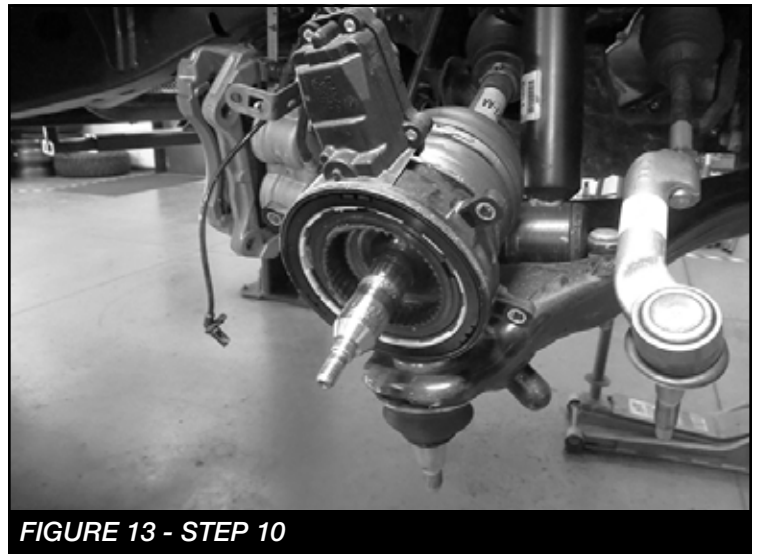

FIGURE 13 - STEP 10

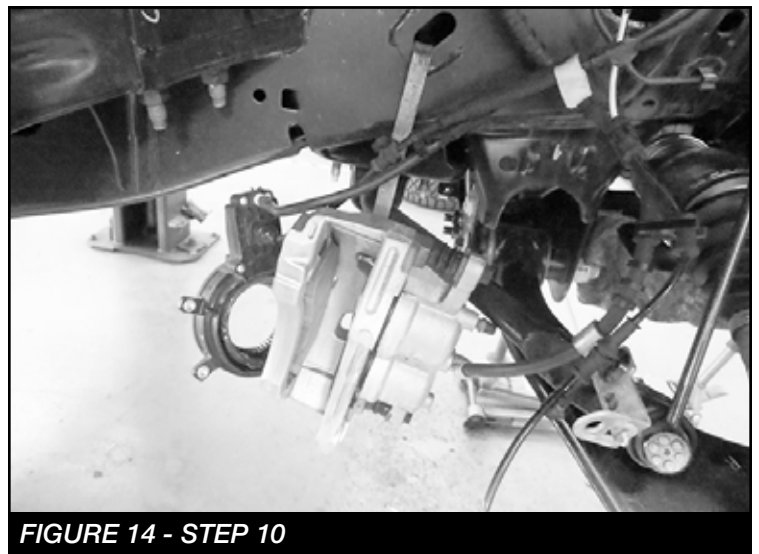

FIGURE 14 - STEP 10

11. Remove the hardware attaching the lower control arm to factory strut. **SEE FIGURE 15**



FIGURE 15 - STEP 11

12. Loosen the lower control arm pivot bolts so the arm can swing down freely. Then, Remove the three upper strut nuts and remove the factory strut from the vehicle. **SEE FIGURE 16**

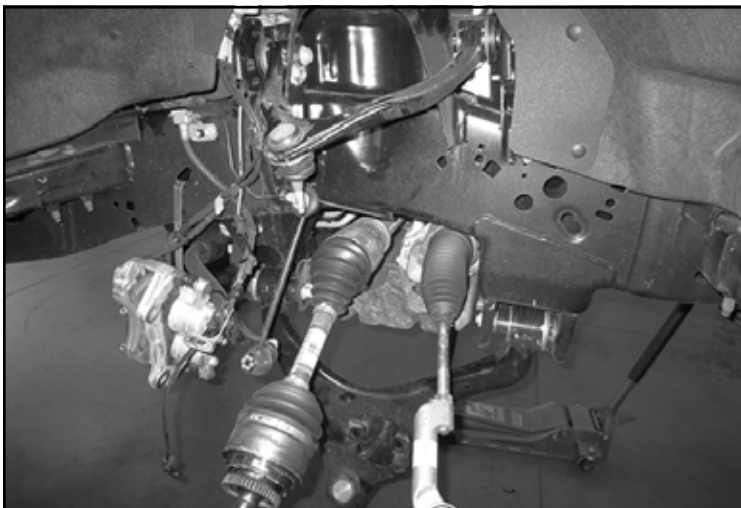

FIGURE 16 - STEP 12

13. Remove the upper control arm from the vehicle. Save all hardware. **SEE FIGURE 17**



FIGURE 17 - STEP 13

14. Locate FT30613BK & FT30614BK (Driver & Pass side control arms), four FT1007 bushings, two FT84 grease zerks and two FT195 sleeves. Install all these components into the control arms. **SEE FIGURE 18**

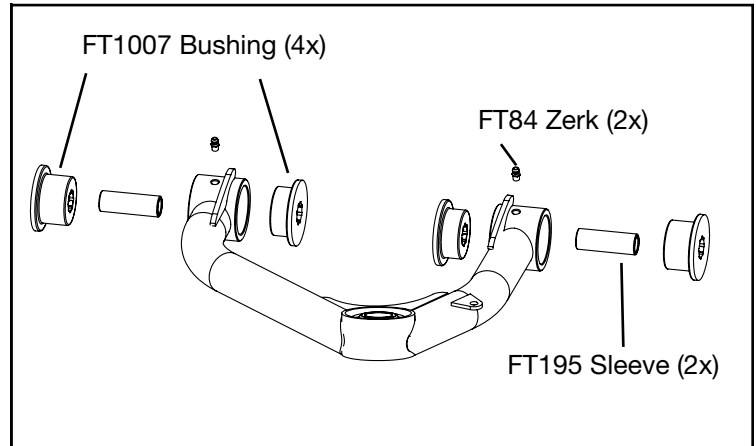

FIGURE 18 - STEP 14

15. Install the new Fabtech upper control arm in the factory upper control arm pockets using the factory hardware. When installing the arm on the truck make sure the barrel gussets are up. Torque to 100 ft- lbs. **SEE FIGURE 19**



FIGURE 19 - STEP 15

16. Install the New Dirt Logic Coilovers using the instructions supplied within the coilover box.

17. Reinstall the factory knuckle to the lower control arm. Torque to 110 ft-lbs.
18. Carefully install the 4wd hub actuator onto the CV shaft and to the knuckle using the factory bolts and thread locking compound. Torque the four bolts to 5 ft-lbs. **SEE FIGURE 20**



FIGURE 20 - STEP 18

19. SEE FIGURE 21 FOR STEPS 20-24

20. Install FT94503 (uniball pin) into the factory knuckle upper ball joint taper. Install the 1/2-20 c-lock nut with thread lock compound and flat washer onto the bottom side of the pin. This will lock the pin into the knuckle. Torque to 106 ft-lbs.
21. Install one FT147 uniball misalignment spacer on to the pin.
22. Swing the control arm down, slide the pin into the uniball on the control arm seating the lower FT147 spacer in the control arm.
23. Install the upper FT147 uniball misalignment spacer onto the pin.
24. Install the 3/4" -16 lock nut on the top side of the pin with thread lock compound and torque to 150 ft-lb

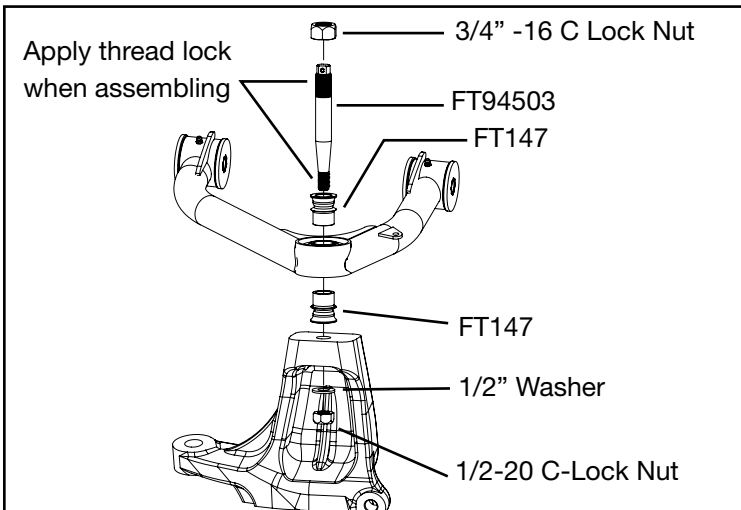

FIGURE 21 - STEP 19

25. Repeat steps on the opposite side.
26. Install the axle nut. Torque to 35 ft-lbs. Then install the axle nut cover. **SEE FIGURE 22**

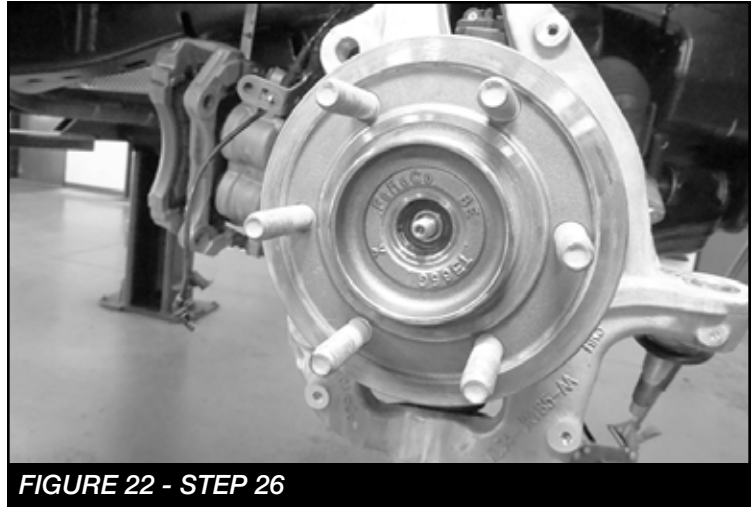

FIGURE 22 - STEP 26

27. Reinstall the ABS sensor into the factory knuckle using the factory hardware. Torque to 7 ft-lbs. **SEE FIGURE 23**

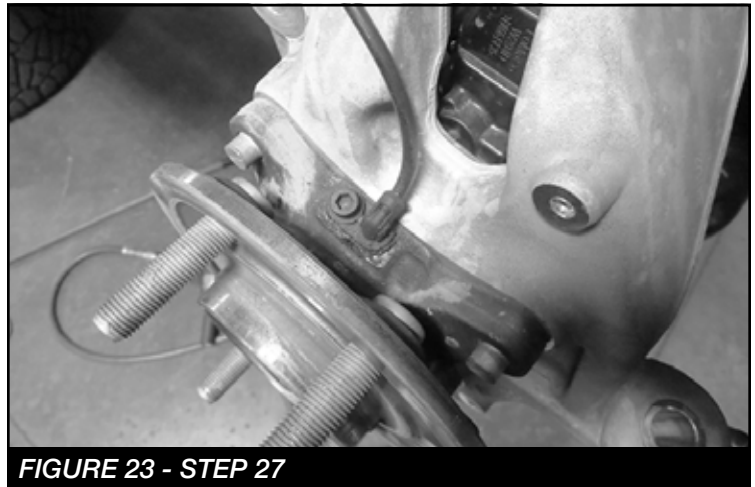

FIGURE 23 - STEP 27

28. Reinstall the factory dust shield using the factory hardware. Torque to 20 ft-lbs. **SEE FIGURE 24**

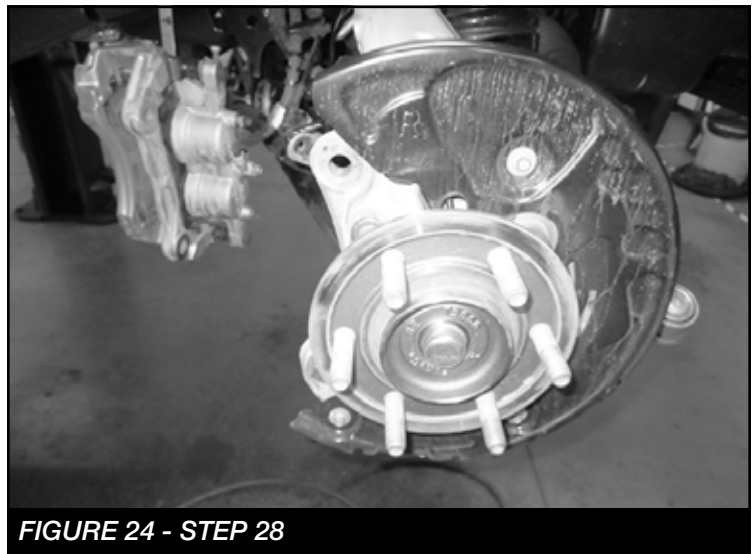

FIGURE 24 - STEP 28

29. Reinstall the brake rotor and brake caliper. Torque the caliper bolts to 160 ft-lbs.
30. Install the tie rod end and the sway bar link to the knuckle. Torque both to 35 ft-lbs.
31. Reconnect the brake line bracket to the knuckle using the factory hardware. Torque to 7 ft-lbs.
32. Repeat steps on the opposite side.
33. Torque the upper and lower control arm hardware to 180 ft-lbs.
34. Install tires and wheels and torque lug nuts to wheel manufacturer's specifications. Turn front tires left to right and check for appropriate tire clearance. **Note - Some oversized tires may require trimming of the front bumper & valance.**
35. Check front end alignment and set to factory specifications. Readjust headlights.
36. Recheck all bolts for proper torque.
37. Recheck brake hoses, ABS wires and suspension parts for proper tire clearance while turning tires fully left to right.
38. Install Driver Warning Decal. Complete product registration card and mail to Fabtech in order to receive future safety and technical bulletins on this suspension.

Vehicles that will receive oversized tires should check ball joints, uniballs and all steering components every 2500-5000 miles for wear and replace as required.

RETORQUE ALL NUTS, BOLTS AND LUGS AFTER 50 MILES AND PERIODICALLY THEREAFTER.

For technical assistance call: **909-597-7800**

- Product Warranty and Warnings -

Fabtech provides a Limited Lifetime Warranty to the original retail purchaser who owns the vehicle, on which the product was originally installed, for defects in workmanship and materials.

The Limited Lifetime Warranty excludes the following Fabtech items; bushings, bump stops, ball joints, tie rod ends, limiting straps, cross shafts, heim joints and driveshafts. These parts are subject to wear and are not considered defective when worn. They are warranted for 60 days from the date of purchase for defects in workmanship.

Dirt Logic and Performance Coilover take apart shocks are considered a serviceable shock with a one year warranty on leakage only. Service seal kits are available separately for future maintenance. All other shocks are covered under our Limited Lifetime Warranty.

Fabtech does not warrant any product for finish, alterations, modifications and/or installation contrary to Fabtech's instructions. Alterations to the finish of the parts including but not limited to painting, powder coating, plating and/or welding will void all warranties. Some finish damage may occur to parts during shipping, which is considered normal and is not covered under warranty.

Fabtech products are not designed nor intended to be installed on vehicles used in race applications or for racing purposes or for similar activities. (A "RACE" is defined as any contest between two or more vehicles, or any contest of one or more vehicle against the clock, whether or not such contest is for a prize). This warranty does not include coverage for police or taxi vehicles, race vehicles, or vehicles used for government or commercial purposes. Also excluded from this warranty are sales outside of the United States of America.

Installation of most suspension products will raise the center of gravity of the vehicle and will cause the vehicle to handle differently than stock. It may increase the vehicle's susceptibility to a rollover, on road and off road, at all speeds. Extreme care should be taken to operate the vehicle safely at all times to prevent rollover or loss of control resulting in serious injury or death. Fabtech front end Desert Guards may impair the deployment or operation of vehicles equipped with supplemental restraining systems/air bag systems and should not be installed if the vehicle is equipped as so.

Fabtech makes every effort to ensure suspension product compatibility with all vehicles listed on the website, but due to unknown auto manufacturer's production changes and/or inconsistencies by the auto manufacturer, Fabtech cannot be responsible for 100% compatibility, including the fitment of tire and wheel sizes listed. The Tire and Wheel sizes listed in Fabtech's website are only a guideline for street driving with noted fender trimming. Fabtech is not responsible for damages to the vehicle's body or tires. Fabtech is not responsible for premature wear of factory components due to the installation of oversized tires and wheels.

Fabtech's obligation under this warranty is limited to the repair or replacement, at Fabtech option, of the defective product only. All costs of removal, installation or re-installation, freight charges, incidental or consequential damages are expressly excluded from this warranty. Fabtech is not responsible for damages and/or warranty of other vehicle parts related or non related to the installed Fabtech product. This warranty is expressly in lieu of all other warranties expressed or implied. This warranty shall not apply to any product that has been subject to accident, negligence, alteration, abuse or misuse as determined by Fabtech.

Fabtech suspension components must be installed as a complete system including shocks as shown on our website. All warranties will become void if Fabtech parts are combined and/or substituted with other aftermarket suspension products. Combination and/or substitution of other aftermarket suspension parts may cause premature wear and/or product failure resulting in an accident causing injury or death. Fabtech does not warrant products not manufactured by Fabtech.

Depending on the condition of the factory suspension components retained after the installation of a Fabtech suspension not all vehicles may have the same ride stance front to rear as described in the website. The blue color of suspension components shown in all Fabtech photographs are for display purposes only. Majority of all Fabtech components will be black specifically where noted with part numbers ending in BK.

Installation of Fabtech product may void the vehicles factory warranty; it is the consumer's responsibility to check with their local vehicle's dealer for warranty disposition before the installation of the product. Some state laws may prohibit modification of suspension to a vehicle in whole or in part. It is the responsibility of the installer and consumer to consult local laws prior to the installation of any Fabtech suspension product to comply with such written laws.

It is the responsibility of the distributor and/or the retailer to review all warranties and warnings of Fabtech products with the consumer prior to purchase.

Fabtech reserves the right to super cede, discontinue, change the design, finish, part number and/or application of parts when deemed necessary without written notice. Fabtech is not responsible for misprints or typographical errors within the website or price sheet. For the most recent Product Warranty and Warnings visit our website www.fabtechmotorsports.com