



## **INSTALLATION INSTRUCTIONS**



### **2014-2017 DODGE 2500 4WD 5" SYSTEMS**

**FTS23053 / FTS23161 / FTS23195 - BASIC SYSTEMS**

**FTS23055 / FTS23162 / FTS23197 - RADIUS ARM SYSTEMS**

<b>FTS23053 5" BASIC KIT W/ PERFORMANCE SHOCKS</b>		
1	FT44172	DODGE PITMAN ARM
2	FT44232BK	RADIUS ARM DROP
1	FT44236BK	TRACK BAR BRACKET
1	FT44237BK	5" COIL SPACER (DRIVER)
1	FT44238BK	5" COIL SPACER (PASSENGER)
1	FT44243BK	BUMP STOP MOUNT (DRIVER)
1	FT44244BK	BUMP STOP MOUNT (PASSENGER)
1	FT44276	HARDWARE SUBASSEMBLY
1	FT44278	HARDWARE KIT
1	FT44269BK	REAR TRACK BAR SUPPORT
2	FT44267BK	REAR SPRING SPACER
2	FT44268BK	REAR BUMP STOP SPACER
2	FT1599-2-4	5" SWAY BAR LINK
2	FTS7343	PERFORMANCE SHOCK (FRONT)
2	FTS7344	PERFORMANCE SHOCK (REAR)

<b>FTS23161 5" BASIC KIT W/ DIRT LOGIC SHOCKS</b>		
1	FT44172	DODGE PITMAN ARM
2	FT44232BK	RADIUS ARM DROP
1	FT44236BK	TRACK BAR BRACKET
1	FT44237BK	5" COIL SPACER (DRIVER)
1	FT44238BK	5" COIL SPACER (PASSENGER)
1	FT44243BK	BUMP STOP MOUNT (DRIVER)
1	FT44244BK	BUMP STOP MOUNT (PASSENGER)
1	FT44276	HARDWARE SUBASSEMBLY
1	FT44278	HARDWARE KIT
1	FT44269BK	REAR TRACK BAR SUPPORT
2	FT44267BK	REAR SPRING SPACER
2	FT44268BK	REAR BUMP STOP SPACER
2	FT1599-2-4	5" SWAY BAR LINK
2	FTS811032	DIRT LOGIC 2.25 NON RESI (FRONT)
2	FTS811042	DIRT LOGIC 2.25 NON RESI (REAR)

<b>FTS23195 5" BASIC KIT W/ STEALTH SHOCKS</b>		
1	FT44172	DODGE PITMAN ARM
2	FT44232BK	RADIUS ARM DROP
1	FT44236BK	TRACK BAR BRACKET
1	FT44237BK	5" COIL SPACER (DRIVER)
1	FT44238BK	5" COIL SPACER (PASSENGER)
1	FT44243BK	BUMP STOP MOUNT (DRIVER)
1	FT44244BK	BUMP STOP MOUNT (PASSENGER)
1	FT44276	HARDWARE SUBASSEMBLY
1	FT44278	HARDWARE KIT
1	FT44269BK	REAR TRACK BAR SUPPORT
2	FT44267BK	REAR SPRING SPACER
2	FT44268BK	REAR BUMP STOP SPACER
2	FT1599-2-4	5" SWAY BAR LINK
2	FTS6343	STEALTH MONOTUBE SHOCK (FRONT)
2	FTS6344	STEALTH MONOTUBE SHOCK (REAR)

<b>FT44278 - HARDWARE KIT</b>		<b>LOCATION</b>
1	M18-2.5 X 90MM HEX BOLT	TRACK BAR DROP BRACKET
2	M18 WASHERS	
1	NUT C-LOCK 18MM G10.9 ZINC	
2	M18-2.5 X 120MM HEX BOLT	RADIUS ARM POCKET
4	M18 WASHERS	
2	NUT C-LOCK 18MM G10.9 ZINC	
12	1/2-13 X 1-1/4 HEX BOLT G8 ZNC	RADIUS ARM POCKET/BUMP STOP
24	1/2 SAE WASHER G8 ZINC	
12	1/2-13 C-LOCK NUT ZINC	
2	1/2-13 X 1-1/2 HEX BOLT G8 ZNC	TRACK BAR DROP BRACKET
4	1/2 SAE WASHER G8 ZINC	
2	1/2-13 C-LOCK NUT ZINC	
2	5/16-18 X 2-1/2 HEX BOLT G8 ZINC	BUMP STOP
4	5/16 SAE WASHER G8 ZINC	
2	5/16-18 C-LOCK NUT ZINC	
4	7/16-14 X 1-1/4 HEX BOLT G8 ZC	COIL SPACER/REAR BUMP STOP
8	7/16 SAE WASHER G8 ZINC	
4	7/16-14 C-LOCK NUT ZINC	
2	1/2-13 X 3-1/2 BUTTONHEAD BOLT	COIL SPACER
4	1/2 SAE WASHER G8 ZINC	
2	1/2-13 C-LOCK NUT ZINC	
4	1/4-20 X 1 HEX BOLT G5 ZINC	BRAKE LINE EXTENSION
2	1/4 SAE WASHER G5 ZINC	
2	1/4-20 C-LOCK NUT ZINC	
8	1/2 USS WASHER G5 ZINC	SWAY BAR LINK
4	M12-1.75 X 70MM HEX BOLT G10.9	
4	NUT 12-1.75 NYLOK 10.9 Z1	
5	7/16-14 X 1-1/4 HEX BOLT G8 ZC	REAR COIL SPACER/REAR TRACK BAR DROP BRACKET
10	7/16 SAE WASHER G8 ZINC	
5	7/16-14 C-LOCK NUT ZINC	
1	1/2-13 X 1-1/4 HEX BOLT G8 ZNC	REAR TRACK BAR BRACKET
1	1/2-13 X 2-1/4 HEX BOLT G8 ZNC	
4	1/2 SAE WASHER G8 ZINC	
2	1/2-13 C-LOCK NUT ZINC	
1	9/16-18 X 3-1/2 HEX BOLT G8 ZC	
2	9/16 SAE WASHER G8 ZINC	
1	9/16" -18 C LOCK NUT	
1	1/4-20 X 1 HEX BOLT G8 ZINC	
2	1/4 SAE WASHER G5 ZINC	
1	1/4-20 NYLOCK NUT ZINC	REAR END BREATHER
1	SPN-10 CUSHIONED CLAMP	

**- PARTS LIST -  
BASIC SYSTEMS CONTINUED**

<b>FT44276</b>		<b>HARDWARE SUBASSEMBLY</b>
2	FT604	SLEEVE 1.000 X .760 X 2.600
1	FT605	SLEEVE 1.000 X .563 X 1.855
1	FT606	SLEEVE .750 X .515 X .780
8	FT1004	SWAY BAR LINK BUSHING HALF
4	FT404739	SLEEVE OD 0.62 ID 12MM L.1.48
2	FT44135	BUMP STOP MOUNT TAB
1	FT44239	WASHER 4.250 X .510 X .250
2	FT44245	BRAKE LINE EXT
1	FT44246	TRACK BAR SUPPORT SPACER
2	FT44253	RADIUS ARM DROP NUT TAB
2	FT44258	1/4 NUT TAB
1	FT44270	NUT TAB
1	FT50184	TRAC BAR SUPPORT NUT TAB
2	FTS88	BUMPSTOP 1 IN TALL LOW RND
1	FTAS16	DRIVER WARNING DECAL
1	FTREGCARD	REGISTRATION CARD
1	FT23053I	INSTRUCTIONS

## - PARTS LIST - RADIUS ARM SYSTEMS

<b>FTS23055</b>		<b>5" RADIUS ARM W/PERFORMANCE SHOCKS</b>
1	FT44243BK	BUMP STOP MOUNT (DRIVER)
1	FT44244BK	BUMP STOP MOUNT (PASSENGER)
1	FT44236BK	TRACK BAR BRACKET
1	FT44237BK	5" COIL SPACER (DRIVER)
1	FT44238BK	5" COIL SPACER (PASSENGER)
1	FT44172	DODGE PITMAN ARM
1	FT44449	RADIUS ARM (DRIVER)
1	FT44450	RADIUS ARM (PASSENGER)
2	FT44267BK	REAR SPRING SPACER
2	FT44268BK	REAR BUMP STOP SPACER
1	FT44269BK	REAR TRACK BAR SUPPORT
2	FT1599-2-4	5" SWAY BAR LINK CLEAR ZINC
1	FT44277	HARDWARE SUBASSEMBLY
1	FT44280	HARDWARE KIT
2	FTS7343	PERFORMANCE SHOCK (FRONT)
2	FTS7344	PERFORMANCE SHOCK (REAR)

<b>FTS23197</b>		<b>5" RADIUS ARM W/ STEALTH SHOCKS</b>
1	FT44243BK	BUMP STOP MOUNT (DRIVER)
1	FT44244BK	BUMP STOP MOUNT (PASSENGER)
1	FT44236BK	TRACK BAR BRACKET
1	FT44237BK	5" COIL SPACER (DRIVER)
1	FT44238BK	5" COIL SPACER (PASSENGER)
1	FT44172	DODGE PITMAN ARM
1	FT44449	RADIUS ARM (DRIVER)
1	FT44450	RADIUS ARM (PASSENGER)
2	FT44267BK	REAR SPRING SPACER
2	FT44268BK	REAR BUMP STOP SPACER
1	FT44269BK	REAR TRACK BAR SUPPORT
2	FT1599-2-4	5" SWAY BAR LINK CLEAR ZINC
1	FT44277	HARDWARE SUBASSEMBLY
1	FT44280	HARDWARE KIT
2	FTS6343	STEALTH MONOTUBE SHOCK (FRONT)
2	FTS6344	STEALTH MONOTUBE SHOCK (REAR)

<b>FTS23162</b>		<b>5" RADIUS ARM W/DIRT LOGIC SHOCKS</b>
1	FT44243BK	BUMP STOP MOUNT (DRIVER)
1	FT44244BK	BUMP STOP MOUNT (PASSENGER)
1	FT44236BK	TRACK BAR BRACKET
1	FT44237BK	5" COIL SPACER (DRIVER)
1	FT44238BK	5" COIL SPACER (PASSENGER)
1	FT44172	DODGE PITMAN ARM
1	FT44449	RADIUS ARM (DRIVER)
1	FT44450	RADIUS ARM (PASSENGER)
2	FT44267BK	REAR SPRING SPACER
2	FT44268BK	REAR BUMP STOP SPACER
1	FT44269BK	REAR TRACK BAR SUPPORT
2	FT1599-2-4	5" SWAY BAR LINK CLEAR ZINC
1	FT44277	HARDWARE SUBASSEMBLY
1	FT44280	HARDWARE KIT
2	FTS811032	DIRT LOGIC 2.25 NON RESI (FRONT)
2	FTS811042	DIRT LOGIC 2.25 NON RESI (REAR)

**- PARTS LIST -  
RADIUS ARM SYSTEMS CONTINUED**

<b>FT44277</b>		<b>HARDWARE SUBASSEMBLY</b>
2	FT102	SLEEVE 1.000 X .732 X 3.280
4	FT1006	BUSHING C1500 L.T. LOWER
1	FT44270	NUT TAB
1	FT605	SLEEVE 1.000 X .563 X 1.855
1	FT606	SLEEVE .750 X .515 X .780
8	FT1004	SWAY BAR LINK BUSHING HALF
4	FT404739	SLEEVE OD 0.62 ID 12MM L.1.48
1	FT50184	TRAC BAR SUPPORT NUT TAB
2	FT44135	BUMP STOP MOUNT TAB
1	FT44239	WASHER 4.250 X .510 X .250
2	FT44245	BRAKE LINE EXT
1	FT44246	TRACK BAR SUPPORT SPACER
2	FT44253	RADIUS ARM DROP NUT TAB
2	FT44258	1/4 NUT TAB
2	FTS88	BUMPSTOP 1 IN TALL LOW RND
1	FTAS16	DRIVER WARNING DECAL
1	FTREGCARD	REGISTRATION CARD
1	FT23055I	INSTRUCTIONS

<b>FT44280 - HARDWARE KIT</b>		<b>LOCATION</b>
1	M18-2.5 X 90MM HEX BOLT	TRACK BAR DROP BRACKET
2	M18 WASHERS	
1	NUT C-LOCK 18MM G10.9 ZINC	
4	1/2-13 X 1-1/4 HEX BOLT G8 ZNC	BUMP STOP
8	1/2 SAE WASHER G8 ZINC	
4	1/2-13 C-LOCK NUT ZINC	
2	1/2-13 X 1-1/2 HEX BOLT G8 ZNC	TRACK BAR DROP BRACKET
4	1/2 SAE WASHER G8 ZINC	
2	1/2-13 C-LOCK NUT ZINC	
2	5/16-18 X 2-1/2 HEX BOLT G8 ZINC	BUMP STOP
4	5/16 SAE WASHER G8 ZINC	
2	5/16-18 C-LOCK NUT ZINC	
4	7/16-14 X 1-1/4 HEX BOLT G8 ZC	COIL SPACER/REAR BUMP STOP
8	7/16 SAE WASHER G8 ZINC	
4	7/16-14 C-LOCK NUT ZINC	
2	1/2-13 X 3-1/2 BUTTONHEAD BOLT	COIL SPACER
4	1/2 SAE WASHER G8 ZINC	
2	1/2-13 C-LOCK NUT ZINC	
4	1/4-20 X 1 HEX BOLT G5 ZINC	BRAKE LINE EXTENSION
2	1/4 SAE WASHER G5 ZINC	
2	1/4-20 C-LOCK NUT ZINC	
8	1/2 USS WASHER G5 ZINC	SWAY BAR LINK
4	M12-1.75 X 70MM HEX BOLT G10.9	
4	NUT 12-1.75 NYLOK 10.9 Z1	
5	7/16-14 X 1-1/4 HEX BOLT G8 ZC	REAR COIL SPACER/REAR TRACK BAR DROP BRACKET
10	7/16 SAE WASHER G8 ZINC	
5	7/16-14 C-LOCK NUT ZINC	
1	1/2-13 X 1-1/4 HEX BOLT G8 ZNC	REAR TRACK BAR BRACKET
1	1/2-13 X 2-1/4 HEX BOLT G8 ZNC	
4	1/2 SAE WASHER G8 ZINC	
2	1/2-13 C-LOCK NUT ZINC	
1	9/16-18 X 3-1/2 HEX BOLT G8 ZC	
2	9/16 SAE WASHER G8 ZINC	
1	9/16" -18 C LOCK NUT	
1	1/4-20 X 1 HEX BOLT G8 ZINC	
2	1/4 SAE WASHER G5 ZINC	
1	1/4-20 NYLOCK NUT ZINC	REAR END BREATHER
1	SPN-10 CUSHIONED CLAMP	
2	THREAD LOCKING COMPOUND 2 MIL	



## - TOOL LIST -

### ***Required Tools (Not Included)***

Basic Hand Tools  
Floor Jack  
Jack Stands  
Assorted Metric and S.A.E sockets, and Allen wrenches  
Torque Wrench  
Die Grinder w/ Cutoff Wheel or Sawzall

## - PRE-INSTALLATION NOTES -

### ***Read this before you begin installation-***

Check all parts to the parts list above before beginning installation.

Read all instructions thoroughly from start to finish before beginning the installation. If these instructions are not properly followed severe frame, driveline and / or suspension damage may occur.

Check your local city and state laws prior to the installation of this system for legality. Do not install if not legal in your area.

Prior to the installation of this suspension system perform a front end alignment and record. Do not install this system if the vehicle alignment is not within factory specifications. Check for frame and suspension damage prior to installation.

The installation of this suspension system should be performed by two professional mechanics.

This suspension must be installed with Fabtech shock absorbers.

Use the provided thread locking compound on all hardware.

**WARNING-** Installation of this system will alter the center of gravity of the vehicle and may increase roll over as compared to stock.

Vehicles that receive oversized tires should check ball joints, uniballs, tie rods ends, pitman arm and idler arm every 2500-5000 miles for wear and replace as needed.

Verify differential fluid is at manufactures recommended level prior to kit installation. Installation of the kit will reposition the differential and the fill plug hole may be in a different position. (For example, if the manufacture recommends 3 quarts of fluid, make sure the diff has 3 quarts of fluid). Check your specific manual for correct amount of fluid.

### ***RECOMMENDED TIRE/WHEEL SIZES -***

Use 37x12.50/R17 tire w/ 17x9 wheels w/ 5" BS w/ minor trimming

Use 37x12.50/R18 tire w/ 18x9 wheels w/ 5" BS w/ minor trimming

Use 37x13.50/R20 tire w/ 20x9.5 wheels w/ 5" BS w/ minor trimming

Use 37x13.50/R22 tire w/ 22x9.5 wheels w/ 5" BS w/ minor trimming

# - INSTRUCTIONS -

## FRONT SUSPENSION

1. Disconnect the negative terminal on the battery. Jack up the front end of the truck and support the frame rails with jack stands. **NEVER WORK UNDER AN UNSUPPORTED VEHICLE!** Remove the front tires.
2. **DRIVER SIDE ONLY** - Starting on the driver side, remove the driver side fender liner.
3. Remove the factory shock and discard. Retain factory lower hardware.
4. Disconnect factory sway bar links.
5. Remove factory coil spring and rubber isolator. Retain these parts for later use.
6. Remove the factory pitman arm and discard. Keep hardware.
7. Locate the new FT44172 Fabtech pitman arm and install. Do not reconnect the factory drag link at this time. Reinstall the factory lock washer plus thread locker. Torque to 220ft-lbs.
8. Unthread the factory drag link at the adjuster sleeve and remove adjuster sleeve. **SEE FIGURE 1**

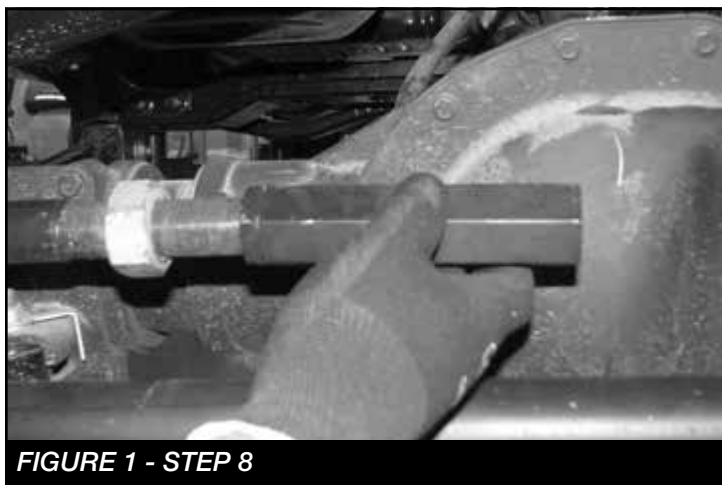


FIGURE 1 - STEP 8

9. Using a die grinder remove the flat nonthreaded section from both ends of the drag link. This will allow you to rotate the drag link and line it up with the pitman arm. **SEE FIGURES 2-4**



FIGURE 2 - STEP 9



FIGURE 3 - STEP 9

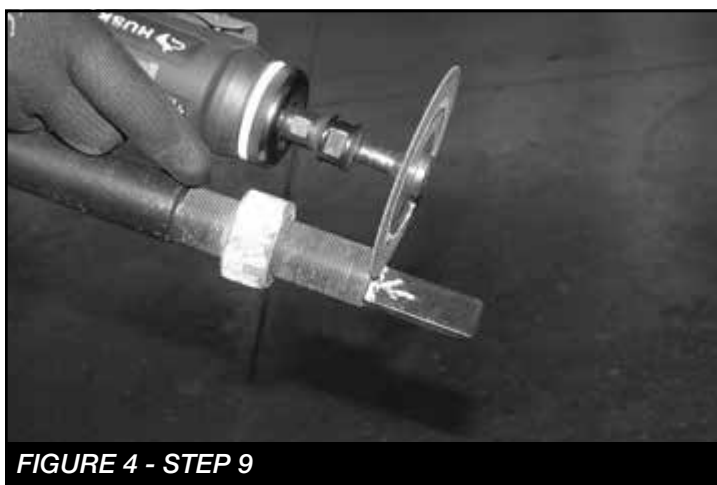
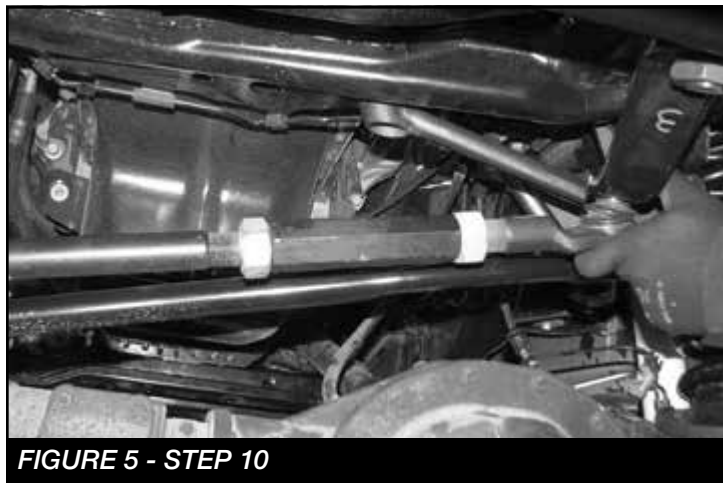


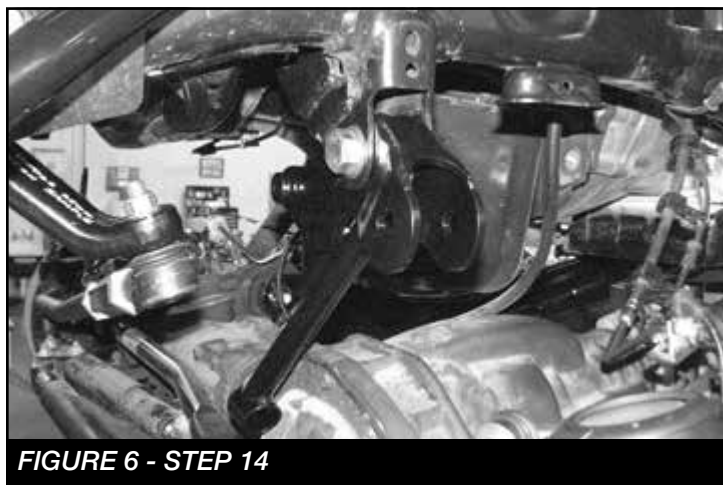
FIGURE 4 - STEP 9

10. Reassemble the drag link and connect it to the new pitman arm. **SEE FIGURE 5**



**FIGURE 5 - STEP 10**

11. Torque the drag link to 83 ft-lbs.  
12. Remove the track bar from the frame side of the vehicle.  
13. Locate the FT44236BK track bar bracket and M18-2.5 x 90mm bolt.  
14. Slide the track bar bracket into the factory mount and insert the M18 bolt into the factory pivot hole. **SEE FIGURE 6**



**FIGURE 6 - STEP 14**

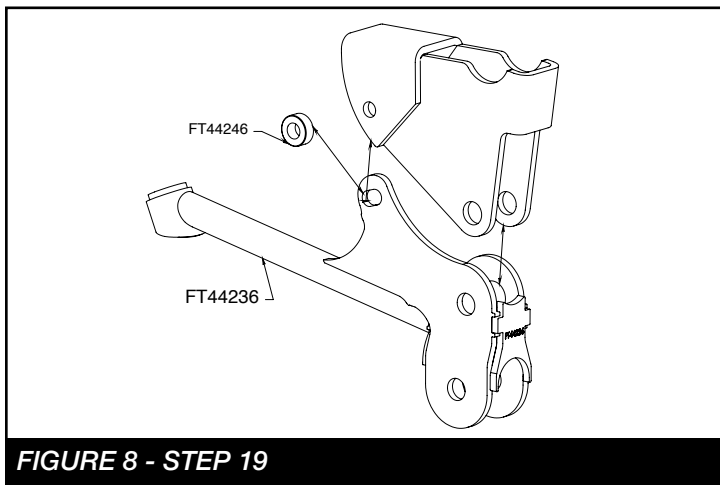
15. Rotate the bracket up until the end of the bracket is flush with the crossmember under the motor.  
16. Using the Fabtech bracket as a guide, mark the factory mount for the upper driver side mounting hole.

17. Swing the bracket back out of the way. Using a 1/2" drill bit, drill out the marked hole. **SEE FIGURE 7**



**FIGURE 7 - STEP 17**

18. Locate one FT44246 sleeve and two 1/2"-13 x 1-1/2" bolts, nuts and washers.  
19. Rotate the track bar bracket back into place and bolt together using 1/2"-13 x 1-1/2" bolt and the sleeve. **SEE FIGURES 8-9**



**FIGURE 8 - STEP 19**



**FIGURE 9 - STEP 19**

20. Using the Fabtech bracket as a guide, drill a 1/2" hole in the cross member under the motor. Next, mount using 1/2"-13x1.5" and washer. **SEE FIGURE 10**



**FIGURE 10 - STEP 20**

21. **DRIVER SIDE ONLY** - Locate the Brake control module on the top of the coil bucket. **SEE FIGURE 11**

**NOTE: IF INSTALLING DUAL SHOCKS DO SO NOW WITH THE INSTRUCTIONS PROVIDED**



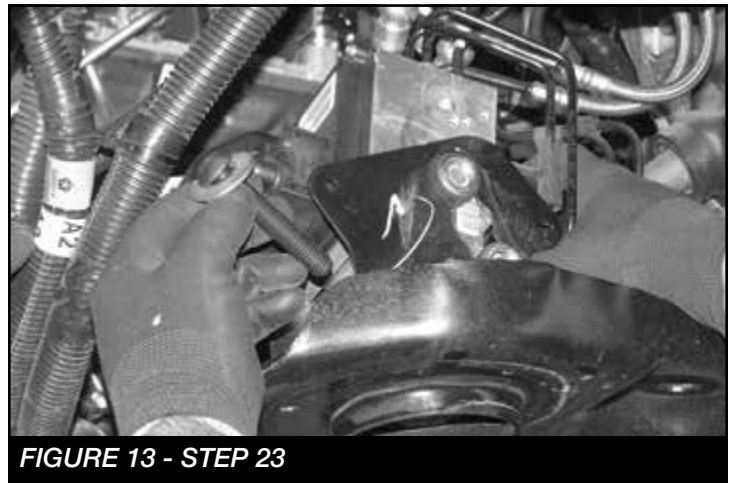
**FIGURE 11 - STEP 21**

22. Remove the bolts that attach the module to the mounting bracket on the top of the bucket. Retain hardware. **SEE FIGURE 12**



**FIGURE 12 - STEP 22**

23. Lift the module with care not to damage any brake lines and install the 1/2" -13 x 4" button head bolt and washer through the top hole in the coil bucket. **SEE FIGURES 13-14**

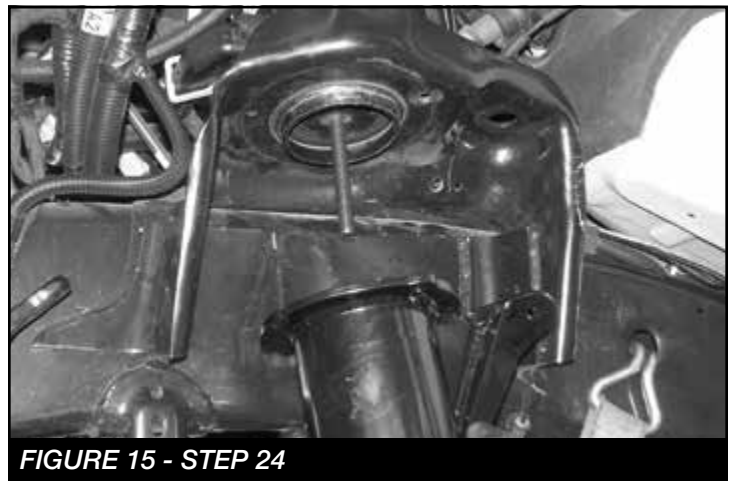


**FIGURE 13 - STEP 23**



**FIGURE 14 - STEP 23**

24. Locate the FT44237BK coil spacer. Install the coil spacer into the top of the factory coil bucket passing the button head bolt through the center hole in the Fabtech coil spacer. Attach a flat washer and locking nut to the 1/2" button head bolt. Leave loose at this time. **SEE FIGURE 15**



**FIGURE 15 - STEP 24**

25. Install a 7/16"-14 x 1-1/4" bolt, nut and washer through the coil bucket in the locating tab on the Fabtech spacer. **SEE FIGURE 16**



**FIGURE 16 - STEP 25**

26. Torque the 7/16" bolt to 59 ft-lbs and the 1/2" button head bolt to 90 ft-lbs. **SEE FIGURE 17**



**FIGURE 17 - STEP 26**

27. Using the support tab on the coil spacer as a drill guide, drill a 7/16" hole through the factory coil bucket. **SEE FIGURE 18**



**FIGURE 18 - STEP 27**

28. Install a 7/16"-14 x 1-1/4" bolt, nut and washer through the coil bucket and torque the 7/16" bolt to 59 ft-lbs. **SEE FIGURE 19**



**FIGURE 19 - STEP 28**

29. Locate and remove the factory rubber bump stop. **SEE FIGURE 20**



**FIGURE 20 - STEP 29**

30. Using a die grinder, grind out the stamped in tabs on the inside of the bump stop housing. **SEE FIGURES 21-22**



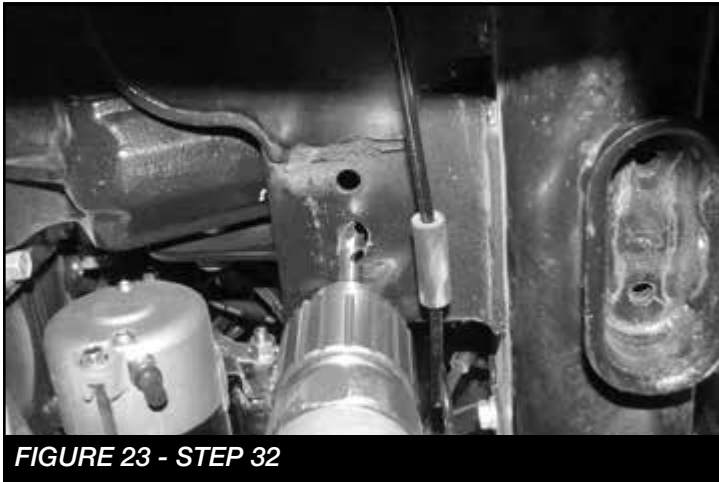
**FIGURE 21 - STEP 30**



**FIGURE 22 - STEP 30**

31. Locate the FT44243BK driver front bump stop and the FT44135 nut tab.

32. Using a 1/2" drill bit, drill out the hole in the factory crossmember inline with the factory bump stop mount. **SEE FIGURE 23**



**FIGURE 23 - STEP 32**

33. Slide the bump stop into the factory bump stop mount. Using a 1/2"-13 x 1-1/4" bolt and the nut tab, bolt the bump stop to the crossmember. Torque the 1/2" bolt to 90 ft-lbs. **SEE FIGURES 24-26**



**FIGURE 24 - STEP 33**



**FIGURE 25 - STEP 33**



**FIGURE 26 - STEP 33**

34. Using the outer tab on the bump stop as a drill guide, drill a 5/16" hole all the way through the factory bump stop mount. **SEE FIGURE 26**



**FIGURE 27 - STEP 35**

35. Locate a 5/16"-18 x 2-1/2" bolt, nut and washers. Using this bolt, secure the bump stop to the factory bump stop mount and torque to 29 ft-lbs. **SEE FIGURE 28**

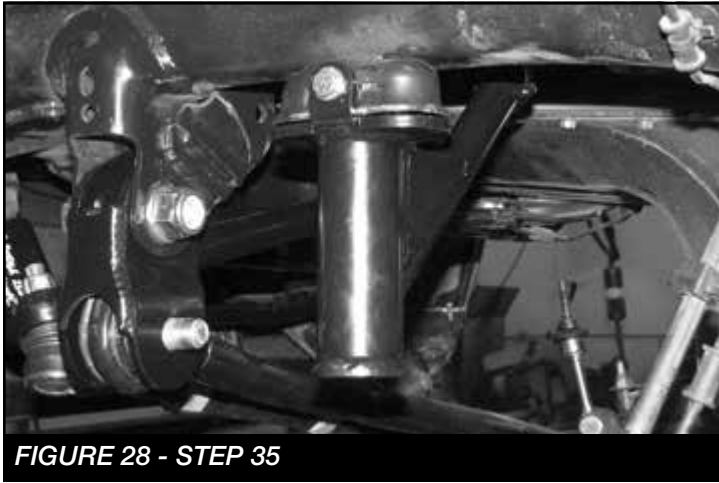


FIGURE 28 - STEP 35

36. Locate the FTS88 bump stop pad and thread it into the bottom of the Fabtech bump stop. **SEE FIGURE 29**

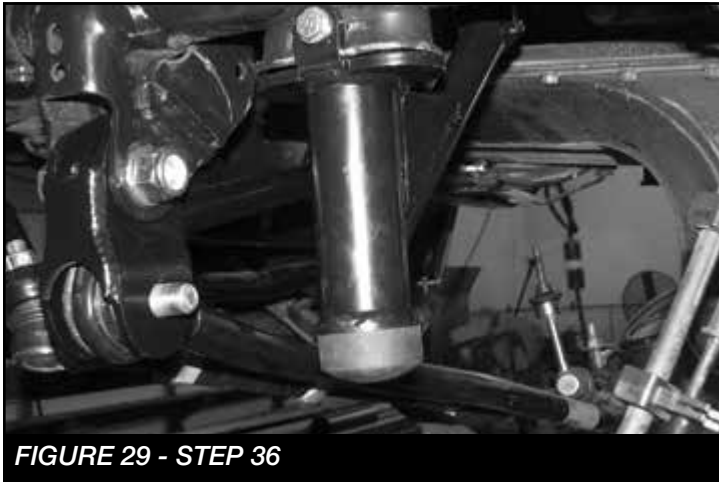


FIGURE 29 - STEP 36

37. Repeat steps 2-36 on the passenger side. On **PASSENGER SIDE ONLY** install the 1/2" -13 x 4" Button head bolt and FT44239 washer through the top hole in the coil bucket. **SEE FIGURE 30**



FIGURE 30 - STEP 37

38. Secure the front diff. Remove the factory driver and passenger side Radius arm. Retain Hardware. **SEE FIGURE 31**

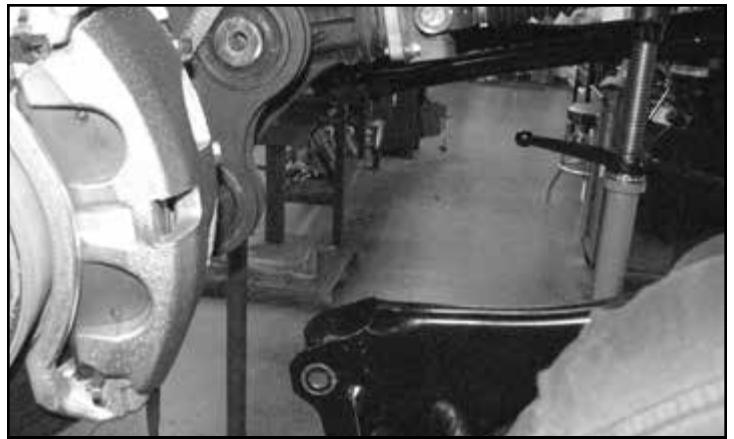


FIGURE 31 - STEP 38

**IF INSTALLING FABTECH RADIUS ARMS SKIP TO STEP 51**

39. Remove the factory crossmember and skid plate that is mounted between the factory radius arm pockets. Retain Hardware. **SEE FIGURE 32**



FIGURE 32 - STEP 39

40. Trim 1/2" off both driver and passenger ends of the crossmember leaving a 1/4" border perpendicular to the bolt holes. This will be done to add clearance for the Fabtech radius arm brackets. **SEE FIGURES 33-34**

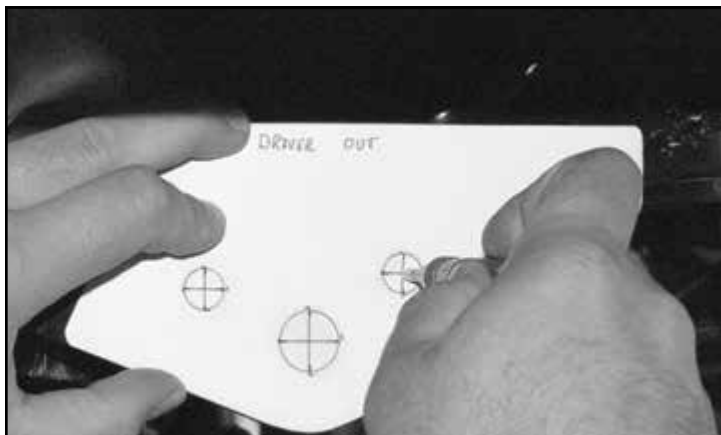


FIGURE 33 - STEP 40



**FIGURE 34 - STEP 40**

41. Reinstall the factory crossmember and torque to 200 ft-lbs.
42. Locate the Fabtech FT44232BK Radius arm drop bracket and the drill template in the instructions (**Page 26**). Cut out the template.
43. Line up the drill template with the factory Radius arm bracket and mark the two holes around the radius arm pivot bolt. **SEE FIGURE 35**

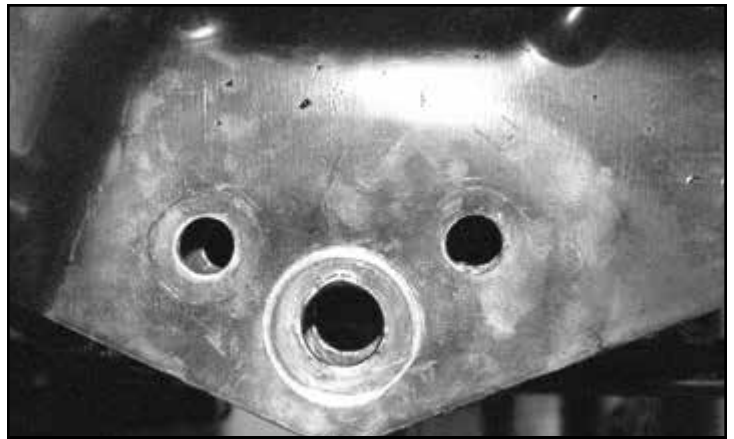


**FIGURE 35 - STEP 43**

44. Using a 1/2" drill bit, drill all the way through both sides of the factory radius arm mount. **SEE FIGURES 36-37**



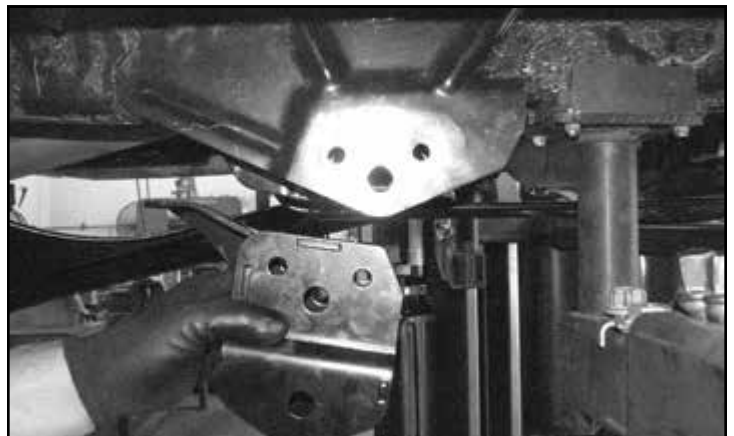
**FIGURE 36 - STEP 44**



**FIGURE 37 - STEP 44**

**Repeat steps 42 - 44 on the passenger side.**

45. Slide the Fabtech radius arm mount into the factory pocket with the frame tab facing the front of the truck. **SEE FIGURE 38**



**FIGURE 38 - STEP 45**

46. Locate four 1/2"-13 x 1-1/4" bolts, nuts and washers. Use these bolts to mount the radius arm drop bracket to the factory bracket. Leave loose at this time. **SEE FIGURE 39**

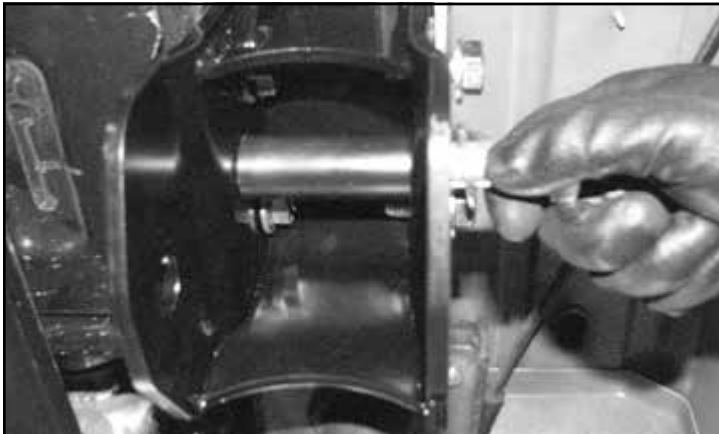


**FIGURE 39 - STEP 46**

47. Locate the M18-2.5 x 120MM bolt, nut and washers. Pass the 18mm bolt through the factory pivot hole into the FT604 sleeve. Torque the 18mm bolt to 200 ft-lbs and the four 1/2" bolts to 127 ft-lbs. **SEE FIGURES 40-42**



**FIGURE 40 - STEP 47**



**FIGURE 41 - STEP 47**



**FIGURE 42 - STEP 47**

48. Using the Fabtech the radius arm drop bracket as a drill guide, drill a 1/2" hole through the bottom of the frame. **SEE FIGURE 43**



**FIGURE 43 - STEP 48**

49. Locate a 1/2"-13 x 1-1/4" bolt and the FT44253 nut tab. Pass the nut tab through the hole in the frame forward of the radius arm drop bracket. Connect the bolt and the nut tab through the radius arm drop bracket and the frame. Torque to 127 ft-lbs. **SEE FIGURES 44-46**



**FIGURE 44 - STEP 49**



**FIGURE 45 - STEP 49**



**FIGURE 46 - STEP 49**

**REPEAT STEPS 45- 49 ON THE PASSENGER SIDE**

50. Reinstall the factory radius arms with the factory hardware and torque to 200 ft-lbs. **SEE FIGURES 47-50**



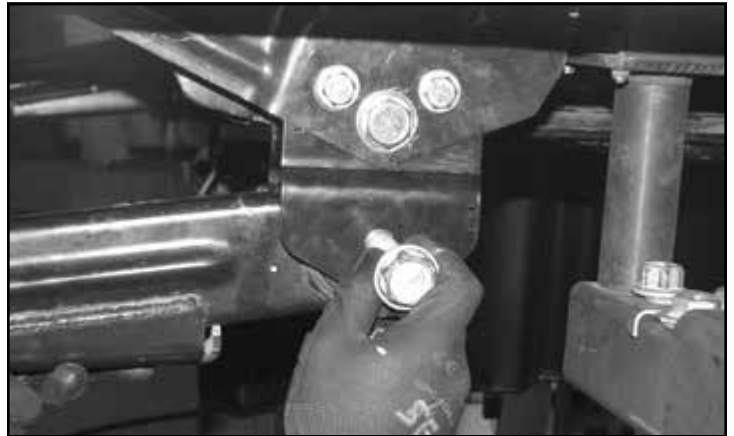
**FIGURE 47 - STEP 50**



**FIGURE 48 - STEP 50**



**FIGURE 49 - STEP 50**



**FIGURE 50 - STEP 50**

**IF INSTALLING FABTECH RADIUS ARMS FOLLOW STEPS 51-56**

51. Remove the driver side factory radius arms and discard. Save the factory hardware. **SEE FIGURES 51-52**



**FIGURE 51 - STEP 51**



**FIGURE 52 - STEP 51**

52. Locate the FT44449 Driver side radius arm, FT1006 bushing, FT102 sleeve, and zerk fitting.

53. Install two bushings, one sleeve, and the zerk fitting into the barrel of the radius arm. **SEE FIGURES 53-55**



**FIGURE 53 - STEP 53**

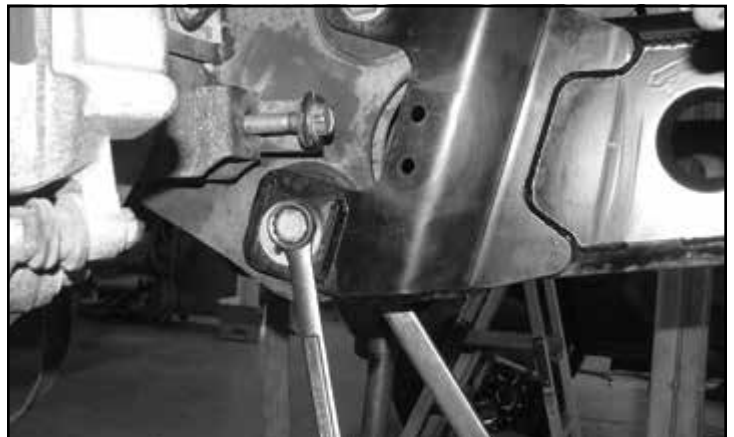


**FIGURE 54 - STEP 53**



**FIGURE 55 - STEP 53**

54. Install the new Fabtech radius arms into the factory frame pocket and onto the axle bushings using the factory hardware. Torque the factory bolts to 200 ft-lbs. **SEE FIGURES 56-58**



**FIGURE 56 - STEP 54**



**FIGURE 57 - STEP 54**



**FIGURE 58 - STEP 54**

55. Locate the factory coil spring isolator and slide it over the Fabtech coil spacer. Install the factory coil spring onto the Fabtech coil spacer and into the lower perch on the axle.

**REPEAT STEPS 51-55 ON PASSENGER SIDE**

56. Locate the FT44245 Brake line extension, FT44258 nut tab and two 1/4"-20 x 1" bolts. Attach the brake line extension to the axle using one bolt and the nut tab. Attach the factory brake line bracket to the Fabtech extension. Torque to 10 ft-lbs. Repeat this step on the passenger side. **SEE FIGURES 59-61**



**FIGURE 59 - STEP 56**



**FIGURE 60 - STEP 56**

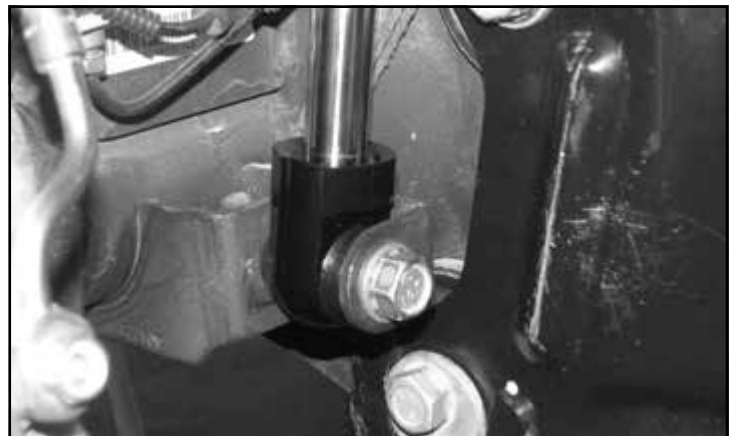


**FIGURE 61 - STEP 56**

57. Locate the FTS7343 Performance shock, FTS6343 (Stealth Shock) or the FTS811032 Dirt Logic shock and install into the factory shock mounts. Torque the upper mount to 14 ft-lbs and the lower 37 ft-lbs. **SEE FIGURES 62-63**



**FIGURE 62 - STEP 57**



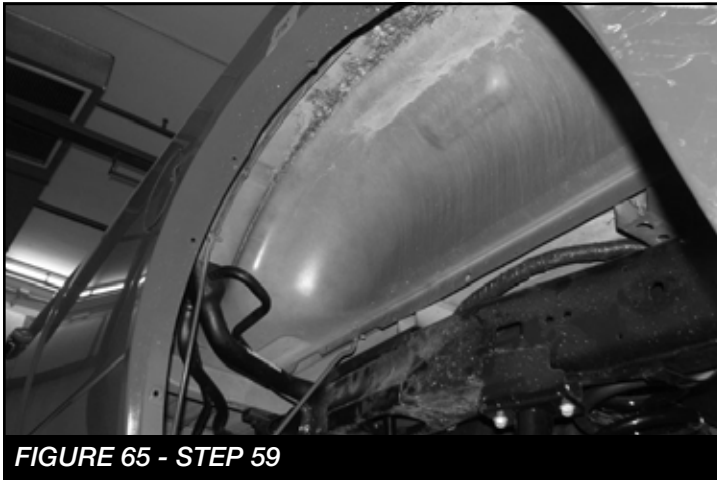
**FIGURE 63 - STEP 57**

58. Reconnect the factory sway bar. Torque to 29 ft-lbs.  
**SEE FIGURE 64**



### REAR SUSPENSION

59. Jack up the rear end of the vehicle and support the frame rails with jack stands and remove wheels and tires. Remove the rear driver and passenger inner fender liners.  
**SEE FIGURE 65**



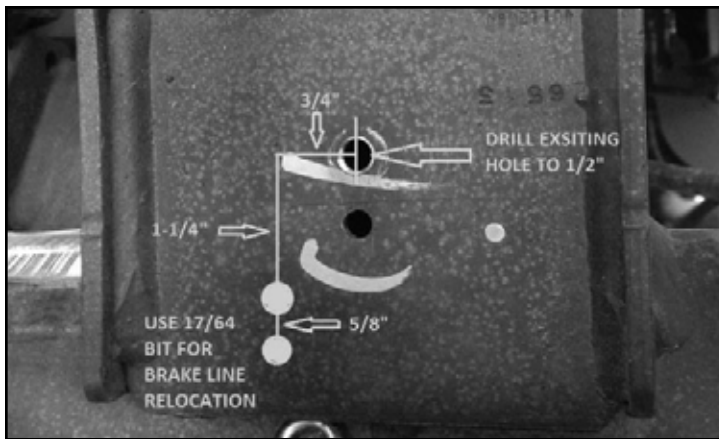
60. Disassemble the rear track bar from the axle side and keep hardware for re-installation. Remove and discard factory sway bar end links and shocks, save lower shock hardware for re-installation. Slowly lower the rear axle and remove and save the rear factory springs and rubber isolators for re-installation. Remove bump stops and hardware from the vehicles frame and keep for re-installation.

61. Locate the hole on the front side of the rear drivers side axle bump stop pad. Drill out this hole to 7/8".  
**SEE FIGURES 66-67**



62. Next, on the rear side of the same bump stop pad. Remove the factory brake line bracket and relocate it  $\frac{3}{4}$ " - left and 1-1/4" down using a 17/64" bit. Drill another 17/64" hole 5/8" below to allow the factory bracket to set in. **NOTE: ONLY DRILL THROUGH BUMP STOP PAD, DRILLING TO FAR WILL RESULT IN DAMAGE TO AXEL TUBE. SEE FIGURES 68-69**





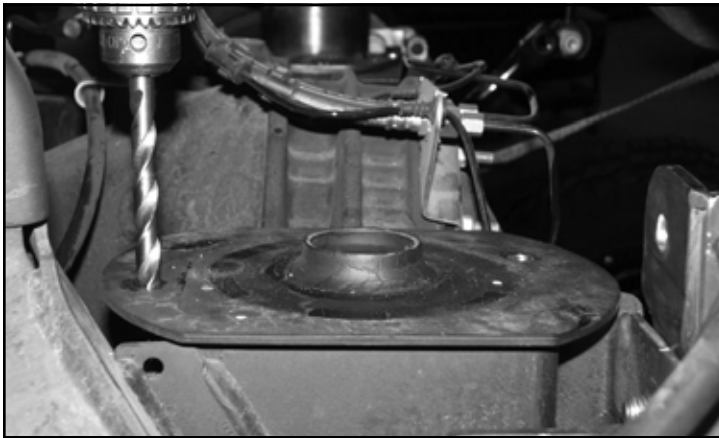
**FIGURE 69 - STEP 62**

63. Next, using a 1/2" bit, drill the old brake line bracket hole to allow for the new track bar support bracket in a future step. **SEE FIGURE 70**



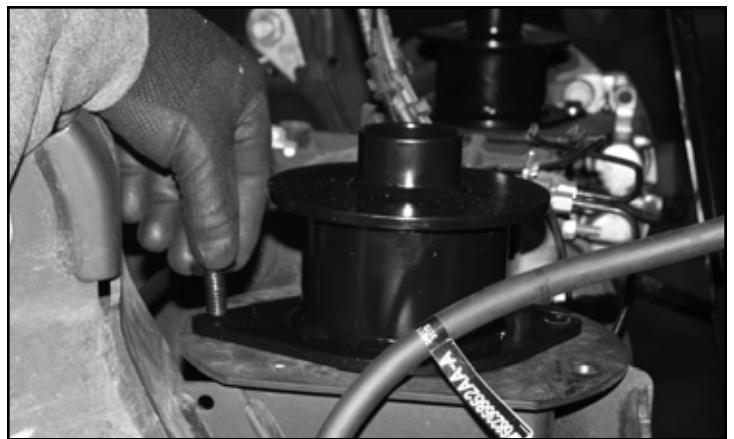
**FIGURE 70 - STEP 63**

64. Drill out the existing holes located on the factory spring perches to 7/16". **SEE FIGURE 71**

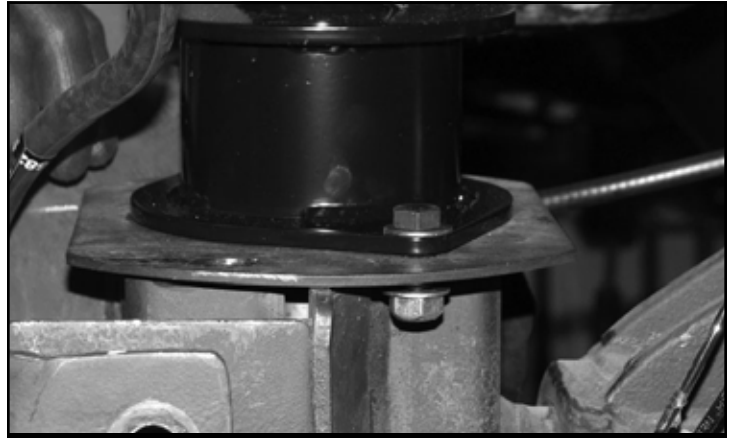


**FIGURE 71 - STEP 64**

65. Locate the FT44267BK rear spring spacers and install them with the supplied 7/16"-14 x 1-1/4" bolt, nuts and washers. Torque to 83 ft-lbs. **SEE FIGURE 72-73**

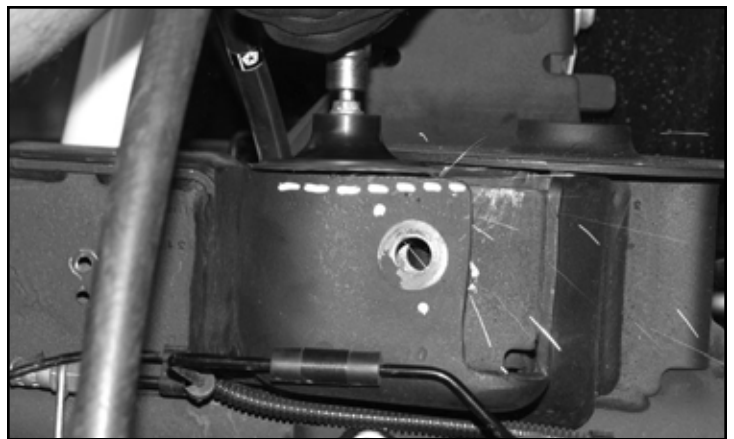


**FIGURE 72 - STEP 65**



**FIGURE 73 - STEP 65**

66. Locate the FT44269BK rear track bar support bracket. TRIMMING MAY BE REQUIRED TO INSTALL THE NEW FT44269BK REAR TRACK BAR SUPPORT BRACKET. **SEE FIGURE 74**

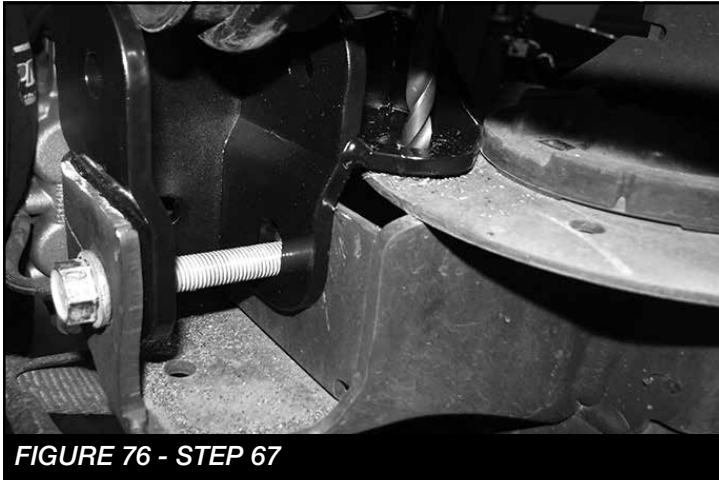


**FIGURE 74 - STEP 66**

- 67. NOTE: If installing on 2017 or newer skip to step 69.**  
Install the FT44269BK using the factory track bar bolt.  
Mark holes for drilling on the factory track bar bracket.  
Remove the bolt and drill out the hole on the factory track bar bracket using a 1/2" drill bit. **SEE FIGURES 75-77**



**FIGURE 75 - STEP 67**

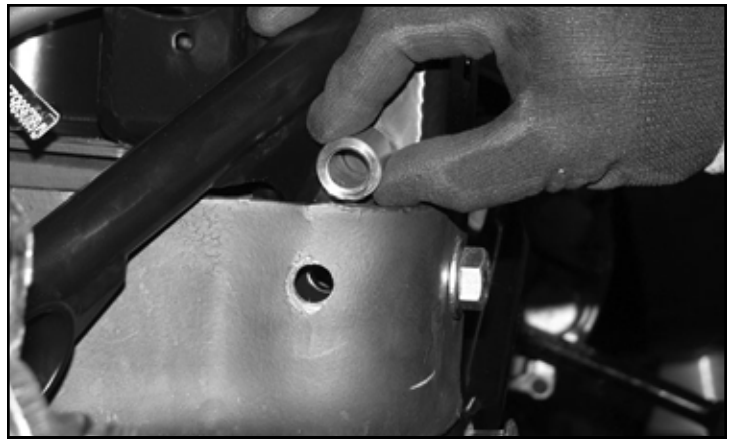


**FIGURE 76 - STEP 67**

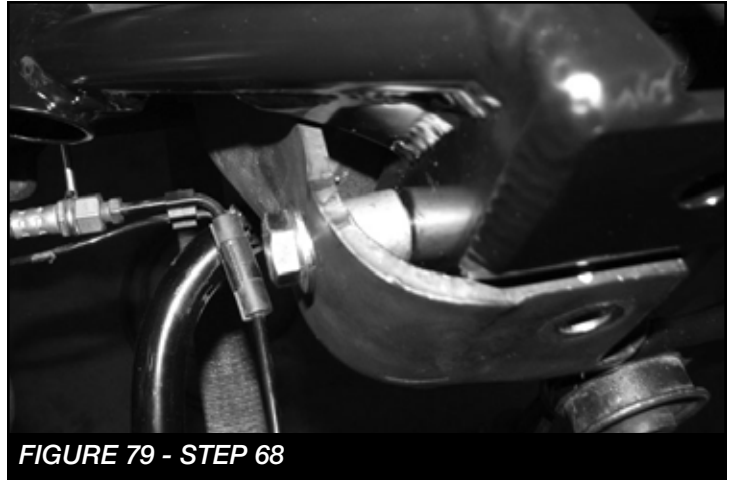


**FIGURE 77 - STEP 67**

- 68. Install the supplied 1/2"-13x 2-1/4" bolt, nut, washers and FT606 sleeve as shown below. DO NOT TIGHTEN. SEE FIGURES 78-79**

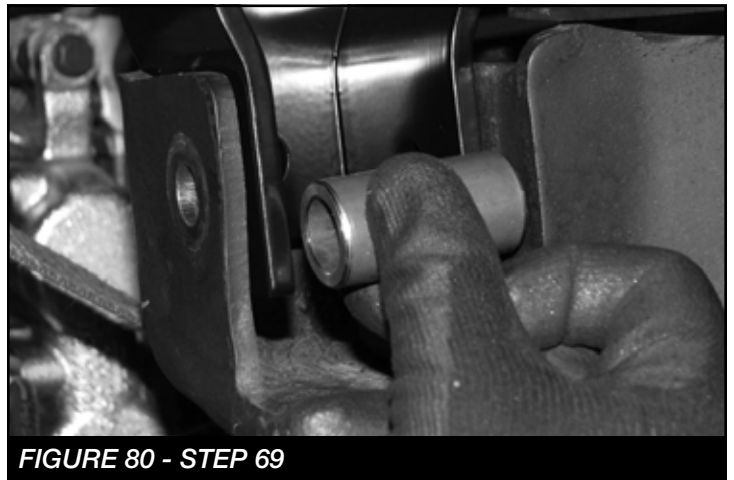


**FIGURE 78 - STEP 68**

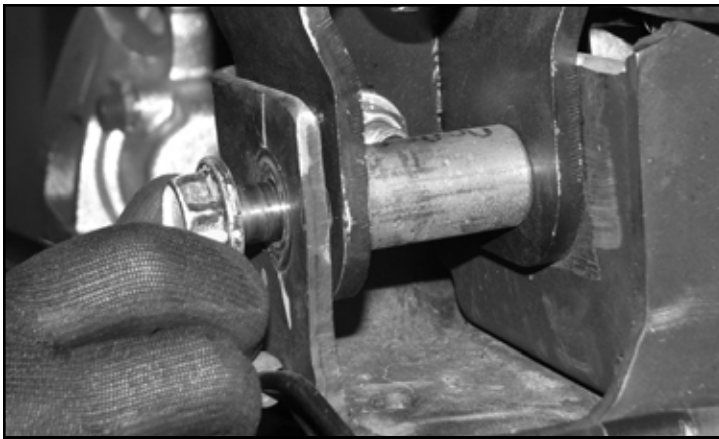


**FIGURE 79 - STEP 68**

- 69. Install the factory track bar pivot bolt and hardware along with FT605 Sleeve. Torque to 160 ft-lbs. Next, torque the 1/2" bolt on the same bracket to 127 ft-lbs. SEE FIGURES 80-81**



**FIGURE 80 - STEP 69**



**FIGURE 81 - STEP 69**

70. Locate FT44270 nut tab, 1/2"-13x 1-1/4" bolt and washer and install into the track bar support bracket through the bump stop pad. Torque to 127 ft-lbs. **SEE FIGURES 82-84**



**FIGURE 82 - STEP 70**

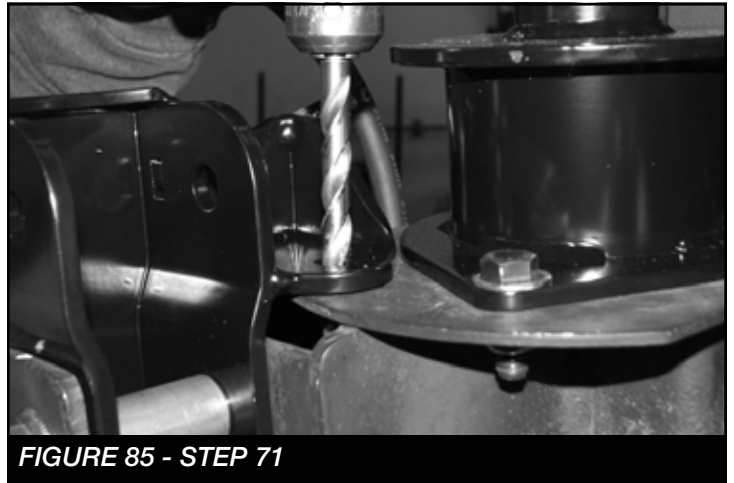


**FIGURE 83 - STEP 70**



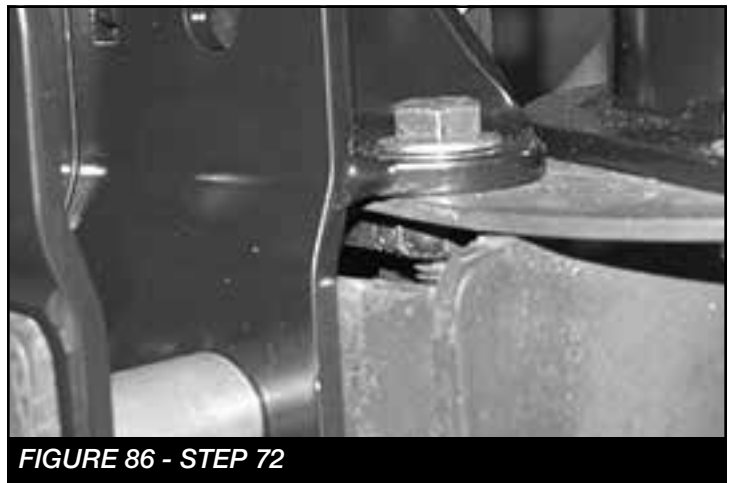
**FIGURE 84 - STEP 70**

71. Using a 7/16" drill bit, drill through the existing hole on the track bar bracket into the top of the spring perch. **SEE FIGURES 85 85**



**FIGURE 85 - STEP 71**

72. Locate and install the supplied 7/16"-14x 1-1/4" bolt, washer and FT50184 Track Bar Support Nut Tab. Torque to 83 ft-lbs. **SEE FIGURES 86-87**



**FIGURE 86 - STEP 72**



FIGURE 87 - STEP 72

73. Locate the supplied 1/4"-20x 1" bolt, nut, washers and FTCLAMP-LB10 rubber cushioned clamp and install on the rear axle breather tube, mounting it to the hole provided on the new track bar bracket. Torque to 14 ft-lbs. **SEE FIGURE 88**

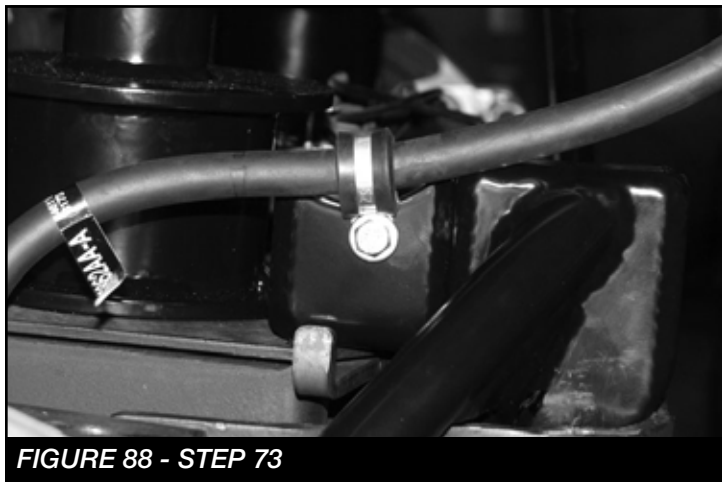


FIGURE 88 - STEP 73

74. Locate the FT44268BK rear bump stop spacer and supplied 7/16"-14x 1-1/4" bolts, nuts, and washers. Install the FT44268BK spacer with the factory bolts that were removed during disassembly. Then, install the factory bump stop onto the spacer bracket with the supplied 7/16" hardware. Torque to 58 ft-lbs. **SEE FIGURE 89**

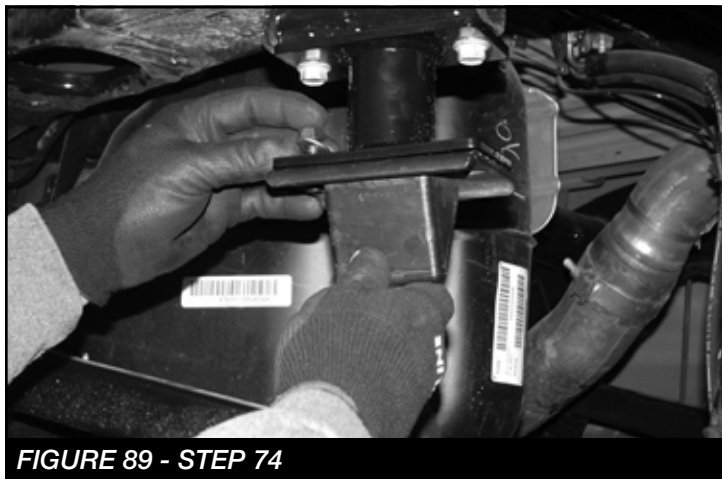


FIGURE 89 - STEP 74

75. Re-install the factory coil springs and rubber isolators as shown. **SEE FIGURE 90**

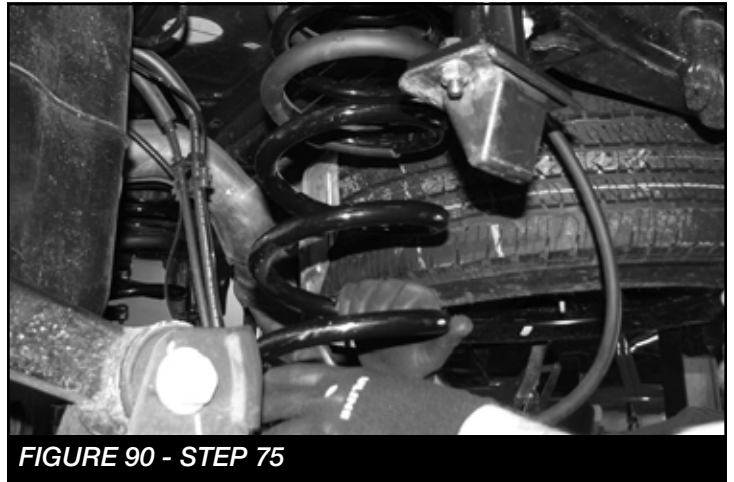


FIGURE 90 - STEP 75

76. Locate the supplied 9/16"-18x 3-1/2" bolt, nut and washers and install the rear track bar into the new location. Torque to 184 ft-lbs. **SEE FIGURE 91**

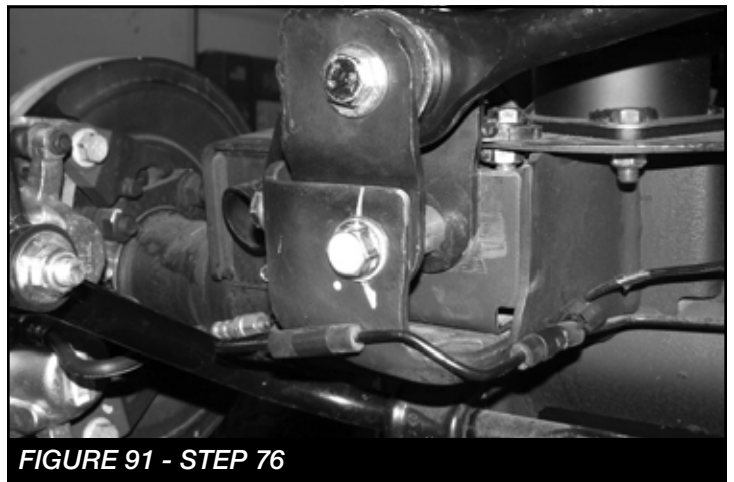
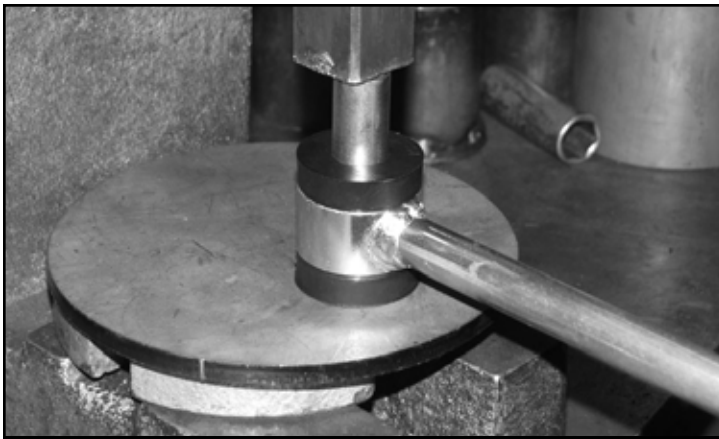


FIGURE 91 - STEP 76

77. Locate the FT1599-2-4 (5" zinc sway bar links) and supplied M12-1.75 x 70mm bolts, Nylok nuts and washers. Install the supplied bushings and sleeves. **SEE FIGURES 92-93**

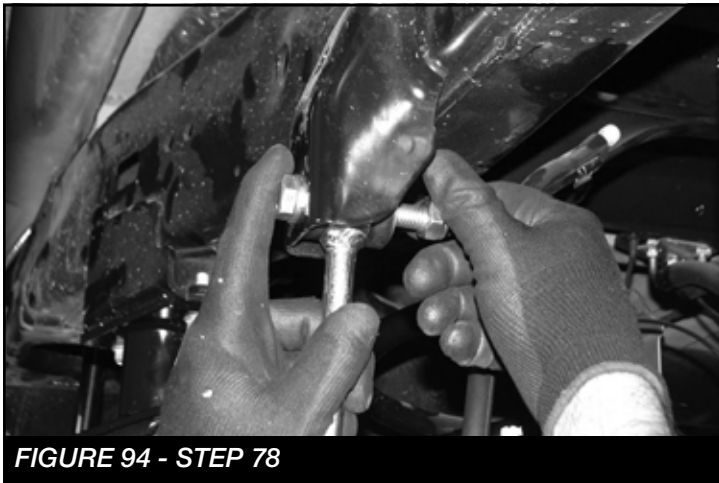


FIGURE 92 - STEP 77

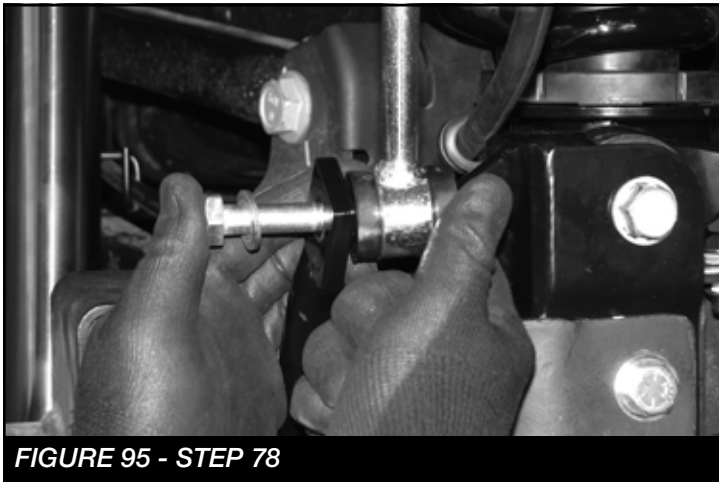


**FIGURE 93 - STEP 77**

78. Install the new end links with the supplied M12-1.75 x 70mm bolts, Nylok nuts and washers and torque to 100 ft-lbs. **SEE FIGURES 94-95**



**FIGURE 94 - STEP 78**



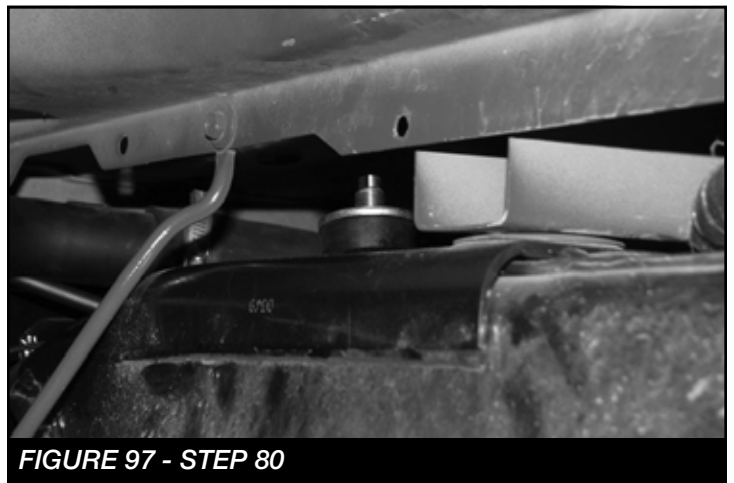
**FIGURE 95 - STEP 78**

79. Locate the rear shocks that were supplied with the kit: Part numbers vary between kits. (FTS7344- Performance Shock), (FTS6344- Stealth Shock) or (FTS811042- Dirt Logic 2.25 Shock)

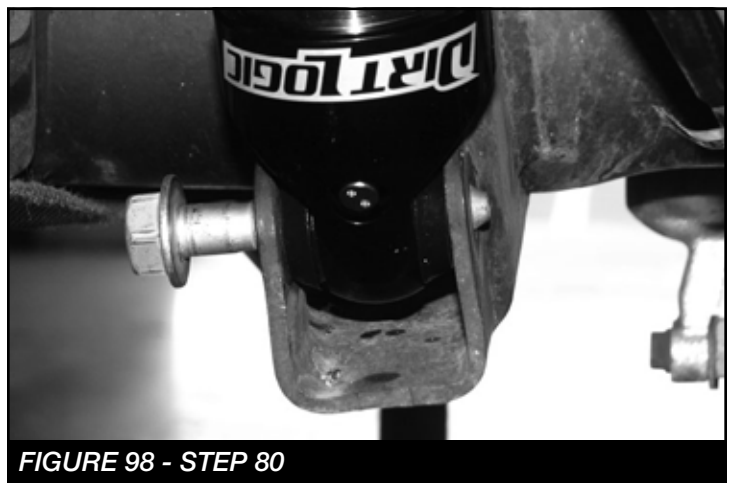
80. Press the supplied sleeve into the lower bushing and install the rear shocks with the supplied washers and bushings. Next, torque the upper nut to 14 ft-lbs and the lower to 37 ft-lbs. **SEE FIGURES 96-98**



**FIGURE 96 - STEP 80**



**FIGURE 97 - STEP 80**



**FIGURE 98 - STEP 80**

81. Re-Install rear inner fender liners.
82. Install tires and wheels and torque lug nuts to wheel manufacturer's specifications. Turn front tires left to right and check for appropriate tire clearance. **Note - Some oversized tires may require trimming of the front bumper & valance.**
83. Check front end alignment and set to factory specifications. Readjust headlights.
84. Recheck all bolts for proper torque.
85. Recheck brake hoses, ABS wires and suspension parts for proper tire clearance while turning tires fully left to right.
86. Check the fluid in the front and rear differential and fill if needed with factory specification differential oil. **Note - some differentials may expel fluid after filling and driving. This can be normal in resetting the fluid level with the new position of the differential/s.**
87. Install Driver Warning Decal. Complete product registration card and mail to Fabtech in order to receive future safety and technical bulletins on this suspension.

**Vehicles that will receive oversized tires should check ball joints, uniballs and all steering components every 2500-5000 miles for wear and replace as required.**

**RETORQUE ALL NUTS, BOLTS AND LUGS  
AFTER 50 MILES AND PERIODICALLY  
THEREAFTER.**

## - Product Warranty and Warnings -

Fabtech provides a Limited Lifetime Warranty to the original retail purchaser who owns the vehicle, on which the product was originally installed, for defects in workmanship and materials.

The Limited Lifetime Warranty excludes the following Fabtech items; bushings, bump stops, ball joints, tie rod ends, limiting straps, cross shafts, heim joints and driveshafts. These parts are subject to wear and are not considered defective when worn. They are warranted from the date of purchase for defects in workmanship.

Dirt Logic and Performance Coilover take apart shocks are considered a serviceable shock with a one year warranty on leakage only. Service seal kits are available separately for future maintenance. All other shocks are covered under our Limited Lifetime Warranty.

Fabtech does not warrant any product for finish, alterations, modifications and/or installation contrary to Fabtech's instructions. Alterations to the finish of the parts including but not limited to painting, powder coating, plating and/or welding will void all warranties. Some finish damage may occur to parts during shipping, which is considered normal and is not covered under warranty.

Fabtech products are not designed nor intended to be installed on vehicles used in race applications or for racing purposes or for similar activities. (A "RACE" is defined as any contest between two or more vehicles, or any contest of one or more vehicle against the clock, whether or not such contest is for a prize). This warranty does not include coverage for police or taxi vehicles, race vehicles, or vehicles used for government or commercial purposes. Also excluded from this warranty are sales outside of the United States of America.

Installation of most suspension products will raise the center of gravity of the vehicle and will cause the vehicle to handle differently than stock. It may increase the vehicle's susceptibility to a rollover, on road and off road, at all speeds. Extreme care should be taken to operate the vehicle safely at all times to prevent rollover or loss of control resulting in serious injury or death. Fabtech front end Desert Guards may impair the deployment or operation of vehicles equipped with supplemental restraining systems/air bag systems and should not be installed if the vehicle is equipped as so.

Fabtech makes every effort to ensure suspension product compatibility with all vehicles listed on the website, but due to unknown auto manufacturer's production changes and/or inconsistencies by the auto manufacturer, Fabtech cannot be responsible for 100% compatibility, including the fitment of tire and wheel sizes listed. The Tire and Wheel sizes listed in Fabtech's website are only a guideline for street driving with noted fender trimming. Fabtech is not responsible for damages to the vehicle's body or tires. Fabtech is not responsible for premature wear of factory components due to the installation of oversized tires and wheels.

Fabtech's obligation under this warranty is limited to the repair or replacement, at Fabtech option, of the defective product only. All costs of removal, installation or re-installation, freight charges, incidental or consequential damages are expressly excluded from this warranty. Fabtech is not responsible for damages and/or warranty of other vehicle parts related or non related to the installed Fabtech product. This warranty is expressly in lieu of all other warranties expressed or implied. This warranty shall not apply to any product that has been subject to accident, negligence, alteration, abuse or misuse as determined by Fabtech.

Fabtech suspension components must be installed as a complete system including shocks as shown on our website. All warranties will become void if Fabtech parts are combined and/or substituted with other aftermarket suspension products. Combination and/or substitution of other aftermarket suspension parts may cause premature wear and/or product failure resulting in an accident causing injury or death. Fabtech does not warrant products not manufactured by Fabtech.

Depending on the condition of the factory suspension components retained after the installation of a Fabtech suspension not all vehicles may have the same ride stance front to rear as described in the website. The blue color of suspension components shown in all Fabtech photographs are for display purposes only. Majority of all Fabtech components will be black specifically where noted with part numbers ending in BK.

Installation of Fabtech product may void the vehicles factory warranty; it is the consumer's responsibility to check with their local vehicle's dealer for warranty disposition before the installation of the product. Some state laws may prohibit modification of suspension to a vehicle in whole or in part. It is the responsibility of the installer and consumer to consult local laws prior to the installation of any Fabtech suspension product to comply with such written laws.

It is the responsibility of the distributor and/or the retailer to review all warranties and warnings of Fabtech products with the consumer prior to purchase.

Fabtech reserves the right to super cede, discontinue, change the design, finish, part number and/or application of parts when deemed necessary without written notice. Fabtech is not responsible for misprints or typographical errors within the website or price sheet.

# FT44232 - TEMPLATE

PRINT AT 100% - DO NOT SCALE TO PAGE

