



INSTALLATION INSTRUCTIONS



2013-2016 DODGE 3500 4WD 5" KIT W/ COILS

FTS23092/FTS23093/FTS23094 - BASIC KITS

FTS23095/FTS23096/FTS23097 - RADIUS ARM KITS

FT23092i

- PARTS LIST - BASIC KIT W/ COILS

FTS23091		5" BASIC KIT W/ COILS
1	FT44172	DODGE PITMAN ARM
2	FT44232BK	RADIUS ARM DROP
1	FT44236BK	TRACK BAR BRACKET
1	FT44298BK	LOWER SPRING PERCH (DRIVER)
1	FT44299BK	LOWER SPRING PERCH (PASSENGER)
2	FT44316BK	FRONT COIL SPRING
2	FT44356BK	COIL RETAINER

FTS23092		COMPONENT BOX 2 W/PERFORMANCE SHOCKS
1	FT44243BK	BUMP STOP MOUNT (DRIVER)
1	FT44244BK	BUMP STOP MOUNT (PASSENGER)
2	FT44242BK	REAR BUMP STOP SPACER
4	FT738U	UBOLT RD 9/16-18X12.50X4.00
2	FTBK21	BLOCK 2.0" W/ 3/4" PIN
1	FT44329	HARDWARE SUBASSEMBLY
1	FT44328	HARDWARE KIT
2	FTS7343	PERFORMANCE SHOCK FRONT
2	FTS7335	PERFORMANCE SHOCK REAR

FTS23093		COMPONENT BOX 2 W/STEALTH SHOCKS
1	FT44243BK	BUMP STOP MOUNT (DRIVER)
1	FT44244BK	BUMP STOP MOUNT (PASSENGER)
2	FT44242BK	REAR BUMP STOP SPACER
4	FT738U	UBOLT RD 9/16-18X12.50X4.00
2	FTBK21	BLOCK 2.0" W/ 3/4" PIN
1	FT44329	HARDWARE SUBASSEMBLY
1	FT44328	HARDWARE KIT
2	FTS6343	STEALTH MONOTUBE FRONT
2	FTS6335	STEALTH MONOTUBE REAR

FTS23094		COMPONENT BOX 2 W/DIRT LOGIC SHOCKS
1	FT44243BK	BUMP STOP MOUNT (DRIVER)
1	FT44244BK	BUMP STOP MOUNT (PASSENGER)
2	FT44242BK	REAR BUMP STOP SPACER
4	FT738U	UBOLT RD 9/16-18X12.50X4.00
2	FTBK21	BLOCK 2.0" W 3/4" PIN
1	FT44347	HARDWARE SUBASSEMBLY
1	FT44328	HARDWARE KIT
2	FT801032	DIRT LOGIC 2.25 RESI
2	FT810362	DIRT LOGIC 2.25 NON RESI

FT44328 - HARDWARE KIT		LOCATION
BAG 1		
1	M18-2.5 X 90MM HEX BOLT	TRACK BAR DROP BRACKET
2	M18 WASHERS	
1	NUT C-LOCK 18MM G10.9 ZINC	
2	1/2-13 X 1-1/2 HEX BOLT G8	TRACK BAR DROP BRACKET
2	1/2-13 X 4" HEX BOLT G8	
8	1/2 SAE WASHER G8	
4	1/2-13 C-LOCK NUT	
BAG 2		
2	M18-2.5 X 120MM HEX BOLT	RADIUS ARM POCKET
4	M18 WASHERS	
2	NUT C-LOCK 18MM G10.9 ZINC	
12	1/2-13 X 1-1/4 HEX BOLT G8 ZNC	RADIUS ARM POCKET/BUMP STOP
24	1/2 SAE WASHER G8 ZINC	
12	1/2-13 C-LOCK NUT ZINC	
BAG 3		
2	5/16-18 X 2-1/2 HEX BOLT G8 ZINC	BUMP STOP
4	5/16 SAE WASHER G8 ZINC	
2	5/16-18 C-LOCK NUT ZINC	
4	1/4-20 X 1 HEX BOLT G5	BRAKE LINE BRACKET
2	1/4 SAE WASHERG5	
2	1/4-20 C-LOCK NUT	
4	5/16-18 X 1-1/2 HEX BOLT	COIL SPACER
6	5/16 SAE FLAT WASHER	
2	5/16-18 C-LOCK NUT ZINC	
BAG 4		
4	7/16-14 X 1-1/4" HEX BOLT G8	REAR BUMP STOP
8	7/16 SAE WASHER G8	
4	7/16-14 C-LOCK NUT	
8	9/16-18 NYLOCK NUT	UBOLTS
8	9/16 SAE FLAT WASHER	
2	THREAD LOCKING COMPOUND	

**- PARTS LIST -
BASIC KIT CONTINUED**

FT44329		HARDWARE SUBASSEMBLY
2	FT604	SLEEVE 1.000 X .760 X 2.600
2	FT44135	BUMP STOP MOUNT TAB
2	FT44245	BRAKE LINE EXT
2	FT44253	RADIUS ARM DROP NUT TAB
2	FT44258	1/4 NUT TAB
2	FTS88	BUMPSTOP 1 IN TALL LOW RND
1	FTAS16	DRIVER WARNING DECAL
1	FTAS12	STICKER FT BLUE 10X4
1	FTREGCARD	REGISTRATION CARD
1	FT23092i	INSTRUCTIONS
1	FT44359	COIL RETAINER WASHER
1	FT44239	WASHER 4.250 X .510 X .250
2	FT44317	COIL SPRING SPACER NUT TAB

FT44347		HARDWARE SUBASSEMBLY
2	FT604	SLEEVE 1.000 X .760 X 2.600
2	FT44135	BUMP STOP MOUNT TAB
2	FT44245	BRAKE LINE EXT
2	FT44253	RADIUS ARM DROP NUT TAB
2	FT44258	1/4 NUT TAB
2	FTS88	BUMPSTOP 1 IN TALL LOW RND
1	FTAS16	DRIVER WARNING DECAL
1	FTAS12	STICKER FT BLUE 10X4
1	FTREGCARD	REGISTRATION CARD
1	FT23092i	INSTRUCTIONS
2	FTSP01029	HARDWARE PACK STEM BUSHING
2	FT86021	HARDWARE & BUSHING KIT 21
4	FT83076	1.5/1.75-2.25/2.5 RESI CLAMP
4	FT89016	#64 HOSE CLAMP
2	FT86008	HARDWARE & BUSHING KIT 8
1	FT44246	TRACK BAR SUPPORT SPACER
1	FT44359	COIL RETAINER WASHER
1	FT44239	WASHER 4.250 X .510 X .250
2	FT44317	COIL SPRING SPACER NUT TAB

- PARTS LIST - 5" RADIUS ARM KIT W/ COILS

FTS23090		5" RADIUS ARM KIT W/ COILS
1	FT44172	DODGE PITMAN ARM
1	FT44449	RADIUS ARM (DRIVER)
1	FT444450	RADIUS ARM (PASSENGER)
1	FT44236BK	TRACK BAR BRACKET
1	FT44298BK	LOWER SPRING PERCH (DRIVER)
1	FT44299BK	LOWER SPRING PERCH (PASSENGER)
2	FT44316BK	FRONT COIL SPRING
2	FT90071	LOGO PLATE SMALL
2	FT44356BK	COIL RETAINER

FTS23095		COMPONENT BOX 2 W/PERFORMANCE SHOCKS
1	FT44243BK	BUMP STOP MOUNT (DRIVER)
1	FT44244BK	BUMP STOP MOUNT (PASSENGER)
2	FT44242BK	REAR BUMP STOP SPACER
4	FT738U	UBOLT RD 9/16-18X12.50X4.00
2	FTBK21	BLOCK 2.0" W/ 3/4" PIN
1	FT44330	HARDWARE KIT
1	FT44331	HARDWARE SUBASSEMBLY
2	FTS7343	PERFORMANCE SHOCK FRONT
2	FTS7335	PERFORMANCE SHOCK REAR

FTS23096		COMPONENT BOX 2 W/STEALTH SHOCKS
1	FT44243BK	BUMP STOP MOUNT (DRIVER)
1	FT44244BK	BUMP STOP MOUNT (PASSENGER)
2	FT44242BK	REAR BUMP STOP SPACER
1	FT44330	HARDWARE KIT
1	FT44331	HARDWARE SUBASSEMBLY
4	FT738U	UBOLT RD 9/16-18X12.50X4.00
2	FTBK21	BLOCK 2.0" W/ 3/4" PIN
2	FTS6343	STEALTH MONOTUBE FRONT
2	FTS6335	STEALTH MONOTUBE REAR

FTS23097		COMPONENT BOX 2 W/DIRT LOGIC SS SHOCKS
1	FT44243BK	BUMP STOP MOUNT (DRIVER)
1	FT44244BK	BUMP STOP MOUNT (PASSENGER)
2	FT44242BK	REAR BUMP STOP SPACER
1	FT44330	HARDWARE KIT
1	FT44348	HARDWARE SUBASSEMBLY
4	FT738U	UBOLT RD 9/16-18X12.50X4.00
2	FTBK21	BLOCK 2.0" W/ 3/4" PIN
2	FT801032	DIRT LOGIC 2.25 RESI SS
2	FT810362	DIRT LOGIC 2.25 NON RESI SS

FT44330 - HARDWARE KIT		LOCATION
BAG 1		
1	M18-2.5 X 90MM HEX BOLT	TRACK BAR DROP BRACKET
2	M18 WASHERS	
1	NUT C-LOCK 18MM G10.9 ZINC	
2	1/2-13 X 1-1/2 HEX BOLT G8 ZNC	
2	1/2-13 X 4 HEX BOLT G8 ZINC	
8	1/2 SAE WASHER G8	
4	1/2-13 C-LOCK NUT	
BAG 2		
4	1/4-20 X 1 HEX BOLT G5 ZINC	BRAKE LINE EXTENSION
2	1/4 SAE WASHER G5 ZINC	
2	1/4-20 C-LOCK NUT ZINC	
2	5/16-18 X 2-1/2 HEX BOLT G8 ZINC	BUMP STOP
4	5/16 SAE WASHER G8 ZINC	
2	5/16-18 C-LOCK NUT ZINC	
4	5/16-18 X 1-1/2 HEX BOLT	COIL SPACER
6	5/16 SAE WASHER	
2	5/16-18 C-LOCK NUTS	
4	1/2-13 X 1-1/4 HEX BOLT G8 ZNC	BUMP STOP
8	1/2 SAE WASHER G8 ZINC	
4	1/2-13 C-LOCK NUT ZINC	
BAG 3		
4	7/16-14 X 1-1/4 HEX BOLT G8 ZC	REAR BUMP STOP
8	7/16 SAE WASHER G8 ZINC	
4	7/16-14 C-LOCK NUT ZINC	
8	9/16" SAE FLAT WASHER	UBOLTS
8	9/16-18 NYLOCK NUT	
2	THREAD LOCKING COMPOUND 2 MIL	

**- PARTS LIST -
RADIUS ARM KIT CONTINUED**

FT44331		HARDWARE SUBASSEMBLY
2	FT102	SLEEVE 1.000 X .732 X 3.280
2	FT44135	BUMP STOP MOUNT TAB
2	FT44245	BRAKE LINE EXT
4	FT404739	SLEEVE OD 0.62 ID 12MM L.1.48
2	FT44258	1/4 NUT TAB
2	FTS88	BUMPSTOP 1 IN TALL LOW RND
1	FTAS16	DRIVER WARNING DECAL
1	FTAS12	STICKER FT BLUE 10X4
1	FTREGCARD	REGISTRATION CARD
1	FT23092i	INSTRUCTIONS
1	FT44359	COIL RETAINER WASHER
1	FT44239	WASHER 4.250 X .510 X .250
2	FT44317	COIL SPRING SPACER NUT TAB
4	FT1006	BUSHING C1500 L.T. LOWER
1	FT44246	TRAC BAR SUPPORT SPACER
1	FT50184	TRAC BAR SUPPORT NUT TAB
1	FT605	SLEEVE 1.000 X .563 X .780
1	FT606	SLEEVE .750 X .515 X .780

FT44348		HARDWARE SUBASSEMBLY
2	FT102	SLEEVE 1.000 X .732 X 3.280
2	FT44135	BUMP STOP MOUNT TAB
2	FT44245	BRAKE LINE EXT
1	FT44246	TRACK BAR SUPPORT SPACER
2	FT44258	1/4 NUT TAB
2	FTS88	BUMPSTOP 1 IN TALL LOW RND
1	FTAS16	DRIVER WARNING DECAL
1	FTAS12	STICKER FT BLUE 10X4
1	FTREGCARD	REGISTRATION CARD
1	FT23092i	INSTRUCTIONS
2	FTSP01029	HARDWARE PACK STEM BUSHING
2	FT86021	HARDWARE & BUSHING KIT 21
4	FT83076	1.5/1.75-2.25/2.5 RESI CLAMP
4	FT89016	#64 HOSE CLAMP
2	FT86008	HARDWARE & BUSHING KIT 8
1	FT44359	COIL RETAINER WASHER
1	FT44239	WASHER 4.250 X .510 X .250
2	FT44317	COIL SPRING SPACER NUT TAB
4	FT1006	BUSHING C1500 L.T. LOWER



- TOOL LIST -

Required Tools (Not Included)

Basic Hand Tools
Floor Jack
Jack Stands
Assorted Metric and S.A.E sockets, and Allen wrenches
Torque Wrench
Die Grinder w/ Cutoff Wheel or Sawzall

- PRE-INSTALLATION NOTES -

Read this before you begin installation-

Check all parts to the parts list above before beginning installation.

Read all instructions thoroughly from start to finish before beginning the installation. If these instructions are not properly followed severe frame, driveline and / or suspension damage may occur.

Check your local city and state laws prior to the installation of this system for legality. Do not install if not legal in your area.

Prior to the installation of this suspension system perform a front end alignment and record. Do not install this system if the vehicle alignment is not within factory specifications. Check for frame and suspension damage prior to installation.

The installation of this suspension system should be performed by two professional mechanics.

This suspension must be installed with Fabtech shock absorbers.

Use the provided thread locking compound on all hardware.

WARNING- Installation of this system will alter the center of gravity of the vehicle and may increase roll over as compared to stock.

Vehicles that receive oversized tires should check ball joints, uniballs, tie rods ends, pitman arm and idler arm every 2500-5000 miles for wear and replace as needed.

Verify differential fluid is at manufactures recommended level prior to kit installation. Installation of the kit will reposition the differential and the fill plug hole may be in a different position. (For example, if the manufacture recommends 3 quarts of fluid, make sure the diff has 3 quarts of fluid). Check your specific manual for correct amount of fluid.

RECOMMENDED TIRE/WHEEL SIZES -

Use 37x12.50/R17 tire w/ 17x9 wheels w/ 5" BS w/ minor trimming

Use 37x12.50/R18 tire w/ 18x9 wheels w/ 5" BS w/ minor trimming

Use 37x13.50/R20 tire w/ 20x9.5 wheels w/ 5" BS w/ minor trimming

Use 37x13.50/R22 tire w/ 22x11 wheels w/ 5" BS w/ minor trimming

- INSTRUCTIONS -

FRONT SUSPENSION

1. Disconnect the negative terminal on the battery. Jack up the front end of the truck and support the frame rails with jack stands. **NEVER WORK UNDER AN UNSUPPORTED VEHICLE!** Remove the front tires.
2. **DRIVER SIDE ONLY** - Starting on the driver side, remove the driver side fender liner.
3. Remove the factory shock and discard. Retain factory lower hardware.
4. Disconnect factory sway bar links.
5. Remove factory coil spring and rubber isolator. Retain these parts for later use.
6. Remove the factory pitman arm and discard. Keep hardware.
7. Locate the new FT44172 Fabtech pitman arm and install. Do not reconnect the factory drag link at this time. Reinstall the factory lock washer plus thread locker. Torque to 220ft-lbs.
8. Unthread the factory drag link at the adjuster sleeve and remove adjuster sleeve. **SEE FIGURE 1**

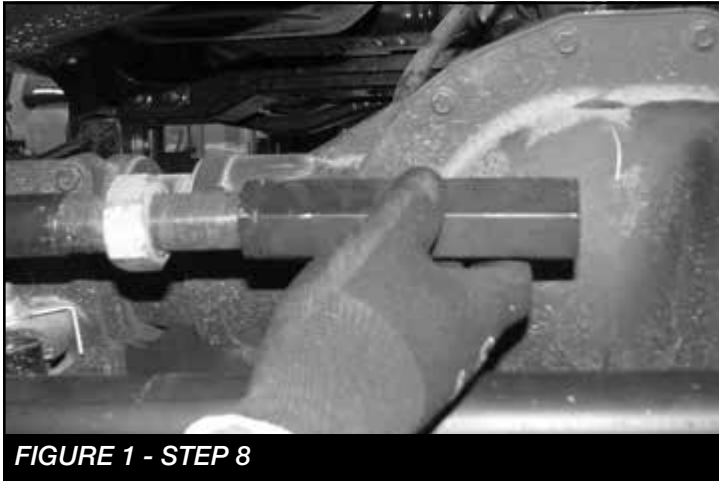

FIGURE 1 - STEP 8

9. Using a die grinder remove the flat nonthreaded section from both ends of the drag link. This will allow you to rotate the drag link and line it up with the pitman arm. **SEE FIGURES 2-4**



FIGURE 2 - STEP 9



FIGURE 3 - STEP 9

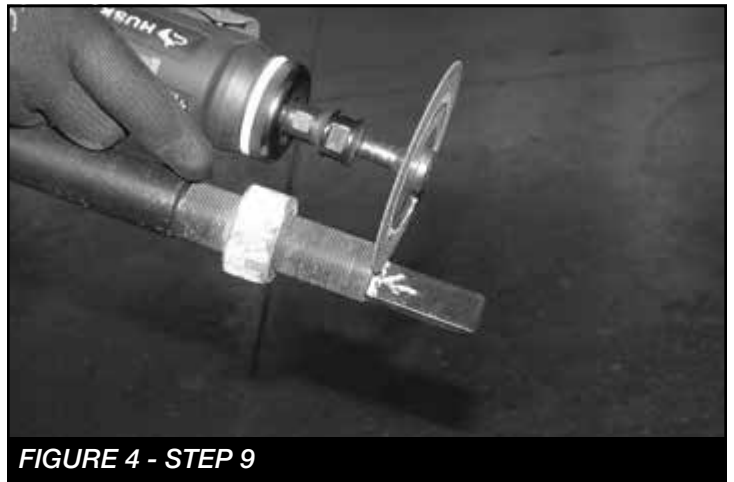

FIGURE 4 - STEP 9

10. Reassemble the drag link and connect it to the new pitman arm. **SEE FIGURE 5**

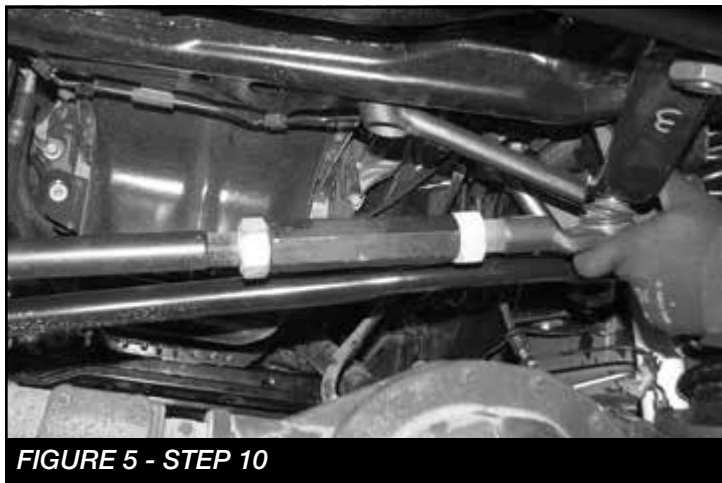

FIGURE 5 - STEP 10

11. Torque the drag link to 83 ft-lbs.
12. Remove the track bar from the frame side of the vehicle.
13. Locate the FT44236BK track bar bracket and M18-2.5 x 90mm bolt.
14. Slide the track bar bracket into the factory mount and insert the M18 bolt into the factory pivot hole. **SEE FIGURE 6**

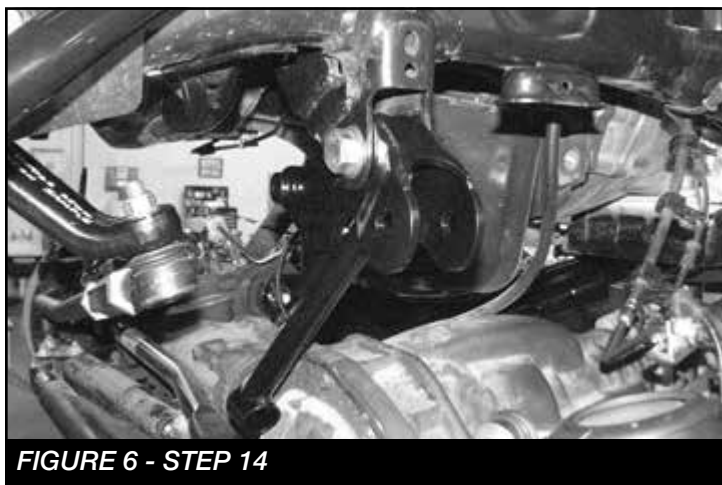

FIGURE 6 - STEP 14

15. Rotate the bracket up until the end of the bracket is flush with the crossmember under the motor.
16. Using the Fabtech bracket as a guide, mark the factory mount for the upper driver side mounting hole.

17. Swing the bracket back out of the way. Using a 1/2" drill bit, drill out the marked hole. **SEE FIGURE 7**



FIGURE 7 - STEP 17

18. Locate one FT44246 sleeve and two 1/2"-13 x 1-1/2" bolts, nuts and washers.
19. Rotate the track bar bracket back into place and bolt together using 1/2"-13 x 1-1/2" bolt and the sleeve. **SEE FIGURES 8-9**

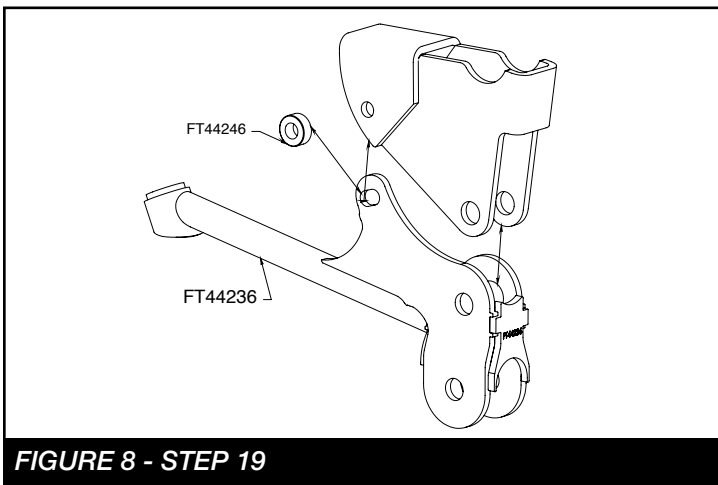

FIGURE 8 - STEP 19



FIGURE 9 - STEP 19

20. Using the Fabtech bracket as a guide, drill a 1/2" hole in the cross member under the motor. Next, mount using 1/2"-13x1.5" and washer. **SEE FIGURE 10**

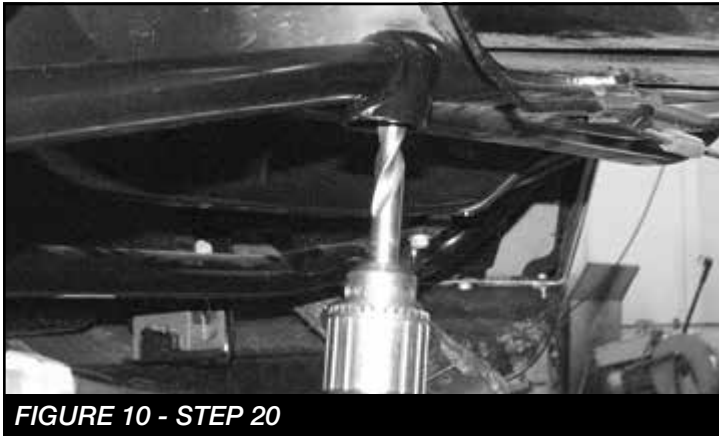

FIGURE 10 - STEP 20

21. Remove the factory coil springs and lower rubber isolators. **SEE FIGURE 11**



FIGURE 11 - STEP 21

22. **(DRIVER SIDE)** Locate FT44356BK (Coil Retainer), FT44359 (Washer), 1/2"-13 X 4" Bolt, nut and washer. **(Driver side)** Remove the bolts attaching the ABS module to the spring perch and install the 1/2" bolt and FT44359. Install the FT44356BK (Retainer) and 1/2" washer and nut. Torque to 100 ft-lbs. **SEE FIGURE 12 (PASSENGER SIDE)** Repeat the same process using FT44239 (Washer). **SEE FIGURE 13**

NOTE: IF INSTALLING DUAL SHOCKS DO SO NOW WITH THE INSTRUCTIONS PROVIDED



FIGURE 12 - STEP 22



23. Locate FT44298BK (lower spring perch spacer), FT44317 (lower spring perch nut tab) and 5/16" hardware. Install the new spring spacer by lining up the existing rear hole. Use the 5/16" hardware and FT44317 nut tab. **SEE FIGURE 13**



FIGURE 13 - STEP 23

24. Using the existing spacer hole as a guide, drill through the factory spring perch using a 1 1/32" drill bit and install the 5/16" hardware to 29 ft-lbs. **SEE FIGURES 14-15**



FIGURE 14 - STEP 24

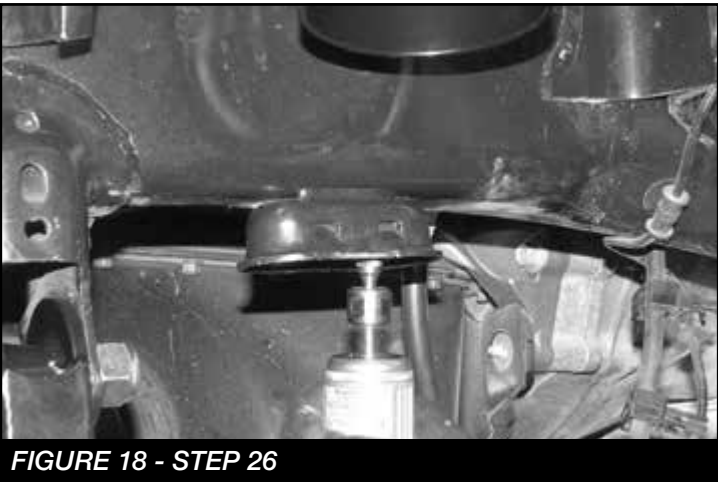

FIGURE 15 - STEP 24

25. Locate and remove the factory rubber bump stop.
SEE FIGURE 16



26. Using a die grinder, grind out the stamped in tabs on the inside of the bump stop housing. **SEE FIGURES 17-18**



27. Locate the FT44243BK driver front bump stop and the FT44135 nut tab.

28. Using a 1/2" drill bit, drill out the hole in the factory crossmember inline with the factory bump stop mount.
SEE FIGURE 19

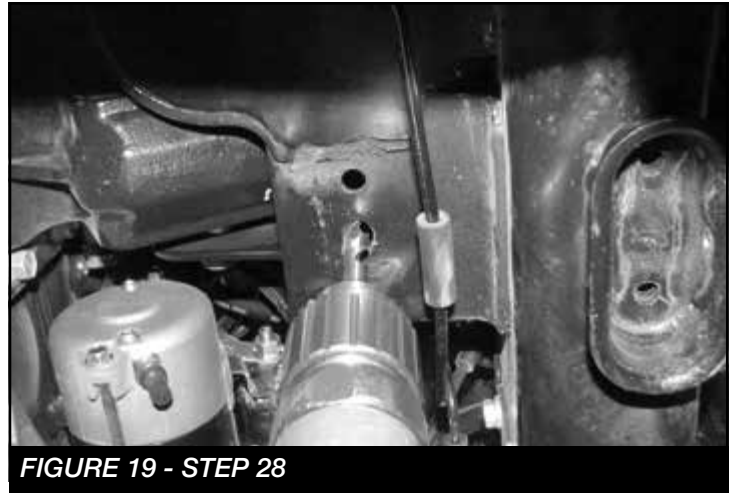

29. Slide the bump stop into the factory bump stop mount. Using a 1/2"-13 x 1-1/4" bolt and the FT44135 (nut tab), bolt the bump stop to the crossmember. Torque the 1/2" bolt to 90 ft-lbs. **SEE FIGURES 20-22**

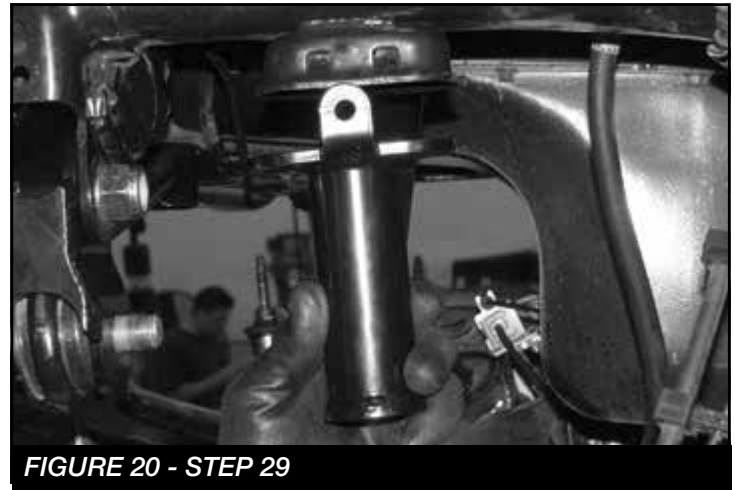



FIGURE 21 - STEP 29



FIGURE 22 - STEP 29

30. Using the outer tab on the bump stop as a drill guide, drill a 5/16" hole all the way through the factory bump stop mount. **SEE FIGURE 23**



FIGURE 23 - STEP 30

31. Locate a 5/16"-18 x 2-1/2" bolt, nut and washers. Using this bolt, secure the bump stop to the factory bump stop mount and torque to 29 ft-lbs. **SEE FIGURE 24**

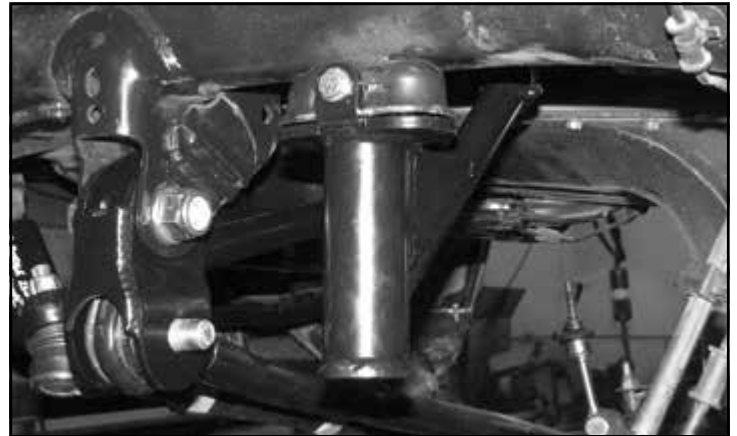

FIGURE 24 - STEP 31

32. Locate the FTS88 bump stop pad and thread it into the bottom of the Fabtech bump stop. **SEE FIGURE 25**

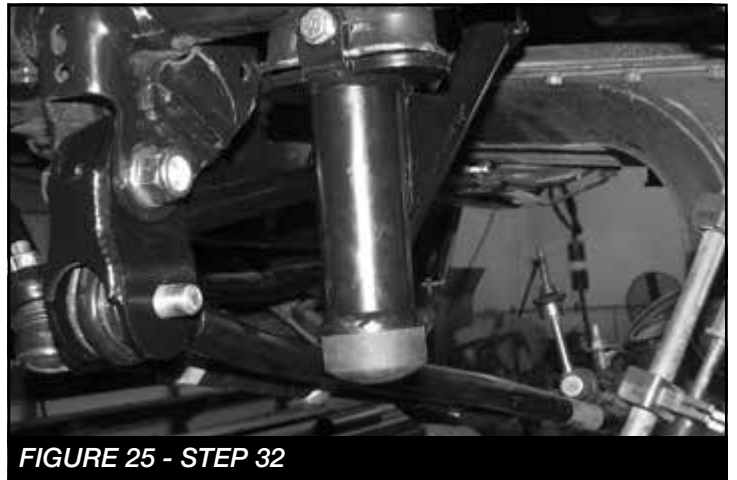

FIGURE 25 - STEP 32

33. Repeat steps 2-36 on the passenger side.

34. Secure the front diff. Remove the factory driver and passenger side Radius arm. Retain Hardware. **SEE FIGURES 26-27**



FIGURE 26 - STEP 34



FIGURE 27 - STEP 34

IF INSTALLING FABTECH RADIUS ARMS SKIP TO STEP 47

35. Remove the factory crossmember and skid plate that is mounted between the factory radius arm pockets. Retain Hardware. **SEE FIGURE 28**



FIGURE 28 - STEP 35

36. Trim 1/2" off both driver and passenger ends of the crossmember leaving a 1/4" border perpendicular to the bolt holes. This will be done to add clearance for the Fabtech radius arm brackets. **SEE FIGURES 29-30**

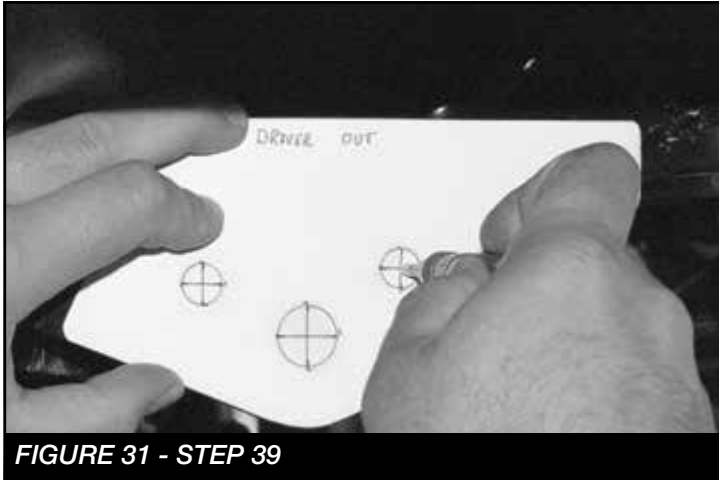

FIGURE 29 - STEP 36



FIGURE 30 - STEP 36

37. Reinstall the factory crossmember and torque to 200 ft-lbs.
38. Locate the Fabtech FT44232BK Radius arm drop bracket and the drill template in the instructions (**Page 21**). Cut out the template.
39. Line up the drill template with the factory Radius arm bracket and mark the two holes around the radius arm pivot bolt. **SEE FIGURE 31**



40. Using a 1/2" drill bit, drill all the way through both sides of the factory radius arm mount. **SEE FIGURES 32-33**

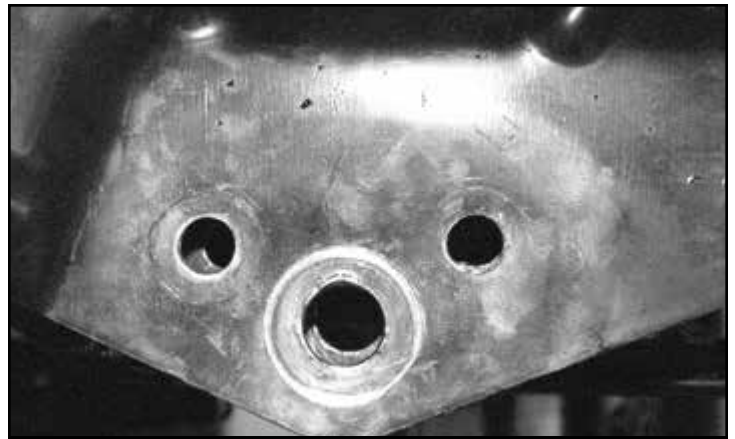

FIGURE 33 - STEP 40

Repeat steps 38-40 on the passenger side.

41. Slide the Fabtech radius arm mount into the factory pocket with the frame tab facing the front of the truck. **SEE FIGURE 34**

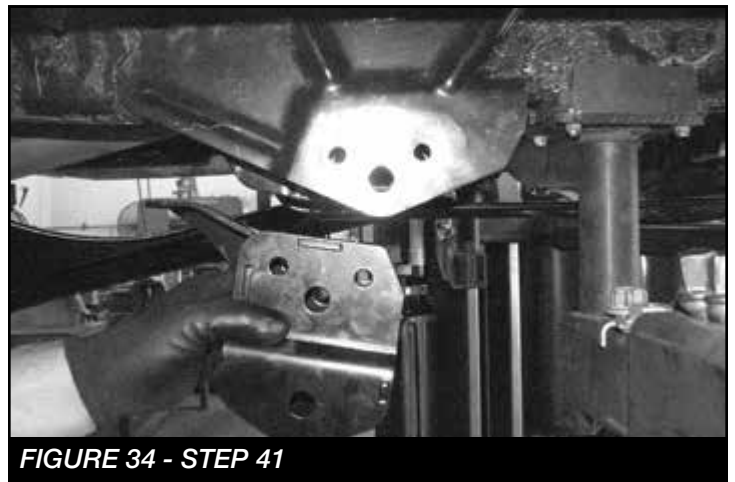

FIGURE 34 - STEP 41

42. Locate four 1/2"-13 x 1-1/4" bolts, nuts and washers. Use these bolts to mount the radius arm drop bracket to the factory bracket. Leave loose at this time. **SEE FIGURE 35**

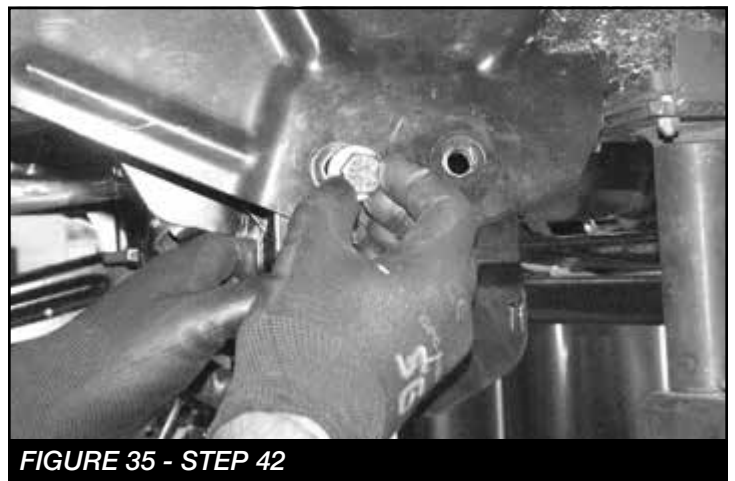

FIGURE 35 - STEP 42

43. Locate the M18-2.5 x 120MM bolt, nut and washers. Pass the 18mm bolt through the factory pivot hole into the FT604 sleeve. Torque the 18mm bolt to 200 ft-lbs and the four 1/2" bolts to 127 ft-lbs. **SEE FIGURES 36-38**



FIGURE 36 - STEP 43

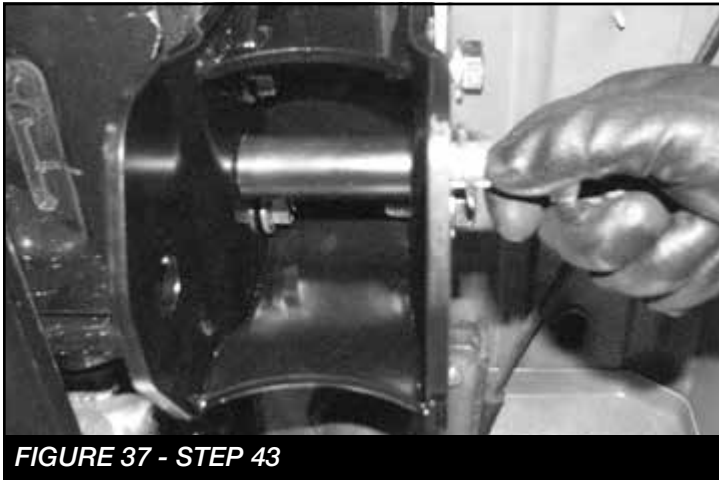

FIGURE 37 - STEP 43

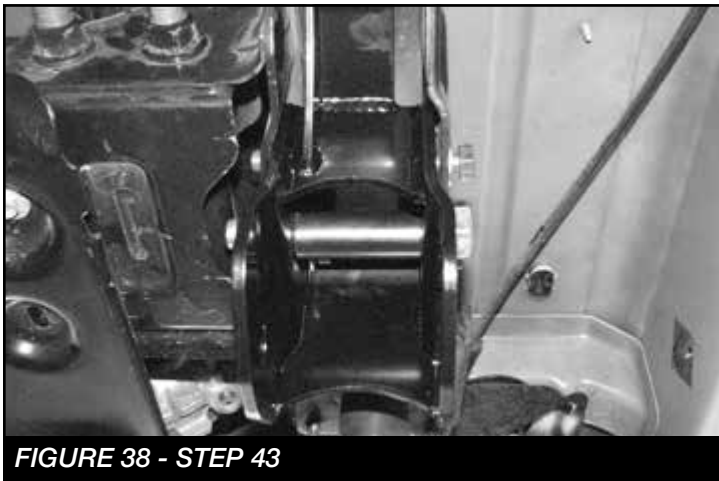

FIGURE 38 - STEP 43

44. Using the Fabtech the radius arm drop bracket as a drill guide, drill a 1/2" hole through the bottom of the frame. **SEE FIGURE 39**



FIGURE 39 - STEP 44

45. Locate a 1/2"-13 x 1-1/4" bolt and the FT44253 nut tab. Pass the nut tab through the hole in the frame forward of the radius arm drop bracket. Connect the bolt and the nut tab through the radius arm drop bracket and the frame. Torque to 127 ft-lbs. **SEE FIGURES 40-42**

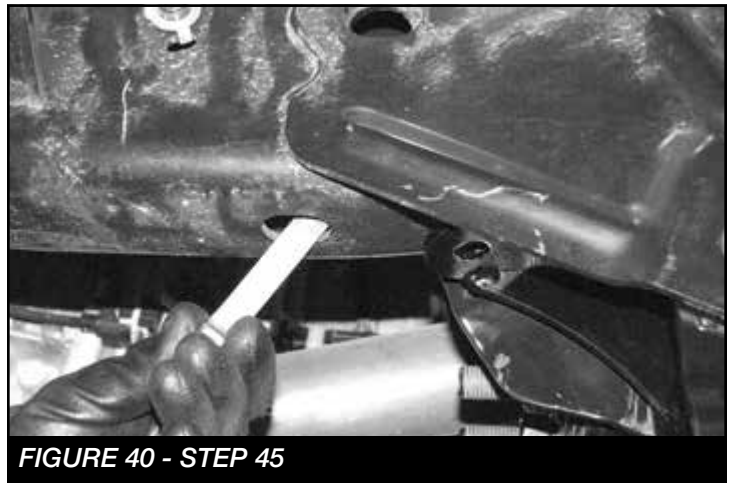

FIGURE 40 - STEP 45



FIGURE 41 - STEP 45

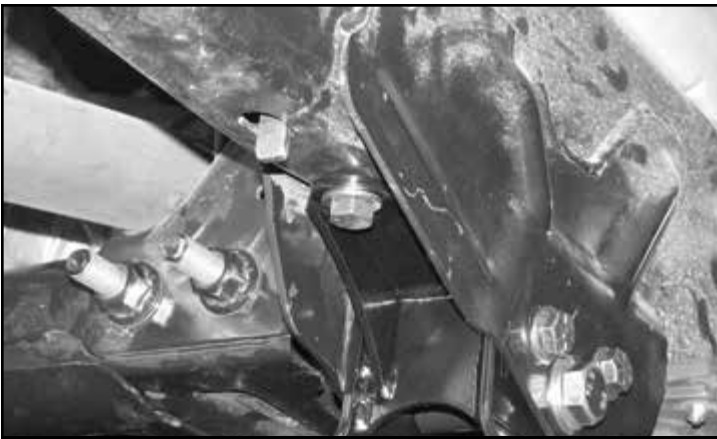

FIGURE 42 - STEP 45

REPEAT STEPS 41-45 ON THE PASSENGER SIDE

46. Reinstall the factory radius arms with the factory hardware and torque to 200 ft-lbs. **SEE FIGURES 43-46**



FIGURE 43 - STEP 46



FIGURE 44 - STEP 46



FIGURE 45 - STEP 46

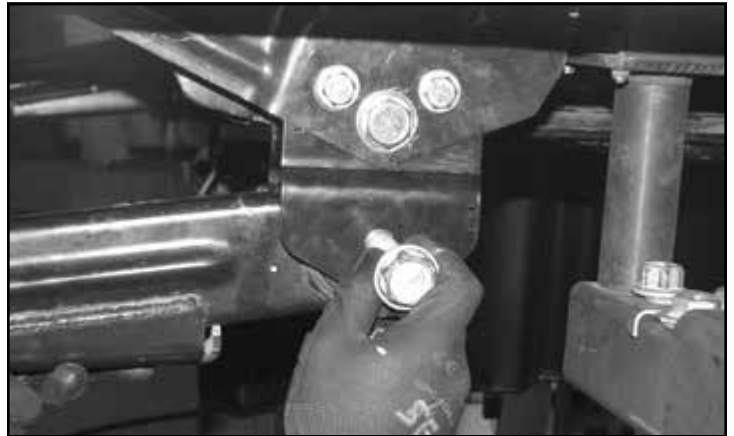

FIGURE 46 - STEP 46

IF INSTALLING FABTECH RADIUS ARMS FOLLOW STEPS 47-52

47. Locate the FT44449 Driver side radius arm, FT1006 bushing, FT102 sleeve, and zerk fitting.

48. Install two bushings, one sleeve, and the zerk fitting into the barrel of the radius arm. **SEE FIGURES 50-52**



FIGURE 47 - STEP 49



FIGURE 48 - STEP 49



FIGURE 49 - STEP 49

49. Install the new Fabtech radius arms into the factory frame pocket and onto the axle bushings using the factory hardware. Torque the factory bolts to 200 ft-lbs.

SEE FIGURES 53-55

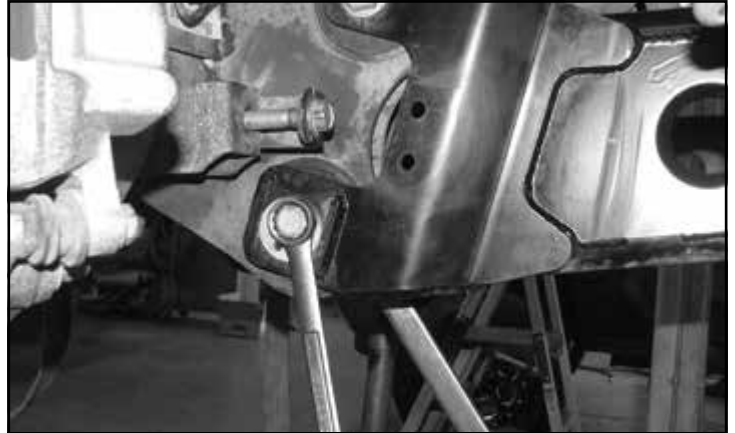

FIGURE 50 - STEP 50



FIGURE 51 - STEP 50



FIGURE 52 - STEP 50

50. REPEAT STEPS 46-47 ON THE PASSENGER SIDE.

51. Locate and install the new coil spring (FT44316BK) using the factory coil spring isolator. **SEE FIGURE 53**

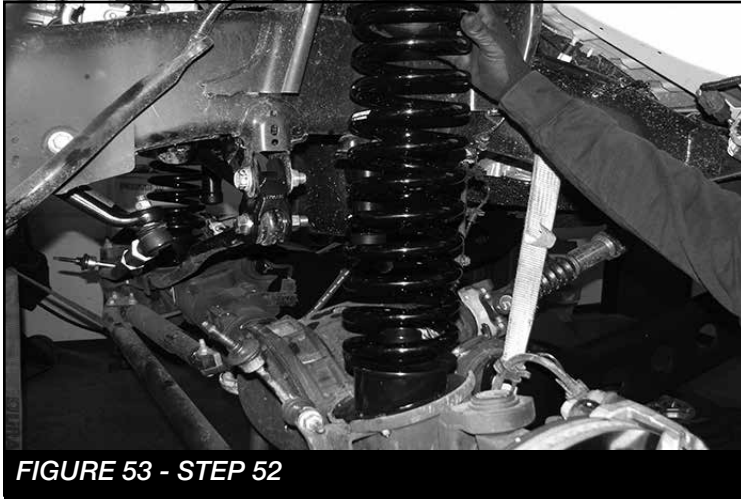

FIGURE 53 - STEP 52

REPEAT STEP 51 ON PASSENGER SIDE

52. Locate the FT44245 Brake line extension, FT44258 nut tab and two 1/4"-20 x 1" bolts. Attach the brake line extension to the axle using one bolt and the nut tab. Attach the factory brake line bracket to the Fabtech extension. Torque to 10 ft-lbs. Repeat this step on the passenger side. **SEE FIGURES 56-58**

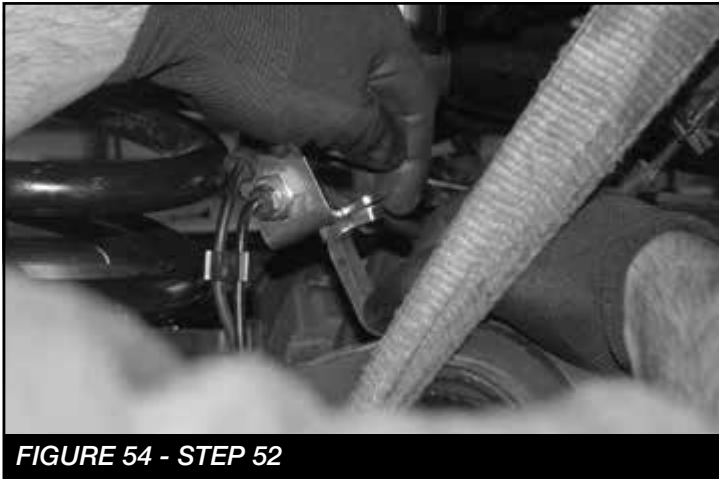

FIGURE 54 - STEP 52



FIGURE 55 - STEP 52



FIGURE 56 - STEP 53

53. Locate the (FTS7343) Performance shock, (FTS6343) Stealth shock or the FTS801032 Dirt Logic shock and install into the factory shock mounts. Torque the upper mount to 14 ft-lbs and the lower 37 ft-lbs. **SEE FIGURES 59-60**



FIGURE 57 - STEP 53

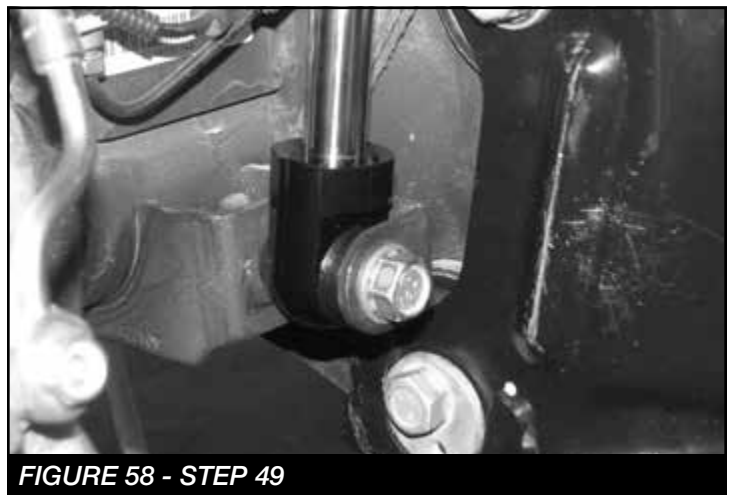

FIGURE 58 - STEP 49

54. Reconnect the factory sway bar. Torque to 29 ft-lbs.

SEE FIGURE 61

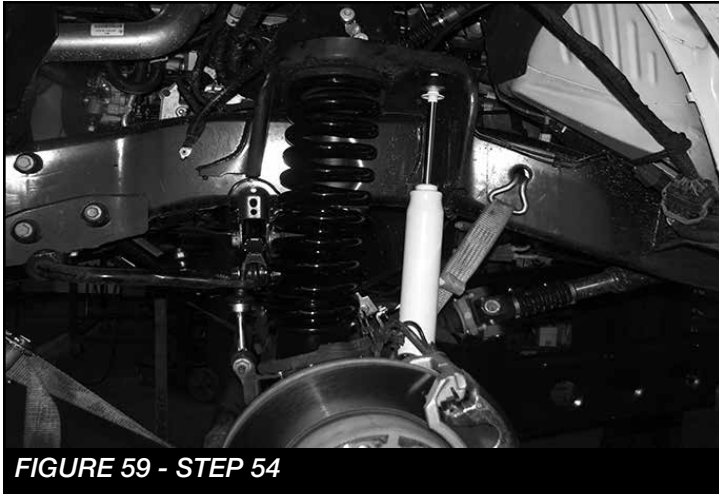

FIGURE 59 - STEP 54

REAR SUSPENSION

55. Jack up the rear end of the vehicle and support the frame rails with jack stands. Supporting the rear differential, remove and discard the rear shocks and u-bolts. Lower the axle down slowly. Use care not to over extend the brake hoses. **SEE FIGURES 60-61**

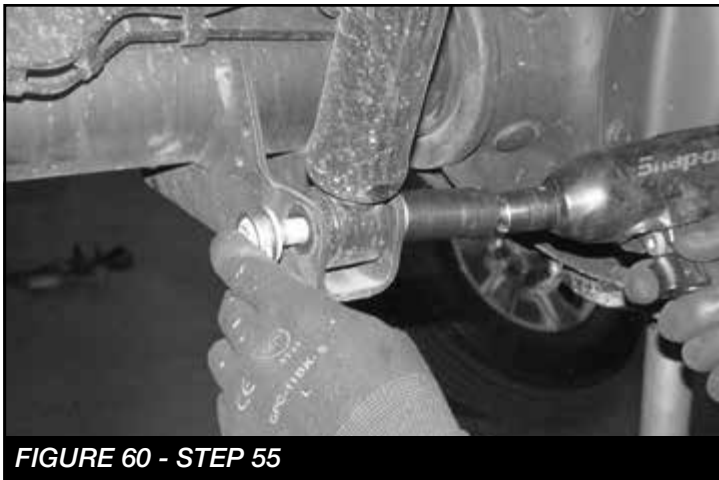

FIGURE 60 - STEP 55



FIGURE 61 - STEP 55

56. Locate the supplied 2" blocks FTBK21, FT738U u-bolts and 9/16" hardware. Install the block onto the axle with the small end of the taper to front of the truck. Using the supplied u-bolts, nuts and washers, align axle, lift block and springs and torque to u-bolts to 129 ft-lbs.

SEE FIGURES 62-65



FIGURE 62 - STEP 56



FIGURE 63 - STEP 56



FIGURE 64 - STEP 56

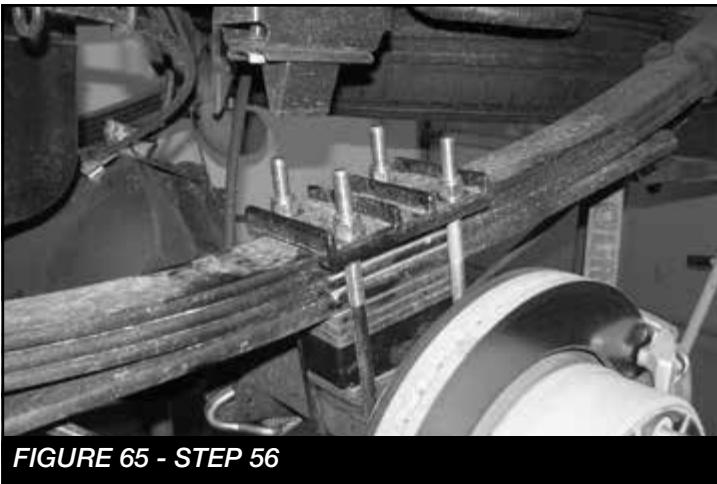

FIGURE 65 - STEP 56

57. Install new Fabtech Performance shocks (FTS7335), Stealth (FTS6335) or Dirt Logic 2.25" (FTS810362) with the factory hardware and torque upper and lower bolts to 29 ft-lbs.
58. Locate the FT44242BK bump stop extension. Remove driver and passenger factory bump stop. Retain Hardware.
59. Install the bump stop extension to the factory mount using the factory hardware and torque to 65 ft-lbs.
SEE FIGURE 66

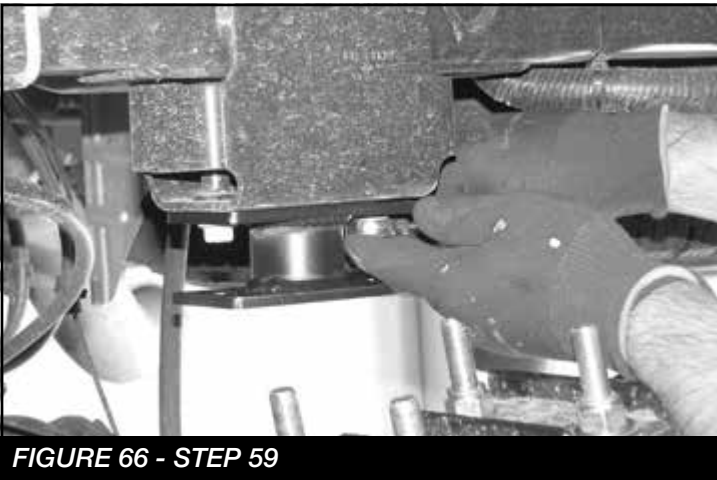

FIGURE 66 - STEP 59

60. Using 7/16"-14 x 1-1/4" bolt, nuts and washers, mount the factory bump stop to the extension. Torque to 59 ft-lbs. **SEE FIGURES 67-68**

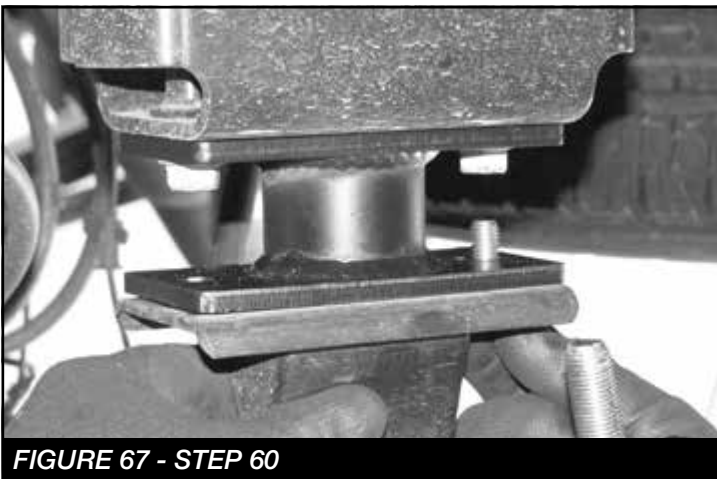

FIGURE 67 - STEP 60

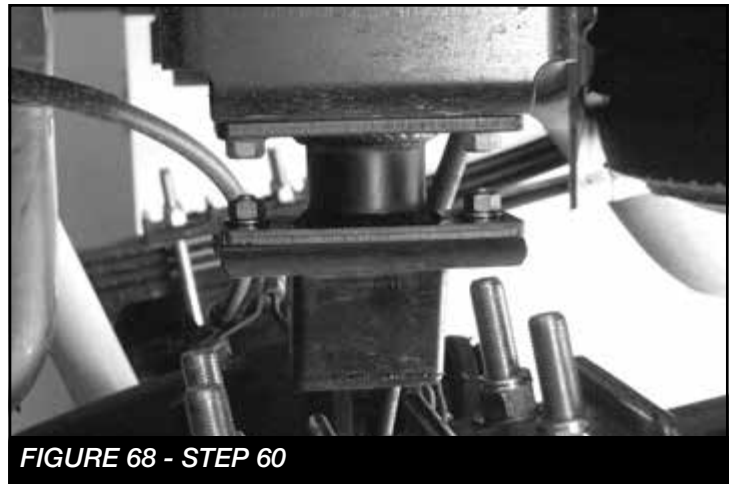

FIGURE 68 - STEP 60

61. Install tires and wheels and torque lug nuts to wheel manufacturer's specifications. Turn front tires left to right and check for appropriate tire clearance. **Note - Some oversized tires may require trimming of the front bumper & valance.**
62. Check front end alignment and set to factory specifications. Readjust headlights.
63. Recheck all bolts for proper torque.
64. Recheck brake hoses, ABS wires and suspension parts for proper tire clearance while turning tires fully left to right.
65. Check the fluid in the front and rear differential and fill if needed with factory specification differential oil. **Note - some differentials may expel fluid after filling and driving. This can be normal in resetting the fluid level with the new position of the differential/s.**
66. Install Driver Warning Decal. Complete product registration card and mail to Fabtech in order to receive future safety and technical bulletins on this suspension.

Vehicles that will receive oversized tires should check ball joints, uniballs and all steering components every 2500-5000 miles for wear and replace as required.

RETORQUE ALL NUTS, BOLTS AND LUGS AFTER 50 MILES AND PERIODICALLY THEREAFTER.

- Product Warranty and Warnings -

Fabtech provides a Limited Lifetime Warranty to the original retail purchaser who owns the vehicle, on which the product was originally installed, for defects in workmanship and materials.

The Limited Lifetime Warranty excludes the following Fabtech items; bushings, bump stops, ball joints, tie rod ends, limiting straps, cross shafts, heim joints and driveshafts. These parts are subject to wear and are not considered defective when worn. They are warranted from the date of purchase for defects in workmanship.

Dirt Logic and Performance Coilover take apart shocks are considered a serviceable shock with a one year warranty on leakage only. Service seal kits are available separately for future maintenance. All other shocks are covered under our Limited Lifetime Warranty.

Fabtech does not warrant any product for finish, alterations, modifications and/or installation contrary to Fabtech's instructions. Alterations to the finish of the parts including but not limited to painting, powder coating, plating and/or welding will void all warranties. Some finish damage may occur to parts during shipping, which is considered normal and is not covered under warranty.

Fabtech products are not designed nor intended to be installed on vehicles used in race applications or for racing purposes or for similar activities. (A "RACE" is defined as any contest between two or more vehicles, or any contest of one or more vehicle against the clock, whether or not such contest is for a prize). This warranty does not include coverage for police or taxi vehicles, race vehicles, or vehicles used for government or commercial purposes. Also excluded from this warranty are sales outside of the United States of America.

Installation of most suspension products will raise the center of gravity of the vehicle and will cause the vehicle to handle differently than stock. It may increase the vehicle's susceptibility to a rollover, on road and off road, at all speeds. Extreme care should be taken to operate the vehicle safely at all times to prevent rollover or loss of control resulting in serious injury or death. Fabtech front end Desert Guards may impair the deployment or operation of vehicles equipped with supplemental restraining systems/air bag systems and should not be installed if the vehicle is equipped as so.

Fabtech makes every effort to ensure suspension product compatibility with all vehicles listed on the website, but due to unknown auto manufacturer's production changes and/or inconsistencies by the auto manufacturer, Fabtech cannot be responsible for 100% compatibility, including the fitment of tire and wheel sizes listed. The Tire and Wheel sizes listed in Fabtech's website are only a guideline for street driving with noted fender trimming. Fabtech is not responsible for damages to the vehicle's body or tires. Fabtech is not responsible for premature wear of factory components due to the installation of oversized tires and wheels.

Fabtech's obligation under this warranty is limited to the repair or replacement, at Fabtech option, of the defective product only. All costs of removal, installation or re-installation, freight charges, incidental or consequential damages are expressly excluded from this warranty. Fabtech is not responsible for damages and/or warranty of other vehicle parts related or non related to the installed Fabtech product. This warranty is expressly in lieu of all other warranties expressed or implied. This warranty shall not apply to any product that has been subject to accident, negligence, alteration, abuse or misuse as determined by Fabtech.

Fabtech suspension components must be installed as a complete system including shocks as shown on our website. All warranties will become void if Fabtech parts are combined and/or substituted with other aftermarket suspension products. Combination and/or substitution of other aftermarket suspension parts may cause premature wear and/or product failure resulting in an accident causing injury or death. Fabtech does not warrant products not manufactured by Fabtech.

Depending on the condition of the factory suspension components retained after the installation of a Fabtech suspension not all vehicles may have the same ride stance front to rear as described in the website. The blue color of suspension components shown in all Fabtech photographs are for display purposes only. Majority of all Fabtech components will be black specifically where noted with part numbers ending in BK.

Installation of Fabtech product may void the vehicles factory warranty; it is the consumer's responsibility to check with their local vehicle's dealer for warranty disposition before the installation of the product. Some state laws may prohibit modification of suspension to a vehicle in whole or in part. It is the responsibility of the installer and consumer to consult local laws prior to the installation of any Fabtech suspension product to comply with such written laws.

It is the responsibility of the distributor and/or the retailer to review all warranties and warnings of Fabtech products with the consumer prior to purchase.

Fabtech reserves the right to super cede, discontinue, change the design, finish, part number and/or application of parts when deemed necessary without written notice. Fabtech is not responsible for misprints or typographical errors within the website or price sheet.

FT44232 - TEMPLATE

PRINT AT 100% - DO NOT SCALE TO PAGE

