



**2008-2016 Ford F250/350/450 8 lug
4wd 2008-2016 Ford F450/550 10 lug
4wd**

Qty	Part #	Description
		Coilover Hoop Kit
1	FT30452BK	Driver Lower Mount
1	FT30453BK	Passenger Lower Mount
1	FT30191	Hardware Kit
1	FT30513BK	4.0 Coil Over Hoop Drv.
1	FT30280BK	4.0 Coil Over Hoop Pass.
1	FT30322	Hdwr Sub-Assembly Kit

Qty	Part #	Description
	FT30322	Hdwr Sub-Assembly Kit
2	12001407102	14" Zip Tie
1	31000005052	5/16" Flat Washer
1	31180003352	5/16" C-Lock Nut
2	31181001152	5/16"-18 x 1" Bolt
2	50131501081	1/2"-13 x 1 1/2" Bolt
6	50000005252	1/2" Split Washer
1	31182001081	5/16"-18 x 2" Bolt
1	FT161	Sleeve
2	FT22078i	Instruction Sheet
2	FT30192BK	Limit Straps w/ Logo
2	FT30197	Upper Limit Strap Bracket
2	FT30198	Lower Limit Strap Bracket
1	FT30299	Nut Tab Drv
1	FT30300	Nut Tab Pass
1	FT30301	Dual Nut Tab Drv
1	FT30302	Dual Nut Tab Pass

Qty	Description	Location
14	1/2"-13 x 1 1/2" Bolt	Hoop To Frame
6	1/2"-13 x 1 3/4" Bolt	Hoop To Frame To Limit Strap
24	1/2"-13 C-Lock Nut	Bracket & Limit Straps
52	1/2"SAE Flat Washer	
4	7/16"-14 x 1 3/4" Bolt	Hoop To Frame (top)
4	7/16"-14 C-Lock Nut	
8	7/16 SAE Flat Washer	
8	1/4"-20 X 1" Bolt	All Brake Line to Hoop
8	1/4"-20 Nylock Nut	
16	1/4" SAE Flat Washer	
2	14mm-2.0 x 30mm Bolt	Lower Mount to Axle
2	14mm Flat Washer	
2	18mm-2.5 x 130mm Bolt	Upper Axle Pivot Bolt
2	18mm-2.5 C-Lock Nut	
4	18mm Flat Washer	
1	Lock Tight	

	FTS22143	2011-16 F250/350 SD 4.0 CONV
1	FT30452BK	LOWER FRONT MOUNT DRVR 05 SD
1	FT30453BK	LOWER FRONT MOUNT PASS 05 SD
1	FT30191	HARDWARE KIT
1	FT30513BK	4.0 COIL OVER HOOP DRIVER BLK
1	FT30280BK	4.0 COIL OVER HOOP PASSENGER
2	FT30456	AXLE SWAY BAR EXTENSION
1	FT30450	HARDWARE SUBASSEMBLY
1	FT30451	HARDWARE KIT
	FT30450	HARDWARE SUBASSEMBLY
1	FT161	SLEEVE .500 X .370 X 1.125
2	FT22078i	INSTRUCTIONS
2	FT30192BK	14" LIMIT STRAP QUAD W/LOGO
2	FT30197	UPPER LIMIT STRAP BRACKET
2	FT30198	LOWER LIMIT STRAP BRACKET
1	FT30299	NUT TAB DRIVER CLEAR ZINC
1	FT30300	NUT TAB PASSENGER CLEAR ZINC
1	FT30301	DUAL NUT TAB DRIVER CLEAR ZINC
1	FT30302	DUAL NUT TAB PASSENGER
1	FT30514	ABS BRACKET
	FT30451	HARDWARE KIT
8	12001407100	ZIP TIE 14"
4	31000005052	WASHER 5/16 SAE G5 Z1
4	31180003352	NUT 5/16-18 STOVER G5 Z1
2	31181001152	SCRW 5/16-18 1"HEX SELF TAP G5
4	31182001081	SCREW 5/16-18 X 1 HEX G8 Z2
6	50000005252	WASHER 1/2 SPLIT LOCK G8 Z1
2	50131251081	SCREW 1/2-13 X 1¼ HEX G8 Z2
4	50000005052	1/2 WASHER SAE G5 Z1
2	50130004152	1/2-13 C-LOCK NUT

TOOL LIST:

- Floor jack & Jack stands
- Assorted metric & S.A.E. wrenches & sockets
- Air Hammer
- Die Grinder with cutoff wheel
- Drill with 7/16" & 1/2" bit

CHECK ALL PARTS INCLUDED IN THIS KIT TO THE PARTS LIST ABOVE BEFORE

BEGINNING INSTALLATION OF THE KIT.

FABTECH RECOMMENDS FTS92024BK HYDRAULIC BUMP STOP KIT USE ON TRUCKS THAT WILL HAVE HEAVY OFF ROAD USE.

THIS KIT MUST BE INSTALLED WITH FABTECH DIRT LOGIC COILOVER SHOCKS NOT INCLUDED IN THIS BOX KIT.

THIS KIT IS COMPATIBLE WITH FABTECHS 4/6/8" RADIUS ARM SYSTEM OR 4/6/8" 4 LINK SYSTEM ONLY.

NOTE: IF YOU HAVE THE FABTECH DUAL SHOCK KIT FTS52002 ON THE VEHICLE, YOU WILL NEED SEVERAL OF THE PARTS THAT WERE DISCARDED DURING THE INSTALL OF THE DUAL SHOCK KIT. THE FORD PARTS REQUIRED ARE THE FACTORY BRAKE LINE BRACKETS. THE FABTECH PARTS REQUIRED ARE THE SWAY BAR DROP BRACKETS WITH HARDWARE AND SWAY BAR END LINKS WITH THE BUSHINGS AND HARDWARE. CONTACT FABTECH FOR PART NUMBERS IF NESSESARY.

Quality Fabtech suspension systems when used on "Gas engine" trucks may require that the front drive shaft be modified. This is done to give adequate clearance between the driveshaft and the factory exhaust. Fabtech does not recommend modifying the exhaust and / or the catalytic converters. Contact Fabtech for additional information.

*** SPANNER WRENCH IS NOT INCLUDED IN THIS KIT. IF NEEDED, ORDER FTS89905.

INSTRUCTIONS:

1. Disconnect the negative terminal on the battery. Jack up the front end of the truck and support the frame with jack stands. **NEVER WORK UNDER AN UNSUPPORTED VEHICLE.** Remove the front tires.
2. Support the front axle with a floor jack. Raise the floor jack approx. 1". Working on both sides of the truck, remove the front shocks and discard. Save the factory lower shock bolt and nut tab. Disconnect the front sway bar end links from the axle mount and save the hardware.
3. Remove the brake line bracket from the factory coil bucket and discard hardware. If a Fabtech kit has already been installed, remove the brake line drop bracket supplied with that kit and discard. Remove the brake line and ABS line mounts from the lower coil perch and discard the hardware.
4. Remove the trac bar bracket from the driver side of the frame and save the hardware.
5. Lower the floor jack supporting the axle until the coil springs are free of tension. Remove the coil springs and discard.
6. Locate bump stop on the bottom of the frame below the coil bucket and remove. If you have a Fabtech kit that has already been installed on the truck, remove the bump stop along with the drop bracket and discard. Fabtech recommends running the FTS92001 optional Hydraulic Bump Stop Kit. The installation of the coil over kit does not require the installation of a bump stop.
7. Working from the driver's side of the truck, use a die grinder with a cut off wheel to cut a cross pattern in the heads of the rivets that attach the factory coil bucket to the frame. Using an air chisel, remove the heads of the rivets and pry the coil bucket free from the frame. With the bucket removed from the frame use a hammer and center punch and knock the rest of the rivets out of the holes in the frame (unbolt the power steering line bracket from the hoop). SEE PHOTOS BELOW.

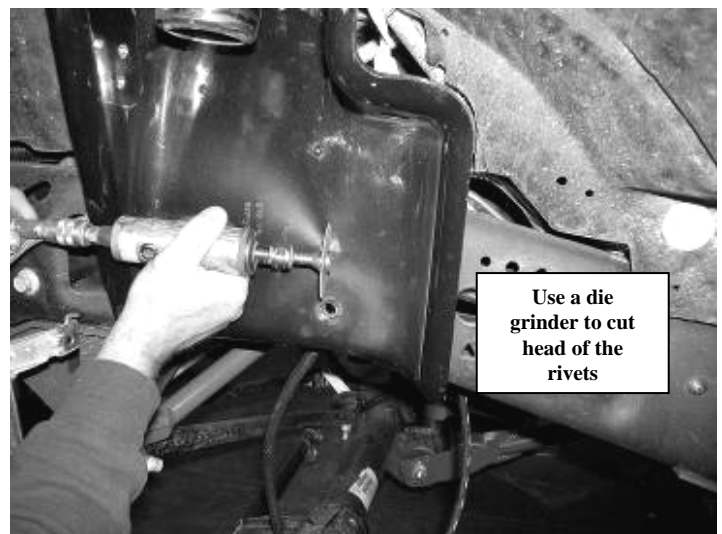

Use a die grinder to cut head of the rivets

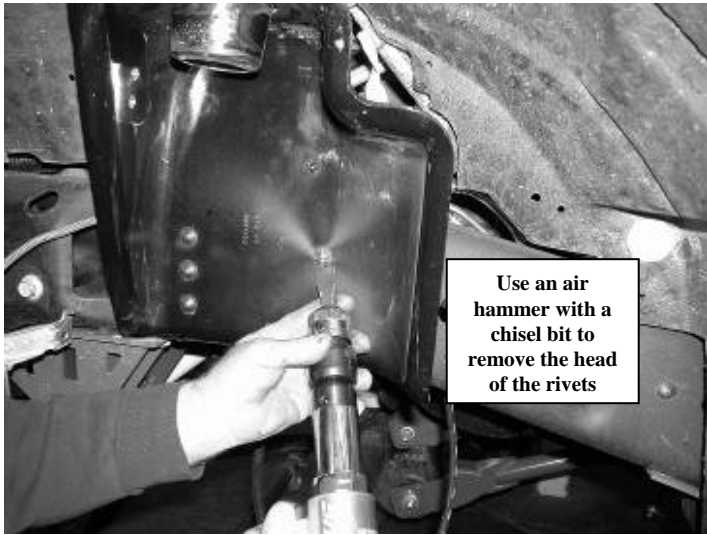

Use an air hammer with a chisel bit to remove the head of the rivets

8. Drill all the holes on the outside and bottom of the frame (where the rivets were just removed), to $\frac{1}{2}$ ". SEE PHOTO BELOW.

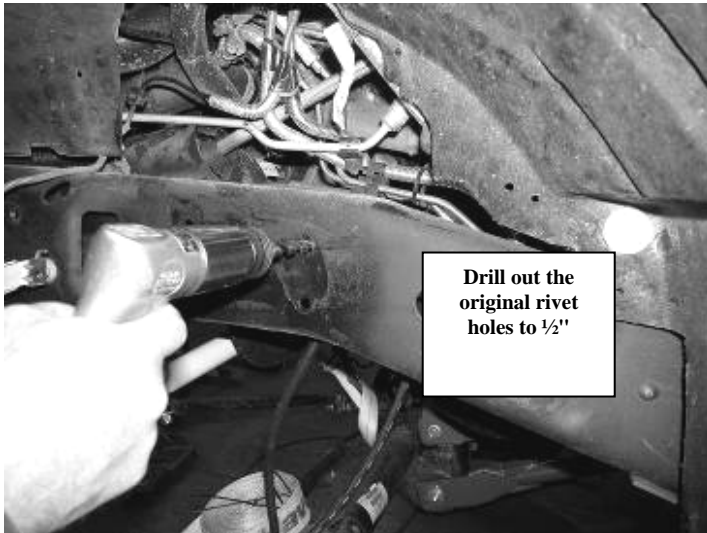

Drill out the original rivet holes to $\frac{1}{2}$ "

9. Locate the factory lower coil perch on the axle and remove. Discard the perch and hardware.
10. Using a sharp razor blade cut a 6" wide x 4" high rectangle in the plastic inner fender well as shown below. When cutting the inner fender well do not cut the heat shield felt on the backside of the inner fender well. SEE PHOTOS IN NEXT COLUMN.



Passenger Side Marked and Uncut



Driver Side Marked and Uncut

11. Repeat steps eight through eleven on the passenger side of the truck. Remove the wiring harness from the face of the frame and save the hardware. Carefully bend the A/C lines to make room for the coilover bucket. SEE PHOTO BELOW.



Photo shows bent A/C line

12. Working from the driver side of the truck, locate FT30452 lower coil over axle mount. Place the mount on the axle where the factory coil perch was located, aligning the arm of the new perch into the factory lower shock mount on the axle. Using the supplied 14mm bolt and washer and small amount of the supplied thread locking compound attach it to the axle. Using the original lower shock bolt and nut tab attach the support arm of the mount to the factory shock mount on the axle. Torque the 14mm bolt to 100 ft. lbs. and the support arm bolt to 80 ft. lbs. SEE PHOTO BELOW

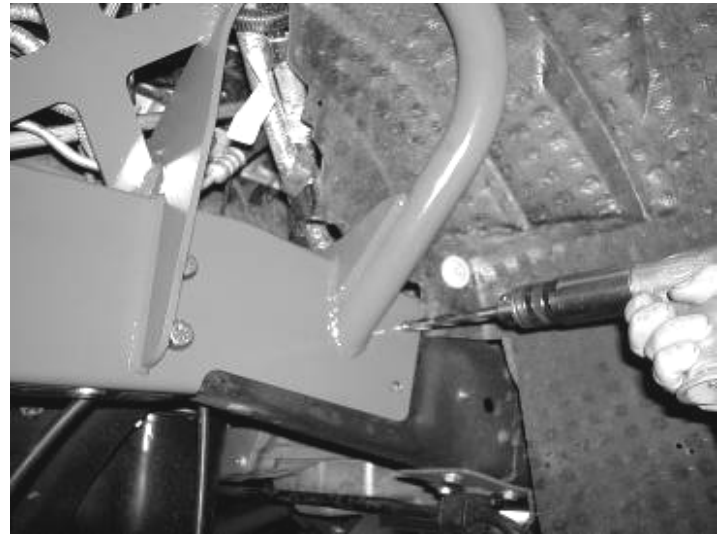

Driver side shown

13. Locate FT30513BK (driver side) Coil Over Hoop and align onto the frame where the factory bucket was mounted. Align the holes in the hoop to the holes in the frame. Using the supplied $\frac{1}{2}$ " x $1\frac{1}{2}$ " hardware in the holes on the outside of the frame, attach the hoop to the frame, leave loose at this time.



14. Drill the three rear holes to $\frac{1}{2}$ " through the frame. Locate FT30299 & FT30301 nut tabs and use the supplied $\frac{1}{2}$ " x $1\frac{1}{2}$ " hardware attach to the frame. Locate FT161 Sleeve and the supplied $\frac{5}{16}$ "x2" hardware. Attach the power steering line bracket to the back of the bucket and torque to 15lbs. **NOTE: For 11- up vehicles install FT30514 (ABS Bracket) to the rear of the hoop.** Once tightened, make sure that the lines are NOT making contact with the hoop. Carefully bend them for additional clearance if needed. Repeat steps 14 & 15 on the passenger side of the truck. SEE PHOTOS IN NEXT COLUMN. Torque $\frac{1}{2}$ " hardware to 127 ft-lbs.

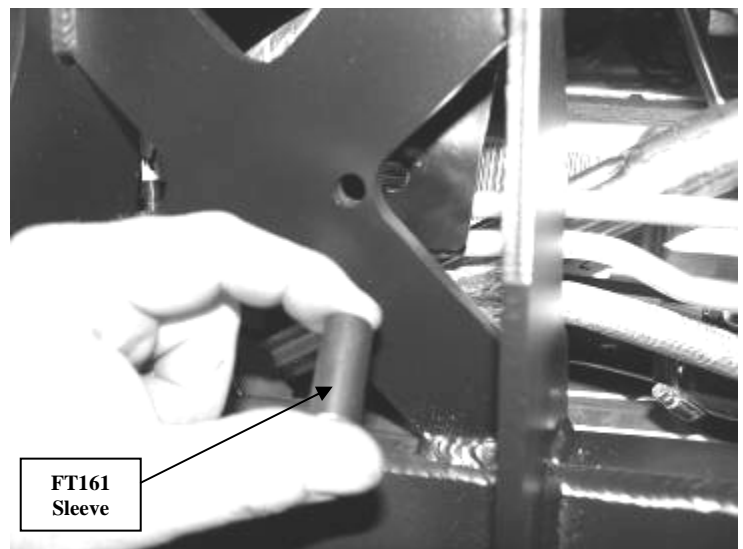

Driver side shown

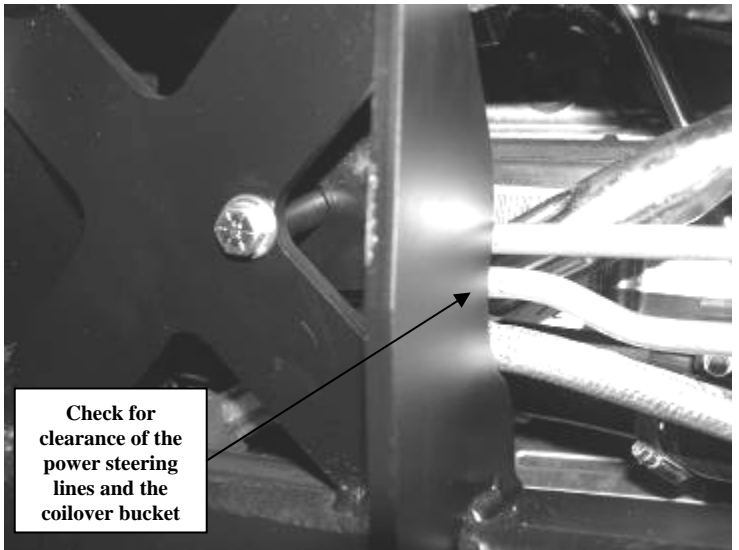

Check for clearance of the power steering lines and the coilover bucket

Driver side shown

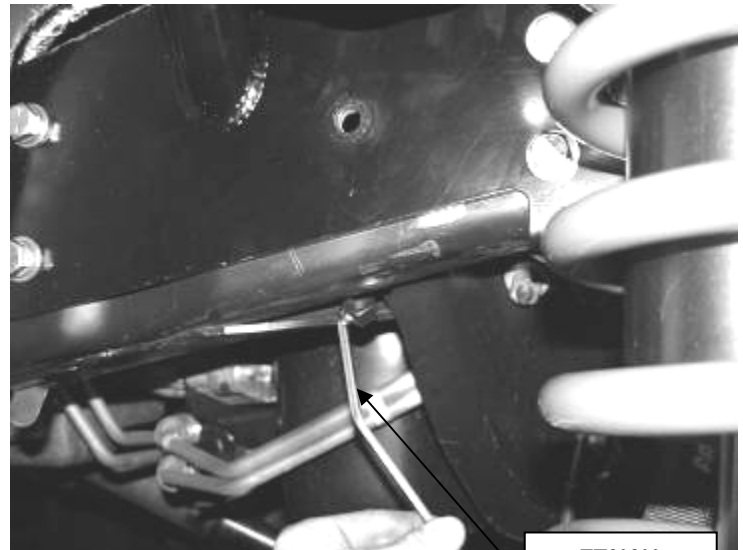

Passenger side Shown

FT30300
Passenger
Single Nut Tab

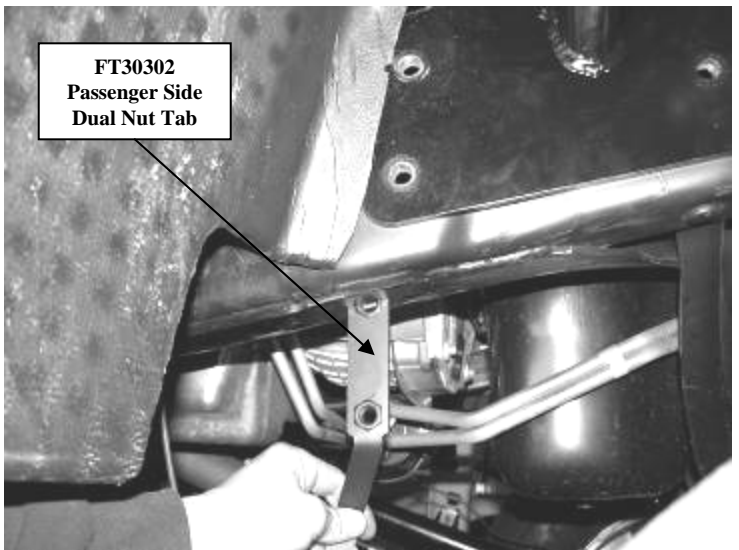

FT30302
Passenger Side
Dual Nut Tab

Passenger side Shown

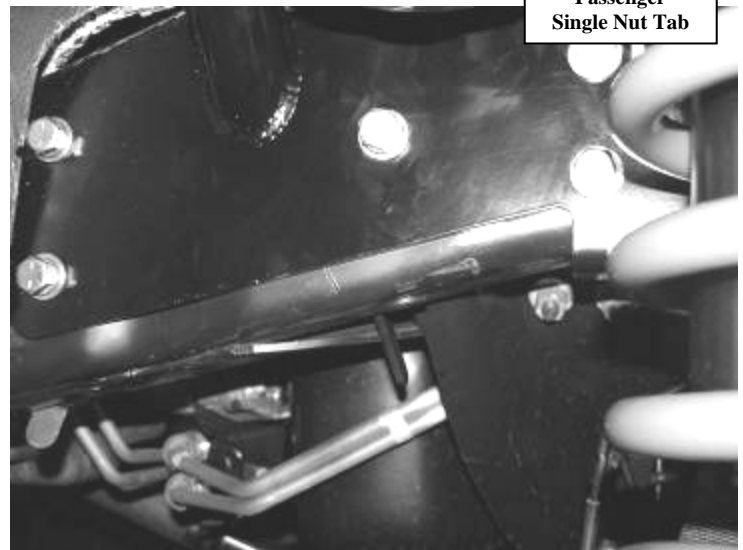

Passenger side Shown

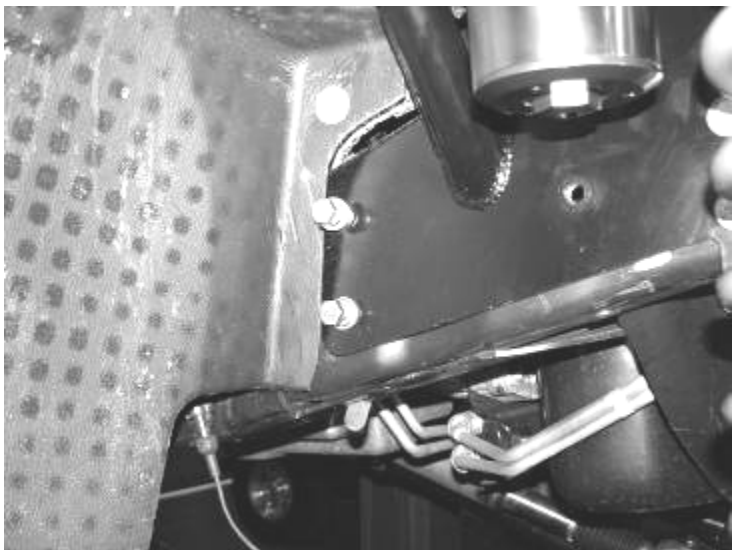

Passenger side Shown

15. Reinstall the trac bar bracket to the frame and torque the frame mount bolts to 80 ft. lbs., motor mount bolt to 55 ft. lbs., & trac bar bolt to 400 ft. lbs.
16. Locate FT30197 upper limit strap bracket. Place the bracket on the inside of the frame to the rear hole on the bottom of the frame (the long side of the bracket mounts to the frame with the short side attaching to the strap). Using the supplied 1/2" x 1 3/4" hardware, attach it to the frame. Attach the forward hole of the hoop to the frame with the supplied 1/2" x 1 1/2" hardware at this time also. Torque to 50 ft. lbs. SEE PHOTO BELOW.

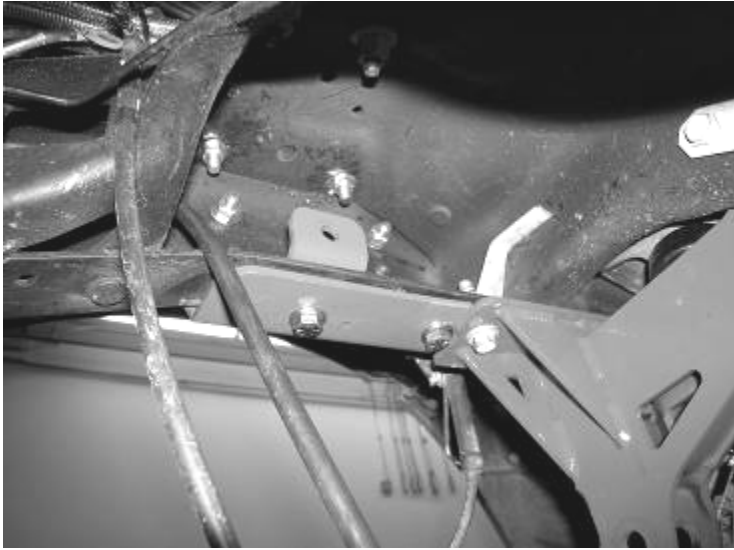

View of driver's side from looking rear to front

17. Locate the upper axle pivot on the front axle. Remove the bolt and discard. Locate FT30198 lower limit strap bracket and attach to the inside of the upper pivot using the supplied 18mm x 130mm bolt, nut, and washer. If installing this kit on an 8" kit, the long end of the bracket will be facing upward and on a 4 & 6" kit the short end will be facing up. SEE PHOTOS ON NEXT PAGE.



Picture Shown With Tab Set Up For 8" Kit



Picture Shown With Tab Set Up For 6" Kit

18. If installing Fabtech's optional Hydraulic front bump stop kit, do so at this time.
19. Locate the supplied two large zip ties. Use the zip ties and attach the wiring harness to the power steering lines inside the driver's side wheel well. SEE PHOTO IN NEXT COLUMN.



20. Locate the two holes on the passenger side coilover hoop. The top hole will need to be drilled out to 17/64". Locate the electrical wiring harness on the passenger side which was removed earlier during install and attach to the coil bucket with the factory hardware. SEE PHOTO IN NEXT COLUMN



21. Locate coilovers and insert one of the supplied FT83034 mis-alignment spacers to each side of the top bearing in the shock. Next locate the supplied FT1040 and FT1041 Delron bushings and place the one with the larger inner ring on the side of the bearing without the snap ring and the one with the smaller inner ring on the side with the snap ring. Insert the top of the coil over into the coil over hoop. Using the supplied 5/8" x 3.5" bolt and washers and FT30183 nut tab connect the coil over to the hoop. SEE DIAGRAM ON LAST PAGE.
22. Locate the last two FT83034 mis-alignment spacers and insert them into the bearing on the bottom of the shock. Using the supplied 5/8" x 3.5" bolt, nut, and washer attach it to the lower mount on the axle. SEE DIAGRAM ON LAST PAGE.
23. Install the supplied limit straps to the upper and lower mounts using the supplied 1/2" x 1 3/4" bolt, nuts, and washers. You will need to stack three 1/2" washers between the limit strap and mounting brackets on both upper and lower mounts. SEE DIAGRAM BELOW.

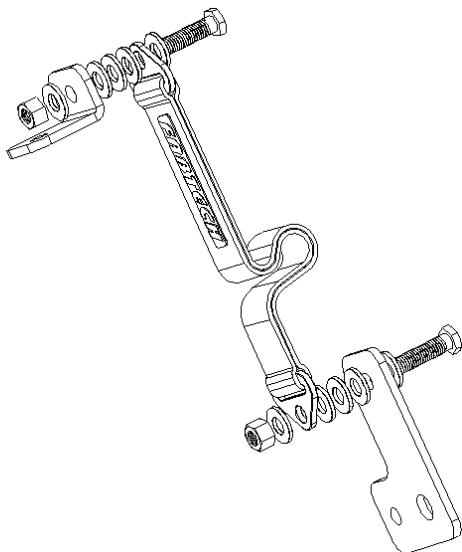

24. Using the Supplied 1/4" x 1" bolt, nut, and washer attach the ABS line to the new lower coil perch as shown below. The original line clamps will be reused. SEE PHOTO BELOW.

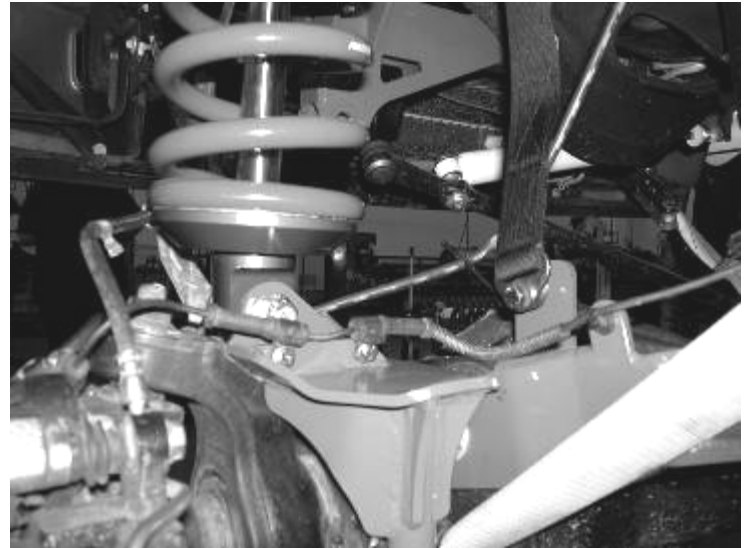

25. Re-attach the upper brake line bracket to the frame just in front of the coil over hoop with the original hardware. Attach the lower brake line bracket to the new lower coil over mount using the supplied 1/4" x 1" bolt, nut, and washer. SEE PHOTO BELOW

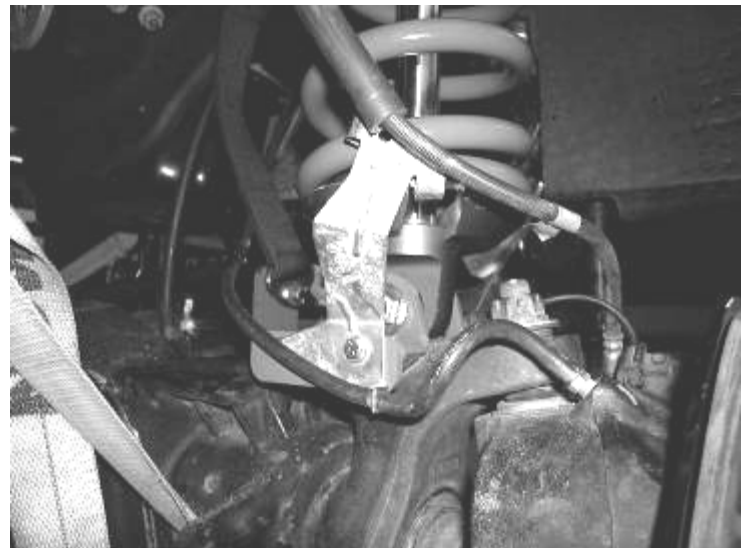

26. Make sure the vacuum line from the hub assembly is still routed in the stock position. If the line is tight carefully pull some slack free from the frame mounts.
27. Reconnect the front sway bar back to the axle mount using the original hardware on the 2008 – 2010 models. **2011 models** Locate the FT30456 Lower sway bar extension and attach the extension to the axle using a 1/2x13x1-1/4 bolt, nut and washer as shown in the diagram and pictures below. Torque to 127 ft-lbs.

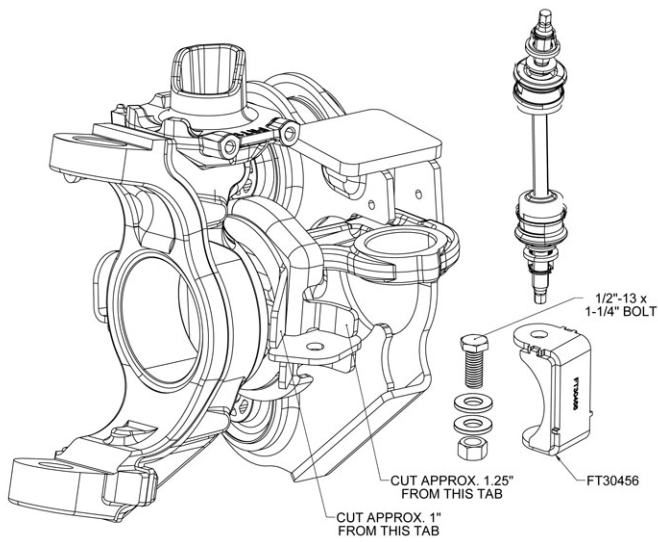

28. Reinstall the front tires and set the truck back on the ground. Turning the steering wheel fully in each direction, check for contact between the tires and any newly installed components. Drive the truck fifty miles and have a professional front end alignment done. Re-adjust headlights.

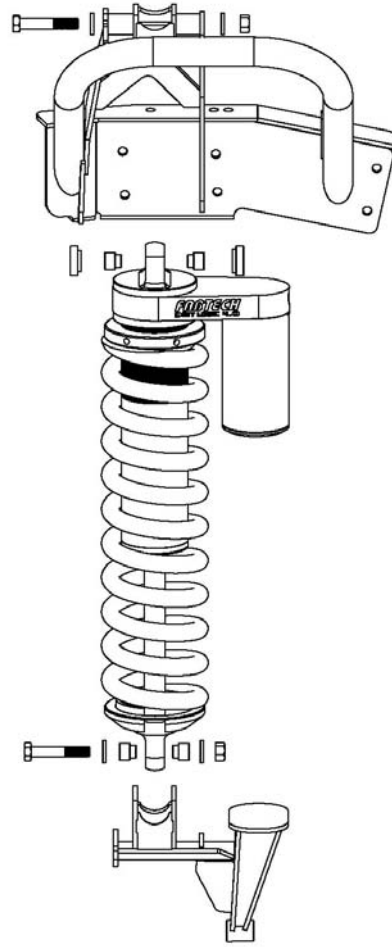
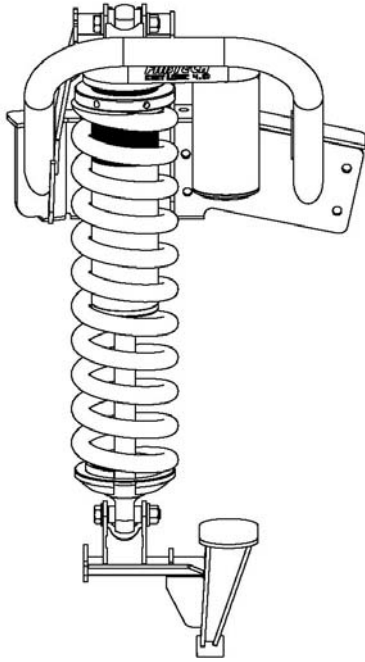



FTS22103

**2008-2016 FORD SUPER DUTY 4WD
REAR LIFT FOR 4" & 6" F-350 WITH FACTORY OVER LOAD
LEAF**

PARTS LIST:

Qty	Part #	Description
2	FTBK3	3" Block
4	FT742U	U-Bolt
1	FT58H	5/8" Hardware
1	FTS419	Shim Kit
2	FT22103i	Instruction Sheet

Tool List: (Not Included)

Floor Jack

Jack Stands

Assorted Metric and S.A.E Sockets & Allen Wrenches

READ ALL INSTRUCTIONS THOROUGHLY FROM START TO FINISH BEFORE BEGINNING INSTALLATION!

CHECK ALL PARTS INCLUDED IN THIS KIT TO THE PARTS LIST ABOVE BEFORE BEGINNING INSTALLATION OF THIS KIT.

**IF TRUCK IS EQUIPPED WITH REAR SWAY BAR,FTS92010BK REAR SWAY BAR DROP BRACKET
CAN BE PURCHASED.**

INSTRUCTIONS:

1. Disconnect the negative terminal on the battery. Jack up the rear end of the vehicle and support the frame rails with jack stands. Supporting the rear differential, remove and discard the rear shocks and u-bolts. Lower the axle down slowly. Use care not to over extend the brake hose.
NEVER WORK UNDER AN UNSUPPORTED VEHICLE!
2. Locate and install the rear lift blocks, For 6" kits the factory block will be positioned on top of the new Fabtech block. For 4" kits the factory block will need to be removed. Install with the short center pin of both blocks facing down, to the axle. The short end of the blocks should face to the front of the vehicle. Using the supplied u-bolts, nuts, and washers align axle, lift blocks, and springs and torque to U-Bolts to 180 ft-lbs. SEE PHOTO



3. Install Fabtech shock part number FTS7266 Performance Shocks or FTS81005 Dirt Logic (not included) with the factory hardware and torque bolts to 65lbs.
4. Rotate the E-Brake cable bracket so that it positions the cable below the spring plate and attach to the plate with the factory hardware. Once tightened, bend the bracket forward towards the front of the truck. Locate the upper E-brake cable bracket on the frame and bend it outward / down to give the cable some more slack. SEE PHOTOS BELOW

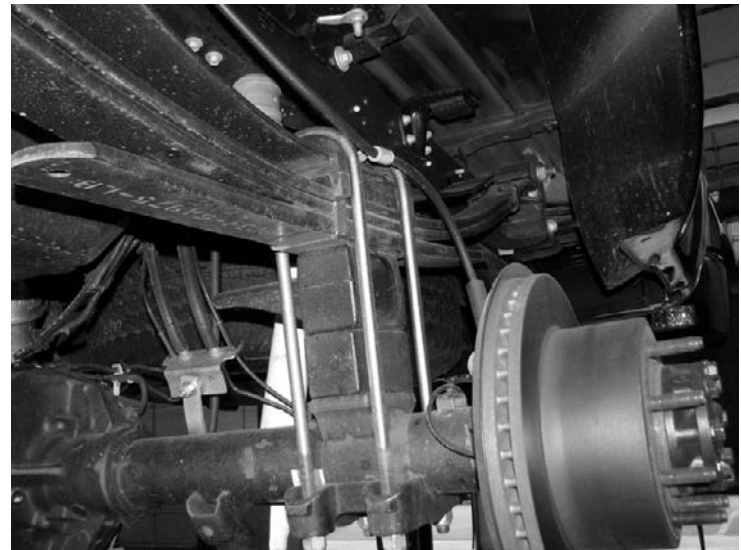
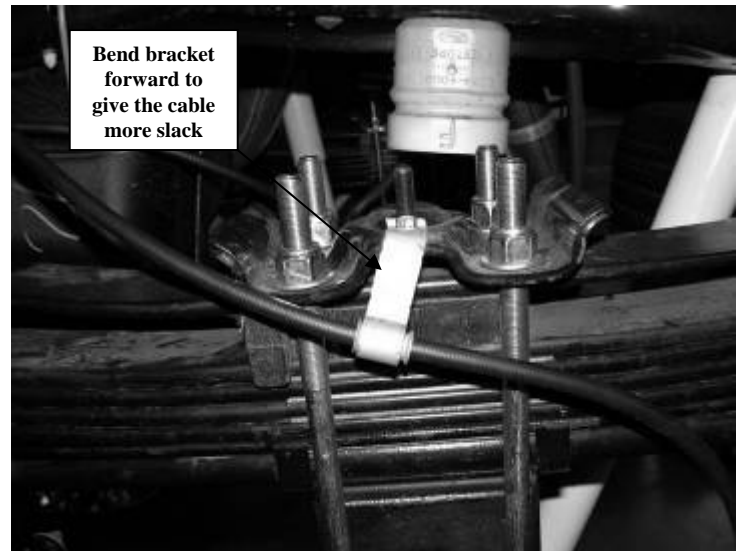

2011 rear configuration shown above.

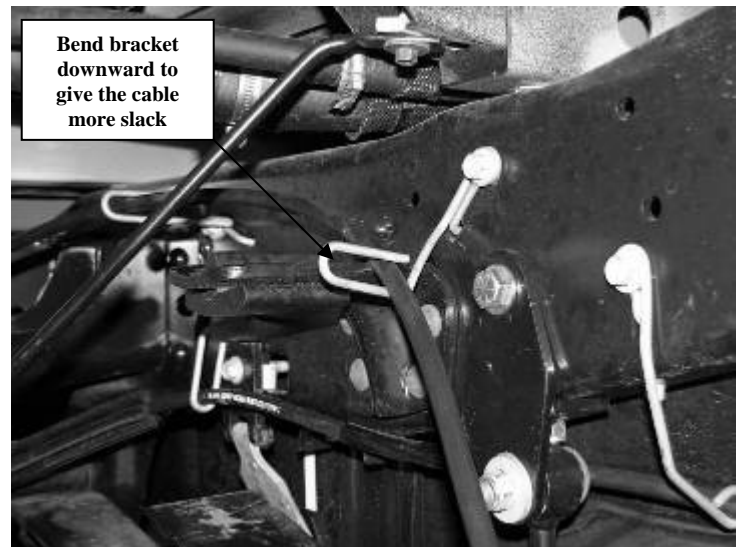

5. Install FTS419 shim kit as per the instructions in the FTS419 box.

6. Recheck all bolts for proper torque. Recheck brake hoses and lines for proper clearances.

7. **2011 models only** .Locate the factory brake line mount on the driver side of the axle. Remove the vent line from the bolt and remove bolt, save hardware. Locate the supplied brake line bracket FT30059; attach the side with the sleeve to the axle using the factory hardware. Using the supplied 3/8" x 2" bolt, nut, and washer attach the brake line to the other end. Reattach vent line. SEE PHOTO BELOW.



8. Install tires and wheels and torque lug nuts to wheel manufacturer's specifications.

9. Readjust headlights.

10. Check the front-end alignment and set to the factory specifications.

RETORQUE ALL NUTS, BOLTS AND LUGS AFTER 50 MILES AND PERIODICALLY THEREAFTER.



FTS22139
4" / 6" & 8" RADIUS ARM BOX
KIT

2008-2016 FORD F-250/350 SUPER DUTY 4WD



**2008 – 2016 FORD F-250/350 SUPER DUTY
4WD FTS22139
4", 6" & 8" RADIUS ARM KIT**

FTS22139 Radius Arm Box Kit		
Qty	Part #	Description
1	FT30125BK	Custom Radius Arm Driver
1	FT30126BK	Custom Radius Arm Pass
1	FT30122	Pitman Arm
1	FT30143BK	Frnt. Bumpstop Drop Driver
1	FT30144BK	Frnt. Bumpstop Drop Pass
1	FT30402	Steering Stabilizer Drop 08-10
1	FT3400-112P	Sway Bar Drop Driver 08-14
1	FT3400-112D	Sway Bar Drop Pass. 08-14
1	FT30373BK	Trac Bar Drop Bracket
1	FT30273BK	Trac Bar Support Tube
1	FT30434	Hdwr Sub-Assembly
1	FT30287	Hardware Kit (radius arm)
1	FT30583BK	Steering Stabilizer Drop 11-UP
1	FT30630	Sway Bar Drop Driver 15-UP
1	FT30629	Sway Bar Drop Pass 15-UP

FT30434 Hdwr Sub-Assembly Kit		
Qty	Part #	Description
4	FT1006	Bushing
2	FT102	Sleeve
2	FT30409	Brake Line
2	FT30410	Brake Line Union
2	FT30432	Brake line Bracket 2011
1	FT30059	Brake line Bracket
2	FT30276	Frnt. Brake line Bracket
1	FT30258	Sector Shaft Nut
1	FT292	Alignment Cam Half Kit
1	FTLUBE	Lube
2	FT22139i	Instruction Sheet
1	FTREGCARD	Reg. Card
1	FTAS12	Fabtech Sticker
2	FT30277	ABS Bracket @ Radius Arm

FT30287 Hardware Kit		
Qty	Description	Location
2	5/16"-18 x 1 1/4" Bolt	Brake Line Bracket
2	5/16"-18 Nylock Nut	
4	5/16" SAE Flat Washer	
2	5/16"-18 x 1" Thd Frmg Bolt	
2	5/16"-18 x 1 1/4" Bolt	Bump Stop Center
2	5/16" SAE Flat Washer	
2	5/16" Split Washer	
4	7/16"-14 x 1 1/2" Bolt	Bump Stop
4	7/16"-14 Nylock Nut	
8	7/16" SAE Flat Washer	
4	7/16"-14 x 1 1/4" bolt	Sway Bar Drop Brkt
4	7/16"-14 C-Lock Nut	
8	7/16" SAE Flat Washer	
6	1/4"-20 x 1" Bolt	ABS Line & Brkt
6	1/4"-20 C-Lock Nut	@ Radius Arm
12	1/4" SAE Flat Washer	
2	Adel Clamp	ABS Line & Brkt
2	Zerk Fitting	Radius Arm End
1	1/8" x 2" Cotter Pin	Drag Link
1	Lock Tight	
7	8" Zip Ties	4wd & ABS Lines
1	M12-1.75 X 70MM Bolt	Steering Stabilizer
2	M12 SAE Flat Washer	
1	M12-1.75 C-Lock Nut	

TOOL LIST:

- FLOOR JACK
- JACK STANDS
- ASSORTED METRIC AND S. A. E. WRENCHES AND SOCKETS
- WHITE LITHIUM GREASE
- TORQUE WRENCH
- DIE GRINDER WITH A CUTOFF WHEEL

READ ALL INSTRUCTIONS THOROUGHLY FROM START TO FINISH BEFORE BEGINNING INSTALLATION.

CHECK PARTS & HARDWARE AGAINST THE PARTS LIST BEFORE BEGINNING THE INSTALLATION TO ASSURE THE KIT IS COMPLETE.

FABTECH RECOMMENDS YOU DO A PRE- INSPECTION OF THE TRUCKS FRAME FOR ANY DAMAGE BEFORE BEGINNING THE INSTALLATION OF THIS KIT. FABTECH ALSO RECOMMEND YOU PREFORM AN ALIGNMENT ON THE TRUCK BEFORE BEGINNING THE INSTALLATION. IF THE TRUCK HAS ANY FRAME DAMAGE OR WILL NOT ALIGN TO FACTORY SEPECS. DO NOT INSTALL THIS KIT UNTIL THE DAMAGE IS CORRECTED.

FABTECH RECOMMENDS THE FOLLOWING TIRE SIZES FOR USE WITH THIS KIT:

4" & 6" LIFT- 325/65R18 TIRES W/ 18X9.5 WHEELS W/ 4 3/4" BACK SPACING

8" LIFT- 355/65R18 TIRES W/ 18X9.5 WHEELS W/ 4 3/4" BACK SPACING

Fabtech suspension systems when used on "Gas engine" trucks may require that the front drive shaft be modified. This is done to give adequate clearance between the driveshaft and the factory exhaust. Fabtech does not recommend modifying the exhaust and / or the catalytic converters. Contact Fabtech for additional information.

****NOTE - DO NOT PROCEED WITH INSTALLATION OF SUSPENSION KIT UNTIL VERIFYING THE PROPER FACTORY PITMAN ARM LENGTH.**

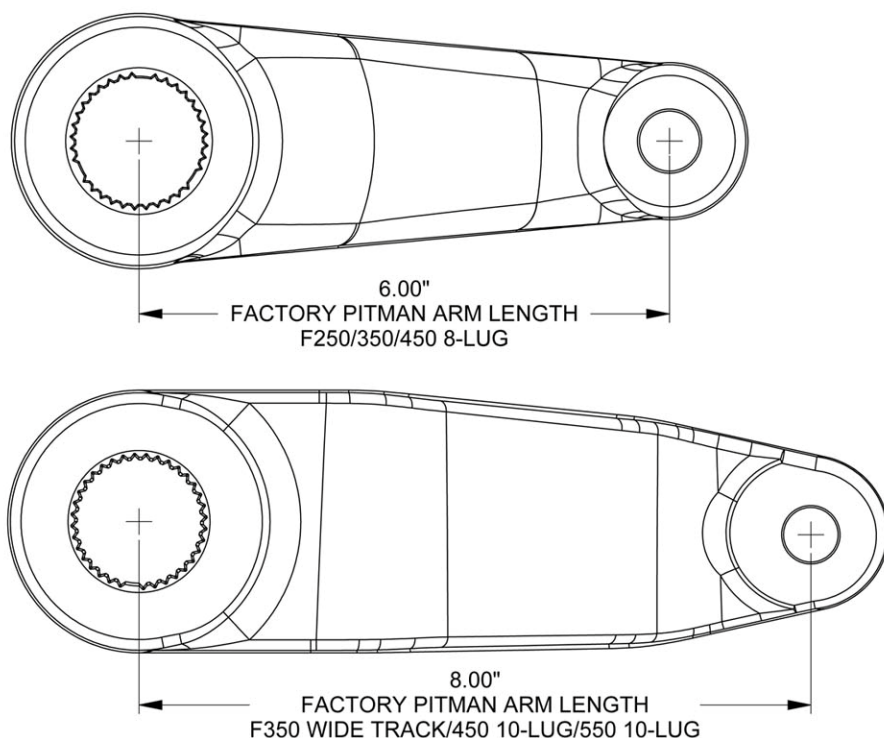

CALL FABTECH FOR ADDITIONAL INFORMATION.

LIFT INSTRUCTIONS:

1. Disconnect the negative terminal on the battery. Jack up the front end of the truck and support the frame, at the front frame rails, with jack stands. **NEVER WORK UNDER AN UNSUPPORTED VEHICLE.** Remove the front tires.
2. Working from both sides of the truck, remove the brake calipers (**remove the caliper cage from the knuckle, do not remove the caliper from the caliper cage**) and tie them up out of the way. **DO NOT ALLOW THE CALIPERS TO HANG FROM THE BRAKE LINES!** Remove the brake line and ABS line tabs from the front side and the rear side of the coil spring mount on the axle and save the hardware.
3. Locate the ABS lines on the radius arms and disconnect it at its two mounting points. Use care not to damage the plastic clips on the ABS line as they will be reused, discard the bolt from the bracket
4. Supporting the front axle with two floor jacks, remove the front shocks and discard. Remove the sway bar end links from the axle mount and save with the hardware.
5. Lower the front axle allowing the coil springs to come free of tension. **EXERCISE EXTREME CAUTION WHEN WORKING WITH COIL SPRINGS UNDER LOAD!** Remove the coil springs from the truck and discard, save the factory upper coil isolator.
6. Remove the factory steering stabilizer from the frame mount and save the hardware. Remove the steering stabilizer frame bracket and save the hardware. Discard the frame bracket. Leave the steering stabilizer connected to the drag link. **SEE PHOTO BELOW.**



7. Remove the drag link from the pitman arm and save factory hardware. You will need to use a two jaw puller to remove drag link from the pitman arm. **USE CARE NOT TO DAMAGE THE THREADS ON THE DRAG LINK!**

8. Remove the trac bar from the frame bracket and save the original hardware. Remove the trac bar bracket from the frame and save the original hardware and discard the factory trac bar bracket. **SEE PHOTO BELOW**



9. Remove the factory pitman arm from the steering box using a large pitman arm puller or large two-jaw puller. Discard the hardware and the pitman arm. **SEE PHOTO BELOW.**



10. Locate FT30122 new drop pitman arm. Attach to the steering box in the same indexed position as the factory pitman arm was when removed. **Install the provided FT30258 Sector Shaft Nut and torque to 350 ft. lbs. (Note: this is a one-time only use nut, once it is tightened on the sector shaft and removed, it must be discarded)**
11. Locate FT30373BK Trac Bar Frame Bracket. Attach to the frame using the original hardware in the same position. Torque bolts to 110 ft. lbs. **DO NOT ATTACH THE TRAC BAR TO THE FRAME BRACKET AT THIS TIME.**

12. With the front axle still supported by the floor jacks remove both front factory radius arms from axle and factory frame mounts. Save the factory frame pivot bolts and the factory front pivot bolts and nut from the axle mounts.
13. Locate both FT30125BK and FT30126BK radius arms and install two of the supplied bushings and one of the supplied sleeves into each radius arm end. Use the supplied FTLUBE on all the bushing surfaces before installing them into the radius arms. Install one grease fitting into each end of the radius arms with the bushings.
14. Working from the driver side of the truck, Install FT30125, driver side radius arm onto the truck. First attach the radius arm to the axle mounts using the factory upper pivot bolt and nut and the supplied alignment cam on the lower pivot. Then attach the rear pivot to the factory mount on the frame and use the factory bolt. Leave loose at this time. SEE PHOTO BELOW.

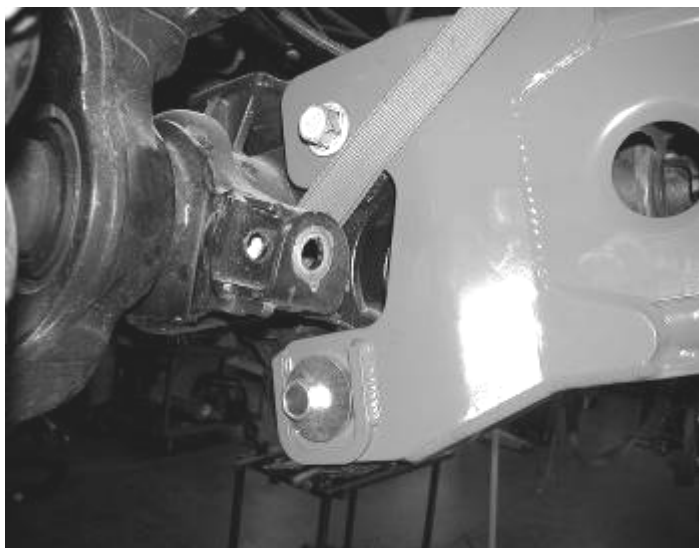

15. Repeat step fourteen on the passenger side of the truck.
16. Working from both sides of the truck, locate and remove the factory front bump stops and save. These can be removed by pulling on the bump stop itself free from the cup. Remove the factory mounting cup from the frame and discard the hardware. Locate FT30143 Drv. Side front bump stop drop brackets. Using a drill with a 7/16" drill bit, drill out the factory locator pin hole in the frame. Now attach the bump stop to the hole in the frame using the supplied 7/16" x 1 1/2" bolt, nut, and washer. Once attached and aligned with the frame drill the second hole with the 7/16" drill bit. Locate FT30144 Pass. Side and center on the bottom of the frame between the factory rivets. (Pass. side does not have a locating hole). Mark the two holes from the new bracket to the frame and drill the two holes. Attach the bracket to the frame with the supplied 7/16" hardware.
17. Locate the factory bumpstop cup and use a die grinder with a cut-off wheel to cut off the locating tab from the bottom. Attach the last hole with the supplied 7/16" x 1 1/2" hardware. Attach the factory bump stop cup to the new

bracket using the supplied 5/16" x 1 1/4" bolt, flat washer, and split washer. Before tightening the bolt, align the flat part of the bumpstop cup to the flat side of the drop bracket. Press the factory bump stop back into the cup. SEE PHOTOS BELOW

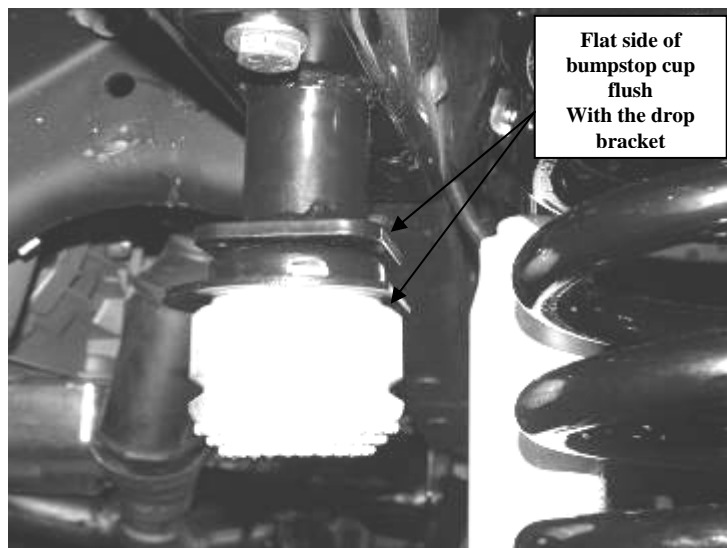
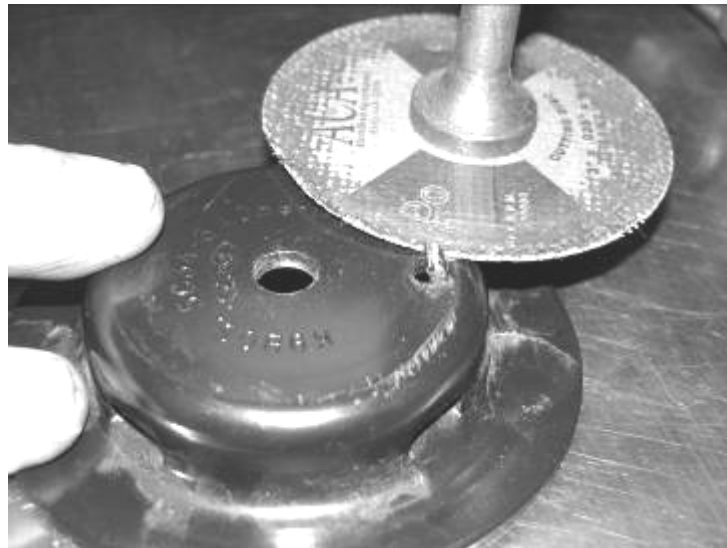

18. Using the coil springs from the 6" lift or 8" lift coil spring kit install the coil spring into the truck in the factory location using the original factory upper coil isolator. **IF INSTALLING A FABTECH COILOVER CONVERSION KIT SEE THE INSTRUCTIONS ENCLOSED WITH THE HOOP KIT AT THIS TIME.**
19. Torque the front and rear radius arm pivot bolts to 200 ft. lbs. **NOTE: SET THE ALIGNMENT CAMS IN THE LOWER FRONT RADIUS ARM IN THE MIDDLE OF ADJUSTMENT BEFORE TORQUING. MAKE SURE THE CAM IS SEATED INSIDE THE ALIGNMENT CAM GUIDES.**

IF INSTALLING A FABTECH DUAL SHOCK KIT, USE THE INSTRUCTIONS ENCLOSED WITH THE DUAL SHOCK KIT AND INSTALL AT THIS TIME.

20. Using a floor jack raise the front axle enough to compress the front coils approx. 1". Locate the correct front shocks FTS7188 for the 4" & 6" kit and FTS7189 for the 8" kit and install onto the truck. **Note: Some shock mounts will require cutting a 1/4" from the top of the factory shock tab. If required, use a die grinder with a cut-off wheel and remove the top 1/4" of the tab. Sand and paint bare/exposed metal. SEE PHOTOS BELOW**

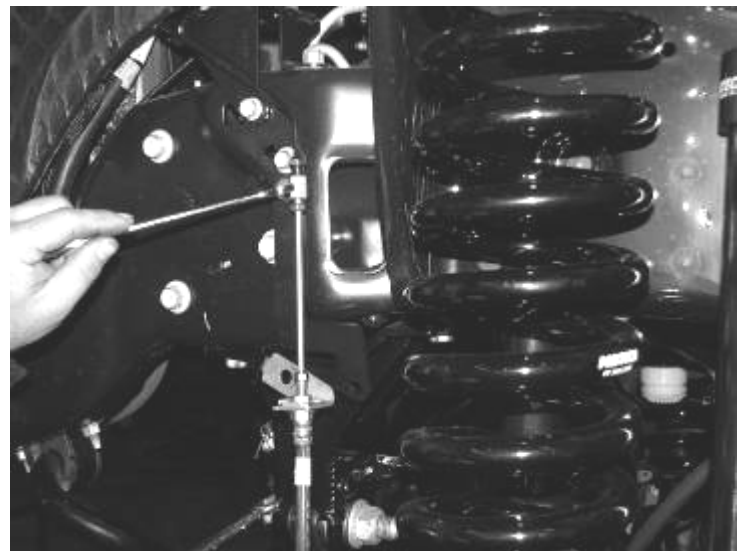

21. Locate the factory brake line mount on the front side of the frame. Remove the bracket from the frame and save the hardware. Locate (FT30276 Front Brake Line Drop Bracket 2008-2010) or the (FT30432 Front Brake Line Drop Bracket 2011-13) and attach to the frame using the original hardware in the factory brake line hole (with the offset of the bracket to the rear of the truck on 2008-2010).

Complete step 22 on 2008-13 models only.

22. Locate FT30409 Hard Brake Line Extension and separate the factory hose from the hard line. Install the supplied FT30410 union and hard line to the factory hard line. Move to step 26. SEE PHOTOS BELOW.

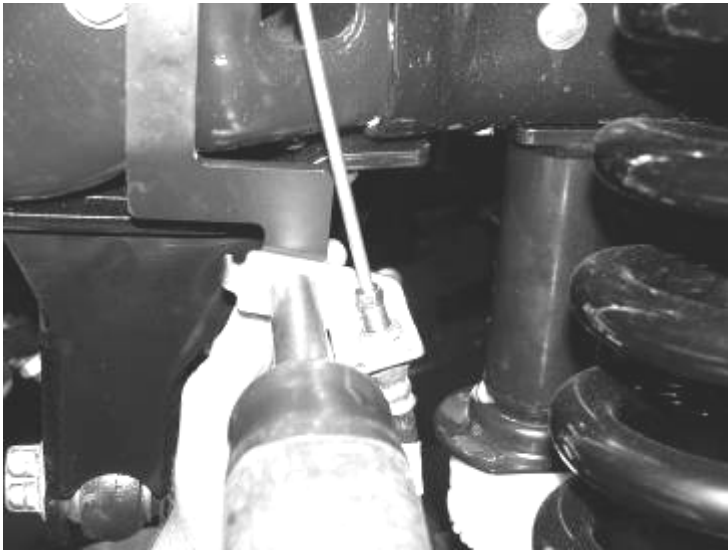

24. Using a die grinder remove the tang from the factory brake line bracket.

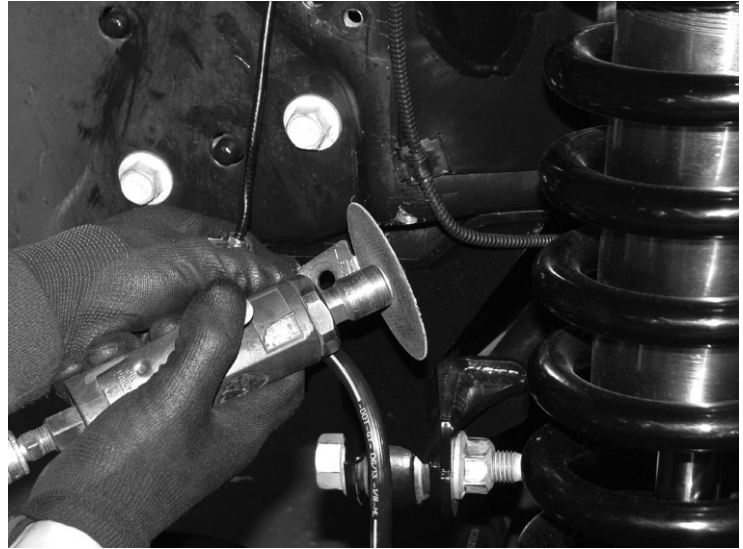

25. Move the bracket down 4" from the factory mounting hole . Using a 1/4" drill bit drill a new hole and remount the factory bracket using the supplied 5/16" self tapping screw. Torque to 14 ft-lbs. Move to step 26.

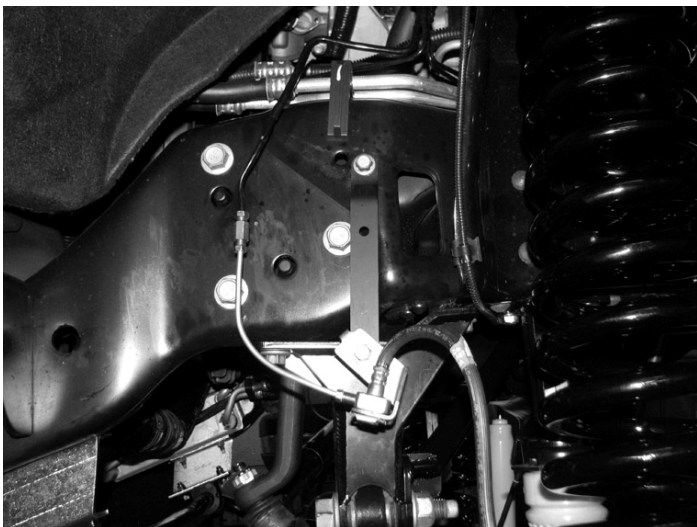

2011 Brake line bracket (FT30432) shown above

Complete step 23-25 on 2014 models only.

23. Remove the bolt holding the brake line to the frame and straighten out the factory hard line.

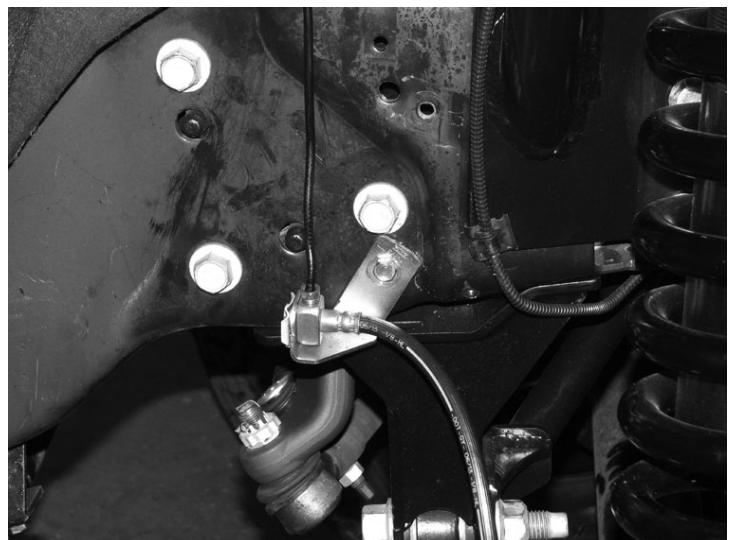
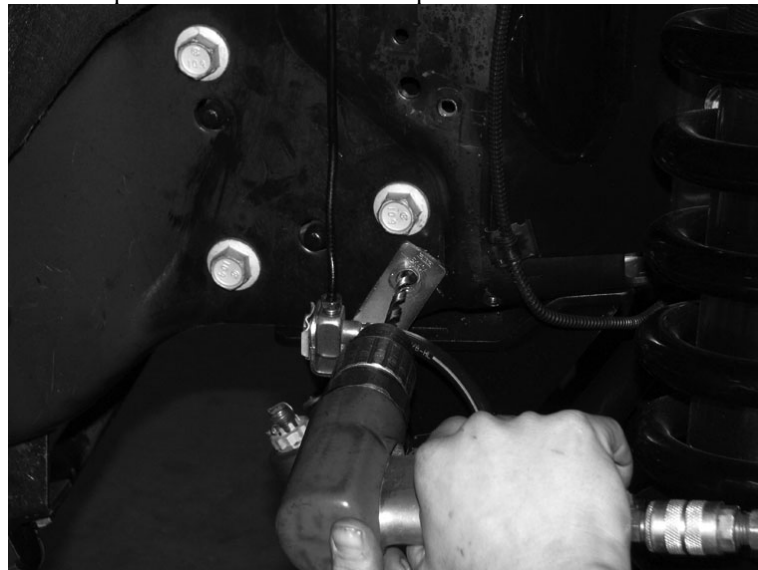
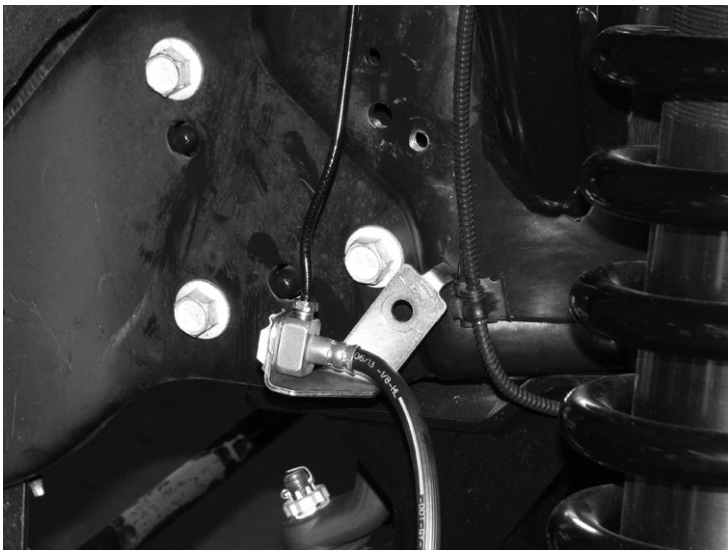

Continue with Step 26 for all models.

26. Working on the driver side, disconnect the four wheel drive vacuum line from the front brake line bracket and reposition and reconnect behind the coil spring mount. Follow the 4wd vacuum line up to the 120 degree connector and remove it from the line and re-connect the lines with the existing line splint. Attach the vacuum line to the ABS line at the coil mount with 2 of the supplied zip ties and attach the vacuum line to the front differential vent hose with 2 more zip ties. **(this keeps all the lines in place during suspension travel, failure to follow this step could cause ABS and / or 4wd failure).** SEE PHOTOS BELOW.

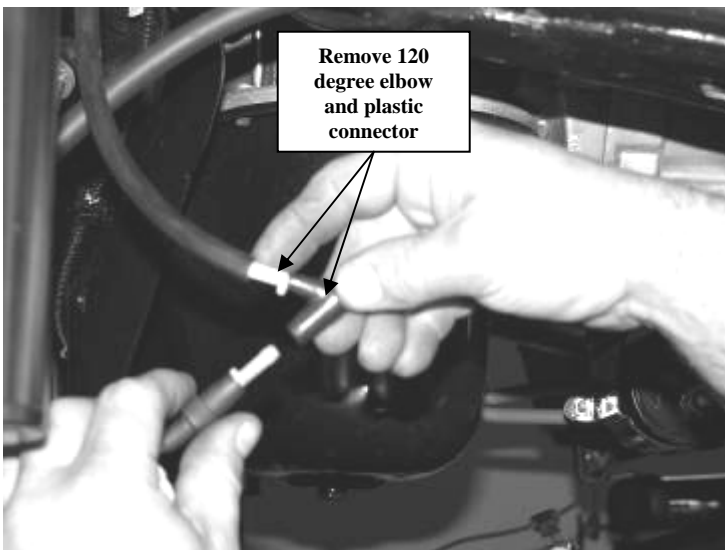

27. Locate FT30277 ABS Line Bracket, the supplied 1/4" hardware, and adel clamp. Locate the hole on the radius arm and attach the line bracket to the radius arm in the middle hole. Now mark and drill the bottom hole in the line bracket to the radius arm. Install the 1/4" hardware into the bottom hole. Remove the ABS socket connector from the frame and re-connect the ABS line. Install the factory front ABS

mount onto the front of the radius arm. Place the provided adel clamp onto the ABS line mount (this may need to be moved) and attach to the new bracket with the supplied 1/4" hardware SEE PHOTOS BELOW.

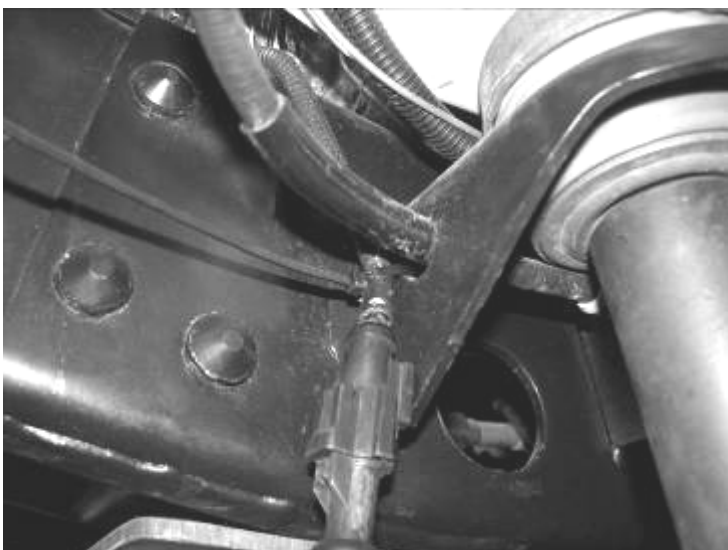
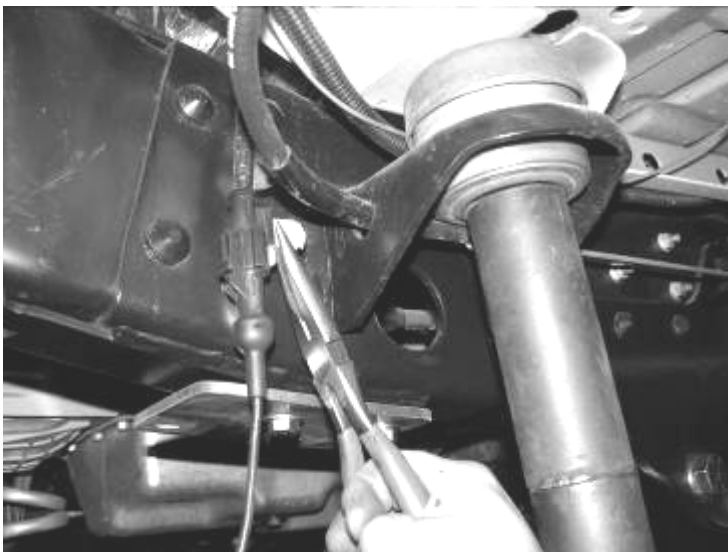

28. Locate FT30402 (08-10) or FT30583BK (11-UP) steering stabilizer drop bracket and install in the factory location

using the original hardware. Torque to 50 ft. lbs. Reattach the factory stabilizer to the frame bracket using the original hardware unless installing on 11-UP model use M12 hardware. If installing a Fabtech stabilizer do so at this time. SEE PHOTO BELOW.



Picture Shown with Factory Stabilizer re-installed



29. Remove the front sway bar from the frame mounts and save the hardware. **(15-UP)** Install FT30629 (Driver) and FT30630 (Pass) using the the supplied 7/16 hardware.

(08-14 Models) Install FT3400-112D & P sway bar drop brackets and attach to the frame (AS SHOWN IN PHOTOS) where the sway bar was originally attached using the factory hardware. **MOUNT THE DRIVER SIDE BRACKET ON THE PASSENGER SIDE, AND THE PASSENGER SIDE ON THE DRIVER SIDE.**

Using the supplied 7/16" X 1 1/4" hardware, attach the sway bar to the new drop brackets. Reattach the factory sway bar end links to the axle mounts using the original hardware (Torque to 40 ft. lbs. once the truck is on the ground; do not tighten while the suspension is in the air). The new drop brackets are slotted at both mounting points. For the 4" & 6" lift, position the frame mount and sway bar all the way forward toward the front of the truck and torque to 35 ft. lbs. For the 8" lift, position the frame mount and sway bar all the way rearward toward the back of the truck and torque to 35 ft. lbs. SEE PHOTO BELOW.



View of outer driver side frame rail



View of inner passenger side frame rail

30. Position the factory trac bar into the new trac bar bracket. Note: You may need to raise the axle up or down to align the hole. Using the original bolt insert it from the front side of the bracket towards the back. Do not push the bolt fully through at this time.
31. Locate FT30273 trac bar support bracket. First attach it to the forward motor mount bolt on the driver side of the truck, and then line the other end up the trac bar bolt. Torque the factory motor mount bolt to 55 ft. lbs and the trac bar bolt to 400 ft. lbs. SEE PHOTO BELOW.



32. Refer to owner's manual for proper brake bleeding procedure
33. Install front tires and wheels. Torque lug nuts to wheel manufacturer's specifications.
34. Re-check all front hardware at this time for correct torque tightness. Torque the sway bar hardware and endlinks at this time.
35. Check the front brake lines and ABS line at this time for proper clearance from all moving parts. You will want to steer the wheels from left to right to make sure the lines clear the wheels. Check fender to tire clearance, trim as needed. Adjust the front headlights.
36. Complete a full alignment on the truck.
37. **RETORQUE ALL NUTS, BOLTS AND LUGS AFTER 500 MILES.** Re-adjust headlights.

REAR LIFT

SEE THE INSTRUCTIONS ENCLOSED IN THE REAR LIFT BOX KIT.

RETORQUE ALL NUTS, BOLTS AND LUGS AFTER 50 MILES AND PERIODICALLY THEREAFTER.