



INSTALLATION INSTRUCTIONS

2010-17 TOYOTA 4RUNNER 4WD 6" BASIC & PERFORMANCE SYSTEMS

FT26080i

2015 Toyota 4 Runner Brake Caliper Bolt

Prior to ordering a Fabtech suspension for a 2015 Toyota 4 Runner, the vehicle must be evaluated for the size of front brake caliper bolt. The 2015 model has two different sized caliper bolts, M12-1.25 or M14-1.5. The caliper bolt on the vehicle must be measured or identified with the VIN through a Toyota dealership. Order the appropriate Fabtech suspension system based on caliper bolt size.

- PARTS LIST -

FTS26080		COMPONENT BOX 1 (2010-2015)
1	FTS70234D	Spindle (Driver)
1	FTS70234P	Spindle (Passenger)
2	FT70123	Tie Rod End
1	FT70242	Sway Bar Drop (Driver)
1	FT70243	Sway Bar Drop (Passenger)
2	FT70094	Body Mount Weld In Plate
1	FT70241	Hardware Kit
1	FT70244	Hardware Subassembly

FTS26081		COMPONENT BOX 2
1	FT70053	Lower Diff Bracket (Driver)
1	FT70054	Lower Diff Bracket (Passenger)
1	FT70056BK	Bump Stop Mount (Driver)
1	FT70057BK	Bump Stop Mount (Passenger)
1	FT70058BK	Skid Plate
2	FT70098	Crossmember Weld in Plate
1	FT70162BK	Front Crossmember
1	FT70240	Rear Crossmember

FTS26093		COMPONENT BOX 1 (2016-UP)
1	FT70260D	Spindle (Driver)
1	FT70260P	Spindle (Passenger)
2	FT70123	Tie Rod End
1	FT70242	Sway Bar Drop (Driver)
1	FT70243	Sway Bar Drop (Passenger)
2	FT70094	Body Mount Weld In Plate
1	FT70241	Hardware Kit
1	FT70244	Hardware Subassembly

FTS26082		REAR BOX KIT
1	FT50089	Sway Bar Sleeve Kit
1	FT50116	Sway Bar Bushing Kit
2	FT70084BK	Upper Link Arm D/P
2	FT70085BK	Lower Link Arm D/P
1	FT70245	Coil Spacer
1	FT70088BK	Trac Bar Bracket
1	FT70089	Brake Line Bracket
2	FT70090BK	Sway Bar End Link
1	FT70092	Rear Bushing Kit
2	FT70246	Rear Bump Stop Bracket
1	FT70096	Trac Bar Bracket Nut Tab
2	FT83239	Rear Shock Spacer
2	FT83267	Rear Shock Bushing

FT70244		HARDWARE SUBASSEMBLY
1	FT90087	Bushing Kit
1	FT26080i	Instruction Sheet
2	FT70061	Front Brake Line Bracket
1	FT70063	Spindle Brake Line Bracket (Driver)
1	FT70064	Spindle Brake Line Bracket (Passenger)
2	FT70102	Sway Bar Hat
2	FT70105	Sway Bar End Link
6	FT70159	Mis-Alignment
4	FT95023	1/2" Heim
2	FTS88	Bumpstop
1	FTAS12	Sticker FT Blue 10X4
1	FTAS16	Driver Warning Decal
1	FTREGCARD	Registration Card
1	FTLUBE	Urethane Grease

FTS26010BK		COIL SPACER KIT
2	FT70055BK	Coil Spacer

FT70241		HARDWARE KIT
	BAG 1	
2	3/4"-10 x 4 1/2" Bolt	Front Crossmember
2	3/4"-10 C-Lock	
4	3/4" SAE Flat Washer	
2	1/2"-13 x 4" Bolt	Diff Mounts
2	1/2"-13 C-Lock	
4	1/2" SAE Flat Washer	
2	9/16"-12 x 5" Bolt	Rear Crossmember
2	9/16"-12 C-Lock	
4	9/16" SAE Flat Washer	
2	5/16"-18 x 1 1/4" Bolt	Diff Skid Plate
4	5/16"-18 C-Lock	
8	5/16" SAE Flat Washer	
1	1/2"-13 1 1/2" Bolt	
1	1/2"-13 C-Lock	
2	1/2" SAE Flat Washer	
1	Thread Locking Compound	
	BAG 2	
6	3/8"-16 C-Lock	Coil Spacers
6	3/8" SAE Flat Washers	
8	1/8" Cotter Pin	
2	5/16"-18 x 1" Hex Bolt	Front Brake Line Drop
7	Clamp	
12	1/4"-20 x 3/4" Hex Bolt	ABS & Brake Line
12	1/4" Lock Washer	
12	1/4" SAE Washer	
	BAG 3	
2	M10-1.25 x 25mm Bolt	
2	M10 Flat Washer	
2	3/8"-16 Nyloc	Bump Stop
2	3/8" SAE Flat Washer	
4	3/8"-16 x 1 1/4" Bolt	Sway Bar & Bracket
4	3/8"-16 x 1 1/4" Bolt	Bump Stop Bracket
4	3/8"-16 C-Lock	
8	3/8" SAE Flat Washer	
4	3/8"-16 C-Lock	
8	3/8" SAE Flat Washer	
2	3/8-16 x 2-1/2" Button head	Sway Bar End Link (Bottom)
2	3/8-16 x 3" Hex Bolt	Sway Bar End Link (Top)
4	1/2" Jam Nut	
2	M12-1.25 x 25mm Bolt	Sway Bar Bracket
2	M12 Washer	

	BAG 4	REAR
4	M8-1.25 x 30mm Bolt	
4	M8 Split Washer	
4	M8 Flat Washer	
10	3/8"-16 x 1 1/4" Bolt	Coil Spacers
8	3/8"-16 C-Lock Nut	
18	3/8" SAE Flat Washer	
2	3/8" Lock Washer	
1	9/16"-12 x 3 1/2" Bolt	Trac Bar Bracket
1	9/16"-12 C-Lock Nut	
2	9/16" SAE Flat Washer	
1	1/2"-13 x 1 1/2" Bolt	
1	1/2" Split Washer	
1	1/2" SAE Flat Washer	
2	5/16"-18 x 3/4" Bolt	Brake/ E-Brake Cable Bracket
2	5/16"-18 C-Lock Nut	
4	5/16" SAE Flat Washer	
2	3/8"-24 C-lock Nut	
2	M12-1.75 x 70mm Bolt	Sway Bar End Link
2	M12-1.75 C-Lock Nut	
6	1/2" USS Flat Washer	
8	Grease Fitting 1/4-28	Rear Links



- PRE-INSTALLATION NOTES -

Read this before you begin installation-

Check all parts to the parts list above before beginning installation.

Read all instructions thoroughly from start to finish before beginning the installation. If these instructions are not properly followed severe frame, driveline and / or suspension damage may occur.

Check your local city and state laws prior to the installation of this system for legality. Do not install if not legal in your area.

Prior to the installation of this suspension system perform a front end alignment and record. Do not install this system if the vehicle alignment is not within factory specifications. Check for frame and suspension damage prior to installation.

The installation of this suspension system should be performed by two professional mechanics.

Use the provided thread locking compound on all hardware.

Do not combine this suspension system with any other lift device or parts.

This suspension must be installed with Fabtech shock absorbers.

WARNING- Installation of this system will alter the center of gravity of the vehicle and may increase roll over as compared to stock.

Kit does not fit models with factory electronic controlled shocks.

If installing the optional Dirt Logic coilover, record the ride height of the vehicle so that the proper ride height can be done when completed.

Welding Required

Verify differential fluid is at manufactures recommended level prior to kit installation. Installation of the kit will reposition the differential and the fill plug hole may be in a different position. (For example, if the manufacture recommends 3 quarts of fluid, make sure the diff has 3 quarts of fluid). Check your specific manual for correct amount of fluid.

Recommend Tires and Wheels:

Use 35/12.50R17 tire w/ 17x9 wheels w/ 4-3/4" BS w/ minor trimming

Use 35/12.50R18 tire w/ 18x9 wheels w/ 4-3/4" BS w/ minor trimming

Use 35/12.50R20 tire w/ 20x9 wheels w/ 5" BS w/ minor trimming

FOOTNOTES:

- KIT DOES NOT FIT MODELS WITH FACTORY ELECTRONIC CONTROLLED SHOCKS
- WILL NOT FIT TRD PRO MODELS
- DOES NOT WORK WITH KDSS SWAY BAR SYSTEM

- TOOL LIST -

Required Tools (Not Included)
Floor Jack
Jack Stands
Assorted Metric and S.A.E sockets
Drill and Drill Bits
Welder
Torque Wrench
Sawzall or Die Grinder
Press
Coil Spring Compressor

- INSTRUCTIONS -

FRONT SUSPENSION

1. Disconnect the negative terminal on the battery. Jack up the front end of the truck and support the frame rails with jack stands. **NEVER WORK UNDER AN UNSUPPORTED VEHICLE!** Remove the front tires.
2. Working from both sides of the truck, locate and remove the factory skid plate and brackets. Discard skid plate and hardware, these will not be reinstalled on the truck. **SEE FIGURE 1**

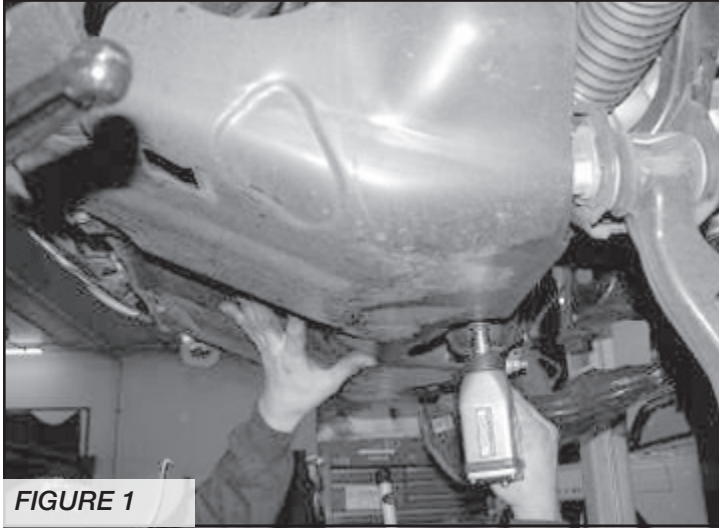

FIGURE 1

3. Remove factory mud flaps off front of the vehicle and discard.
4. Remove the nut from the tie rod ends. Disconnect the tie rod ends from the steering knuckle by striking the knuckle with a large hammer to dislodge the tie rod end. Use care as to not hit the threads on the tie rod end with the hammer as you will damage them. Save all hardware. **SEE FIGURE 2**

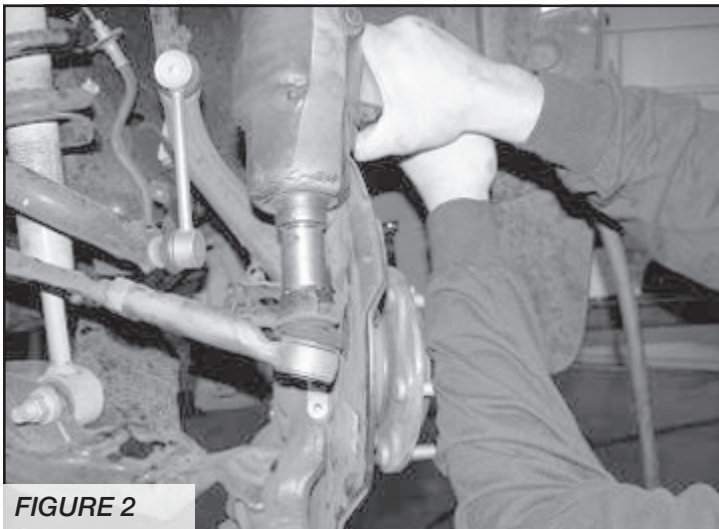

FIGURE 2

5. Remove the sway bar end links from the factory steering knuckles and leave connected to the bar. Then remove the bar from the truck. Save the bar and end links with all hardware. **SEE FIGURES 3-4**

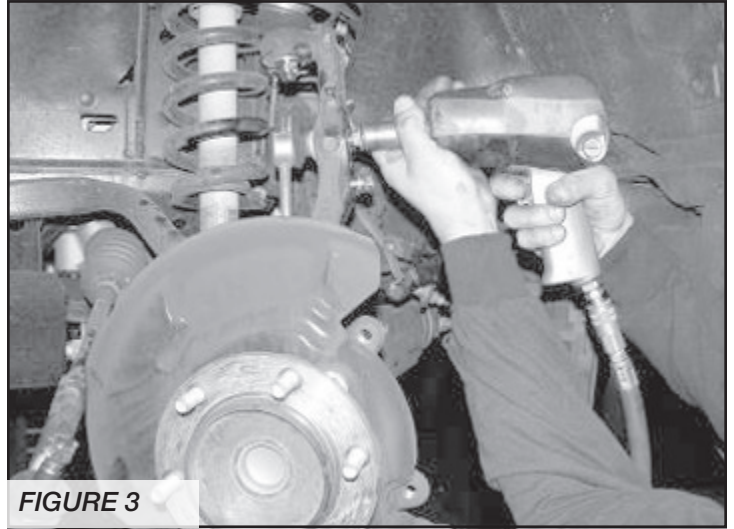

FIGURE 3

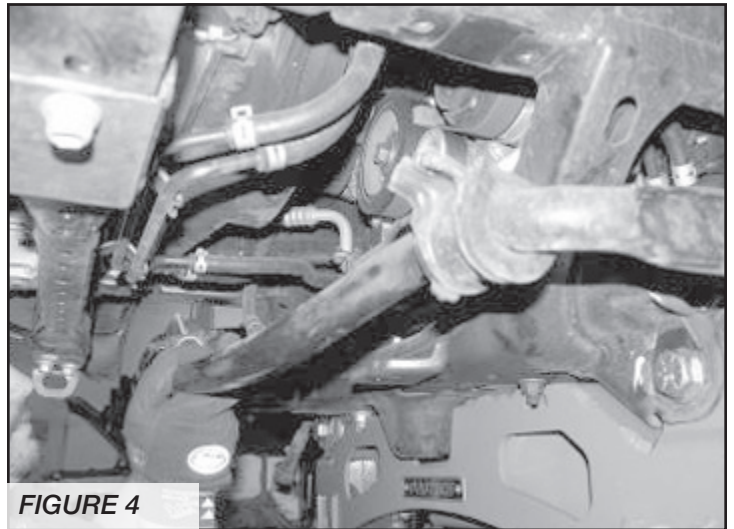

FIGURE 4

6. Remove the brake caliper from the steering knuckle and hang out of the way. Do not allow the brake caliper to hang from brake line. Remove the brake line brackets from the knuckle. Trucks equipped with ABS brakes, unbolt the ABS line and disconnect from steering knuckle and the upper control arm. Remove the bracket from the ABS line and discard. **SEE FIGURE 5**

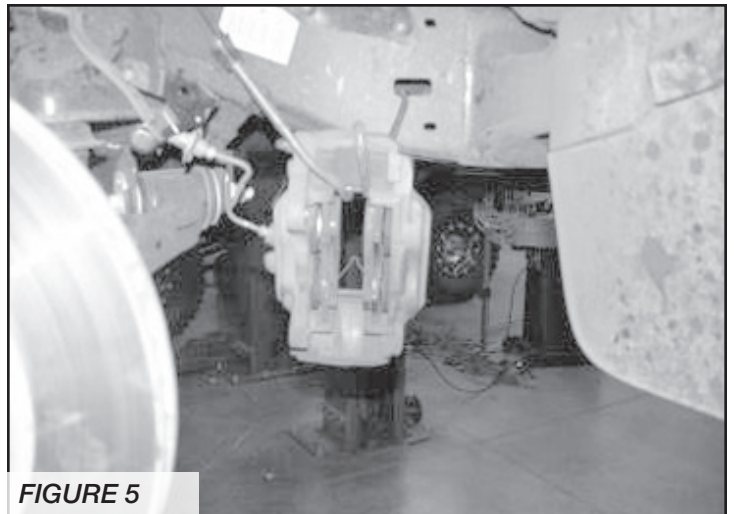

FIGURE 5

7. Remove the brake rotor, save all hardware.
8. Support the lower A-Arm with a floor jack. Loosen the upper ball joint nut. Disconnect the upper ball joint from the upper control arm by striking the knuckle with a large hammer next to the ball joint to dislodge the ball joint. Use care not to hit the ball joint when removing.
9. Remove the castle nut and two bolts on each side connecting the lower ball joint assembly to the knuckle. Save the Castle nut, as you will reuse it. Remove spindle assembly from truck. Remove the lower section of the spindle still attached to the control arm by striking with a large hammer. Use care not to hit the ball joint.

SEE FIGURE 6



FIGURE 6

10. Remove the three upper nuts from the top of the strut assembly then the lower bolt from the strut at the lower control arm. Remove the shock assembly as one complete unit and save with the hardware if installing the Basic Kit (coil spacer) retain shock assembly, if installing Dirt Logic coilovers discard shock assembly.
- SEE FIGURES 7-8**

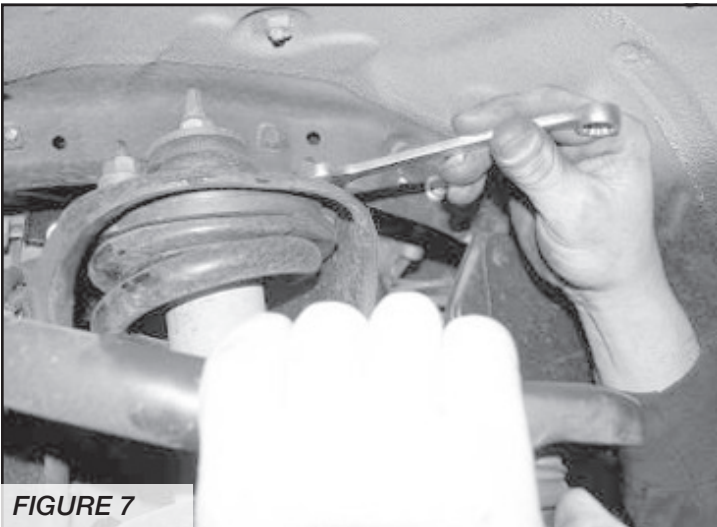

FIGURE 7

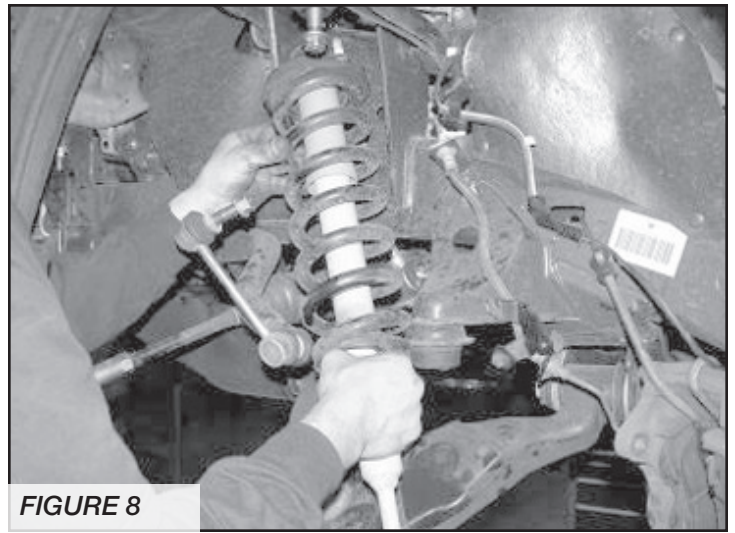

FIGURE 8

11. Remove and save the factory lower control arms with the hardware.
12. Disconnect the front driveshaft ONLY from the differential, do not disconnect from the transfer case. Save hardware. Do not allow driveshaft to hang freely.
13. Support the front differential with a transmission or floor jack. Disconnect all electrical, vacuum lines, and breather lines from the differential. Remove the rear differential nut and save as you will reuse it during assembly. Remove the two front differential bracket bolts from the frame. Discard the bolts, as you will not reuse them. **DO NOT SEPARATE THE C.V. AXLES FROM THE DIFFERENTIAL.** Remove the differential from the truck and set aside. **USE CARE WHEN REMOVING DIFFERENTIAL AS TO NOT DAMAGE THE C.V. AXLES and 4WD VACUUM ACTUATOR ASSEMBLY.** **SEE FIGURE 9**

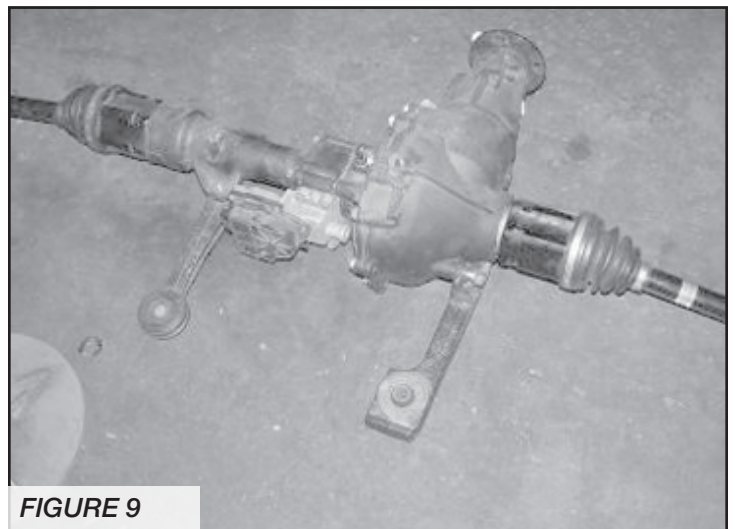
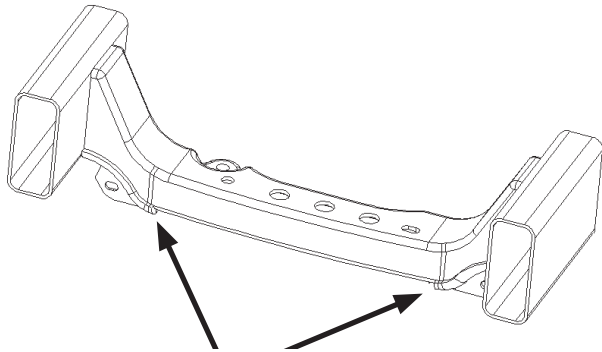

FIGURE 9

14. Locate the factory rear crossmember. Mark the crossmember 3 1/2" from outside edge of the cam pocket adjustment hole inward. On the top of the crossmember, locate the bottom hole and measure down 1/4", draw a line straight across the top of the crossmember and connect to the first line that is on the back of the crossmember. On the bottom of the crossmember, draw another line forward from the first line just beside the weld for the control arm pocket. Take care to cut the crossmember straight up and down and to not cut into the control arm pocket itself or cut out the weld. You will use a Sawzall or Die Grinder with a cutoff wheel to make these cuts. Remove the rear crossmember section. Cut and discard.

SEE FIGURES 10-14



CUT CENTER OF CROSSMEMBER ALONG
EDGE OF TAB MOUNTS ON BOTH SIDES

FIGURE 10

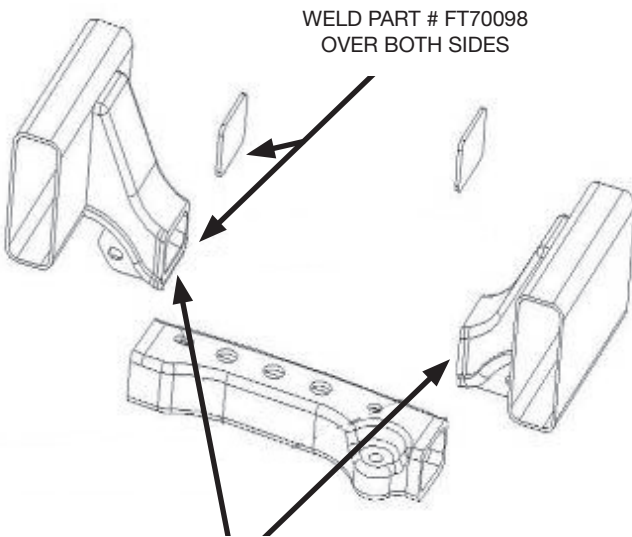

WELD PART # FT70098
OVER BOTH SIDES

CUT CENTER OF CROSSMEMBER ALONG
EDGE OF TAB MOUNTS ON BOTH SIDES

FIGURE 11

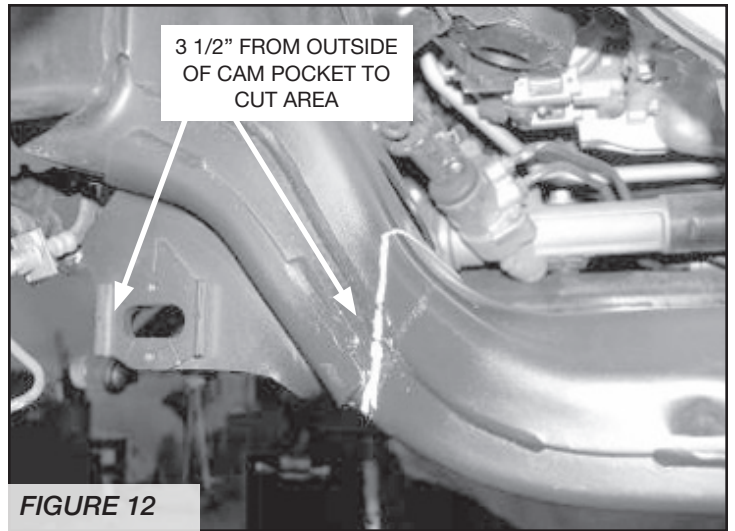

3 1/2" FROM OUTSIDE
OF CAM POCKET TO
CUT AREA

FIGURE 12

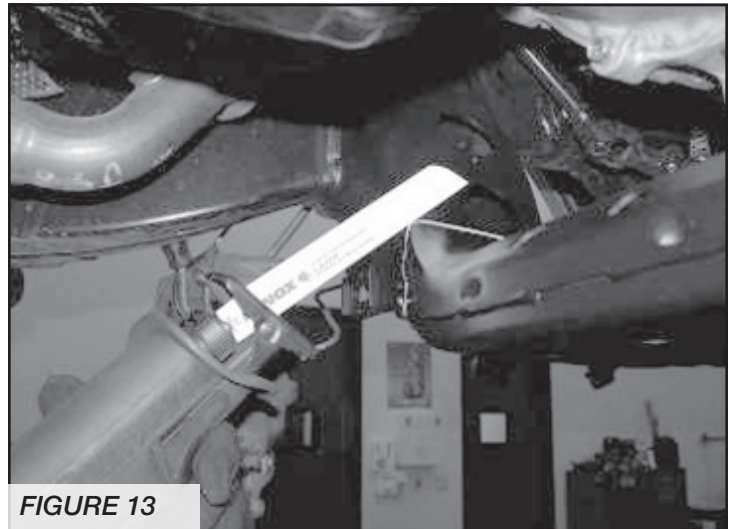

FIGURE 13



FIGURE 14

15. Locate FT70098 Weld in plate. You will need to weld in these plates to cover the holes made by cutting out the original cross member. Clean area to bare metal and weld in new plates. Let plate cool and paint with a corrosive resistant paint or under coating. **SEE FIGURES 15-17**



FIGURE 15

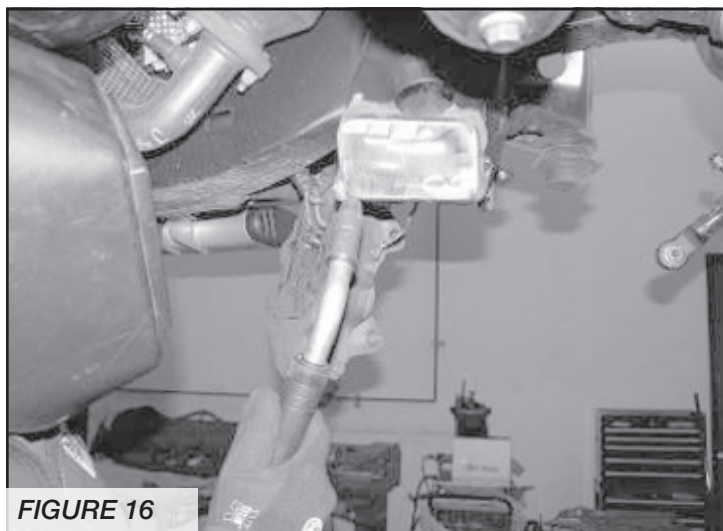

FIGURE 16

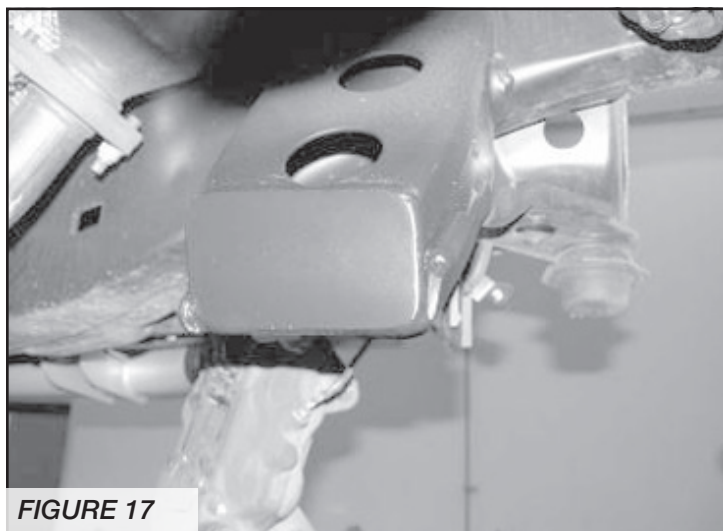

FIGURE 17

16. Working from the driver's side, mark the front frame section / body mount 5 3/4" from the face of the frame and the back at 8" from the frame. **SEE FIGURES 18-20**

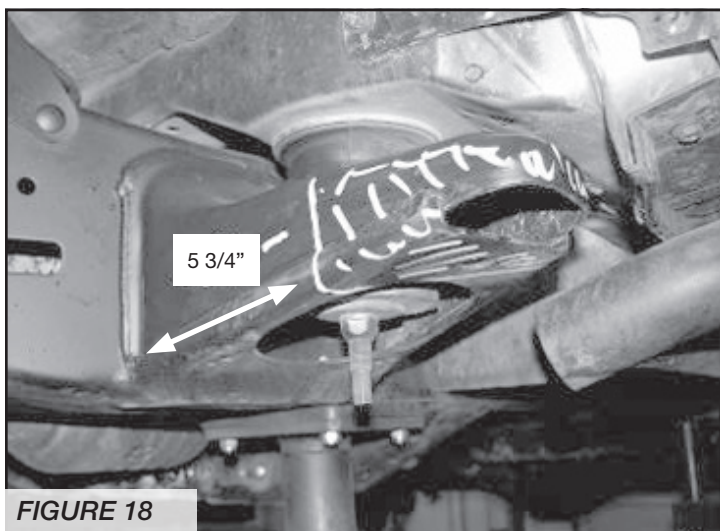

FIGURE 18

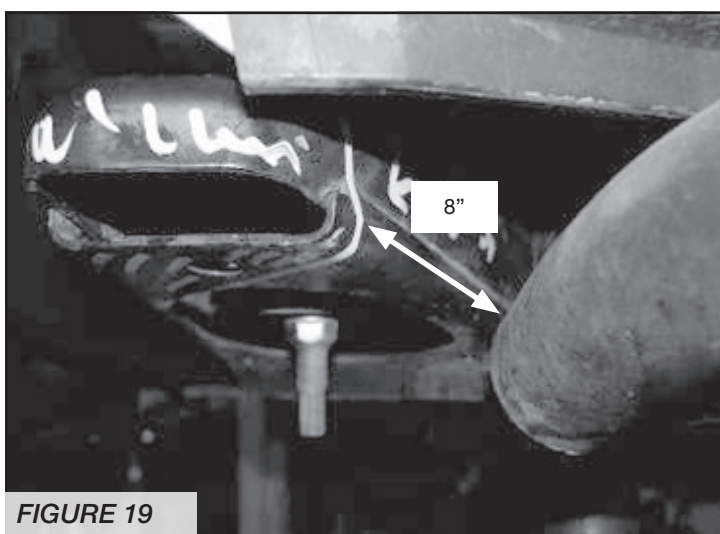

FIGURE 19



FIGURE 20

17. Use a sawzall and cut the marked area from the mount. Next, sand and clean the cut area on the mount. Locate FT70094 Weld-in Plate. Check fit the plate against the mount for proper fitment (it may be necessary to sand the mount for proper fitment of the plate). Weld the plate in and paint after it has cooled. **SEE FIGURES 21-24**

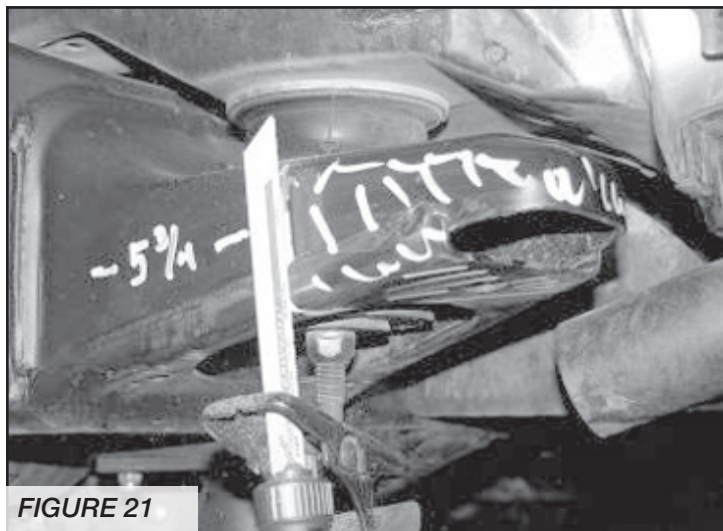

FIGURE 21

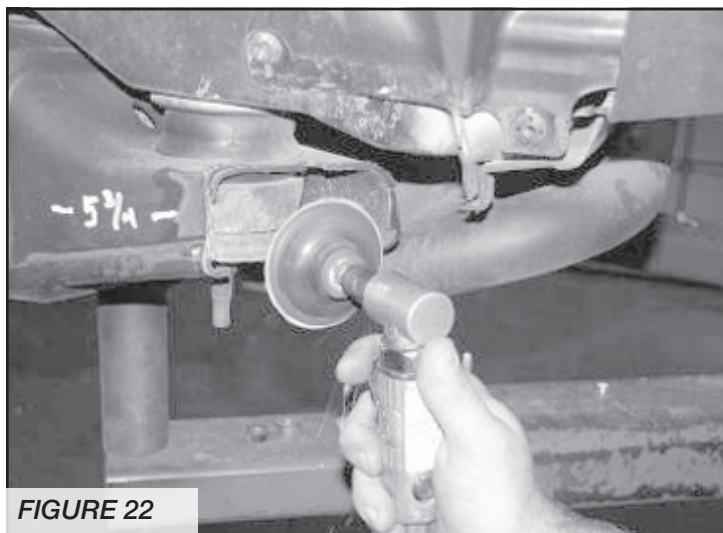

FIGURE 22

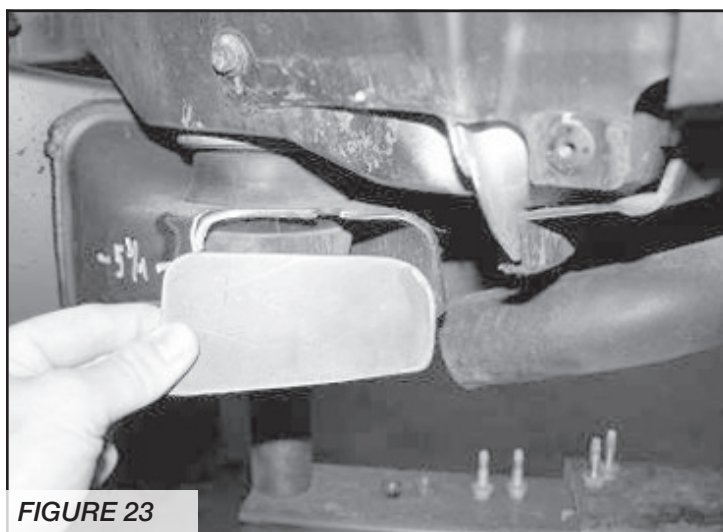

FIGURE 23

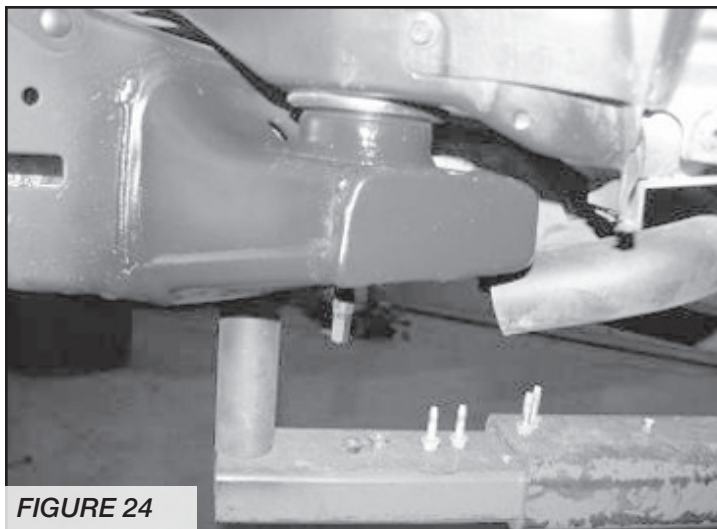

FIGURE 24

18. Locate the front differential and remove the factory front mounts. Discard the mounts and save the hardware. Locate FT70053 Driver Diff mount, FT70054 Pass Diff mount, and FT90087 Bushing and Sleeve Kit. Install the four bushings and the two sleeves into the new mounts. Using the factory hardware and some of the supplied thread-locking compound, mount the new diff mounts to the front differential. Torque the hardware to 75 ft. lbs. **SEE FIGURE 25**

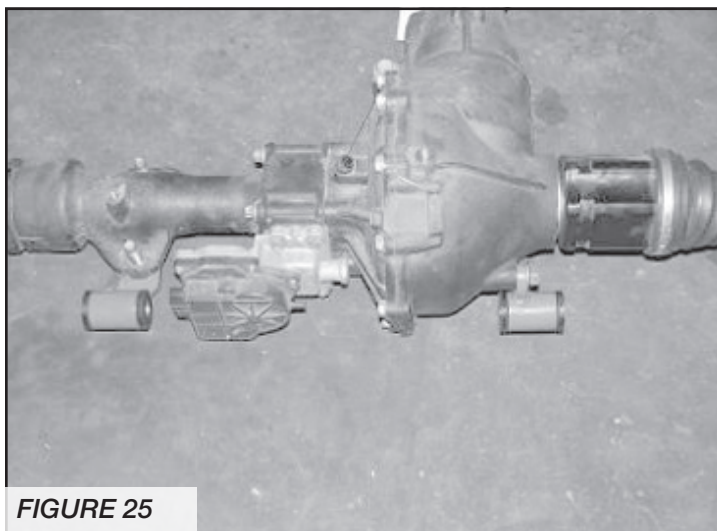
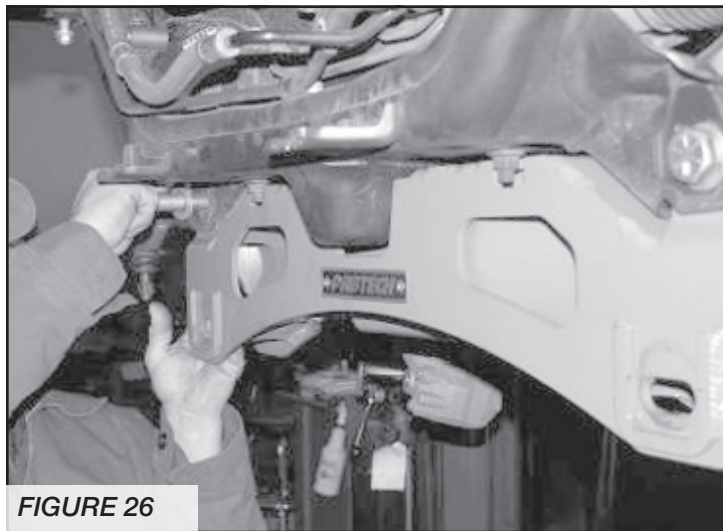
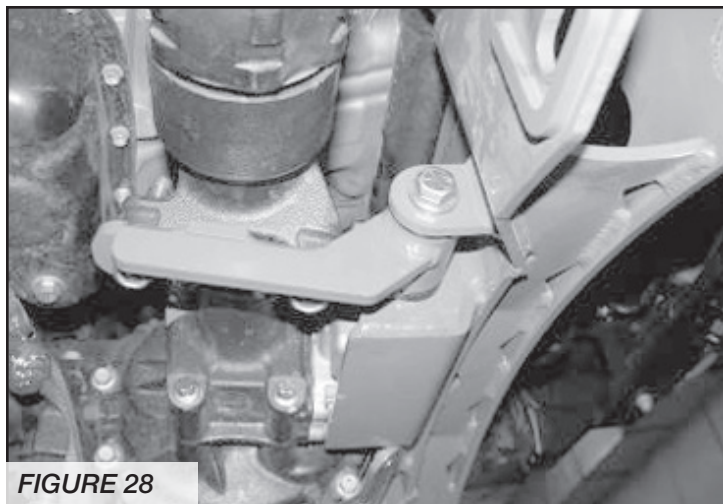
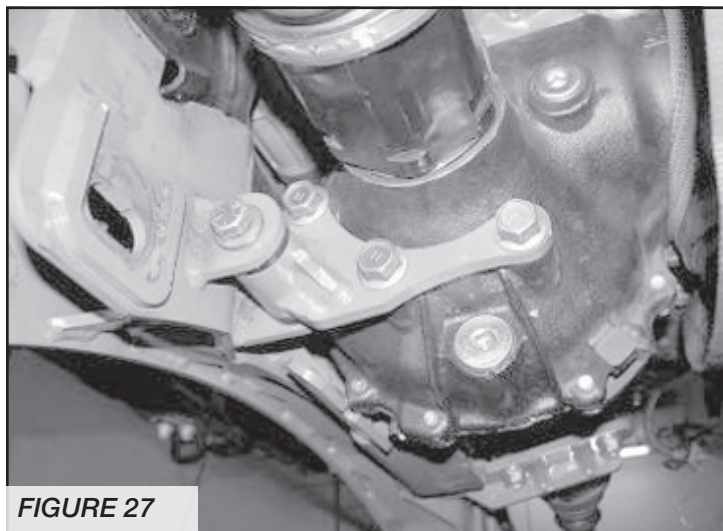

FIGURE 25

19. Locate the Fabtech front crossmember FT70162BK with the supplied $\frac{3}{4}$ " x 4-1/2" bolts, nuts, and washers (BAG 1), attach the crossmember to the factory control arm pockets, leave loose at this time. **SEE FIGURE 26**



20. Install the differential up onto the front crossmember with the supplied $\frac{1}{2}$ " x 4" bolts and hardware (BAG 1). Support the differential with a transmission jack. Leave loose at this time. **SEE FIGURES 27-28**



21. Locate the Fabtech rear crossmember FT70240 with the supplied $\frac{9}{16}$ " x 5" bolts, nuts, and washers (BAG 1). Install the crossmember to the factory control arm pockets. Leave loose at this time. Re-install the factory rear differential nut at this time. **SEE FIGURE 29**

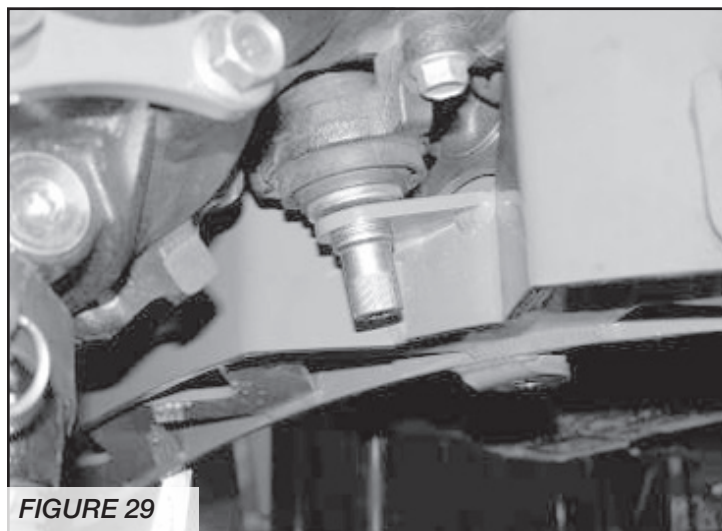

22. Locate the previously removed factory hardware for the front driveshaft and install with the supplied thread-locking compound on the bolts and torque to 50 ft lbs. Re-connect all electrical, vacuum lines, and breather lines back to the differential.
23. Install the factory lower control arms, using stock alignment bolts and hardware, set cams in the middle of their adjustment range and leave loose. **SEE FIGURE 30**

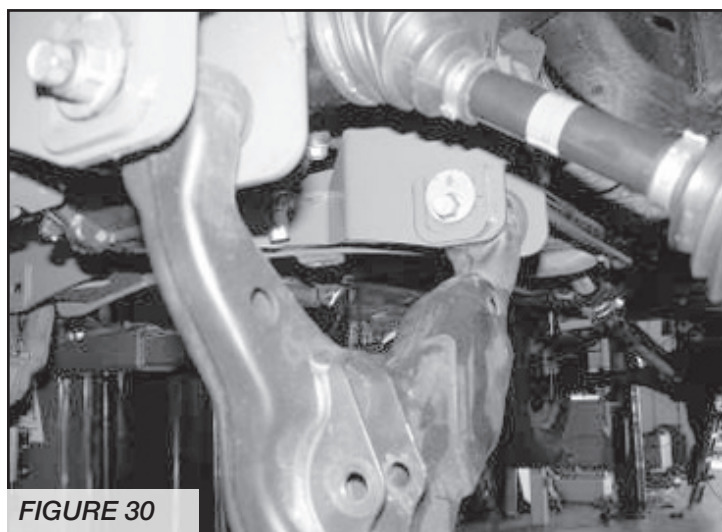

24. Locate FT70058BK skid plate. Attach using the supplied hardware (front mount) 5/16" x 1-1/4" bolts, nuts, and washers (rear mount) 1/2"x 1-1/2" bolt, nut, and washer. (BAG 1) Leave loose. **SEE FIGURE 31**

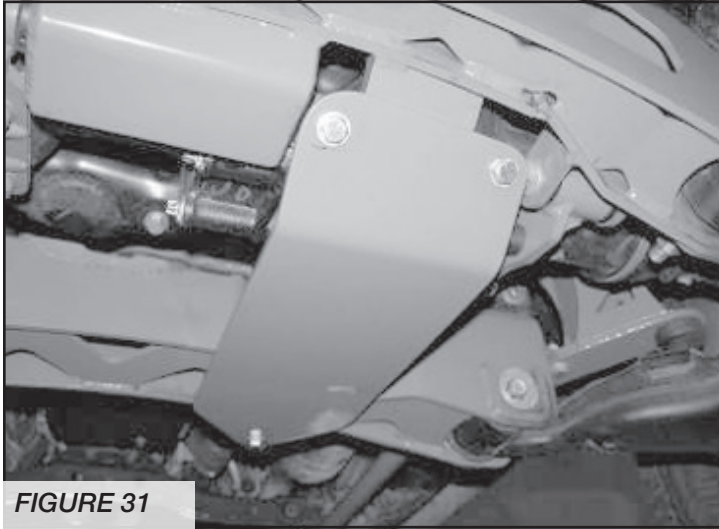

Follow Step 25 For The Basic System Or
Follow Step 26 For The Performance System.

25. Locate the factory shock assembly and hardware. Locate the FT70055BK Coil Spacers and supplied 3/8" C-Lock nuts and Washers (BAG 2). Position the spacer onto the top of the shock assembly so that the shortest side of the spacer is angled in towards the shock bucket on the vehicle and attach to the shock with the factory hardware. This must also align with the bottom mounting point of the shock assembly to mount into the lower control arm. Insert the shock assembly up into the bucket and attach with the supplied 3/8" hardware. Leave loose at this time. Place the bottom of the shock into the lower shock mount and attach with the factory hardware. Torque the top 3/8" hardware to 30 ft. lbs., factory hardware to 30 ft. Lbs., and the lower bolt to 100 ft. Lbs. **SEE FIGURES 32-33**

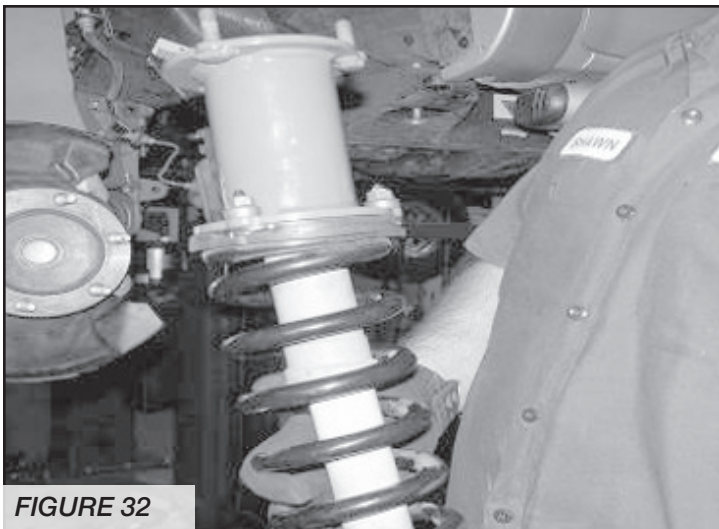
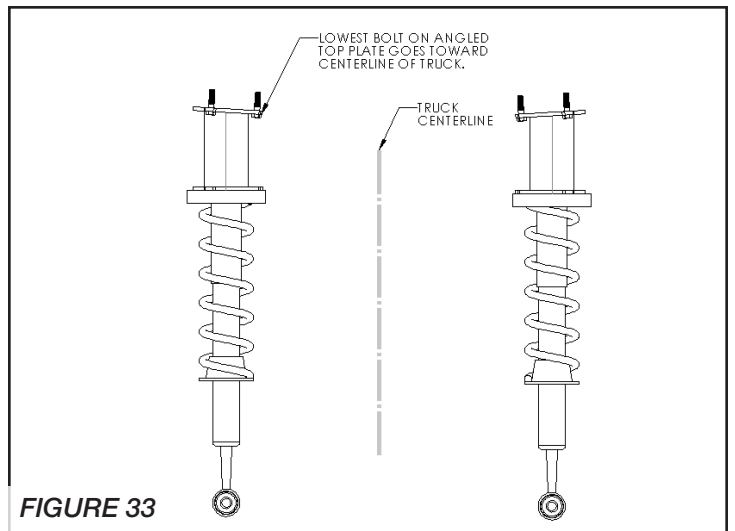
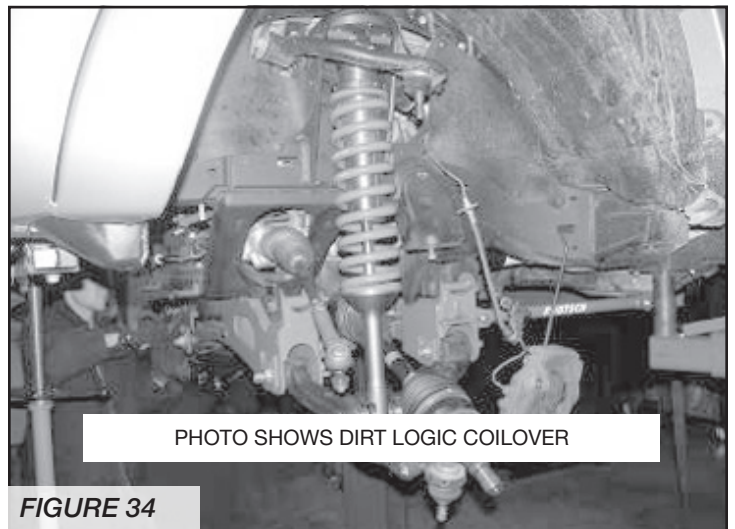

PHOTO SHOWS BASIC SPACER ON FACTORY STRUT



26. Locate and install FTS820152D or FT825152 Dirt Logic Coilover as described in the instructions enclosed with the coilovers. **SEE FIGURE 34**



27. Locate the factory steering knuckles and remove the hubs, backing plates, inner seal, and the dust covers. Locate the new Fabtech steering knuckles. Install the factory hubs, backing plates, factory inner seal, and the dust covers with the factory hardware and supplied thread-locking compound. Tighten to factory torque specs. **SEE FIGURES 35-38**

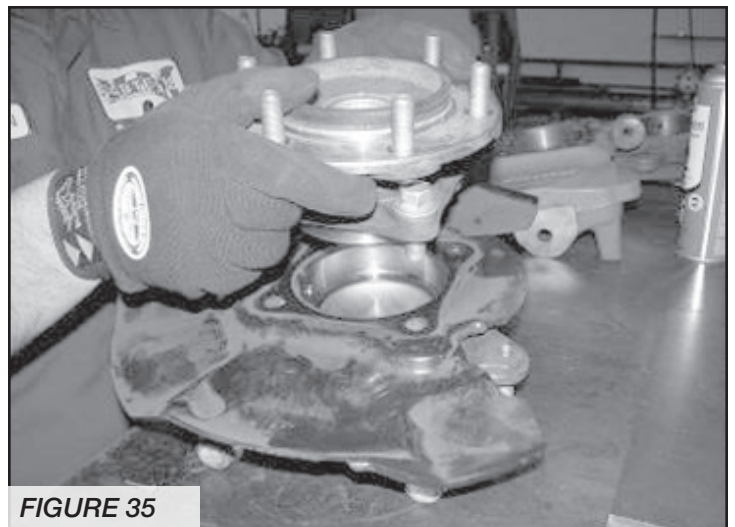



FIGURE 36

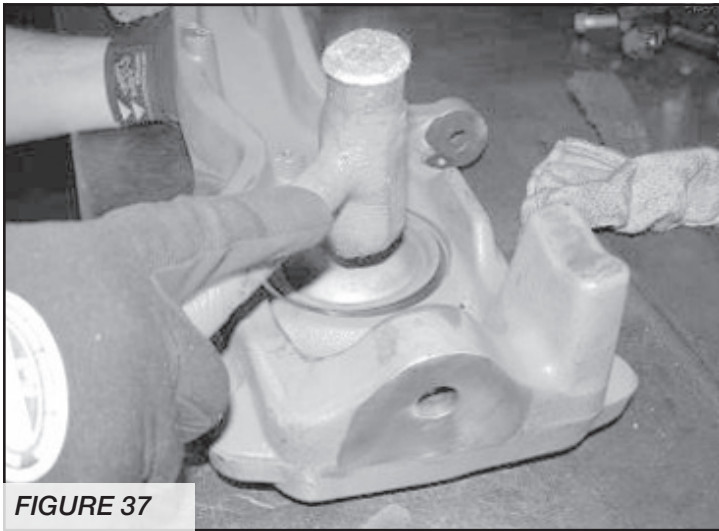

FIGURE 37

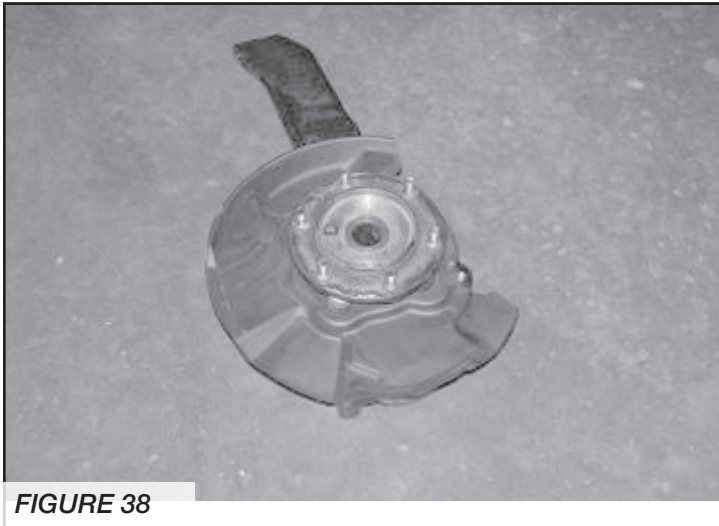

FIGURE 38

28. Support the lower arm with a floor jack and install the new assembled steering knuckle to the lower ball joint with the factory castle nut and supplied cotter pin. Raise the jack enough to locate the knuckle up into the upper ball joint (pull down on upper arm) and attach with the factory castle nut and supplied new cotter pin. Upper ball joint torque 81 ft-lbs. Lower ball joint 103 ft-lbs.

SEE FIGURE 39

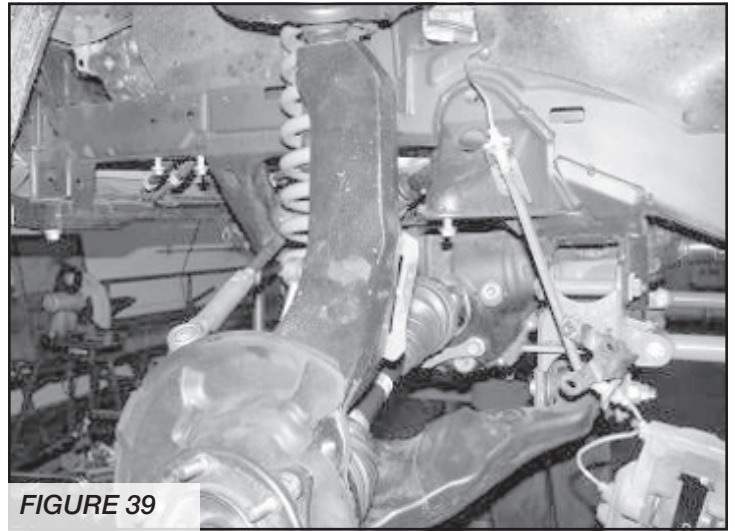

FIGURE 39

29. Torque factory control arm pocket bolts to 100 ft lbs., the $\frac{3}{4}$ " front crossmember bolts to 110 ft. lbs., the $\frac{9}{16}$ " rear crossmember bolts to 100 ft. lbs., the $\frac{1}{2}$ " differential mounts to 75 ft. lbs., the $\frac{1}{2}$ " skid plate bolt to 75 ft. lbs., and the $\frac{5}{16}$ " skid plate bolts to 20 ft. lbs.

30. Locate the factory brake line tab next to upper control arm. Unbolt the bracket from the frame save hardware and bracket. You will need to carefully pull the hard brake line down 4". Locate FT70061 brake line drop bracket and attach the bracket to the frame with the factory hardware in the upside down J formation. Attach factory bracket to the new bracket using the supplied $\frac{5}{16}$ " x 1" bolt, nut, and washers (BAG 2). **SEE FIGURE 40**

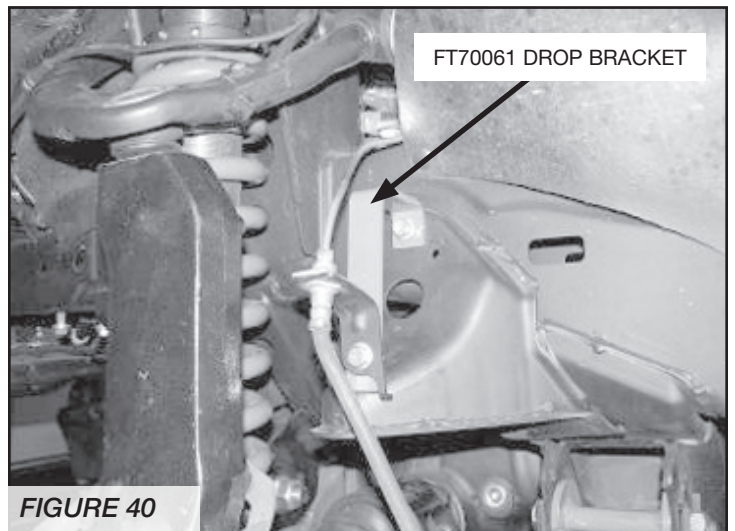

FIGURE 40

31. Locate FT70063 & FT70064 (drv. / pass.) spindle brake line bracket. Attach to the Fabtech knuckle using the supplied $\frac{1}{4}$ " x $\frac{3}{4}$ " bolts, washers, and split washers. Attach the factory bracket to the new brake line bracket using the supplied $\frac{1}{4}$ " x $\frac{3}{4}$ " bolt, washer, & split washer (BAG 2) **SEE FIGURES 41-44**



FIGURE 41

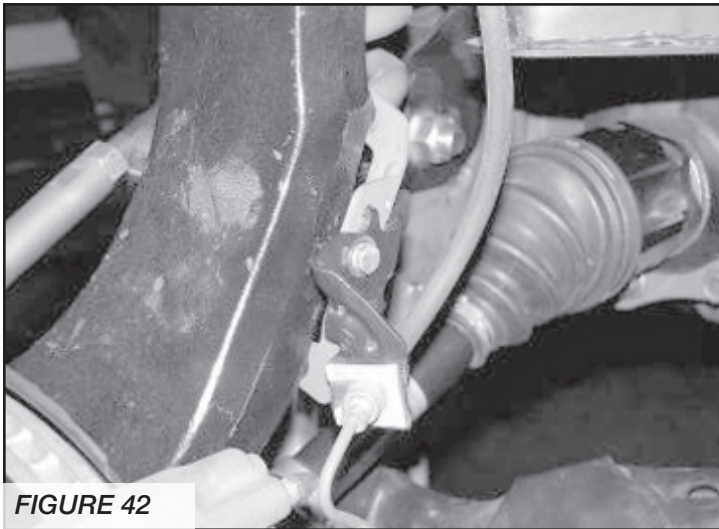

FIGURE 42

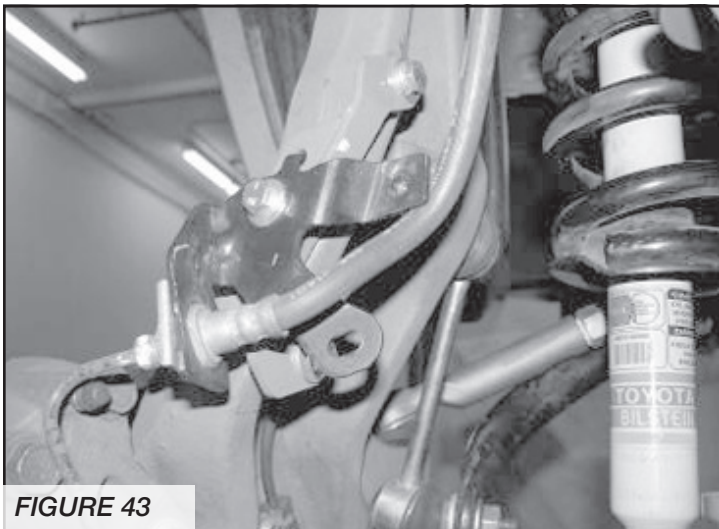

FIGURE 43



FIGURE 44

32. Install brake rotors & brake calipers with the factory hardware and thread lock compound. Route the ABS onto backside of the steering knuckle. There should be enough slack just inside the wheel well to pull the line down for the factory sensor to bolt into the new Fabtech steering Knuckle. Using the supplied adel clamps and the $\frac{1}{4}$ " x $\frac{3}{4}$ " bolts, washers, & split washers (BAG 2), reinstall the factory ABS Sensor into the Fabtech Knuckle. **SEE FIGURES 45-46**

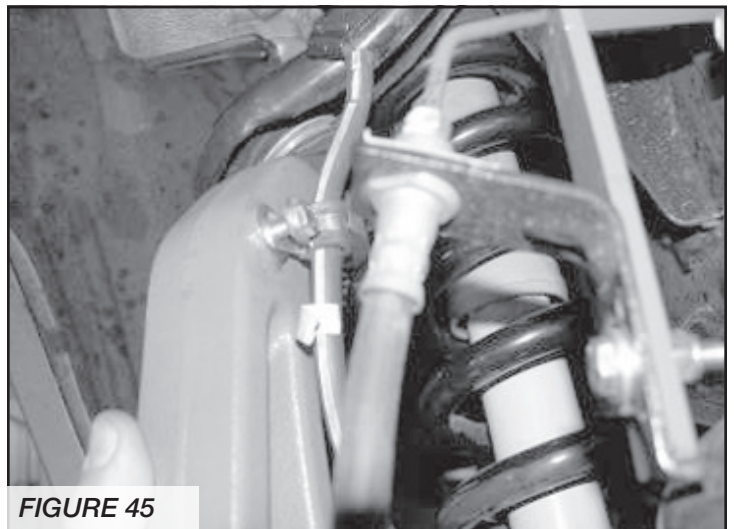

FIGURE 45

33. Install the new FT70123 (tie rod ends) with the with the supplied cotter pin. (torque the tie rod ends to 70 ft. lbs.)

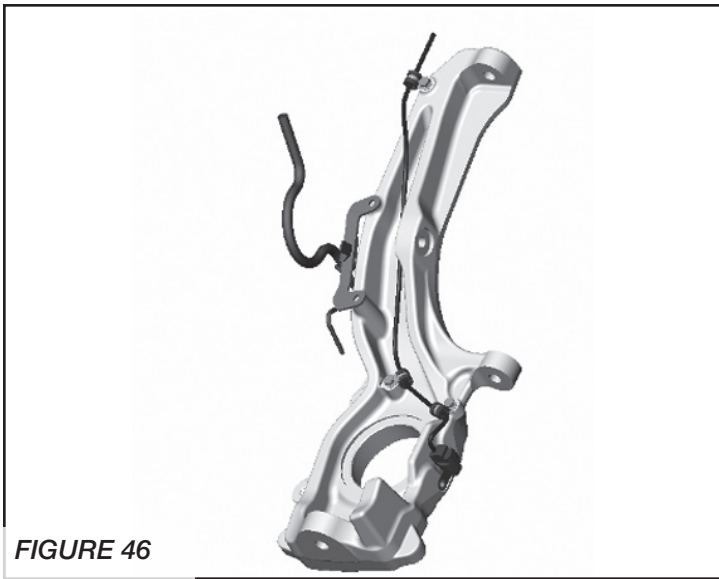

FIGURE 46

34. Remove factory bump stop and discard. Locate FT70056BK (drv.) & FT70057BK (pass.) bumpstop drop bracket. Attach the top of the bracket to the factory bump stop position using the supplied 10mm x 30mm bolt and washer (BAG 3). Attach the two bottom holes of the bracket to the rear Fabtech crossmember, using the supplied 3/8" x 1-1/4" bolts, nuts, & washers (BAG 3). Now locate the supplied FTS88 Bump Stop, attach to the new bump stop bracket using the supplied 3/8" nylock nut, & washer. **SEE FIGURES 47-48**

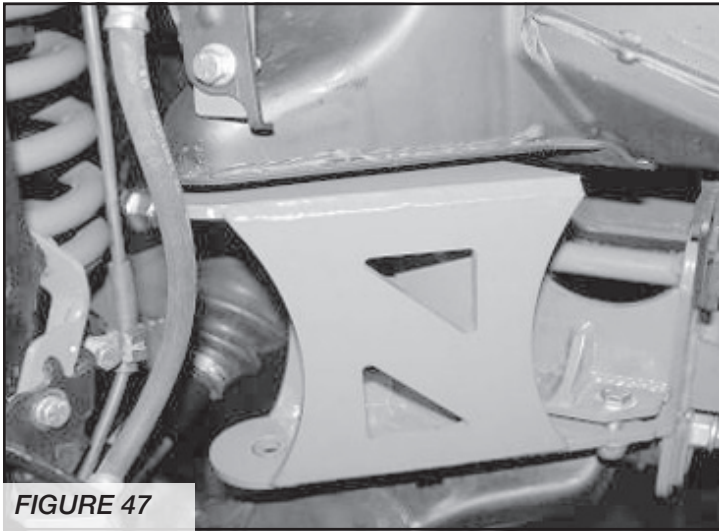

FIGURE 47

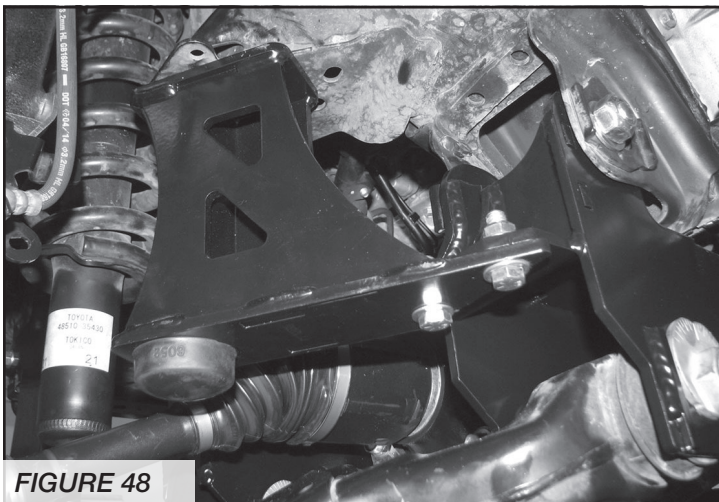

FIGURE 48

35. Locate FT70242 Driver Sway Bar Drop Bracket, and FT70243 Passenger Sway Bar Drop Bracket and the factory sway bar, with hardware. Also locate the supplied 3/8" x 1 1/4" hardware and 12mm bolts and washers (BAG 3). Position the new drop bracket on the frame so the sway bar will be mounted forward of its factory position and attach with the factory hardware. Next, install the 12mm hardware through the new bracket to the factory hole on the side of the radiator support. Install the sway bar to the new drop brackets with the supplied 3/8" hardware. (the sway bar will need to be mounted upside down from the factory position). **SEE FIGURES 49-50**

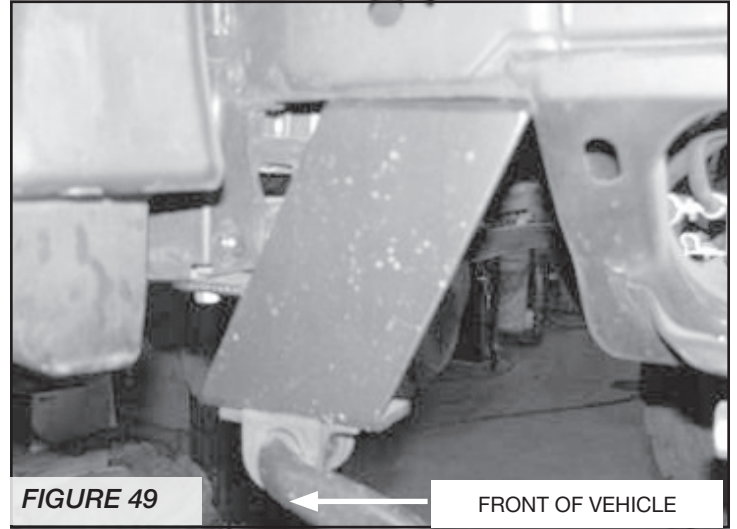

FIGURE 49

FRONT OF VEHICLE

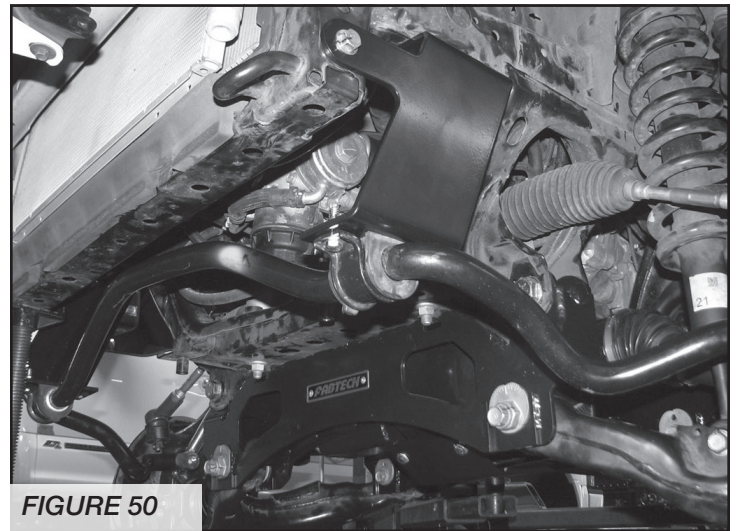

FIGURE 50

36. Locate FT70105 (Sway Bar End Link), FT95023 (½" Heims), and supplied ½" Jam Nuts. Thread the jam nuts all the way onto the heims. Insert an assembled heim into each end of the end links and leave loose. Locate FT70102 (sway bar hat), FT70159 (misalignment) and the supplied 3/8" x 2-1/2" Button head hardware (BAG 3). Insert the misalignments into the heim on one end and attach to the sway bar. Locate FT70159 misalignments and the supplied 3/8" x 3" hardware (BAG 3). Insert the misalignments into the upper heim and attach it to the Fabtech steering knuckle. Torque the 3/8" hardware to 52 ft. lbs. **SEE FIGURES 51-54**

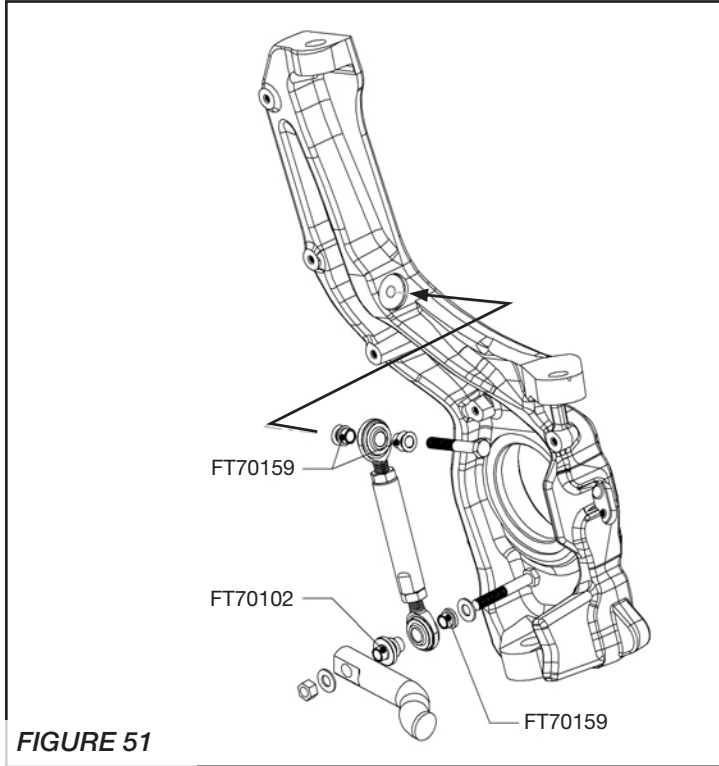

FIGURE 51

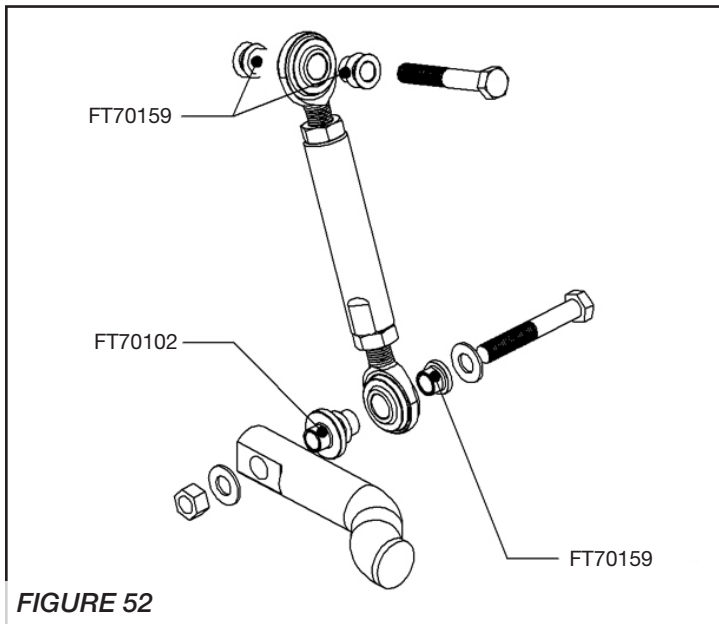

FIGURE 52

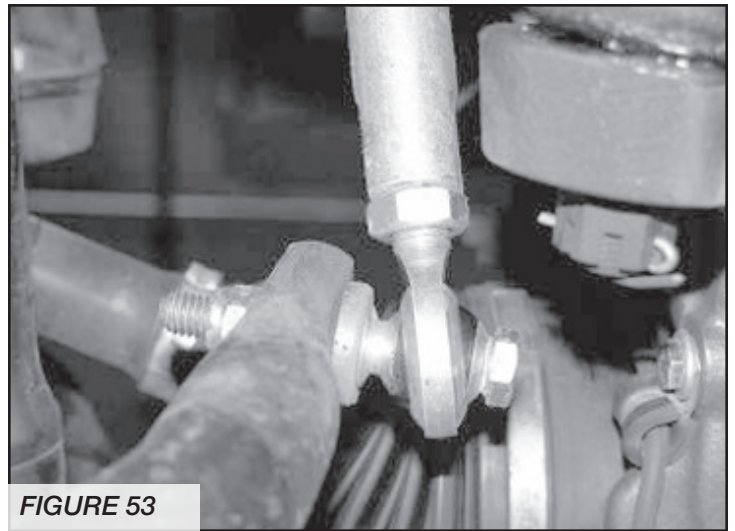

FIGURE 53

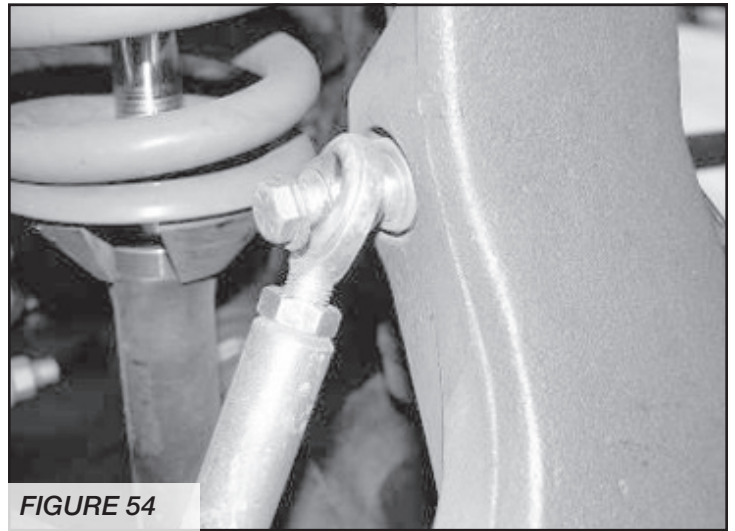
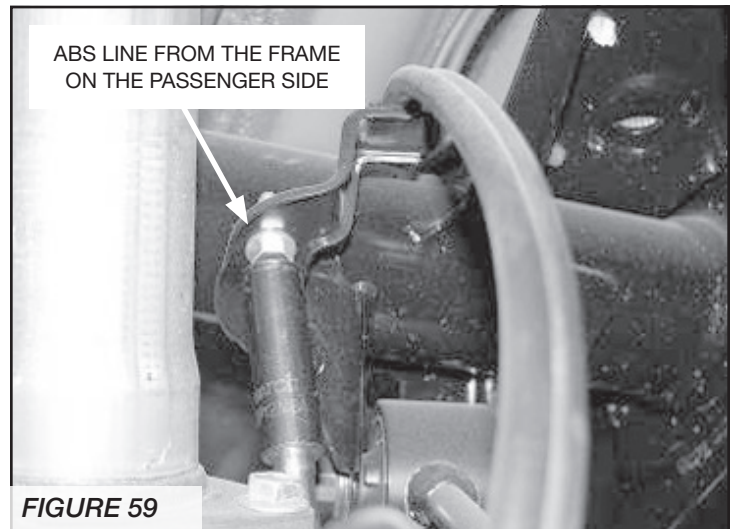
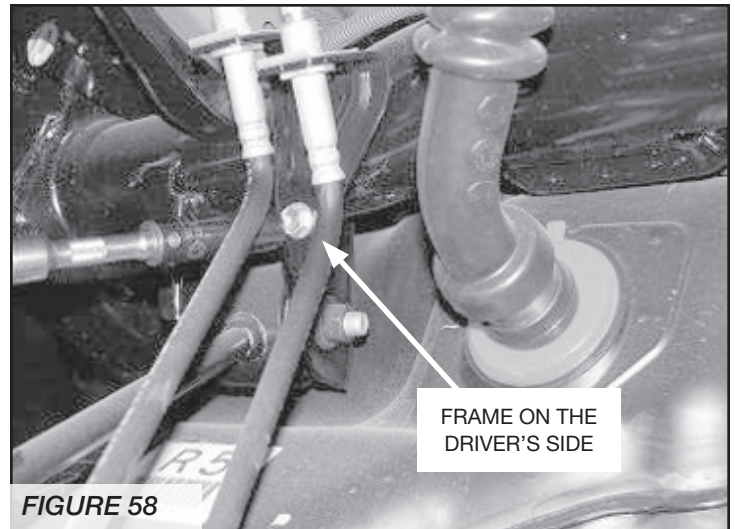
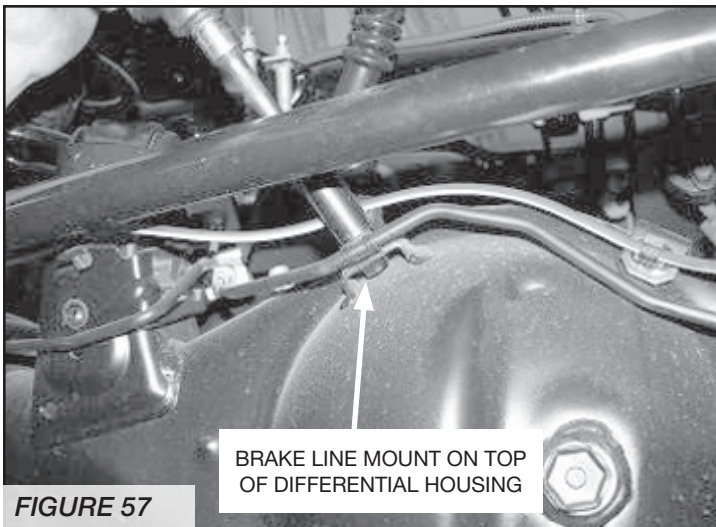
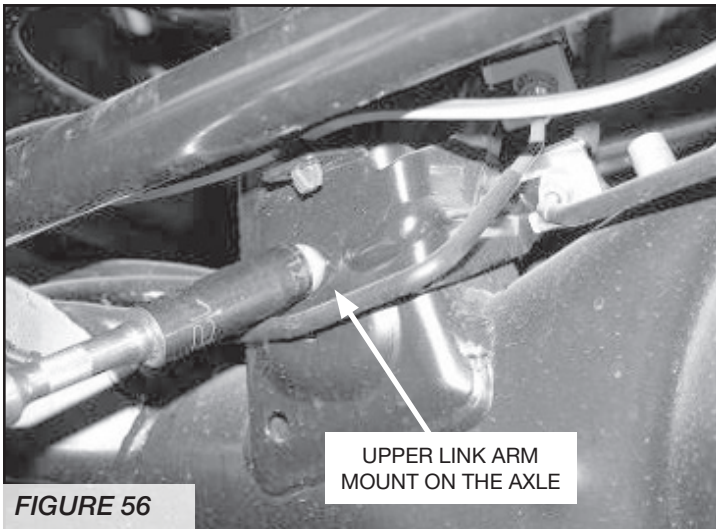
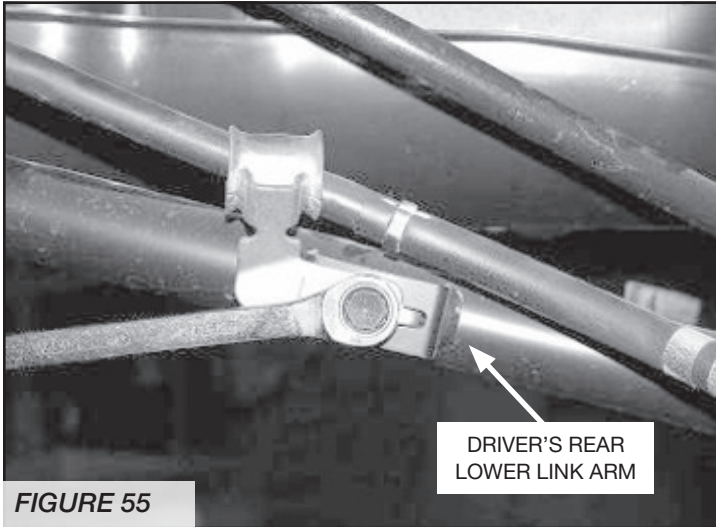

FIGURE 54

37. Install the wheels and tires and torque to the wheel manufactures specs. Turn wheels left to right to check for proper clearance between brake lines / ABS Lines to tires and wheels with vehicle hanging and on the ground. Reroute lines as required for clearance.

REAR SUSPENSION

38. Jack up the rear end of the vehicle and support the frame rails with jack stands. Supporting the rear differential remove and discard the rear shocks, save hardware.
39. Disconnect the brake line brackets on the lower link arms, upper link arm mount on the axle, the mount at the top of the differential housing, and the frame on the driver's side. Remove the ABS line from the frame on the passenger side, save all hardware. **SEE FIGURES 55-59**



40. Remove and save the trac bar, coil springs, and the bumpstops on the frame.
41. Locate FT70084BK (upper) and FT70085BK (lower) Link Arms and FT70092 Bushing kit. **NOTE:** Press FT1007 bushings and longer sleeves into FT70085BK (lower link). Install (1) FT1007 bushing, (1) FT1037 bushing and the shorter sleeve into the FT70084BK (Upper link) coordinating with the offset zerk fitting hole. Install the supplied zerk fittings. **SEE FIGURES 60-61**

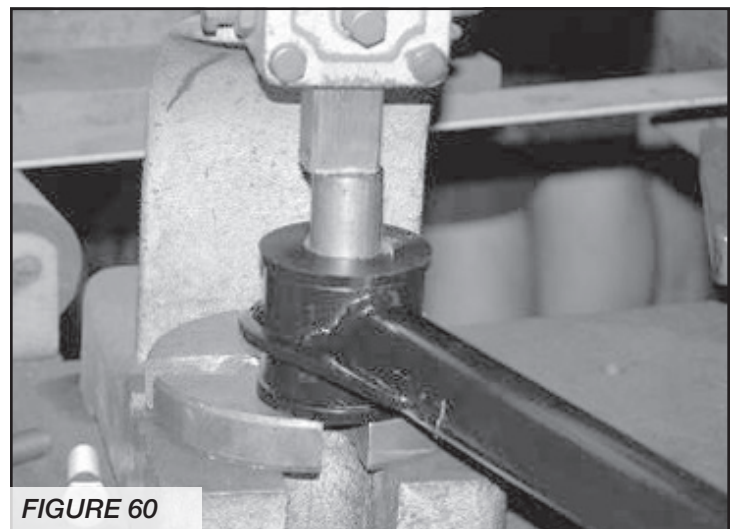

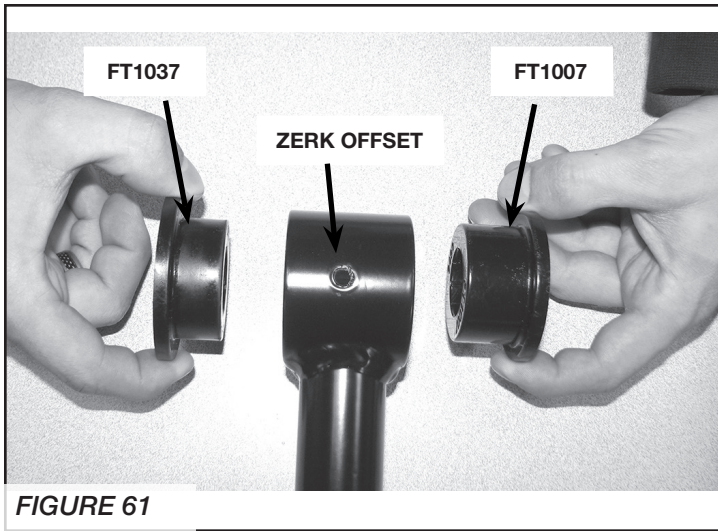

FIGURE 61

42. Remove the driver lower link and install an assembled Fabtech link with the gussets facing down using the stock hardware. Repeat on the passenger lower link.
SEE FIGURES 62-63

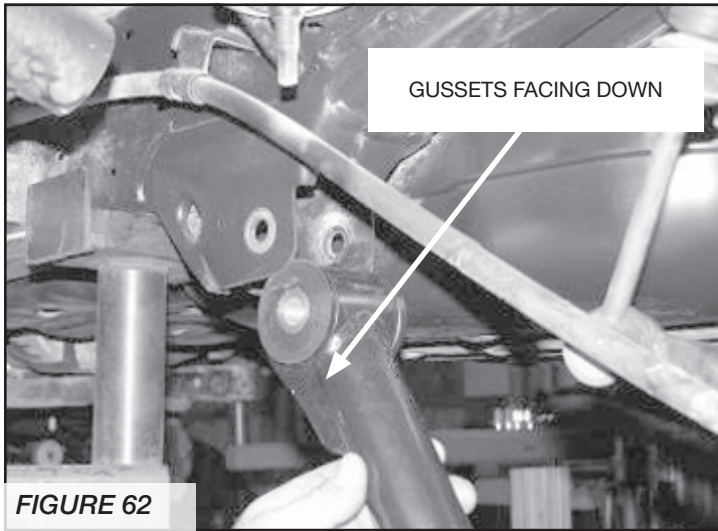

FIGURE 62

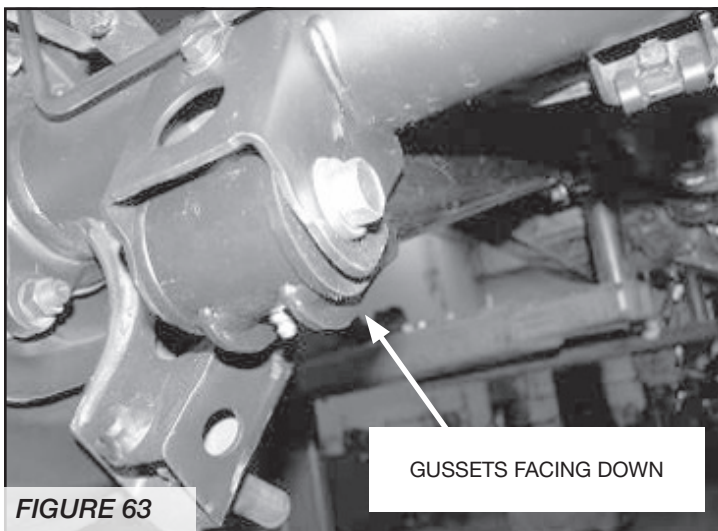

FIGURE 63

43. Remove the driver upper link and install an assembled Fabtech link with the gusset facing upward in the frame pocket and down at the axle mount with the stock hardware. Repeat on the passenger upper link.
SEE FIGURE 64

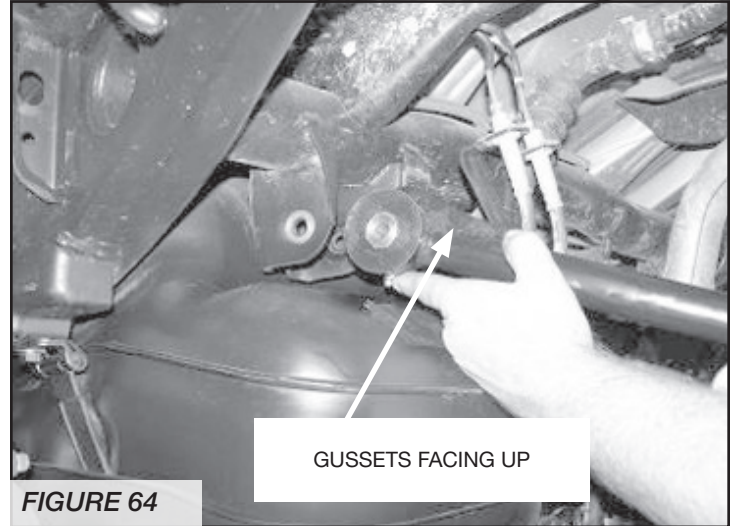

FIGURE 64

44. Working from the driver side, locate FT70245 Rear Coil Spacers and the supplied 3/8" X 1-1/4" & 8mm X 30mm hardware (BAG 4). Position the coil spacer up into the coil bucket on the frame and attach to the factory bumpstop mount with the 8mm hardware (only tighten enough to hold the spacer in position). Mark the three holes in the spacer to the coil bucket and remove the spacer. **SEE FIGURES 65-66**

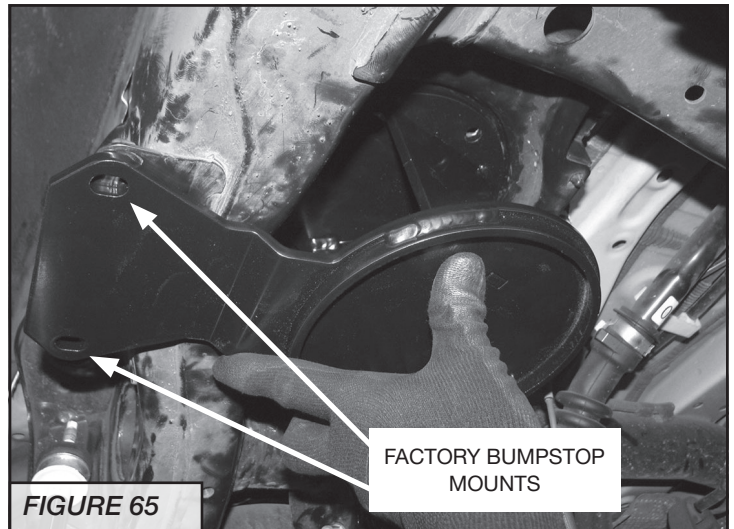

FIGURE 65

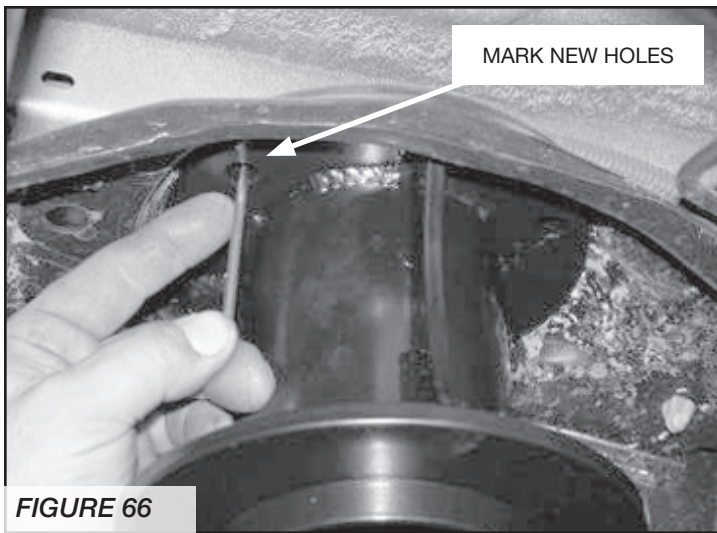

FIGURE 66

45. Use a drill with a 3/8" bit and drill out the three holes in the bucket. Install the spacer with the 3/8" hardware for the 2 holes closest to the inside of the vehicle. Use FT70248 Nut Tab for the outer most hole. Leave loose. Locate FT70246 Rear Bumpstop Bracket, supplied 3/8" X 1-1/4" hardware (BAG 4), and the factory bumpstop. Mount the factory bumpstop to the new bracket with the 3/8" hardware. Position the new mount to the bottom of the coil spacer and attach both to the factory bumpstop mount with the 8mm hardware. Torque the 3/8" hardware to 52 lbs. and the 5/16" & 8mm hardware to 29 lbs. **SEE FIGURES 67-70**

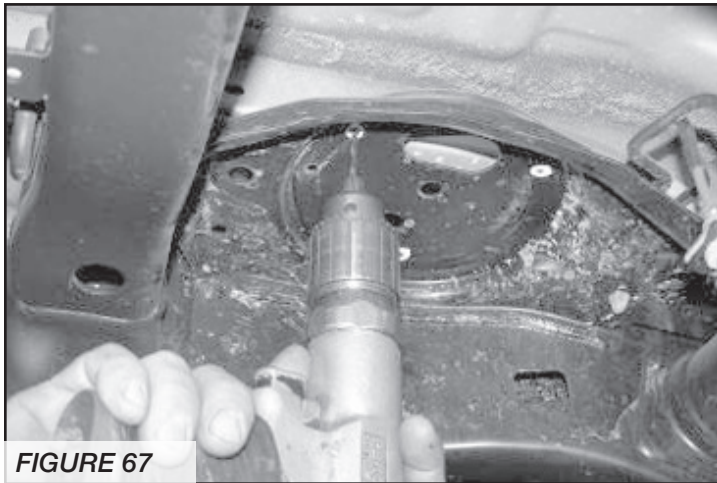

FIGURE 67

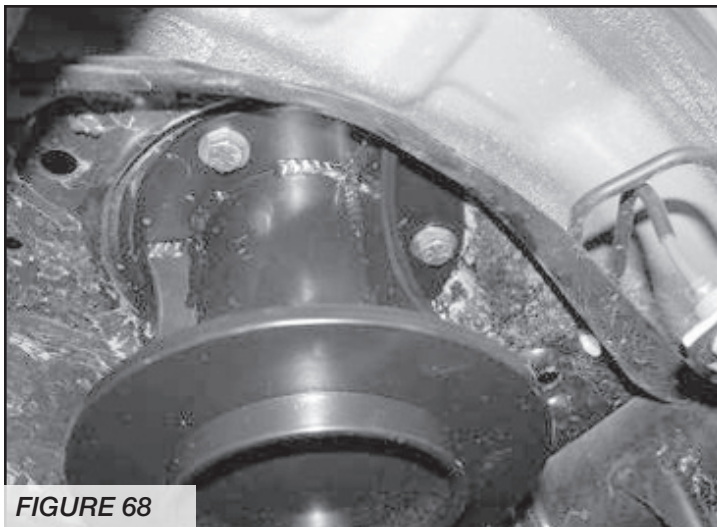

FIGURE 68

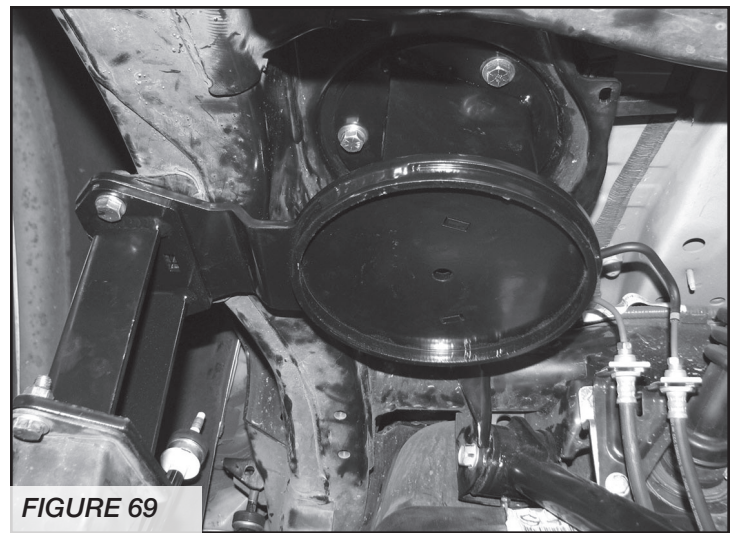

FIGURE 69

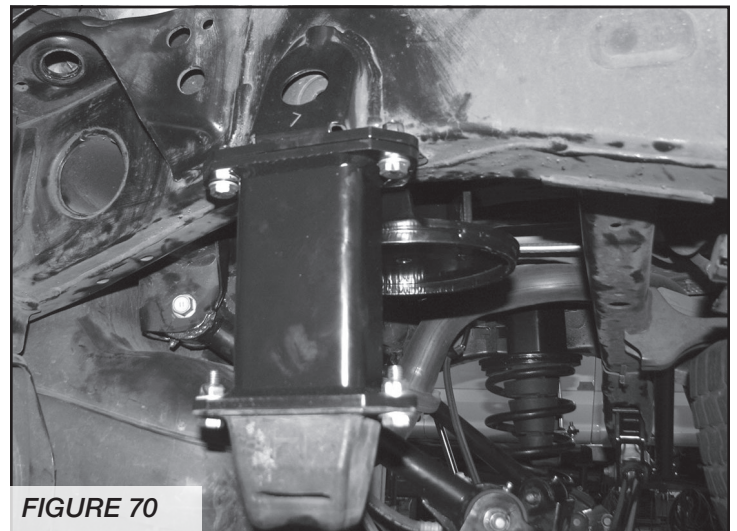

FIGURE 70

46. Repeat steps 44 & 45 on the passenger side.
47. Locate the factory rear coils and bumpstop. Use a coil spring compressor and install the coils (with the bumpstops inside) onto the new spacer and the axle mount. The bottom end of the coil spring must set against the stop on the axle mount for proper fitment and ride height. **SEE FIGURES 71-72**

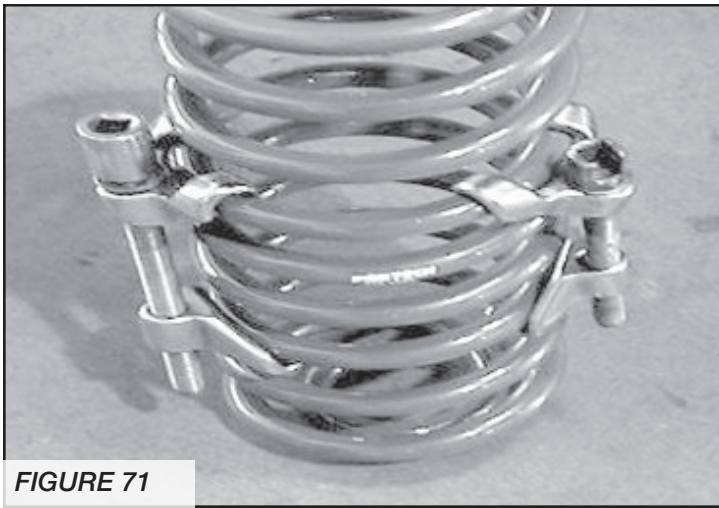

FIGURE 71

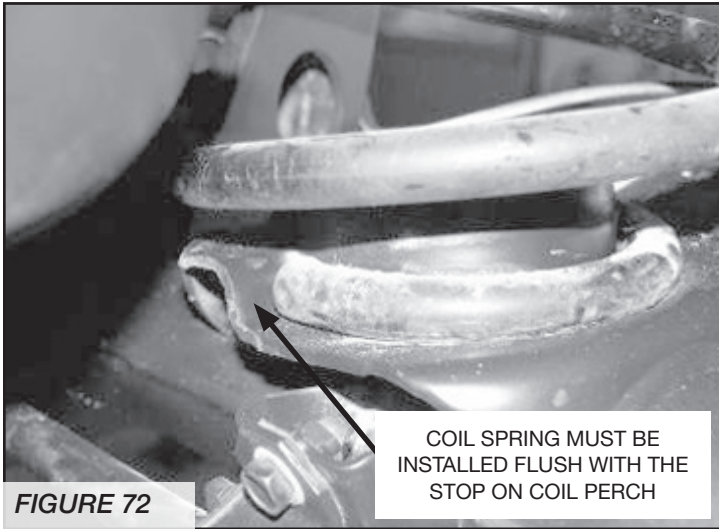

FIGURE 72

COIL SPRING MUST BE
INSTALLED FLUSH WITH THE
STOP ON COIL PERCH

48. Locate FT70088 Trac Bar Bracket and install into the factory trac bar mount on the frame with the supplied 9/16" x 3-1/2" hardware (BAG 4). Rotate the new bracket so that the support tube mount makes contact with the rear crossmember. Using a drill with a 1/2" bit, drill the new hole into the crossmember. Locate FT70096 Trac Bar Nut Tab and insert into the bottom of the crossmember just behind the new bracket and attach with the supplied 1/2" x 1 1/2" bolt, flat washer, and split washer (BAG 4). Torque the 1/2" hardware to 127 lbs and the 9/16" to 184 lbs. Locate and install the factory trac bar and hardware. Torque to 127 lbs. **SEE FIGURES 73-76**

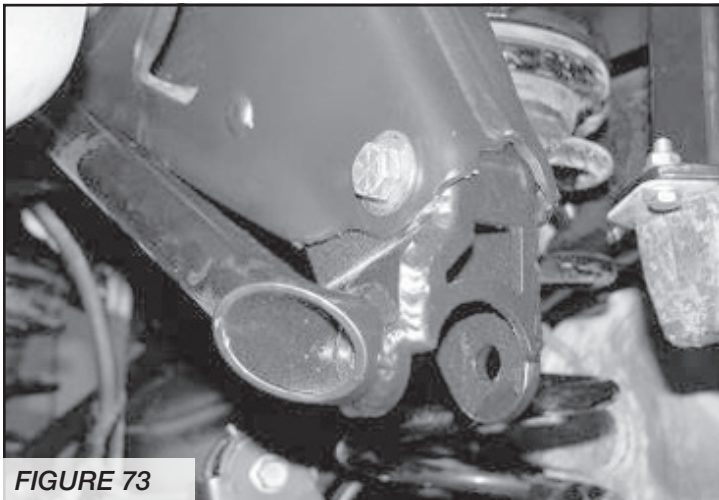

FIGURE 73

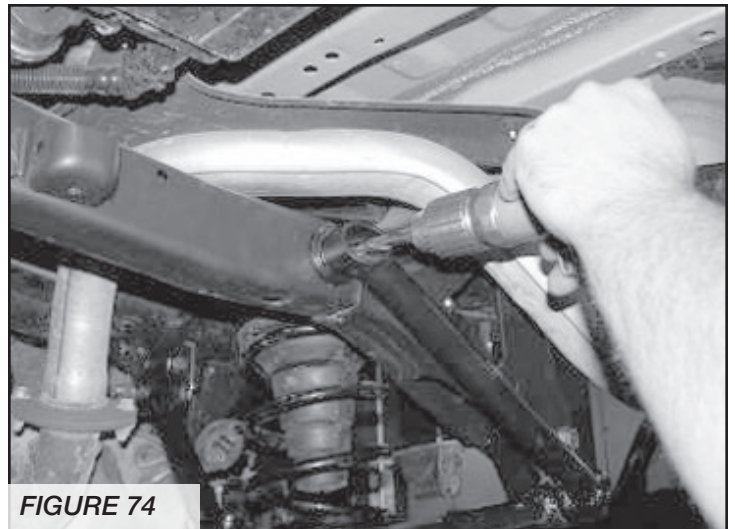

FIGURE 74

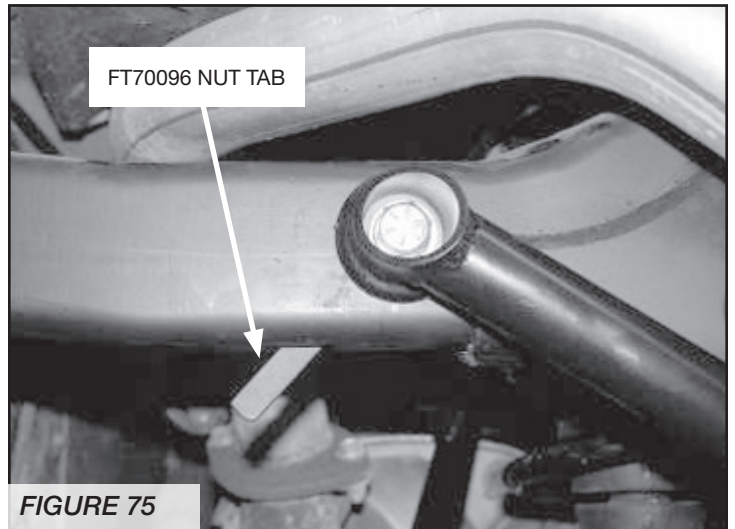

FIGURE 75

FT70096 NUT TAB

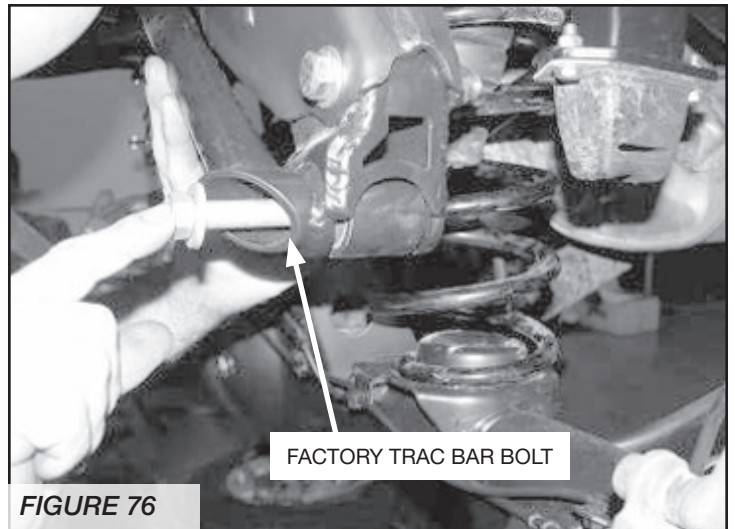
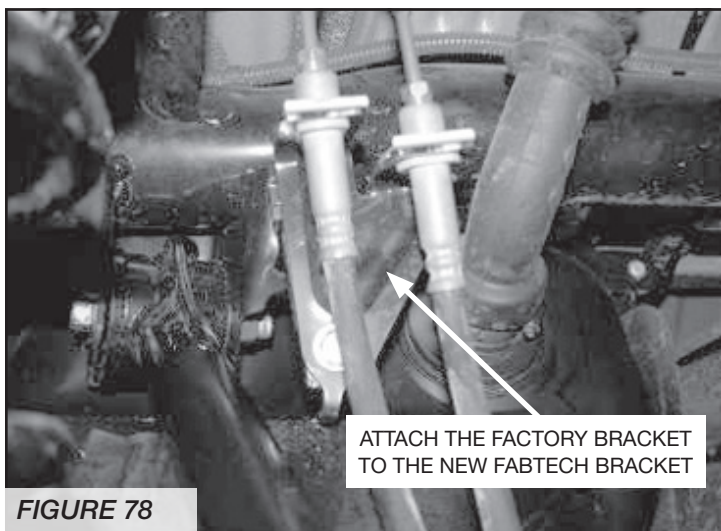
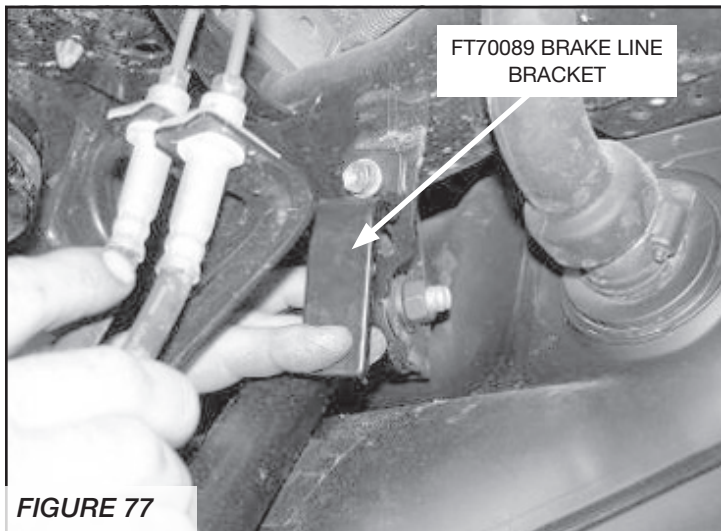

FIGURE 76

FACTORY TRAC BAR BOLT

49. Locate FT70089 Brake Line Bracket and the supplied 5/16" x 3/4" hardware (BAG 4). Position the new bracket onto the factory brake line bracket on the driver's side on the crossmember and attach with the factory hardware. Use the 5/16 to attach the brake line bracket to the new Fabtech bracket. Torque the hardware to 29 lbs. **SEE FIGURES 77-78**



50. Re-connect the ABS sensor to the harness. Locate the ABS bracket on the crossmember and carefully bend the bracket down (do not over bend, it could brake the bracket) just enough so it lines up with the clamp on the ABS lines. Check to ensure that there will be enough slack for the cables during suspension cycling. Attach the ABS clamp to the bracket with the factory hardware. **SEE FIGURES 79-81**

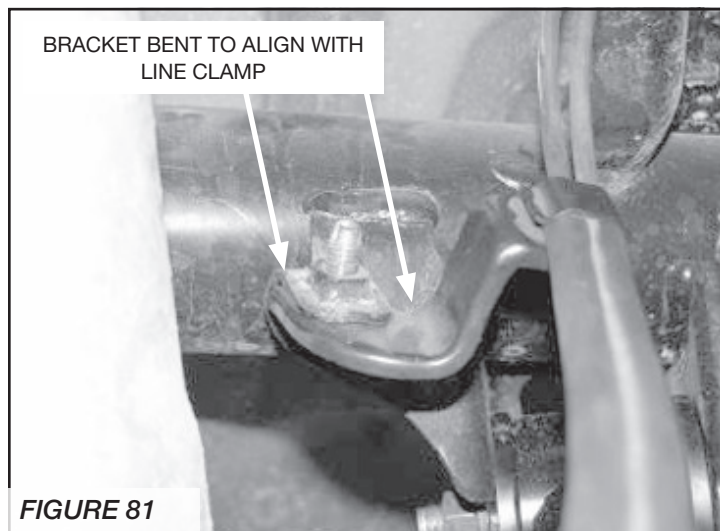
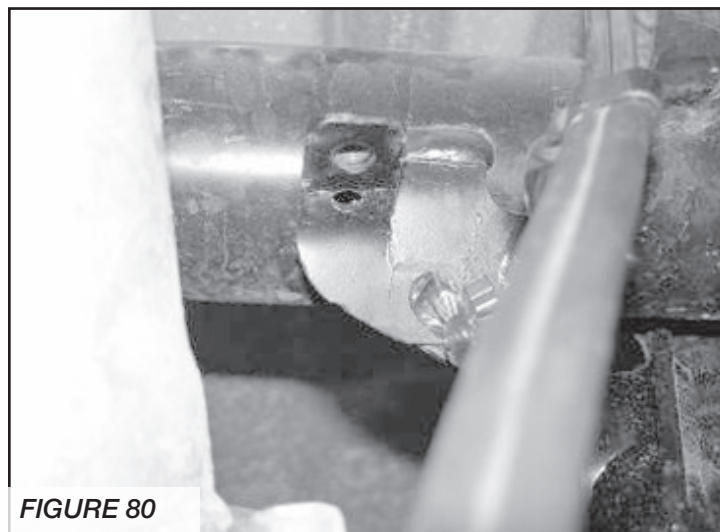
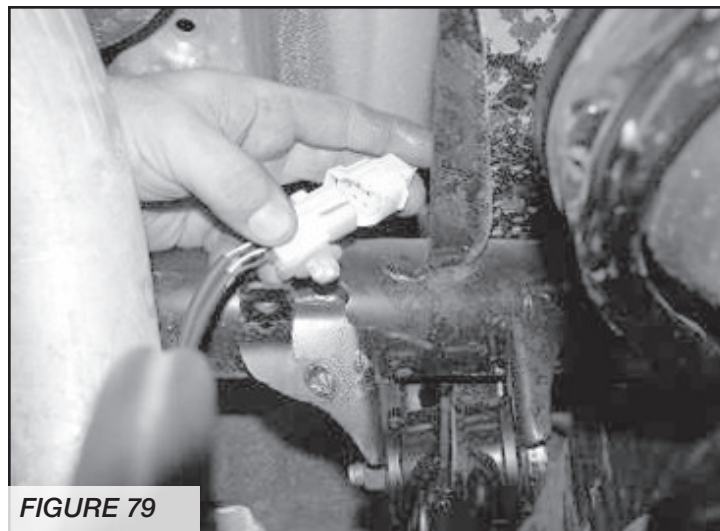

51. Attach the factory e-brake cable bracket with the supplied 5/16" x 3/4" hardware to the mounts on the new lower links. Torque to 15 lbs. **SEE FIGURE 82**

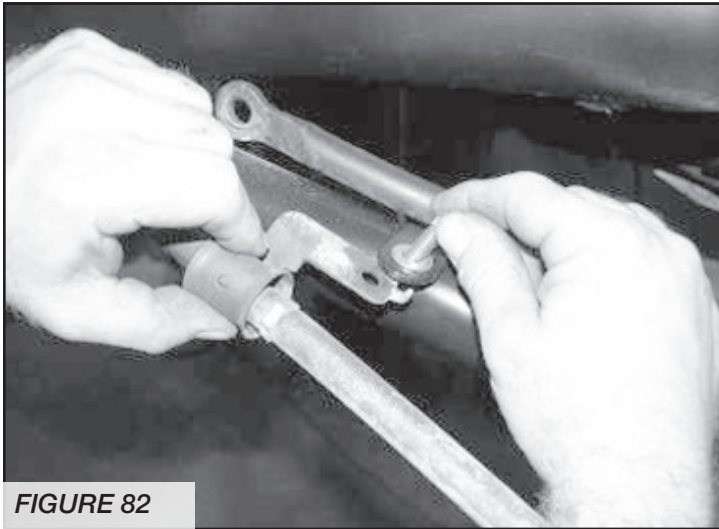

FIGURE 82

52. Locate FT70090 Sway Bar End Links and FT50116 Bushing Kit. Using an arbor press, press an hourglass bushing and FT50089 (sleeve) into the barrel end of the links. Install a cup washer and flat bushing on the stem of the end link and install into the mount on the frame. Place the other bushing and cup washer and supplied 3/8-24 fine thread nut (BAG 4) on the top of the link and leave loose. **SEE FIGURE 83**

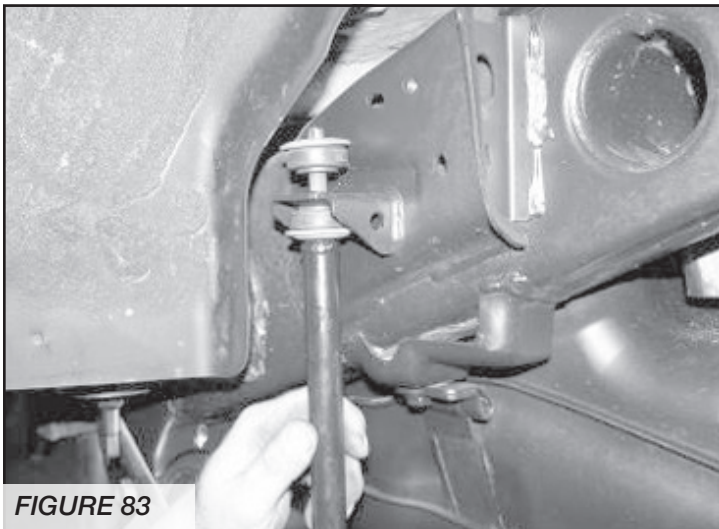

FIGURE 83

53. Locate the supplied 12mm bolt, nut, and large washers (BAG 4). Place a washer onto the bolt and insert into the sway bar from the inside of the bar. Follow with another large washer. Mount the bar to link and follow with another large washer and the C-lock nut. Tighten the lower bolt first and then the upper nut. Only tighten enough to get the bushings to bulge. **SEE FIGURE 84**

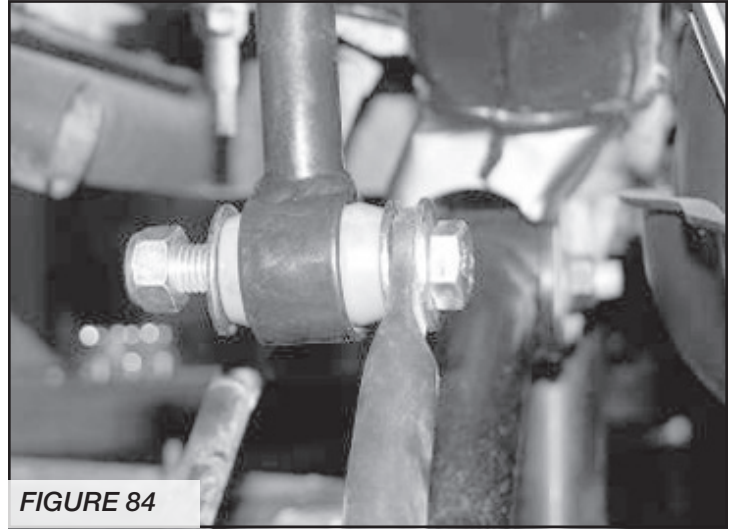

FIGURE 84

54. Install the new Fabtech shocks FTS7237, FTS6017 or FTS810542 and FT83239 Shock Spacer with the factory hardware and supplied shock sleeve. **NOTE: If installing FTS7237 Performance shock, remove the lower bushing and install the supplied FT83267 (bushing).** Install the spacer onto the lower shock mount and follow with the shock and factory hardware. Torque upper and lower bolts to 83 lbs. **SEE FIGURE 85**

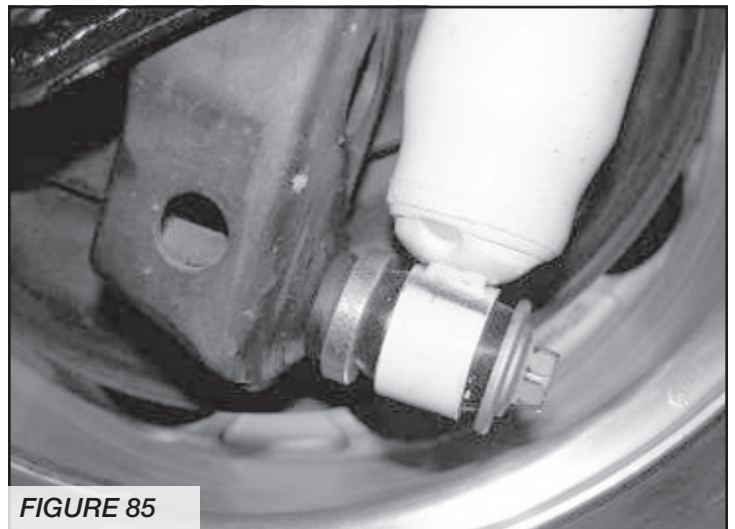

FIGURE 85

55. Tighten upper & lower link arms to 127 ft-lbs.
56. Install tires and wheels and torque lug nuts to wheel manufacturer's specifications. Turn front tires left to right and check for appropriate tire clearance. **Note - Some oversized tires may require trimming of the front bumper & valance.**
57. Check front end alignment and set to factory specifications. Readjust headlights.
58. Recheck all bolts for proper torque.
59. Recheck brake hoses, ABS wires and suspension parts for proper tire clearance while turning tires fully left to right.
60. Check the fluid in the front and rear differential and fill if needed with factory specification differential oil. **Note - some differentials may expel fluid after filling and driving. This can be normal in resetting the fluid level with the new position of the differential/s.**
61. Install Driver Warning Decal. Complete product registration card and mail to Fabtech in order to receive future safety and technical bulletins on this suspension

Vehicles that will receive oversized tires should check ball joints and all steering components every 2500-5000 miles for wear and replace as required.

**RE-TORQUE ALL NUTS, BOLTS AND LUGS
AFTER 50 MILES AND PERIODICALLY
THEREAFTER.**



FTS26059 Dirt Logic 6" 2005-2017 Toyota Tacoma and F.J. CRUISER Non Reservoir Coilover Installation Instructions

Spanner wrench is not included in this kit if needed order FTS98008

***NOTE:** These instructions are for vehicles with Fabtech kits already installed.*

Removal

With the vehicle on level ground, set the emergency brake and block the rear tires. **NEVER WORK UNDER AN UNSUPPORTED VEHICLE!**

1.) With the help of a floor jack lift up the front end of the vehicle and support the weight by the use of jack stands. 2.) Loosen lugs on both front wheels and remove wheels off the vehicle. 3.) With both wheels off the vehicle remove both tie rod ends. 4.) Remove both sway bar links so the sway bar can swing freely out of the way. 5.) Now only working on the driver side, remove 3 nuts off the upper stock mount plate.



6.) Remove the lower shock bolt and completely remove the shock of the vehicle.

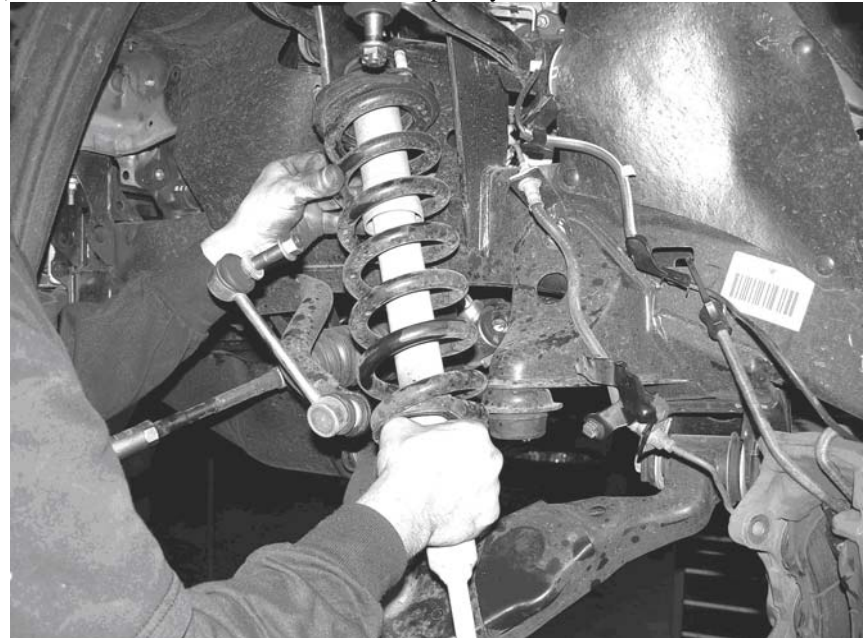

7.) Now move to the passenger side and repeat the procedures in removing the stock shock of the vehicle.

Installation

Still having the vehicle supported by the jack stands start on the driver side.

1.) With the tank valve in the direction of the installer line up the 3 holes of the upper mount plate and installed the 3 bolts provided with the Coilover.



2.) Attach the bearing spacers to the lower rod end of the shock. Taller spacer should face the front of vehicle and the shorter spacer to the rear of the vehicle. 3.) Slide the lower rod end into the lower shock mounting plate of the control arm and install bolt.

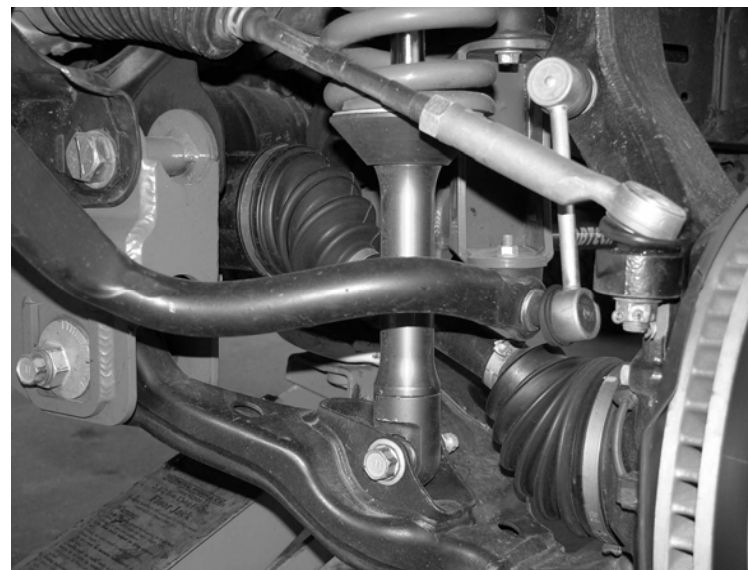



4.) Now move to the passenger side and repeat the procedures for the installation of the Coilover. Once both sides have the newly installed Coilover, reinstalled the sway bar links on both sides and also reinstalled the tie rod ends. You have now completed your installation. Spanner wrench is not included in this kit if needed order FTS98008. We recommend driving the vehicle for 50 miles and retorque nuts and bolts and then have it aligned to factory specs.

Fabtech provides the best in performance suspension parts equipment.