

# Firestone



## APPLICATION GUIDE FALL 2017



## Precision-engineered leveling

Firestone Air Springs are specifically designed to fit on your vehicle and provide an array of benefits. Use the application guide beginning on page 3 to determine which air spring product is designed for your vehicle. Enjoy easy installation and the smooth ride, improved stability and safer load-carrying capacity offered by the original Air Spring.



### Ride-Rite™ Air Springs

- Firestone's most popular and comprehensive Air Spring line
- Maximizes the vehicle's safe load-carrying capacity, stability, ride quality and brake effectiveness
- Most kits are No-Drill systems, easily installing in 1-2 hours
- Supports up to 5,000 lbs. per set\*



### Sport-Rite™ Air Springs

- Improves the ride and handling of your vehicle
- Innovative tapered sleeve Air Springs, which are more conducive for specific applications
- Supports up to 3,000 lbs. per set\*



### Coil-Rite™ Air Springs

- Control the air pressure in the Air Springs for varying loads and road conditions
- Spring performance can be altered as easily as inflating a tire
- Made of durable, elastic polyurethane
- Support 500-1000 lbs. per set\*
- Designed to work in temperatures between -40°F (-40°C) and 180°F (82°C)

\*DO NOT EXCEED THE VEHICLE'S RECOMMENDED GROSS VEHICLE WEIGHT RATING (GVWR)

# RED LABEL™ AIR SPRING KITS

## Want the absolute best? You just found it

The Firestone RED Label™ Air Springs are built to extreme specifications found in the most demanding applications. We pioneered the Air Spring industry and continue to develop high quality products.

- Commercial-grade bellows
- High strength steel components
- Up to 7,500 lbs leveling\*



RED LABEL™ AIR SPRING KIT						
Make/Model	In-bed Hitch Compatible	Year	Rear Kit Number	No Drill	Time (hours)	Replacement Air Spring
<b>Chevrolet/GMC Pickup Trucks</b>						
Silverado, Sierra 2500HD (2WD, 4WD)	Y	11-18	2702	Y	1.5	8401
Silverado, Sierra 2500HD (2WD, 4WD)	Y	01-10	2700	Y	1.5	8781
Silverado, Sierra 3500HD (2WD, 4WD)	Y	11-18	2702	Y	1.5	8401
Silverado, Sierra 3500HD (2WD, 4WD)	Y	01-10	2700	Y	1.5	8781
<b>Ford Pickup Trucks</b>						
F250 (2WD, 4WD)	Y	11-16	2703	Y	1.5	8401
F350 (2WD, 4WD)	Y	11-16	2703	Y	1.5	8401
F450 (2WD, 4WD)	Y	11-13	2703	Y	1.5	8401
<b>Ram Pickup Trucks</b>						
Ram 2500 (2WD, 4WD) w/out factory air springs	Y	14-18	2706	Y	1.5	8873
Ram 2500 (2WD, 4WD)	Y	03-13	2701	Y	1.5	8401
Ram 3500 (4WD only) w/out factory air springs	Y	13-18	2705	Y	1.5	8401
Ram 3500 (2WD, 4WD)	Y	03-12	2701	Y	1.5	8401

\*DO NOT EXCEED THE VEHICLE'S RECOMMENDED GROSS VEHICLE WEIGHT RATING (GVWR)



## The complete kit so you can Ride-Rite

All-in-One Kits come with Air Springs, compressor, air accessories and all components for install. Choose F3 Wireless or Analog.

- One part number for easy ordering
- Recommended: No-Drill Air Accessory Mounting Kit (page 34)

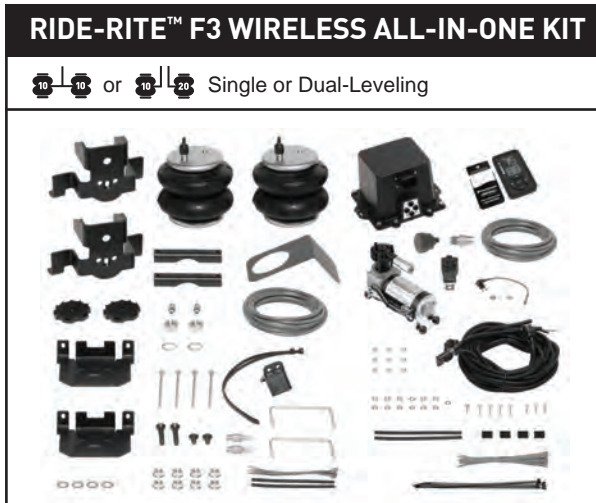

ALL-IN-ONE KIT							
Make/Model	In-bed Hitch Compatible	Year	Rear Analog Kit	Rear F3 Wireless Kit	No Drill*	Time (hours)	Replacement Air Spring
<b>Chevrolet/GMC Pickup Trucks</b>							
Silverado, Sierra 2500HD, 3500HD (2WD, 4WD)	Y	11-18	2807	2806	Y	2.5	6401
Silverado, Sierra 2500HD, 3500HD (2WD, 4WD)	Y	01-10	2809	2808	Y	2.5	6781
<b>Ford Pickup Trucks</b>							
F250, F350 (2WD, 4WD)	Y	11-16	2803	2802	Y	2.5	6401
F250, F350 (2WD, 4WD)	Y	08-10	2801	2800	Y	2.5	6401
F250 Over 8,500 GVWR (2WD, 4WD)	Y	99-04	2801	2800	Y	2.5	6401
F350 (2WD, 4WD) (not v10 gas w/ extended cab and 8' bed)	Y	99-04	2801	2800	Y	2.5	6401
F450 (2WD, 4WD)	Y	11-13	2803	2802	Y	2.5	6401
<b>Ram Pickup Trucks</b>							
Ram 1500 Mega Cab (2WD, 4WD)	Y	06-08	2805	2804	Y	2.5	6401
Ram 2500 (2WD, 4WD)	Y	03-13	2805	2804	Y	2.5	6401
Ram 3500 (2WD, 4WD)	Y	03-12	2805	2804	Y	2.5	6401
<b>Toyota Pickup Trucks</b>							
Tundra (2WD, 4WD), TRD	Y	07-18	2811	2810	Y	2.5	6410

DO NOT EXCEED THE VEHICLE'S RECOMMENDED GROSS VEHICLE WEIGHT RATING (GVWR)

\*No-Drill applies to the Air Spring component installation.

To accomplish No-Drill for entire installation, purchase Air Accessory Mounting Kit on page 34.

# APPLICATION GUIDE

Make/Model	In-bed Hitch Compatible	Year	AIR LEVELING REAR					AIR LEVELING FRONT					Air Accessory Duty
			Rear Kit Part Number	Solution	No Drill	Time (hours)	Replacement Air Spring	Front Kit Part Number	Solution	No Drill	Time (hours)	Replacement Air Spring	
<b>Acura SUV</b>													
MDX		05-10	4179	C-R		2	6020						Light
<b>Audi Cars</b>													
A3		10-17	4176	C-R	Y	1	6027						Light
Q3		15-16	4176	C-R	Y	1	6027						Light
<b>Buick Cars / CUV / Van</b>													
Century (fwd only)		82-96	4103	C-R	Y	1	6014						Light
Century (rwd only)		73-87	-4114-	C-R	Y	1	6008						Light
Electra (not sw)		85-96	4107	C-R	Y	1	6021						Light
Grand Sport		73-87	-4114-	C-R	Y	1	6008						Light
LeSabre (not sw) (fwd only)		00-04	4105	C-R	Y	1	6013						Light
LeSabre FWD		86-99	4107	C-R	Y	1	6021						Light
Luxus (rwd only)		73-87	-4114-	C-R	Y	1	6008						Light
Park Avenue		97-05	4105	C-R	Y	1	6013						Light
Park Avenue (not sw)		85-96	4107	C-R	Y	1	6021						Light
Regal (rwd only)		73-87	-4114-	C-R	Y	1	6008						Light
Riviera		95-98	4105	C-R	Y	1	6013						Light
Riviera		79-85	4106	C-R	Y	1	6015						Light
Terraza		05-07	4155	C-R	Y	1	6020						Light
<b>Cadillac Cars / SUVs</b>													
Coupe Deville, Fleetwood, Sedan Deville, Touring Sedan (fwd only)		85-93	4107	C-R	Y	1	6021						Light
CTS		05-11	-4168-	C-R	Y	1	6027						Light
El Dorado		79-85	4106	C-R	Y	1	6015						Light
Escalade (2WD, 4WD) (4 door only)		99-00	2101	R-R	Y	2	6781						Light
Escalade, ESV, EXT (2WD, 4WD)		07-17	4108	C-R	Y	1	6003						Light
Escalade, ESV, EXT (2WD, 4WD) (with Autoride suspension)		15-17	4108	C-R	Y	1	6003						Light
Escalade, ESV, EXT (2WD, 4WD) (with Autoride suspension)		08-14	4186	C-R	Y	1	6015						Light
Escalade, ESV, EXT (2WD, 4WD)		02-06	4108	C-R	Y	1	6003						Light
Seville		80-85	4106	C-R	Y	1	6015						Light
STS		06-14	-4168-	C-R	Y	1	6027						Light

## DO NOT EXCEED THE VEHICLE'S RECOMMENDED GROSS VEHICLE WEIGHT RATING (GVWR)

Minimum Tire to Frame Clearance Requirements (check both sides): \* = 7.50" \*\* = 3.00" \*\*\* = 9.50" + = 8.00" ++ = 6.00" +++ = 6.50"

-0000- While Supplies Last # = Use spacer kit 2366 with heavy duty package or TRD

sw = Station Wagon  
rwd = Rear Wheel Drive

fwd = Front Wheel Drive  
A.C. = Air Conversion

Y = Yes

R-R = Ride-Rite  
C-R = Coil-Rite

S-R = Sport-Rite

# APPLICATION GUIDE

Make/Model	In-bed Hitch Compatible	Year	AIR LEVELING REAR					AIR LEVELING FRONT					Air Accessory Duty
			Rear Kit Part Number	Solution	No Drill	Time (hours)	Replacement Air Spring	Front Kit Part Number	Solution	No Drill	Time (hours)	Replacement Air Spring	
<b>Chevrolet Cars</b>													
Aveo		10	4103	C-R	Y	1	6014						Light
Camaro, Z-28, IROC-Z		82-02	4103	C-R	Y	1	6014						Light
Celebrity		82-90	4103	C-R	Y	1	6014						Light
Chevelle		73-83	-4114-	C-R	Y	1	6008						Light
El Camino		67-87	-4114-	C-R	Y	1	6008						Light
Malibu		73-83	-4114-	C-R	Y	1	6008						Light
Monte Carlo (not SS)		73-88	-4114-	C-R	Y	1	6008						Light
Volt		16	4176	C-R	Y	1	6027						Light
Volt		12-15	4118	C-R	Y	1	6118						Light
<b>Chevrolet/GMC Vans</b>													
Astro, Safari (2WD, AWD)		99-05	-2361-	R-R		2	6397						Standard
G1500 (6 lug nuts, GVWR 7200)		03-09	2423	R-R		2	6868						Standard
G10, G20, G30, G1500, G2500, G3500		70-95	-0830-	R-R		3	6859	4100	C-R	Y	1	6100	Standard
G2500 G3500 (8 lug nuts) (Over 8600 GVW) (single rear wheel)		03-17	-2337-	S-R		2	9000						Standard
Uplander		05-09	4155	C-R	Y	1	6020						Light
<b>Chevrolet/GMC SUVs</b>													
Avalanche 1500 (2WD, 4WD) (with Autoride suspension)		11-13	4186	C-R	Y	1	6015						Light
Avalanche 1500 (2WD, 4WD)		02-13	4108	C-R	Y		6003						Light
Blazer (2WD only) (full size)		73-91						4100	C-R	Y	1	6100	Light
Denali XL 2500 (2WD, 4WD)		00-09	-2253-	R-R		2	6781	-1003-	L-R	Y	2	7210	Standard
Envoy (2WD, 4WD) (with rear coil springs)		02-09	4108	C-R	Y	1	6003						Light
Jimmy (2WD only) (full size)		73-91						4100	C-R	Y	1	6100	Light
Suburban 1500 (2WD, 4WD)		07-18	4108	C-R	Y	1	6003						Light
Suburban 1500 (2WD, 4WD) (with Autoride suspension)		15-18	4108	C-R	Y	1	6003						Light
Suburban 1500 (2WD, 4WD) (with Autoride suspension)		08-14	4186	C-R	Y	1	6015						Light
Suburban 1500 (2WD, 4WD)		00-06	4108	C-R	Y	1	6003						Light

## DO NOT EXCEED THE VEHICLE'S RECOMMENDED GROSS VEHICLE WEIGHT RATING (GVWR)

Minimum Tire to Frame Clearance Requirements (check both sides): \* = 7.50" \*\* = 3.00" \*\*\* = 9.50" += 8.00" ++ = 6.00" +++ = 6.50"

-0000- While Supplies Last # = Use spacer kit 2366 with heavy duty package or TRD

sw = Station Wagon  
rwd = Rear Wheel Drive

fwd = Front Wheel Drive  
A.C. = Air Conversion

Y = Yes

R-R = Ride-Rite  
C-R = Coil-Rite

S-R = Sport-Rite

# APPLICATION GUIDE

Make/Model	In-bed Hitch Compatible	Year	AIR LEVELING REAR					AIR LEVELING FRONT					Air Accessory Duty
			Rear Kit Part Number	Solution	No Drill	Time (hours)	Replacement Air Spring	Front Kit Part Number	Solution	No Drill	Time (hours)	Replacement Air Spring	
<b>Chevrolet/GMC SUVs (continued)</b>													
Suburban 1500 (2WD, 4WD)		92-99	2101	R-R		2	6781						Standard
Suburban 1500 (2WD only)		73-91	-2100-	R-R		2	6781	4100	C-R	Y	1	6100	Standard
Suburban 1500 (4WD only)		73-91	-2100-	R-R		2	6781						Standard
Suburban 2500 (2WD, 4WD)		00-09	-2253-	R-R		2	6781	-1003-	L-R	Y	2	7210	Standard
Suburban 2500 (2WD, 4WD)		92-99	2101	R-R		2	6781						Standard
Suburban 2500 (2WD only)		73-91	-2100-	R-R		2	6781	4100	C-R	Y	1	6100	Standard
Suburban 2500 (4WD only)		73-91	-2100-	R-R		2	6781						Standard
Tahoe (2WD, 4WD)		00-18	4108	C-R	Y	1	6003						Light
Tahoe (2WD, 4WD) (with Autoride suspension)		15-18	4108	C-R	Y	1	6003						Light
Tahoe (2WD, 4WD) (with Autoride suspension)		08-14	4186	C-R	Y	1	6015						Light
Police Tahoe (2WD, 4WD)		07-18	4147	C-R	Y	1	6024						Light
Tahoe (2WD, 4WD) (4-door only)		95-99	2101	R-R		2	6781						Standard
Trailblazer (2WD, 4WD)		02-09	4108	C-R	Y	1	6003						Light
Yukon 1500 (2WD, 4WD)		07-18	4108	C-R	Y	1	6003						Light
Yukon 1500 (2WD, 4WD) (with Autoride suspension)		15-18	4108	C-R	Y	1	6003						Light
Yukon 1500 (2WD, 4WD) (with Autoride suspension)		08-14	4186	C-R	Y	1	6015						Light
Yukon 1500 (2WD, 4WD)		00-06	4108	C-R	Y	1	6003						Light
Yukon 1500 (2WD, 4WD) (4-door only)		95-99	2101	R-R		2	6781						Standard
Yukon XL 2500 (2WD, 4WD)		00-09	-2253-	R-R		2	6781	-1003-	L-R	Y	2	7210	Standard
Yukon 2500 (2WD, 4WD) (4-door only)		95-99	2101	R-R			6781						Standard
<b>Chevrolet/GMC Pickup Trucks</b>													
S10 Crew Cab (2WD only)		04	-2209-	S-R		2	9001						Standard
S10, Sonoma (2WD only) (not factory lowered ZQ8)		82-03	-2209-	S-R		2	9001						Standard
Colorado, Canyon (2WD, 4WD)		15-18	2587	S-R	Y	1.5	9001						Standard
Colorado, Canyon (2WD, 4WD) (not factory lowered ZQ8)		04-12	2384	R-R	Y	1.5	6397						Standard

## DO NOT EXCEED THE VEHICLE'S RECOMMENDED GROSS VEHICLE WEIGHT RATING (GVWR)

Minimum Tire to Frame Clearance Requirements (check both sides): \* = 7.50" \*\* = 3.00" \*\*\* = 9.50" + = 8.00" ++ = 6.00" +++ = 6.50"

-0000- While Supplies Last # = Use spacer kit 2366 with heavy duty package or TRD

sw = Station Wagon  
rwd = Rear Wheel Drive

fwd = Front Wheel Drive  
A.C. = Air Conversion

Y = Yes

R-R = Ride-Rite  
C-R = Coil-Rite

S-R = Sport-Rite

# APPLICATION GUIDE

Make/Model	In-bed Hitch Compatible	Year	AIR LEVELING REAR					AIR LEVELING FRONT					Air Accessory Duty
			Rear Kit Part Number	Solution	No Drill	Time (hours)	Replacement Air Spring	Front Kit Part Number	Solution	No Drill	Time (hours)	Replacement Air Spring	
<b>Chevrolet/GMC Silverado, Sierra 1500 Pickup Truck</b>													
Silverado, Sierra 1500 (2WD, 4WD) (not High Country and Denali model 15+)		07-18	2430	R-R	Y	1	6397						Standard
Silverado Classic, Sierra Classic 1500 (2WD, 4WD)		07	-2320- ++	S-R		2	9000						Standard
Silverado Classic, Sierra Classic 1500 (2WD, 4WD)		07	-2320- ++	S-R		2	9000						Standard
Silverado, Sierra 1500 (2WD, 4WD) (not HD)		99-06	-2320- ++	S-R		2	9000						Standard
Silverado, Sierra 1500HD (2WD, 4WD) (not Quad-Steer)		05-06	2190	R-R		2	6781	-1003-	L-R	Y	2	7210	Standard
Silverado, Sierra 1500HD (2WD, 4WD) (not Quad-Steer)		01-03	2190	R-R		2	6781	-1003-	L-R	Y	2	7210	Standard
C & K1500 (2WD, 4WD)		88-98	2025	R-R		2	6781						Standard
(2WD only)			-2162- +++	S-R		2	9002						Standard
C & R 10, 1500 (2WD only)		73-87	2071 *	R-R		2	6781	4100	C-R	Y	1	6100	Standard
K & V-10, 1500 (4WD only)		73-87	-2040- ***	R-R		2	6873						Standard
<b>Chevrolet/GMC Silverado, Sierra 2500 Pickup Truck</b>													
Silverado, Sierra C2500 (2WD only) (not HD)		99-05	2190	R-R		2	6781	-1003-	L-R	Y	2	7210	Standard
Silverado, Sierra C2500 (4WD only) (not HD)		99-05	2190	R-R		2	6781	-1003-	L-R	Y	2	7210	Standard
Silverado, Sierra 2500HD (2WD, 4WD)	Y	11-18	2596	R-R	Y	1.5	6401						Heavy
Silverado, Sierra 2500HD (2WD, 4WD)	Y	01-10	2250	R-R	Y	1.5	6781	-1003-	L-R	Y	2	7210	Heavy
C & K2500 (2WD, 4WD) (with rear drum brakes)		99-00	2025	R-R		2	6781						Heavy
C & K2500 (2WD, 4WD)		88-98	2025	R-R		2	6781						Heavy
C & R20, C & R2500 (2WD only)		73-87	2071 *	R-R		2	6781	4100	C-R	Y	1	6100	Heavy
K & V20, 2500 (4WD only)		73-87	-2040- ***	R-R		2	6873						Heavy

**DO NOT EXCEED THE VEHICLE'S RECOMMENDED GROSS VEHICLE WEIGHT RATING (GVWR)**

Minimum Tire to Frame Clearance Requirements (check both sides): \* = 7.50" \*\* = 3.00" \*\*\* = 9.50" += 8.00" ++ = 6.00" +++ = 6.50"

-0000- While Supplies Last # = Use spacer kit 2366 with heavy duty package or TRD

sw = Station Wagon  
rwd = Rear Wheel Drive

fwd = Front Wheel Drive  
A.C. = Air Conversion

Y = Yes

R-R = Ride-Rite  
C-R = Coil-Rite

S-R = Sport-Rite



# APPLICATION GUIDE

Make/Model	In-bed Hitch Compatible	Year	AIR LEVELING REAR					AIR LEVELING FRONT					Air Accessory Duty
			Rear Kit Part Number	Solution	No Drill	Time (hours)	Replacement Air Spring	Front Kit Part Number	Solution	No Drill	Time (hours)	Replacement Air Spring	
<b>Chevrolet/GMC Silverado, Sierra 3500 Pickup Truck</b>													
Silverado, Sierra 3500HD (2WD, 4WD)	Y	11-18	2596	R-R	Y	1.5	6401						Heavy
Silverado, Sierra 3500HD (2WD,4WD)	Y	01-10	2250	R-R	Y	1.5	6781	-1003-	L-R	Y	2	7210	Heavy
C & K3500 (2WD, 4WD)		88-00	2025	R-R		2	6781						Heavy
C & R30, C & R3500 (2WD only)		73-87	2071 *	R-R		2	6781						Heavy
C30 (2WD only)		67-87	2071 *	R-R		2	6781	4100	C-R	Y	1	6100	Heavy
K & V30, 3500 (4WD only)		73-87	-2040-***	R-R		2	6873						Heavy
<b>Chevrolet/GMC Commercial Vehicles (vehicles without factory bed)</b>													
C3500HD (2WD, 4WD) (wide track only)		11-12	2176 +	R-R		2	6781						Heavy
C2500HD, C3500HD (2WD, 4WD)		01-10	2249	R-R	Y	1.5	6781	-1003-	L-R	Y	2	7210	Heavy
C4500, C5500 (2WD only)		02-09	-2362-*	R-R		2	6781	-2451-	L-R	Y	1.5	6401	Heavy
G3500, G4500 (with dual rear wheels)		98-13	-2173-	R-R	Y	2	6762						Heavy
G30, G3500		70-95	-0830-	R-R		3	6859	4100	C-R	Y	1	6100	Heavy
<b>Chevrolet/GMC Motorhomes Class "C" Vans</b>													
G3500, G4500 (with dual rear wheels)		13-16	2557	R-R	Y	2	6766						Xtra
G3500, G4500 (with dual rear wheels)		98-12	-2173-	R-R	Y	2	6762						Xtra
G30, G3500		70-95	-0830-	R-R		3	6859	4100	C-R	Y	1	6100	Xtra
<b>Chevrolet/GMC Motorhomes Class "A" &amp; Step Vans</b>													
GP30 HD (cutaway) (10,500 to 12,300 GVWR)		93-96	-2080-	R-R	Y	2	6859	4100	C-R	Y	1	6100	Xtra
GP30 HD (cutaway) (14,500 GVWR)		93-96	-2085-	R-R	Y	2	0335	4100	C-R	Y	1	6100	Xtra
P30 (10,500 to 12,800 GVWR) (with jounce bumpers mounted at bottom of frame rails)		93-96	-2080-	R-R	Y	2	6859	4100	C-R	Y	1	6100	Xtra
P30 (14,500 to 17,000 GVWR) (with jounce bumpers mounted above leaf springs)		93-99	-2085-	R-R	Y	2	0335	4100	C-R	Y	1	6100	Xtra
P30 (with jounce bumpers mounted at bottom of frame rails)		63-92	-2080-	R-R	Y	2	6859	4100	C-R	Y	1	6100	Xtra
<b>Chrysler Cars / Vans / SUV</b>													
Aspen (2WD, 4WD)		07-09	-4152-	C-R	Y	1	6009						Light
Imperial, New Yorker 5th Ave. Landau and Salon		90-94	4105	C-R	Y	1	6013						Light
Le Baron, GTS, TC By Maserati		82-95	4105	C-R	Y	1	6013						Light
New Yorker		84-89	4105	C-R	Y	1	6013						Light

## DO NOT EXCEED THE VEHICLE'S RECOMMENDED GROSS VEHICLE WEIGHT RATING (GVWR)

Minimum Tire to Frame Clearance Requirements (check both sides): \* = 7.50" \*\* = 3.00" \*\*\* = 9.50" + = 8.00" ++ = 6.00" +++ = 6.50"

-0000- While Supplies Last # = Use spacer kit 2366 with heavy duty package or TRD

sw = Station Wagon  
rwd = Rear Wheel Drive

fwd = Front Wheel Drive  
A.C. = Air Conversion

Y = Yes

R-R = Ride-Rite  
C-R = Coil-Rite

S-R = Sport-Rite

# APPLICATION GUIDE

Make/Model	In-bed Hitch Compatible	Year	AIR LEVELING REAR					AIR LEVELING FRONT					Air Accessory Duty
			Rear Kit Part Number	Solution	No Drill	Time (hours)	Replacement Air Spring	Front Kit Part Number	Solution	No Drill	Time (hours)	Replacement Air Spring	
<b>Chrysler Cars / Vans / SUV (continued)</b>													
Town and Country		08-16	4169	C-R		1	6013						Light
Town and Country (sw only)		84-89	4105	C-R	Y	1	6013						Light
<b>Dodge Cars</b>													
400, 600, Lancer, Daytona		82-94	4105	C-R	Y	1	6013						Light
Aries		81-89	4105	C-R	Y	1	6013						Light
Dynasty, Spirit		90-94	4105	C-R	Y	1	6013						Light
Shadow		87-94	4105	C-R	Y	1	6013						Light
<b>Dodge Vans (For Ram vans after 2009, see Ram listing)</b>													
Caravan, Grand Caravan		08-17	4169	C-R		1	6013						Light
C/V		08-16	-4192-	C-R		1	6028						Light
B100, B150, B200, B250, B300, B350, 1500, 2500, 3500, MB300, MB400		77-03	-2109-	R-R	Y	1.5	6781						Standard
B100, B200, B300		71-76	-0830-	R-R		3	6859						Standard
<b>Dodge SUVs</b>													
Nitro (2WD, 4WD)		07-08	4146	C-R		1	6005						Light
Durango (2WD, 4WD)		11-18	4184	C-R		1	6014						Light
Durango (2WD, 4WD)		04-09	4152	C-R	Y	1	6009						Light
<b>Dodge Pickup Trucks (For Ram trucks after 2009, see Ram listing)</b>													
Ram 50		80-93	-1130- **	R-R	Y	2	6873						Standard
Dakota Quad Cab (2WD, 4WD)		05-09	-2379- +++	S-R		2	9000						Standard
Dakota (4WD only) (not crew cab)		97-03	-2162- +++	S-R		2	9002						Standard
<b>Dodge 1500 Pickup Truck (For Ram trucks after 2009, see Ram listing)</b>													
Ram 1500 (2WD, 4WD)		09	2595	R-R	Y	1.5	9047						Standard
Ram 1500 (2WD, 4WD)		09	4185	C-R	Y	1	6133						Standard
Ram 1500 (2WD, 4WD)		02-08	2286	R-R	Y	1.5	6781						Standard
Ram 1500 Mega Cab (2WD, 4WD)		06-08	2299	R-R	Y	1.5	6401						Standard
Ram 1500 (2WD only)		94-01	2071 *	R-R		2	6781						Standard
Ram 1500 (2WD only)		94-01	-2162- +++	S-R		2	9002						Standard
Ram 1500 (4WD only)		94-01	2071 *	R-R		2	6781						Standard
D & W 100, 150, Ram 1500 (2WD, 4WD)		69-93	2071 *	R-R		2	6781						Standard

**DO NOT EXCEED THE VEHICLE'S RECOMMENDED GROSS VEHICLE WEIGHT RATING (GVWR)**

Minimum Tire to Frame Clearance Requirements (check both sides): \* = 7.50" \*\* = 3.00" \*\*\* = 9.50" += 8.00" ++ = 6.00" +++ = 6.50"

-0000- While Supplies Last # = Use spacer kit 2366 with heavy duty package or TRD

sw = Station Wagon  
rwd = Rear Wheel Drive

fwd = Front Wheel Drive  
A.C. = Air Conversion

Y = Yes

R-R = Ride-Rite  
C-R = Coil-Rite

S-R = Sport-Rite

# APPLICATION GUIDE

Make/Model	In-bed Hitch Compatible	Year	AIR LEVELING REAR					AIR LEVELING FRONT					Air Accessory Duty
			Rear Kit Part Number	Solution	No Drill	Time (hours)	Replacement Air Spring	Front Kit Part Number	Solution	No Drill	Time (hours)	Replacement Air Spring	
<b>Dodge 2500 Pickup Truck (For Ram trucks after 2009, see Ram listing)</b>													
Ram 2500 (2WD only)	Y	03-09	2299	R-R	Y	1.5	6401						Heavy
Ram 2500 (4WD only)	Y	03-09	2299	R-R	Y	1.5	6401	-1004-	L-R	Y	2	7215	Heavy
Ram 2500 (2WD only)		94-02	2071 *	R-R		2	6781						Heavy
Ram 2500 (4WD only)		94-02	2071 *	R-R		2	6781						Heavy
Ram 2500 (2WD, 4WD) (with contact overload springs)		94-98	2220	R-R	Y	2	6781						Heavy
D & W 200, 250, Ram 2500 (2WD, 4WD)		69-93	2071 *	R-R		2	6781						Heavy
<b>Dodge 3500 Pickup Truck (For Ram trucks after 2009, see Ram listing)</b>													
Ram 3500 (2WD only)	Y	03-09	2299	R-R	Y	1.5	6401						Heavy
Ram 3500 (4WD only)	Y	03-09	2299	R-R	Y	1.5	6401	-1004-	L-R	Y	2	7215	Heavy
Ram 3500 (2WD only)		94-02	2071 *	R-R		2	6781						Heavy
Ram 3500 (4WD only)		94-02	2071 *	R-R		2	6781						Heavy
D & W 300, 350, Ram 3500 (2WD, 4WD)		69-93	2071 *	R-R		2	6781						Heavy
<b>Dodge Commercial Vehicles (vehicles without factory bed) (For Ram trucks after 2009, see Ram listing)</b>													
Ram 3500 HD (2WD, 4WD)		07-09	2478 +	R-R		2	6781						Heavy
Ram 4500, 5500 (2WD, 4WD) (requires 2" clearance above frame)		07-09	2404 ***	R-R		2	7714						Heavy
Ram 2500 (2WD, 4WD) (not dually, with box delete)		04-08	2299	R-R	Y	1.5	6401						Heavy
Ram 3500 (4WD only) (dually only, with box delete)		06-12	2299	R-R	Y	1.5	6401						Heavy
D3500, W3500 (2WD, 4WD) (cab & chassis)		94-02	2220	R-R	Y	2	6781						Heavy
<b>Dodge Motorhomes Class "C" Vans</b>													
B100, B150, B200, B250, B300, B350, 1500, 2500, 3500, MB300, MB400		77-03	-2109-	R-R	Y	1.5	6781						Standard
B100, B200, B300		71-76	-0830-	R-R		3	6859						Standard
<b>Ford Cars</b>													
Country Squire		83-97	4108	C-R	Y	1	6003						Light
Crown Victoria (with rear coil springs)		98-08	4107	C-R	Y	1	6021						Light
Crown Victoria		83-97	4108	C-R	Y	1	6003						Light
Fusion		06-12	4169	C-R		1.5	6013						Light
LTD		83-86	4103	C-R	Y	1	6014						Light
Mustang		79-03	4103	C-R	Y	1	6014						Light
Taurus (sw only)		86-98	4105	C-R	Y	1	6013						Light

## DO NOT EXCEED THE VEHICLE'S RECOMMENDED GROSS VEHICLE WEIGHT RATING (GVWR)

Minimum Tire to Frame Clearance Requirements (check both sides): \* = 7.50" \*\* = 3.00" \*\*\* = 9.50" + = 8.00" ++ = 6.00" +++ = 6.50"

-0000- While Supplies Last # = Use spacer kit 2366 with heavy duty package or TRD

sw = Station Wagon  
rwd = Rear Wheel Drive

fwd = Front Wheel Drive  
A.C. = Air Conversion

Y = Yes

R-R = Ride-Rite  
C-R = Coil-Rite

S-R = Sport-Rite

# APPLICATION GUIDE

Make/Model	In-bed Hitch Compatible	Year	AIR LEVELING REAR					AIR LEVELING FRONT					Air Accessory Duty
			Rear Kit Part Number	Solution	No Drill	Time (hours)	Replacement Air Spring	Front Kit Part Number	Solution	No Drill	Time (hours)	Replacement Air Spring	
<b>Ford Cars (continued)</b>													
Thunderbird		92-97	4105	C-R	Y	1	6013						Light
Thunderbird		80-88	4106	C-R	Y	1	6015						Light
<b>Ford Vans</b>													
Windstar		98-03	4106	C-R	Y	1	6015						Light
E150		08-14						4101	C-R	Y	1	6102	Standard
E150		75-07	-2171-	S-R		2	7076	4101	C-R	Y	1	6102	Standard
E100, E150 (may require tailpipe modification)		75-91	-2032-	R-R	Y	1.5	6859	4101	C-R	Y	1	6102	Standard
E250		98-14	-2165-	S-R		2	9002	4101	C-R	Y	1	6102	Standard
E250 (may require tailpipe modification)		75-91	-2032-	R-R	Y	1.5	6859	4101	C-R	Y	1	6102	Standard
E350 (with single rear wheels)		98-14	-2181-	S-R		2	9000	4101	C-R	Y	1	6102	Standard
E350 (may require tailpipe modification)		75-91	-2032-	R-R	Y	1.5	6859	4101	C-R	Y	1	6102	Standard
<b>Ford SUVs</b>													
Bronco (4WD only) (full size)		90-96	2071 *	R-R		2	6781	4102	C-R	Y	1	6111	Standard
Bronco (2WD, 4WD)		80-90						4102	C-R	Y	1	6111	Standard
Excursion (2WD only)		00-06	-2255-	R-R	Y	2	6781						Standard
Excursion (4WD only)		00-06	2251	R-R	Y	2	6781						Standard
Expedition (2WD, 4WD) (with rear coil springs)		97-02	4134	C-R	Y	1	6022						Light
<b>Ford Pickup Trucks</b>													
Ranger (2WD, 4WD) (not for use with composite leaf) (not SuperCab 4WD with 6' bed)		83-11	-2531- +++	S-R		2	9000						Standard
F100 (2WD, 4WD)		68-79	2071 *	R-R		2	6781	4102	C-R	Y	1	6111	Standard
<b>Ford F150 Pickup Truck</b>													
F150 (2WD, 4WD) (Not Raptor)		15-18	2582 +	R-R	Y	1.5	6781						Standard
F150 (2WD, 4WD) (Not Raptor or FX2)		09-14	2525 +	R-R	Y	1.5	6781						Standard
F150 (2WD, 4WD) (with B&W hitch only)		09-14	2542 +	R-R	Y	1.5	6781						Standard
F150 Raptor (4WD only)		09-14	2565 +	S-R	Y	1.5	9055						Standard
F150 (2WD, 4WD) (not FX2)		04-08	2350 #	R-R	Y	1.5	6397						Standard
F150, F150 Heritage (2WD, 4WD)		97-04	-2320- ++	S-R		2	9000						Standard
F150 (2WD, 4WD)		68-96	2071 *	R-R		2	6781	4102	C-R	Y	1	6111	Standard

**DO NOT EXCEED THE VEHICLE'S RECOMMENDED GROSS VEHICLE WEIGHT RATING (GVWR)**

Minimum Tire to Frame Clearance Requirements (check both sides): \* = 7.50" \*\* = 3.00" \*\*\* = 9.50" += 8.00" ++ = 6.00" +++ = 6.50"

-0000- While Supplies Last # = Use spacer kit 2366 with heavy duty package or TRD

sw = Station Wagon  
rwd = Rear Wheel Drive

fwd = Front Wheel Drive  
A.C. = Air Conversion

Y = Yes

R-R = Ride-Rite  
C-R = Coil-Rite

S-R = Sport-Rite

# APPLICATION GUIDE

Make/Model	In-bed Hitch Compatible	Year	AIR LEVELING REAR					AIR LEVELING FRONT					Air Accessory Duty
			Rear Kit Part Number	Solution	No Drill	Time (hours)	Replacement Air Spring	Front Kit Part Number	Solution	No Drill	Time (hours)	Replacement Air Spring	
<b>Ford F250 Pickup Truck</b>													
F250 Under 8500 GVWR (2WD, 4WD)		97-03	<b>-2320-++</b>	S-R		2	9000						Heavy
F250 Under 8500 GVWR (2WD only)		69-96	<b>2071 *</b>	R-R		2	6781	<b>4101</b>	C-R	Y	1	6102	Heavy
F250 Under 8500 GVWR (4WD only)		69-96	<b>2071 *</b>	R-R		2	6781						Heavy
F250 (2WD only)	Y	17-18	<b>2600 *</b>	R-R	Y	1.5	6781		C-R	Y	1		Heavy
F250 (2WD only)	Y	11-16	<b>2597</b>	R-R	Y	2	6401	<b>4101</b>	C-R	Y	1	6102	Heavy
F250 (2WD only)	Y	08-10	<b>2550</b>	R-R	Y	1.5	6401	<b>4101</b>	C-R	Y	1	6102	Heavy
F250 (2WD only)	Y	05-07	<b>-2398-</b>	R-R		2	6401	<b>4101</b>	C-R	Y	1	6102	Heavy
F250 Over 8500 GVWR (2WD only)	Y	99-04	<b>2550</b>	R-R	Y	1.5	6401	<b>4101</b>	C-R	Y	1	6102	Heavy
F250 Over 8500 GVWR (2WD only)		84-98	<b>2071 *</b>	R-R		2	6781	<b>4101</b>	C-R	Y	1	6102	Heavy
F250 Over 8500 GVWR (2WD only)		69-83	<b>2071 *</b>	R-R		2	6781						Heavy
F250 (4WD only)	Y	17-18	<b>2600 *</b>	R-R	Y	1.5	6781	<b>4160 or 4187 if snow plow prep</b>	C-R	Y	1	6125	Heavy
F250 (4WD only)	Y	11-16	<b>2597</b>	R-R	Y	2	6401	<b>4160</b>	C-R	Y	1	6125	Heavy
F250 (4WD only)	Y	08-10	<b>2550</b>	R-R	Y	1.5	6401	<b>4160 or 4187 if snow plow prep</b>	C-R	Y	1	6125	Heavy
F250 (4WD only)	Y	05-07	<b>2400</b>	R-R	Y	1.5	6401	<b>4160 or 4187 if snow plow prep</b>	C-R	Y	1	6125	Heavy
F250 Over 8500 GVWR (4WD only)	Y	99-04	<b>2550</b>	R-R	Y	1.5	6401	<b>2223</b>	R-R		2	6762	Heavy
F250 Over 8500 GVWR (4WD only)		84-04	<b>2071 *</b>	R-R		2	6781	<b>2223</b>	R-R		2	6762	Heavy
F250 Over 8500 GVWR (4WD only)		69-83	<b>2071 *</b>	R-R		2	6781						Heavy

## DO NOT EXCEED THE VEHICLE'S RECOMMENDED GROSS VEHICLE WEIGHT RATING (GVWR)

Minimum Tire to Frame Clearance Requirements (check both sides): \* = 7.50" \*\* = 3.00" \*\*\* = 9.50" + = 8.00" ++ = 6.00" +++ = 6.50"

-0000- While Supplies Last # = Use spacer kit 2366 with heavy duty package or TRD

sw = Station Wagon  
rwd = Rear Wheel Drive

fwd = Front Wheel Drive  
A.C. = Air Conversion

Y = Yes

R-R = Ride-Rite  
C-R = Coil-Rite

S-R = Sport-Rite



# APPLICATION GUIDE

Make/Model	In-bed Hitch Compatible	Year	AIR LEVELING REAR					AIR LEVELING FRONT					Air Accessory Duty
			Rear Kit Part Number	Solution	No Drill	Time (hours)	Replacement Air Spring	Front Kit Part Number	Solution	No Drill	Time (hours)	Replacement Air Spring	
<b>Ford F350 Pickup Truck</b>													
F350 (2WD only)	Y	17-18	2600 *	R-R	Y	1.5	6781		C-R	Y	1		Heavy
F350 (2WD only) (not V10 gas w/ extended cab and 8' bed)	Y	11-16	2597	R-R	Y	1.5	6401	4101	C-R	Y	1	6102	Heavy
F350 (2WD only)	Y	08-10	2550	R-R	Y	1.5	6401	4101	C-R	Y	1	6102	Heavy
F350 (2WD only)	Y	06-07	-2398-	R-R	Y	1.5	6401	4101	C-R	Y	1	6102	Heavy
F350 (2WD only)	Y	05	-2398-	R-R	Y	1.5	6401	4160 or 4187 if snow plow prep	C-R	Y	1	6125	Heavy
F350 (2WD only) (not V10 gas w/ extended cab and 8' bed)	Y	99-04	2550	R-R	Y	1.5	6401	4101	C-R	Y	1	6102	Heavy
F350 (2WD only)		70-98	2071 *	R-R		2	6781	4101	C-R	Y	1	6102	Heavy
F350 (2WD only)		63-69	2071 *	R-R		2	6781		C-R	Y	1		Heavy
F350 (4WD only)	Y	17-18	2600 *	R-R	Y	1.5	6781	4160 or 4187 if snow plow prep	C-R	Y	1	6125	Heavy
F350 (4WD only)	Y	11-16	2597	R-R	Y	1.5	6401	4160 or 4187 if snow plow prep	C-R	Y	1	6125	Heavy
F350 (4WD only)	Y	08-10	2550	R-R	Y	1.5	6401	4160 or 4187 if snow plow prep	C-R	Y	1	6125	Heavy
F350 (4WD only)	Y	05-07	2400	R-R	Y	1.5	6401	4160 or 4187 if snow plow prep	C-R	Y	1	6125	Heavy
F350 (4WD only)	Y	99-04	2550	R-R	Y	1.5	6401	2223	R-R		2	6762	Heavy
F350 (4WD only)		84-98	2071 *	R-R		2	6781	2223	R-R		2	6762	Heavy
F350 (4WD only)		63-83	2071 *	R-R		2	6781						Heavy

**DO NOT EXCEED THE VEHICLE'S RECOMMENDED GROSS VEHICLE WEIGHT RATING (GVWR)**

Minimum Tire to Frame Clearance Requirements (check both sides): \* = 7.50" \*\* = 3.00" \*\*\* = 9.50" += 8.00" ++ = 6.00" +++ = 6.50"

-0000- While Supplies Last # = Use spacer kit 2366 with heavy duty package or TRD

sw = Station Wagon  
rwd = Rear Wheel Drive

fwd = Front Wheel Drive  
A.C. = Air Conversion

Y = Yes

R-R = Ride-Rite  
C-R = Coil-Rite

S-R = Sport-Rite

# APPLICATION GUIDE

Make/Model	In-bed Hitch Compatible	Year	AIR LEVELING REAR					AIR LEVELING FRONT					Air Accessory Duty
			Rear Kit Part Number	Solution	No Drill	Time (hours)	Replacement Air Spring	Front Kit Part Number	Solution	No Drill	Time (hours)	Replacement Air Spring	
<b>Ford F450 Pickup Truck</b>													
F450 (2WD only)	Y	17-18	2601 ***	R-R	Y	1.5	6873		C-R	Y	1		Heavy
F450 (2WD only)	Y	14-16	2583	R-R	Y	1.5	7701	4101	C-R	Y	1	6102	Heavy
F450 (2WD only)	Y	11-13	2597	R-R	Y	1.5	6401	4101	C-R	Y	1	6102	Heavy
F450 (2WD only)	Y	08-10	2446	R-R		2	7701	4101	C-R	Y	1	6102	Heavy
F450 (4WD only)	Y	17-18	2601 ***	R-R	Y	1.5	6873	4160	C-R	Y	1	6025	Heavy
F450 (4WD only)	Y	14-16	2583	R-R	Y	1.5	7701	4160	C-R	Y	1	6025	Heavy
F450 (4WD only)	Y	11-13	2597	R-R	Y	1.5	6401	4160	C-R	Y	1	6025	Heavy
F450 (4WD only)	Y	08-10	2446	R-R		2	7701	4160	C-R	Y	1	6025	Heavy
<b>Ford Commercial Vehicles (vehicles without factory bed)</b>													
E250 (cutaway)		07-08	2061	R-R	Y	1.5	6764	4101	C-R	Y	1	6102	Heavy
E350 (with dual rear wheels)		92-14	2061	R-R	Y	1.5	6764	4101	C-R	Y	1	6102	Heavy
E350 (may require tailpipe modification)		75-91	-2032-	R-R	Y	1.5	6859	4101	C-R	Y	1	6102	Heavy
E450		08-17	2458	R-R	Y	1.5	6397	4101	C-R	Y	1	6102	Heavy
E450		96-07	-2377-	R-R	Y	1.5	6397	4101	C-R	Y	1	6102	Heavy
E450 (requires 2" clearance above frame)		96-17	2153 +	R-R		2	6781	4101	C-R	Y	1	6102	Heavy
F350 (2WD, 4WD)		05-08	2176 *	R-R		2	6781	4160	C-R	Y	1	6125	Heavy
F350 (2WD only)		99-04	2176 *	R-R		2	6781	4101	C-R	Y	1	6102	Heavy
F350 (4WD only)		99-04	2176 *	R-R		2	6781	2223	R-R		2	6762	Heavy
F450 (2WD, 4WD)		05-17	2176 *	R-R		2	6781	4160	C-R	Y	1	6125	Heavy
F450 (2WD, 4WD)		99-04	2176 *	R-R		2	6781						Heavy
F550 (2WD, 4WD) (requires 2" clearance above frame)		05-17	2404 ***	R-R		2	7714	4160	C-R	Y	1	6125	Heavy
F550 (2WD, 4WD) (requires 2" clearance above frame)		99-04	2404 ***	R-R		2	7714						Heavy
F59		11-12	2170 +	R-R		2	6781	2070	R-R		2	0335	Heavy
<b>Ford Motorhomes Class "C" Vans</b>													
E350 (with dual rear wheels)		92-16	2061	R-R	Y	1.5	6764	4101	C-R	Y	1	6102	Heavy
E350 (may require tailpipe modification)		75-91	-2032-	R-R	Y	1.5	6859	4101	C-R	Y	1	6102	Heavy
E450		08-17	2458	R-R	Y	1.5	6397	4101	C-R	Y	1	6102	Heavy
E450		96-07	-2377-	R-R	Y	1.5	6397	4101	C-R	Y	1	6102	Heavy
E450 (requires 2" clearance above frame)		96-17	2153 +	R-R		2	6781	4101	C-R	Y	1	6102	Heavy

## DO NOT EXCEED THE VEHICLE'S RECOMMENDED GROSS VEHICLE WEIGHT RATING (GVWR)

Minimum Tire to Frame Clearance Requirements (check both sides): \* = 7.50" \*\* = 3.00" \*\*\* = 9.50" + = 8.00" ++ = 6.00" +++ = 6.50"

-0000- While Supplies Last # = Use spacer kit 2366 with heavy duty package or TRD

sw = Station Wagon  
rwd = Rear Wheel Drive

fwd = Front Wheel Drive  
A.C. = Air Conversion

Y = Yes

R-R = Ride-Rite  
C-R = Coil-Rite

S-R = Sport-Rite

# APPLICATION GUIDE

Make/Model	In-bed Hitch Compatible	Year	AIR LEVELING REAR					AIR LEVELING FRONT					Air Accessory Duty
			Rear Kit Part Number	Solution	No Drill	Time (hours)	Replacement Air Spring	Front Kit Part Number	Solution	No Drill	Time (hours)	Replacement Air Spring	
<b>Ford Motorhomes Class "A"</b>													
E33 (with front coil springs)		92-96	-2061-	R-R	Y	1.5	6764	4101	C-R	Y	1	6102	Heavy
E33 (with front coil springs)		86-91	-2032-	R-R	Y	1.5	6859	4101	C-R	Y	1	6102	Heavy
F53 (16,000 to 22,000 GVWR) (not Thor m/h for rear kit)		08-12	2170 +	R-R		2	6781	-2475-	R-R		2	6873	Heavy
F53 (16,000 to 22,000 GVWR) (not Thor m/h for rear kit)		99-07	2170 +	R-R		2	6781	2070	R-R		2	0335	Heavy
F53		90-98	-2068- +	R-R		2	6859	2070	R-R		2	0335	Heavy
<b>Freightliner / Oshkosh / John Deere Motorhomes Class "A"</b>													
"M" and "X" chassis (not XC21) (below 22,000 GVWR)		94-98	2071 *	R-R		2	6781						Heavy
<b>Honda Vans / SUVs</b>													
Odyssey		05-10	4179	C-R		1.5	6020						Light
Odyssey		99-04	4138	C-R		1.5	6017						Light
Passport (2WD, 4WD)		98-02	4136	C-R	Y	1	6014						Light
Pilot		05-10	4179	C-R		1.5	6020						Light
Pilot		03-04	4138	C-R	Y	1	6017						Light
<b>HUMMER SUVs</b>													
H2, H2 SUT (with rear coil springs)		07-09	4108	C-R	Y	1	6003						Light
H2, H2 SUT (with rear coil springs)		03-06	4108	C-R	Y	1	6003						Light
<b>Hyundai Car / Van / SUVs</b>													
Accent		07-12	4136	C-R	Y	1	6014						Light
Entourage		07-09	4138	C-R		1.5	6017						Light
Santa Fe, Santa Fe Sport		07-16	4170	C-R		1.5	6117						Light
Tucson		16-17	4176	C-R	Y	1	6027						Light
Veracruz		07-12	4170	C-R		1	6117						Light
<b>Infiniti SUVs</b>													
FX45 (2WD, 4WD)		03-08	4118	C-R	Y	1	6118						Light
QX56		05-09	4150	C-R	Y	1	6023						Light
QX80		16	4164	C-R	Y	1	6009						Light
<b>Isuzu SUVs / Truck</b>													
290i, 370i (2WD, 4WD)		06-09	2384	R-R	Y	1.5	6397						Standard
Amigo		98-00	4103	C-R	Y	1	6014						Light
Axiom		02-03	4136	C-R	Y	1	6014						Light
Rodeo, Rodeo Sport		98-04	4136	C-R	Y	1	6014						Light
Trooper		92-97	4106	C-R	Y	1	6015						Light

**DO NOT EXCEED THE VEHICLE'S RECOMMENDED GROSS VEHICLE WEIGHT RATING (GVWR)**

Minimum Tire to Frame Clearance Requirements (check both sides): \* = 7.50" \*\* = 3.00" \*\*\* = 9.50" += 8.00" ++ = 6.00" +++ = 6.50"

-0000- While Supplies Last # = Use spacer kit 2366 with heavy duty package or TRD

sw = Station Wagon  
rwd = Rear Wheel Drive

fwd = Front Wheel Drive  
A.C. = Air Conversion

Y = Yes

R-R = Ride-Rite  
C-R = Coil-Rite

S-R = Sport-Rite

# APPLICATION GUIDE

Make/Model	In-bed Hitch Compatible	Year	AIR LEVELING REAR					AIR LEVELING FRONT					Air Accessory Duty
			Rear Kit Part Number	Solution	No Drill	Time (hours)	Replacement Air Spring	Front Kit Part Number	Solution	No Drill	Time (hours)	Replacement Air Spring	
<b>Jeep SUVs</b>													
Commander (2WD, 4WD)		06-10	4157	C-R	Y	1	6005						Light
Grand Cherokee (2WD, 4WD) (not "Overland")		11-18	4184	C-R	Y	1	6014						Light
Grand Cherokee (2WD, 4WD)		05-10	4157	C-R		1.5	6005						Light
Grand Cherokee (2WD, 4WD) (not "Up Country")		92-98	4118	C-R	Y	1	6118						Light
Grand Wagoneer (2WD, 4WD)		92-98	4118	C-R	Y	1	6118						Light
Liberty (2WD, 4WD)		08-12	4170	C-R		1.5	6017						Light
Liberty (2WD, 4WD)		02-07	4146	C-R		1.5	6005						Light
Summit (sw only)		92-93	4105	C-R	Y	1	6013						Light
Wrangler (except Rubicon) (2WD, 4WD)		07-17	4173	C-R	Y	1	6106						Light
Wrangler Rubicon (4WD only)		07-17	4172	C-R	Y	1	6107						Light
Wrangler Unlimited (except Rubicon) (2WD, 4WD)		07-17	4173	C-R	Y	1	6106						Light
Wrangler Unlimited Rubicon (4WD only)		07-17	4172	C-R	Y	1	6107						Light
Wrangler (2WD, 4WD)		97-06	4157	C-R		1.5	6005						Light
<b>Kia Van / SUV</b>													
Sportage		16-18	4176	C-R		1	6027						Light
Sedona		06-16	4138	C-R		1.5	6017						Light
<b>Land Rover SUVs</b>													
Defender 90		90-97	4121	C-R	Y	1	6003						Light
Discovery (with rear coil springs)		90-04	4121	C-R	Y	1	6003						Light
Range Rover		90-96	4121	C-R	Y	1	6003						Light
<b>Lexus SUVs</b>													
LX 450		96-98	4124	C-R	Y	1	6007						Light
LX 470		99-07	4124	C-R	Y	1	6007						Light
LX 570		13-18	4135	C-R	Y	2	6024						Light
LX 570		09-12	4164	C-R	Y	2	6009						Light
<b>Lincoln Cars / CUVs / Truck</b>													
Continental (with rear coil springs)		82-88	4106	C-R	Y	1	6015						Light
Mark IV (with rear coil springs)		84-87	4106	C-R	Y	1	6015						Light
Mark LT (2WD, 4WD)		05-08	2350	S-R	Y	1.5	6397						Standard
MKC		15-17	4175	C-R	Y	1	6026						Light
MKS		09-16	-4178-	C-R	Y	1	6014						Light

## DO NOT EXCEED THE VEHICLE'S RECOMMENDED GROSS VEHICLE WEIGHT RATING (GVWR)

Minimum Tire to Frame Clearance Requirements (check both sides): \* = 7.50" \*\* = 3.00" \*\*\* = 9.50" + = 8.00" ++ = 6.00" +++ = 6.50"

-0000- While Supplies Last # = Use spacer kit 2366 with heavy duty package or TRD

sw = Station Wagon  
rwd = Rear Wheel Drive

fwd = Front Wheel Drive  
A.C. = Air Conversion

Y = Yes

R-R = Ride-Rite  
C-R = Coil-Rite

S-R = Sport-Rite

# APPLICATION GUIDE

Make/Model	In-bed Hitch Compatible	Year	AIR LEVELING REAR					AIR LEVELING FRONT					Air Accessory Duty
			Rear Kit Part Number	Solution	No Drill	Time (hours)	Replacement Air Spring	Front Kit Part Number	Solution	No Drill	Time (hours)	Replacement Air Spring	
<b>Lincoln Cars / CUVs / Truck (continued)</b>													
MKT		09-15	-4178-	C-R	Y	1	6014						Light
MKX		07-11	-4171-	C-R	Y	3.5	6020						Light
MKZ		11-17	4170	C-R	Y	1	6017						Light
Towncar		80-89	4108	C-R	Y	1	6003						Light
<b>Mazda Van / Truck</b>													
Mazda5		06-13	4168	C-R	Y	1	6027						Light
MPV		96-98	4105	C-R	Y	1	6013						Light
Pickup (2WD only)		72-90	-1130- **	S-R	Y	1.5	6873						Standard
<b>Mercury Cars / Van</b>													
Capri		79-86	4103	C-R	Y	1	6014						Light
Colony Park		83-97	4108	C-R	Y	1	6003						Light
Cougar		92-97	4105	C-R	Y	1	6013						Light
Cougar		80-88	4106	C-R	Y	1	6015						Light
Grand Marquis		98-08	4107	C-R	Y	1	6021						Light
Grand Marquis		83-97	4108	C-R	Y	1	6003						Light
Marquis		83-86	4103	C-R	Y	1	6014						Light
Milan		06-08	4168	C-R	Y	1	6027						Light
Sable (sw only)		86-98	4105	C-R	Y	1	6013						Light
<b>Mitsubishi SUVs</b>													
Expo (2WD, 4WD)		92-93	4105	C-R	Y	1	6013						Light
Outlander		12	4182	C-R	Y	1	6026						Light
Outlander		07-09	4182	C-R	Y	1	6026						Light
<b>Mitsubishi Pickup Trucks</b>													
Raider Double Cab (2WD, 4WD)		06-09	-2379- +++	S-R		2	9000						Standard
Pickup (2WD only)		69-96	-1130- **	R-R	Y	1.5	6873						Standard

**DO NOT EXCEED THE VEHICLE'S RECOMMENDED GROSS VEHICLE WEIGHT RATING (GVWR)**

Minimum Tire to Frame Clearance Requirements (check both sides): \* = 7.50" \*\* = 3.00" \*\*\* = 9.50" += 8.00" ++ = 6.00" +++ = 6.50"

-0000- While Supplies Last # = Use spacer kit 2366 with heavy duty package or TRD

sw = Station Wagon  
rwd = Rear Wheel Drive

fwd = Front Wheel Drive  
A.C. = Air Conversion

Y = Yes

R-R = Ride-Rite  
C-R = Coil-Rite

S-R = Sport-Rite



# APPLICATION GUIDE

Make/Model	In-bed Hitch Compatible	Year	AIR LEVELING REAR					AIR LEVELING FRONT					Air Accessory Duty
			Rear Kit Part Number	Solution	No Drill	Time (hours)	Replacement Air Spring	Front Kit Part Number	Solution	No Drill	Time (hours)	Replacement Air Spring	
<b>Nissan Cars</b>													
Altima		05-15	4105	C-R	Y	1	6013						Light
Maxima		16-17	4105	C-R	Y	1	6013						Light
Maxima		05-08	4105	C-R	Y	1	6013						Light
<b>Nissan Vans</b>													
NV 1500, 2500		12-18	-2551-	R-R	Y	1	6766						Light
Quest		12-16	4188	C-R	Y	1	6028						Light
Quest		04-09	4118	C-R	Y	1	6118						Light
<b>Nissan SUVs</b>													
Armada (2WD, 4WD)		06-18	4150	C-R	Y	1	6023						Light
Murano (2WD, 4WD)		16-17.5	4118	C-R	Y	1	6118						Light
Murano (2WD, 4WD)		15	-4197-	C-R	Y	1	6124						Light
Murano (2WD, 4WD)		03-08	4118	C-R	Y	1	6018						Light
Pathfinder (2WD, 4WD)		13-17	4118	C-R	Y	1	6018						Light
Pathfinder (2WD, 4WD)		06-12	4166	C-R	Y	1	6021						Light
Pathfinder Armada (2WD, 4WD)		04-05	4150	C-R	Y	1	6023						Light
Pathfinder (2WD, 4WD)		87-95	4106	C-R	Y	1	6015						Light
Rogue (2WD, 4WD)		14-18	4175	C-R	Y	1	6026						Light
Xterra (2WD, 4WD)		05-15	-2409-	S-R	Y	1.5	9002						Light
<b>Nissan Pickup Trucks</b>													
Frontier (2WD, 4WD)		05-17	2558	R-R	Y	1.5	6766						Standard
Frontier (2WD only)		01-04	-2293-	S-R	Y	1.5	9002						Standard
Pickup (2WD only)		69-96	-1130- **	R-R	Y	1.5	6873						Standard
Titan (2WD, 4WD)		04-15	2355	R-R	Y	1.5	6781						Standard
<b>Oldsmobile Cars</b>													
Aurora		95-04	4105	C-R	Y	1	6013						Light
Bravada (2WD, 4WD) (with rear coil springs)		02-05	4106	C-R	Y	1	6015						Light
Calais, Cutlass, Cutlass Supreme (not sw)		73-87	4114	C-R	Y	1	6008						Light
Cutlass Cierra		82-96	4103	C-R	Y	1	6014						Light
Cutlass Cruiser (sw only) (fwd only)		84-95	4103	C-R	Y	1	6014						Light
Delta 88, 98 (fwd only)		85-99	4107	C-R	Y	1	6021						Light
LSS		96-01	4107	C-R	Y	1	6021						Light
Toronado		79-85	4106	C-R	Y	1	6015						Light

## DO NOT EXCEED THE VEHICLE'S RECOMMENDED GROSS VEHICLE WEIGHT RATING (GVWR)

Minimum Tire to Frame Clearance Requirements (check both sides): \* = 7.50" \*\* = 3.00" \*\*\* = 9.50" + = 8.00" ++ = 6.00" +++ = 6.50"

-0000- While Supplies Last # = Use spacer kit 2366 with heavy duty package or TRD

sw = Station Wagon  
rwd = Rear Wheel Drive

fwd = Front Wheel Drive  
A.C. = Air Conversion

Y = Yes

R-R = Ride-Rite  
C-R = Coil-Rite

S-R = Sport-Rite

# APPLICATION GUIDE

Make/Model	In-bed Hitch Compatible	Year	AIR LEVELING REAR					AIR LEVELING FRONT					Air Accessory Duty
			Rear Kit Part Number	Solution	No Drill	Time (hours)	Replacement Air Spring	Front Kit Part Number	Solution	No Drill	Time (hours)	Replacement Air Spring	
<b>Plymouth Cars / Truck</b>													
Acclaim		89-95	4105	C-R	Y	1	6013						Light
Arrow		80-93	-1130- **	R-R	Y	1.5	6873						Standard
Caravelle		85-88	4105	C-R	Y	1	6013						Light
Reliant		81-94	4105	C-R	Y	1	6013						Light
Sundance		87-93	4105	C-R	Y	1	6013						Light
<b>Pontiac Cars</b>													
6000		82-91	4103	C-R	Y	1	6014						Light
Bonneville (fwd only)		00-05	4105	C-R	Y	1	6013						Light
Bonneville (fwd only)		87-99	4107	C-R	Y	1	6021						Light
Firebird, Trans Am		82-02	4103	C-R	Y	1	6014						Light
Grand Prix		73-87	4114	C-R	Y	1	6008						Light
Grand Prix		65-68	4114	C-R	Y	1	6008						Light
<b>Ram Vans (For Dodge vans before 2010, see Dodge listing)</b>													
ProMaster City		15-17	4199	C-R		1	6114						Light
Caravan, Grand Caravan		08-16	4169	C-R		1	6013						Light
C/V		08-16	4192	C-R		1	6028						Light
B100, B150, B200, B250, B300, B350, 1500, 2500, 3500, MB300, MB400		77-03	-2109-	R-R	Y	1.5	6781						Standard
B100, B200, B300		71-76	-0830-	R-R		3	6859						Standard
<b>Ram Pickup Trucks (Ford Dodge trucks before 2010 see Dodge listing)</b>													
Dakota Quad Cab (2WD, 4WD)		10-11	-2379- +++	S-R		2	9000						Standard
<b>Ram 1500 Pickup Truck (For Dodge trucks before 2010, see Dodge listing)</b>													
Ram 1500 (2WD, 4WD) (not Power Ram or Rebel)		10-18	2595	R-R	Y	2	9047						Standard
Ram 1500 (2WD, 4WD) (not Power Ram or Rebel)		10-18	4185	C-R	Y	1	6133						Standard

**DO NOT EXCEED THE VEHICLE'S RECOMMENDED GROSS VEHICLE WEIGHT RATING (GVWR)**

Minimum Tire to Frame Clearance Requirements (check both sides): \* = 7.50" \*\* = 3.00" \*\*\* = 9.50" += 8.00" ++ = 6.00" +++ = 6.50"

-0000- While Supplies Last # = Use spacer kit 2366 with heavy duty package or TRD

sw = Station Wagon  
rwd = Rear Wheel Drive

fwd = Front Wheel Drive  
A.C. = Air Conversion

Y = Yes

R-R = Ride-Rite  
C-R = Coil-Rite

S-R = Sport-Rite

# APPLICATION GUIDE

Make/Model	In-bed Hitch Compatible	Year	AIR LEVELING REAR					AIR LEVELING FRONT					Air Accessory Duty
			Rear Kit Part Number	Solution	No Drill	Time (hours)	Replacement Air Spring	Front Kit Part Number	Solution	No Drill	Time (hours)	Replacement Air Spring	
<b>Ram 2500 Pickup Truck (For Dodge trucks before 2010, see Dodge listing)</b>													
Ram 2500 (2WD only)	Y	14-18	2598	R-R	Y	1.5	6873	4193	C-R	Y	1	6103	Heavy
Ram 2500 (4WD only)	Y	14-18	2580	R-R	Y	1.5	6873	4193	C-R	Y	1	6103	Heavy
Ram 2500 (2WD, 4WD)	Y	13	2299	R-R	Y	1.5	6401						Heavy
Ram 2500 (2WD only)	Y	10-12	2299	R-R	Y	1.5	6401						Heavy
Ram 2500 (4WD only)	Y	10-12	2299	R-R	Y	1.5	6401	-1004-	L-R	Y	2	7215	Heavy
<b>Ram 3500 Pickup Truck (For Dodge trucks before 2010, see Dodge listing)</b>													
Ram 3500 (2WD only) (not factory air assist)	Y	14-18	2579	R-R	Y	1.5	6401	4193	C-R	Y	1	6103	Heavy
Ram 3500 (4WD only) (not factory air assist)	Y	13-18	2560	R-R	Y	1.5	6401	4193	C-R	Y	1	6103	Heavy
Ram 3500 (2WD only)	Y	10-12	2299	R-R	Y	1.5	6401						Heavy
Ram 3500 (4WD only)	Y	10-12	2299	R-R	Y	1.5	6401	-1004-	L-R	Y	2	7215	Heavy
<b>Ram Commercial Vehicles (vehicles without factory bed) (For Dodge trucks before 2010, see Dodge listing)</b>													
Ram 3500 HD (2WD, 4WD)		07-17	2478 +	R-R		2	6781						Heavy
Ram 4500, 5500 (2WD, 4WD) (requires 2" clearance above frame)		07-17	2404 ***	R-R		2	7714						Heavy
Ram 2500 (2WD, 4WD) (not dually, with box delete)		04-08	2299	R-R	Y	1.5	6401						Heavy
Ram 3500 (4WD only) (dually only, with box delete)		06-12	2299	R-R	Y	1.5	6401						Heavy
D3500, W3500 (2WD, 4WD) (cab & chassis)		94-02	2220	R-R	Y	2	6781						Heavy
<b>Saturn Van</b>													
Relay		05-07	4155	C-R	Y	1	6020						Light
<b>Scion Cars</b>													
xA		04-07	4136	C-R	Y	1	6014						Light
xB		08-16	4136	C-R	Y	1	6014						Light
<b>Sterling Commercial Vehicles (vehicles without factory bed)</b>													
Bullet (2WD, 4WD) (cab & chassis)		08-09	2478 +	R-R		2	6781						Heavy
<b>Toyota Cars</b>													
ECHO		01-05	4118	C-R	Y	1	6118						Light
Prius		10-17	4136	C-R	Y	1	6014						Light
Yaris		07-16	4136	C-R	Y	1	6014						Light

## DO NOT EXCEED THE VEHICLE'S RECOMMENDED GROSS VEHICLE WEIGHT RATING (GVWR)

Minimum Tire to Frame Clearance Requirements (check both sides): \* = 7.50" \*\* = 3.00" \*\*\* = 9.50" + = 8.00" ++ = 6.00" +++ = 6.50"

-0000- While Supplies Last # = Use spacer kit 2366 with heavy duty package or TRD

sw = Station Wagon  
rwd = Rear Wheel Drive

fwd = Front Wheel Drive  
A.C. = Air Conversion

Y = Yes

R-R = Ride-Rite  
C-R = Coil-Rite

S-R = Sport-Rite

# APPLICATION GUIDE

Make/Model	In-bed Hitch Compatible	Year	AIR LEVELING REAR					AIR LEVELING FRONT					Air Accessory Duty
			Rear Kit Part Number	Solution	No Drill	Time (hours)	Replacement Air Spring	Front Kit Part Number	Solution	No Drill	Time (hours)	Replacement Air Spring	
<b>Toyota Vans</b>													
Sienna (not AWD)		04-17	4155	C-R	Y	1	6020						Light
Sienna		98-03	4118	C-R	Y	1	6118						Light
Van (with rear coil springs)		64-89	4112	C-R	Y	1	6006						Light
<b>Toyota SUVs</b>													
RAV4 (2WD, 4WD)		07-18	4174	C-R	Y	1	6028						Light
FJ Cruiser		07-14	4135	C-R	Y	2	6024						Light
4Runner		98-18	4135	C-R	Y	2	6024						Light
4Runner		90-95	4112	C-R	Y	1	6006						Light
Sequoia (with rear coil springs)		17	4124	C-R	Y	1	6007						Light
Sequoia (with rear coil springs)		08-16	4164	C-R	Y	1	6009						Light
Sequoia		01-07	4124	C-R	Y	1	6007						Light
Land Cruiser		08-18	4164	C-R	Y	2	6009						Light
Land Cruiser		91-07	4124	C-R	Y	1	6007						Light
<b>Toyota Pickup Trucks</b>													
Pickup (2WD only)		69-95	-1130- **	R-R	Y	1.5	6873						Standard
Pickup (4WD only)		84-95	-2116-	R-R	Y	1.5	6781						Standard
T 100 (4WD only)		93-98	-2116-	R-R	Y	1.5	6781						Standard
Tacoma (2WD only)		05-18	2410	R-R	Y	1.5	6762						Standard
Tacoma (2WD only)		95-04	-2213-	R-R		2	6762						Standard
Tacoma Prerunner (2WD only)		05-17	2407	R-R	Y	1.5	6766						Standard
Tacoma Prerunner (2WD only)		95-04	2304 #	R-R		2	6781						Standard
Tacoma (4WD only)		05-18	2407	R-R	Y	1.5	6766						Standard
Tacoma (4WD only)		95-04	2304 #	R-R		2	6781						Standard
Tundra (2WD, 4WD), TRD		07-18	2445	R-R	Y	1.5	6410						Standard
Tundra (2WD only)		00-06	-2212-	S-R		2	9001						Standard
Tundra TRD (2WD only)		00-06	2245	R-R		2	6781						Standard
Tundra (4WD only)		00-06	2245	R-R		2	6781						Standard

## DO NOT EXCEED THE VEHICLE'S RECOMMENDED GROSS VEHICLE WEIGHT RATING (GVWR)

Minimum Tire to Frame Clearance Requirements (check both sides): \* = 7.50" \*\* = 3.00" \*\*\* = 9.50" += 8.00" ++ = 6.00" +++ = 6.50"

-0000- While Supplies Last # = Use spacer kit 2366 with heavy duty package or TRD

sw = Station Wagon  
rwd = Rear Wheel Drive

fwd = Front Wheel Drive  
A.C. = Air Conversion

Y = Yes

R-R = Ride-Rite  
C-R = Coil-Rite

S-R = Sport-Rite

# APPLICATION GUIDE

Make/Model	In-bed Hitch Compatible	Year	AIR LEVELING REAR					AIR LEVELING FRONT					Air Accessory Duty
			Rear Kit Part Number	Solution	No Drill	Time (hours)	Replacement Air Spring	Front Kit Part Number	Solution	No Drill	Time (hours)	Replacement Air Spring	
<b>Volkswagen Cars</b>													
CC		09-17	4176	C-R	Y	1	6027						Light
Beetle (not turbo)		12-17	4176	C-R	Y	1	6027						Light
Beetle Turbo		12-17	4175	C-R	Y	1	6026						Light
Eos		07-16	4176	C-R	Y	1	6027						Light
Golf		11-17	4176	C-R	Y	1	6027						Light
Golf GTI		07-17	4176	C-R	Y	1	6027						Light
Golf TDI		11-17	4176	C-R	Y	1	6027						Light
Golf Sport Wagen		16-17	4176	C-R	Y	1	6027						Light
Jetta		12-17	4176	C-R	Y	1	6027						Light
Jetta (not TDI)		07-10	4175	C-R	Y	1	6026						Light
Jetta Sport Wagen		12-13	4176	C-R	Y	1	6027						Light
Jetta Sport Wagen		09-10	4176	C-R	Y	1	6027						Light
Passat		12-17	4176	C-R	Y	1	6027						Light
Passat (not TDI)		98-06	4105	C-R	Y	1	6013						Light
Passat Wagen		07-09	4175	C-R	Y	1	6026						Light
<b>Volkswagen Van</b>													
Routan		09-12	4169	C-R		1.5	6013						Light
Euro Van, T-4		85-03	4117	C-R	Y	1	6004						Light
<b>Volkswagen SUVs</b>													
Atlas		18	4175	C-R	Y	1	6026						Light
Tiguan		09-17	4176	C-R	Y	1	6027						Light
<b>Workhorse Motorhomes Class "A"</b>													
P30, P32, W16 10,500 to 17,000 GVWR		00-07	-2085-	R-R	Y	1.5	6781						Xtra

## DO NOT EXCEED THE VEHICLE'S RECOMMENDED GROSS VEHICLE WEIGHT RATING (GVWR)

Minimum Tire to Frame Clearance Requirements (check both sides): \* = 7.50" \*\* = 3.00" \*\*\* = 9.50" + = 8.00" ++ = 6.00" +++ = 6.50"

-0000- While Supplies Last # = Use spacer kit 2366 with heavy duty package or TRD

sw = Station Wagon  
rwd = Rear Wheel Drive

fwd = Front Wheel Drive  
A.C. = Air Conversion

Y = Yes

R-R = Ride-Rite  
C-R = Coil-Rite

S-R = Sport-Rite



# Determine the correct spacer for your lifted vehicle

Lift spacers can be used with most Ride-Rite™ Air Spring Kits, not Coil-Rite™ or Sport-Rite™ Kits. The lift spacer needs to be the same length as the amount of lift applied to the axle on which the Air Spring is being installed. **Note that a six inch lift does not mean you need a six inch lift spacer!**

**6" ≠ 6"**  
**LIFT KIT**                      **LIFT SPACER**

## MEASURE YOUR SPACING

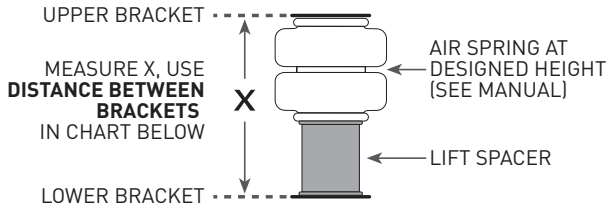

**Most six inch lifts only have four inches of lift in the rear to level out the truck. This holds true for the shorter lift kits as well.**

LIFT SPACERS			
	Distance Between Brackets	Lift Spacer Height	Lift Spacer Number
	6.5"-7.5"	1.25"	<b>2536</b> (PACKAGES OF 2)
	7.5" - 8.5"	2"	<b>2366</b> (PACKAGES OF 2)
	8.5" - 9.5"	3"	<b>2367</b> (PACKAGES OF 2)
	9.5" - 10.5"	4"	<b>2370</b> (PACKAGES OF 2)
	11.5" - 12.5"	6"	<b>2374</b> (PACKAGES OF 2)

AXLE EXTENSION BRACKETS FOR LIFTED VEHICLES			
	Lift	Kit Number	Make/Model Number
	2"	<b>2506</b>	Tundra 07-17 2445
	3"	<b>2507</b>	
	4"	<b>2508</b>	
	5"	<b>2509</b>	
	6"	<b>2510</b>	
SOME KITS / BRACKETS MAY REQUIRE DRILLING. USE THE EXTENSION BRACKET AS A TEMPLATE TO MARK AND DRILL THE HOLES.			

# COIL-RITE™ SERVICE PARTS & TECH SPECS

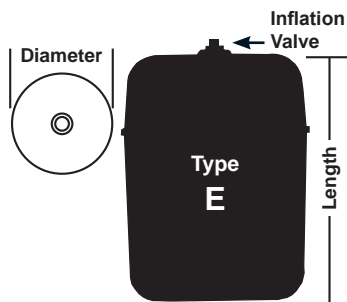
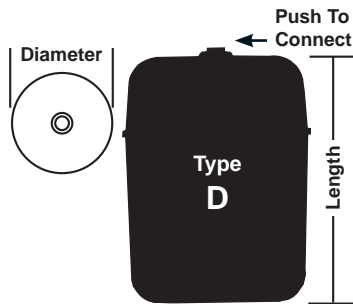
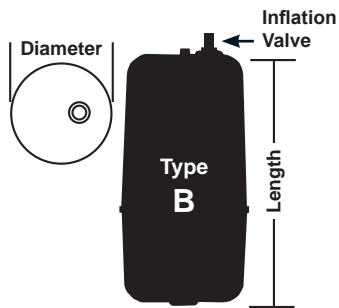
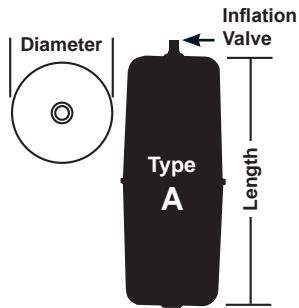

Coil-Rite™ Spring	Diameter	Length	Type
6003	4.75"	10.00"	D
6004	4.75"	6.50"	D
6005*	5.50"	5.00"	D
6006*	5.50"	7.00"	D
6007*	5.50"	8.00"	D
6008	5.50"	9.00"	D
6009*	5.50"	10.00"	D
6013*	4.00"	5.00"	D
6014*	4.00"	8.00"	D
6015*	4.00"	9.00"	D
6017*	4.75"	4.00"	D
6018*	4.00"	7.00"	D
6019*	4.00"	12.00"	D
6020*	4.75"	6.50"	D
6021*	4.75"	9.00"	D
6023*	4.75"	12.00"	D
6024*	4.75"	7.50"	D
6026*	3.56"	8.75"	D
6027	3.56"	7.00"	D
6028*	4.00"	6.00"	D
6100	3.56"	10.50"	A
6102*	4.00"	11.00"	B
6103*	4.75"	10.00"	E
6106*	5.50"	7.00"	E
6107*	5.50"	8.00"	E
6111*	4.00"	8.00"	E
6114	4.00"	8.00"	E
6117*	4.75"	4.00"	E
6118*	4.00"	7.00"	E
6124	4.75"	7.50"	E
6125*	4.00"	11.00"	E
6133	4.38"	11.00"	E

\*Available in kit form only.

## Standard Air Springs – up to 100 PSI

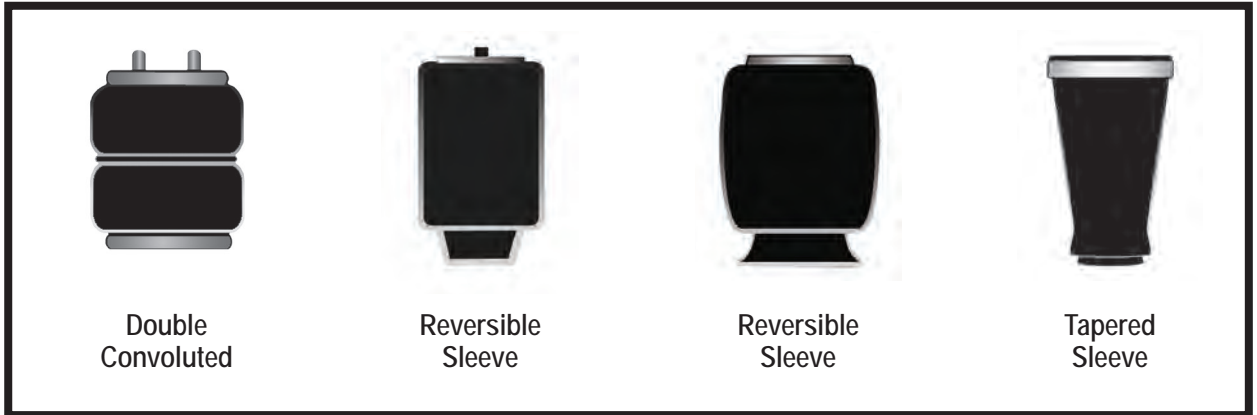

### 268C



Compressed Height 2.80"  
 Extended Height 7.00"  
 Ride Height 4.50" - 5.50"  
 Max. Diameter 6.40"

### 6764

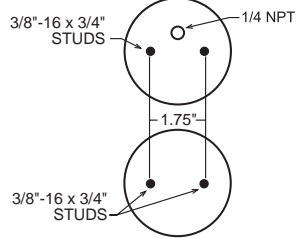

### 6762

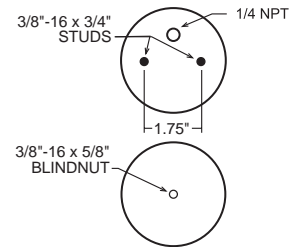

1600 lbs. per air spring\*

### 26C



Compressed Height 3.00"  
 Extended Height 9.00"  
 Ride Height 7.00" - 8.00"  
 Max. Diameter 8.60"

### 7714

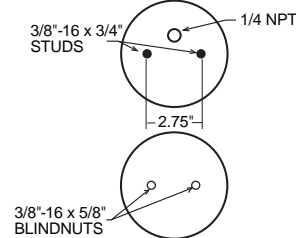

### 7325

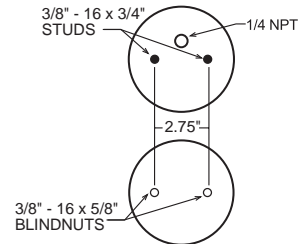

2800 lbs. per air spring\*

\*Load is nominal @ 100 PSI. Load will vary with height & pressure. Values shown are at ride height.

# SERVICE AIR SPRINGS & TECH SPECS

## 224C



Compressed Height 3.00"  
 Extended Height 8.91"  
 Ride Height 5.50" - 7.00"  
 Max. Diameter 7.52"

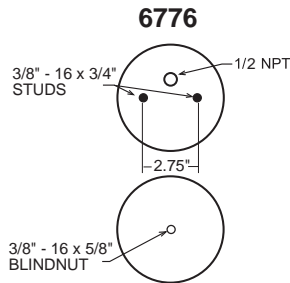
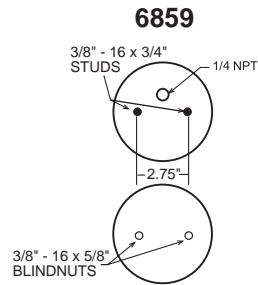
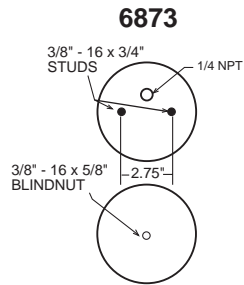
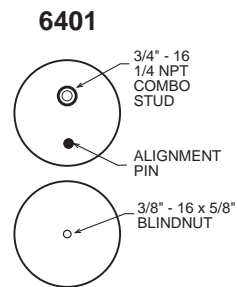
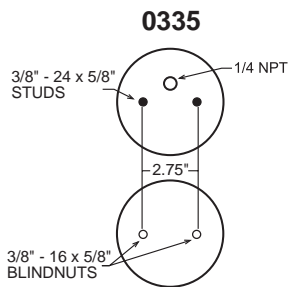

2500 lbs. per air spring\*

\*Load is nominal @ 100 PSI. Load will vary with height & pressure. Values shown are at ride height.

# SERVICE AIR SPRINGS & TECH SPECS

## 267C 1.5



Compressed Height 2.80"  
 Extended Height 8.30"  
 Ride Height 5.50" - 6.50"  
 Max. Diameter 6.60"

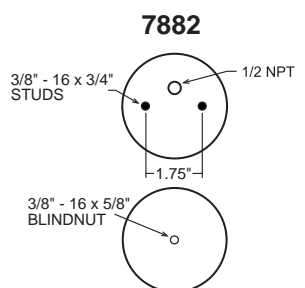
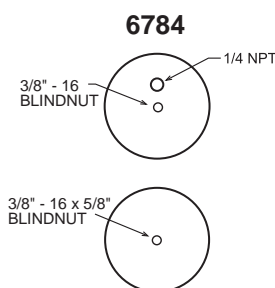
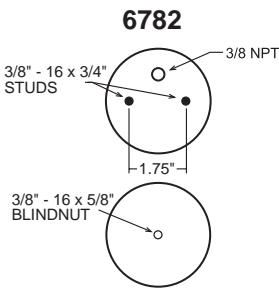
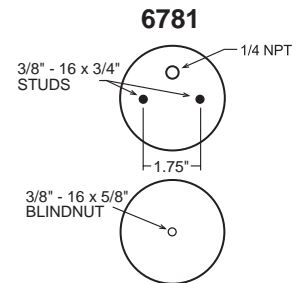
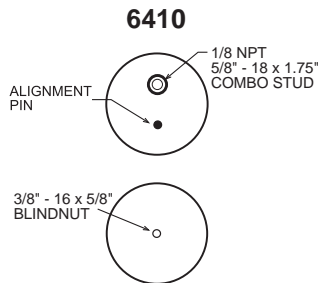
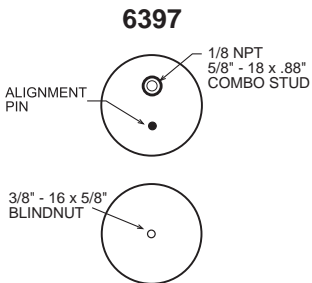

2800 lbs. per air spring\*

## 140/95



Max. Diameter 6.44"

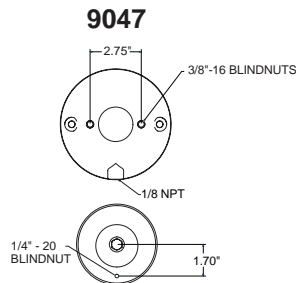

Compressed Height 8.00"  
 Extended Height 17.80"  
 Ride Height 11.34"

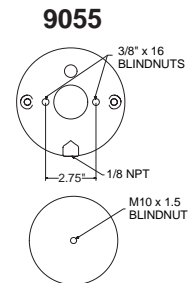

Compressed Height 6.50"  
 Extended Height 13.50"  
 Ride Height 8.90"

1500 lbs. per air spring\*

\*Load is nominal @ 100 PSI. Load will vary with height & pressure. Values shown are at ride height.



# SERVICE AIR SPRINGS & TECH SPECS

## 110/70



Max. Diameter 5.70"

## 9001

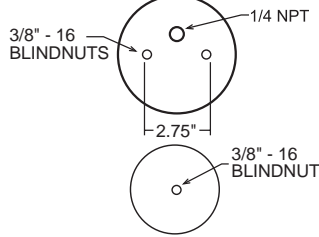

Compressed Height 4.37"  
Extended Height 8.37"  
Ride Height 6.38"

## 70mm



## 7076

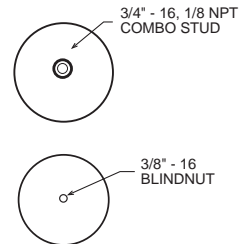

Compressed Height 3.95"  
Extended Height 10.50"  
Ride Height 7.00"  
Max. Diameter 5.00"

## 9000

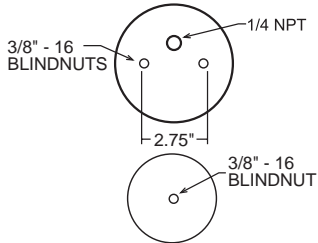

Compressed Height 6.25"  
Extended Height 10.25"  
Ride Height 8.25"

## 9002

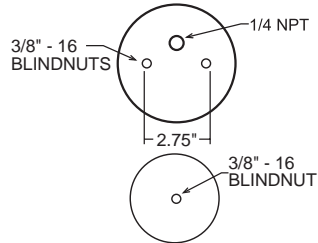

Compressed Height 5.25"  
Extended Height 9.25"  
Ride Height 7.25"

1500 lbs. per air spring\*

1000 lbs. per air spring\*

## 1T14CB



## 5295

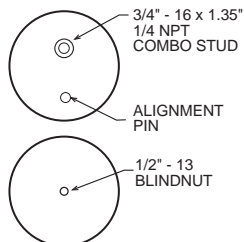

Ride Height 6.70"  
Maximum Diameter 9.20"

## 1T14C1



## 5294

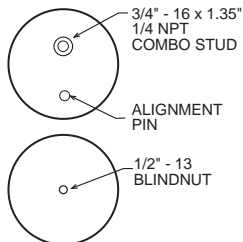

Ride Height 6.00"  
Maximum Diameter 9.20"

## 2093

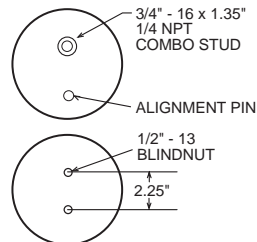

Ride Height 7.75"  
Maximum Diameter 9.20"

## 2107

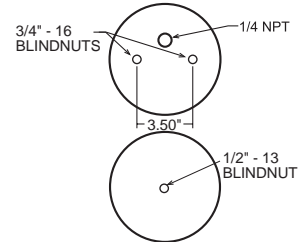

Compressed Height 4.25"  
Extended Height 13.60"  
Ride Height 9.80"  
Max. Diameter 9.10"

1500 lbs. per air spring\*

3200 lbs. per air spring\*

\*Load is nominal @ 100 PSI. Load will vary with height & pressure. Values shown are at ride height.

## RED Label™ Extreme Duty Air Springs – up to 150 PSI

Firestone continues to raise the bar on high pressure and high quality Air Springs with our RED Label™ edition. The Air Spring operates up to 150 PSI and has a test pressure of 400 PSI. *The RED Label™ parts are not intended to supplement the standard Air Springs in the standard Ride-Rite™ Kits. The RED Label™ parts are intended for use with RED Label™ Kits or on custom applications only.*

### 267C 1.5



Compressed Height 2.80"  
 Extended Height 8.30"  
 Ride Height 5.50" - 6.50"  
 Max. Diameter 6.60"

### 224C



Compressed Height 3.00"  
 Extended Height 8.91"  
 Ride Height 5.50" - 7.00"  
 Max. Diameter 7.52"

#### 7671

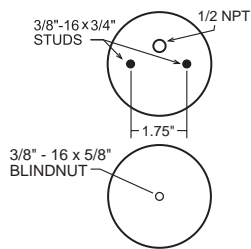

#### 7703

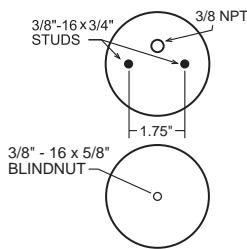

#### 8401

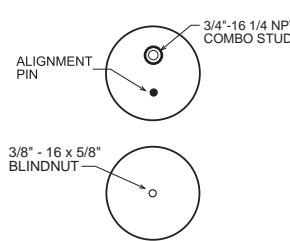

#### 8873

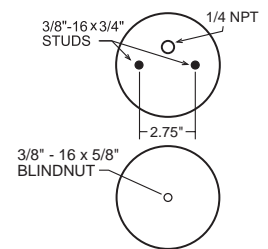

#### 8781

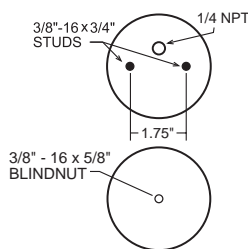

2800 lbs. per air spring\*

3250 lbs. per air spring\*

1/8 NPT = 0.405"

1/4 NPT = 0.540"

3/8 NPT = 0.675"





1/2 NPT = 0.840"

\*Load is nominal @ 150 PSI. Load will vary with height & pressure. Values shown are at ride height.

# AIR COMMAND™ SYSTEMS

## Which Air Command™ System is best for you?















Firestone Air Command Systems provide an instant air source for air suspension products. Adjust the ride for various load and road conditions with a flip of a switch or even a click on a remote. Individual air accessory components are also available, including compressors, air tanks and mounting solutions, providing a wide variety of air control assist solutions.

	Best for these uses	Frequency of use	Load Weight	Air Tank
<b>Light Duty</b> 	Light loads Light trailers	● ○ ○ ○ ○	● ○ ○ ○ ○	-
<b>Standard Duty</b> 	Boats 20' or smaller trailers Small to medium loads	● ● ● ○ ○	● ● ● ○ ○	-
<b>Heavy Duty</b> 	20' or larger trailers Slide-in campers Heavy loads	● ● ● ● ●	● ● ● ● ●	-
<b>Xtra Duty</b> 	Same as Heavy Duty, plus motorcycle tire, golf cart tire or trailer tire inflation	● ● ● ● ●	● ● ● ● ●	1/2 gallon
<b>Xtreme Duty</b> 	Same as Heavy Duty, plus off-road tire or truck tire inflation	● ● ● ● ●	● ● ● ● ●	2 gallon

\*For more details on compressor specs, see chart on page 36.

# Air Command™ Systems

Determine which kit is best for your use, then reference the chart below for the corresponding kit number.







Step 1: Choose from Light Duty to Xtreme Duty		Step 2: Choose between Single or Dual Leveling System, Analog or F3 Wireless						Additional items included in kit			
AIR COMMAND™ AIR COMPRESSOR KITS											
	Best uses	SINGLE LEVELING SYSTEM		DUAL LEVELING SYSTEM				Compressor*	Tank	Air Hose	Warranty Years
											
		Analog 		Analog 		F3 Wireless 					
Kit Number	Mounting Plate	Kit Number	Mounting Plate	Kit Number	Mounting Plate(s)						
<b>Light Duty</b>	Passenger cars, SUVs, vans and small pickups for occasional use and light loads.	<b>2538</b>	2497	n/a	n/a	<b>2581</b>	2588	 9377	n/a	n/a	1
<b>Standard Duty</b>	Moderate usage, including towing boats, trailers 20' or smaller and medium loads.	<b>2158</b>	2497	<b>2178</b>	2497	<b>2589</b>	2588	 9284	n/a	n/a	1
<b>Heavy Duty</b>	8-lug trucks, trailers larger than 20', slide-in campers and heavy loads.	<b>2097</b>	2497	<b>2219</b>	2497	<b>2590</b>	2588	 9499	n/a	n/a	2
<b>Xtra Duty</b>	Same as Heavy Duty, plus motorcycle tire, golf cart tire or trailer tire inflation.	<b>2266</b>	2530	<b>2168</b>	2530	<b>2591</b>	2588 2496	 9499	 9124	 9006	2
<b>Xtreme Duty</b>	Same as Heavy Duty plus off-road tire or truck tire inflation.	<b>2543</b>	2530	<b>2549</b>	2530	<b>2592</b>	2588 2496	 9287	 9420	 2311	2

\*For more details on compressor specs, see chart on page 36.

# AIR ACCESSORY SYSTEMS



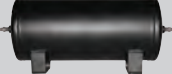

## Air Supply Kits

Air Supply Kits offer an on-board air source for inflating Air Springs, tires, rafts and other pneumatic components. Kits include a compressor, an air tank and a 25 ft. extension hose.

AIR SUPPLY KITS				
	Kit Number	Compressor	Air Tank	Hose
Xtra Duty	2047	9499 	9124 (1/2 gallon) 	9006 
Xtra Duty	2239	9499 	9127 (3 gallon) 	2311 

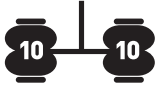
## Height Control Valve Kits

Height Control Valve Kits automatically control the Air Spring height. Choose single or dual height leveling. Requires Air Command™ or Air Supply system.

HEIGHT CONTROL VALVE KITS			
Use With	Kit Number	Single or Dual Leveling	Valve(s)
Xtra or Xtreme Duty	2186	Single 	
Xtra or Xtreme Duty	2017	Dual 	

# AIR ACCESSORY MOUNTING KITS

## No-drill, easy-to-install Air Accessories

Firestone's Air Accessory Mounting Kits allow the compressor only, tank only or entire Air Accessory system to be pre-assembled. The plate with the assembled accessory system can easily be attached to the frame, without drilling, using bail clamps.

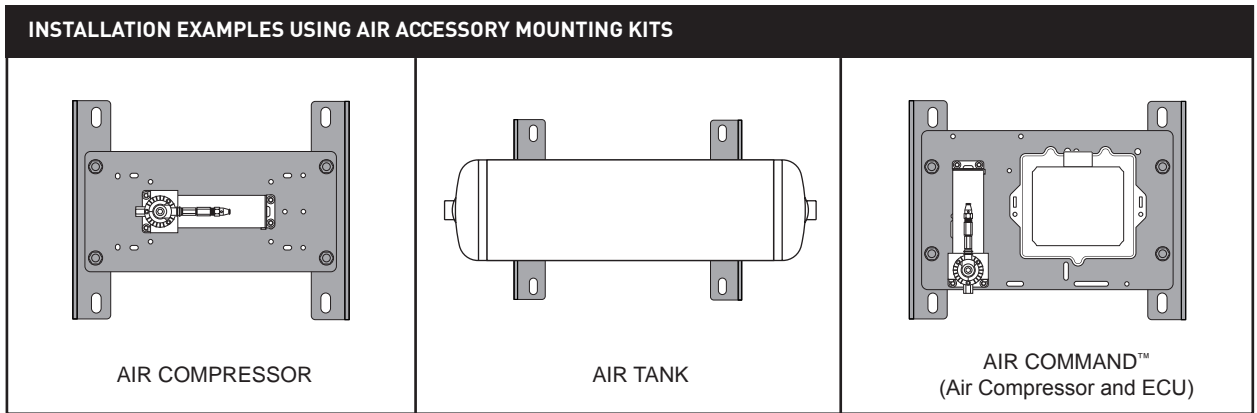

AIR ACCESSORY MOUNTING KITS			
Kit Number	Used to Mount	Kit Components	Works with These Kits
2496	Air Tanks		All Firestone tanks <b>except</b> 9166
2497	Compressors		2097 9284 2158 9287 2178 9377 2219 9499 2538
2530	Air Tank and Compressor		2047 2266 2168 2543 2198 2549 2232 2591* 2239 2592*
2588	Air Command™ Kits		2581 2589 2590 2591* 2592*



\*For 2591 Xtra Remote Air Command, use the 2588 and 2496.  
For 2592 Xtreme Remote Air Command, use the 2588 and 2530.





# CONTROL PANELS

## Provide air at the flip of a switch

Control Panels can be added to existing air supply setups to offer air pressure control at the flip of a switch. See important note about electric and pneumatic options.

METAL CONTROL PANELS					
Single Control		Dual Control		Monitoring Only	
					
4.38" x 2.75"		5.75" x 2.75"		3" x 2.75"	
Pneumatic		Replacement Gauge (2.03" dia.)		Monitoring Gauge	
White	2225	9181	White	2241	9201
Black	2149		Black	2145	
Electric		Replacement Gauge (2.03" dia.)		Monitoring Gauge	
White	2229	9181	White	2260	9201
Black	2191				

PLASTIC CONTROL PANELS					
Single Control		Dual Control			
					
5.25" x 2.73"		6.50" x 2.9"			
Pneumatic		Replacement Gauge			
White	2570	9181	White	2574	9201
Electric		Replacement Gauge			
White	2572	9181	White	2576	9201

REPLACEMENT SWITCH - ALL CONTROL PANELS	
Pneumatic	9072 - With Air Tank
Electric	9039 - No Air Tank

### How do I know if I need a pneumatic or an electric control panel?





- Pneumatic control panels are used in systems that utilize tanks and pull air from the tank
- Electric control panels do NOT require a tank, and activate the compressor directly

### What is the difference between single and dual control panels?

- Single control panels inflate and deflate one pair of Air Springs
- Dual control panels inflate and deflate two individual Air Springs or two pairs

## Air Compressors

Firestone's air compressors are included in all Air Command™ systems, but may also be purchased separately. All Firestone compressors are direct drive compressors (no oil or belts), so the compressors can be mounted in any position. Compressors should be mounted in a clean air location. Mounting holes are 3/16".

AIR COMPRESSORS											
9377			9284				9499				
											
Compressor Dimensions		Drill Hole Dimensions		Compressor Dimensions		Drill Hole Dimensions		Compressor Dimensions		Drill Hole Dimensions	
Length	7.63"	Length	5.50"	Length	6.30"	Length	5.54"	Length	8.00"	Length	7.19"
Width	2.11"	Width	1.41"	Width	3.27"	Width	2.72"	Width	3.95"	Width	3.31"
Height	4.31"			Height	5.20"			Height	6.30"		
9287			9164				<p><b>DO NOT SUBMERGE</b></p> <p>The compressors are designed to withstand the normal driving conditions of debris and moisture. Care should be taken that the compressors are not submerged into water.</p>				
											
Compressor Dimensions		Drill Hole Dimensions		Compressor Dimensions							
Length	11.24"	Length	8.31"	Length	12.54"						
Width	3.94"	Width	3.31"	Width	5.65"						
Height	6.85"			Height	8.86"						

Air Compressor	Part No.	Max. Air Pressure	Air Tank Use (up to gal.)	Duty Cycle	Max. AMP Draw	0 - 30 PSI*	0-60 PSI*	Wty** (yr)	Repl. Filter	CFM @ 100 PSI*
Light Duty	9377	120 PSI (8.3 BAR)	n/a	9%	10 AMPS	17 sec.	42 sec.	1	9129+	.32
Standard Duty	9284	130 PSI (9.0 BAR)	1	15%	14 AMPS	15 sec.	30 sec.	1	9350	.57
Heavy Duty	9499	150 PSI (10.4 BAR)	3	30%	13 AMPS	14 sec.	35 sec.	2	–	.40
Xtreme Duty	9287	150 PSI (10.4 BAR)	6	100%	23 AMPS	7 sec.	18 sec.	2	–	.94
Xtreme -alt Duty	9164	100 PSI (6.9 BAR)	6	100%	28 AMPS	–	–	2	–	1.10

\*Indicates flow rate - how long it takes to fill 1/2 gallon air tank.

\*\* See product-specific warranty guidelines for more information regarding warrantable manufacturing defects.

\*Packs of 10 filters.

# SERVICE PARTS

---

## Inflation Valve

(RETAIL PACK OF 2)

**3467** - 1/4" tubing

(BULK BAG OF 6)

**3457** - 1/4" tubing

(BULK BAG OF 25)

**3032** - 1/4" tubing



---

## Male Connector

(RETAIL PACK OF 2)

**3465** - 1/4" tubing - 1/8 NPT

**3463** - 1/4" tubing - 1/4 NPT

(BULK BAG OF 6)

**3454** - 1/4" tubing - 1/8 NPT

**3455** - 1/4" tubing - 1/4 NPT

(BULK BAG OF 25)

**3046** - 1/4" tubing - 1/4 NPT



---

## Male Elbow

(RETAIL PACK OF 2)

**3462** - 1/4" tubing - 1/4 NPT

(BULK BAG OF 6)

**3456** - 1/4" tubing - 1/4 NPT

(BULK BAG OF 25)

**3128** - 1/4" tubing - 1/8 NPT

**3031** - 1/4" tubing - 1/4 NPT



---

## Union T (Push To Connect)

(RETAIL PACK OF 1)

**3461** - 1/4" tubing

(BULK BAG OF 6)

**3453** - 1/4" tubing

(BULK BAG OF 25)

**3025** - 1/4" tubing



## Male Branch Swivel T

(BULK BAG OF 25)

**3273** - 1/4" tubing - 1/4 NPT



---

## Pressure Switch

(RETAIL PACK OF 1)

**9016** - 1/8 NPT Male, 90–120 PSI

**9193** - 1/8 NPT Male, 100–150 PSI



---

## Sealed Pressure Switch

(RETAIL PACK OF 1)

**9401** - 1/8 NPT Male, 90–120 PSI

**9402** - 1/8 NPT Male, 110–145 PSI



---

## Compressor Check Valve

(RETAIL PACK OF 1)

**3468** - 1/8 NPT



---

## Compressor T

(RETAIL PACK OF 1)

**3066** - 1/4" tubing - 1/8 NPT



---

## Union

(RETAIL PACK OF 1)

**3466** - 1/4" tubing

(BULK BAG OF 10)

**3079** - 1/4" tubing

**3114** - 1/4"–3/8" tubing



## Tubing Cutter

(RETAIL PACK OF 1)  
**9009** - Air Line Cutter



## Coil-Rite™ Elbow Fitting

(RETAIL PACK OF 2)  
**3438** - Shrader to Push to Connect



## Coil-Rite™ Straight Fitting

(RETAIL PACK OF 2)  
**3439** - Shrader to Push to Connect



## Wire Harness

(RETAIL PACK OF 1)  
**9307** - Switch Active  
*Used with electric gauge panels*  
**9419** - Ignition Active  
*Used in compressor/tank kits only*



## Inflation Valve Bracket

(RETAIL PACK OF 1)  
**7560**



## Fuse Tap Kit

(RETAIL PACK OF 1)  
**2526** - The Fuse Tap Kit provides an easy, low-impact method to connect the wire harness to the fuse box without splicing or soldering. Keeps the original circuit intact.



## Extension Hose

**9006** - 25-ft. Extension Hose



## Helpful Tools

The scale shown below may be used to assist in identifying the correct NPT (National Standard Taper Pipe Thread) fitting. Thread sealant is applied to the tapered threads. If the fitting is removed, use Teflon tape during reinstallation to prevent air leaks.

### SHOWN ACTUAL SIZE

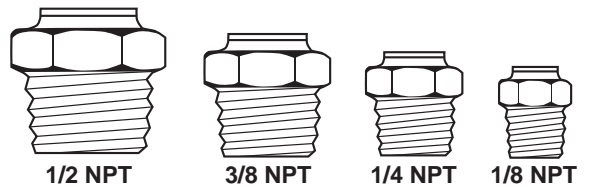

NPT Size	Nominal Outside Diameter
1/2	0.840"
3/8	0.675"
1/4	0.540"
1/8	0.405"

# SERVICE PARTS

## Dealer Fitting Pack 1

**2359**

**Includes 4 each:** 1/4" union Ts, inflation valves, 1/4 NPT elbow fittings.



## Dealer Fitting Pack 2

**2360**

**Includes 4 each:** 1/4" union Ts, inflation valves, 1/4 NPT elbow fittings and 2 each: 1/4" unions, 1/4 NPT straight fittings.



## Dealer Fitting Pack 3

**2395**

**Includes 6 each:** 1/4 NPT elbow fittings, inflation valves.

**Includes 2 each:** Union Ts, 1/4 NPT straight fittings, union fittings.

Also includes 100' of 1/4" air line tubing.



## Dealer Fitting Pack 4

**2567**

**Includes 4 each:** 1/4" union Ts, inflation valves, 1/8 NPT straight fittings.



## Ride-Rite™/Sport-Rite™ Air Line Service Kit

**2012**

Includes 18' of red 1/4" air line, two 1/4 NPT elbow fittings, one union T and two inflation valves.



### AIR LINE TUBING

Size	Length (ft.)	Color	Part No.
1/4"	30	Red	<b>9416</b>
1/4"	100	Red	<b>9145</b>
1/4"	30	Black	<b>9153</b>

## Expand your air supply capabilities in the field

Firestone offers a wide selection of air tanks ranging from 1/4 gallon to 20 gallons. These air tanks are coated internally and externally to resist corrosion. They are tested to SAE J10 compliance and are capable of 150 PSI maximum pressure. All tanks are made in the USA.



### 1/4 Gallon Air Tank

9166

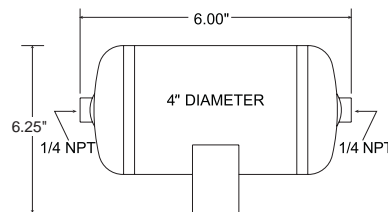

### 1/2 Gallon Air Tank

9124

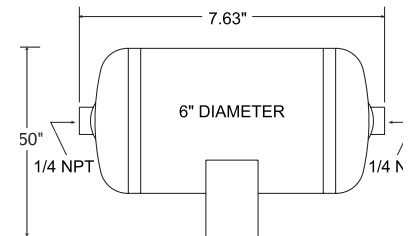

### 1 Gallon Air Tanks

9125

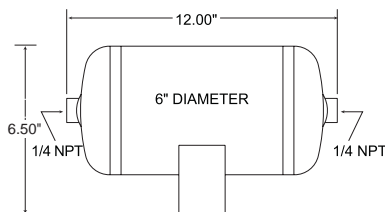

9244

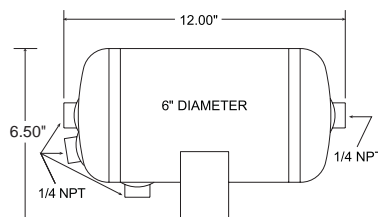

### 2 Gallon Air Tank

9124

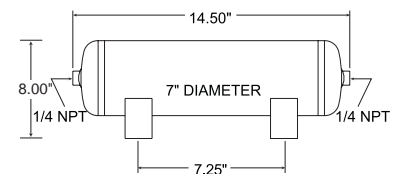

### 3 Gallon Air Tanks

9127

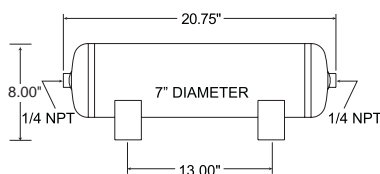

9148

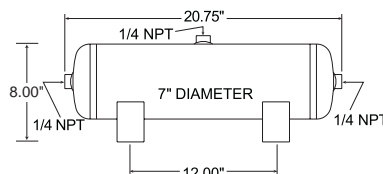

9227

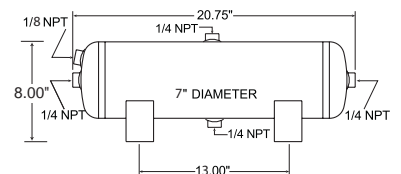

9154

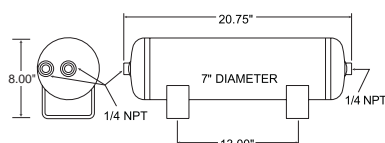

9229

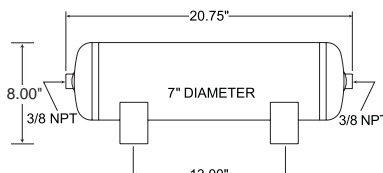

9245

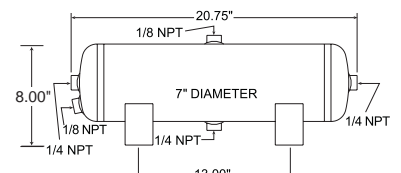



# AIR TANKS

## 5 Gallon Air Tanks

9191

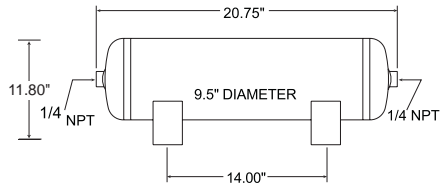

9231

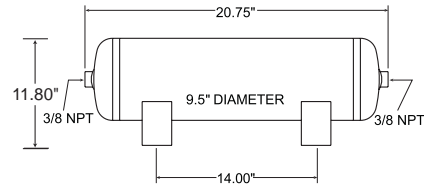

9242

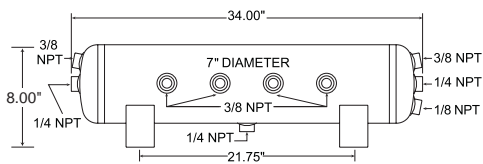

9243

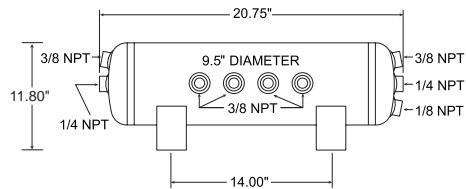

9246

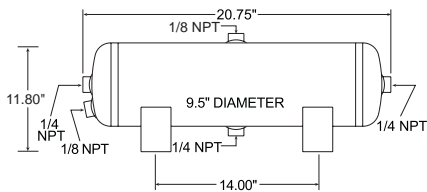

9248

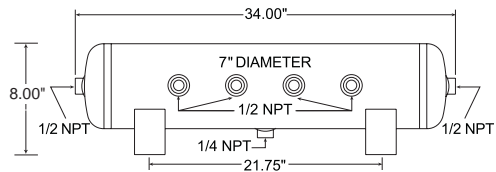

## 20 Gallon Air Tank

9277

