

FLEXZILLA®

PREMIUM HOSES, TOOLS & EQUIPMENT



AIR



WATER



POWER



LUBE



WORKWEAR

If it's not ZillaGreen™, it's not Flexzilla®

2020



THE FLEXZILLA® EDGE

Giving you the edge you deserve.

You work hard to get where you are in life. When it's time to choose the tools that help get you there, you deserve something that's above the ordinary. Tools that give you the edge you need to complete your projects faster, easier and with more satisfaction at the end of the day. You deserve Flexzilla hoses, tools and equipment.

**It's the difference between ordinary tools
and the innovative thinking designed
into every Flexzilla product.**

We take conventional tool ideas and rethink the work experience. The result is premium air, water and power tools that pull their weight and always put you a step ahead.

Experience it for yourself.

See how the innovative details we put into our tools make all the difference. Whether you're a professional or do-it-yourselfer, working with Flexzilla tools doesn't feel like work.

FLEXZILLA[®] by

legi

CONTENTS



7 Air Compressors

Stationary Air Compressors	8-9	Air Compressor Accessories	10
Refrigerated Air Dryers	10		

12 Air Hoses

Air Hose Assemblies	12	Pro Custom Hose Centers	17-18
Air Hose Kits	13-14	Pro Reusable Fittings and Splicers	19
Whip Hose Assemblies	14	Bulk Air and Water Hose	19
Polyurethane Recoil Hose	15	Pro Air Hose Assemblies	20
Hose Crimper	15	Pro Air Hose Kits	21
Pro Custom Air Hose	16	Pro Custom Length Whip Hose with High Flow Ball Swivel	21

22 Air Hose Reels

Retractable Air Hose Reels with Levelwind™ Technology	23	Retractable Air Hose Reels - Single Arm, Open Face	27
Mounting Brackets	23	Manual Air Hose Reels	28
Retractable Air Hose Reels	24	Manual Air Hose Reels - Fixed, Heavy-Duty	29
Retractable Air Hose Reels - Single Axle Arm Support	25	Manual Air Hose Reels - Portable	30
Retractable Air Hose Reels - Dual Axle Arm Support	26	Lead-In Hoses	31

32 Air Line Accessories

Pro High Flow Couplers and Plugs	33-34	Pro Heavy Duty Safety Couplers and Plugs	36
Pro High Flow Coupler and Plug Kits	35	Pro Heavy Duty Safety Coupler and Plug Kits	37

38 Blow Guns

Modular Blow Guns	39	Modular Blow Guns Accessories System	40
Modular Blow Gun Kits	39		

41 Air Tools

Pro Mini Impact Wrench	42	Pro Reciprocating Mini Air Saw Kit	43
Pro Reactionless Mini Air Ratchet Kit	43	Reactionless Mini Air Ratchet Kit	44

45 Tire Maintenance

Tire Inflators	46	Truck Tire Inflator Kit	46
--------------------------	----	-----------------------------------	----

WATER

Water Hoses

47

SwivelGrip™ Garden and Lead-in Hose Assemblies	48	Pro Custom Water Hose	54
Garden Hose Merchandiser and Pallets	49	Pro Custom Water Hose Centers	55-56
Colors™ SwivelGrip Garden Hose Assemblies	49	Pro Water Hose Assemblies	56
Garden and Lead-in Hose Assemblies	50	Pro Water Hose Nozzles	56
Garden Hose Kit with Quick Connect Attachments	51	Retractable Water Hose Reel with Levelwind Technology	57
3-Piece Nozzle Kit with Quick Connections	51	Mounting Brackets	57
Garden Hose Nozzles	52	Pressure Washer Hose Assemblies	58
Garden Hose Nozzle Merchandisers	53		

POWER

Extension Cords

59

Pro Extension Cords	60	Retractable Extension Cord Reel	61
-------------------------------	----	---	----

LUBE

Greasing Equipment

62

20V Cordless Grease Gun Kit	63	Quick-Release Grease Coupler	64
Lever Action Grease Gun	64	Grease Hoses	65

WORKWEAR

Protective Eyewear

66

Protective Eyewear	67
------------------------------	----

Plan-O-Grams & Part Number Index

68

Plan-O-Grams	69-74	Part Number Index	75-77
------------------------	-------	-----------------------------	-------

ICONS

ICONS THROUGHOUT THE CATALOG IDENTIFY FLEXZILLA® FEATURES AND BENEFITS



Flexzilla® Air Hose

FEATURES:

- Extreme all-weather flexibility, even in subzero temperatures (-40° to 140°F)
- Won't kink under pressure
- Lightweight and easy to handle
- Lays flat - no memory
- Durable and abrasion-resistant outer cover
- Anodized aircraft aluminum ends
- Max. working pressure at 70°F: 300 psi
- Includes bend restrictors to reduce wear and tear, prolonging the life of the hose



Flexzilla® Water Hose

FEATURES:

- Extreme all-weather flexibility
- Won't kink under pressure
- Lightweight, coils easily
- Lays flat - no memory
- Durable and abrasion-resistant outer cover
- Anodized aircraft aluminum ends
- Leak-free O-rings
- Max. working pressure at 70°F: 150 psi
- 3/4 in. - 1 1/2" GHT fittings



ColorConnex® Couplers & Plugs

ColorConnex is a patented system that allows color-to-color matching of couplers and plugs among the standard pneumatic interchanges.

- Industrial (Type D): Red
- Automotive (Type C): Blue
- ARO (Type B): Green

By using ColorConnex to dedicate line use, you can ensure you never use a lubricated line for a dry line application, preventing cross contamination.

- Match coupler and plug types
- Dedicate hose applications



Flexzilla® Pro Air Hose

FEATURES:

- Field Repairable – Reusable anodized aircraft aluminum fittings
- Extreme all-weather flexibility, even in subzero temperatures (-40° to 140°F)
- Won't kink under pressure
- Lightweight and easy to handle
- Lays flat - no memory
- Durable and abrasion-resistant outer cover
- Max. working pressure at 70°F: 300 psi
- Flexzilla Pro Reusable Fittings include bend reinforcement to reduce wear and tear, prolonging the life of the hose



Flexzilla® Pro Water Hose

FEATURES:

- Field Repairable – Reusable anodized aircraft aluminum fittings
- Extreme all-weather flexibility
- Lightweight, coils easily
- Won't kink under pressure
- Lays flat - no memory
- Durable and abrasion-resistant outer cover
- Leak-free O-rings
- Max. working pressure at 70°F: 150 psi
- 3/4 in. - 1 1/2" GHT fittings
- Flexzilla Pro Reusable Fittings include bend reinforcement to reduce wear and tear, prolonging the life of the hose



Flexzilla® Pro High Flow Couplers and Plugs

Flexzilla Pro High Flow couplers and plugs allow Twice The Flow to your air tools compared to standard interchanges. Connect Flexzilla High Flow fittings from your tool all the way to the compressor. Don't Starve Your Air Tool!

- Push-To-Connect
- Increased efficiency
- Maximum Torque
- Maximum RPM
- Best Performance
- Ideal for spray guns and impact tools

Flexzilla® Pro

Flexzilla Pro Products are designed with the professional in mind



Drinking Water Safe

The Flexible Hybrid Polymer inner tube material makes many of our hoses drinking water safe



QUIET TECHNOLOGY™

Quiet Technology™, which uses large, low-RPM pumps and motors to reduce high frequency noise levels while increasing CFM output.

AIR COMPRESSORS

SILENCER™ NOISE SUPPRESSION

A patented noise suppression system that uses baffles to reduce low frequency noise.



SILENCER™

FLEXZILLA
PRO



QUIET
TECHNOLOGY™

NEW **Stationary Air Compressors**

PRO

Let's face it, standard air compressors are LOUD. All this NOISE interferes with workplace communication, lowers productivity on the job, and increases risk of hearing loss. Fortunately, Flexzilla® brings quiet back to the workplace.

QUIET TECHNOLOGY™

- Flexzilla air compressors are the quietest on the market, emitting operating noise no louder than a normal conversation.
- Flexzilla air compressors feature low RPM pumps and motors that reduce high frequency noise levels while increasing CFM output.

SILENCER™

- Flexzilla stationary air compressors include the Silencer™, a patented noise suppression system that reduces low frequency noise levels.

INDUSTRY EXCLUSIVE!

10 HP RECIPROCATING UNIT / 1-PHASE

- High CFM performance without the cost of installing 3-Phase.
- Output of more expensive screw units without the added cost.



SILENCER™ NOISE SUPPRESSION
Patented

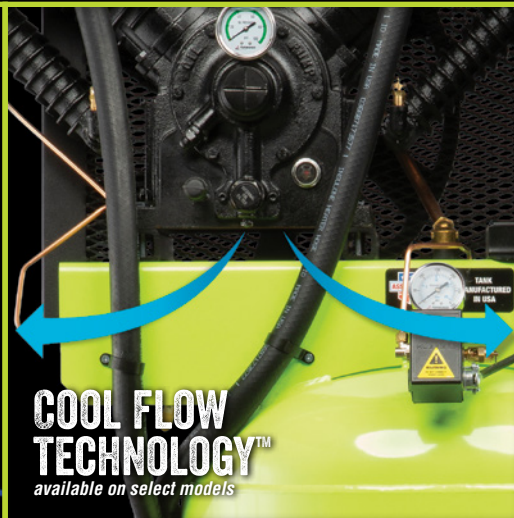

COOL FLOW TECHNOLOGY™
available on select models

10 HORSEPOWER SINGLE-PHASE
available on select models



NEW Stationary Air Compressors

PRO

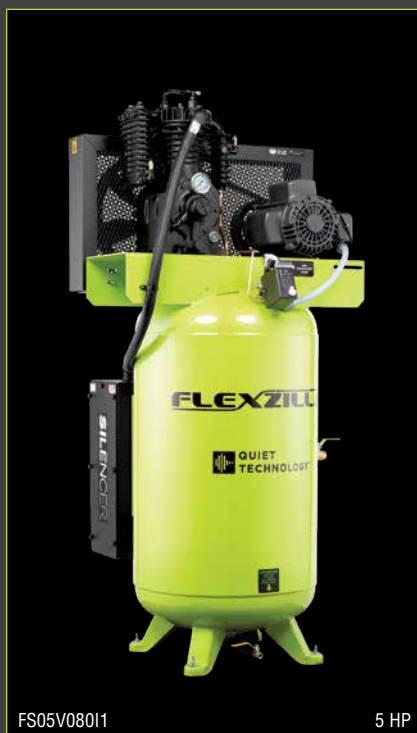

FS05V08011

5 HP

FLEXZILLA® (5 HP) INCLUDES:

- Manual water drain
- Motor - open drip proof (ODP)
- 4 Year Warranty
 - 1 Year Parts and Labor Warranty
 - Additional 3 Year Extended Parts Warranty



FXS07V080V1

7 HP

FLEXZILLA® PRO (7.5 / 10 HP) INCLUDE:

- Cool Flow Technology™
- Timed water drain
- Belt tensioner
- Continuous run (Dual control)
- Totally enclosed fan cooled motor



FXS10V120V1

10 HP

- Magnetic starter - prewired
- Ball valve crank case oil drain
- 6 Year Warranty
 - 1 Year Parts and Labor Warranty
 - Additional 5 Year Extended Parts Warranty

Part No.	HP Spec	Tank Size	Max. PSI	Pump	Pump Pressure	Pump Lubed	1-Phase Connection	3-Phase Connection	Automatic Tank Drain	Belt Tensioner	Continuous Run	Cool Flow Technology™	Assembled in USA
Flexzilla® Stationary Air Compressors, 5 HP													
FS05V08011	5 HP	80 Gal.	175 PSI	2-Cyl	●	●	●	—	—	—	—	—	●
Flexzilla® Pro Stationary Air Compressors, 7.5 HP													
FXS07V080V1	7.5 HP	80 Gal.	175 PSI	4-Cyl	●	●	●	●	●	●	●	●	●
FXS07V080V3-208	7.5 HP	80 Gal.	175 PSI	4-Cyl	●	●	●	●	●	●	●	●	●
FXS07V080V3-230	7.5 HP	80 Gal.	175 PSI	4-Cyl	●	●	●	●	●	●	●	●	●
Flexzilla® Pro Stationary Air Compressors, 10 HP													
FXS10V080V1	10 HP	80 Gal.	175 PSI	4-Cyl	●	●	●	●	●	●	●	●	●
FXS10V080V3-208	10 HP	80 Gal.	175 PSI	4-Cyl	●	●	●	●	●	●	●	●	●
FXS10V080V3-230	10 HP	80 Gal.	175 PSI	4-Cyl	●	●	●	●	●	●	●	●	●
FXS10V120V1	10 HP	120 Gal.	175 PSI	4-Cyl	●	●	●	●	●	●	●	●	●
FXS10V120V3-208	10 HP	120 Gal.	175 PSI	4-Cyl	●	●	●	●	●	●	●	●	●
FXS10V120V3-230	10 HP	120 Gal.	175 PSI	4-Cyl	●	●	●	●	●	●	●	●	●

NEW Refrigerated Air Dryers

PRO

Flexzilla™ Pro Refrigerated Air Dryers continuously chill the compressed air from your compressors to condense and remove moisture, leaving only powerful, compressed air your pneumatic tools require for best performance.

FEATURES:

- Premium Industrial Refrigerated Air Dryer
 - Chills the air to condense and remove moisture; runs on 115 Volt, single phase
 - 230 PSI max.; Max. inlet temp: 140°F; 37°F - 50°F dew point
 - Maximum ambient temperature: 122°F; for use with compressors that do not have aftercoolers
- 5 Micron Pre-Filter - Removes larger dust and dirt particles from the air supply so the dryer can work more efficiently
- 1 Micron Active Coalescing Filter - Removes oil and water Particles from the air; cleaner, drier air improves tool life & project results
- Refrigerated Air Inlet Inner Cooler - Trouble-free high temperature cooling for consistent, dry air
- Automatic Drain System - Eliminates the need for daily maintenance
- Outlet Air Baffle Heater - Prevents condensation on outlet air piping
- Side Mounted Condenser and Fan Motor
 - Easy to reach and service through the cabinet doors- no screws to slow you down
 - Uses environmentally friendly 134A refrigerant
- Heavy Duty Steel Cabinet and Safety Shut-Off Valve - Meets the demands of industrial use; valve shuts the compressor down if it gets above or below a safe temperature

FDRCF1150030



FDRCF1150058

Part No.	Volt	CFM	HP Spec	Max. PSI	Inlet Fittings	Outlet Fittings
FDRCF1150030	115V	30	5 HP-7.5 HP	230 PSI	1/2 in. NPT	1/2 in. NPT
FDRCF1150058	115V	58	10 HP	230 PSI	1/2 in. NPT	1/2 in. NPT

NEW Air Compressor Accessories

Part No.	Description	Retail Packaging	Assembled in USA
DRAIN001A	Flexzilla™ Pro Air Compressor Timed Water Drain	-	-
FILTER057	Flexzilla™ Air Compressors Air Filter for 5-10 HP	-	•
FILTER107KIT	Flexzilla™ Air Compressor Silencer™ Filter Replacements, Qty. 4	-	•
FILTERKIT011	Flexzilla™ Air Dryer Filter Maintenance Kit, for 29 CFM	-	-
FILTERKIT012	Flexzilla™ Air Dryer Filter Maintenance Kit, for 58 CFM	-	-
ISOLATORS001	Flexzilla™ Air Compressors Isolator Pads, Qty. 4	-	-
MAINKIT008	Flexzilla™ Air Compressors Oil and Filter Maintenance Kit, for 5-10 HP	•	•
OILFZ004	Flexzilla™ Air Compressor Oil, Synthetic, Piston-Type, 1 Qt.	•	•



MAINKIT008



FILTER057



DRAIN001A



FILTER107KIT



FILTERKIT011

FLEXIBLE HYBRID POLYMER

Flexzilla® hoses have a durable, abrasion-resistant outer cover.

WON'T KINK UNDER PRESSURE

Lightweight and easy to handle, Flexzilla hoses lay flat, have no memory and won't kink under pressure.

AIR HOSES

EXTREME ALL-WEATHER FLEXIBILITY

Flexzilla hoses offer extreme all-weather flexibility, even in subzero temperatures (-40° to 140°F).



Air Hose Assemblies



Flexzilla® is a revolutionary hose featuring a Flexible Hybrid Polymer material that redefines flexibility. This engineered polymer-blend material permits use in environments where general purpose PVC and rubber hose may become too stiff. Flexzilla hose characteristics offer zero memory allowing it to lay flat. It won't work against you during operation and coils easily after use. Flexzilla offers extreme all-weather flexibility, even in subzero conditions, and is ideal in both hot and cold environments where tight radius bends are needed.



HFZ3850YW2

FEATURES:

- Extreme all-weather flexibility, even in subzero temperatures (-40° to 140°F)
- Won't kink under pressure
- Lightweight and easy to handle
- Lays flat - no memory
- Durable and abrasion-resistant outer cover
- Anodized aircraft aluminum ends
- Max. working pressure at 70°F: 300 psi
- Includes bend restrictors to reduce wear and tear, prolonging the life of the hose

MADE IN USA
(3/8 and 1/4 in. hose assemblies only)



HFZ3850YW2



HFZ3850YW2-3X

Part No.	Hose I.D.	Hose Length	Fittings	Retail Packaging	Made in USA
HFZ1425YW2	1/4 in.	25 ft.	1/4 in. MNPT	●	●
HFZ1450YW2	1/4 in.	50 ft.	1/4 in. MNPT	●	●
HFZ14100YW2	1/4 in.	100 ft.	1/4 in. MNPT	●	●
HFZ14100YW2-3X	1/4 in.	100 ft.	1/4 in. MNPT	●	●
HFZ3825YW2	3/8 in.	25 ft.	1/4 in. MNPT	●	●
HFZ3825YW2-5X	3/8 in.	25 ft.	1/4 in. MNPT	●	●
HFZ3835YW2	3/8 in.	35 ft.	1/4 in. MNPT	●	●
HFZ3850YW2	3/8 in.	50 ft.	1/4 in. MNPT	●	●
HFZ3850YW2-3X	3/8 in.	50 ft.	1/4 in. MNPT	●	●
HFZ3850YW3	3/8 in.	50 ft.	3/8 in. MNPT	-	●
HFZ38100YW2	3/8 in.	100 ft.	1/4 in. MNPT	●	●
HFZ1225YW3	1/2 in.	25 ft.	3/8 in. MNPT	●	-
HFZ1250YW3	1/2 in.	50 ft.	3/8 in. MNPT	●	-
HFZ1250YW4	1/2 in.	50 ft.	1/2 in. MNPT	-	-
HFZ12100YW3	1/2 in.	100 ft.	3/8 in. MNPT	●	-
HFZ12100YW4	1/2 in.	100 ft.	1/2 in. MNPT	-	-

Part nos. with a -3X or -5X suffix include 3 or 5 hose assemblies respectively in a retail merchandiser display

Air Hose Kits – Include Hose, Coupler, and Plug



This convenient hose kit features the revolutionary Flexzilla® air hose paired with a Red Industrial (Type D) 1/4 in. body ColorConnex® coupler and plug set (one each). Combining Flexzilla's revolutionary design and the convenient color coding of ColorConnex, you get two great products in one. Plus, since thread sealer is already installed on the coupler and plug, you're ready to go as soon as you reach the jobsite.



HFZ3850YW2-D

KIT INCLUDES:

- Flexzilla Air Hose
- ColorConnex Red Industrial (Type D) Coupler and Plug
- Pre-Sealed Threads

ASSEMBLED IN USA
of US and global components



HFZ3850YW2-D

FEATURING:

Use color to:

ColorConnex®
TYPE D / INDUSTRIAL

- Match coupler & plug types
- Dedicate hose applications



Part No.	Hose I.D.	Hose Length	Fittings	Retail Packaging	Assembled in USA
HFZ1425YW2-D	1/4 in.	25 ft.	1/4 in. MNPT	●	●
HFZ1450YW2-D	1/4 in.	50 ft.	1/4 in. MNPT	●	●
HFZ14100YW2-D	1/4 in.	100 ft.	1/4 in. MNPT	●	●
HFZ3825YW2-D	3/8 in.	25 ft.	1/4 in. MNPT	●	●
HFZ3835YW2-D	3/8 in.	35 ft.	1/4 in. MNPT	●	●
HFZ3850YW2-D	3/8 in.	50 ft.	1/4 in. MNPT	●	●
HFZ38100YW2-D	3/8 in.	100 ft.	1/4 in. MNPT	●	●



Air Hose Kit – Includes Hose, Blow Gun and Accessories



11-Piece Air Compressor Kit

KIT INCLUDES:

- (1) Flexzilla Air Hose, 50 ft. x 3/8 in.
- (1) Blow Gun with safety tip
- (1) Ball Foot Chuck
- (1) Pencil Tire Pressure Gauge (10 to 100 psi)
- (1) Coupler, 1/4 in. FNPT
- (1) Coupler, 1/4 in. MNPT
- (2) Plugs, 1/4 in. FNPT
- (3) Plugs, 1/4 in. MNPT

ASSEMBLED IN USA
of US and global components



HFZCLB11D



HFZCLB11D

Part No.	Hose I.D.	Hose Length	Fittings	Retail Packaging	Assembled in USA
HFZCLB11D	3/8 in.	50 ft.	1/4 in. NPT	●	●
HFZCLB11D-3X	3/8 in.	50 ft.	1/4 in. NPT	●	●

Part no. with a -3X suffix include 3 hose assemblies in a retail merchandiser display

Whip Hose Assemblies



WHY USE A WHIP HOSE?

- Increased longevity of the main hose
- Reduces user fatigue by eliminating weight of coupler/plug
- Increases mobility in tight spaces
- Improves air tool ergonomics

ASSEMBLED IN USA
of US and global components



HFZ3806YW2B

Part No.	Hose I.D.	Hose Length	Fittings	Retail Packaging	Assembled in USA
HFZ1405YW2B	1/4 in.	5 ft.	1/4 in. MNPT Ball Swivel x 1/4 in. FNPT	–	–
HFZ3802YW2B	3/8 in.	2 ft.	1/4 in. MNPT Ball Swivel x 1/4 in. FNPT	●	●
HFZ3804YW2B	3/8 in.	4 ft.	1/4 in. MNPT Ball Swivel x 1/4 in. FNPT	●	–
HFZ3806YW2B	3/8 in.	6 ft.	1/4 in. MNPT Ball Swivel x 1/4 in. FNPT	●	●
HFZ1202YW3S	1/2 in.	2 ft.	3/8 in. MNPT Swivel x 3/8 in. MNPT	–	–
HFZ1204YW3S	1/2 in.	4 ft.	3/8 in. MNPT Swivel x 3/8 in. MNPT	–	–
HFZ1206YW3S	1/2 in.	6 ft.	3/8 in. MNPT Swivel x 3/8 in. MNPT	–	–
HFZ1208YW3S	1/2 in.	8 ft.	3/8 in. MNPT Swivel x 3/8 in. MNPT	–	–
HFZ1202YW4S	1/2 in.	2 ft.	1/2 in. MNPT Swivel x 1/2 in. MNPT	–	–
HFZ1204YW4S	1/2 in.	4 ft.	1/2 in. MNPT Swivel x 1/2 in. MNPT	–	–
HFZ1206YW4S	1/2 in.	6 ft.	1/2 in. MNPT Swivel x 1/2 in. MNPT	–	–

Polyurethane Recoil Hose

The Flexzilla® revolution continues with the Flexzilla polyurethane recoil air hose. Flexzilla recoil air hose exhibits extreme, all-weather flexibility and outperforms nylon hose. Plus, with the field repairable fittings, damaged hose can be repaired quickly, using tools commonly available on the jobsite.

FEATURES:

- Extreme all-weather flexibility (-40° to 165°F)
- Polyurethane outperforms nylon:
 - More flexible
 - Will not become brittle over time
 - Better recoil memory
- Working pressure at 70°F: 120 psi
- 1/4 in. MNPT reusable ends
- Safety factor: 3:1
- Tool end: 16 in. tail with swivel fitting
- Compressor end: 8 in. tail with rigid fitting
- Pre-applied thread sealer

Part No.	Hose I.D.	Hose Length	Fittings	Retail Packaging
LP1410AFZ	1/4 in.	10 ft.	1/4 in. MNPT	●
LP1415AFZ	1/4 in.	15 ft.	1/4 in. MNPT	●
LP1420AFZ	1/4 in.	20 ft.	1/4 in. MNPT	●
LP1425AFZ	1/4 in.	25 ft.	1/4 in. MNPT	●



LP1425AFZ

Hose Crimper

Hose Crimper		
Part No.	Die Bore Sizes	Retail Packaging
A5	5/8 in. 37/64 in. (for 3/8 in. Flexzilla) 17/32 in. 7/16 in. (For 1/4 in. Flexzilla) 11/16 in. (For 1/2 in. Flexzilla)	-



A5

Flexzilla® Pro Air Hose



Flexzilla® Pro Air Hose is available in pre-assembled coils or in our Custom Hose Centers where the end user can fabricate a custom length hose for any application. The field repair and custom length hose process takes

3 EASY STEPS



CUSTOM LENGTHS



CUT – Measure and cut desired length of hose at 90° angle.

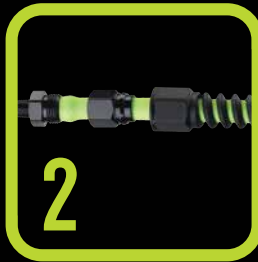

INSTALL – Slide spiral fitting and nut onto hose. Push hose onto fitting until hose reaches threads.



TIGHTEN – Tighten fitting nut until snug. Slide bend restrictor up and snap onto nut.



FIELD REPAIRABLE



CUT – Cut damaged portion of hose at 90° angle. Slide fitting nuts onto hose.



INSTALL – Slide hose onto fitting until hose reaches threads.



TIGHTEN – Tighten fitting nuts until snug.

Custom Hose Centers



The Flexzilla® Pro Custom Hose Centers allow you to provide your customers with custom length hose assemblies. Using Flexzilla Pro reusable ends, you can quickly and easily create custom length hose assemblies on site.

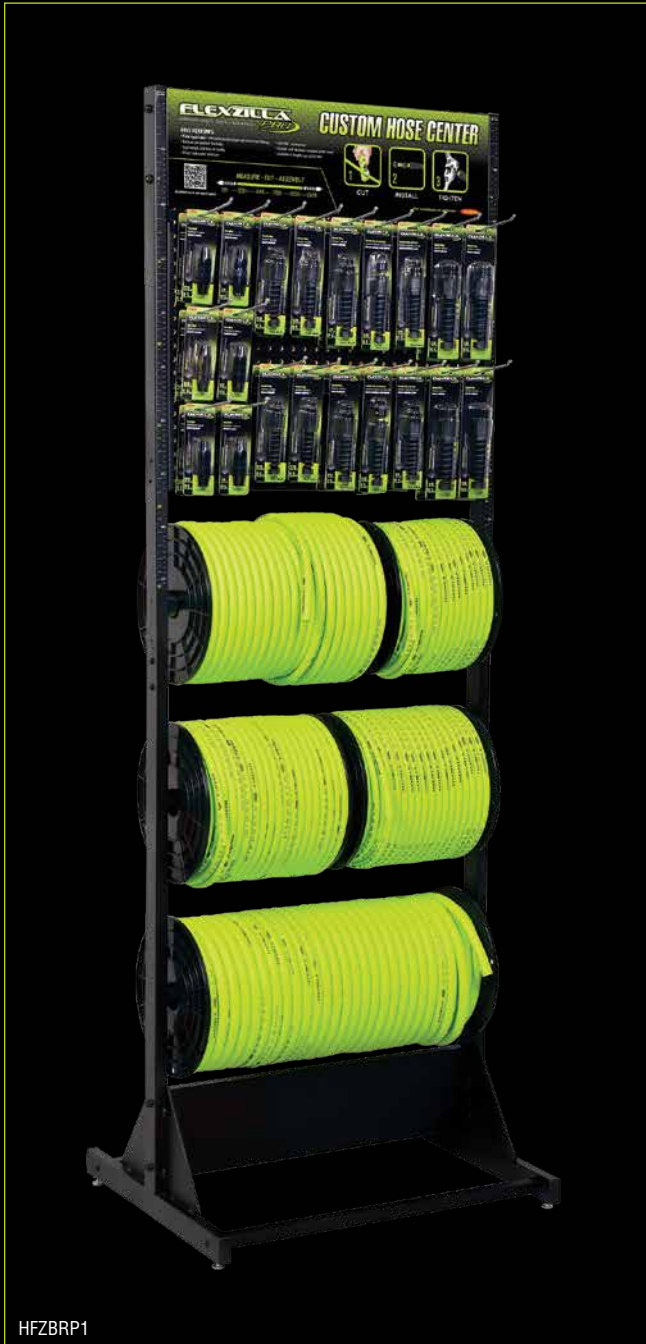

HFZBRP1

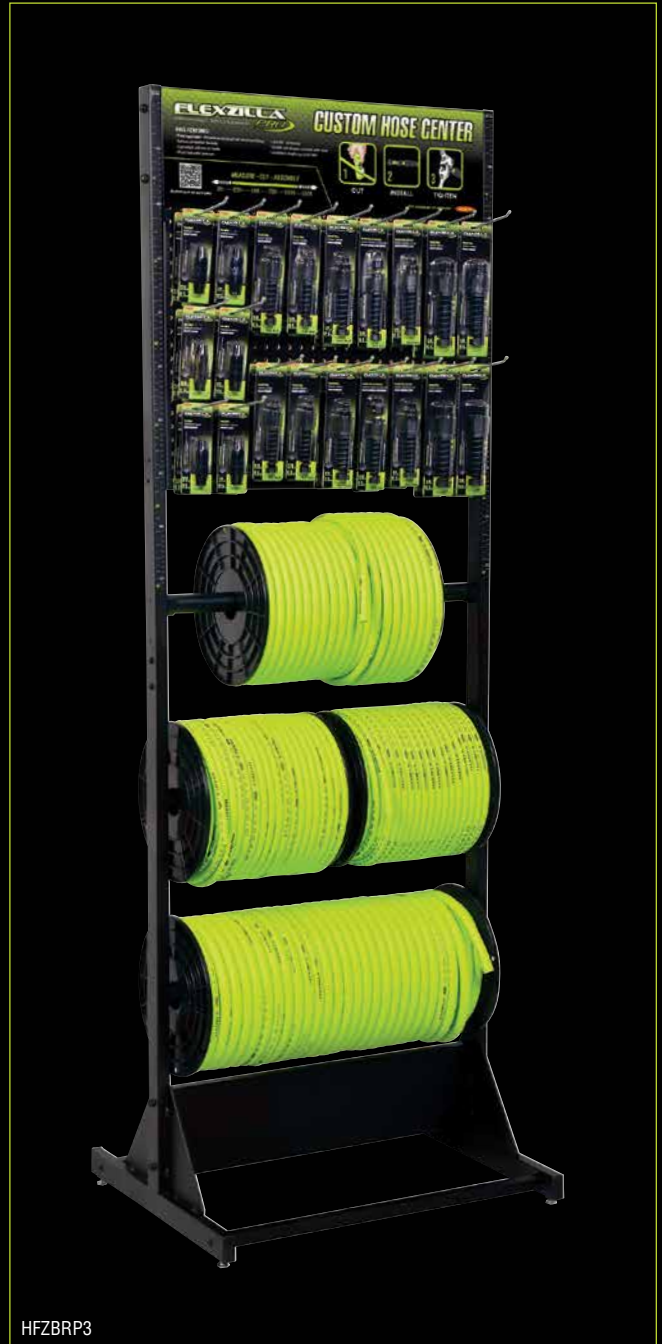

HFZBRP3



Drinking water safe hose (Water Hose Only)

Custom Hose Centers (continued)



HFZBRP1 - Flexzilla® Pro Custom Hose Center		
Part No.	Description	Rack Quantity
HFZ12250YW	Flexzilla® Pro Air Hose, 1/2 in. x 250 ft. Spool, ZillaGreen™	1 ea.
HFZ14250YW	Flexzilla® Pro Air Hose, 1/4 in. x 250 ft. Spool, ZillaGreen™	2 ea.
HFZ38250YW	Flexzilla® Pro Air Hose, 3/8 in. x 250 ft. Spool, ZillaGreen™	2 ea.
HFZW58250YW	Flexzilla® Pro Water Hose, 5/8 in. x 250 ft. Spool, ZillaGreen™	1 ea.
RP900250	Flexzilla® Pro Air Hose Reusable Fitting, 1/4 in.	10 ea.
RP900250BS	Flexzilla® Pro Air Hose Reusable Fitting with Ball Swivel, 1/4 in.	10 ea.
RP900375	Flexzilla® Pro Air Hose Reusable Fitting, 3/8 in.	10 ea.
RP900375BS	Flexzilla® Pro Air Hose Reusable Fitting with Ball Swivel, 3/8 in.	10 ea.
RP900500	Flexzilla® Pro Air Hose Reusable Fitting, 1/2 in.	10 ea.
RP900500S	Flexzilla® Pro Air Hose Reusable Fitting with Swivel, 1/2 in.	10 ea.
RP900625F	Flexzilla® Pro Water Hose Female Reusable Fitting, 5/8 in.	10 ea.
RP900625M	Flexzilla® Pro Water Hose Male Reusable Fitting, 5/8 in.	10 ea.
RP901250	Flexzilla® Pro Air Hose Reusable Splicer, 1/4 in.	10 ea.
RP901375	Flexzilla® Pro Air Hose Reusable Splicer, 3/8 in.	10 ea.
RP901500	Flexzilla® Pro Air Hose Reusable Splicer, 1/2 in.	10 ea.
HR-05	Custom Hose Center (Freestanding Rack)	1 ea.

Parts also sold separately in standard pack quantities

HFZBRP3 - Flexzilla® Pro Custom Hose Center		
Part No.	Description	Rack Quantity
HFZ12250YW	Flexzilla® Pro Air Hose, 1/2 in. x 250 ft. Spool, ZillaGreen™	1 ea.
HFZ38250YW	Flexzilla® Pro Air Hose, 3/8 in. x 250 ft. Spool, ZillaGreen™	4 ea.
HFZW58250YW	Flexzilla® Pro Water Hose, 5/8 in. x 250 ft. Spool, ZillaGreen™	2 ea.
RP900375	Flexzilla® Pro Air Hose Reusable Fitting, 3/8 in.	20 ea.
RP900375BS	Flexzilla® Pro Air Hose Reusable Fitting with Ball Swivel, 3/8 in.	20 ea.
RP900500	Flexzilla® Pro Air Hose Reusable Fitting, 1/2 in.	10 ea.
RP900500S	Flexzilla® Pro Air Hose Reusable Fitting with Swivel, 1/2 in.	10 ea.
RP900625F	Flexzilla® Pro Water Hose Female Reusable Fitting, 5/8 in.	10 ea.
RP900625M	Flexzilla® Pro Water Hose Male Reusable Fitting, 5/8 in.	10 ea.
RP901375	Flexzilla® Pro Air Hose Reusable Splicer, 3/8 in.	20 ea.
RP901500	Flexzilla® Pro Air Hose Reusable Splicer, 1/2 in.	10 ea.
HR-05	Custom Hose Center (Freestanding Rack)	1 ea.

Parts also sold separately in standard pack quantities

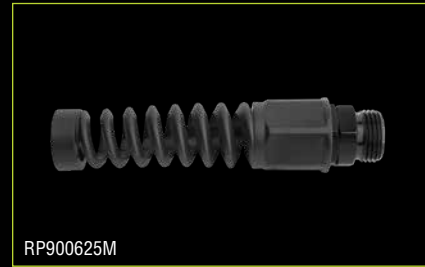
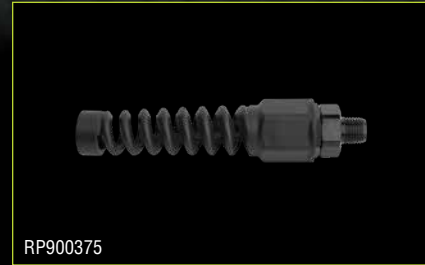

Drinking water safe hose (Water Hose Only)



Reusable Fittings and Splicers – Air and Water Hose



PRO

Flexzilla® Pro Reusable Fittings and Splicers allow you to quickly repair Flexzilla hose on the jobsite, or create a custom length hose in just three easy steps.

Splicers Include:

- Reusable MNPT anodized aircraft aluminum fitting for Flexzilla and Flexzilla Pro Air Hose



Part No.	Description	Application	Fitting	Barb Size	Retail Packaging
RP900250	Reusable Fitting	Air	1/4 in. MNPT	1/4 in.	●
RP900250BS	Reusable Ball Swivel Fitting	Air	1/4 in. MNPT	1/4 in.	●
RP900250S	Reusable Swivel Fitting	Air	1/4 in. MNPT	1/4 in.	●
RP900375	Reusable Fitting	Air	1/4 in. MNPT	3/8 in.	●
RP900375BS	Reusable Ball Swivel Fitting	Air	1/4 in. MNPT	3/8 in.	●
RP900375S	Reusable Swivel Fitting	Air	1/4 in. MNPT	3/8 in.	●
RP900500	Reusable Fitting	Air	3/8 in. MNPT	1/2 in.	●
RP900500S	Reusable Ball Swivel Fitting	Air	3/8 in. MNPT	1/2 in.	●
RP901250	Hose Splicer	Air	–	1/4 in.	●
RP901375	Hose Splicer	Air	–	3/8 in.	●
RP901500	Hose Splicer	Air	–	1/2 in.	●
RP900625F	Reusable Fitting	Water	3/4 in. Female GHT	5/8 in.	●
RP900625M	Reusable Fitting	Water	3/4 in. Male GHT	5/8 in.	●

Bulk Air and Water Hose



PRO

Flexzilla® Pro bulk hose spools allow you to create custom length hose.



Part No.	Application	Hose I.D.	Spool Length	Hose Fittings	Max. Working Pressure	Retail Packaging
HFZ14250YW	Air	1/4 in.	250 ft.	Sold separately	300 psi	–
HFZ38250YW	Air	3/8 in.	250 ft.	Sold separately	300 psi	–
HFZ12250YW	Air	1/2 in.	250 ft.	Sold separately	300 psi	–
HFZW58250YW	Water	5/8 in.	250 ft.	Sold separately	150 psi	–



Drinking water safe hose (Water Hose Only)

Air Hose Assemblies



Flexzilla® Pro Field Repairable Air Hose features extreme all-weather flexibility, rugged durability and won't kink under pressure. Its unique Flexible Hybrid Polymer material redefines flexibility. With reusable anodized aircraft aluminum fittings, the Flexzilla Pro Air Hose can be repaired on the jobsite in a few simple steps.



HFZP3850YW2

FEATURES:

- Field Repairable – Reusable anodized aircraft aluminum fittings
- Extreme all-weather flexibility, even in subzero temperatures (-40° to 140°F)
- Won't kink under pressure
- Lightweight and easy to handle
- Lays flat - no memory
- Durable and abrasion-resistant outer cover
- Max. working pressure at 70°F: 300 psi
- Flexzilla Pro Reusable Fittings include bend reinforcement to reduce wear and tear, prolonging the life of the hose



HFZP38100YW2

Part No.	Hose I.D.	Hose Length	Fittings	Retail Packaging
HFZP1425YW2	1/4 in.	25 ft.	1/4 in. MNPT	●
HFZP1450YW2	1/4 in.	50 ft.	1/4 in. MNPT	●
HFZP14100YW2	1/4 in.	100 ft.	1/4 in. MNPT	●
HFZP3825YW2	3/8 in.	25 ft.	1/4 in. MNPT	●
HFZP3835YW2	3/8 in.	35 ft.	1/4 in. MNPT	●
HFZP3850YW2	3/8 in.	50 ft.	1/4 in. MNPT	●
HFZP38100YW2	3/8 in.	100 ft.	1/4 in. MNPT	●

Air Hose Kits – Include Hose, Coupler and Plug



This convenient hose kit features the revolutionary Flexzilla® Pro Flexible Hybrid Polymer air hose paired with a Red Industrial (Type D) ColorConnex® Coupler and Plug Set (one each). Combining Flexzilla's revolutionary design and the convenient color coding of ColorConnex, you get two great products in one. Plus, since the thread sealer is already installed on the coupler and plug, you're ready to go as soon as you reach the jobsite.

KIT INCLUDES:

- Flexzilla Pro Air Hose
- ColorConnex Red Industrial (Type D) Coupler and Plug
- Pre-sealed Threads

Part No.	Hose I.D.	Hose Length	Fittings	Retail Packaging
HFZP1425YW2-D	1/4 in.	25 ft.	1/4 in. MNPT	●
HFZP1450YW2-D	1/4 in.	50 ft.	1/4 in. MNPT	●
HFZP14100YW2-D	1/4 in.	100 ft.	1/4 in. MNPT	●
HFZP3825YW2-D	3/8 in.	25 ft.	1/4 in. MNPT	●
HFZP3850YW2-D	3/8 in.	50 ft.	1/4 in. MNPT	●
HFZP38100YW2-D	3/8 in.	100 ft.	1/4 in. MNPT	●



HFZP1425YW2-D

Custom Length Whip Hose with High Flow Ball Swivel



WHY USE A WHIP HOSE?

- Increased longevity of the main hose
- Reduces user fatigue by eliminating weight of coupler/plug
- Increases mobility in tight spaces
- Improves air tool ergonomics



HFZP3806YW2B



High Flow Ball Swivel

Part No.	Hose I.D.	Hose Length	Fittings	Retail Packaging
HFZP3806YW2B	3/8 in.	6 ft.	1/4 in. MNPT High Flow Ball Swivel and Reusable Fitting (RP900375)	●

AIR HOSE REELS



LEVELWIND™ TECHNOLOGY

Automatically layers the hose back and forth across the reel.

LATCHING MODE SWITCH

Latch hose every three feet for extended use or switch to free run for immediate, automatic rewinding.

Retractable Air Hose Reels with Levelwind™ Technology



Featuring Levelwind™ – Flexzilla’s unique winding system that automatically layers hose back and forth across the reel ensuring that the hose is coiled smoothly, easily...every time – and includes Flexzilla® air hose and lead-in hose.



L8305FZ

FEATURES:

- **Latching Mode Switch** - Choose from latching hose every 3 ft. for extended use or switch to free run for immediate automatic rewinding
- **Seven Position Locking Bracket** - These reels can swivel freely on a mounting bracket up to 135° or can be locked into place using the locking brace. Up to seven different locking angles can be utilized (L8300-W)
- **Adjustable Hose Stopper** - Increase or decrease the length of the hose that remains when hose is fully retracted
- **Extra Large Swivel** - A 3/4 in. swivel reduces flow restrictions and allows for maximum flow
- **Free Standing Base** - Portable - Use freestanding or mounted on wall or ceiling. Flat base allows reel to rest on the ground
- **Built-In Handle** - For carrying ease
- **Durable Construction** - Made from durable UV stabilized polypropylene
- **Hose Material** - Flexible Hybrid Polymer
- **Lead-in Hose Included** - 5 ft.

ASSEMBLED IN USA
of US and global components

Retractable Air Hose Reels with Levelwind™ Technology

Part No.	Hose I.D.	Hose Length	Working Pressure @ 70°F	Temperature Range (F°)	Lead-in Hose Connection	Reel Inlet	Hose Outlet	Weight	Retail Packaging	Assembled in USA
L8305FZ	3/8 in.	50 ft.	300 psi	-40° to 140°	3/4 in. Female GHT x 1/4 in. MNPT	3/4 in. – 1 1/2 Male GHT	1/4 in. MNPT	25 lbs.	●	●
L8306FZ	3/8 in.	75 ft.	300 psi	-40° to 140°	3/4 in. Female GHT x 1/4 in. MNPT	3/4 in. – 1 1/2 Male GHT	1/4 in. MNPT	30 lbs.	●	●
L8335FZ	1/2 in.	50 ft.	300 psi	-40° to 140°	3/4 in. Female GHT x 3/8 in. MNPT	3/4 in. – 1 1/2 Male GHT	3/8 in. MNPT	29 lbs.	●	●

Mounting Brackets



L8300-W



L8300-B

L8300-W FEATURES:

- Includes a seven position locking bracket
- Reel can swivel freely on mounting bracket up to 135° or can be locked into place using the locking brace
- Mounting options: wall or overhead ceiling

L8300-B FEATURES:

- Includes a seven position locking bracket
- Reel can swivel freely on mounting bracket up to 360° or can be locked into place using the locking brace
- Mounting options: high wall or bench

Retractable Air Hose Reels



These economical, retractable air hose reels are ideal for the home shop.



L8250FZ

FEATURES:

- **Auto Retract/Latch Hose Mechanism** - Simplifies every job by keeping excess hose out of the work space
- **Positive Latching Mechanism** - Locks hose automatically in 18 in. intervals
- **Durable Construction** - Made from durable UV stabilized polypropylene
- **Adjustable Hose Stopper** - Increase or decrease the length of the hose that remains when hose is fully retracted
- **Swivel Mounting Bracket** - Pivots in the direction of your work, reel can be mounted to wall or ceiling
- **Hose Material** - Flexible Hybrid Polymer
- **Lead-in Hose Included** - 3 ft.

HOSE I.D.	WORKING PRESSURE
3/8 IN.	150 PSI

Retractable Air Hose Reels

Part No.	Hose I.D.	Hose Length	Working Pressure @ 70°F	Temperature Range (F°)	Lead-in Hose Connection	Hose Outlet	Weight	Retail Packaging
L8230FZ	3/8 in.	30 ft.	150 psi	-40° to 140°	-40° to 140°	1/4 in. MNPT	12 lbs.	●
L8250FZ	3/8 in.	50 ft.	150 psi	-40° to 140°	-40° to 140°	1/4 in. MNPT	18 lbs.	●

Retractable Air Hose Reels – Single Axle Arm Support



These retractable, open face hose reels are ideal for indoor shop, mobile and industrial applications.



L8603FZ

HOSE I.D.	WORKING PRESSURE
3/8 IN.	300 PSI

FEATURES:

- **Multi-Position Guide Arm** - Allows mounting on wall, tank or overhead
- **Durable Heavy-Duty Steel Construction** - Provides strength and stability to the reel and bracket
- **Corrosion-Resistant Powder Coating** - Provides extra measure of protection against the elements
- **Four-Way Direction Rollers** - Allow the hose to be easily pulled from the reel
- **Self-Locking Fasteners** - Stay tight even in mobile installations
- **Narrow Size** - Ideal for easy placement and storage
- **Multi-Position Release Ratchet** - Allows appropriate amount of hose to be extended for each jobsite
- **Metal Latching Pawl** - Makes an audible clicking sound allowing the latching zone to be locked quickly and easily
- **Fully-Enclosed Spring Motor** - Packed with grease for extended life
- **Hose Material** - Flexible Hybrid Polymer
- **Lead-in Hose Included** - 5 ft.

ASSEMBLED IN USA
of US and global components

Retractable Air Hose Reels – Single Axle Arm Support

Part No.	Hose I.D.	Hose Length	Working Pressure @ 70°F	Temperature Range (F°)	Lead-in Hose Connection	Reel Inlet	Hose Outlet	Weight	Retail Packaging	Assembled in USA
L8603FZ	3/8 in.	25 ft.	300 psi	-40° to 140°	1/4 in. MNPT x 1/4 in. MNPT	1/4 in. FNPT	1/4 in. MNPT	25 lbs.	–	●
L8611FZ	3/8 in.	50 ft.	300 psi	-40° to 140°	3/8 in. MNPT Swivel x 1/4 in. MNPT	3/8 in. FNPT Swivel	3/8 in. MNPT	40 lbs.	●	–

Retractable Air Hose Reels – Dual Axle Arm Support



Featuring dual axle arm support, these retractable open face hose reels can withstand constant vibration making them ideal for mobile installations.



L8711FZ



L8741FZ

HOSE I.D.	WORKING PRESSURE
3/8 IN.	300 PSI

HOSE I.D.	WORKING PRESSURE
1/2 IN.	300 PSI

FEATURES:

- **Multi-Position Release Ratchet** - Allows appropriate amount of hose to be extended for each jobsite
- **Durable Heavy-Duty Steel Construction** - Provides strength and stability to the reel
- **Corrosion-Resistant Powder Coating** - Provides extra measure of protection against the elements
- **Four-Way Direction Rollers** - Allow the hose to be easily pulled from the reel
- **Self-Locking Fasteners** - Stay tight even in mobile installations
- **Narrow Size** - Ideal for easy placement and storage

- **Multi-Position Guide Arm** - Allows mounting on wall, truck, tank or overhead
- **Galvanized Dual Support Arms and Bases** - Resist rust and corrosion
- **Dual Axle Arm Support** - Can withstand the constant vibration of mobile installations
- **Hose Material** - Flexible Hybrid Polymer
- **Lead-in Hose Included** - 5 ft.

ASSEMBLED IN USA
of US and global components

Retractable Air Hose Reels – Dual Axle Arm Support

Part No.	Hose I.D.	Hose Length	Working Pressure @ 70°F	Temperature Range (F°)	Lead-in Hose Connection	Reel Inlet	Hose Outlet	Weight	Retail Packaging	Assembled in USA
L8711FZ	3/8 in.	50 ft.	300 psi	-40° to 140°	3/8 in. MNPT Swivel x 1/4 in. MNPT	3/8 in. MNPT Swivel	3/8 in. MNPT	39 lbs.	-	-
L8741FZ	1/2 in.	50 ft.	300 psi	-40° to 140°	3/8 in. MNPT x 3/8 in. MNPT Swivel	3/8 in. MNPT	3/8 in. MNPT	44 lbs.	-	●

Retractable Air Hose Reels – Single Arm, Open Face



Built with quality and durability in mind, these reels incorporate heavy gauge steel and corrosion-resistant components to withstand the harsh conditions in the workplace.



L8011FZ

HOSE I.D.	WORKING PRESSURE
3/8 IN.	300 PSI



L8041FZ

HOSE I.D.	WORKING PRESSURE
1/2 IN.	300 PSI

FEATURES:

- **Multi-Position Release Ratchet** - Allows appropriate amount of hose to be extended for each jobsite
- **Durable Heavy-Duty Steel Construction** - Provides strength and stability to the reel
- **Corrosion-Resistant Powder Coating** - Provides extra measure of protection against the elements
- **Self-Locking Fasteners** - Stay tight even in mobile installations

- **Narrow Size** - Ideal for easy placement and storage
- **Multi-Position Guide Arm** - Allows mounting on wall, tank, overhead, bench, or vehicle
- **Hose Material** - Flexible Hybrid Polymer
- **Lead-in Hose Included** - 5 ft.

ASSEMBLED IN USA
of US and global components

Retractable Air Hose Reels – Single Arm, Open Face

Part No.	Hose I.D.	Hose Length	Working Pressure @ 70°F	Temperature Range (F°)	Lead-in Hose Connection	Reel Inlet	Hose Outlet	Weight	Retail Packaging	Assembled in USA
L8011FZ	3/8 in.	50 ft.	300 psi	-40° to 140°	3/8 in. MNPT Swivel x 3/8 in. MNPT	3/8 in. MNPT Swivel	3/8 in. MNPT	32 lbs.	-	●
L8041FZ	1/2 in.	50 ft.	300 psi	-40° to 140°	1/2 in. MNPT Swivel x 1/2 in. MNPT	1/2 in. MNPT Swivel	1/2 in. MNPT	33 lbs.	-	●

Manual Air Hose Reels



These manual open face hose reels are ideal for indoor shop, mobile and industrial applications.



FEATURES:

- **Swivel Handle** - Pivots in hand for winding ease
- **Mounting Bracket** - Mount reel to wall, workbench or vehicle
- **Swivel** - Heavy-duty 1/4 in. brass
- **Baked Enamel Finish** - Provides a smooth and durable finish
- **Bend Restrictor** - Prolongs the life of the air hose
- **Hose Material** - Flexible Hybrid Polymer
- **Lead-in Hose Included** - 5 ft.

ASSEMBLED IN USA
of US and global components

L8550FZ

HOSE I.D.	WORKING PRESSURE
3/8 IN.	300 PSI

Manual Air Hose Reels

Part No.	Hose I.D.	Hose Length	Working Pressure @ 70°F	Temperature Range (F°)	Lead-in Hose Connection	Reel Inlet	Hose Outlet	Weight	Retail Packaging	Assembled in USA
L8550FZ	3/8 in.	50 ft.	300 psi	-40° to 140°	1/4 in. MNPT x 1/4 in. MNPT	1/4 in. MNPT	1/4 in. MNPT	15 lbs.	-	●
L8560FZ	3/8 in.	100 ft.	300 psi	-40° to 140°	1/4 in. MNPT x 1/4 in. MNPT	1/4 in. MNPT	1/4 in. MNPT	22 lbs.	-	●

Manual Air Hose Reels – Fixed, Heavy Duty



These manual heavy-duty drum reels are compact and ideal for indoor shop and industrial applications.



L8650FZ

HOSE I.D.	WORKING PRESSURE	SUPPORT
3/8 IN.	300 PSI	SINGLE



L8652FZ

HOSE I.D.	WORKING PRESSURE	SUPPORT
3/8 IN.	300 PSI	DUAL

FEATURES:

- **Heavy-Duty Drum** - Heavy-duty steel reinforced drum.
- **Powder Coat Finish** - Provides a smooth and durable finish
- **Brake** - Keeps hose from unwinding unintentionally
- **Inlet Swivel** - Heavy-duty 1/4 in. brass
- **Tapered Side Walls** - Store more hose in less space
- **Swivel Handle** - Pivots in hand for winding ease
- **Mounting Bracket** - Mount reel to wall, workbench, or vehicle

- **Dual Support** - Provides extra stability for the big jobs (L8652FZ only)
- **Bend Restrictor** - Prolongs the life of the air hose
- **Hose Material** - Flexible Hybrid Polymer
- **Lead-in Hose Included** - 5 ft.

ASSEMBLED IN USA
of US and global components

Manual Air Hose Reels – Fixed, Heavy Duty

Part No.	Hose I.D.	Hose Length	Working Pressure @ 70°F	Temperature Range (F°)	Lead-in Hose Connection	Reel Inlet	Hose Outlet	Weight	Retail Packaging	Assembled in USA
L8650FZ	3/8 in.	50 ft.	300 psi	-40° to 140°	1/4 in. MNPT x 1/4 in. MNPT	1/4 in. MNPT	1/4 in. MNPT	16 lbs.	-	●
L8652FZ	3/8 in.	100 ft.	300 psi	-40° to 140°	1/4 in. MNPT x 1/4 in. MNPT	1/4 in. MNPT	1/4 in. MNPT	30 lbs.	-	●

Manual Air Hose Reels – Portable



Designed for portability, these reels are useful just about anywhere on the jobsite. Use an air manifold with the supply hose to service multiple air tools (air manifold is sold separately). The hose layering guide spools hose back onto the reel eliminating tangles; cleanup is faster and easier.



L8651FZ



L8654FZ

HOSE I.D.	WORKING PRESSURE
3/8 IN.	300 PSI

HOSE I.D.	WORKING PRESSURE
1/4 IN.	300 PSI

FEATURES:

- **Hose Layering Guide** - Manually operated guide smoothly winds hose without tangles
- **Drum Lock** - Ideal for mobile installations. Prevents air hose from unwinding accidentally
- **Carrying Handle** - For complete portability
- **Support Legs** - Attach support legs for placing reel on ground. Pre-drilled holes can be used for staking reel to the ground

- **Mounting Bracket** - Reel can be mounted on truck, wall or bench
- **Swivel Handle** - Swivels in hand for winding ease. Folds in for transporting
- **Hose Material** - Flexible Hybrid Polymer
- **Lead-in Hose Included** - 5 ft.



ASSEMBLED IN USA
of US and global components

Manual Air Hose Reels – Portable

Part No.	Hose I.D.	Hose Length	Working Pressure @ 70°F	Temperature Range (F°)	Lead-in Hose Connection	Reel Inlet	Hose Outlet	Weight	Retail Packaging	Assembled in USA
L8651FZ	3/8 in.	50 ft.	300 psi	-40° to 140°	1/4 in. MNPT x 1/4 in. MNPT	1/4 in. MNPT	1/4 in. MNPT	21 lbs.	●	●
L8654FZ	1/4 in.	100 ft.	300 psi	-40° to 140°	1/4 in. MNPT x 1/4 in. MNPT	1/4 in. MNPT	1/4 in. MNPT	21 lbs.	-	●

Lead-In Hoses



Flexzilla hose reels come equipped with a lead-in hose as standard equipment. Details regarding the lead-in hose that comes with each reel model are listed below. If for some reason you need to replace your lead-in hose, please refer to the part number that corresponds to your model of reel.



L8651FZLI

Part No.	Lead-in Hose For Part Nos.	Hose I.D.	Hose Length	Fittings	Hose Material	Working Pressure @ 70°F	Temperature Range (F°)	Retail Packaging	Made in USA	Assembled in USA
L8011FZLI	L8011FZ	3/8 in.	5 ft.	3/8 in. MNPT Swivel x 3/8 in. MNPT	Flexible Hybrid Polymer	300 psi	-40° to 140°	-	●	-
L8041FZLI	L8041FZ	1/2 in.	5 ft.	1/2 in. MNPT Swivel x 1/2 in. MNPT	Flexible Hybrid Polymer	300 psi	-40° to 140°	-	-	-
L8250FZLI	L8230FZ L8250FZ	3/8 in.	3 ft.	1/4 in. MNPT	Flexible Hybrid Polymer	150 psi	-40° to 140°	-	-	●
L8305FZLI	L8305FZ L8306FZ	3/8 in.	5 ft.	3/4 in. Female GHT x 1/4 in. MNPT	Flexible Hybrid Polymer	300 psi	-40° to 140°	-	-	-
L8335FZLI	L8335FZ	1/2 in.	5 ft.	3/4 in. Female GHT x 3/8 in. MNPT	Flexible Hybrid Polymer	300 psi	-40° to 140°	-	-	-
L8611FZLI	L8611FZ L8711FZ	3/8 in.	5 ft.	3/8 in. MNPT Swivel x 1/4 in. MNPT	Flexible Hybrid Polymer	300 psi	-40° to 140°	-	●	-
L8651FZLI	L8550FZ L8560FZ L8603FZ L8650FZ L8651FZ L8652FZ	3/8 in.	5 ft.	1/4 in. MNPT x 1/4 in. MNPT	Flexible Hybrid Polymer	300 psi	-40° to 140°	-	●	-
L8654FZLI	L8654FZ	1/4 in.	5 ft.	1/4 in. MNPT x 1/4 in. MNPT	Flexible Hybrid Polymer	300 psi	-40° to 140°	-	-	●



360° ROTATION

Ball swivel rotates
360° at a 30° angle.

HIGH FLOW

High flow couplers and plugs
allow twice the amount of
airflow to your tool.

AIR LINE ACCESSORIES

High Flow Couplers and Plugs



Flexzilla® Pro High Flow couplers and plugs allow Twice The Flow to your air tools compared to standard interchanges. Connect Flexzilla High Flow fittings from your tool all the way to the compressor. This ensures the best performance your air system can provide. For maximum efficiency, use Flexzilla Pro High Flow.



Don't Starve Your Air Tool!

- Push-To-Connect System
- Maximum Torque
- Maximum RPM
- Ideal for spray guns and impact tools or any high output tool

Flexzilla Pro High Flow Ball Swivel brings ergonomic ease to any tool attached to it. Save your wrist and improve your ability to get into hard-to-reach places.

Standard Plug

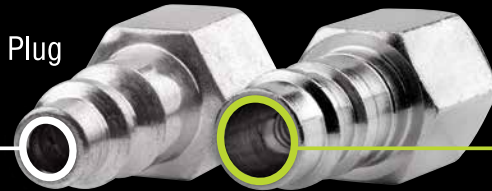

Flexzilla® Pro

Larger internal diameter = Twice The Flow!

When compared to standard interchanges.

Ball swivel rotates 360° at a 30° angle.



High Flow Couplers and Plugs



PRO

Couplers



A53416FZ-X



A53426FZ-X



A53616FZ-X

Part No.	Type	Interchange	Connection Size	Body Size	Max. Pressure	Material	Retail Packaging
High Flow Couplers							
A53416FZ	Z	High Flow	1/4 in. FNPT	1/4 in.	300 psi	Steel/Aluminum*	●
A53416FZ-X	Z	High Flow	1/4 in. FNPT	1/4 in.	300 psi	Steel/Aluminum*	-
A53426FZ	Z	High Flow	1/4 in. MNPT	1/4 in.	300 psi	Steel/Aluminum*	●
A53426FZ-X	Z	High Flow	1/4 in. MNPT	1/4 in.	300 psi	Steel/Aluminum*	-
A53616FZ	Z	High Flow	3/8 in. FNPT	1/4 in.	300 psi	Steel/Aluminum*	●
A53616FZ-X	Z	High Flow	3/8 in. FNPT	1/4 in.	300 psi	Steel/Aluminum*	-
A53626FZ	Z	High Flow	3/8 in. MNPT	1/4 in.	300 psi	Steel/Aluminum*	●
A53626FZ-X	Z	High Flow	3/8 in. MNPT	1/4 in.	300 psi	Steel/Aluminum*	-

*Nickel Plated Steel with Anodized Aluminum Sleeve

-X = Product offered in bulk, individually bagged product

Plugs



PRO



A53430FZ-X

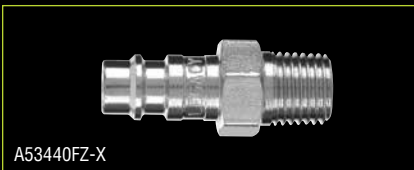

A53440FZ-X



A53440FZBS-X

Part No.	Type	Interchange	Connection Size	Body Size	Max. Pressure	Material	Retail Packaging
High Flow Plugs							
A53430FZ-X	Z	High Flow	1/4 in. FNPT	1/4 in.	300 psi	Nickel Plated Steel	-
A53440FZ-X	Z	High Flow	1/4 in. MNPT	1/4 in.	300 psi	Nickel Plated Steel	-
A53630FZ-X	Z	High Flow	3/8 in. FNPT	1/4 in.	300 psi	Nickel Plated Steel	-
A53640FZ-X	Z	High Flow	3/8 in. MNPT	1/4 in.	300 psi	Nickel Plated Steel	-
A53440FZBS	Z	High Flow	1/4 in. MNPT	1/4 in.	300 psi	Nickel Plated Steel	●
A53440FZBS-X	Z	High Flow	1/4 in. MNPT	1/4 in.	300 psi	Nickel Plated Steel	-
High Flow Plugs – 2-Pc.							
A53430FZ-2PK	Z	High Flow	1/4 in. FNPT	1/4 in.	300 psi	Nickel Plated Steel	●
A53440FZ-2PK	Z	High Flow	1/4 in. MNPT	1/4 in.	300 psi	Nickel Plated Steel	●
A53630FZ-2PK	Z	High Flow	3/8 in. FNPT	1/4 in.	300 psi	Nickel Plated Steel	●
A53640FZ-2PK	Z	High Flow	3/8 in. MNPT	1/4 in.	300 psi	Nickel Plated Steel	●

-X = Product offered in bulk, individually bagged product

High Flow Coupler and Plug Kits



PRO



A53452FZ



A53457FZ



A53657FZ



A53658FZ



A53658FZ Retail Packaging



A86666FZ

Part No.	Type	Interchange	Connection Size	Body Size	Max. Pressure	Material	Contents	Retail Packaging
3-Pc. Coupler and Plug Kit								
A53452FZ	Z	High Flow	1/4 in. NPT	1/4 in.	300 psi	Steel/Aluminum*	(1) FNPT Coupler, (1) FNPT Plug and (1) MNPT Plug	●
7-Pc. Coupler and Plug Kits								
A53457FZ	Z	High Flow	1/4 in. NPT	1/4 in.	300 psi	Steel/Aluminum*	(1) FNPT Coupler, (1) MNPT Coupler, (2) FNPT Plug and (3) MNPT Plug	●
A53657FZ	Z	High Flow	3/8 in. NPT	1/4 in.	300 psi	Steel/Aluminum*	(1) FNPT Coupler, (1) MNPT Coupler, (2) FNPT Plug and (3) MNPT Plug	●
14-Pc. Coupler and Plug Kit								
A53458FZ	Z	High Flow	1/4 in. NPT	1/4 in.	300 psi	Steel/Aluminum*	(2) FNPT Coupler, (2) MNPT Coupler, (4) FNPT Plug and (6) MNPT Plug	●
3-Way Manifold								
A86666FZ	Z	High Flow	3/8 in. NPT	1/4 in.	300 psi	Steel/Aluminum*	(1) 3-Way Flat Hex Manifold, (3) A53626FZ and (1) A53640FZ	●

*Nickel Plated Steel with Anodized Aluminum Sleeve

NEW Heavy Duty Safety Couplers and Plugs

PRO

Flexzilla® Pro Heavy Duty Safety Couplers and Plugs feature ZVR™ Technology, Zero Valve Restriction provides maximum CFM possible. Paired with quick, safe and easy connections, Flexzilla Pro HD Couplers and Plugs are the best choice for maximum performance from your air tools.



FEATURES:

- **ZVR™ Technology** - Zero Valve Restriction provides absolute throughput and feeds your tool the maximum CFM possible
- **Safety Coupler** - Connect and disconnect under zero pressure
- Non-marring

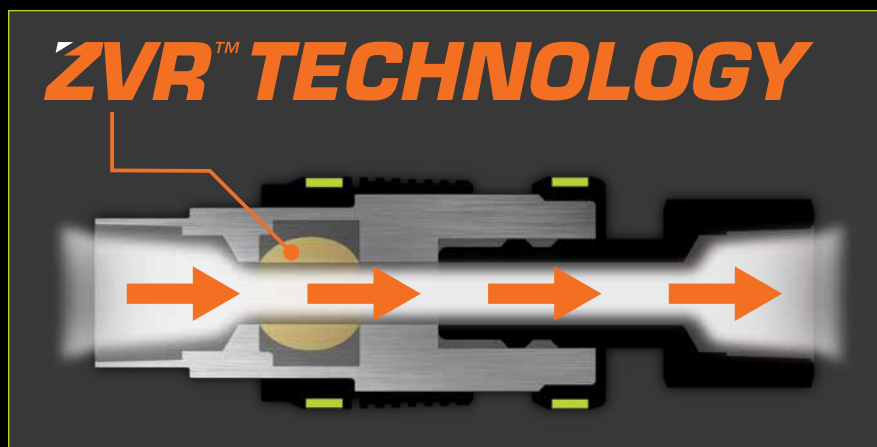

QUICK, SAFE & EASY CONNECTIONS

ENGAGE AT ZERO PRESSURE

DISENGAGE AT ZERO PRESSURE



Push-to-connect under zero pressure



Push sleeve up to open valve and engage air flow



Pull sleeve down to shut off air flow and pull top collar down to disengage plug under zero pressure

NEW

Heavy Duty Safety Couplers and Plugs

PRO

Couplers

Part No.	Type	Interchange	Connection Size	Body Size	Max. Pressure	Material	Retail Packaging
Heavy Duty Safety Couplers							
A55618FZ	H	Industrial	3/8 in. FNPT	1/2 in.	175 psi	Multiple*	●
A55628FZ	H	Industrial	3/8 in. MNPT	1/2 in.	175 psi	Multiple*	●
A55818FZ	H	Industrial	1/2 in. FNPT	1/2 in.	175 psi	Multiple*	●
A55828FZ	H	Industrial	1/2 in. MNPT	1/2 in.	175 psi	Multiple*	●

*Nickel Plated Steel and ABS



Plugs

Part No.	Type	Interchange	Connection Size	Body Size	Max. Pressure	Material	Retail Packaging
Heavy Duty Safety Plugs							
A55630FZ	H	Industrial	3/8 in. FNPT	1/2 in.	232 psi	Nickel Plated Steel	●
A55640FZ	H	Industrial	3/8 in. MNPT	1/2 in.	232 psi	Nickel Plated Steel	●
A55830FZ	H	Industrial	1/2 in. FNPT	1/2 in.	232 psi	Nickel Plated Steel	●
A55840FZ	H	Industrial	1/2 in. MNPT	1/2 in.	232 psi	Nickel Plated Steel	●



Heavy Duty Safety Coupler and Plug Kits

PRO

Part No.	Type	Interchange	Connection Size	Body Size	Max. Pressure	Material	Contents	Retail Packaging
5-Pc. Coupler and Plug Kits								
A55656FZ	H	Industrial	3/8 in. NPT	1/2 in.	175 psi	Multiple*	(1) FNPT Coupler, (1) MNPT Coupler, (1) FNPT Plug, and (2) MNPT Plugs	●
A55856FZ	H	Industrial	1/2 in. NPT	1/2 in.	175 psi	Multiple*	(1) FNPT Coupler, (1) MNPT Coupler, (1) FNPT Plug, and (2) MNPT Plugs	●

*Nickel Plated Steel and ABS



MODULAR ACCESSORIES SYSTEM

Includes needle tips, chip guards, extensions and OSHA-compliant safety nozzles.

INCREASED AIR FLOW

Variable flow trigger that can be tailored to a high power job or delicate precision work.

BLOW GUNS

THOUGHTFULLY DESIGNED

Ergonomic handle and rubberized grip.

Modular Blow Guns

Introducing Flexzilla™ Blow Guns and accessories. Flexzilla features an ergonomically superior gun body for maximum comfort and control which reduces operator fatigue. A variable flow trigger regulates air volume precisely with maximum flow, equal to or greater than the competition. The exclusive modular accessories system allows the Flexzilla blow guns to be customized for extension length and tips needed for any job. Flexzilla safety nozzles and bendable extension are labeled to meet or exceed OSHA standards.

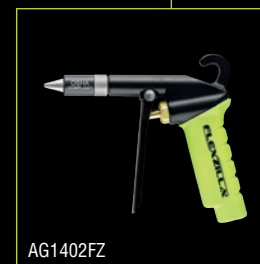

Part No.	Description	CFM	dBA	Variable Flow Trigger	Meets OSHA Number	Line psi	Retail Packaging
AG1102FZ	Flexzilla™ X3™ Blow Gun with Quiet-Flo Safety Nozzle	36	87	●	1910.95 (a), 1910.242 (b)	100	●
AG1202FZ	Flexzilla™ X3™ Blow Gun with Xtreme-Flo Safety Nozzle	50	99	●	1910.242 (b)	100	●
AG1402FZ	Flexzilla™ X1™ Blow Gun with Quiet-Flo Safety Nozzle	36	87	–	1910.95 (a), 1910.242 (b)	100	●
AG1502FZ	Flexzilla™ X1™ Blow Gun with Xtreme-Flo Safety Nozzle	43	99	–	1910.242 (b)	100	●

Modular Blow Gun Kits

Flexzilla™ X3™ 6-Pc. Blow Gun Kit

AG1200FZKIT INCLUDES:

- a – Flexzilla X3 Blow Gun - with Variable Flow Trigger
- b – 6 in. Extension
- c – Chip Guard
- d – Tri-Thrust Safety Nozzle
- e – Xtreme-Flo Safety Nozzle
- f – Quiet-Flo Safety Nozzle



Flexzilla™ X1™ 10-Pc. Blow Gun Kit

AG1500FZKIT INCLUDES:

- a – Flexzilla X1 Blow Gun
- b – 6 in. Extensions (x2)
- c – Needle Tips (1 in., 2 in. & 3 in.)
- d – Xtreme-Flo Safety Nozzle
- e – Quiet-Flo Safety Nozzle
- f – Rubber Tip
- g – Tip Adapter

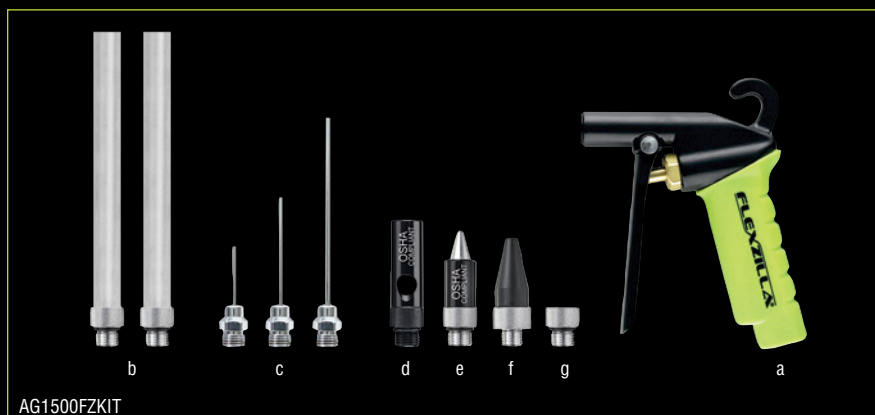

Part No.	Retail Packaging
AG1200FZKIT	●
AG1500FZKIT	●

Modular Blow Guns Accessories System

The exclusive modular accessories system (sold separately) allows the Flexzilla™ blow guns to be customized for extension length and tips needed for any job. Flexzilla safety nozzles and bendable extension are labeled to meet or exceed OSHA standards. Extensions can be combined up to 6 feet.

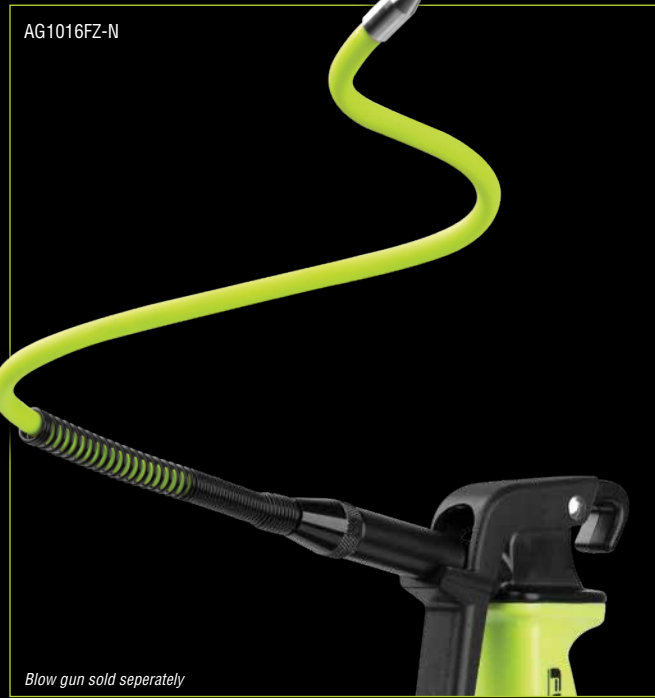
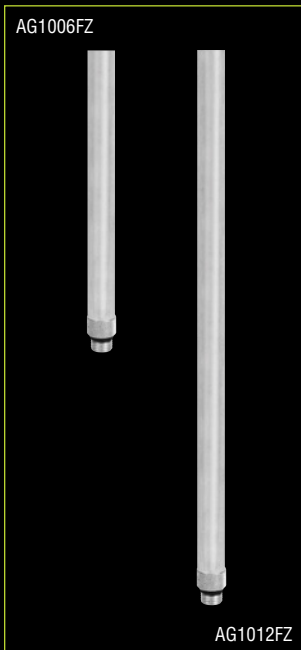
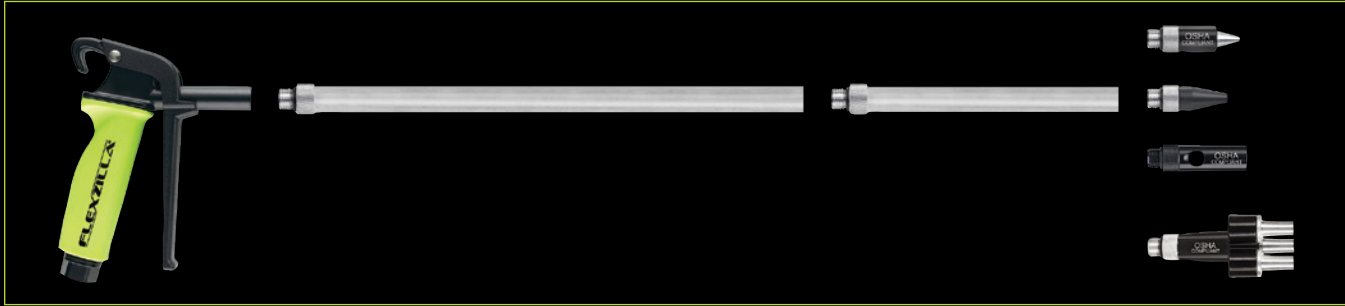

Part No.	Description	Retail Packaging
AG934FZ	Flexzilla™ Rubber Tip	●
AG1090FZ	Flexzilla™ Xtreme-Flo Safety Nozzle	●
AG1091FZ	Flexzilla™ Quiet-Flo Safety Nozzle	●
AG1093FZ	Flexzilla™ Tri-Thrust Safety Nozzle	●
AG1099FZ	Flexzilla™ 5-Pc. Tip Adapter Kit	●
AG1092FZ	Flexzilla™ Chip Guard	●
AG1006FZ	Flexzilla™ 6 in. Extension	●
AG1012FZ	Flexzilla™ 12 in. Extension	●
AG1016FZ-N	Flexzilla™ 16 in. Bendable Extension	●

BREAKAWAY TORQUE

Delivers 800 ft-lbs. of nut-busting breakaway torque.

AIR TOOLS

LIGHTWEIGHT & COMPACT

Making it easy to get into those hard to reach areas.

Mini Impact Wrench



PRO



AT1475FZ

TORQUE	DRIVE
800 FT-LBS.	1/2 IN.
HIGH SPEED	AIR CONSUMPTION
9500 RPM	4.8 CFM

Proving once again you don't have to be big to be powerful. Flexzilla® Pro Air Tools pack high RPM and maximum torque into the lightest, most compact air tools on the market. The mini impact wrench has 800 ft-lbs. of nut-busting breakaway torque and an extremely lightweight design.

Flexzilla Pro Mini Impact Wrench (AT1475FZ)

FEATURES:

- 800 ft-lbs. of nut-busting breakaway torque
- Compact design – Ideal for tight spaces, 4.4 in.
- Torque selector – Maximum torque, 550 ft-lbs.
- Extremely lightweight – Composite design, 2.5 lbs.
- Patented Forward/Reverse toggle switch
- Handle exhaust – Directs air away from user
- 1/4 in. NPT air inlet with built-in swivel
- Ergonomic grip
- High speed, 9500 RPM
- Air Consumption: 4.8 CFM
- Drive: 1/2 in.

INCLUDES:

- Flexzilla Pro Mini Impact Wrench
- Flexzilla Pro High Flow 1/4 in. MNPT Ball Swivel Plug



Part No.	Retail Packaging
AT1475FZ	●

Reactionless Mini Air Ratchet Kit



AT8535FZ

TORQUE	DRIVE
45 FT-LBS.	3/8 IN.
HIGH SPEED	WEIGHT
700 RPM	1.5 LBS.

Get in tight spots and get the job done with Flexzilla® Pro Reactionless Mini Air Ratchet. No more busted knuckles. No pinched fingers. The reactionless clutch prevents kickback when you bottom out. The compact and lightweight design is perfect for small workspaces like under automotive dashboards. Plus, its super high-speed lets you remove or tighten bolts in a flash.

Flexzilla Pro Reactionless Mini Air Ratchet Kit (AT8535FZ)

FEATURES:

- Reactionless clutch
- Built-in air regulator
- Built-in swivel
- High speed, 700 RPM
- Torque: 45 ft-lbs.
- Rear exhaust
- Compact and lightweight
- Length: 7.5 in.
- Weight: 1.5 lbs.
- Drive: 3/8 in.

KIT INCLUDES:

- Flexzilla Pro Reactionless Mini Air Ratchet
- Flexzilla Pro Custom Length Whip Hose with High Flow Ball Swivel and Reusable Fitting, 3/8 in. x 6 ft.
- Flexzilla Pro High Flow Couplers and Plugs
 - (1) 1/4 in. FNPT Coupler
 - (1) 1/4 in. MNPT Coupler
 - (2) 1/4 in. FNPT Plugs

Part No.	Retail Packaging
AT8535FZ	●

Reciprocating Mini Air Saw Kit



AT8565FZ

HIGH SPEED	AIR CONSUMPTION	WEIGHT
9500 SPM	3.5 CFM	0.9 LBS.

The Flexzilla® Pro Reciprocating Mini Air Saw is perfect for working in tight spaces to get the job done. The lightweight, compact design and low vibration reduces operator fatigue during extended use. Plus, its high-speed, strokes per minute, allows you to cut through the toughest materials with ease and comfort.

Flexzilla Pro Reciprocating Mini Air Saw Kit (AT8565FZ)

FEATURES:

- High speed (Blade speed), 9500 SPM
- Air consumption: 3.5 CFM
- Low vibration
- Rear exhaust
- Compact and lightweight
- Length: 6.3 in.
- Weight: 0.9 lbs.

KIT INCLUDES:

- Flexzilla Pro Reciprocating Mini Air Saw
- Flexzilla Pro Custom Length Whip Hose with High Flow Ball Swivel and Reusable Fitting, 3/8 in. x 6 ft.
- Flexzilla Pro High Flow Couplers and Plugs
 - (1) 1/4 in. FNPT Coupler
 - (1) 1/4 in. MNPT Coupler
 - (2) 1/4 in. FNPT Plugs
- Blades
 - (1) Coarse (24 tooth)
 - (1) Fine (32 tooth)
- Allen Wrench

Part No.	Retail Packaging
AT8565FZ	●

Reactionless Mini Air Ratchet Kit



Get in tight spots and get the job done with Flexzilla® Reactionless Mini Air Ratchet. No more busted knuckles. No pinched fingers. The reactionless clutch prevents kickback when you bottom out. The compact and lightweight design is perfect for small workspaces, like under automotive dashboards. Plus, its super high-speed lets you remove or tighten bolts in a flash. This convenient kit includes Flexzilla Reactionless Mini Air Ratchet, ColorConnex® X-Flo™ Couplers and Plugs, and a Flexzilla® Whip Hose.

Flexzilla Reactionless Mini Air Ratchet Kit (AT8530FZ)

FEATURES:

- Reactionless clutch
- High speed, 650 RPM
- Torque: 40 ft-lbs.
- Rear exhaust
- Compact and lightweight
- Length: 6.5 in.
- Weight: 1.3 lbs.
- Drive: 3/8 in.

KIT INCLUDES:

- Flexzilla Reactionless Mini Air Ratchet
- Flexzilla Whip Hose, 3/8 in x 2 ft.
- ColorConnex® X-Flo™ Couplers and Plugs
 - (1) X-Flo Coupler, 1/4 in. FNPT
 - (1) X-Flo Coupler, 1/4 in. MNPT
 - (1) Plug, 1/4 in. FNPT
 - (1) Plug, 1/4 in. MNPT



AT8530FZ

TORQUE	DRIVE
40 FT-LBS.	3/8 IN.
HIGH SPEED	WEIGHT
650 RPM	1.3 LBS.

Part No.

Retail Packaging

AT8530FZ



TIRE MAINTENANCE

INFLATE AND MONITOR

Inflate and check tire pressure simultaneously at a safe distance.

Tire Inflators



Tire inflators deliver accurate pressure to car, truck, bike, and off-road tires.



AL2000FZ

AL2000FZ FEATURES:

- Range: 20 to 170 psi
- Straight-on chuck with 12 in. air hose
- Heavy-duty gauge
- Indicator bar is calibrated in 2 psi increments from 20 to 100 psi



AL2025FZ-1

AL2025FZ-1 FEATURES:

- Range: 10 to 170 psi
- Quick-connect coupler and plug
- Trigger actuated deflate function
- Straight lock-on connector
- Dial gauge with protective rubber guard
- Includes: 3 ft. air hose extension



AL2025FZ-2

AL2025FZ-2 FEATURES:

- Range: 10 to 170 psi
- Quick-connect coupler and plug
- Trigger actuated deflate function
- Straight lock-on connector
- Dial gauge with protective rubber guard
- Includes: 3 and 15 ft. air hose extensions
- OSHA Compliant - 15 ft. hose only



Part No.	Type	Hose I.D.	Hose Length	Inlet	Body Material	Retail Packaging
AL2000FZ	Tire Inflator	1/4 in.	1 ft.	1/4 in. FNPT	Die-cast Zinc	●
AL2025FZ-1	Inflator Kit	1/4 in.	3 ft.	1/4 in. FNPT	Nylon/Brass	●
AL2025FZ-2	Combo Inflator Kit	1/4 in.	3 ft. & 15 ft.	1/4 in. FNPT	Nylon/Brass	●
HGH2-FZ	Truck Tire Inflator Kit	3/8 in.	50 ft.	1/4 in. MNPT	-	●

Truck Tire Inflator Kit



The Flexzilla® truck tire inflator kit uses a truck's on-board air supply to inflate tires in remote situations.

HGH2-FZ INCLUDES:

- 3/8 in. x 50 ft. air hose
- Glad-hand attachment
- 30° Dual air chuck



HGH2-FZ

EXCLUSIVE SWIVELGRIP™

SwivelGrip™ action allows the water hose to rotate freely inside the grip. It eliminates twists in the hose as you uncoil it and prevents kinks in the hose as you move across the yard.

(SwivelGrip™ Patent Pending)

WATER HOSES

EXTREME ALL-WEATHER FLEXIBILITY

Lightweight and easy to handle, Flexzilla® hoses lay flat and have no memory, even in extreme weather conditions.

FLEXIBLE HYBRID POLYMER

Flexzilla hoses have a durable, abrasion-resistant outer cover.

SwivelGrip™ Garden and Lead-in Hose Assemblies



Flexzilla® makes it easier to work around your home and lawn. SwivelGrip™ action eliminates twists that occur when uncoiling a hose. Conventional garden hose can trap coils that tighten into kinks as you move across the yard. SwivelGrip releases these trapped coils because the hose rotates freely inside the grip. The large, comfortable gripping surface on both ends of the hose makes connections much easier to turn and tighten. Plus, with our superior O-ring, you get a long-term, leak-free connection at the spigot. SwivelGrip hoses are also drinking water safe.



HFZG550YWS

FEATURES:

- Male and female SwivelGrip™ Connections
- Extreme all-weather flexibility
- Won't kink under pressure
- Lightweight, coils easily
- Lays flat - no memory
- Durable and abrasion-resistant outer cover
- Anodized aircraft aluminum ends
- Leak-free O-rings
- Max. working pressure at 70°F: 150 psi
- Drinking water safe



Part No.	Hose I.D.	Hose Length	Fittings	Retail Packaging
HFZG503YWS	5/8 in.	3 ft.	3/4 in. - 1 1/2 GHT	●
HFZG505YWS	5/8 in.	5 ft.	3/4 in. - 1 1/2 GHT	●
HFZG510YWS	5/8 in.	10 ft.	3/4 in. - 1 1/2 GHT	●
HFZG510YWS-6X	5/8 in.	10 ft.	3/4 in. - 1 1/2 GHT	●
HFZG525YWS	5/8 in.	25 ft.	3/4 in. - 1 1/2 GHT	●
HFZG550YWS	5/8 in.	50 ft.	3/4 in. - 1 1/2 GHT	●
HFZG550YWS-30X	5/8 in.	50 ft.	3/4 in. - 1 1/2 GHT	●
HFZG550YWS-40X	5/8 in.	50 ft.	3/4 in. - 1 1/2 GHT	●
HFZG575YWS	5/8 in.	75 ft.	3/4 in. - 1 1/2 GHT	●
HFZG5100YWS	5/8 in.	100 ft.	3/4 in. - 1 1/2 GHT	●

Part nos. with a -30X or -40X suffix include 30 or 40 hose assemblies respectively on a quarter pallet display

Part no. with a -6X suffix includes 6 hose assemblies in a retail merchandiser display



HFZG503YWS



HFZG550YWS

Exclusive SwivelGrip™ Action

- Hose spins freely to release coils!

Hose turns inside grip

Makes connections easy

Attachments

Spigot

Connects Easily

Garden Hose Merchandiser and Pallets



Garden Hose Merchandiser Tray

Garden Hose Quarter Pallet

Garden Hose Pallet

Colors™ SwivelGrip™ Garden Hose Assemblies



From the makers of Flexzilla® hoses, tools and equipment, Colors™ Garden Hose with exclusive SwivelGrip™ action allows the hose to uncoil easily and provides tangle free yardwork. Easily connect the hose to spigot and attachments. It features the same Flexible Hybrid Polymer material as our renowned ZillaGreen™ hoses, but comes in earthy colors that blend with a variety of landscapes. (SwivelGrip™ Patent Pending)



HFZC550BRS



HFZC550BRS



HFZC550TCS

SWIVELGRIP™ FEATURES:

- Male and female SwivelGrip Connections
- Exclusive SwivelGrip Action
- Hose turns freely inside grip
- Uncoils easily
- Easily connects to attachments
- Tangle free yardwork

Part No.	Color	Hose I.D.	Hose Length	Fittings	Retail Packaging
HFZC550BRS	Brown Mulch	5/8 in.	50 ft.	3/4 in. - 1 1/2 GHT	●
HFZC550TCS	Red Clay	5/8 in.	50 ft.	3/4 in. - 1 1/2 GHT	●

Garden and Lead-in Hose Assemblies



Flexzilla® Garden Hose was engineered with a lightweight Flexible Hybrid Polymer to lie flat and eliminate kinking under pressure. It redefines flexibility, making it easy to maneuver around trees, bushes or other obstacles. Zero memory means your sprinkler stays put without twisting. And Flexzilla Garden Hose doesn't fight you when you coil it. Plus, with our superior O-ring, you get a long-term, leak-free connection at the spigot. The Flexible Hybrid Polymer inner tube material is drinking water safe.



HFZG550YW



HFZG503YW



HFZG510YW

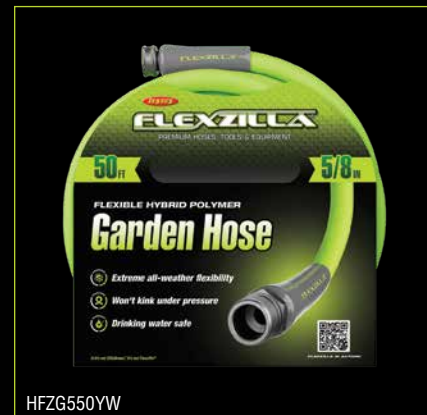

HFZG550YW

Part No.	Hose I.D.	Hose Length	Fittings	Retail Packaging
HFZG503YW	5/8 in.	3 ft.	3/4 in. - 1 1/2 GHT	●
HFZG505YW	5/8 in.	5 ft.	3/4 in. - 1 1/2 GHT	●
HFZG510YW	5/8 in.	10 ft.	3/4 in. - 1 1/2 GHT	●
HFZG525YW	5/8 in.	25 ft.	3/4 in. - 1 1/2 GHT	●
HFZG550YW	5/8 in.	50 ft.	3/4 in. - 1 1/2 GHT	●
HFZG550YW-48T	5/8 in.	50 ft.	3/4 in. - 1 1/2 GHT	●
HFZG575YW	5/8 in.	75 ft.	3/4 in. - 1 1/2 GHT	●
HFZG575YW-48T	5/8 in.	75 ft.	3/4 in. - 1 1/2 GHT	●
HFZG5100YW	5/8 in.	100 ft.	3/4 in. - 1 1/2 GHT	●
HFZG5100YW-36T	5/8 in.	100 ft.	3/4 in. - 1 1/2 GHT	●
HFZG650YW	3/4 in.	50 ft.	3/4 in. - 1 1/2 GHT	●
HFZG675YW	3/4 in.	75 ft.	3/4 in. - 1 1/2 GHT	●
HFZG6100YW	3/4 in.	100 ft.	3/4 in. - 1 1/2 GHT	●
HFZG450YW-TV	1/2 in.	50 ft.	3/4 in. - 1 1/2 GHT	●

Part nos. with a -36T or -48T suffix include 36 or 48 hose assemblies respectively on a pallet display

HFZG450YW-TV also includes hose hanger

NSF/ANSI 61



Garden Hose Kit with Quick Connect Attachments

The Flexzilla® Garden Hose Kit with Quick Connect Attachments features Flexible Hybrid Polymer material with extreme all-weather flexibility that allows hose to lie flat and won't kink under pressure. It's lightweight and coils easily. The convenient Flexzilla Garden Hose Kit comes with hose, twist action nozzle, quick connect stop-flow coupler, spigot adapter, hose adapters and hose hanger to make gardening a snap.



Part No.	Hose I.D.	Hose Length	Fittings	Retail Packaging
HFZG12050QN	1/2 in.	50 ft.	3/4 in. - 1 1/2 GHT	●

HOSE FEATURES:

- Extreme all-weather flexibility
- Won't kink under pressure
- Lightweight, coils easily
- Lays flat - no memory
- Durable and abrasion-resistant outer cover
- Quick connect couplers
- Max. working pressure at 70°F: 150 psi

SPRAY NOZZLE FEATURES:

- Soft mist for flowers and plants
- Jet spray for long distances (up to 20 ft.)

GARDEN HOSE KIT INCLUDES:

- a – Flexzilla Garden Hose with Quick Connect Couplers
- b – Hose hanger
- c – Nozzle
- d – Adapter for spigot
- e – (2) Garden hose attachment adapters



3-Piece Nozzle Kit with Quick Connections

KIT INCLUDES:

- Quick Connect Spray Nozzle
 - Soft mist for flowers and plants
 - Jet spray for long distances (up to 20 ft.)
- Stop-Flow Coupler – Prevents user from being sprayed when connecting and disconnecting
- Quick Connect Attachment Adapter – Easily connect to sprinkler or other attachments

Part No.	Retail Packaging
HFZGAK01	–
HFZGAK02	●



NEW Garden Hose Nozzles

Flexzilla™ Garden Hose Nozzles are designed for a wide range of water needs and are suitable for gardening, cleaning, washing your car, or showering dogs and other pets. They are available in a variety of styles, are simple to operate and built to withstand years of tough use.

NFZG61 FEATURES:

- Thumb control design – 3 position
- Heavy duty metal construction
- Adjustable spray patterns: shower, flat, jet
- Soft grip dial guard
- Ergonomic soft grip handle
- Leak-free O-ring

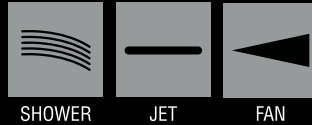

SHOWER JET FAN

NFZG62 FEATURES:

- Variable flow pattern – Soft mist to jet spray
- Heavy duty metal construction
- Soft grip outer housing
- Compact design
- Leak-free O-ring

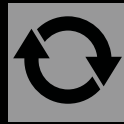

VARIABLE FLOW PATTERN

NFZG63 FEATURES:

- Adjustable spray patterns: shower, full, jet, cone
- Soft grip dial guard
- Leak-free O-ring

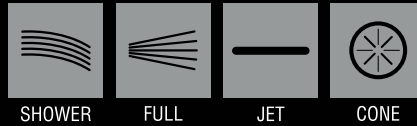

SHOWER FULL JET CONE

NFZG64 FEATURES:

- On/Off toggle switch with variable flow
- 6-pattern adjustable spray patterns: mist, vertical, shower, cone, flat, jet
- Durable outer housing
- Soft grip dial guard
- Lightweight soft grip handle
- Leak-free O-ring

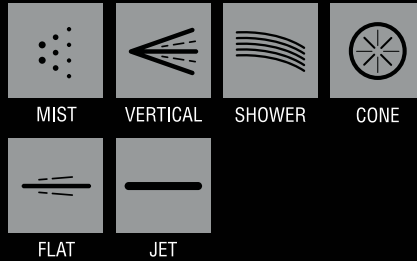

MIST VERTICAL SHOWER CONE
FLAT JET



NFZG61



NFZG62



NFZG63



NFZG64

Part No.	Description	Retail Packaging
NFZG61	Heavy Duty Pistol Grip Garden Hose Nozzle	●
NFZG61-8X	Heavy Duty Pistol Grip Garden Hose Nozzle, 8-Piece Merchandiser	●
NFZG61-12X	Heavy Duty Pistol Grip Garden Hose Nozzle, 12-Piece Merchandiser	●
NFZG62	Heavy Duty Twist Action Garden Hose Nozzle	●
NFZG62-12X	Heavy Duty Twist Action Garden Hose Nozzle, 12-Piece Merchandiser	●
NFZG63	4-Pattern Twist Action Garden Hose Nozzle	●
NFZG63-12X	4-Pattern Twist Action Garden Hose Nozzle, 12-Piece Merchandiser	●
NFZG64	6-Pattern Adjustable Garden Hose Nozzle	●
NFZG64-8X	6-Pattern Adjustable Garden Hose Nozzle, 8-Piece Merchandiser	●
NFZG64-12X	6-Pattern Adjustable Garden Hose Nozzle, 12-Piece Merchandiser	●

Part nos. with -8X or -12X suffix include 8 or 12 garden nozzles respectively in a retail merchandiser display

NEW Garden Hose Nozzle Merchandisers



NFZG61-12X
Heavy Duty Pistol Grip Garden Hose Nozzle, 12-Piece Merchandiser



NFZG62-12X
Heavy Duty Twist Action Garden Hose Nozzle, 12-Piece Merchandiser



NFZG63-12X
4-Pattern Twist Action Garden Hose Nozzle, 12-Piece Merchandiser



NFZG61-8X
Heavy Duty Pistol Grip Garden Hose Nozzle, 8-Piece Merchandiser



NFZG64-8X
4-Pattern Twist Action Garden Hose Nozzle, 8-Piece Merchandiser



NFZG64-12X
6-Pattern Adjustable Garden Hose Nozzle, 12-Piece Merchandiser

Flexzilla® Pro Water Hose



FIELD REPAIRABLE



CUSTOM LENGTHS

Flexzilla® Pro Water Hose is available in pre-assembled coils or in our Custom Hose Centers where the end user can fabricate a custom length hose for any application. The field repair and custom length hose process takes

3 EASY STEPS



CUT – Remove damaged portion of hose or measure and cut desired length at 90° angle.



INSTALL – Slide spiral fitting and nut onto hose. Push hose onto fitting until hose reaches threads.



TIGHTEN – Tighten fitting nut until snug. Slide bend restrictor up and snap onto nut.

Custom Water Hose Centers



The Flexzilla® Pro Custom Water Hose Centers allow you to provide your customers with custom length hose. Using Flexzilla Pro reusable ends, you can quickly and easily create custom length hose assemblies on site. The Custom Water Hose Centers also include Flexzilla SwivelGrip™ Garden lead-in hose assemblies.



HFZWHC1



HFZCBRP3

SwivelGrip™ Garden Lead-In hoses are not field repairable



Custom Water Hose Centers (continued)



Part No.	Description	Rack Quantity
HFZWHC1 - Flexzilla® Pro Custom Water Hose Center		
HFZW58250YW	Flexzilla® Pro Water Hose, 5/8 in. x 250 ft. Spool, ZillaGreen™	3 ea.
RP900625F	Flexzilla® Pro Water Hose Female Reusable Fitting, 5/8 in.	30 ea.
RP900625M	Flexzilla® Pro Water Hose Male Reusable Fitting, 5/8 in.	30 ea.
HFZG503YWS	Flexzilla® Garden Lead-in Hose with SwivelGrip™, 5/8 in. x 3 ft.	10 ea.
HFZG510YWS	Flexzilla® Garden Lead-in Hose with SwivelGrip™, 5/8 in. x 10 ft.	20 ea.
HR-05	Custom Hose Center (Freestanding Rack)	1 ea.
HFZCBRP3 - Flexzilla® Pro Colors Custom Water Hose Center		
HFZW58250YW	Flexzilla® Pro Water Hose, 5/8 in. x 250 ft. Spool, ZillaGreen™	1 ea.
HFZC58250BRS	Flexzilla® Pro Water Hose, 5/8 in. x 250 ft. Spool, Brown Mulch	1 ea.
HFZC58250TCS	Flexzilla® Pro Water Hose, 5/8 in. x 250 ft. Spool, Red Clay	1 ea.
RP900625F	Flexzilla® Pro Water Hose Female Reusable Fitting, 5/8 in.	30 ea.
RP900625M	Flexzilla® Pro Water Hose Male Reusable Fitting, 5/8 in.	30 ea.
HFZG503YWS	Flexzilla® Garden Lead-in Hose with SwivelGrip™, 5/8 in. x 3 ft.	10 ea.
HFZG510YWS	Flexzilla® Garden Lead-in Hose with SwivelGrip™, 5/8 in. x 10 ft.	20 ea.
HR-05	Custom Hose Center (Freestanding Rack)	1 ea.

Parts also sold separately in standard pack quantities



Water Hose Assemblies



FEATURES:

- Field Repairable – Reusable anodized aircraft aluminum fittings
- Extreme all-weather flexibility
- Lightweight, coils easily
- Won't kink under pressure
- Lays flat - no memory
- Durable and abrasion-resistant outer cover
- Leak-free O-rings
- Max. working pressure at 70°F: 150 psi
- Flexzilla Pro Reusable Fittings include bend reinforcement to reduce wear and tear, prolonging the life of the hose
- Drinking water safe



Part No.	Hose I.D.	Hose Length	Fittings	Retail Packaging
HFZWP550	5/8 in.	50 ft.	3/4 in. - 11½ GHT	●
HFZWP575	5/8 in.	75 ft.	3/4 in. - 11½ GHT	●
HFZWP5100	5/8 in.	100 ft.	3/4 in. - 11½ GHT	●



Water Hose Nozzles



FEATURES:

- Precision flow port – Inline connection allows water to flow directly, not up and through the handle – increases water flow, pressure and power by approximately 30%
- Multiple spray patterns – Select from jet, fan, power or low flow spray – perfect for any job in the shop, garage or home
- Ergonomic handle provides an easy grip for less user fatigue
- Machined aircraft aluminum barrel and Santoprene™ rubber handle and head
- Durable, non-marring outer cover that protects painted surfaces
- Leak-free O-ring - outlasts the competition
- Works with 1/2, 5/8 and 3/4 in. water hose

Retractable Water Hose Reel with Levelwind™ Technology



Featuring Levelwind™ – Flexzilla’s unique winding system that automatically layers hose back and forth across the reel ensuring that the hose is coiled smoothly, easily...every time – and includes Flexzilla® water hose and lead-in hose.



L8340FZ

FEATURES:

- **Latching Mode Switch** – Choose from latching hose every 3 ft. for extended use or switch to free run for immediate automatic rewinding
- **Seven Position Locking Bracket** – These reels can swivel freely on the mounting bracket up to 135° or can be locked into place using the locking brace. Up to seven different locking angles can be utilized (L8300-W)
- **Adjustable Hose Stopper** – Increase or decrease the length of the hose that remains when hose is fully retracted
- **Extra Large Swivel** – A 3/4 in. swivel reduces flow restriction and allows maximum flow
- **Free Standing Base** – Portable - Use freestanding or mounted on wall or ceiling. Flat base allows reel to rest on ground
- **Built-In Handle** – For carrying ease
- **Durable Construction** – Made from durable UV stabilized polypropylene
- **Lead-in Hose Included** – 10 ft. x 3/4 in. x 11½ GHT (L8340FZLI)

 **ASSEMBLED IN USA**
of US and global components

Retractable Water Hose Reels with Levelwind™ Technology

Part No.	Hose I.D.	Hose Length	Hose Material	Working Pressure @ 70°F	Reel Inlet	Weight	Retail Packaging	Assembled in USA
L8340FZ	1/2 in.	70 ft.	Flexible Hybrid Polymer	150 psi	3/4 in. – 11½ Male GHT	31 lbs.	●	●

Mounting Brackets



L8300-W



L8300-B

L8300-W FEATURES:

- Includes a seven position locking brace
- Reel can swivel freely on mounting bracket up to 135° or can be locked into place using the locking brace
- Mounting options: wall or overhead ceiling

L8300-B FEATURES:

- Includes a seven position locking brace
- Reel can swivel freely on mounting bracket up to 360° or can be locked into place using the locking brace
- Mounting options: high wall or bench

Pressure Washer Hose Assemblies

Flexzilla® offers a revolutionary pressure washer hose that redefines flexibility, even under pressure. Unlike other pressure washer hose, Flexzilla stays flexible when pressurized during use and offers minimal memory when depressurized. It also lays flat and won't work against you before, during or after use.



HFZPW3425M

FEATURES:

- Extreme flexibility under pressure, from subzero to 140°F
- Made of Flexible Hybrid Polymer material
- Integral non-kink bend restrictor
- Max. working pressure at 70°F: 3,100 psi
- Cold water use only

 **MADE IN USA**



HFZPW3425M

Part No.	Hose I.D.	Hose Length	Fittings	Yoke/Stem	Retail Packaging	Made in USA
HFZPW3425M	1/4 in.	25 ft.	M22	14 mm	●	●
HFZPW3425M-5X	1/4 in.	25 ft.	M22	14 mm	●	●
HFZPW3450M	1/4 in.	50 ft.	M22	14 mm	●	●
HFZPW3450M-3X	1/4 in.	50 ft.	M22	14 mm	●	●
HFZPW3525M	5/16 in.	25 ft.	M22	14 mm	●	●
HFZPW3525M-5X	5/16 in.	25 ft.	M22	14 mm	●	●
HFZPW3550M	5/16 in.	50 ft.	M22	14 mm	●	●
HFZPW3550M-3X	5/16 in.	50 ft.	M22	14 mm	●	●

Part nos. with -3X or -5X suffix include 3 or 5 hose assemblies respectively in a retail merchandiser display



HFZPW3550M-3X



HFZPW3425M-5X

LIGHTED PLUG

Light up any work site with the lighted power indicator, ensuring you can always find the power source.



GLOW STRIPE

Features a glow-in-the-dark stripe that runs the length of the cord.



EXTENSION CORDS

Extension Cords

PRO

Flexzilla® Pro industrial grade extension cords are engineered to hold up to the toughest jobs. They are easy to coil and remain flexible in temperatures as low as -58°F and up to 140°F. Plus, the grounded plug includes a lighted power indicator which lets you know power is running through the cord. Flexzilla Pro Extension Cords are ideal for outdoor industrial grade applications.

FEATURES:

- Extreme all-weather flexibility (-58°F to 140°F)
- Abrasion and corrosion-resistant
- Glow-in-the-dark stripe
- Power indicator light
- Resists kinks and easy to coil
- Grounded plug
- Water Resistant
- Flame Retardant
- Outdoor use
- cULus Listed



Part No.	Cord Length	Gauge	Retail Packaging
FZ512930	50 ft.	10 ga.	●
FZ512935	100 ft.	10 ga.	●
FZ512825	25 ft.	12 ga.	●
FZ512830	50 ft.	12 ga.	●
FZ512835	100 ft.	12 ga.	●
FZ512725	25 ft.	14 ga.	●
FZ512730	50 ft.	14 ga.	●
FZ512735	100 ft.	14 ga.	●



Flexzilla® Pro Extension Cords are manufactured by Prime Wire & Cable, Inc. in partnership with Legacy Manufacturing Company, and are distributed by both Prime Wire & Cable and Legacy Mfg. Co.

NEW Retractable Extension Cord Reel

The Flexzilla® Retractable Extension Cord Reel comes pre-loaded with 50 feet of oil resistant cord, a lighted triple tap outlet and grounded 5 foot lead-in cord. The reel also contains a circuit breaker with reset button, adjustable cord stopper, power indicator light, and a swivel mounting bracket. The reel locks the cord out in 1 foot increments. The reel case is made of durable UV stabilized polypropylene and designed to store the extension cord when not in use. This retractable reel is ideal for general, commercial and industrial use.

FEATURES:

- Lighted triple tap outlet for plenty of capacity
- Circuit breaker with reset button prevents breaker from tripping and blown fuses. Reset circuit at reel
- Oil-Resistant 14/3 AWG SJTOW cord is flexible in low temperatures and resists the effects of oil, water and sunlight
- Cord locks out in 1 ft. increments
- Adjustable cord stopper ensures outlet is always within reach
- Power indicator light
- Grounded plug includes 5 ft. lead-in cord
- Swivel mounting bracket pivots in the direction of your work. Reel can be mounted to wall or ceiling.
- Recommended for dry, indoor locations
- cULus Listed



FZ8140503

GAUGE	CORD LENGTH
14 GA.	50 FT.

Part No.	Cord Length	Gauge	AMP	Retail Packaging
FZ8140503	50 ft.	14 ga.	13A	●



Grounded Plug



LISTED

GREASING EQUIPMENT

FLEXZILLA® GREASE HOSE

Stays flexible, even in subzero temperatures.



LED LIGHTING

Keep your work space well-lit long after sundown.

RAPID RELOAD™ TECHNOLOGY

Push button technology that allows for quick cartridge loading and includes a threadless grease barrel.

(Rapid Reload™ Push Button Technology Patent Pending)



20V Cordless Grease Gun Kit

There is a new creature dominating automotive shops, farms and worksites across the country. Introducing the Flexzilla® 20V Cordless Grease Gun Kit. It proves what can be accomplished when you combine over 30 years of grease gun experience from Legacy Manufacturing with the extreme performance of Flexzilla.



GREASE GUN FEATURES:

- Rapid Reload™ Push Button Technology
 - For fast cartridge loading and unloading
 - Includes lightweight threadless grease barrel
- Flexzilla Grease Hose - 42 in.
 - Extreme cold-weather flexibility (subzero to 140°F)
 - Non-kink bend restrictor
- LED Light - Illuminate workspace
- Ergonomic Grip
- Non-slip Pads - Stabilize gun when standing up and laying on its side. Ideal for tight spaces
- Hose Dock - Secure and manage hose
- Lightweight Aluminum Barrel with Firm Grip Knurling - For better grip and durability
- Positive T-Grip Follower Handle
- Pressure Relief Valve
- 4-Jaw Coupler - Provides quality connection, disconnection, and sealing to zerk
- Holds 14 oz. Grease Cartridge (Cartridge not included)
- Delivers up to 7,000 psi

RAPID RELOAD™ PUSH BUTTON TECHNOLOGY

- For fast cartridge loading
- (Patent Pending)



Press to release barrel



Slide barrel out to reload



L1388LFZ KIT INCLUDES:

- Flexzilla 20V Cordless Grease Gun
- Flexzilla Grease Hose - 42 in.
- (2) 20V Lithium-Ion Rechargeable Batteries
- 1-Hour Quick Charger
- Automatic Air Bleeder
- 4-Jaw Coupler
- Shoulder Strap
- Carrying Case

Part No.	Description	Retail Packaging
L1388LFZ	Flexzilla® 20V Cordless Grease Gun Kit	●
L1388LFZ-B	Flexzilla® 20V Lithium-Ion Rechargeable Battery for L1388LFZ	●
L1388LFZ-C	Flexzilla® 20V Lithium-Ion 1-Hour Quick Charger for L1388LFZ-B	●

Lever Action Grease Gun

The highest standards of engineering and craftsmanship are built into every Flexzilla® Grease Gun making them the choice for those who work in rugged conditions. Flexzilla Grease Hoses are more flexible than traditional rubber or thermoplastic hoses and stay flexible, even in subzero temperatures.

Heavy Duty Lever Action Grease Gun - Variable Stroke



FEATURES:

- Flexzilla 18 in. Grease Hose - Extreme cold-weather flexibility (subzero to 140°F)
- Soft Barrel Grip - Provides better ergonomic control and comfort
- Heavy-Duty Cast Head Construction - For maximum durability and longer service life
- Durable Follower Rod And Spring - For consistent priming
- Bleeder Valve - For purging unwanted air
- Variable Stroke - Allows grease delivery in confined areas
- 4-Jaw Coupler - Provides quality connection, disconnection, and sealing to zerk
- 3-Way Loading - Cartridge, bulk, filler nipple
- Wide Grip Clearance
- Holds 14 oz. Grease Cartridge
- Includes 6 in. rigid extension

Part No.	Retail Packaging
L1355FZ	●

NEW Quick-Release Grease Coupler

The Flexzilla™ Quick-Release Grease Coupler features a patented, innovative design which enables quick and easy connections to grease fittings, even in tight spaces. The Quick-Release Grease Coupler features a spring latch for positive engagement and allows for one-handed operation. When the fitting becomes pressurized, depress the thumb lever and release the coupler. No more stuck on couplers and broken grease fittings. Plus, the Quick-Release Grease Coupler eliminates grease spurts when disconnecting, keeping your workspace clean.

FEATURES:

- 6-Jaw Coupler with high strength steel jaws provide improved clamping force on the zerk
- Releases easily under high pressure
- Spring latch for positive engagement
- Ergonomic thumb lever provides effortless one-handed coupling and uncoupling, even under pressure - no more struggling when removing coupler
- Compact design is ideal for use in tight spaces, 2.9 in. long by 1.2 in. tall
- Compatible with all sizes and forms of mounts, fits all SAE and metric zerk fittings
- For use with most manual, battery and air operated grease guns and pumps
- Patented design



*Grease hose not included

Part No.	FNPT Fitting	Retail Packaging
L2050FZ	1/8 in.	●

Grease Hoses

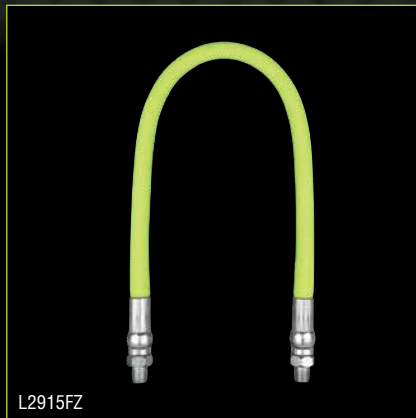

L2915FZ



L2915FZSP



L2915FZSP

Flexzilla™ Grease Hoses are more flexible than traditional rubber or thermoplastic hoses and stay flexible, even in subzero temperatures.

FEATURES:

- Extreme cold-weather flexibility
- 10,000 psi working pressure
- For use with manual, battery or air operated grease guns
- Coupler sold separately

Part No.	Description	Hose I.D.	Hose Length	MNPT Fitting	Spring Guard	Retail Packaging
L2910FZ	Flexzilla® 12 in. Grease Hose	3/16 in.	12 in.	1/8 in.	–	●
L2910FZSP	Flexzilla® 12 in. Grease Hose w/ Spring Guard	3/16 in.	12 in.	1/8 in.	Yes	●
L2915FZ	Flexzilla® 18 in. Grease Hose	3/16 in.	18 in.	1/8 in.	–	●
L2915FZSP	Flexzilla® 18 in. Grease Hose w/ Spring Guard	3/16 in.	18 in.	1/8 in.	Yes	●
L2925FZ	Flexzilla® 36 in. Grease Hose	3/16 in.	36 in.	1/8 in.	–	●
L2925FZSP	Flexzilla® 36 in. Grease Hose w/ Spring Guard	3/16 in.	36 in.	1/8 in.	Yes	●
L2930FZSP	Flexzilla® 42 in. Grease Hose w/ Spring Guard	3/16 in.	42 in.	1/8 in.	Yes	●
L2950FZ	Flexzilla® 12 in. Grease Hose	1/8 in.	12 in.	1/8 in.	–	●
L2950FZSP	Flexzilla® 12 in. Grease Hose w/ Spring Guard	1/8 in.	12 in.	1/8 in.	Yes	●
L2955FZ	Flexzilla® 18 in. Grease Hose	1/8 in.	18 in.	1/8 in.	–	●
L2955FZSP	Flexzilla® 18 in. Grease Hose w/ Spring Guard	1/8 in.	18 in.	1/8 in.	Yes	●
L2965FZ	Flexzilla® 36 in. Grease Hose	1/8 in.	36 in.	1/8 in.	–	●
L2965FZSP	Flexzilla® 36 in. Grease Hose w/ Spring Guard	1/8 in.	36 in.	1/8 in.	Yes	●

PROTECTIVE EYEWEAR

ADJUSTABLE TEMPLES

Get the perfect fit with Flexzilla™ Pro models by adjusting the angle and length of the temples.



99.99% UV PROTECTION

Constructed for all-day wear featuring superior UV protection that shields your eyes from harmful ultraviolet light.

NEW Impact Resistant Protective Eyewear

Flexzilla™ Impact Resistant Protective Eyewear helps keep your focus on any project, whether at home or on the jobsite. Available in two eye-catching styles with clear or tinted lens, Flexzilla has you covered. Each pair of Flexzilla Protective Eyewear feature 99.99% UV protection, a flexible and soft temple, and soft nose bridge.

IDEAL PROMO ITEMS

EFZ01C & EFZ01S FEATURES:

- Black frames with black or clear lens
- For Indoor/Outdoor Use
- Meets ANSI Z87.1
- 99.99% UV protection
- Optically correct
- Flexible, soft temple
- Soft nose bridge
- Anti-scratch lens

EFZ02CP & EFZ02SP FEATURES:

- Black frames with black or clear lens
- For Indoor/Outdoor Use
- Adjustable temples
- Meets ANSI Z87.1
- 99.99% UV protection
- Optically correct
- Flexible, soft temple
- Soft nose bridge
- Hard coated lens
- Includes protective bag

FLEXZILLA PRO MODELS

ADJUSTABLE TEMPLES

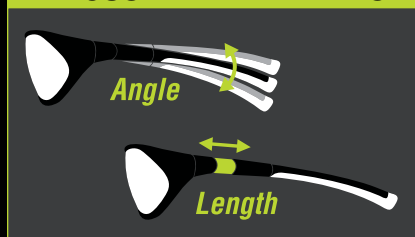

Part No.	Lenses	Retail Packaging
EFZ01C	Clear	●
EFZ01S	Tinted	●
EFZ02CP	Clear	●
EFZ02SP	Tinted	●



EFZ01C



EFZ02CP

PRO



EFZ01S



EFZ02SP

PRO



EFZ01S



EFZ02SP

PRO

PLAN-O-GRAMS

ONE-STOP SHOP

All the high-performance tools you need for that big project in one spot.

Water Hoses, Reels and Nozzles



Items Shown:

- Garden Hose Nozzles
- Garden Hose Nozzle Kits
- Pro Water Hose Nozzles
- Garden Lead-in Hoses
- Pressure Washer Hoses
- SwivelGrip™ Garden Hoses
- Garden Hoses
- Garden Hose Kits with Quick Connect Attachments
- Pro Water Hoses – Field Repairable
- Water Hose Reels

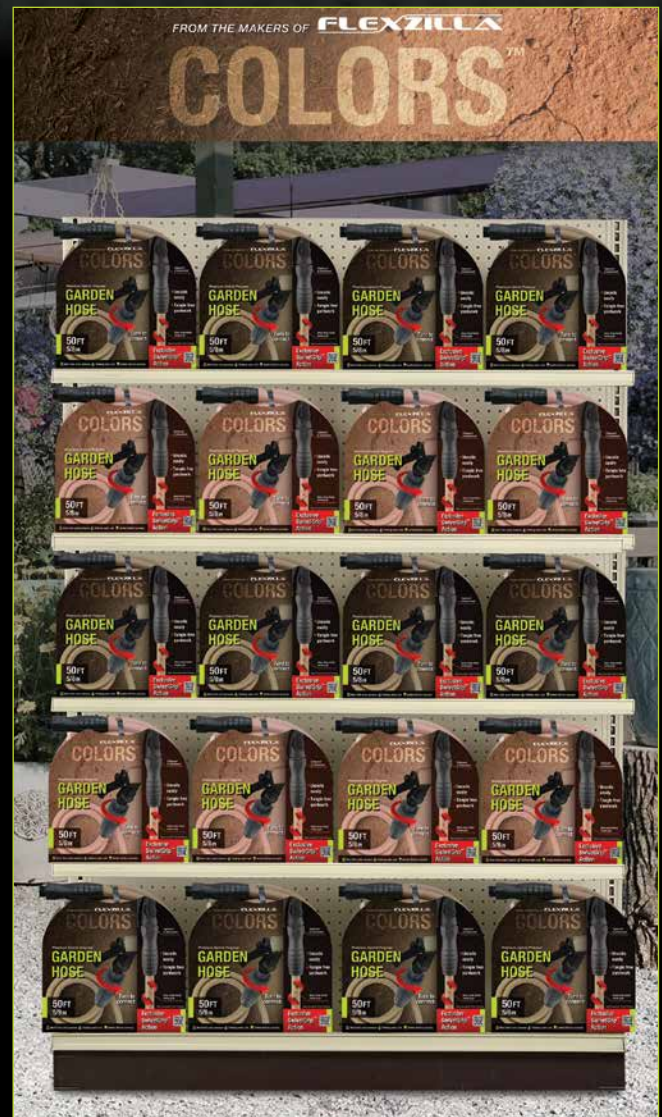

Items Shown:

- Colors™ SwivelGrip™ Garden Hoses
- Available in Colors:
 - Brown Mulch
 - Red Clay

Greasing Equipment, Blow Guns and Assorted Products



Items Shown:

- Grease Hoses
- Grease Guns – Lever Action
- Grease Guns – 20V Cordless Kit



Items Shown:

- Blow Guns and Kits
- Pro Extension Cords
- 11-Piece Air Hose Compressor Kits
- Truck Tire Inflator Kits
- Air Hose Reels with Levelwind™ Technology
- Extension Cord Reels

Air Tool Kits, Hoses and Assorted Products



Items Shown:

- Recoil Hoses
- Whip Hoses
- Tire Inflators
- Pro High Flow Couplers and Plugs
- Pro Reusable Fittings and Splicers
- Air Hoses
- Pro Air Hoses – Field Repairable
- Air Hose Reels
- Extension Cord Reels

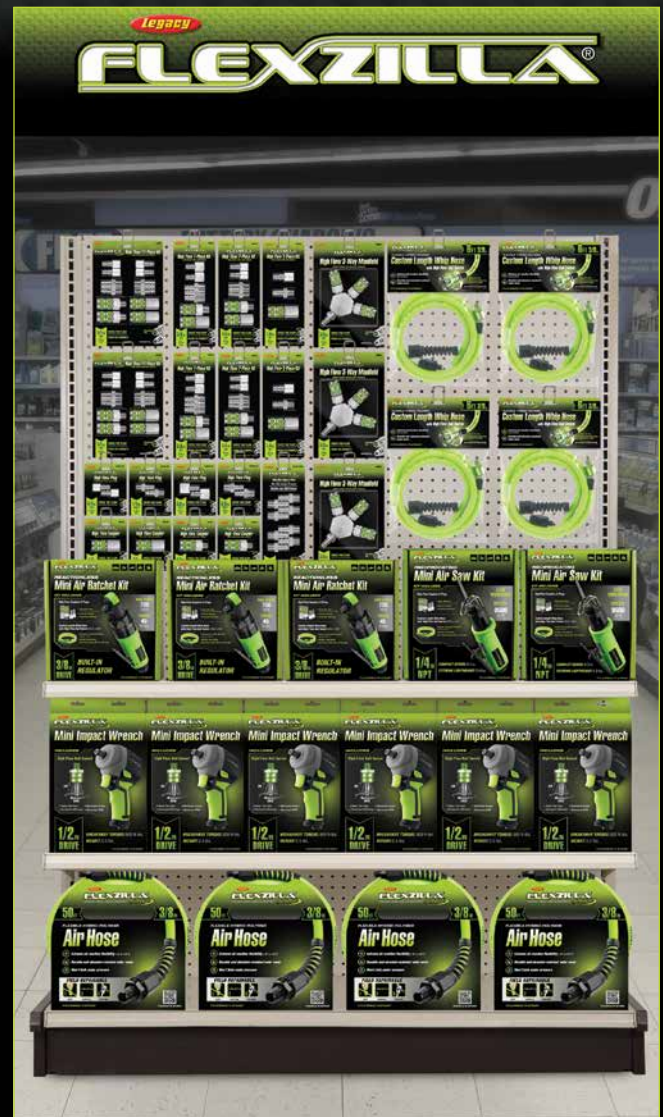

Items Shown:

- Pro High Flow Couplers and Plugs
- Pro Custom Length Whip Hoses
- Pro Reciprocating Mini Air Ratchet Kits
- Pro Reactionless Mini Air Saw Kits
- Pro Mini Impact Wrench
- Pro Air Hoses – Field Repairable

Hose Reel Display Rack, Reels, and Air Hoses

Items Shown:

- Gondola Mounted Hose Reel Display Rack (HR-20)
- Air Hoses
- Air Hose Reels

Gondola Mounted Hose Reel Display Rack:

Allows up to five Legacy or Flexzilla reels to be mounted for in-store display.

COMPATIBLE WITH 4 FT. LOZIER GONDOLA SHELVING

SIDE PROFILE

MEASUREMENTS:

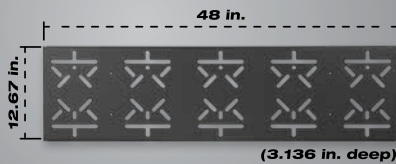

HR-20 FEATURES:

- Unique mounting patterns accommodate any Legacy or Flexzilla hose reel
- Interlocking tabs compatible with 4 ft. Lozier gondola shelving uprights
- Secondary mount holes for attaching to other structures



Custom Hose Centers

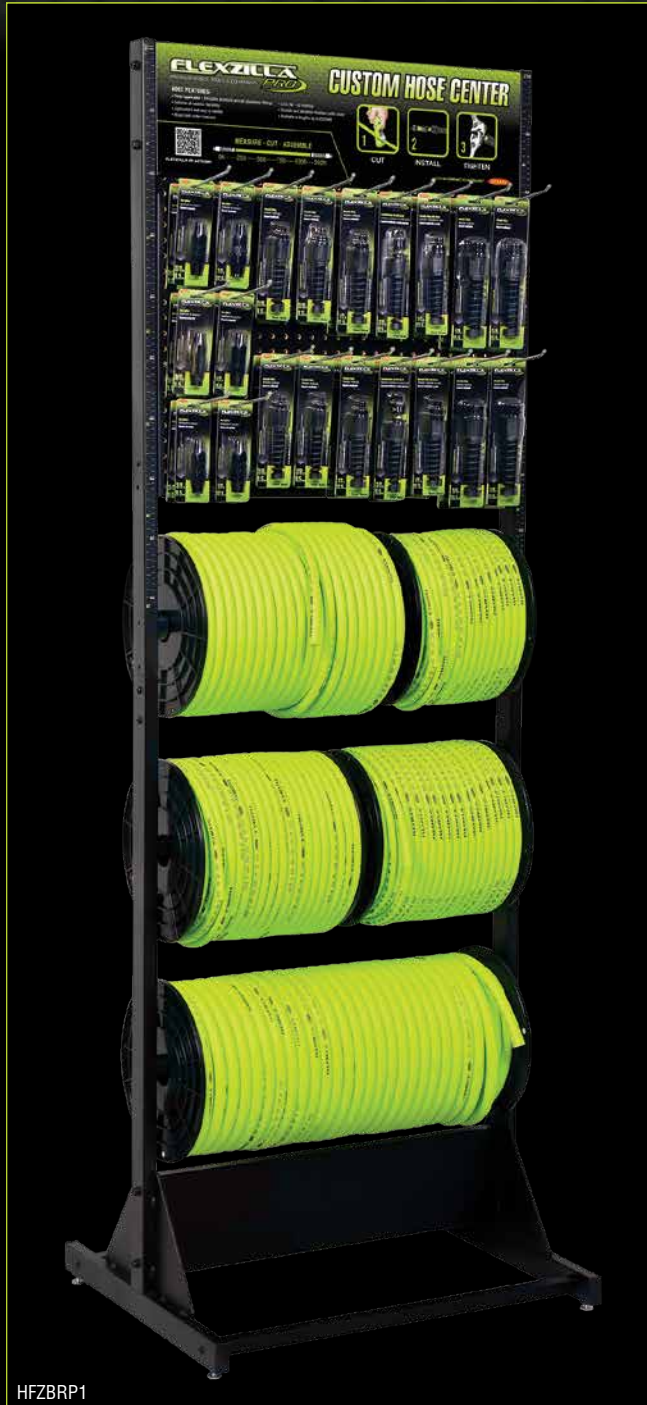

HFZBRP1

Items Shown:

- Reusable Fittings and Splicers
- Bulk Air Hose
- Bulk Water Hose



® Drinking water safe hose (Water Hose Only)



HFZBRP3

Items Shown:

- Reusable Fittings and Splicers
- Bulk Air Hose
- Bulk Water Hose

Custom Water Hose Centers



HFZWHC1

Items Shown:

- Reusable Water Fittings
- SwivelGrip™ Lead-in Hoses
- Bulk Water Hose



HFZCBRP3

Items Shown:

- Reusable Water Fittings
- SwivelGrip™ Lead-in Hoses
- Bulk Flexzilla® Water Hose, ZillaGreen™
- Bulk Colors® Water Hose, Brown Mulch
- Bulk Colors® Water Hose, Red Clay



Part No.	Pg.	Part No.	Pg.	Part No.	Pg.
A5	15	AG1006FZ	40	FXS07V080V1	9
A53416FZ	34	AG1012FZ	40	FXS07V080V3-208	9
A53416FZ-X	34	AG1016FZ-N	40	FXS07V080V3-230	9
A53426FZ	34	AG1090FZ	40	FXS10V080V1	9
A53426FZ-X	34	AG1091FZ	40	FXS10V080V3-208	9
A53430FZ-2PK	34	AG1092FZ	40	FXS10V080V3-230	9
A53430FZ-X	34	AG1093FZ	40	FXS10V120V1	9
A53440FZ-2PK	34	AG1099FZ	40	FXS10V120V3-208	9
A53440FZBS	34	AG1102FZ	39	FXS10V120V3-230	9
A53440FZBS-X	34	AG1200FZKIT	39	FZ512725	60
A53440FZ-X	34	AG1202FZ	39	FZ512730	60
A53452FZ	35	AG1402FZ	39	FZ512735	60
A53457FZ	35	AG1500FZKIT	39	FZ512825	60
A53458FZ	35	AG1502FZ	39	FZ512830	60
A53616FZ	34	AG934FZ	40	FZ512835	60
A53616FZ-X	34	AL2000FZ	46	FZ512930	60
A53626FZ	34	AL2025FZ-1	46	FZ512935	60
A53626FZ-X	34	AL2025FZ-2	46	FZ8140503	61
A53630FZ-2PK	34	AT1475FZ	42	HFZ1202YW3S	14
A53630FZ-X	34	AT8530FZ	44	HFZ1202YW4S	14
A53640FZ-2PK	34	AT8535FZ	43	HFZ1204YW3S	14
A53640FZ-X	34	AT8565FZ	43	HFZ1204YW4S	14
A53657FZ	35	DRAIN001A	10	HFZ1206YW3S	14
A55618FZ	37	EFZ01C	67	HFZ1206YW4S	14
A55628FZ	37	EFZ01S	67	HFZ1208YW3S	14
A55630FZ	37	EFZ02CP	67	HFZ12100YW3	12
A55640FZ	37	EFZ02SP	67	HFZ12100YW4	12
A55656FZ	37	FDRCF1150030	10	HFZ12250YW	18, 19
A55818FZ	37	FDRCF1150058	10	HFZ1225YW3	12
A55828FZ	37	FILTER057	10	HFZ1250YW3	12
A55830FZ	37	FILTER107KIT	10	HFZ1250YW4	12
A55840FZ	37	FILTERKIT011	10	HFZ1405YW2B	14
A55856FZ	37	FILTERKIT012	10	HFZ14100YW2	12
A86666FZ	35	FS05V08011	9	HFZ14100YW2-3X	12

INDEX

Part No.	Pg.
HFZ14100YW2-D	13
HFZ14250YW	18, 19
HFZ1425YW2	12
HFZ1425YW2-D	13
HFZ1450YW2	12
HFZ1450YW2-D	13
HFZ3802YW2B	14
HFZ3804YW2B	14
HFZ3806YW2B	14
HFZ38100YW2	12
HFZ38100YW2-D	13
HFZ38250YW	18, 19
HFZ3825YW2	12
HFZ3825YW2-5X	12
HFZ3825YW2-D	13
HFZ3835YW2	12
HFZ3835YW2-D	13
HFZ3850YW2	12
HFZ3850YW2-3X	12
HFZ3850YW2-D	13
HFZ3850YW3	12
HFZBRP1	17, 18, 73
HFZBRP3	17, 18, 73
HFZC550BRS	49
HFZC550TCS	49
HFZC58250BRS	56
HFZC58250TCS	56
HFZCBRP3	55, 56, 74
HFZCLB11D	14
HFZCLB11D-3X	14
HFZG12050QN	51
HFZG503YW	50
HFZG503YWS	48, 56
HFZG505YW	50

Part No.	Pg.
HFZG505YWS	48
HFZG5100YW	50
HFZG5100YW-36T	50
HFZG5100YWS	48
HFZG510YW	50
HFZG510YWS	48, 56
HFZG510YWS-6X	48
HFZG525YW	50
HFZG525YWS	48
HFZG550YW	50
HFZG550YW-48T	50
HFZG550YWS	48
HFZG550YWS-30X	48
HFZG550YWS-40X	48
HFZG575YW	50
HFZG575YW-48T	50
HFZG575YWS	48
HFZG6100YW	50
HFZG650YW	50
HFZG675YW	50
HFZGAK01	51
HFZGAK02	51
HFZP14100YW2	20
HFZP14100YW2-D	21
HFZP1425YW2	20
HFZP1425YW2-D	21
HFZP1450YW2	20
HFZP1450YW2-D	21
HFZP3806YW2B	21
HFZP38100YW2	20
HFZP38100YW2-D	21
HFZP3825YW2	20
HFZP3825YW2-D	21
HFZP3835YW2	20

Part No.	Pg.
HFZP3850YW2	20
HFZP3850YW2-D	21
HFZPW3425M	58
HFZPW3425M-5X	58
HFZPW3450M	58
HFZPW3450M-3X	58
HFZPW3525M	58
HFZPW3525M-5X	58
HFZPW3550M	58
HFZPW3550M-3X	58
HFZW58250YW	18, 19, 56
HFZWHC1	55, 56, 74
HFZWP5100	56
HFZWP550	56
HFZWP575	56
HGH2-FZ	46
HR-05	18, 56
HR-20	72
ISOLATORS001	10
L1355FZ	64
L1388LFZ	63
L1388LFZ-B	63
L1388LFZ-C	63
L2050FZ	64
L2910FZ	65
L2910FZSP	65
L2915FZ	65
L2915FZSP	65
L2925FZ	65
L2925FZSP	65
L2930FZSP	65
L2950FZ	65
L2950FZSP	65
L2955FZ	65

Part No.	Pg.	Part No.	Pg.
L2955FZSP	65	LP1420AFZ	15
L2965FZ	65	LP1425AFZ	15
L2965FZSP	65	MAINKIT008	10
L8011FZ	27	NFZG01-N	56
L8011FZLI	31	NFZG02-N	56
L8041FZ	27	NFZG61	52
L8041FZLI	31	NFZG61-12X	52, 53
L8230FZ	24	NFZG61-8X	52, 53
L8250FZ	24	NFZG62	52
L8250FZLI	31	NFZG62-12X	52, 53
L8300-B	23, 57	NFZG63	52
L8300-W	23, 57	NFZG63-12X	52, 53
L8305FZ	23	NFZG64	52
L8305FZLI	31	NFZG64-12X	52, 53
L8306FZ	23	NFZG64-8X	52, 53
L8335FZ	23	OILFZ004	10
L8335FZLI	31	RP900250	18, 19
L8340FZ	57	RP900250BS	18, 19
L8340FZLI	57	RP900250S	19
L8550FZ	28	RP900375	18, 19
L8560FZ	28	RP900375BS	18, 19
L8603FZ	25	RP900375S	19
L8611FZ	25	RP900500	18, 19
L8611FZLI	31	RP900500S	18, 19
L8650FZ	29	RP900625F	18, 19, 56
L8651FZ	30	RP900625M	18, 19, 56
L8651FZLI	31	RP901250	18, 19
L8652FZ	29	RP901375	18, 19
L8654FZ	30	RP901500	18, 19
L8654FZLI	31		
L8711FZ	26		
L8741FZ	26		
LP1410AFZ	15		
LP1415AFZ	15		

- ✓ Air Compressors
- ✓ Air Hoses
- ✓ Air Line Accessories
- ✓ Extension Cords
- ✓ Greasing Equipment
- ✓ Modular Blow Guns & Accessories
- ✓ Reels
- ✓ Protective Eyewear
- ✓ Tire Maintenance
- ✓ Water Hoses
- ✓ Work Gloves



FLEXZILLA®

PREMIUM HOSES, TOOLS & EQUIPMENT



If you're looking for quality air compressors, visit our website.