

**Fowler**



DIAL GAUGE **E**



**INSTRUCTIONS**

**Installing and replacing the battery (or  
Power cable)**



No. 0  No. 0 (0,4x2,5mm) 



**Battery** : lithium 3V, type CR2032

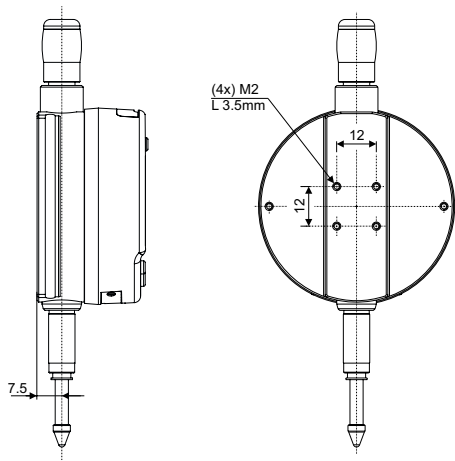

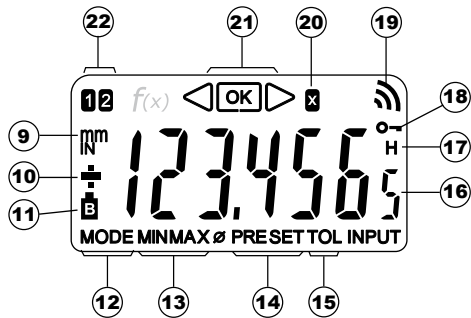
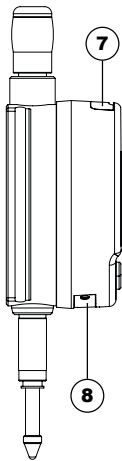
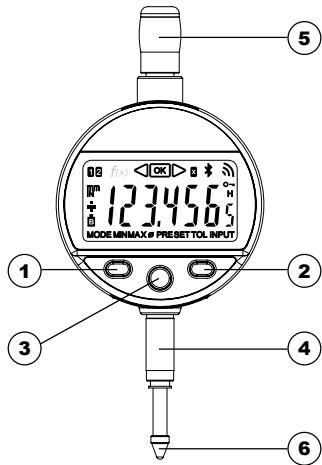

**Diagram for rear fixings**



## Description

1. MODE button
2. SET button
3. "Favourite" button
4. Clamping shaft  $\varnothing 8$  or  $3/8$ "
5. Lifting cap
6. Contact point  $\varnothing 2/M2.5$  or 4-48-UNF
7. Slot for Proximity cable
8. Slot for battery or Power Cable
9. Measurement units (mm/INCH)
10. +/- Indicator
11. Low battery
12. Mode menu display
13. MIN/MAX/DELTA mode
14. Preset mode
15. Tolerance mode
16. 6-digit display
17. Hold measured value
18. Button lock
19. Send data
20. Multiplication factor
21. Tolerance indicators
22. Active reference

## 1 . Operating features of the instrument

-  The instrument has two operating modes: basic functions (direct access) and advanced functions. In addition to the configuration functions, 2 working reference functions can be accessed, in MIN, MAX and DELTA (TIR) mode, plus tolerance display or input of multiplication factor other than 1:1 (see chaps. 3 and 4)
-  The «favourite» key gives direct access to the function used most often (see chap. 6)
-  Sets a Preset value, reset the MIN/MAX mode, verifies a selection, and controls switching off the instrument. By default, SIS mode enables automatic switch-off with no loss of origin (see chap. 7)

### - Personalising the functions

It is possible to activate or de-activate certain functions of the instrument via RS232 (see chap. 9)

### - Data transmission parameters

4800Bds, 7 bits, even parity, 2 stop bits

## 2. Start

Press a button.

### 3. Basic functions

Each short press on **MODE** gives direct access to the basic functions:

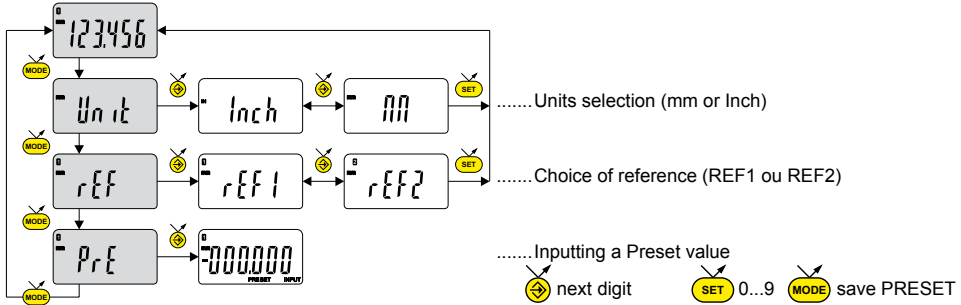

**Note:** It is possible to assign a different preset value to each of the 2 References. Similarly, different tolerance limits can be assigned to References 1 and 2.

## 4. Advanced functions

Prolonged pressure (>2s) on **MODE** gives access to the advanced functions. Then, each short press on **MODE** accesses the required function:

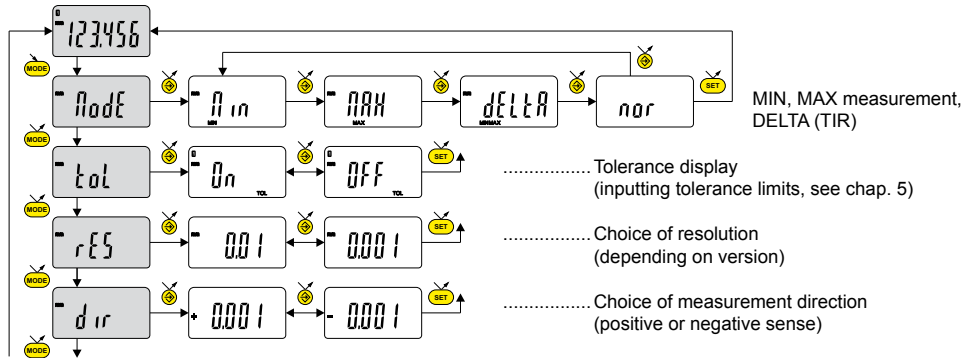





## 5. Inputting tolerance limits

To input or modify the tolerance limits,  $t_{ol}$  →  $0_n$  mode should be selected, followed by a short press on **MODE** :

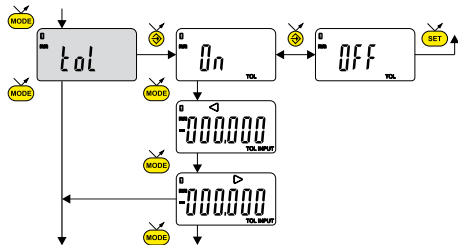

..... Input the lower tolerance limit ◀

..... Input the upper tolerance limit ▶

◀ next digit

SET 0...9

▶ save PRESET



### Note :

- For measuring internal dimensions, the red and yellow indicators can be switched over by reversing the order in which the tolerance limits are input (lower limit > upper limit).
- It is possible to input different tolerances on REF1 and REF2.

## 6. Favourite key

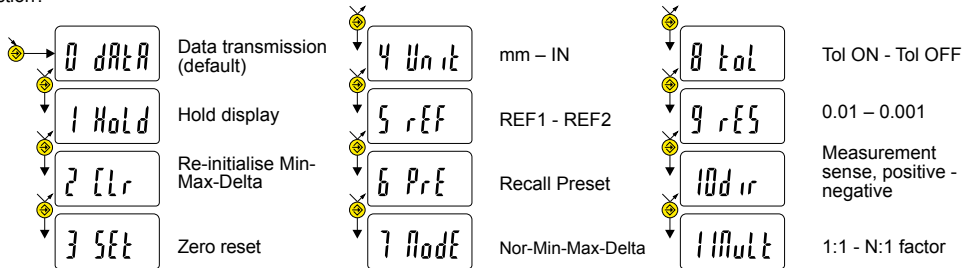
The «favourite» key gives direct access to a predefined function, and can be configured according to the needs of the user. In order to assign a function to the «favourite» key, give a prolonged press on , and then select the required function:



Validation of selection: By a prolonged press on  or a short press on  or 

**Note:** a function can also be assigned via RS232 using the command <FCT + Function No.>  
example: Change of Unit = <FCT4>

## 7. Switching off

The dial gauge goes automatically into stand-by if not used for 20 minutes, unless Auto OFF mode has been turned off (see Chap. 4, advanced functions)

Stand-by mode can be forced by a prolonged press (> 2 sec) on  :

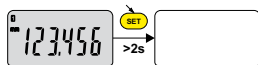



In stand-by mode, the value of the origin is retained by the sensor (SIS mode), and the instrument automatically restarts with any movement of the measurement probe, RS command or press a button.

The instrument can be switched off completely for a long period of non-use, but this will necessitate a zero reset on restart (the origin will be lost):



## 8. Re-initialising the instrument

The initial instrument settings can be restored at any time by a prolonged press (>4 sec) simultaneously on  and  until the message `rESt` is displayed.

Nevertheless the instrument retains its configuration settings (units and resolution), as well as the last active reference.

## 9. Personalising the instrument

Access to the functions of your instrument can be personalised, for more information see manufacturer's website (requires you to connect your instrument via a Proximity or Power RS / USB cable).

Possibilities:

- De-activate or active the required functions
- Modify access to the advanced functions (direct access)

## 10. Connecting the instrument

The instrument can be connected to a peripheral via a Proximity (RS or USB), Power (RS or USB). See page 2 for connecting the Power cable.

Measured values can be transmitted and the instrument driven using predefined commands (see chap. 11 for a list of the main retro-commands)

### **Note:**

In Tolerance mode, the tolerance limit lights remain lit only for a few seconds while the measurement stabilises. On the other hand, they will remain lit continuously if the instrument is connected to, and powered by, the Power RS (USB) cable.

## 11. List of the main commands

### Selection and configuration

CHA+ / CHA-	Change measurement direction
FCT0 ...9...A...F	Assign «favourite» function
MM / IN	Change measurement unit
KEY0 / KEY1	Lock / unlock keypad
MUL [+/-]xxx.xxxx	Modify multiplication factor
PRE [+/-]xxx.xxx	Modify preset value
REF1 / REF2	Change active reference
STO1 / STO0	Activate / de-activate HOLD
TOL1 / TOL0	Activate / de-activate tolerances
LCAL dd.mm.yy	Modify last calibration date
NCAL dd.mm.yy	Modify next calibration date
TOL +/-xxx.xxx +/-yyy.yyy +/-zzz.zzz	Inputting nominal and current tolerance limits
MIN /MAX /DEL /NOR	Selecting MIN, MAX, Delta, Normal mode
CLE	Re-initialisation of MIN, MAX or Delta
UNI1 / UNIO	Activate / de-activate change of units
OUT1 /OUT0	Activate / de-activate contin. data transmission
PRE ON / PRE OFF	Activate / de-activate Preset function
PRE	Recall Preset
SET	Zero reset
RES2 / RES3	Change of resolution

### Interrogation

CHA?	Measurement sense?
FCT?	«favourite» function active?
UNI?	Measurement unit active?
KEY?	Keypad locked?
MUL?	Multiplication factor?
PRE?	Preset value?
REF?	Reference active?
STO?	Status of HOLD function?
TOL?	Current tolerance limit values?
LCAL?	Date of last calibration?
NCAL?	Date of next calibration?
?	Current value (mode Tol, value followed by <=>)
MOD?	Active mode (MIN, MAX, Delta or Normal)?
SET?	Main instrument parameters?
ID?	Instrument identification code?
<b>Maintenance functions</b>	
BAT?	Battery status (BAT1 = OK, BAT0 = low battery)
OFF	Switch-off (wake up using a button or RS)
RST	Re-initialisation of the instrument
SBY	Put instrument in stand-by (SIS)
VER?	Version No. and date of firmware

## 12. Specifications

Measurement range :	12.5mm	25mm	50mm	100mm	150mm	
Max error (0.01mm scale):	10 $\mu$ m	10 $\mu$ m	20 $\mu$ m	20 $\mu$ m	20 $\mu$ m	( $\pm$ 1 digit)
Max error (0.001mm scale):	3 $\mu$ m	4 $\mu$ m	5 $\mu$ m	6 $\mu$ m	10 $\mu$ m	
Repeatability:	2 $\mu$ m					
Weight:	119g	123g	161g	208g	265g	
Measurement force (standard):	0.65-0.9N	0.65-1.15N	1.25-2.7N	1.6-3.5N	2.2-5.7N	
Max. speed of travel:	1.7m/s					
No. of measurements/ sec:	measurement: 10 mes/s      MIN/MAX mode: 20 mes/s					
Measurement unit:	metric/english (Inch)					
Maximum Preset (0.01mm scale):	$\pm$ 9999.99 mm / $\pm$ 399.9995 IN					
Maximum Preset (0.001mm scale):	$\pm$ 999.999 mm / $\pm$ 39.99995 IN					
Measurement system:	Sylvac inductive system (patented)					
Power:	1 x 3V lithium battery, type CR2032, 220mAh					
Average consumption:	75 $\mu$ A					
Average battery life:	8'000 hours					
Data output:	RS232 compatible					
Working temperature (storage):	+5 to +40°C (-10 to +60°C)					
Electromagnetic compatibility:	as per EN 61326-1					
IP rating (in accordance with IEC60529):	IP 51 / IP 67 (depending on model)					
Fixing and space envelope:	$\varnothing$ 8h6 (3/8"), interchangeable M2.5 (4-48-UNF) probe (as per DIN 878)					

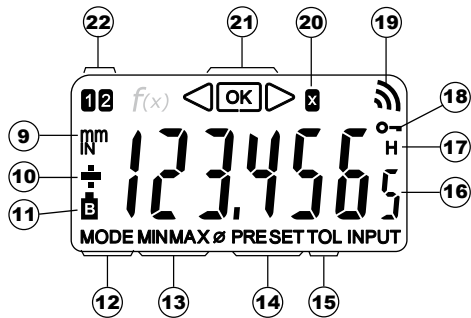
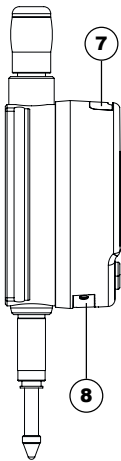
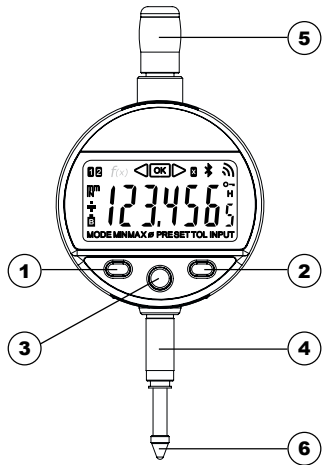
**F**

Learn more about diagnostic and testing tools we have.