

4

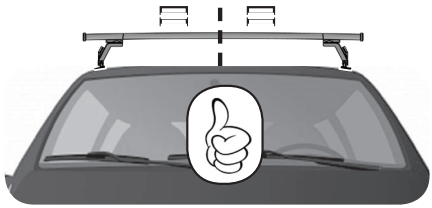

5

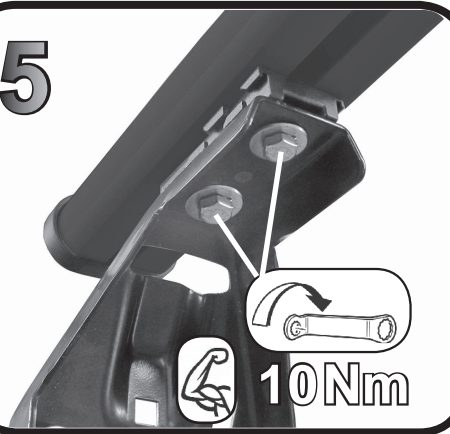

6

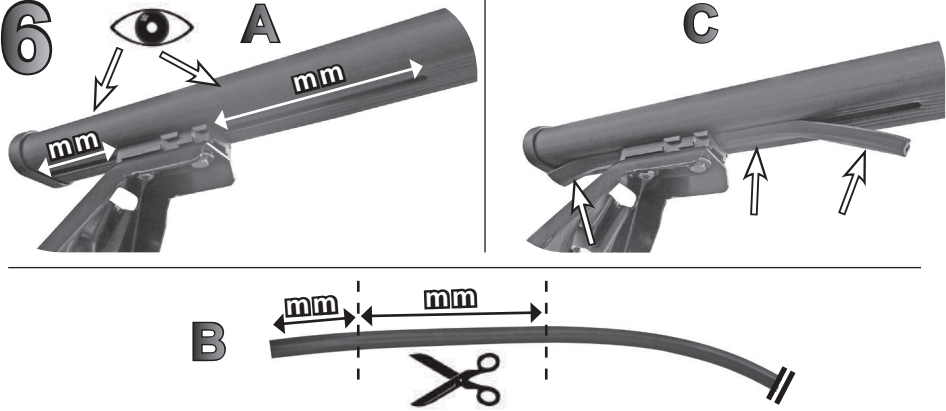

7

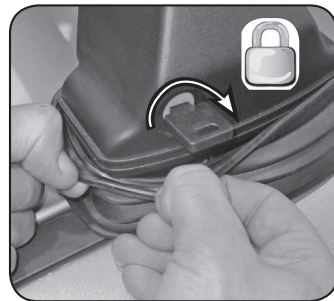
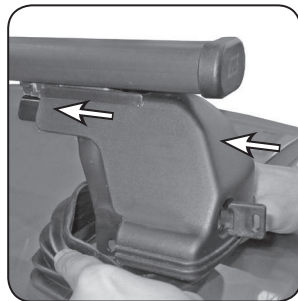



68.007



FITTING INSTRUCTION
"Steel"

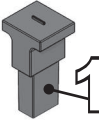

1

		
MERCEDES Classe C 5P (07-12)		•
MERCEDES Classe C 5P (2013>)	•	
MERCEDES Classe C Coupé 2P (2011>)	•	
MERCEDES CLS 4P (2010>)	•	
MERCEDES Classe E 4P (2009>)	•	
MERCEDES Classe E Coupé 2P (2009>)	•	
MERCEDES CLS 5P Shooting Brake (2012>)	•	
TOYOTA Avensis Wagon 5P (2009>)		•

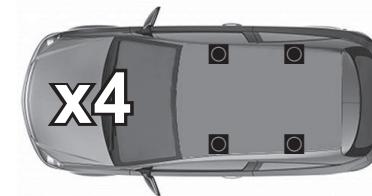
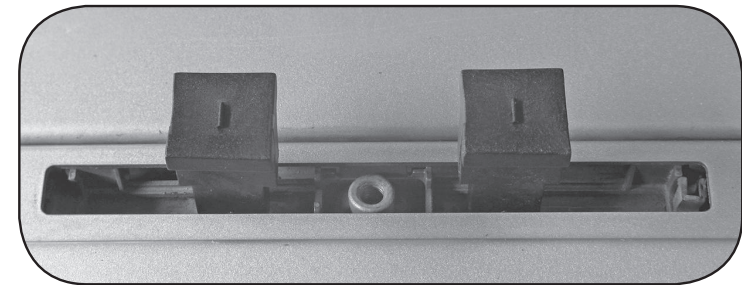

2

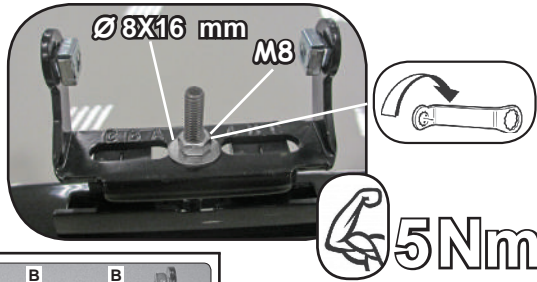
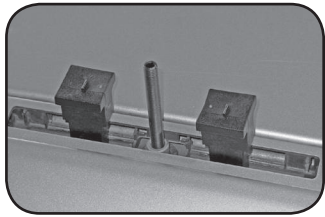

5Nm

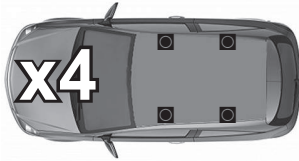
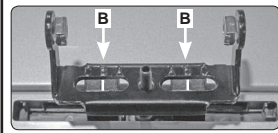

MERCEDES Classe C 5P (07-12)

MERCEDES Classe C 5P (2013>)

MERCEDES Classe C Coupé 2P (2011>)

MERCEDES CLS 4P (2010>)

MERCEDES Classe E 4P (2009>)

MERCEDES Classe E Coupé 2P (2009>)

MERCEDES CLS 5P Shooting Brake (2012>)

•

•

•

•

•

•

•

•

2 Bis



TOYOTA Avensis Wagon 5P (2009>)

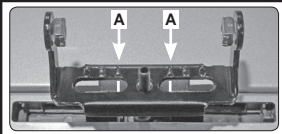

•

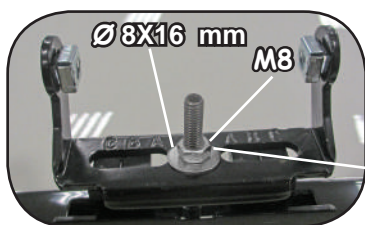
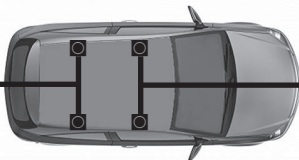
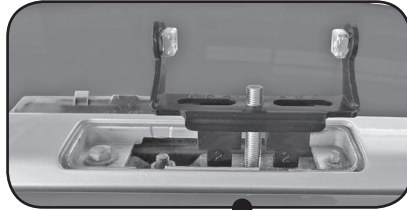
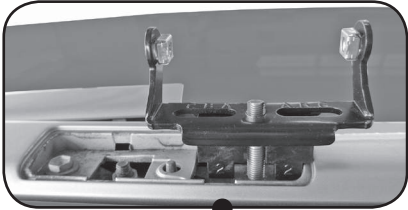

5Nm

3

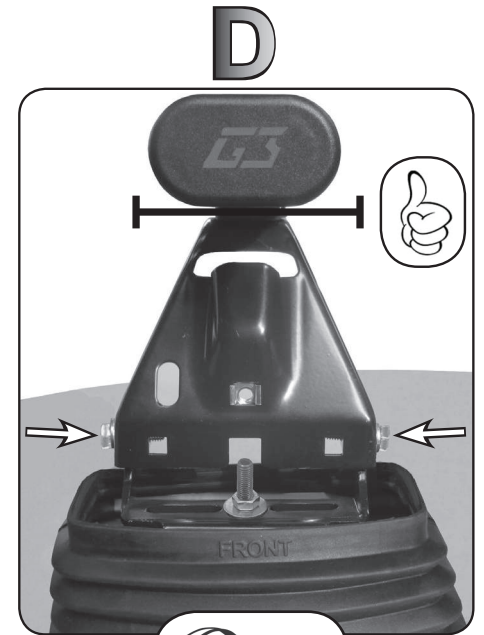
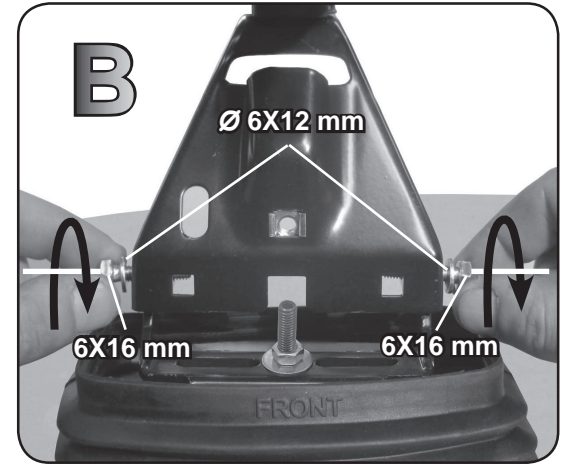
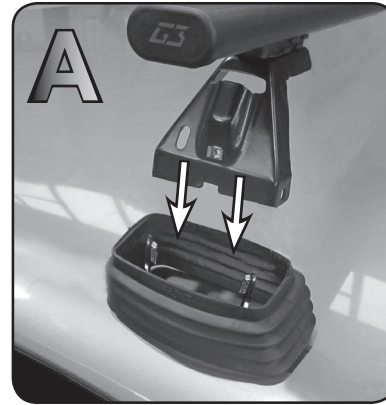

10Nm

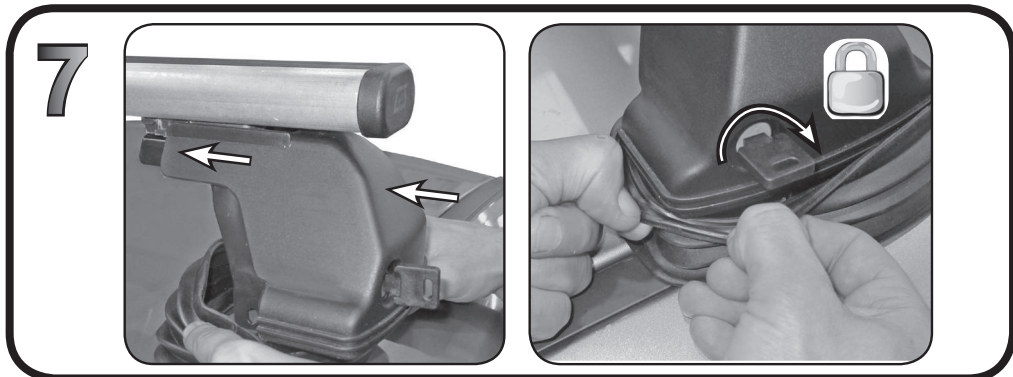
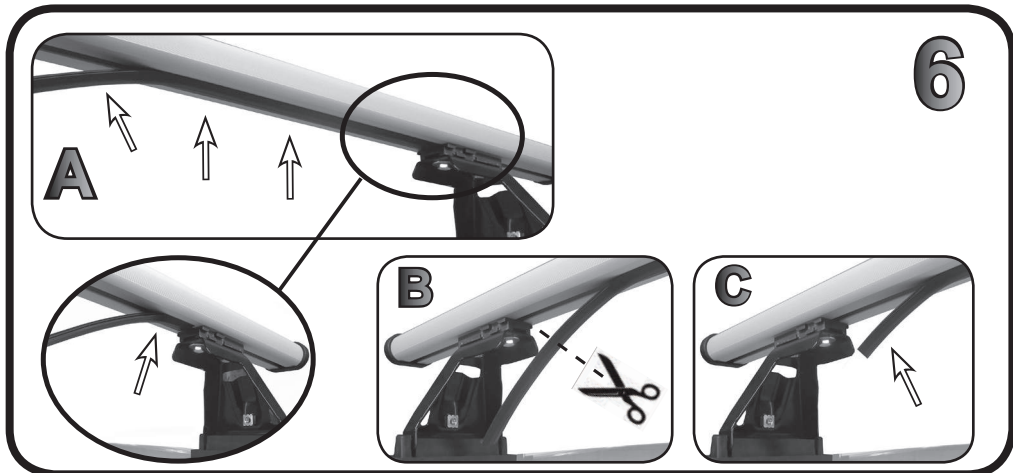
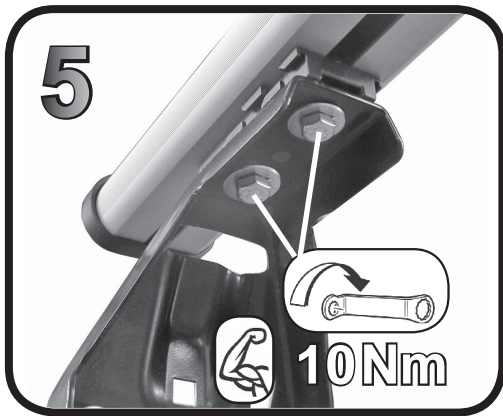
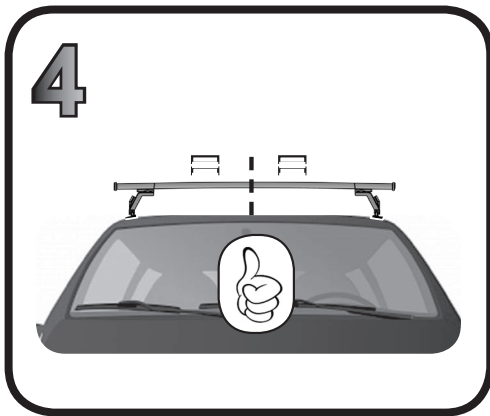

68.007



FITTING INSTRUCTION
"Aluminium"



1

MERCEDES Classe C 5P (07-12)		.
MERCEDES Classe C 5P (2013>)	.	
MERCEDES Classe C Coupè 2P (2011>)	.	
MERCEDES CLS 4P (2010>)	.	
MERCEDES Classe E 4P (2009>)	.	
MERCEDES Classe E Coupè 2P (2009>)	.	
MERCEDES CLS 5P Shooting Brake (2012>)	.	
TOYOTA Avensis Wagon 5P (2009>)		.

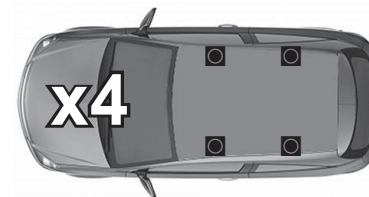
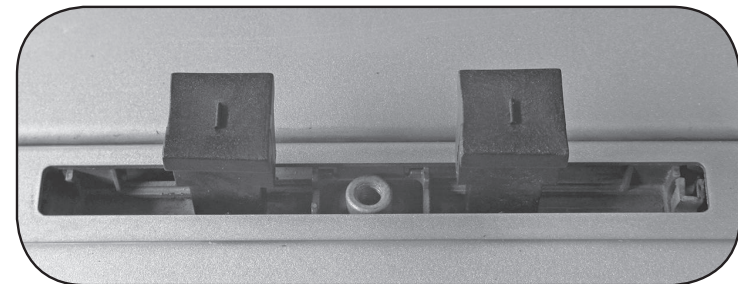

2

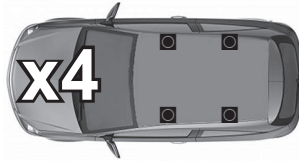
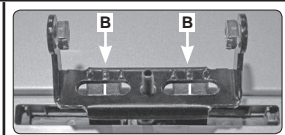
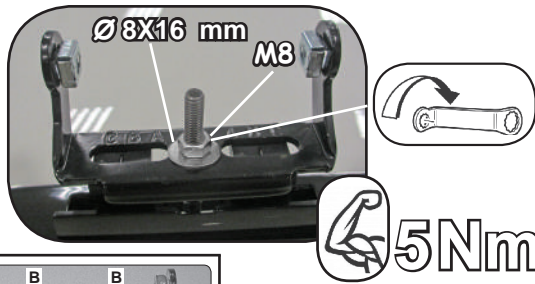
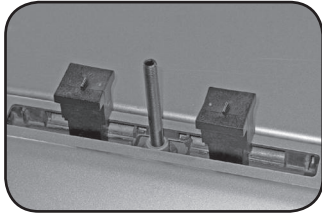

MERCEDES Classe C 5P (07-12)	•
MERCEDES Classe C 5P (2013>)	•
MERCEDES Classe C Coupé 2P (2011>)	•
MERCEDES CLS 4P (2010>)	•
MERCEDES Classe E 4P (2009>)	•
MERCEDES Classe E Coupé 2P (2009>)	•
MERCEDES CLS 5P Shooting Brake (2012>)	•

2 Bis

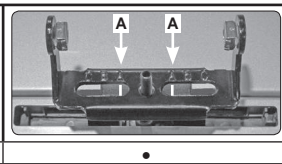

TOYOTA Avensis Wagon 5P (2009>)

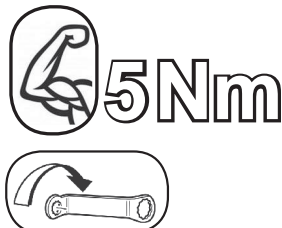
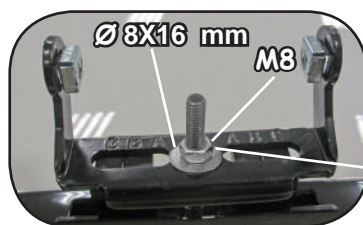
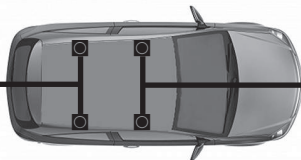
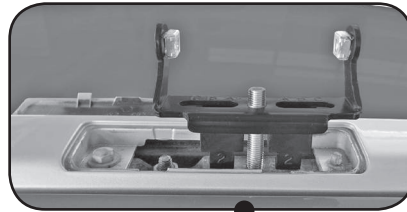
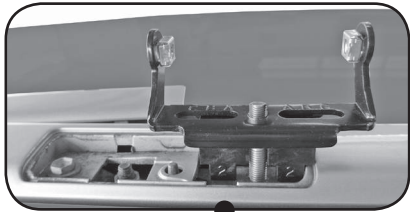

3

