

***OEM & Aftermarket
Catalog***



GLOBETECH
MANUFACTURING



BETTER PARTS! BETTER PRICES!

Trailer Parts & Accessories	Page	Electrical Products	Page	Air Products	Page
Document Holders	2, 3	ABS Cables	55	Nylon Air Hose Tubing	96
Louvered Vents	4	Non ABS Cables	56-57	Nylon Air Hose D.O.T. Brass Hardware	97
Manifest Box	4	Plugs	58	Quick Connect Push-In Hardware	98
Placard Holders	5-6	Sockets	59	Swivel Kits	99
Conspicuity Tape	7	Connectors	60	Drain Valve	99
Door Hardware	8-15	Junction Box	60	Nylon Tube Cutter	99
Corner Irons	14	Adapters	61	Clamping Studs	100
Corner Cap	14	Protector Boots	61	Crimping Hose Ends	100
Tire Carrier	14	Rubber Cushion Clamps	62	Slide Bars	101
Safety Bumper Tube	15	Wire Clip	62	Tender Kits	101
Registration Holders	16	Rubber Grommet	62	Suspender Springs	101
Grab Handles	17	Nosebox	63	Hose Separators & Holders	102
Door Hinges	18	Socketbreakers	63	Pogo Sticks	103
Mud Flaps & Accessories		Circuit Breaker	64	ABS Sensor Kits	104
Rubber Material Specification	20	Circuit Breaker	64	Slack Adjusters	105-113
Armor Guard Rubber Mud Flap	21	Ground Kits	64	Valves	114-125
Economy Chevron Rubber Mud Flap	22	Brush Kits	64	Gladhands	126-128
Standard Rubber Mud Flap	23	Copper Lugs	65	Gladhand Accessories	128-132
Xtreme Rubber Mud Flap	24	Poly Looms	65	Brake Shoe Hardware Kits	133
Heavy Duty Anti-Spray Rubber Mud Flaps	25	Rubber Tractor Lamps	66	Suspension	
Quick Change Anti-Spray Mud Flap	25	License Plate Light	66	Air Springs	134-146
Quick Mount Anti-Sail Mud Flap	26	Mini Lamps	66	Shock Absorbers	147-150
Raintrapper Mud Flap	26	Wheel End Products		King Pin Locks & Gladhand Locks	151-152
Raised Molded Rubber Mud Flap	27	Aluminum Alloy Hub Caps	67-69	Miscellaneous	
Raised Molded Rain Guard Mud Flap	27	Hubodometer Brackets	69	Coil Rack	153
Tireplast Mud Flap	28	Pro Par Style Hub Caps	70	Fifth Wheel Puller	153
Mid Guard Mud Flap	29	Window Kits & Plugs	71	Slick Disks	153
Side Skirt Mud Flap	29	Hub Cap Gaskets	72	Safety Flags & Banners	154-155
Colored Poly Mud Flap	29	Tempbolts	73	Triangle Kits	153
Silk-Screen Logo Rubber	30	Inner/Outer Wheel Hardware	74	Mirrors	157
Hot Stamp Logo Poly	31	Hub Cap Hardware	75	Chrome Stacks	158
Polyguard Standard	32	PSI Hub Caps	76	Clamps	159
Polyguard Plus Anti-Spray Mud Flap	32	Tire Inflation Hose	77	Lock Rod Assembly	160
Polyguard Plus HD Anti-Spray Mud Flap	32	Inner Tube	78	Cross-Reference Page	
Stock Logo Mud Flap	33	Tire Knocker	78 161-164	
Custom Logo Mud Flap Forms	34-35	Tire Repair Tool Kit	78	Index	
Wheel Chock	36	Tire Inflater Kit	79 165-173	
Trailer Bumpers	37-39	Tire Chucks/Tire Gauges	79	Notes	
Laminated Bumpers	40	Valve Stems	80 174-175	
Door Bumpers	40	Valve Stem Caps	81	Warranty	
Bar Type Mud Flap Hanger	41-42	Standard Bore Valve Tool	81 176	
Mounting Brackets for Hangers	43	Freeze Plugs	82		
Mud Flap Bolt Kits	44	Air Products			
Bulk Display Hangers	44	Spring Brakes	83-86		
Conspicuity Accessories	45	Diaphragms	87		
Spring Loaded Brackets	46-48	Chamber Clamps	87		
Quarter Fenders	49-50	Standard Air Coils	88-89		
Quarter Fender Hardware	51-53	Extreme Weather Air Coils	90		
Quick Reference Guide	54	Air-Electric 3 to 1 Combo	91		
		Bulk Rubber Air Hose	92		
		Rubber Air Brake Hose Assemblies	93		
		Rubber Air Hose D.O.T. Brass Hardware	94-95		



Document Holders



GT-1001

- UV-resistant Dow Corning CALIBRE polycarbonate lens
- EPDM rubber seal for weather proofing

Part Number	Description	Replaces Betts#
GT-1001	Plastic document holder outside: 6" x 5" x 1-2/3" inside: 4-1/4" dia, 1" depth	PS-1
GT-1001S	O-ring seal for GT-1001	BTL-820012
GT-1004	Replacement lens & seal kit	BTL-71P5



GT-1007

- UV-resistant Dow Corning CALIBRE polycarbonate lens
- Water resistant seal, retaining spring, locking design

Part Number	Description	Replaces Trucklite#
GT-1007	Twist lock document holder w/wire outside: 6" x 5" x 2-1/2" inside: 3-3/4" dia, 1" depth	97960
GT-1008	Replacement lens & seal kit	TL-97962



GT-1003

- EPDM rubber caps for UV-resistance
- Stainless steel cable eliminates loss of end caps
- Pre-drilled mounting brackets

Part Number	Description	Replaces Fleet Engineers#
GT-1003	Tube style document holder w/ rubber end caps, 9" length, 1-1/2" diameter, 4" bracket height	022-01190
GT-1005	Replacement cap For GT-1003	



GT-1006

- Stainless steel hardware
- Poron gasket

Part Number	Description	Replaces James King#
GT-1006	Security box, die cast outside: 7" x 5-1/4" x 2" Clipboard: 3-1/2" x 5-1/4"	Model 300
GT-1009	Replacement lid kit for GT-1006	



Document Holders

- High-tech plastic is unaffected by weather, chemicals, or corrosion
- Rainshield lid & water resistant seal
- Side clips prevent accidental opening

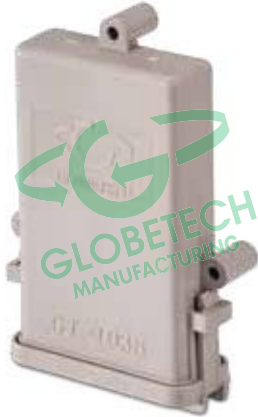

GT-1035

Part Number	Description	Replaces James King#
GT-1035	Xenoy document holder overall: 7" x 5-1/4" x 2" inside: 5" x 3-1/2" x 1"	Model 350
GT-1035B	Document holder, body only for GT-1035	—
GT-1035L	Replacement Lid Kit for GT-1035	—



GT-1050

- Holds papers and binders up to 10" x 14"
- Sliding lid with rainshield
- Internal document shelf

Part Number	Description	Replaces James King#
GT-1050	Large plastic record holder outside: 16" x 11-1/2" x 1-1/2" inside: 14" x 10" x 1-1/2"	Model 500
GT-1050L	Replacement Lid Kit for GT-1050	—



GT-1055

- Flip open lid features triple latch for secure close
- Interior clip & document shelf

Part Number	Description	Replaces James King#
GT-1055	Flip plastic record holder outside: 15" x 10" x 1-1/4" inside: 12-1/4" x 9-1/2" x 3/4"	Model 550
GT-1055L	Replacement Lid Kit for GT-1055	—



Louvered Vent

- Louvered Aluminum



GT-1105

Part Number	Description	Replaces Fleet Eng. #
GT-1105	Slide by vent	024-03000
GT-1105B	Slide by vent, black	—

Manifest Box

- Lightweight aluminum body, stainless steel hinge & latch
- Outside: 13" x 8" x 1-1/2"
- Inside: 11-1/2" x 6-1/2" x 1-1/4"
- Available with custom logo



GT-1002

Part Number	Description	Replaces Fleet Engineers#	Replaces James King#
GT-1002	Aluminum manifest box	022-01087	Model 200
GT-1002WHT	White manifest box	—	—



GT-04400035

- Pre-drilled to hold GT-1002 manifest box
- Powder coated finis

Part Number	Description	Replaces Wabash
GT-04400035	Aluminum pan for GT-1002	04400035



Placard Holders



GT-1100

• Louvered Aluminum



GT-1102

• Plastic



GT-1100A

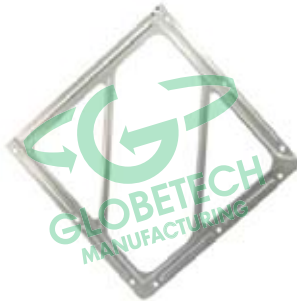

GT-1103

Part Number	Description	Replaces
GT-1100	Standard aluminum placard holder w/stainless clip & back plate	80SM-4CC Labelmaster
GT-1101	Standard placard holder, white w/stainless clip & back plate	-
GT-1102	Plastic placard holder	JJK2-TPH JJ Keller

Part Number	Description	Replaces Labelmaster#
GT-1100A	Aluminum placard holder, angle cut w/back plate	80SM-P
GT-1101A	White placard holder, angle cut W/back plate	-
GT-1103	Aluminum face	4-TPH
GT-1111	Stainless Steel clip	

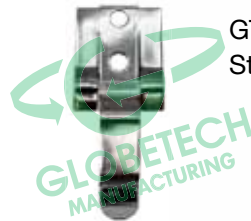

GT-1111

Stainless Steel replacement clip



GT-1150

GT-1150 (Aluminum) GT-1150W (White)	GT-1151(Aluminum) GT-1151W (White)
<ol style="list-style-type: none"> 1. Explosive 2. Flammable Gas 3. Corrosive 4. Dangerous 5. Flammable 6. Non-Flammable Gas 7. Oxidizer 8. Poison 9. Radioactive 10. Blank White 	<ol style="list-style-type: none"> 1. Corrosive 2. Flammable Gas 3. Radioactive 4. Flammable 5. Plain White 6. Dangerous 7. Oxidizer 8. Non-Flammable Gas 9. Poison
Replaces Labelmaster #81-10FO	Replaces Labelmaster #81-8FO



Placard Holder

GT-1108
Aluminum Placard Holder
Small 5x7

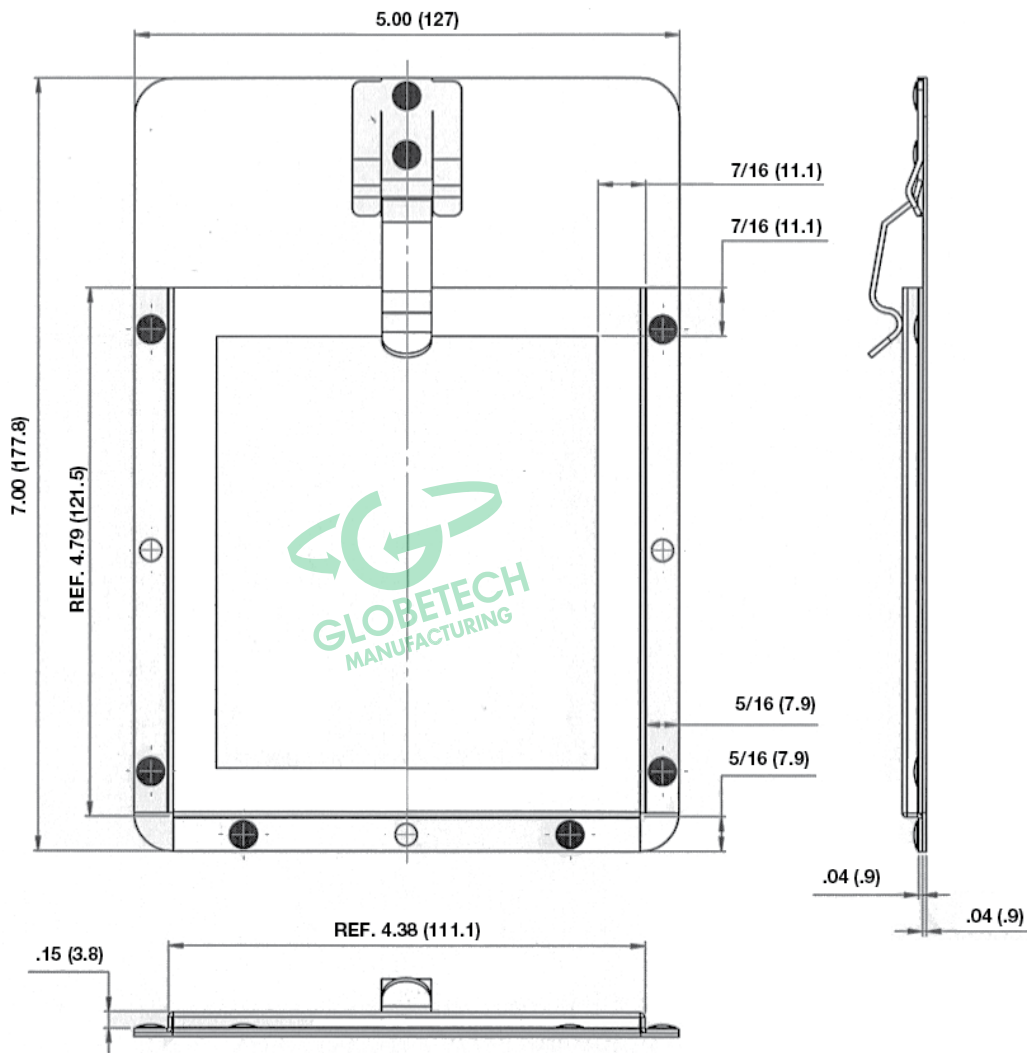
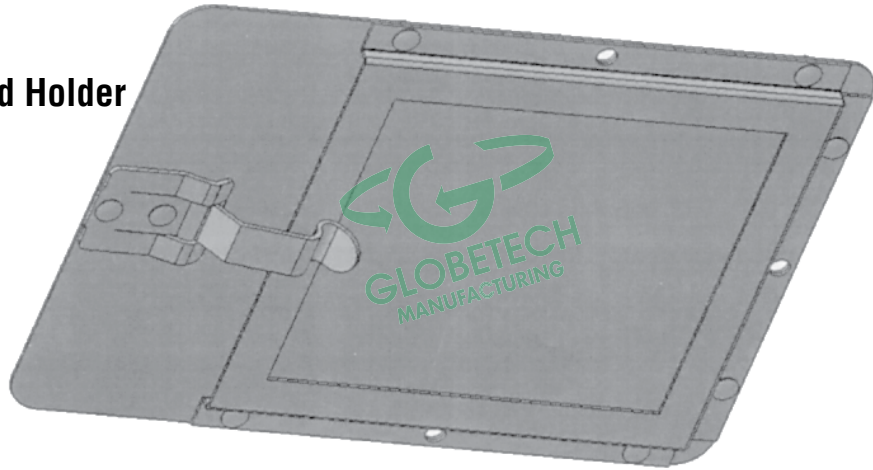



Conspicuity Tape Benefits

- DOT tape is certified and guaranteed to meet and exceed NHTSA requirements
- Durable – resists weather, dirt and aging
- Aggressive adhesive: DOT Specs
- Non – corroding
- Strong and durable for easy application to smooth surface
- New thin, flexible prismatic for smooth surface, and around rivets and corners



Color Plots

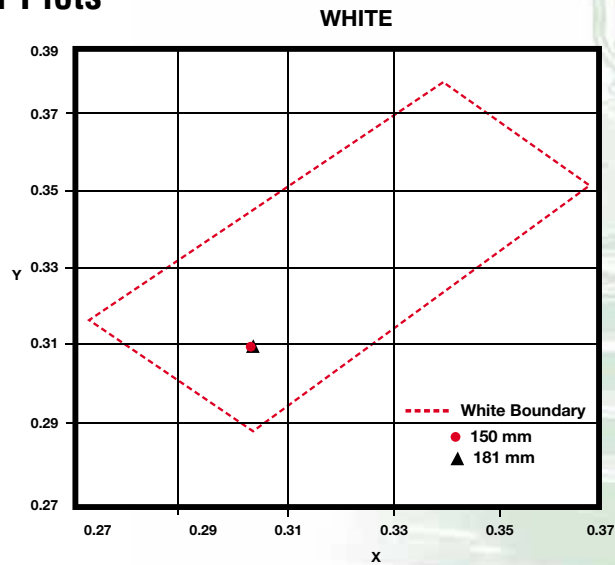
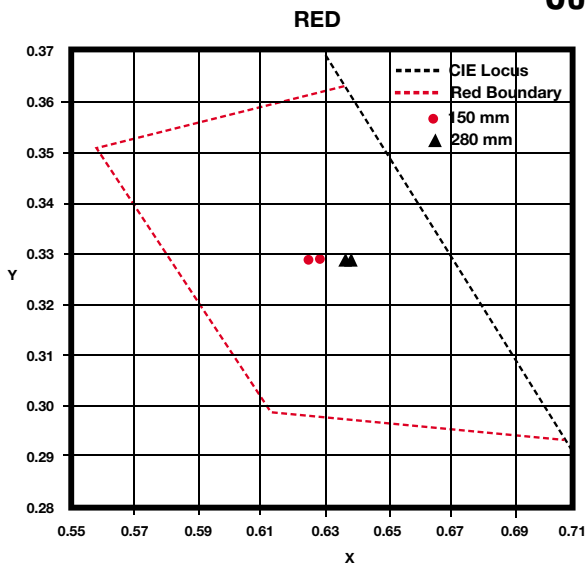

Part No.	Color	Width	Unit	Length	Quantity	Replaces 3M ID
GT-27003	Red & White	2 inch	6" Red x 6" White Roll	150 ft	1	75-0301-6343-2
GT-27004	Red & White	2 inch	11" Red x 7" White Roll	150 ft	1	75-0301-6340-8
GT-27005	White	2 inch	Roll	150 ft	1	75-0301-6345-7
GT-27006	Yellow	2 inch	Roll	150 ft	1	
GT-27007	Orange	2 inch	Roll	150 ft	1	



Holdbacks



Part Number	Description	Replaces Wabash #
GT-1301	Door holdback hook, galvanized mounting plate: 2" x 2-3/16" hook height: 2-1/4"	06300015



Part Number	Description	Replaces Wabash #	Replaces Fleet Engineers #
GT-1302	"T" type door holdback T bar length: 4", base: 1-3/4" x 3"	06300028	022-01022
GT-1326	"T" type door holdback T bar length: 6", base: 1-3/4" x 3"	-	022-01024



Part Number	Description	Replaces Wabash #
GT-1303	Stainless steel spring holdback width: 11-1/2", length: 20-1/2"	06300094



Part Number	Description	Replaces Wabash #
GT-1306	Holdback hook #XCD-0262-1, galvanized	06300119



Part Number	Description	Replaces Wabash #	Replaces Eberhard #
GT-1307	Door holdback post, galvanized mounting plate: 3-1/4" x 1-1/4" post length: 6-3/4"	06300693	6602-50



Part Number	Description	Replaces Wabash #	Replaces Eberhard #
GT-1312	Door holdback post, galvanized mounting plate: 1-1/4" x 3-3/16" post length: 4-11/32"	06301964	6603-50



Loops & Snaps

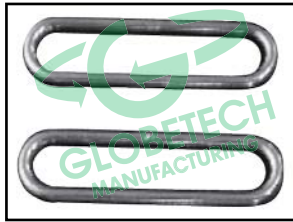

Part Number	Description	Replaces Wabash #	Replaces Eberhard #
GT-1313	4" chain loop	06302523	6601-3



Part Number	Description	Replaces Wabash #
GT-1314	Galvanized snap, 1/2"	06300058

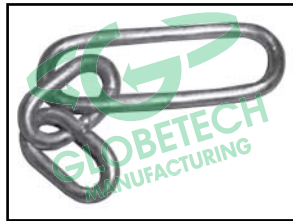

Part Number	Description	Replaces Wabash #
GT-1316	4" loop, galvanized, 2 small links	06300985

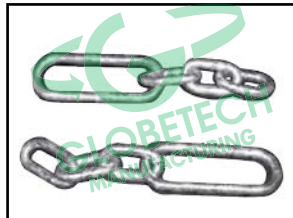

Part Number	Description	Replaces Wabash #
GT-1317	4" holdback loop, galvanized, 3 small links	06302613

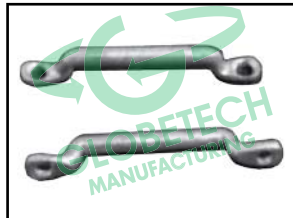

Part Number	Description	Replaces Wabash #	Replaces Fleet Engineers #
GT-1300	Footman loop, galvanized overall length: 3-1/2", C-C: 2-3/4"	A1300017	021-00043

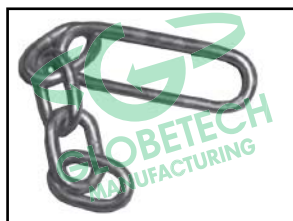

Part Number	Description	Replaces Wabash #	Replaces Eberhard #
GT-1305	Holdback loop, galvanized large link: 4", 4 small links	06300118	6608-1 (3" large link)



Door Sockets/Plunger



Part Number	Description	Replaces Wabash #	Replaces Fleet Engineers #
GT-1304	Loop attach link #DCC-07478-1 galvanized	06300117	021-00053



Part Number	Description	Replaces Wabash #	Replaces ORR #
GT-1308	Plunger, galvanized, 1-5/8"	06300805	H9013



Part Number	Description	Replaces Wabash #
GT-1315	Socket w/o rubber insert, galvanized	06300844



Part Number	Description	Replaces Wabash #	Replaces Eberhard #
GT-1309	Female rubber socket w/ steel insert	06301166	1-666-2 (female portion only)



Part Number	Description	Replaces Wabash #	Replaces Eberhard #
GT-1310	Male insert for GT-1309	06301167	1-666-2 (male portion only)



Part Number	Description	Replaces Wabash #
GT-1318	Rubber insert	06301217



Door Hardware



Part Number	Description	Replaces Fleet Engineers #
GT-1323	Door holdback, 6" loop used in post style holdback kits	022-01078



Part Number	Description	Replaces Fleet Engineers #
GT-1324	5" footman loop 5" overall length 4-1/4" C-C	022-00628



Part Number	Description	Replaces Fleet Engineers #
GT-1327	Holdback loop, Fruehauf style 8-1/2" overall length 2-1/4" x 2/3" base plate	022-00487



Part Number	Description	Replaces Wabash #	Replaces Fleet Engineers #
GT-1328	Door holdback w/3 chain links & HD snap	525461	021-00050



Part Number	Description	Replaces Todco
GT-1400	End hinge, T-style, zinc-plated, for roll up doors	69035



Part Number	Description	Replaces Todco
GT-1401	Center hinge, zinc-plated, for roll up doors	61196



Door Hardware

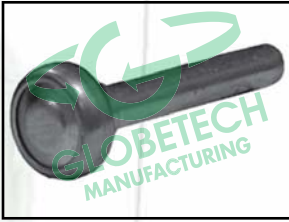

Part Number	Description	Replaces Todco#
GT-1402	1" steel roller	61174



Part Number	Description	Replaces Todco #
GT-1403	2" nylon roller	70225

Kit Replacements

Create kits similar to Fleet Engineer kits with standard Globetech components:



GT-1331



GT-1332



GT-1333

Globetech Kit	Globetech replacement part numbers for kit	Description	Replaces Fleet Engineers kit#
GT-1331	(1) GT-1300 and (1) GT-1328	Handle style anchor, chain, lap link & snap	021-00051
GT-1332	(1) GT-1324, (1) GT-1313 and (1) GT-1307	Handle, post holdback & 4" loop	021-00373
GT-1333	(1) GT-1324, (1) GT-1323 and (1) GT-1307	Handle, post holdback & 6" loop	021-00374



Wabash Style Holdback Oblong Loop and Chain Kit

GT-1329 Oblong Loop and Chain
Replaces WAB06302250

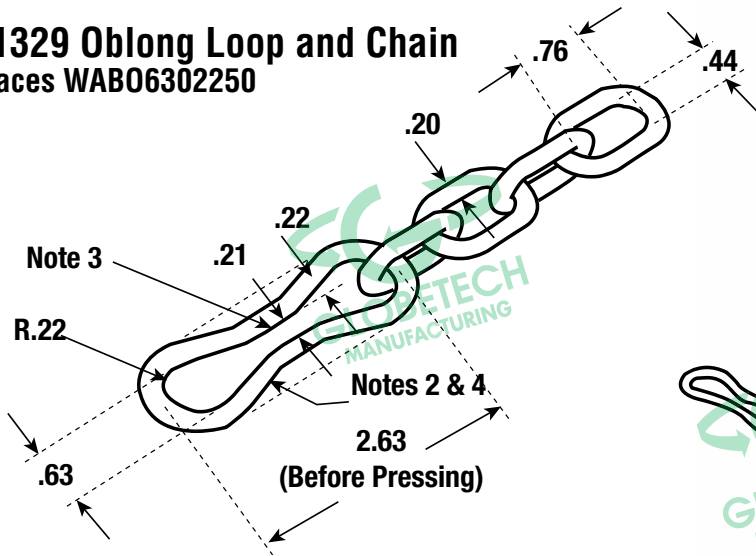

GT-1311 Hook
Replaces WAB06302200



Notes:

1. Four 4/0 Passing links-welded
2. Weld oblong link-grind so there is maximum .03 high flashing
3. Press in sides of oblong link to within .21 of each other
4. Oblong link weld should be free of cracking after pressing

GT-1334 Kit
Replaces WAB06302201



GT-1334 Kit Includes

- GT-1311 Hook
- GT-1329 Oblong Loop and Chain

GT-1336 Kit
Wabash Style Vent Door
Holdback Loop
Replaces WAB06303036

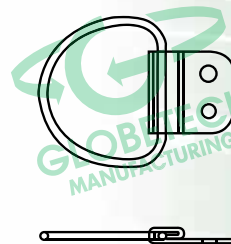



Corner Irons

High strength, drop forged steel construction

GT-1201 – OEM
GT-1202 – Aftermarket

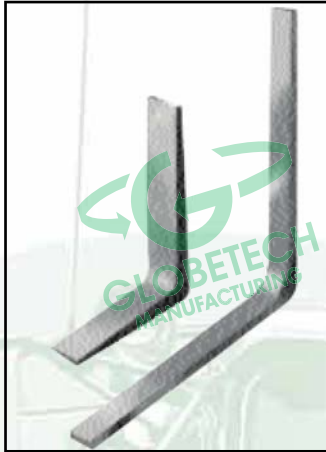

Part Number	Replaces	Size	Weight
GT-1201	B24878	8"x6"x1-1/2"	2.7lb
GT-1202	B2485aa	12"x12"x1-1/2"	4.5lb

GT-1200P-Corner Cap Freuhauf Style

Replaces:
Freuhauf - FruWC F9
Plastic nylon



GT-1270 Tire Carrier

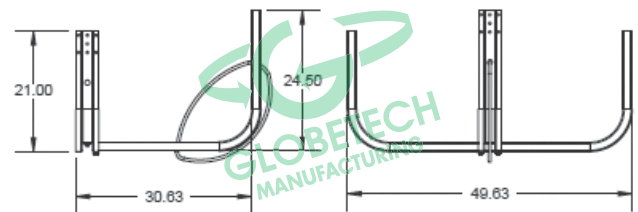
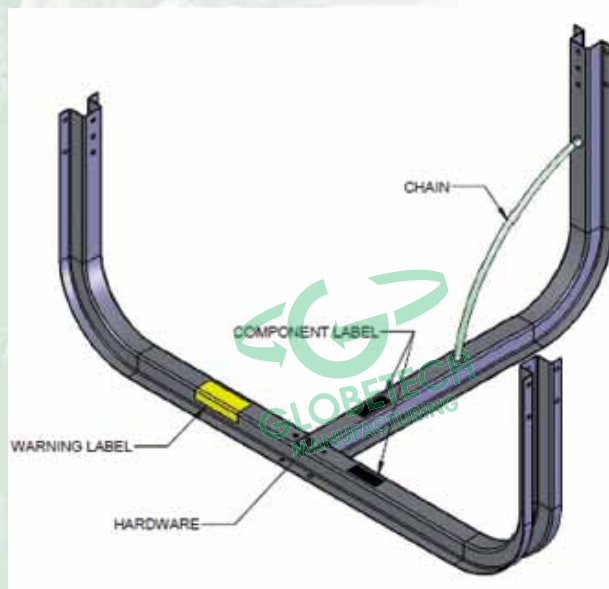



GT-1210 Horizontal Bumper Tube With Anti-Skid & Conspicuity Tape Recess 4" Steel Safety Bumper Tube

Weight: 7.0 lbs./ft.

Globetech bumper tube is a key ingredient of vehicle safety. One piece design provides an integral 2" inset area that neatly positions and protects the reflective tape from damage. The tube is constructed from 50,000 yield high strength steel, and incorporates full penetration welding for long, durable service. Choose from two surfaces: standard flat surface or safety grip surface for added traction.

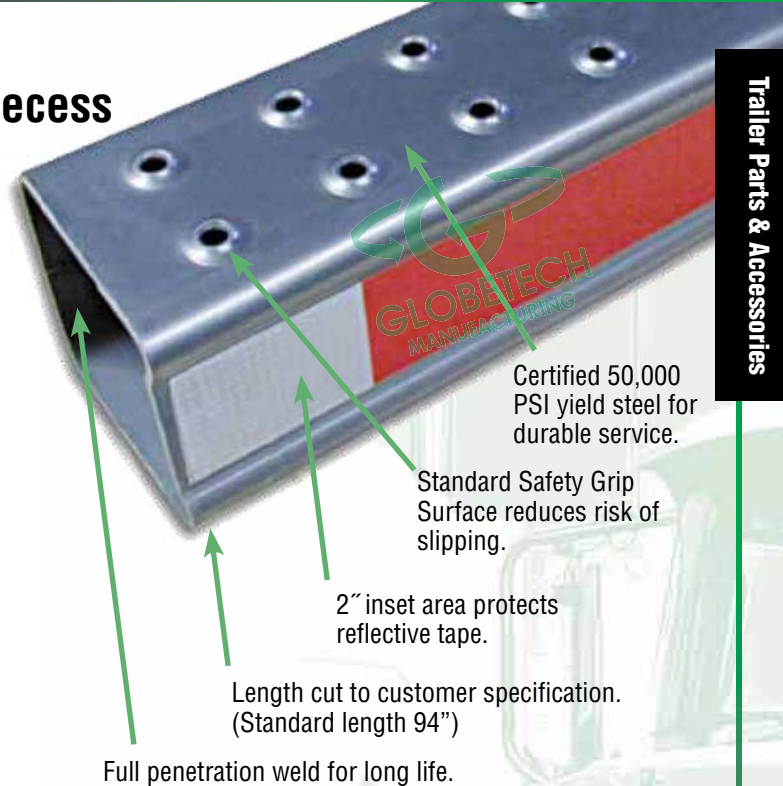

Trailer Parts & Accessories

Cross Section

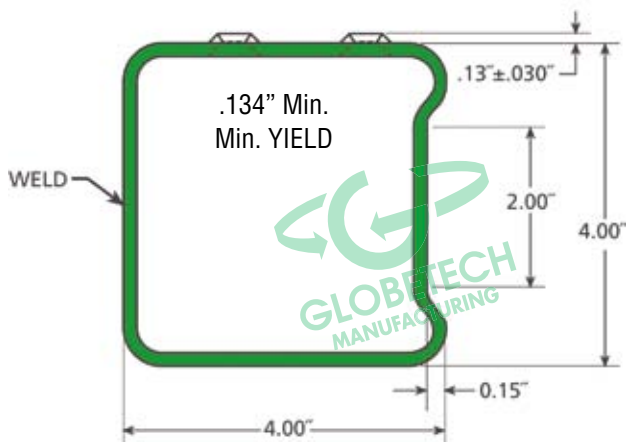

Hole Punch Pattern Dimensions

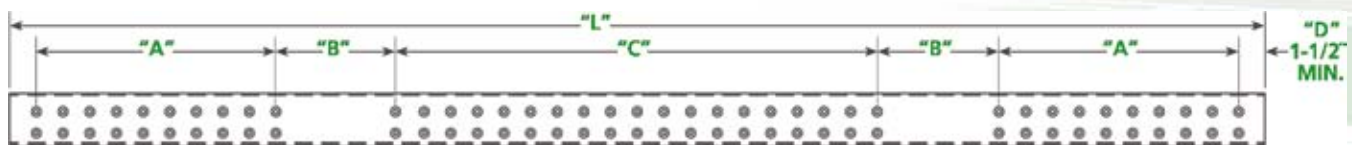

NOTE: Dimensions "A" and "C" must be specified in even increments of 2". Dimension "D" must be 1-1/2" minimum.

IMPORTANT: The Globetech Bumper Tube is sold to original equipment trailer manufacturers and to the trailer aftermarket for use as the horizontal structural member of a trailer's Rear Impact Guard. This Rear Impact Guard is required under federal law in both the U.S. and Canada. It is the responsibility of the installer of the Globetech Bumper Tube to insure that it and the complete Rear Impact Guard assembly is installed per the trailer manufacturer specifications and complies with any and all state/provincial and federal laws and regulations. In the U.S., Rear Impact Guards are regulated under Federal Motor Vehicle Safety Standards FMVSS 223/224 and Federal Motor Carrier Safety Regulation FMCSR 393.86. In Canada, they are regulated by Motor Vehicle Safety Act Standard 223.

WARNING: It is the responsibility of the installer of this bumper tube to insure that it and the entire Rear Impact Guard assembly is installed in accordance with the trailer manufacturer's specifications and in compliance with Federal Motor Vehicle Safety Standards FMVSS 223/224 (U.S.) or Motor Vehicle Safety Act Standard 223 (Canada). Failure to do so could result in death or serious injury to occupants of another vehicle in the event of a rear end collision with the trailer.



Registration Holder

NEW HOT ITEMS!

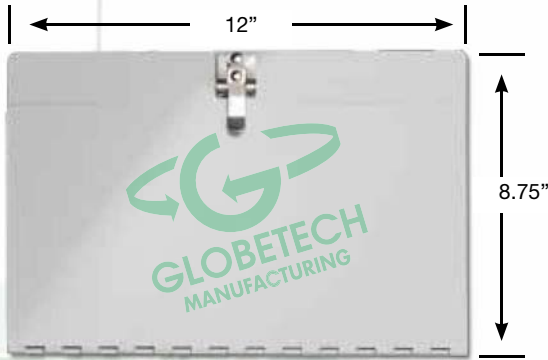

GT-1106

- Aluminum
- Powder coated finish

Part Number	Description
GT-1106	8.75" x 12" Replaces JJ Keller JJK 1RSP-DD
GT-1107	10.5" x 13" Registration Holder
GT-1111	Stainless Steel Clamp

GT-1107

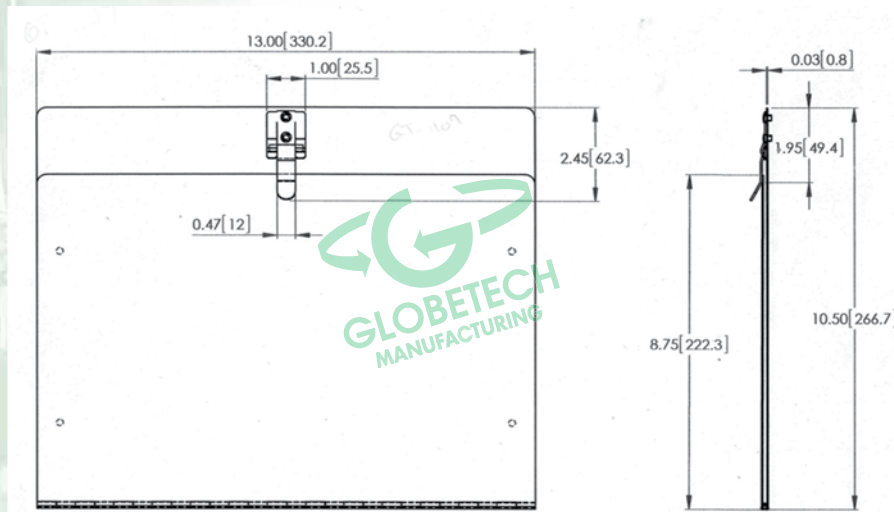

GT-1011 Water Proof Vinyl Pouch

Replaces Grote 43411-3

- All weather protection for permits, licenses, inspection stickers
- Self-sealing zipper protects from moisture and dirt
- Mounting: Four brass eyelets
- Sizes: 5-3/4" Wx8-1/4"L





Grab Handles

Part Number	Description
GT-5377	18"
GT-5378	24"



Steel Grab Handle

- Available in zinc and chrome finishes

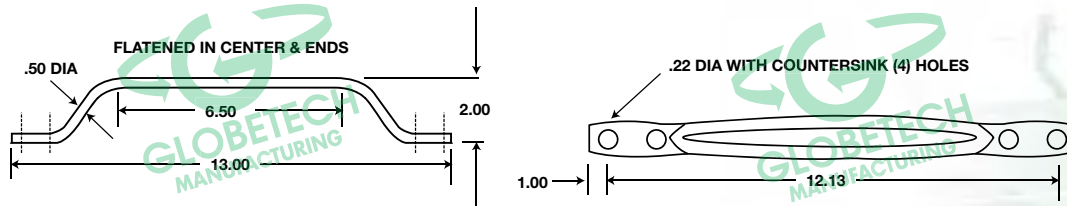

Part Number	Weight(lbs.)	Popularity Code	Construction	Cross Reference
GT-1114	.80	A	Zinc plated steel	Eberhard #4300 zinc
GT-1114C	.80	A	Chromed steel	Eberhard #4300 chrome

Aluminum Grab Handle

- Aluminum construction

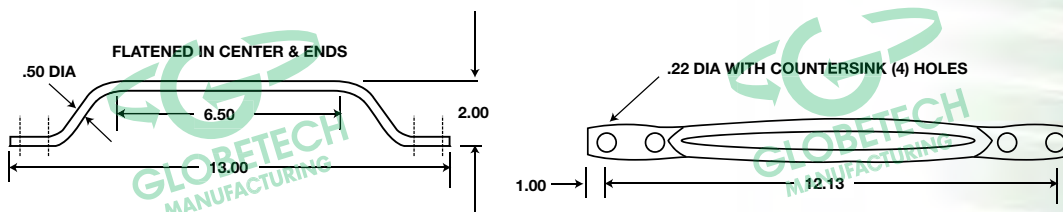

Part Number	Weight(lbs.)	Popularity Code	Construction
GT-1124	.80	A	aluminum



Door Hinges

GT-1410 Wabash Style Door Hinge

Replaces: WAB06301272

- Extruded aluminum

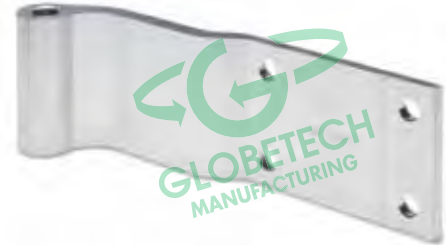

GT-1411 Wabash Style Door Hinge

Replaces: WAB06300291

- Extruded aluminum

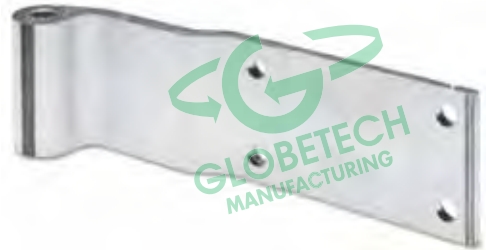

GT-1422 Hinge (Strick style)

Replaces: STRAA33C-0106-01

- Steel
- Zinc plated





BRACKETS • MUD FLAPS • QUARTER FENDERS

**RUBBER & POLY
CUSTOM MUD FLAPS
MADE IN USA**



ARMOR GUARD COMPOUND

Unvulcanized Friction Compound



Globetech Compound 6807

Typical Properties:

Density:	1.16± .04 gms/cm
Shore A Durometer:	70 Duro ± 8
Tensile Strength:	2000 Minimum
Elongation	300% Minimum

Globetech Material Reinforced Ultimate Tear Strength!

Basic Material is commercial productive tire tread compound or similar. Reinforced with polyester and nylon fiber. SBR/NR

ASTM D624 – 00(2012)

Standard test method for tear strength of conventional vulcanized rubber and thermoplastic elastomers

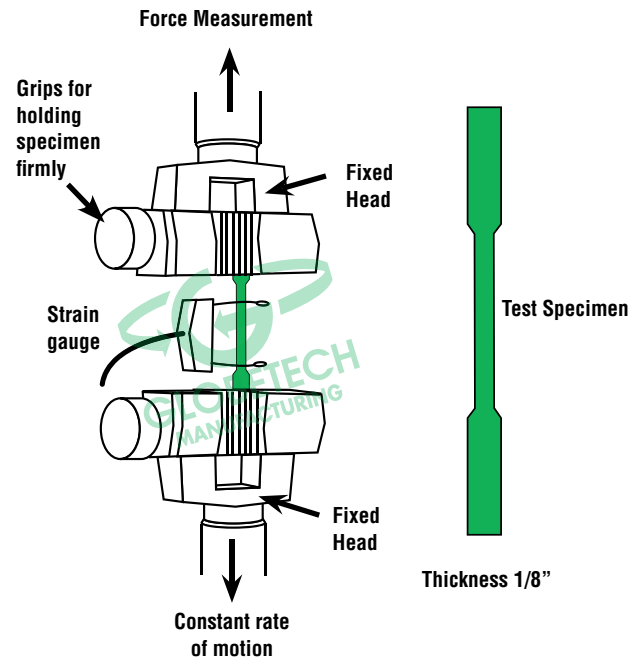
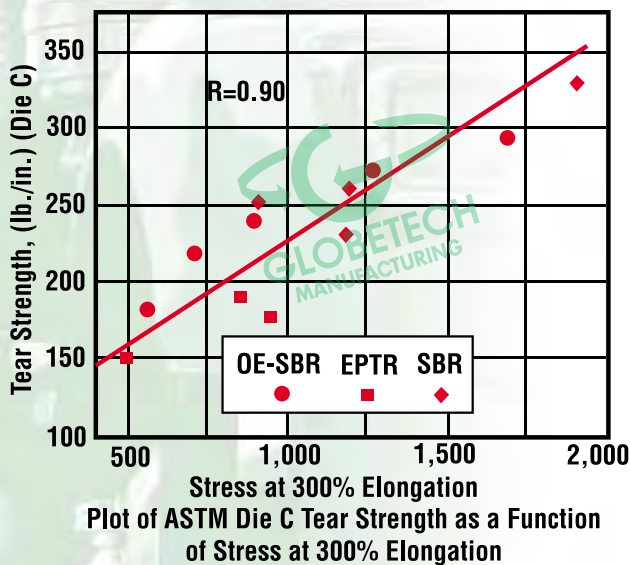



ARMOR GUARD

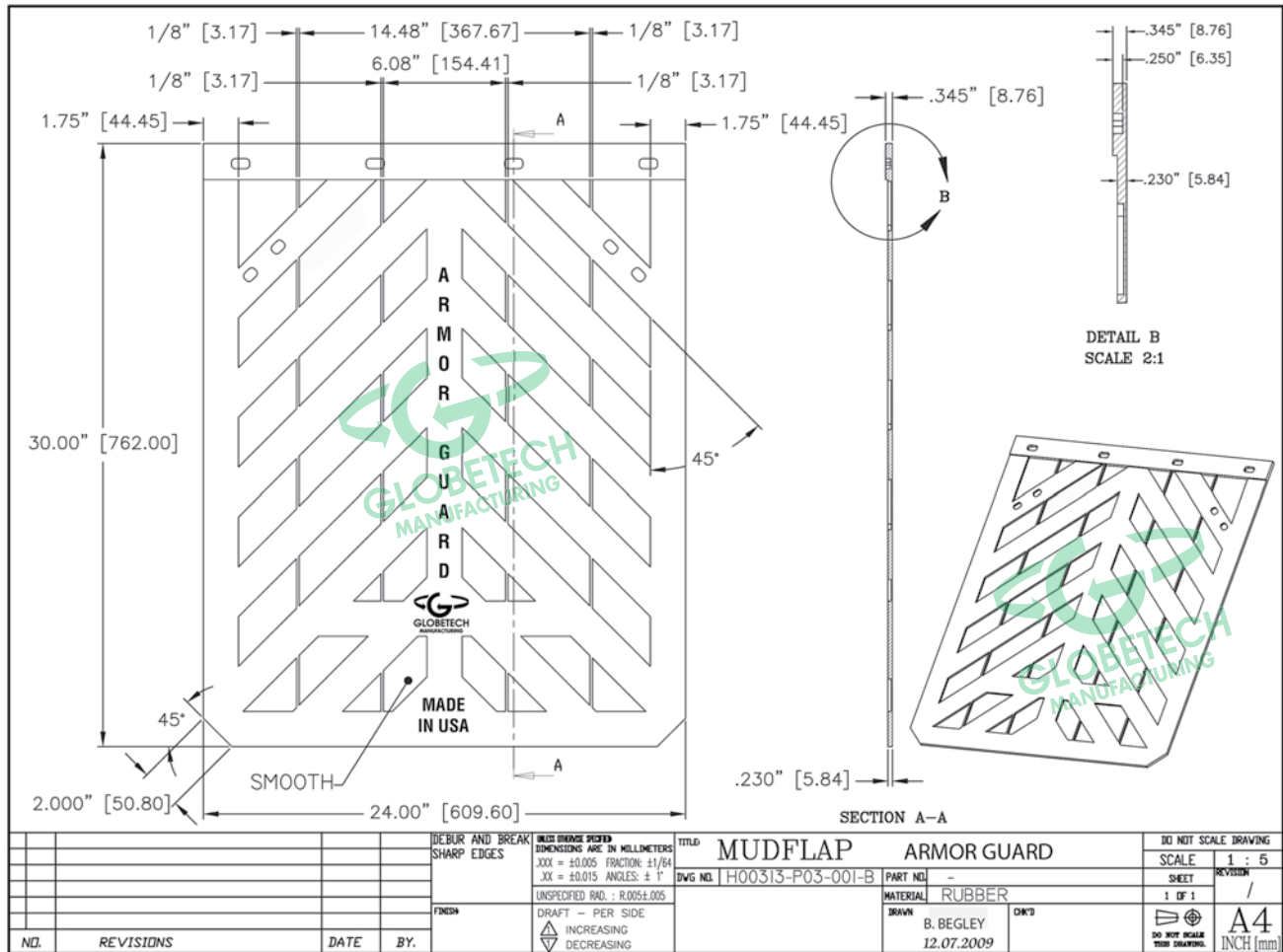

Domestic Mud Flaps MADE IN USA

DOMESTIC ARMOR GUARD MUD FLAP

The Armor Guard splash guard is made from 100% fiber reinforced rubber. The header is molded thicker to resist tearing through normal use. The top corners can be cut to fit standard 45 degree angle brackets. While the bottom can be cut down when a shorter flap is needed.

100% High Tear Strength
MADE IN USA
Best Flap On The Market!



Part Number	Description	Weight Per Pair	Replaces No.
GT-2424CD	24x24 Armor Guard Domestic	12 lbs.	062424
GT-2430CD	24x30 Armor Guard Domestic	14 lbs.	062430
GT-2436CD	24x36 Armor Guard Domestic	16 lbs.	062436



Imported Economy Chevron Mud Flaps



Tear Resistance

The resistance to growth of a nick or cut when tension is applied to the cut specimen. (ASTM D-624.)

Tensile Strength

The tensile strength of a rubber compound is its resistance to rupture under tension. It is measured as strength at break and expressed in pounds per square inch of cross section. This property has an absolute value in some applications where the product is actually subjected to tension in service but, like the other tension properties, it is most frequently used in evaluating compounding materials on a cooperative basis.

In a series of cures with a variable time factor the tensile strength either passes through a maximum or exhibits a marked change in the slope of its curve. Therefore, the tensile strength may be considered either separately or together with the modulus and elongation in defining an optimum state of cure for any specific compound.

CHEVRON MUD FLAP

This is our economy least expensive mudflap. These flaps are thinner and molded from natural rubber and reinforced with "Small Fibers". This flap has a High tear strength!

Look for the  logo! Many import chevrons are not made by Globotech and tear easy.

Part Number	Description	Weight Per Pair
GT-2424C	24x24 Chevron Economy Mud flap	10 lbs.
GT-2430C	24x30 Chevron Economy Mud flap	12 lbs.
GT-2436C	24x36 Chevron Economy Mud flap	14 lbs.

ASTM Standard Testing

- **Hardness: 80A**
- **Elongation: 200%**
- **Tensile: 4.2 MPA (609)**
- **Tear Strength: K/NR 30 (171)**
- **Spec. Gravity 1.39**





5/16" Standard Mud Flaps

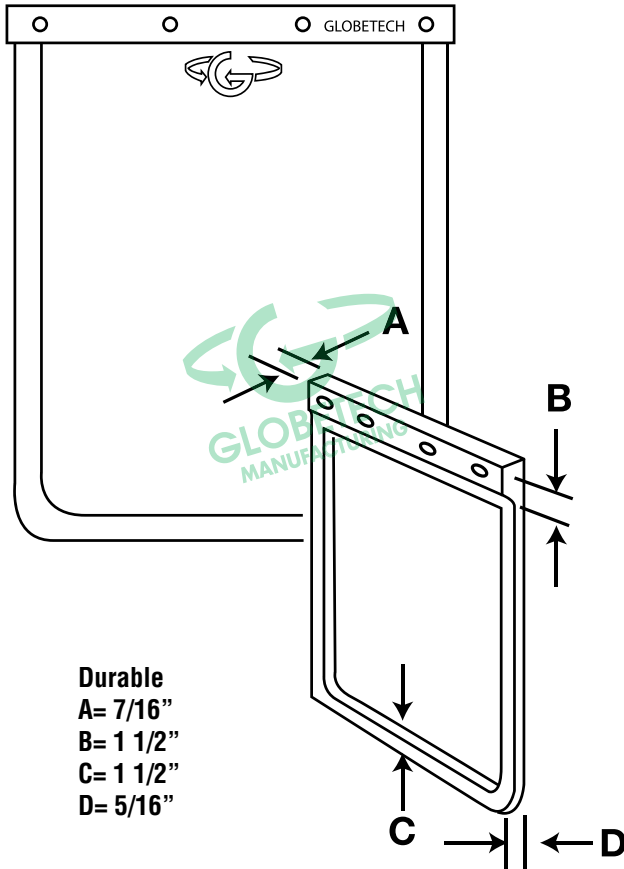

Globetech's Standard Mud Flaps

Globetech uses the finest material available to mold its standard mud flaps. These are the most popular mudflaps for logo use.

This material also meets all MIL-SPEC for Military Contractors.



Our 5/16" Standard splash guards are slightly heavier than our Chevron flaps. The majority of our customers prefer the Standard flap for their Custom logos.



★ MOLDED AND PRINTED IN USA ★

Part Number	Description	Weight Per Pair
GT-1217S	12X17 Standard Mud Flap	7 lbs.
GT-1924S	19x24 Standard Mud Flap	11 lbs.
GT-2418S	24x18 Standard Mud Flap	11 lbs.
GT-2424S	24x24 Standard Mud Flap	13lbs.
GT-2430S	24x30 Standard Mud Flap	15lbs.
GT-2436S	24x36 Standard Mud Flap	17lbs.



Mudflaps & Accessories



★ **MADE IN USA** ★



Nylon Mesh Reinforcement

Part Number	Description	Weight Per Pair
GT-2424XD	24x24 3/8" XTREME Mud Flap	16 lbs.
GT-2430XD	24x30 3/8" XTREME Mud Flap	17 lbs.
GT-2436XD	24x36 3/8" XTREME Mud Flap	19 lbs.
GT-2440X	24x40 3/8" XTREME Mud Flap	21lbs.
GT-2442X	24x42 3/8" XTREME Mud Flap	24lbs.

XTREME MUD FLAP

- Our Xtreme Mud Flap is molded from high tensile strength rubber. Using conveyor belt technology, a wire of nylon sheet is molded into the mud flap for greater durability.
- Great for dump trucks and off-road use
- Highest tear strength of any mud flap
- Stiffer flap prevents waving
- Available with silk-screen or raised molded logo

Correlation of Constrained Path Tear versus Off Road Tire Performance

The chart below illustrates the degree of correlation between CP tear strength at 100°C and the cutting-chipping rating of a series of compounds in an off-road tire performance test.

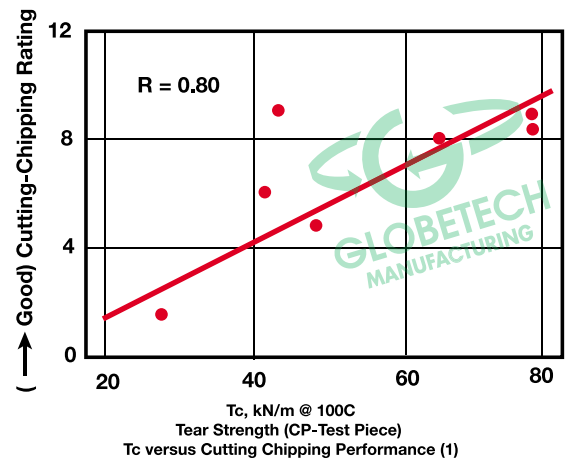

ABSOLUTE TOUGHEST FLAP ON THE MARKET!
REPLACES: STA-PUT-FLAPS



1/2" HEAVY DUTY, Anti-Spray Mud Flaps MADE IN USA



The **Heavy-Duty, Anti-Spray Flap** is the ultimate flap. The 1/2" thick reinforced rubber gives the flap anti-sail features. Raised knobs on the back side for anti-spray.

Part Number	Description	Weight Per Pair	Replaces Koneta No.
GT-2424HDD	24x24 1/2" Heavy Duty USA Mud Flap	19 lbs.	082424
GT-2430HDD	24x30 1/2" Heavy Duty USA Mud Flap	22 lbs.	082430
GT-2436HDD	24x36 1/2" Heavy Duty USA Mud Flap	24 lbs.	082436

- 45 Degree angle mount capable
- 30/36 dual mount capable
- Hole at bottom of flap for hook up
- Available with silk-screen or raised molded logo

NOTE: HD series also available in import

P/N GT-2424HD
P/N GT-2430HD
P/N GT-2436HD



Quick Change, AS Anti-Spray Mud Flaps



Part Number	Description	Weight Per Pair	Replaces Koneta No.
GT-2424AS	24x24 Quick Change Anti-Spray Mud Flap	18 lbs.	84500

ALL-RUBBER ANTI SPRAY QUICK CHANGE MUD FLAPS

Save time and money with two-step Quick Change Mud Flaps!

The Quick Change Anti-Spray mud flap features the easy two-step quick changeability plus finger-like projections directing spray downward while the built-in side ridges prevent lateral spray.

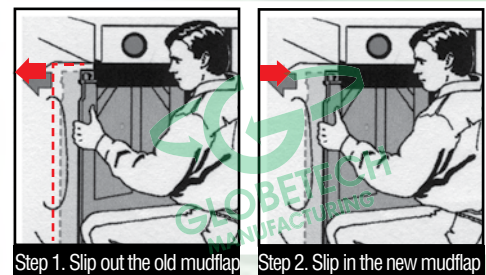



Anti-Sail Quick Mount Mud Flaps



Two embedded, all-steel bars resist wind force, even at high speeds. The convenience of quick maintenance combined with the stability of steel reinforcement bars.

Part Number	Description	Weight Per Pair	Replaces Koneta No.
GT-2430M	24x30 3/8" Quick Mount Mud Flap	20 lbs.	82506
GT-2436M	24x36 3/8" Quick Mount Mud Flap	22 lbs.	82504

Mudflaps & Accessories

Raintrapper Mud Flaps MADE IN USA

The Raintrapper flap is manufactured in the U.S.A. by Globetech Manufacturing. This is the ultimate anti-spray mud flap for the heavy duty trucking industry. The Raintrapper mud flap features the finger-like projections directing spray downward while the built-in side ridges prevent lateral spray.

Part Number	Description	Weight Per Pair	Replaces Koneta No.
GT-2430RT	24x30 Raintrapper Flap	20 lbs.	84502

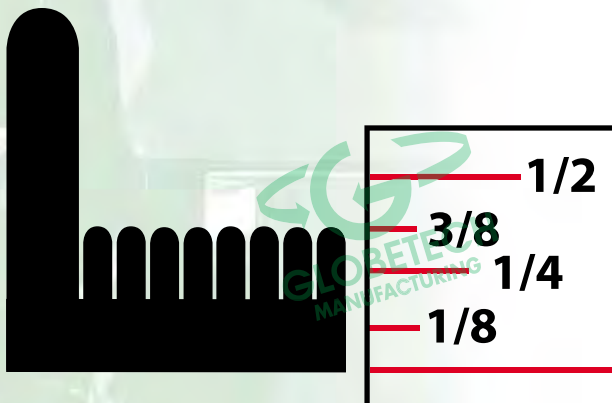

← Profile diagram showing finger-like projections



Standard 5/16" Raised Molded Mud Flaps



Part Number	Description	Weight Per Pair
GT-1220RSM	12 X 20 - 5/16" Standard Black Rubber Mud Flap w/Logo One Color	3
GT-2424RSM	24 X 24 - 5/16" Standard Black Rubber Mud Flap w/Logo One Color	13
GT-2430RSM	24 X 30 - 5/16" Standard Black Rubber Mud Flap w/Logo One Color DUAL MOUNT	15
GT-2436RSM	24 X 36 - 5/16" Standard Black Rubber Mud Flap w/Logo One Color TRI MOUNT	17

Rain Guard 3/8" Raise Molded

Tri-Mount
Perfect for dump trucks, and off road applications.



Anti Spray Back

Part Number	Description	Weight Per Pair
GT-2424RGM	24 X 24 - 3/8" Fiber Enforced Black Anti Spray Rubber Mud Flap w/Logo One Color	16
GT-2430RGM	24 X 30 - 3/8" Fiber Enforced Black Anti Spray Rubber Mud Flap w/Logo One Color TRI MOUNT	18
GT-2436RGM	24 X 36 - 3/8" Fiber Enforced Black Anti Spray Rubber Mud Flap w/Logo One Color TRI MOUNT	20

All raised molded flaps are made in Dayton, Ohio USA.
Our Flaps are made from 100% friction reinforced material to ensure ultimate tear strength and durability.



Tireplast Mud Flaps

This recycled rubber is a combination of recycled rubber (from tires) and plastic, tireplast is environmentally friendly and allows for custom product specifications. A great replacement for most natural and synthetic rubber, tireplast has low temperature impact toughness, tensile strength, flexibility, and sound deadening capabilities. Tireplast is resistant to many chemicals including alcohol, anti-freeze, diesel fuel, gasoline, grease, hydraulic oil, kerosene, motor oil, distilled water, and salt water.

Finished Products

- Mats & Runners
- Drainage Mats
- Automotive Splash guards
- Pick-up Truck Bed Liners
- Brake Pedal Pads
- Counter Top Mats
- Trailer Wall Liner
- Sound Deadening
- Agricultural Mats

Tireplast/Thermo Plastic Mud Flaps



- Thermo plastic rubber
- Anti-curling attributes of a rubber flap
- Stiff anti-sail features of a poly flap
- Ribbed back for anti spray
- Also available in angle cut or rounded corners, Call our sales department for more information.



Tireplast Mud Flap Profile

Part Number	Description	Thickness
2424TPPSB	Tireplast Mud Flap - Black 24"x24"	1/4"
2430TPPSB	Tireplast Mud Flap - Black 24"x30"	1/4"
2436TPPSB	Tireplast Mud Flap - Black 24"x36"	1/4"
2424TPHDB	Heavy Duty Tireplast Mud Flap - Black 24"x24"	3/8"
2430TPHDB	Heavy Duty Tireplast Mud Flap - Black 24"x 30"	3/8"
2436TPHDB	Heavy Duty Tireplast Mud Flap - Black 24" x 36"	3/8"



A MUST HAVE FOR DUMP TRUCKS!

MidGuard Mud Flaps

MidGuard Mud Flaps provide unsurpassed protection from flying gravel, splash and road spray. Available in three thicknesses.

Part Number	Description	Replaces
GT-443638	3/8" x 44" x 36"	140002

Side Shields

- Side Shields offer ribbed construction to reduce spray from sides of trailers.

Part Number	Description	Replaces
GT-848S	Side Skirt Fap, 8" x 48" Rubber	074807

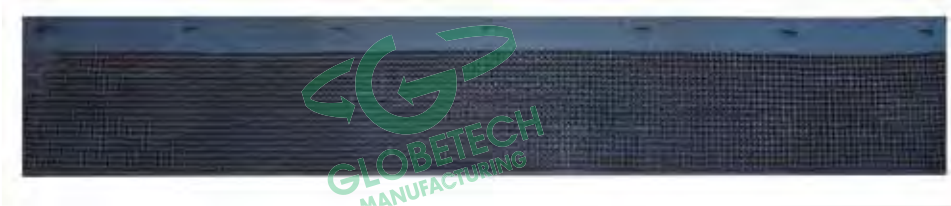

Colored Poly Flaps also available – 24" x 30" x 3/16" Only

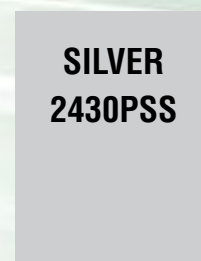
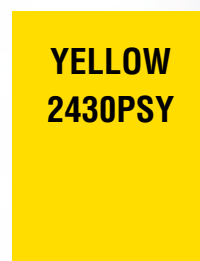



Silk-Screen Logo Rubber Mud Flaps



SILK-SCREEN LOGOS OFFER:

- Multi-Color logos with great detail!
- Long lasting urethane paint also used on floors and running tracks will **NOT WEAR OFF**
- Fast turn around (4 weeks)
- **NO SET UP CHARGE!**
(1 color logos only)
(additional charges for multi-color)

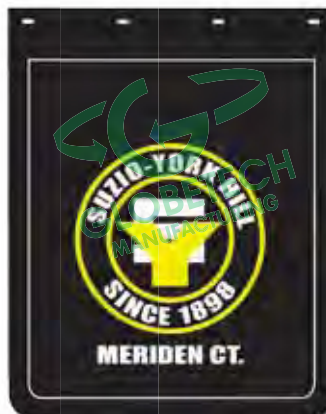

Mudflaps & Accessories



Polyguard Mud Flaps

Antispray Poly Mud Flaps Material Specification Sheet:

**Property
Material**

Tensile Strength
Tensile Elongation
Specific Gravity
Hardness, Shore D
Tear Resistance
Flexural Modulus
Notched Low Temperature Brittleness

ASTM Test Method Polyethylene	Value Polyethylene
D638	>4000 psi
D638	>1000%
D792	0.925
D2240	51
D1004	>1000 psi
D790	150,000 psi
D746	-42 C



HOT STAMPED LOGOS



3/16" Polyguard Standard



Part Number	Description	Weight Per Pair
2424PSB	24X24 Standard Poly - Black	
2424PSW	24X24 Standard Poly - White	6 lbs.
2430PSB	24x30 Standard Poly - Black	
2430PSW	24x30 Standard Poly - White	8 lbs.
2436PSB	24x36 Standard Poly - Black	
2436PSW	24x36 Standard Poly - White	10lbs.

- 3/16" Thick
- Will not crack or curl
- Economic Price

1/4" Anti-Spray Poly Plus



Part Number	Description	Weight Per Pair
2424PPSB	24X24 1/4" Anti-Spray - Black	
2424PPSW	24X24 1/4" Anti-Spray - White	7 lbs.
2430PPSB	24x30 1/4" Anti-Spray - Black	
2430PPSW	24x30 1/4" Anti-Spray - White	9 lbs.
2436PPSB	24x36 1/4" Anti-Spray - Black	
2436PPSW	24x36 1/4" Anti-Spray - White	11lbs.

- 1/4" Thick
- Anti-Spray Ribbed Back
- Medium Duty

3/8" Anti-Spray Poly Plus HD



Part Number	Description	Weight Per Pair
2424PHDB	24X24 3/8" Anti-Spray - Black	
2424PHDW	24X24 3/8" Anti-Spray - White	10 lbs.
2430PHDB	24x30 3/8" Anti-Spray - Black	
2430PHDW	24x30 3/8" Anti-Spray - White	12 lbs.
2436PHDB	24x36 3/8" Anti-Spray - Black	
2436PHDW	24x36 3/8" Anti-Spray - White	14 lbs.

- 3/8" Thick
- Anti-Spray Ribbed Back
- Heavy Duty



Stock logo Mud Flaps



GT-9026

GT-9021



GTM-9020



GT-9014 = White Poly
GT-9015 = Black Poly
GT-9016 = Yellow Poly



GT-9017



GT-9032



GT-9019



GT-9023



GT-9024 - Black
GT-9025 - White



CUSTOM LOGO COLOR MUD FLAPS

MADE IN USA NOTE: Standard black and white available for all logo types.

Silkscreen for rubber flaps

	Red - Pantone 185 C
	Blue - Pantone 2945 C
	Yellow - Pantone 115 C
	Green - Pantone 3298 C
	Orange - Pantone 1655 C
	Gray - P Cool Gray 5 C

Hot Stamp for poly flaps

 Red P 186 C	 Blue P 2935 C	 Dark Blue P 2965 C	 Light Blue P 2925 C
 Dark Green P 3435 C	 Yellow P 116 C	 Orange P 172 C	 Maroon P 188 C
 Green P 348 C	 Brown P 1615 C	 Gray P Cool Gray 10 C	Custom colors available \$100 charge per color (silkscreen & hotstamp)

Guidelines

RUBBER:

- 50 ea / 25 pr minimum order
- Proof must be signed before production can begin
- Lead time: 4-6 weeks
- 2 weeks for screen set up
- NO SET UP CHARGE (1 color only, additional charge for multi-color)

POLY:

- 100 ea minimum order
- Proof must be signed before production can begin
- Lead time: 4-6 weeks
- 2 weeks for plate production
- \$200 per color plate charge
- NO SET UP CHARGE - 500 pcs (1 color only, additional charge for multi-color)

Ordering

- Rubber or Polyguard Flaps
- Flap Type
- Flap Size
- Order Quantity
- Flap Color
- Imprint Color(s)
- Custom color available upon request (please call for more information)



Mudflaps & Accessories



MUDFLAP PROOF

Special Notes:

Customer: _____

Attn: _____

Flap Style: _____

Print Style: Hot Stamp Silkscreen

Flap Size: _____

Imprint
Color: _____

Order Qty: _____

Set-up Fee: _____

Approved BY: _____
Signature: _____

Printed Name: _____ Date: _____

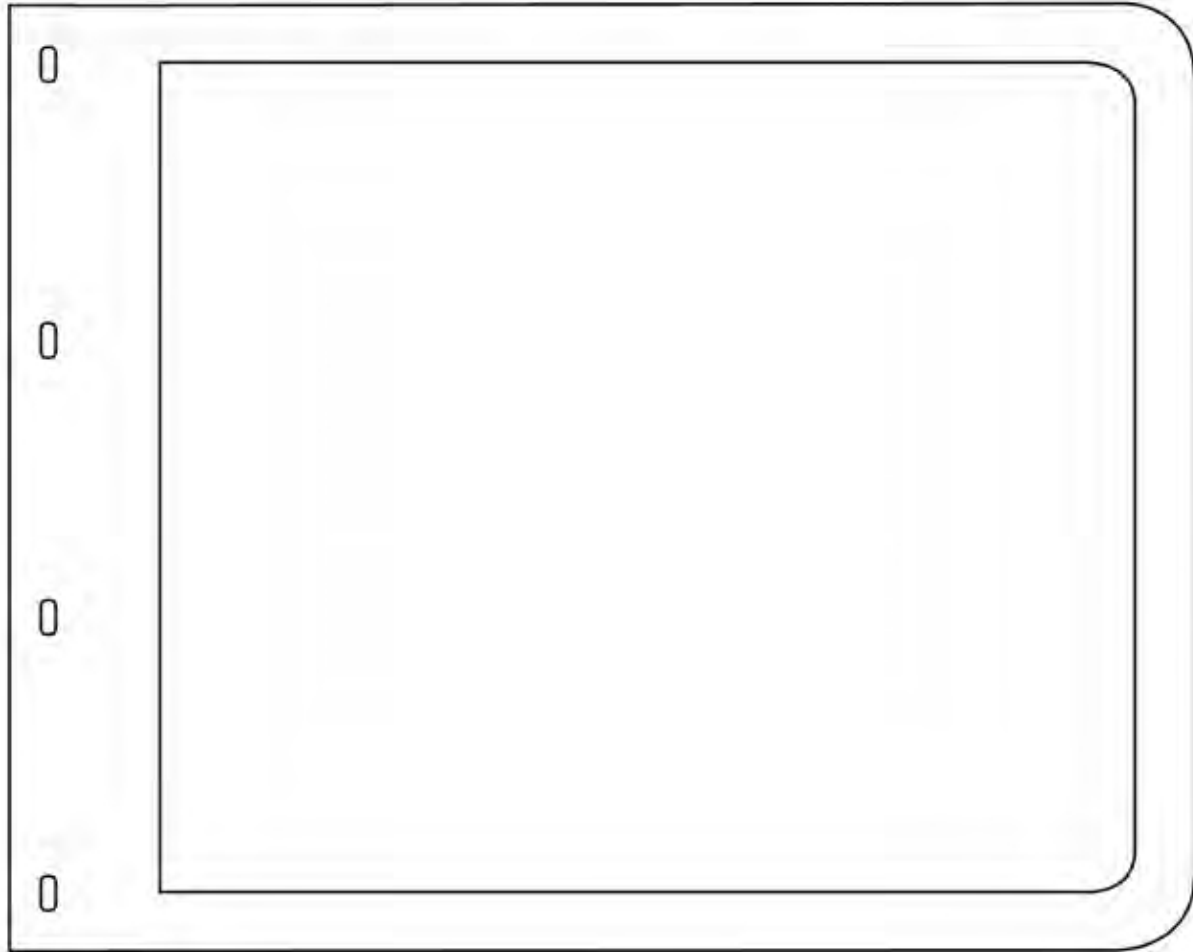

• Signed proof **MUST** be returned before production can begin!



Mudflaps & Accessories

OHSA SPECIFIES:

1910.178(K) TRUCKS AND RAILROAD CARS

(1) The brakes of highway trucks shall be set and wheel chocks placed under the rear wheels to prevent the trucks from rolling while they are boarded with powered industrial trucks.

GT-2047 - Heavy Duty Chock

GT-2047D - Domestic

Made In USA



- Large zinc-plated eyebolt
- Non-skid bottom
- 8"D x 10"L x 6"H

Replaces: Koneta 430030

GT-2048 - Heavy Duty Chock



- Most popular design
- Zinc-plated eyebolt
- 9lbs.
- 8"D X 9-1/2"L X 5-3/4"H

GT-2049 - Contour Chock



- Molded handle on the back
- Nylon safety rope on request
- 11 pounds
- Used for heavy equipment and trucks

Replaces: Koneta 430040

GT-2050 - Standard Utility Chock



- Cored out back
- Power-coated handle
- 8 pounds
- Used by utility companies
- 8"D x 10"L x 5"H

GT-2055 - Stair Step Wheel Chock

GT-2055D Domestic

Made In USA



- Zinc plated eyebolt
- Sharp steps to grip better
- 9 pounds
- 8"D x 9"L x 6"H

GT-2057 - Large Chock



- 16 pounds
- 10"D x 12"L x 8"H
- Used for off-road equipment and trucks



Chock with Chain
Part No. A52475

Chain assembly can be sold separate or attached to wheel chock.



Shark Skin Trailer Bumpers



Globetech's 4-Layer Protection

- 2-Layers of abrasion resistant, high-tear strength compound
- 2-Layers of Styrene Butadiene encapsulated nylon cord sheets
- Base rubber compound consists of fiber reinforced prime rubber containing nylon and polyester
- Resists aging from weather, ozone, heat, abrasion and chemicals.

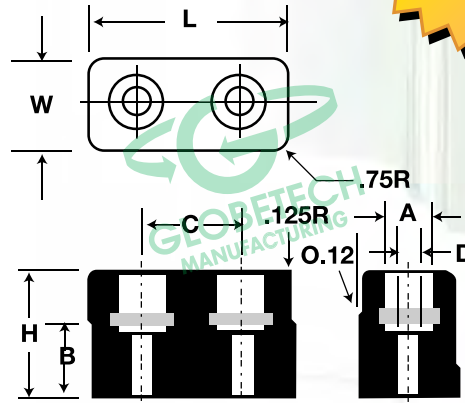

Part Number	A	B	C	D	L	W	H
GT-2000	1-1/2"	3-1/2"	3"	9/16"	6"	3"	5"
GT-2006	1-1/2"	1-3/4"	3"	9/16"	6"	3"	3-1/2"
GT-2312	1-3/8"	1-1/8"	2-5/8"	17/32"	6"	2-3/8"	3-1/4"
GT-2027	1-3/16"	1-3/4"	3-1/2"	11/16"	5-3/4"	3-3/4"	4-1/2"
GT-2042	1-1/4"	1"	4-5/8"	9/16"	7-7/8"	2-3/8"	2"
GT-2044	1-1/2"	1-1/4"	2-5/8"	17/32"	6"	2-3/4"	3"
GT-2345	1-7/16"	1-1/4"	3-1/2"	5/8"	6"	2-5/8"	3-1/4"
GT-UTM053	1-1/4"	3-1/2"	3-1/2"	17/32"	6-1/8"	3-5/8"	5-1/4"
GT-UTM172	1-1/4"	2-3/4"	3-1/2"	17/32"	6-1/8"	3-5/8"	4-1/2"
GT-UTM214	1-1/4"	1-3/4"	2-3/8"	1-7/32"	4-5/8"	2-5/8"	3-1/2"
GT-UTM259	1-1/4"	2-1/4"	3-1/2"	17/32"	6-1/8"	3-5/8"	4"
GT-UTM006	1-1/4"	1-3/4"	3-1/2"	17/32"	6-1/8"	3-5/8"	3-1/2"

Material Specifications:

- 80+5 Durometer
- Impact recovery (ASTM 1170) of 95%
- Tensile Strength 2000+ psi

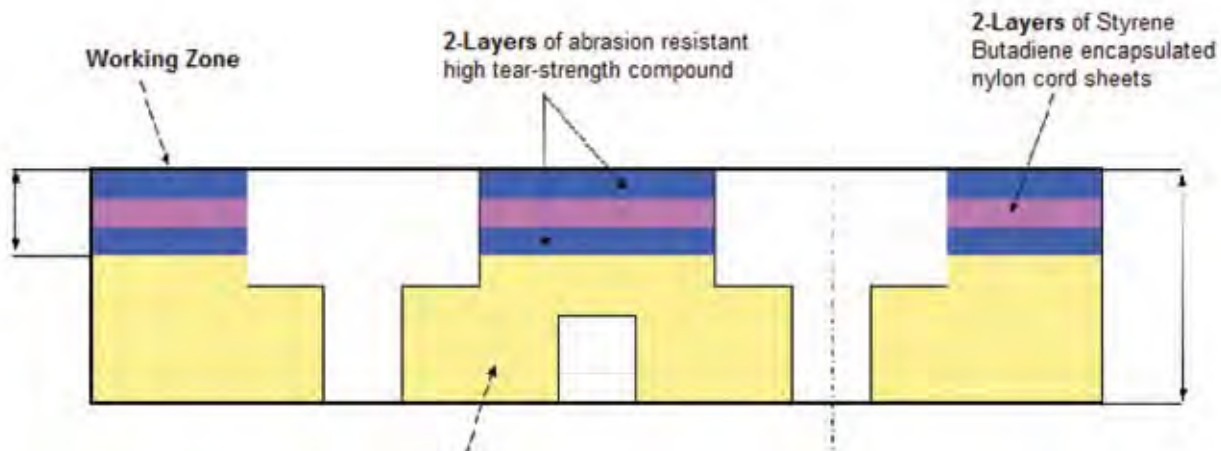



Shark Skin Trailer Bumpers

Globetech Manufacturing molded dock bumpers are the best in the industry. All bumpers are molded from fiber-reinforced rubber to ensure durability.

APPLICATIONS:

- Perfect protection for any high-traffic truck dock.
- In-plant wall protection from forklifts and other material-handling vehicles.

MATERIALS:

- Manufactured from fiber-reinforced prime rubber containing nylon and polyester.
- All bumpers have an impact recovery (ASTM 1170) of 95% with 80+ 5 durometer tensile strength.
- All molds have pre-drilled, countersunk mounting holes for easy installation and are drilled to accept 3/4" anchor bolts.

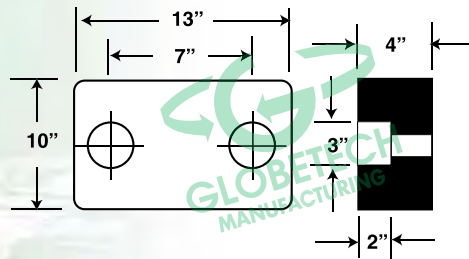
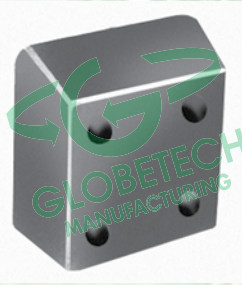

Part Number	Description	Weight
GT-2099	4" X 12" X 13"	21LBS.

Extruded Rubber Bumpers



Extruded Rubber Bumpers

- Available up to 10 ft.
- For Live Stock Trailers
- Drilled holes

Part Number	Description	Weight
D-312	D-3 Dock Bumper 12" L x 3" W x 3" H	3 lbs.
D-324	D-3 Dock Bumper 24" L x 3" W x 3" H	6 lbs.
D-372	D-3 Dock Bumper 72" L x 3" W x 3" H	18 lbs.
D-412	D-4 Dock Bumper 12" L x 4" W x 4" H	6 lbs.
D-412A	D-4 Dock Bumper No Holes 24" L x 4" W x 4" H	6 lbs.
D-424	D-3 Dock Bumper 24" L x 4" W x 4" H	10lbs.
D-424A	D-4 Dock Bumper No Holes 24" L x 4" W x 4" H	10 lbs.
D-472	D-4 Dock Bumper 72" L x 4" W x 4" H	36 lbs.
D-612	D-6 Dock Bumper 12" L x 4" W x 6" H	9 lbs.
D-624	D-6 Dock Bumper 24" L x 4" W x 6" H	18lbs.
D-672	D-6 Dock Bumper 72" L x 4" W x 6" H	36lbs.

D-412

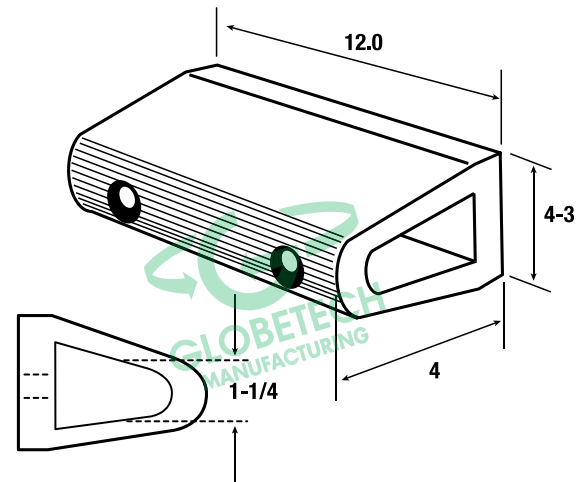



Shark Skin Trailer Bumpers

Standard Material

- Manufactured from fiber-reinforced prime rubber containing nylon & polyester
- 80+5 Durometer
- Impact recovery (ASTM 1170) of 95%
- Tensile strength = 2000+ psi
- Compression molded

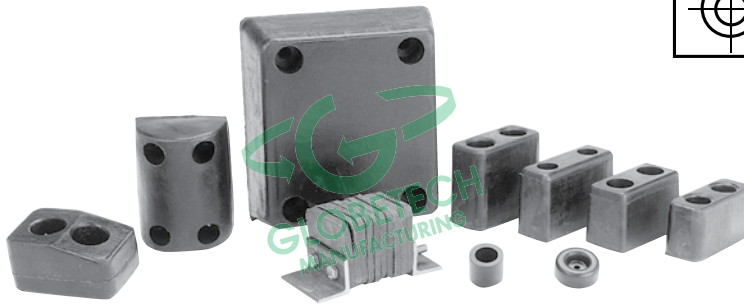
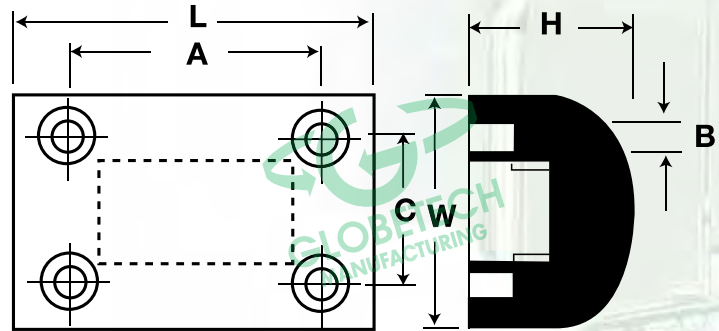

Part Number	A	B	C	L	W	H
GT-2036	5-1/2"	3/4"	3-1/4"	8"	5-1/4"	3-5/8"
GT-2045	5-1/2"	9/16"	3"	7-5/8"	5-1/2"	3-5/8"
GT-2046	5-3/8"	9/16"	3-1/8"	8"	6"	3"

Special Bumpers

Globetech can manufacture any custom molded bumper top any specification.

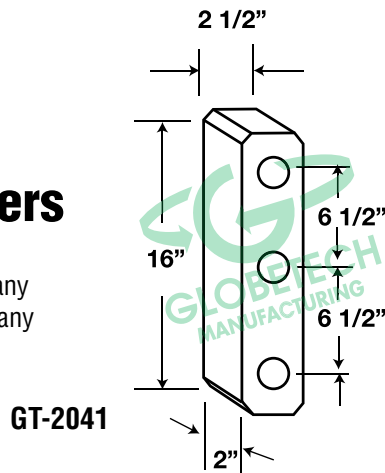

GT-2041

Part Number	Approx. Weight Each	Size
GT-2041	3lbs.	2" x 2" x 16"

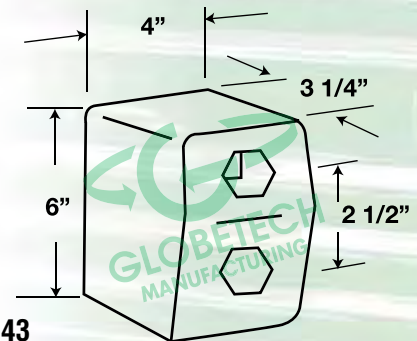

GT-2043

Part Number	Approx. Weight Each	Size
GT-2043	3lbs.	6" x 4" x 3"



Laminated Bumpers

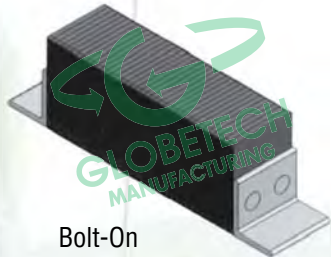

Bolt-On
GT-2100 = WAB21400170
GT-2105 = WAB21400177

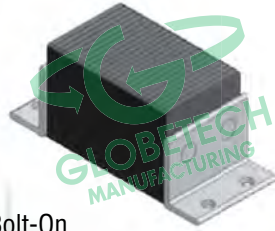

Bolt-On
GT-2101



Weld-On
GT-2102

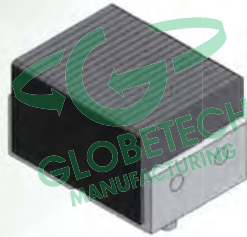

Weld-On
GT-2103



Weld-On
GT-2104



Weld-On
GT-2106

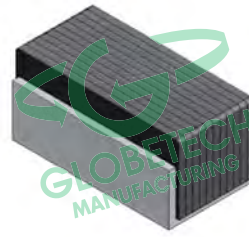

Stud Mount
GT-2107



Stud Mount
GT-2109

- Stainless steel hardware
- Multi-ply belting
- Custom bumpers available

Part Number	Length	Width	Height
GT-2100	10-1/4"	3"	3-1/2"
GT-2101	6"	4"	4"
GT-2102	5-1/2"	4"	3"
GT-2103	5-1/2"	4"	3-1/4"
GT-2104	5-5/8"	4"	4"
GT-2105	9-1/2"	3"	4"
GT-2106	6-1/4"	2-7/8"	2-3/4"
GT-2107	6-1/8"	3-1/4"	2-3/4"
GT-2109	6"	2-3/4"	3"

Door Bumpers



GT-025



GT-2108



GT-2613

- Made of SBR 60 Durometer

Part Number	Size	Hole Diameter
GT-025	1-7/8" x 1-5/8"	9/16"
GT-2108	1-1/2" x 3/4"	1/4"
GT-2613	2-1/2" x 1"	3/8"



Standard .640 Bar Type Mud Flap Hangers

The .640 square spring steel hangers are the standard for the trucking industry. Globetech mud flap hangers are manufactured and tested to OEM specs using SAE test methods. Our hangers are made to accomodate flaps of all sizes.

Kits include (2) mud flap hangers with adjustable flap clips, (2) GT-27B711 mounting brackets, (2) cotter pins and mounting hardware for flaps and brackets.

Part Number	Description	Cross Ref.	
GT-2723B	Kit w/hardware, pair	B23	031-00123



Part Number	Description	Cross Ref.	
GT-2725A	Standard Straight Hanger 10/Box *hardware not included	A25	034-00426
GT-2725B	Kit w/ hardware, pair	B25	031-00125
GT-2725B70	Bulk Barrel 70/ea *hardware not included	A25RLB40	031-0050

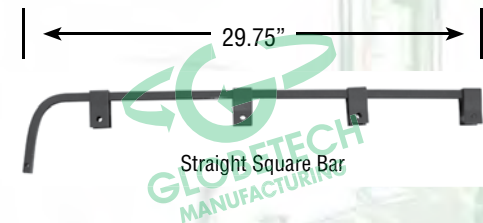

Part Number	Description	Cross Ref.	
GT-2733B	Kit w/hardware, pair	B33	031-00133

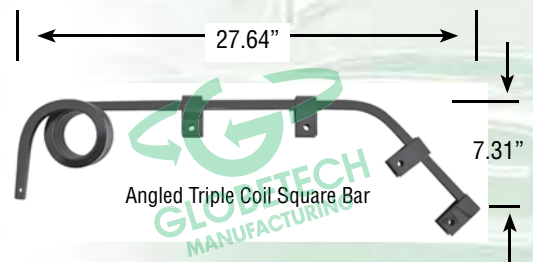

Part Number	Description	Cross Ref.	
GT-2735A	Standard Angled Hanger 10/Box *hardware not included	A35	034-00433
GT-2735B	Kit w/hardware, pair	B35	031-00135
GT-2735B40	Bulk Barrel 40/ea, *hardware not included	A35RLB40	031-00049



Part Number	Description	Cross Ref.	
GT-2729B	Kit w/hardware, pair	B29	031-00129

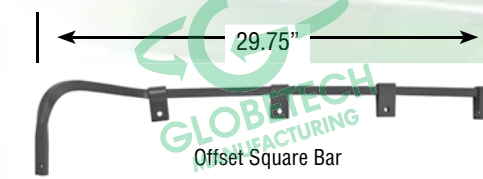



Mudflaps & Accessories

Globetech mudflap hangers and brackets are manufactured to the highest specifications to meet your needs.

Our mudflap hangers were tested by an independent lab and resulted in a superior rating for minimum permanent deflection.

Globetech mudflaps surpassed the Rockwell Hardness B testing per ASTM E18.

Heavy Duty .750 Bar Type Mud Flap Hanger

The .750 square spring steel hangers are among the strongest and most durable flap hangers on the market, designed to meet heavy load of anti-spray flaps. Globetech mud flap hangers are manufactured and tested to OEM specs using SAE test methods.



Kits include (2) mud flap hangers with adjustable flap clips, (2) GT-27B700 mounting brackets, (2) cotter pins and mounting hardware for flaps and brackets.

Part Number	Description	Cross Ref.
GT-2721B	Kit w/hardware, pair	B21 031-00121



Part Number	Description	Cross Ref.
GT-2781A	HD angled hanger 10/Box *hardware not included	A81 034-00685
GT-2781B	Kit w/hardware, pair	B81 031-00105

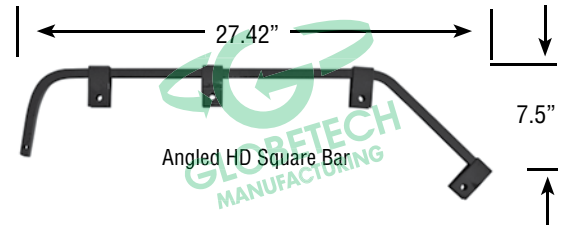

Part Number	Description	Cross Ref.
GT-2782A	HD straight hanger 10/Box *hardware not included	A82 034-00679
GT-2782B	Kit w/hardware, pair	B82 031-00102

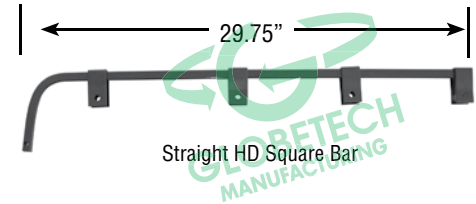

Part Number	Description	Cross Ref.
GT-2783B	Kit w/hardware, pair	B83 031-00108

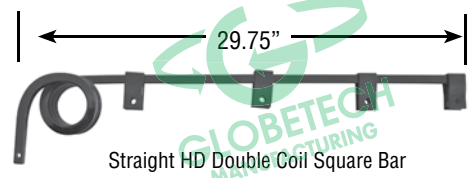

Part Number	Description	Cross Ref.
GT-2784B	Kit w/hardware, pair	B84 031-00110

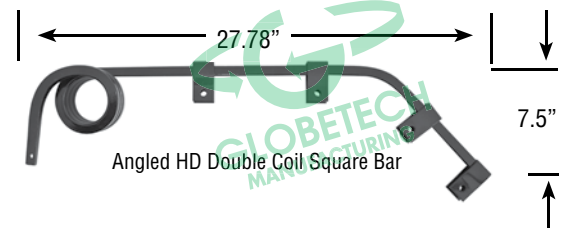



Standard Mounting Brackets for .640 Hangers

- Cast steel construction
- Black primed finish
- Allows for relocation of brackets from one vehicle to another
- Kits include (2) brackets, (4) bolts w/lock washer, (4) nuts and (2) cotter pins

Part Number	Description	Cross Ref.
GT-27B711	Black cast mount bracket, single	B711
GT-27K711	Kit w/mounting hardware, pair	K711

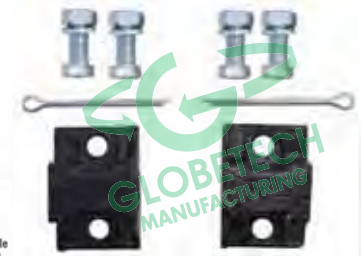
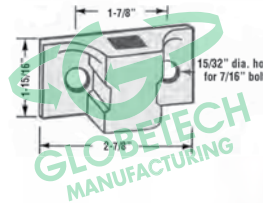

Heavy Duty Mounting Brackets for .750 Hangers

- Cast steel construction
- Black primed finish
- Allows for relocation of brackets from one vehicle to another
- Kits include (2) brackets, (4) bolts w/lock washer, (4) nuts and (2) cotter pins

Part Number	Description	Cross Ref.
GT-27B700	Black HD cast mount bracket, single	B700
GT-27K700	Kit w/mounting hardware, pair	K700

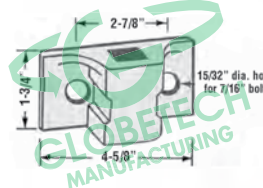

Standard Anti-Sail Bracket

- Assembly required
- Part number represents single bracket only - enough for one mud flap
- Fits standard 24.00" flaps
- Will accommodate flaps up to 3/8" thick

Part Number	Description	Weight	Cross Ref.
GT-2701SS	21" x 24" Anti-Sail Bracket Stainless Steel	1.82	033-05126
GT-2701C	21" x 24" Anti-Sail Bracket Chrome	1.82	033-05126



Standard Anti-Sail Bracket- One Piece Design

- Assembly required
- Part number represents single bracket only - enough for one mud flap
- Fits standard 24.00" flaps
- Will accommodate flap up to 1.00" thick

Part Number	Description	Weight	Cross Ref.
GT-2702SS	21" x 24" Anti-Sail Bracket One Piece Stainless Steel	1.82	033-00076
GT-2702C	21" x 24" Anti-Sail Bracket One Piece Chrome	1.82	033-00075





Mud Flap Mounting Angle & Retaining Strap

- .12" thick, heavy-duty steel construction
- Black primer finish



Part Number	Description	Weight	Cross Ref.	
GT-27051	2.00 x 2.00 x 27.50 mounting angle	3.4 lbs.	#07-50	033-00051
GT-27053	2.00 x 24.00 retaining strap	1.4 lbs.	#07-50-1	033-00053

Mud Flap Bolt Kit

- Attaches mud flaps to any type of mud flap bracket
- Sets consists of eight bolts, eight nuts, and sixteen washers
- Enough to hang two mud flaps
- Available in Stainless steel or Zinc options



Part Number	Description	Weight	Cross Ref.
GT-27516	Mud Flap Bolt Kit Stainless Steel packaged set	0.72	031-01200
GT-27517	Mud Flap Bolt Kit Zinc packaged set	0.72	031-01298



GT-2725A



GT-2735A

BULK DISPLAYS

Part Number	Description	Cross Ref.
GT-2725B70	Square Steel Straight Arm Hangers 70/ea- GT-2725A Bulk Barrel	A25RLB40
GT-2735B40	Square Steel Angled Down Hangers 40/ea-GT2735A Bulk Barrel	A35RLB40



Hardware not included

Mudflaps & Accessories



Conspicuity Strips

- Durable Aluminum Plate
- Reflective tape meets FMVS standard
- Universal used either on roadside or curbside
- Can be used with any straight, shortie, bar or spring loaded bracket

Part Number	Description	Cross Ref.
GT-27RT25	Straight Aluminum Conspicuity Strips, pair	RT25
GT-27RT35	Angled Aluminum Conspicuity Strips, pair	RT35



Conspicuity Tape

- DOT-C2 certified, exceeds NHTSA requirements
- Highly reflective, even up to a 90° angle
- Available in red and white roll/strips, all white roll or all yellow roll
- Quick and easy to apply

Part Number	Description	Type
GT-27000	12" x 2" Strip (2)ea / 6" red x 6" white pattern	strip
GT-27003	150 feet / 6" red x 6" white pattern	roll
GT-27004	150 feet / 11" white x 7" red pattern	roll
GT-27005	150 feet all white tape	roll
GT-27006	150 feet all yellow tape	roll
GT-27007	150 feet all orange tape	roll



Plastic Reflective End Cap

- For use on all GT-27 Economy Brackets and many other brands
- Packaged set includes two reflective end caps and mudflap hardware

Part Number	Description	Cross Ref.
GT-27069	Plastic End Cap Packaged Set for GT-27 Economy Brackets	031-01269

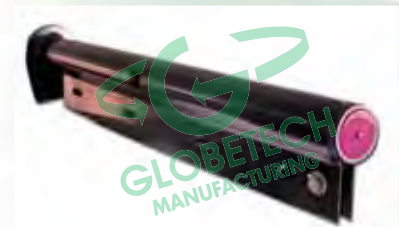
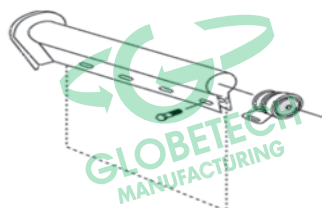



Economy Spring Loaded Brackets

Straight Tube Style Economy Bracket (replaces FB-27)

- Heavy-duty construction
- Design eliminates wind-caused bracket rotations
- Reduces flap and bracket damage
- Conforms to TTMA flap hole pattern
- Ideal for the heavy-duty spray suppression flaps

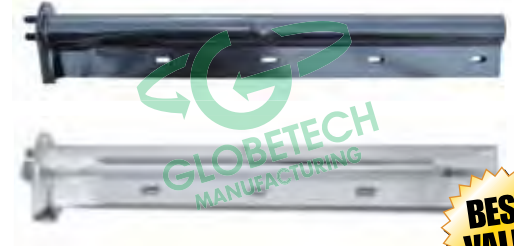

*Sets Include GT-27000
 • 12" x 2" Strip
 (2)ea / 6" red x 6" white pattern

Part Number	Description	Bolt Pattern	Replaces Fleet Engineers
GT-27270	28" Straight Arm Economy (Black E-Coat)-set	1.12"	033-00270
GT-27277	28" Straight Arm Economy (Stainless Steel)-set	1.12"	033-00277
GT-27868	30" Straight Arm Economy (Black E-Coat)-set	1.12"	033-00868
GT-27870	30" Straight Arm Economy (Stainless Steel)-set	1.12"	033-00870

Angled Down Tube Style Bracket (replaces FB-27)

- Heavy-duty steel construction
- Design eliminates wind-caused bracket rotations
- Reduces flap and bracket damage
- Conforms to TTMA flap hole pattern
- Ideal for the heavy-duty spray suppression flaps

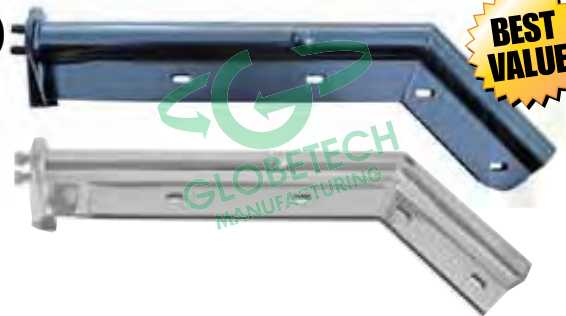

*Sets Include GT-27000
 • 12" x 2" Strip
 (2)ea / 6" red x 6" white pattern

Part Number	Description	Bolt Pattern	Replaces Fleet Engineers
GT-27864	27" Angled Down Economy (Black E-Coat)-set	1.12"	033-00864
GT-27865	27" Angled Down Economy (Stainless Steel)-set	1.12"	033-00865
GT-27404	30" Angled Down Economy (Black E-Coat)-set	1.12"	033-03404
GT-27150	30" Angled Down Economy (Stainless Steel)-set	1.12"	033-04150

Mudflaps & Accessories



Heavy Duty Spring Loaded Brackets

Straight Arm HD Bracket (replaces Betts B57)

- Springs allow bracket to flex for extra durability
- Absorbs vibration, resists flap snags
- Springs allow bracket to flex for extra durability
- Works with any standard 24" wide flap
- Sets Includes two hangers w/reflective tape, and hardware



Part Number	Description	Bolt Pattern	Replaces Betts
GT-27B5728	28" Straight Arm HD (Black E-Coat) -set	1.18"	B5728
GT-27B5728SS	28" Straight Arm HD (Stainless Steel)-set	1.18"	B5728S
GT-27B57	30" Straight Arm HD (Black E-Coat)-set	1.18"	B57
GT-27B57SS	30" Straight Arm HD (Stainless Steel)-set	1.18"	B57S



*Sets Include GT-27000
 • 12" x 2" Strip
 (2)ea / 6" red x 6" white pattern

Angled Down HD Bracket (replaces Betts B67 & B68)

- Downward angle allows for mounting in tight spaces
- Absorbs vibration, resists flap snags
- Springs allow bracket to flex for extra durability
- Works with any standard 24" wide flap
- Sets Includes two hangers w/reflective tape, and hardware



Part Number	Description	Bolt Pattern	Replaces Betts
GT-27B6728	28" Angled Down HD (Black E-Coat)-set	1.18"	B672825
GT-27B6728SS	28" Angled Down HD (Stainless Steel) -set	1.18"	B672825S
GT-27B6728C	28" Angled Down HD (Chrome)-set	1.18"	B672825C
GT-27B67	30" Angled Down HD (Black E-Coat)-set	1.18"	B67
GT-27B67SS	30" Angled Down HD (Stainless Steel) -set	1.18"	B67S
GT-27B67C	30" Angled Down HD (Chrome)-set	1.18"	B67C
GT-27B68	30" Angled Down HD (Black E-Coat)-set	2.5"	B68
GT-27B68SS	30" Angled Down HD (Stainless Steel)-set	2.5"	B68S
GT-27B68C	30" Angled Down HD (Chrome)-set	2.5"	B68C



*Sets Include GT-27000
 • 12" x 2" Strip
 (2)ea / 6" red x 6" white pattern



Heavy Duty Spring Loaded Brackets

Tapered Arm HD Bracket (replaces Betts B7 & B71)

- Springs allow bracket to flex for extra durability
- Tapered design is extremely strong & efficient
- Works with any standard 24" wide flap
- Conspicuity strip not included



Part Number	Description	Bolt Pattern	Replaces Betts
GT-27B71	30" Straight Arm HD Tapered(Black E-Coat)-set	1.18"	B71
GT-27B71SS	30" Straight Arm HD Tapered (Stainless Steel)-set	1.18"	B71S
GT-27B71C	30" Straight Arm HD Tapered (Chrome)-set	1.18"	B71C
GT-27B7	30" Straight Arm HD Tapered (Black E-Coat)-set	2.5"	B7
GT-27B7SS	30" Straight Arm HD Tapered (Stainless Steel)-set	2.5"	B7S
GT-27B7C	30" Straight Arm HD Tapered (Chrome)-set	2.5"	B7C

Mudflaps & Accessories



High Visibility Light Bars With 4" Round Lights

- Stainless steel construction for durability
- Each stainless bar has 3 Pearl LED round lights
- Standard pigtailed included for easy installation
- Each bar measures 30" L x 6" W x 2.25" D
- Standard manufacturer's warranty included

Part Number	Description	Cross Ref.
GT-27LT77S	L.E.D. Kit w/hardware, pair	LT77S



Quarter Fender Mounting Instructions

Recommended quarter fender mounting will result in maximum fender and top flap product life.

50-foot pounds of torque is needed on the steel clamp and 75-foot pounds of torque is needed on the stainless clamp. This torque is to be applied to the nut instead of the bolt. When this torque is applied, the flange end of the clamp should touch.

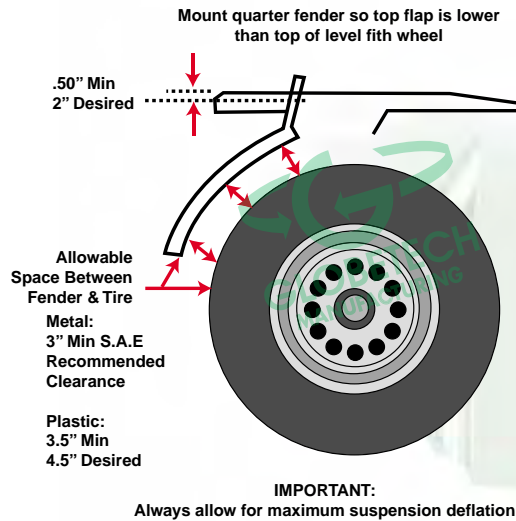

Braceless Standard Quarter Fender

- Durable 18 gauge formed metal
- Tube cradle support for added rigidity
- Mirror finish stainless steel
- Assembly required

Kit Includes:

- Two quarter fenders w/mounting hardware
- Two 24" rubber top flaps
- Top flap hardware
- Two clamps with 5/8" bolt and nut

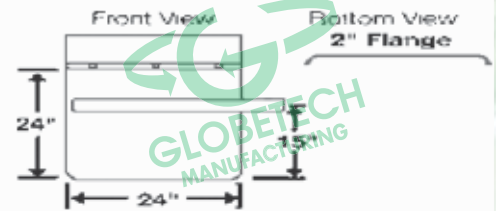

Part Number	Description	Replaces Fleetline	Weight
GT-39585B	Stainless Steel assembly, kit	1585B-Kit	29 lbs

Full Brace Standard Quarter Fender

- Durable 18 gauge formed metal
- Tube cradle support for added rigidity
- Mirror finish stainless steel
- Assembly required

Kit Includes:

- Two quarter fenders w/mounting hardware
- Two 24" rubber top flaps
- Top flap hardware
- Two clamps with 5/8" bolt and nut

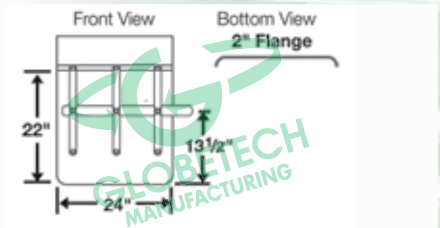

Part Number	Description	Replaces Fleetline	Weight
GT-39585FB	Stainless Steel assembly, kit	1585FB-Kit	32 lbs



Mudflaps & Accessories

Half Brace Standard Quarter Fender

- Durable 18 gauge formed metal
- Tube cradle support for added rigidity
- Assembly required
- Mirror finish stainless steel

Kit Includes:

- Two quarter fenders w/mounting hardware
- Two 24" rubber top flaps
- Top flap hardware
- Two clamps with 5/8" bolt and nut

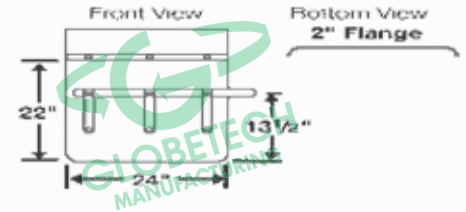

Part Number	Description	Replaces Fleetline	Weight
GT-39585HB	Stainless Steel assembly, kit	1585hB-Kit	30 lbs

Low Mount Standard Quarter Fender

- Durable 18 gauge formed metal
- Tube cradle support for added rigidity
- Mirror finish stainless steel
- Assembly required

Kit Includes:

- Two quarter fenders w/mounting hardware
- Two 24" rubber top flaps
- Top flap hardware
- Two clamps with 5/8" bolt and nut

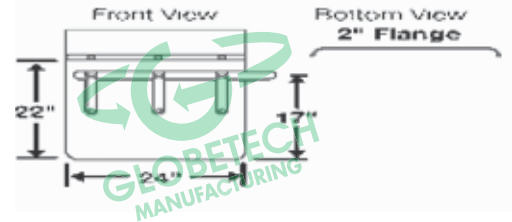

Part Number	Description	Replaces Fleetline	Weight
GT-39585LM	Stainless Steel assembly, kit	1585LM-Kit	29 lbs

Braceless Poly Quarter Fender

- Extreme Weather Polyethylene construction
- Guaranteed not to chip, crack or break
- Molded tube cradle for added rigidity
- Tested to -100°F without failure
- Assembly required

Kit Includes:

- Two quarter fenders w/mounting hardware
- Two 24" black poly top flaps
- Top flap hardware
- Two clamps with 5/8" bolt and nut

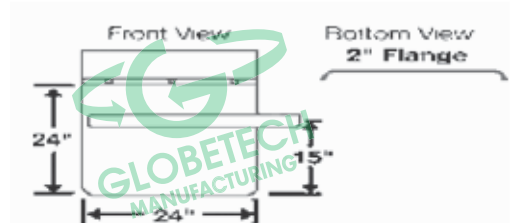

Part Number	Description	Replaces Fleetline	Weight
GT-3900-L	Black Poly assembly, Left	1900-L	10 lbs
GT-3900-R	Black Poly assembly, Right	1900-R	10 lbs
GT-3900	Black Poly assembly, Pair	1900-KIT	20 lbs

Mudflaps & Accessories



Quarter Fender Top Flaps

- Durable Black or White polyethylene and black rubber options
- Custom flaps available with company logo
- Top flap hardware not included



GT-2406

Part Number	Description	Weight
GT-2406	Black Rubber Plain, single	1.0 lbs.
2406PSB	Black Poly Plain, single	0.5 lbs.
2406PSW	White Poly Plain, single	0.5 lbs.

Top Flap Hardware

- For use with plain or custom logo flaps
- Available in stainless or zinc plated steel and black nylon
- Includes eight nuts, eight bolts, and eight washers in a Globetech bag



Part Number	Description	Weight
GT-39414	Zinc Plated Steel Hardware, packaged set	0.3 lbs.
GT-39415	Stainless Steel Hardware, packaged set	0.3 lbs.
GT-39416	Black Nylon Hardware, packaged set	0.2 lbs.



Quarter Fender Mount Tube

- Stainless Steel or Black E-Coat construction
- Must be used with post, side mount socket or 50" cross tube
- Includes 2" end cap
- Does not include clamp or hardware

Part Number	Description	Weight	Cross Ref.
GT-391625	27" Stainless steel pipe with end cap	2.5 lbs.	30 lbs
GT-391626	27" black E-Coat pipe with end cap	2.5 lbs.	30 lbs

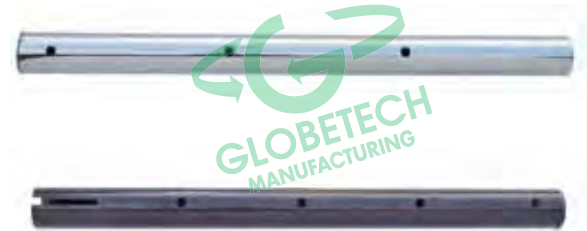

Quarter Fender End Caps

- Available in Stainless Steel or Black Plastic
- 2" Diameter

Part Number	Description	Weight	Cross Ref.
GT-391300	Stainless steel 2" end cap, (set)	.2 lbs.	1300-3A
GT-391301	black plastic 2" end cap, (set)	.2 lbs.	



*Sets packaged in Globetech bag

Quarter Fender Clamps

- Available in Stainless Steel or Black E-Coat
- Sets includes two clamps with 5/8" bolt/nuts

Part Number	Description	Weight	Cross Ref.
GT-391585	Stainless Steel 2" Fender Clamp w/hardware (set)	.5 lbs.	1585-8WHA
GT-391590	Black E-Coat 2" Fender Clamp w/hardware (set)	.2 lbs.	1590-8WHA



Mudflaps & Accessories



Post Mount Socket

- Cast steel construction Black primer finish
- For independent post mounting
- Bolts directly to frame or suspension using present vehicle hardware
- 8.00" for added strength and durability



Part Number	Description	Weight	Cross Ref.
GT-391600	8" Stub Post Mount, single	3 lbs.	1600-15M

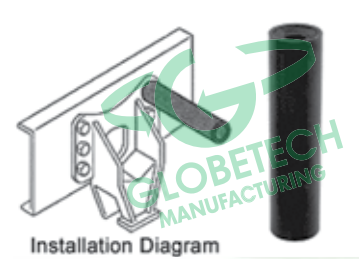

Post Mount Socket With Flange

- Steel construction Black E-Coat finish
- For independent side mounting
- Bolts directly to frame using present vehicle hardware
- Mounting plate 3.75" x 3.75"

Part Number	Description	Weight	Cross Ref.
GT-391601	8" Stub Post Mount with Flange, single	6 lbs.	1600-11M



Cross-Mount Tube Kit

- Steel construction Black primer finish
- For heavy-duty, over-the-frame mounting 50.00" long for added strength and durability
- Bulk kit contains one cross mount tube and all mounting hardware
- Hardware packaged set consists of mounting brackets , u-bolts, and nuts

Part Number	Description	Bar Length	Cross Ref.
GT-395000	50.00" Cross Mount Kit, including U-bolt Clamp Assembly	50.00"	555000



Cross-Mount Tube Hardware

- Two U-Bolts with brackets
- Four nuts
- Four washers

Part Number	Description	Weight	Cross Ref.
GT-395001	U-bolt Clamp Assembly Kit	1 lbs.	1580-12





QUICK REFERENCE GUIDE

Standard .640 Bar



GT-2723B



GT-2725B



GT-2733B



GT-2735B



GT-2729B

Conspicuity Strips



GT-27RT25



GT-27RT35

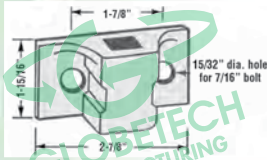

GT-27B711

Plastic Reflective End Cap



GT-27069

Anti-Sail Bracket

GT-2701SS



BULK DISPLAYS



GT-2725B70

GT-2735B40

Spring Loaded



GT-27270



GT-27865



GT-27B6728



GT-27B57SS



GT-27B68



GT-27B7SS

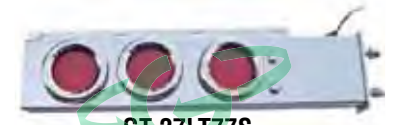

GT-27LT77S



GT-27516

Hardware Kit



GT-27516

GT-391600

Stub Mount

GT-3900

GT-39585B

GT-39585FB

Mudflaps & Accessories



ABS Cable

THE FAT CABLE

- More Copper
- More Tubing

EXCEEDS SAE J2222 Standard

Sealed Screw

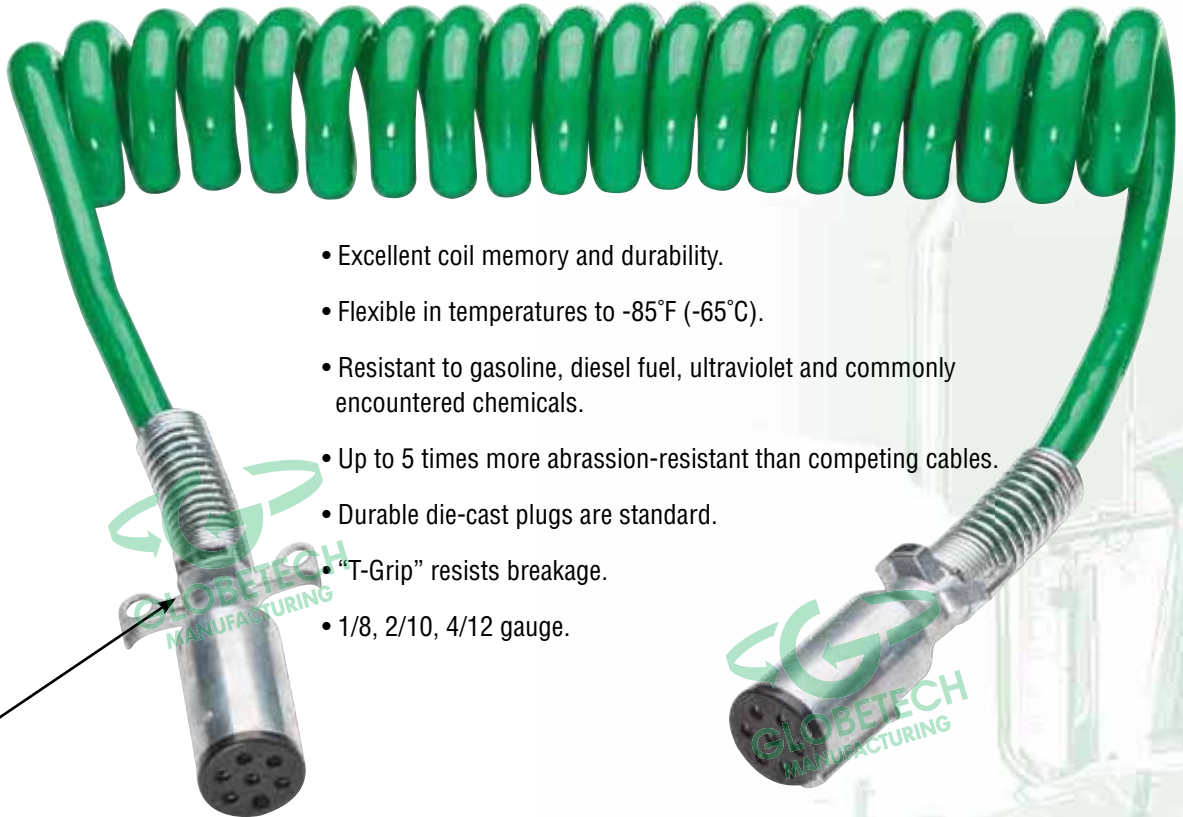

- Excellent coil memory and durability.
- Flexible in temperatures to -85°F (-65°C).
- Resistant to gasoline, diesel fuel, ultraviolet and commonly encountered chemicals.
- Up to 5 times more abrasion-resistant than competing cables.
- Durable die-cast plugs are standard.
- "T-Grip" resists breakage.
- 1/8, 2/10, 4/12 gauge.

ABS Coil Assemblies 1/8, 2/10, 4/12 Gauge

Part Number	Length	Description	Replaces Tectran	Replaces Sloan
GT-3300	12'	2 x 12" Lead	7ATG222MG	590160
GT-3301	15'	2 x 12" Lead	7ATG522MG	590161
GT-3302	15'	1-12" Lead	7ATG542MG	590163
		1-40" Lead		
GT-3303	20'	2 x 12" Lead	7ATG6222MG	590080
GT-3304	20'	1-12" Lead	7ATG642MW	590081
		1-40" Lead		

ABS Straight Assemblies 1/8, 2/10, 4/12 Gauge

Part Number	Length	Replaces Tectran	Replaces Sloan
GT-3306	12'	7AAB122MG	421166
GT-3307	15'	7AAB152MG	421167
GT-3308	20'	7AAB202MG	421247





Standard Duty Cables Non ABS Seven-Way Straight Cable Assemblies

GT-3310 – Non ABS

- 15/ft. Long 12” standard lead
- Flexible from - 60°F to 150°F
- Metal zinc connectors **6/14 - 1/12”** gauge



Part Number	Length	Description	Replaces Tectran	Replaces Sloan
GT-3309	12”	2 x 12” Lead	7ETB222MG	421010
GT-3310	15”	2 x 12” Lead	7ETB522MG	42113
GT-3311	15”	1-12” Lead 1-48” Lead	7ETB542MG	421180

- All length and leads are available upon request.

Standard Duty Cables Non ABS Seven-Way Straight Assemblies

- Heavy-Duty zinc die cast plugs with spring guards included. **6/14 - 1/12”** gauge

Part Number	Length	Replaces Tectran	Replaces Sloan
GT-3315	12”	7SAB122MG	421164
GT-3316	15”	7SAB152MG	421165

- All length and leads are available upon request.





Six-Way Coiled Cable Assembly

- 12' working length
- Durable black outer jacket resists abrasion and has excellent coil memory.
- Heavy-Duty zinc die cast plugs with spring guards included.

Part No.	Length	Description	Replaces Tectran	Replaces Sloan
GT-3317	12"	6 Conductor / 14 gauge	7R6122M	421165



Single Pole Coiled Assembly

For applications where cables are used to charge trailer lift gate batteries.

Jacket Color: Green

- 200 amp max for international lift gate applications at 12 VDC
- 110 amp max for continuous applications at 12 VDC
- Heavy-Duty zinc die cast plugs with spring guards included
- External ground option
- 4 gauge cable

Part No.	Length	Description	Replaces Tectran	Replaces Sloan
GT-3324	12"	Tailgate lift battery, 4 gauge	7BTG222MG	421145
GT-3325	15"	Tailgate lift battery, 4 gauge	7BTG522MG	421146

Two Pole Coiled Assembly

- Rated at 200 amps for lift gate applications at 12 VDC
- 4 gauge cable
- Internally grounded
- Withstand temperatures of -85° to + 185° F
- Durable black polyethylene outer jacket resists abrasions and chemical damage while offering excellent coil retention
- Heavy-Duty zinc die cast plugs with spring guards included

Part No.	Length	Description	Replaces Tectran	Replaces Sloan
GT-3326	12"	Two pole, 4 gauge	7DTB222MW	421172
GT-3327	15"	Two pole, 4 gauge	7DTB522MW	421173



Plugs



GT-3001



GT-3001G



GT-3002



GT-3004



GT-3005



GT-3006A



GT-3007B



GT-3007D



GT-3007Y

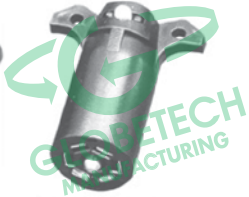

GT-3007YD

A = no spring B = with spring D = blade G = ground kit Y = plastic

Part Number	Description	Replaces Phillips	Replaces Sloan
GT-3001	1-pole plug w/spring, double grip, die cast	15-335	--
GT-3001G	1-pole plug w/spring & ground kit, double grip, die cast	15-335	--
GT-3002	2- pole plug w/spring, double grip, die cast	15-336	--
GT-3004	4-pole plug w/spring, die cast	15-430	421131
GT-3005	5-pole plug, die cast housing, chrome-plated		421133
GT-3006A	6-pole plug, no spring, die cast	15-610	421135
GT-3006B	6-pole plug w/spring, die cast	15-630	421122
GT-3007A	7-pole plug, no spring, die cast	15-710	421000
GT-3007B	7-pole plug w/spring, die cast	15-730	421001
GT-3007D	7-pole plug, blade style, car end only housing & cover (zinc)	16-713	--
GT-3007E	7-pole plug w/spring, economy, die cast	15-730	4210 01
GT-3007Y	7-pole plug, nylon	--	421147
GT-3007YD	7-pole plug, blade style, car end only ABS housing (plastic)	16-714	--



Sockets



GT-3010G



GT-3012



GT-3014



GT-3015



GT-3016

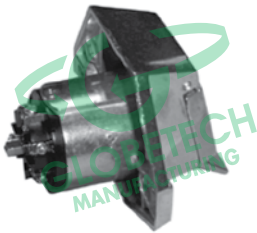

GT-3227



GT-3227D



GT-3227MZ



GT-3227YD

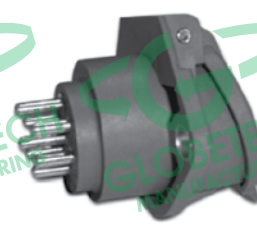

GT-3338



GT-3338K

A = no spring B = with spring D = blade G = ground kit Y = plastic

Part Number	Description	Replaces Phillips No.	Replaces Sloan
GT-3010	single pole socket, die cast	15-320	421126
GT-3010G	single pole socket w/ground kit, die cast	15-320	--
GT-3012	dual pole socket, die cast	15-326	421171
GT-3014	4-pole socket, split pin, die cast	15-400	421132
GT-3015	5-pole socket, die cast housing, chrome-plated	--	421134
GT-3016	6-pole socket, split pin, die cast	15-600	421136
GT-3227	7-pole socket, Pollack style, die cast	15-720	421015
GT-3227D	7-pole socket, blade style, car end only housing & cover (zinc)	16-714	--
GT-3227MB	bracket for 7-pole connector, black E-coated	15-788	--
GT-3227MZ	bracket for 7-pole connector, zinc-plated	15-788	--
GT-3227E	7-pole socket, economy style, die cast	15-720	421015
GT-3227SP	7-pole socket, solid pin, die cast	15-721	421124
GT-3227YD	7-pole socket, blade style, car end only ABS housing & cover (plastic)	16-713	--
GT-3337	7-way base, solid diecast EZ-7 style		--
GT-3338	7-way nylon socket w/gasket split pin	(Replaces Tramec 38502W)	
GT-3338G	gasket only, for GT-3338 socket		
GT-3338K	lid kit for GT-3338 socket nylon	(Replaces Tramec 38502W)	

all references to competitors' part numbers are for cross reference purposes only



Connectors and Junction Boxes



GT-3612



GT-3613



GT-3614



GT-3614-2

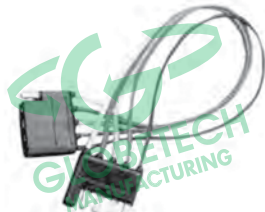

GT-3615



GT-3616



GT-3624

Part Number	Description
GT-3612	2-pole flat connector, 18G wire, 12" loop
GT-3613	3-pole flat connector, 18G wire, 12" loop
GT-3614	4-pole flat connector, 18G bonded wire, 12" loop
GT-3614-2	4-pole flat connector, 18G wire, 24" loop
GT-3624	4-pole flat connector, 18G bonded wire, 12" loop, shrouded
GT-3615	5-pole flat connector, 18G bonded wire, 12" loop
GT-3616	6-pole square connector, 18G wire, 12" loop, shrouded

Electrical Junction Box

7- way Junction Box

- Box is made of high impact black UV resistant ABS plastic
- Sealing surface of lid has a unique V groove to help prohibit moisture entry
- Seven #10-32 studs supplied with nuts and lock washers
- Supplied with five grommets and two strain relief clamps
- Mounting hole centers - 7 3/8"
- Terminal connectors are coded for easy identification
- Kit includes both open and closed grommets, star washers and nuts.



Part Number	Description	Replaces Tectran
GT-3100	Standard junction box	667-7040
GT-3101	Junction box with bracket	667-7050

Electrical



Adapters and Protector Boots



GT-3604YD



GT-3607



GT-3706



GT-3707YD



GT-3704YD



GT-3714



GT-3715



GT-3715W

D = Blade Y = Plastic

Part Number	Description
GT-3604YD	6 to 4 way adapter, 6-way pole to 4-way flat, plastic
GT-3607	6 to 7 way adapter
GT-3704YD	7 to 4 way adapter, flat style, 7 pole round to 4 pole flat, plastic
GT-3706	7 to 6 way adapter
GT-3707YD	7 to 7 way adapter, 7 way pole to 7 way blade, plastic
GT-3714	7 to 4 way adapter, 7 way round to 4 way flat inline female w/cover
GT-3715	7 to 5 way adapter, 7 way blade to 5 way flat inline female
GT-3715W	7 to 5 way adapter, 7 way blade to 5 way flat inline female 2 ft wire



GT-3200



GT-3202

Part Number	Description	Replaces Phillips
GT-3200	Electrical plug protector boot fits GT-3227, GT-3227E, and GT-3227SP	15-740
GT-3202	Electrical socket protector boot 2" x 3" hole mount	

Electrical



Rubber Cushion Clamp



Part Number	Width	Clamping DIA.	Screw Size	Replaces Phillips
GT-35044	1/2"	1/4"	1/4"	5-45044
GT-35064	1/2"	3/8"	1/4"	5-45064
GT-35084	1/2"	1/2"	1/4"	5-45084
GT-35104	1/2"	5/8"	1/4"	5-45104
GT-35124	1/2"	3/4"	1/4"	5-45124
GT-35154	1/2"	1"	1/4"	5-45164
GT-36044	5/8"	1/4"	3/8"	5-46044
GT-36064	5/8"	3/8"	3/8"	5-46064
GT-36084	5/8"	1/2"	3/8"	5-46084
GT-36104	5/8"	5/8"	3/8"	5-46104
GT-36124	5/8"	3/4"	3/8"	5-46124
GT-36164	5/8"	1"	3/8"	5-46164
GT-36241	5/8"	1-1/4"	3/8"	5-46241
GT-36271	5/8"	1-1/2"	3/8"	5-46271
GT-36281	5/8"	2"	3/8"	5-46281
GT-36291	5/8"	2-1/2"	3/8"	5-46291
GT-36301	5/8"	3"	3/8"	5-46301
GT-36302	5/8"	4"	3/8"	--
GT-36304	5/8"	5"	3/8"	--

Wire Clip

Plastisol dipped coating



Part Number	Description	Replaces Wabash
GT-3402	Small Wire Clip	2120046
GT-3403	Large wire clip	2120005

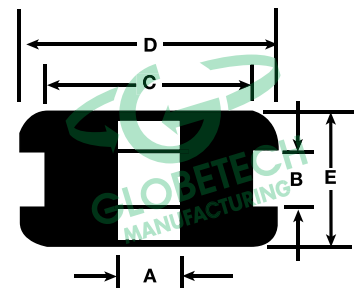

Rubber Grommet



Part No.	A Inside Diameter	B Groove Width	C Drill Diameter	D Outside Diameter	E Overall Thickness
GT-7710	5/16"	1/16"	7/16"	9/16"	3/16"
GT-7711	1/2"	1/4"	1"	1-3/8"	1/2"
GT-7712	3/5"	1/8"	24/25"	1-1/4"	6/16"
GT-7713	21/29"	1/5"	1-3/16"	1-3/4"	1/2"



Electrical Connectors

Zinc Die-Cast Deep Nosebox

- 55% more interior space than the GT-3203.
- Larger interior space allows for easier access & maintenance.
- 3-1/8" deep.
- Fits 15 series and 16 series socketbreakers.
- Standard hole pattern.
- Kit includes gasket, grommet and socketbreaker mounting hardware.
- Does not include nosebox mounting hardware.



GT-3204 Deep Nosebox kit

Part Number	Description	Replaces Phillips
GT-3203	Zinc die-cast nosebox kit	15-769
GT-3203-G	Gasket for nosebox	15-767
GT-3203-D	Grommet for nosebox	15-765
GT-3204	Zinc die-cast deep nosebox kit	15-775
GT-3204-G	Gasket for deep nosebox	--
GT-3204-D	Double grommet for deep nosebox	--
GT-3017-G	Gasket for socketbreaker	15-766

GT-3203 Standard Nosebox

- 1 7/8" deep.
- For use with 15 series or 16 series socketbreakers.
- Kit includes gasket, grommet and socketbreaker mounting hardware.
- Does not include nosebox mounting hardware.



GT-3204-D
Double Grommet



GT-3203
Standard Nose Box Kit

Zinc Die-Cast 7-Way Socketbreakers

- Heavy-Duty die-cast material.
- 2 Hole mount with gasket included.
- 7 pole, split-pin with a full-open lid.
- Available with metal or nylon circuit breakers.



GT-3017-G

Part Number	Description	Replaces Grote	Pack Size
GT-3017-15	15 amp, metal breakers, split pin	82-0854	1
GT-3017-20	20 amp, metal breakers, split pin	82-0855	1
GT-3017-20K	20 amp, metal breakers, split pin, with nosebox & gasket	82-0850	1 (kit)
GT-3017-30	30 amp, metal breakers, split pin	82-0856	1
GT-3017-15P	15 amp nylon breakers, split pin	--	1
GT-3017-20P	20 amp, nylon breakers, split pin	82-0857	1
GT-3017-30P	30 amp, nylon breakers, split pin	82-0858	1
GT-3017-	No circuit breakers, split pin	82-0853	1



BACK



FRONT



Circuit Breakers and Switches

Circuit Breakers

Part Number	Description	Replaces Tectran	
GT-3550	15 amp circuit breaker metal	660-15	Metal
GT-3551	20 amp circuit breaker metal	660-20	
GT-3552	25 amp circuit breaker metal	660-25	
GT-3553	30 amp circuit breaker metal	660-30	
GT-3550P	15 amp circuit breaker plastic	661-15	Plastic
GT-3551P	20 amp circuit breaker plastic	661-20	
GT-3552P	25 amp circuit breaker plastic	661-25	
GT-3553P	30 amp circuit breaker plastic	661-30	



Ground Kits

Part Number	Description
GT-3400	Ground kit

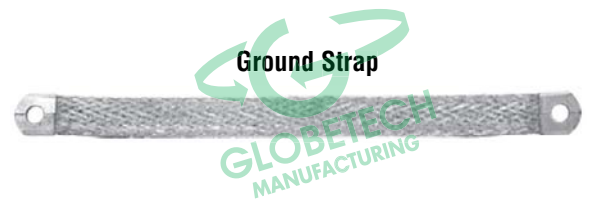

Part Number	Description
GT-3401	Ground strap, 12" 4 ga

Brush Kit

GT-3201

Male & Female
Cleaning kit for 7-way plugs and sockets

Replaces: Tectran 5031





Copper Lugs



- Flared opening for ease of entry
- Crimp or solder flexibility
- One-piece seamless construction
- Non-plated, straight mount

Part Number	Gauge	Stud Size	Replaces Phillips
GT-3500	8	1/4"	8-2101
GT-3501	8	5/16"	8-2102
GT-3502	6	1/4"	8-2111
GT-3503	6	5/16"	8-2112
GT-3504	4	1/4"	8-2121
GT-3505	4	5/16"	8-2122
GT-3506	4	3/8"	8-2123
GT-3507	2	1/4"	8-2131
GT-3508	2	5/16"	8-2132
GT-3509	2	3/8"	8-2133
GT-3510	2	1/2"	8-2135

Part Number	Gauge	Stud Size	Replaces Phillips
GT-3511	1	1/4"	8-2141
GT-3512	1	5/16"	8-2142
GT-3513	1	3/8"	8-2143
GT-3514	1	1/2"	8-2145
GT-3515	4/0	3/8"	8-2183
GT-3516	4/0	1/2"	8-2185
GT-3517	3/0	5/16"	8-2172
GT-3518	3/0	3/8"	8-2173
GT-3519	3/0	1/2"	8-2175
GT-3520	2/0	3/8"	8-2163
GT-3521	2/0	1/2"	8-2165
GT-3522	1/0	5/16"	8-2152
GT-3523	1/0	3/8"	8-2153
GT-3524	1/0	1/2"	8-2155

Poly Split Looms



100 Foot Rolls

Part Number	Description
GT-3801	1/4"
GT-3802	3/8"
GT-3803	3/8"
GT-3803-R	red, 1/2"
GT-3803-G	gray, 1/2"
GT-3804	5/8"

Part Number	Description
GT-3805	3/4"
GT-3806	1"
GT-3807	1-1/4"
GT-3808	1-1/2"
GT-3809	1-7/8"
GT-3810	2"



Rubber Tractor Lamps

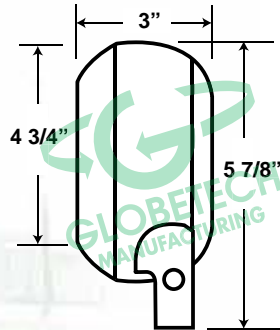

- 4-3/8" round housing with swivel base
- Sealed beam
- Par 36
- 12v 55w halogen bulb

Part Number	Description	Replaces
GT-7450	Rubber tractor lamp	TL80360

License Plate Lights

Part Number	Description	Replaces
GT-7460	License plate light, zinc-plated	TL26330
GT-7461	License plate light, chrome-plated	





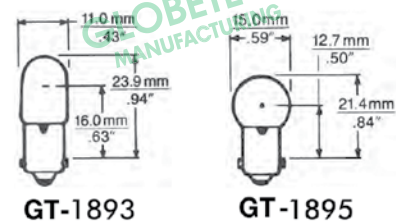
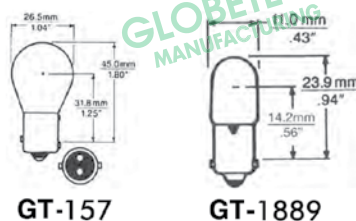
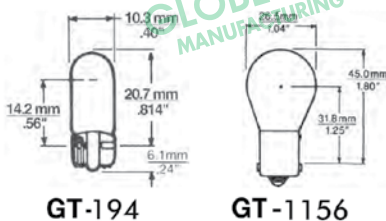
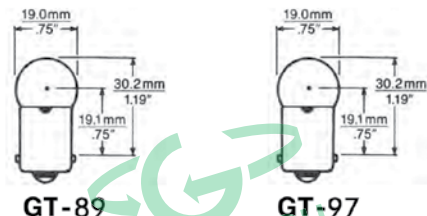
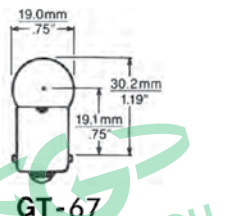
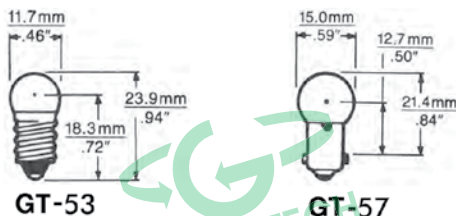



Mini Lamps - 10 per box





GT-4009 Series Hub Caps 380 Aluminum Alloy

G - Dirt exclusion grease hub cap
S - Side fill for oil
H- Hubodometer with side fill
K- Includes gasket

Part Number	Size	Gasket	Window Kit	Replaces	
 GT-4009 Standard hub cap without side fill *Does not Include gasket  GT-4009K Standard hub cap without side fill *Includes gasket	<ul style="list-style-type: none"> • NO. Bolts 6 • Bolt Circle: 5.5" • Bolt Size: 5/16" • Overall Depth: 2-11/16" • Inside Depth: 1-15/16" • Flange I.D.: 4-3/8" • Flange O.D.: 6-1/4" 	GT-4006	GT-4003	STEMCO 340-4009	
 GT-4009G Dirt exclusion grease hub cap *Does not include gasket					STEMCO 342-4009
 GT-4009S Standard hub cap with side fill *Does not include gasket  GT-4009SK Standard hub cap with side fill *Includes Gasket				STEMCO 343-4009	
 GT-4009H Hubodometer hub cap with side fill *Does not include gasket					

Test Procedure: Sample preparation and chemical analysis were conducted in accordance with standard laboratory procedures. Hardness testing was conducted in accordance with ASTM E18-03.

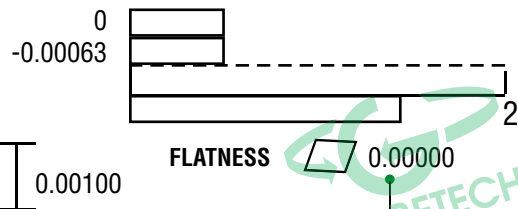

All Globtech Hub Caps
test less than .002
flatness

Test Results:

Chemical Analysis (percentage)	
Manganese	0.16
Silicon	8.68
Nickel	0.08
Chromium	0.04
Copper	3.06
Aluminum	0.04
Magnesium	0.07
Iron	1.06
Titanium	0.03
Zinc	1.18
Tin	0.02
Material Included:	380 Aluminum Alloy
Mechanical Properties	
Hardness	HRB 45



Globetech's standard hub caps are die-cast from a 380 aluminum alloy. They resist cracking, warping and breaking in any conditions.



- Each hub cap is individually poly-bagged.
- Vent plug is molded in a nitrile rubber.
- Dow Corning CALIBRE lens, UV-stabilized.

G - Dirt exclusion grease hub cap

S - Side fill for oil

H- Hubodometer with side fill

K- Includes gasket

Part Number		Size	Gasket	Window Kit	Replaces
 GT-4007F	GT-4007 Stamped Steel without filler vent	<ul style="list-style-type: none"> • NO. Bolts: 6 • Bolt Circle: 4.5" • Bolt Size: 5/16" • Overall Depth: 2 • Inside Depth: 1-15/16" • Flange I.D.: 3-5/16" • Flange O.D.: 5-3/16" 	GT-4006	N/A	STEMCO 340-5097
	GT-4007F Stamped Steel with filler vent				STEMCO 340-5096
Part Number		Size	Gasket	Window Kit	Replaces
 GT-4013	GT-4013 Hub cap without side fill *Does not include gasket	<ul style="list-style-type: none"> • NO. Bolts 5 • Bolt Circle: 5.5" • Bolt Size: 5/16" • Overall Depth: 2-11/16" • Inside Depth: 1-15/16" • Flange I.D. : 4-3/8" • Flange O.D.: 6-1/4" 	GT-4004	GT-4003	STEMCO 340-4013
Part Number		Size	Gasket	Window Kit	Replaces
 GT-4024	GT-4024 Hub cap without side fill *Does not include gasket	<ul style="list-style-type: none"> • NO. Bolts: 6 • Bolt Circle: 4.5" • Bolt Size: 5/16" • Overall Depth: 2-5/8" • Inside Depth: 1-7/8" • Flange I.D.: 3-1/2" • Flange O.D.: 5-1/4" 	GT-4025	GT-4005	STEMCO 340-4024
	GT-4024S Hub cap with side fill *Does not include gasket			GT-4005	STEMCO 343-4024
Part Number		Size	Gasket	Window Kit	Replaces
 GT-4195	GT-4195 Hub cap without side fill *Does not include gasket	<ul style="list-style-type: none"> • NO. Bolts: 6 • Bolt Circle: 6.75" • Bolt Size: 5/16" • Overall Depth: 3-11/16" • Inside Depth: 2-15/16" • Flange I.D.: 5-7/16" • Flange O.D.: 7-1/2" 	GT-4008	GT-4003	STEMCO 340-4195
	GT-4195G Dirt exclusion grease hub cap *Does not include gasket			GT-4000	STEMCO 342-4195
	GT-4195S Hub cap with side fill *Does not include gasket			GT-4003	STEMCO 343-4195
	GT-4195H Hubodometer hub cap with side fill *Does not include gasket			GT-4002	STEMCO 347-4195

Wheel End



Part Number		Size	Gasket	Window Kit	Replaces
 GT-4249S	GT-4249S Hub Cap with side fill, 4-3/8" Window *Does not include gasket	<ul style="list-style-type: none"> • NO. Bolts 6 • Bolt Circle: 5.5" • Bolt Size: 5/16" • Overall Depth: 1-13/16" • Inside Depth: 1-11/16" • Flange I.D.: 4-7/16" • Flange O.D.: 6-3/16" 	GT-4006	GT-4912	STEMCO 343-4249
Part Number		Size	Gasket	Window Kit	Replaces
 GT-4095S	GT-4095 Hub cap with out side fill *Does not include gasket	<ul style="list-style-type: none"> • NO. Bolts 6 • Bolt Circle: 5.5 • Bolt Size: 5/16 • Overall Depth: 1-13/16" • Inside Depth: 1-1/16" • Flange I.D.: 4-9/16" • Flange O.D.: 6-3/16" 	GT-4006	GT-4003	STEMCO 340-4095
	GT-4095S Hub cap with side fill *Does not include gasket				STEMCO 343-4095
Part Number		Size	Gasket	Window Kit	Replaces
 GT-4075	GT-4075 Hub cap with out side fill *Does not include gasket	<ul style="list-style-type: none"> • Bolt Circle: 6-1/4" x 8 UN (M) • Bolt Size: 5/16" • Overall Depth: 2-5/16" • Inside Depth: 1-9/16" • Flange I.D.: 5-3/4" • Flange O.D.: 6-7/8" 	GT-4021	GT-4003	STEMCO 340-4075
Part Number		Size	Gasket	Window Kit	Replaces
 GT-4640	GT-4640 Lexan hub cap	<ul style="list-style-type: none"> • NO. Bolts 6 • Bolt Circle: 5.5" • Bolt Size: 5/16" • Overall Depth: 2-11/16" • Inside Depth: 1-15/16" • Flange I.D.: 4-3/8" • Flange O.D.: 6-1/4" 	GT-4006	N/A	Sirco 9018
	GT-4640H Lexan hubodometer hub cap				Stemco 640-0001 Sirco 9020
Part Number		Size	Bolt Circle Dia.		Replaces
 GT-4065	GT-4065 Hubodometer Bracket	Fits over all hubcaps ending in 4009 <ul style="list-style-type: none"> • Stud Size 5/16" - 18 Thread • Height 3 1/2" 	5-1/2"		Stemco 610-0065
Part Number		Size	Bolt Circle Dia.		Replaces
 GT-4084	GT-4084 Hubodometer Bracket	Fits PSI Hubcap and 4195 <ul style="list-style-type: none"> • Stud Size 5/16" • Height 5" 	6-3/4"		Stemco 610-0084



Pro Par Style Caps



Non Vented

GT-4020B	Specifications	Interchanges
Hub Cap For Fruehauf Propar Includes: Center plug O-Ring	Thread 6/1/4" Size 8 Material: Polycarbonate Replaces Fruehauf ACC-7538-900	Batco 11-0670 BWP M-1052 Euclid E-04075 Leland L-885 Meritor R004075 Sirco 9013 Spicer 8-295 Stemco 340-4975



Vented

GT-4020	Specifications	Interchanges
Hub Cap Vented For Fruehauf Propar Includes: Vented plug O-Ring	Thread 6/1/4" Size 8 Material: Polycarbonate Replaces Fruehauf ACC-7538-900	Euclid E-04075V



Hubodometer

GT-4020H	Specifications	Interchanges
Hub Cap Hubodometer Version For Fruehauf Propar Includes: Side fill plug O-Ring	Thread 6/1/4" Size 8 Material: Polycarbonate Replaces Fruehauf ACC-6113-900	Batco 11-0671 BWP M-2764 Euclid E-04075H Sirco 9015 Spicer 8-295H Stemco 640-0003

Wheel End



Window Kits



Part Number	Description	Replaces
GT-4003	3-1/2" window Dia.	Batco 11-0675 Stemco 359-5995
GT-4005	2-3/4" window Dia.	Stemco 359-5999
GT-4002	Hubo window for 4009 Series	359-6117
GT-4000	Grease cap window	359-6095
GT-4912	4-3/8" window Dia.	359-5912



Part Number	Description	Replaces
GT-4021	O-Ring Use with GT-4020 & GT-4075 6" O.D. 5-1/2" I.D.	Batco 11-0680 BWP M-1065 Euclid E-05500 Leland L-1700 Meritor Roo5500 Spicer 8-29F Stemco 330-3077

Plugs

↑
.70"
↓



Propar Style

↑
1"
↓



Part Number	Description	Replaces
GT-4001	GT-4001 Vented	359-5990
GT-4001 B	GT-4001B Non Vented	
GT-4014	GT-4014 Vented	BWP M-1066
GT-4014B	GT-4014B Non Vented	Euclid E-04000 E-04000V Sirco B-9015 B-9015V



Gaskets



Part Number	Size	Replaces
GT-4025 Use with 4024 series Hub Caps	6 - Hole Small Gasket 4-1/2" B.C.	Batco 13-7156 BWP Euclid Leland Meritor Spicer Stemco 330-3024



Part Number	Size	Replaces
GT-4006 Use with 4009, 4098, 4095 series Hub Caps	6 - Hole 6-13/16" O.D. 4-5/16" I.D. 5-1/2" B.C.	Batco 13-7151B BWP M-2768 Euclid Leland L-453 Meritor Spicer 8-304 Stemco 330-3009



Part Number	Size	Replaces
GT-4004 Universal	12 - Hole 3, 5, 6, Hole 6-3/8" O.D. 4-7/16" I.D. 5-1/2" B.C.	Batco 13-7150B BWP M-837 Euclid E-03009 Leland Meritor Spicer Stemco 330-3067



Part Number	Size	Replaces
GT-4008 TP Axle Gasket Use with 4195 Hubcap	6 - Hole 7-1/2" O.D. 5-7/16" I.D. 6-3/4" B.C.	Batco BWP Euclid Leland Meritor Stemco 330-3118 Wabaash 10600483

Description: GT-8011 is a low density cellulose fiber material with high rubber filler content and a nitrile butadiene rubber binder. It provides excellent sealing of oil and water at low flange pressures, and is used primarily for engine and transmission pan gaskets, water pumps, and environmental seals. It is intended for applications with short duration maximum temperatures up to 180°C (350°F). GT-8011 has UL component recognition.

Density, g/cc(lb/cu.ft)	0.61 (38) (min.)	ASTM F 1315
Compressibility, % (at 6.9MPa)	35 - 60	ASTM F 36
Recovery, %	15 (min.)	ASTM F 36
Tensile Strength, AMD, MPa (psi)	1.52 (220) (min.)	ASTM F 152
Fluid Resistance, IRM903 Oil		ASTM F 146
Change in Weight, %	120 (max.)	
Fluid Resistance, Fuel B		ASTM F 146
Change in weight, %	120 (max.)	
Fluid Resistance, Distilled Water		ASTM F 146
Change in Weight, %	45 (max.)	
Binder Type	Nitrile Butadiene	



TEMPBOLT™ Patented

Avoid expensive bearing failures, unscheduled down time, costly road service calls and missed delivery appointments. Install the new **Globetech TempBolt™** in the hubcaps of your tractors and trailers today.

A **Globetech TempBolt™** installed in your hubcap can warn you of pending bearing problems. The TempBolt's visual red indicator pops out if the hub temperature reaches or exceeds 250° F. Only one **TempBolt™** is needed for each hubcap. This product is not a replacement for a rigorous hub preventive maintenance program.

- Tested and Approved by the TRUCK OEM Technical Center
- Several brake drag-tests were conducted to test drum temperature effect on the TempBolt™. The TempBolt™ did not activate due to high drum temperature. Only when the HUB exceeds 250° F does it activate.
- Anytime the oil temperature is consistently over 300° F, bearing failure can occur. At this temperature the oil will lose its lubricity causing the bearings to create more heat and eventually fail.
 - With the activation temperature set at 250° F, the **TempBolt™** warns you BEFORE a failure occurs.
 - In a typical operation, hub oil temperature runs between 150-200° F.
 - The **Globetech TempBolt™** can be used in any hub (tractor or trailer) that has a 5/16" diameter hubcap bolt.
 - When installing, do not exceed 14 ft. lbs. torque.

The **Globetech TempBolt™** is available in a "point-of-purchase" display box, containing 50 individual bags of 4 bolts. Encourage your customers to make it part of their preventative maintenance program.

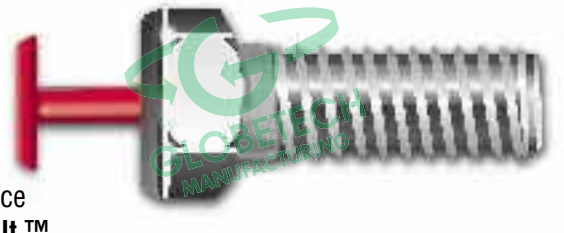

GT-7600 BLK (Bulk)



GT-7600 (Single pkg.)



GT-7600B – (Tempbolt display Kit)
(incl. 50 pkg.)



Wheel Parts Inner/Outer Nuts



Inner Nut

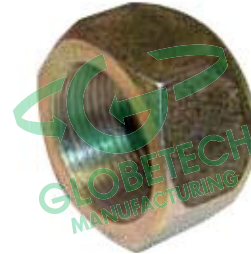

Outer Nut

	Part Number	Dayton Batco	BWP	Euclid	Sirco	Description	Plating
I N N E R	GT-4E5988L	13-3026L	M-2401	E5988L	98AL	For dual mounted aluminum wheels Outer thread 1 1/8" - 16 Inner thread 3/4" - 16 inner thread min. depth 1 15/16" Outer overall length 3 1/16"	Zinc Clear
	GT-4E5988R	13-3026R	M-2400	E5988R	988AR		
	GT-4E7895L	13-3005L	M-129	E7895L	709AL	For dual mounted steel & aluminum wheels Outer thread 1 1/8" - 16 Inner thread 3/4" - 16 inner thread min. depth 1 1/4" Outer overall length 2 7/32"	All Zinc Yellow
	GT-4E7895R	13-3005R	M-128	E7895R	708AR		
	GT-4E7896L	13-3028L	M-131	E7896L	896L	For dual mounted steel & aluminum wheels Outer thread 1 1/8" - 16 Inner thread 3/4" - 16 inner thread min. depth 1 1/4" Outer overall length 2 9/16"	
	GT-4E7896R	13-3028R	M-130	E7896R	896R		
	GT-4E5568L	13-3029L	M-133	E5568L	897L	For dual mounted steel & aluminum wheels Outer thread 1 1/8" - 16 Inner thread 3/4" - 16 inner thread min. depth 1 7/8" Outer overall length 3 1/16"	
	GT-4E5568R	13-3029R	M-132	E5568R	897R		
O U T E R	GT-4E5977L	13-3012L	M-127	E5977L	892AL	Left and right outer nuts for all part numbers listed.	
	GT-4E5977R	13-3012R	M-126	E5977R	891AR		



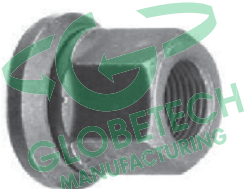

Two Piece Metric Nut



GT-46000A

Description	THRD	HEX	High	Replaces
Metric 2-Piece Budd Unimount 10 Hub Piloted Wheels Teflon Coated	M 22 X 1.5	33 mm (1-19/64")	31 mm (1-7/32")	Euclid E-6000A Meritor R006000 Spicer 51-1033 Sirco 333B

Pro-Par Axle Nuts & Washers

 <p>GT-41226</p> <p>GT-41226 Description: Pro-Par Axle Outer Nut Measurements: 4-3/4" x 3-1/2"-12 x 1-1/8" inches Quality: grade 8 Material: SAE 1040/1050</p>	 <p>GT-43068</p> <p>GT-43068 Description: Pro-Par Axle Washer Measurements: 3-1/2" I.D. 5-1/16" O.D. x .255 thick</p>
<p>REPLACES: Martec: 1227D1226 Eaton: 4-2202 FRUACE8510-1 Trailmobile: 700-7-14</p>	<p>REPLACES: Martec: 1229Z3068 Trailmobile: 700-7-15</p>

Spoke Wheel Rim Nuts, Clamps and Bolts

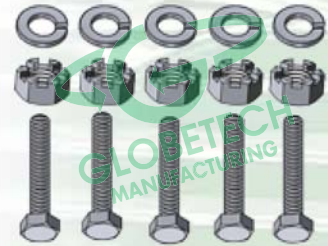

Replaces
Trailmobile# 700-50-34
GT-45000
5 each 2-1/2" - 16 Grade 8 bolts,
Lock nuts, Lock washers

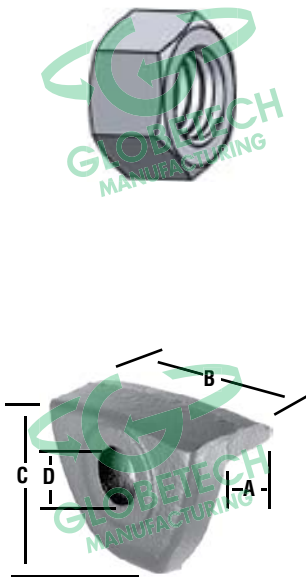

Part Number	Thread	Hex	Replaces
GT-4962	5/8"-11	1-1/16"	Euclid E-4962 Dayton 08-005149

Part Number	Thread	Hex	Replaces
GT-4963	3/4"-10	1-1/4"	Euclid E-4963 Dayton 08-005716

Part Number	A	B	C	D	Spacer Width	Replaces
GT-45571A	1-1/8"	2-7/8"	2-1/2"	3/4"	4"	Euclid E-5571A Dayton 09-612317

Part Number	A	B	C	D	Spacer Width	Replaces
GT-45572A	1-3/4"	2-7/8"	2-1/2"	3/4"	3-3/8"	Euclid E-5572A Dayton 09-623517

Part Number	A	B	C	D	Spacer Width	Replaces
GT-45040A	1-1/2"	2-7/8"	2-1/2"	3/4"	3-5/8"	Euclid E-45040A Dayton 09-699317



PSI Hubcaps



GT-4370

PSI, TN HUBCAP, GREASE, NO SIDE FILL, W/ NYLON WINDOW

Replaces Stemco: 340-4350 or 340-4370

Replaces Meritor: 31426-00

- Application: Grease
- Bolt Circle: 5.5
- Bolt Size: 5/16
- Overall Depth: 2-11/16
- Inside Depth: 1-15/16
- Flange Inner Diameter: 4-3/8
- Flange Outer Diameter: 6-1/4
- Replacement Window Kit: 359-6141



GT-4370S

PSI, TN HUBCAP, OIL, WITH SIDE FILL, W/NYLON WINDOW

Replaces Stemco: 343-4350 or 343-4370

Replaces Meritor: 31427-00

- Application: OIL
- Bolt Circle: 5.5
- Bolt Size: 5/16
- Overall Depth: 2-11/16
- Inside Depth: 1-15/16
- Flange Inner Diameter: 4-3/8
- Flange Outer Diameter: 6-1/4
- Replacement Window Kit: 359-6141



GT-4372

PSI, TP HUBCAP, GREASE, NO SIDE FILL, W/NYLON WINDOW

Replaces Stemco: 340-4352 or 340-4372

- Application: Grease
- Bolt Circle: 6.75
- Bolt Size: 5/16
- Overall Depth: 3-11/16
- Inside Depth: 2-15/16
- Flange Inner Diameter: 5-7/16
- Flange Outer Diameter: 7-1/2
- Replacement Window Kit: 359-6141



GT-4372S

PSI, TP HUBCAP, OIL, WITH SIDE FILL, W/NYLON WINDOW

Replaces Stemco: 343-4352 or 343-4372

- Application: OIL
- Bolt Circle: 6.75
- Bolt Size: 5/16
- Overall Depth: 3-11/16
- Inside Depth: 2-15/16
- Flange Inner Diameter: 5-7/16
- Flange Outer Diameter: 7-1/2
- Replacement Window Kit: 359-6141



Tire Inflation Hose



GT-4120

Long Flex Hose

Cross Reference:
MTR31373-00
HENVS29003-1

Standard Length 17.5" inches
*Also available in 19.5" inches

WORKS WITH ALL TIRE INFLATION SYSTEMS



GT-4121

Cross Reference:
MTR31363-00
HENVS29004-2

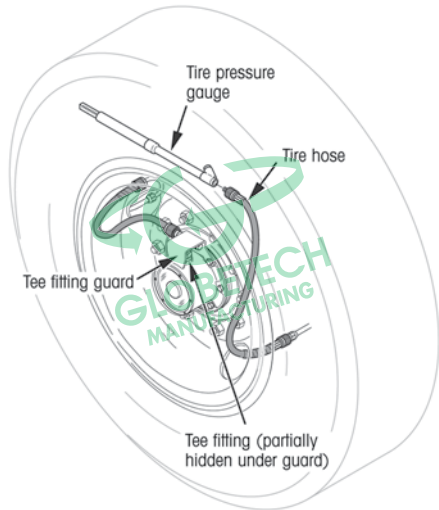

Tire Gage





Inner Tube

GT-4300

(Blue Line)



VALVE STEM: TR78A

Brass angled

STZF: 1000-20

Material: Butyl Blue line (High Tensile)
8-10 mpa

Packaged: Poly Bag 7 tubes per box

Part Number	Description
GT-4300	Standard 1000x20 8 MPA
GT-4302	Premium 1000x20 10 MPA
GT-4301	Tire flap liner

Aluminum Tire Knocker

GT-4101

- Premium Quality Replaces Aluminum Bat10



Tire Repair Tool Kit

GT-4040

- 1pc-Heavy-Duty steel T-handle Insert tool
- 1pc-Heavy-Duty steel T-handle spiral probe cement tool
- 2pc-replacement tool
- 60pc-4" string/plugs
- 1pc-lubricating oil





Tire Inflator Kit

- 1/4" straight air hose for air tool (or other low pressure pneumatic applications)
- Self-storing, adjustable length
- 2 x 1/4" NPTF male swivel fittings with spring guards are included
- 300 psi is maximum recommended operating pressure at 78°F
- OSHA (STD1-13-001) compliant when used with safety tip only

Inflator Kit Includes Coil Assembly and:

- 1/2" x 1/4" Bushing
- Male End Connector
- Female Disconnect
- Universal Gladhand (Part No. 5330)
- Air Chuck (Part No. 451060)
- Blow Gun w/male disconnect (Part No. 451065)



GT-451070

Blow Gun



GT-451065

Part Number	Description	Replaces Tectran
GT-451065	Blow gun w/male disconnect, 1/4" NPT	A148

Tire Chucks/Tire Gauges



GT-45130



GT-45135

Part Number	Description	Replaces Tectran
GT-45130	6" dual foot air chuck. 1/4" NPT	A824
GT-45135	Dual foot tire gauge, nylon bar, 10-150 psi	6A135



Valve Stems - USE: Steel Wheels



Part Number	Length	Replaces
GT-TR501	1-1/2"	Haltec TV-501
GT-TR572	3-3/4"	Haltec TV-572
GT-TR573	4-3/8"	Haltec TV-573

Valve Stems - USE: Aluminum Wheels



Part Number	Length	Bend Angle	Replaces
GT-TR544D	2"	60°	Haltec TV-544D
GT-TR545D	2/5/8"	60°	Haltec TV-545D
GT-TR509	4-3/4"	90°	Haltec TV-509
GT-TR510	5-1/2"	90°	Haltec TV-510



Valve Stems - USE: Steel Wheels

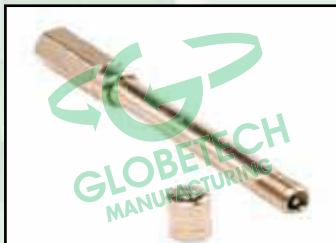

Part Number	Description	Replaces
GT-TE382	5-1/16" valve extension with 1" collar	Haltec 382



Valve Stem Accessories



GT-DS-1

Metal Double Seal Cap

This double seal cap seals at the top of the cap which prevents dirt and water from penetrating the cap, eliminating the chances of clogged air passages due to ice and debris. Allows for inflation and deflation of the tire without removing the cap. A great time saver.

Replaces Haltec DS-1

Valve Caps (Standard Bore)



GT-VC-3



GT-VC-8

Part Number	Description	Replaces
GT-VC-3	Nickel-plated	Haltec A 100-VC-3
GT-VC-8	Black plastic	Haltec A-100-VC-8



GT-VC-1

Valve Core

Part Number	Description	Replaces
GT-VC-1	Standard bore heat resistant core for cars, trucks and buses	Haltec A 100-VC-1

Standard Bore 4-way valve Tool



Part Number	Description	Replaces
GT-TL610	Repairs and conditions inside and outside valve threads. Inserts and removes cores. Corrosion-resistant, cadmium-plated	Haltec A 100-VC-1



Freeze Plugs GT-6200

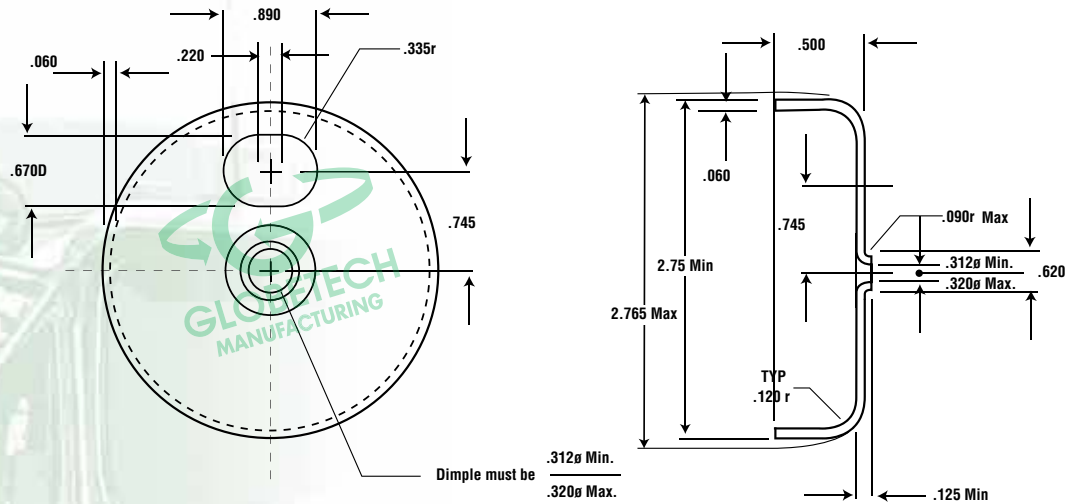

Part Number	Description	Replaces
GT-6200	Freeze plug	Wabash 10600526

Freeze Plugs GT-6202

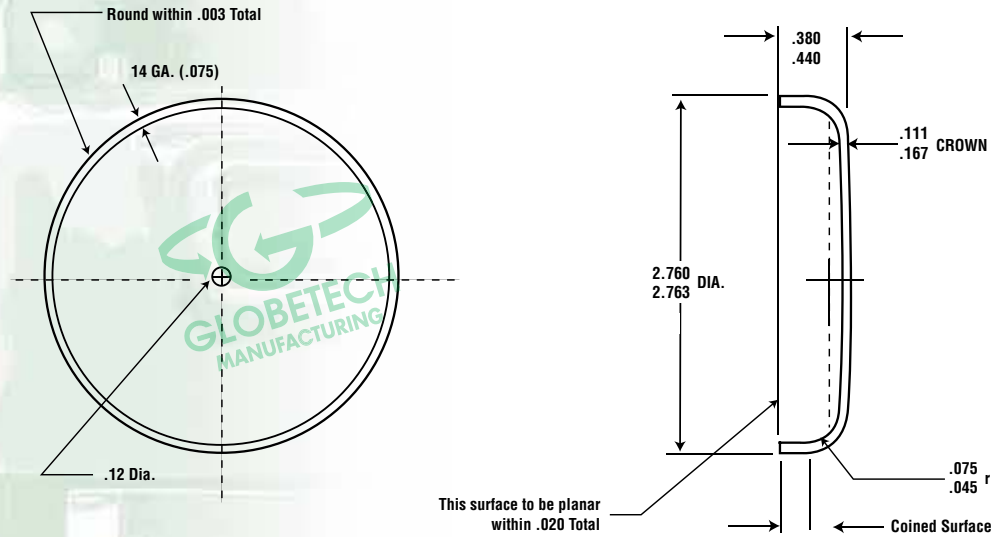

Part Number	Description	Replaces
GT-6202	Freeze plug	Haldex 102434T Fruehauf A-CD7180-1

Wheel End



Spring Brakes Made In U.S.A



Globetech's Spring Brakes are Assembled in the U.S.A.

- Combination of USA made components and imported components
- Each chamber is assembled in the USA and date coded
- Each component is inspected before assembly



Globetech's Spring Brakes are 100% Tested in the U.S.A.

- Meets all SAE J14659 Air Actuators test procedures
- Cycle life test passed for 1 million cycles on parts side and over 200K on spring side





Spring Brakes Made In U.S.A

Renaissance

SERIES

Technical Information

Power Spring

Black passivated and passes 48 hr salt spray test
CNC coiled and meets both force and life cycle requirements
as published by Society of Automotive Engineers 1 million cycle test

Non-Pressure Housing

11 Gauge with reinforced mounting bolts to prevent damage
Black E-coating and passes 200 hr salt spray test

Clamp Bands

Matched stamping for maximum seal and life
High strength steel material consistent long-life pressure
Zinc coated and corrosion prevention passes 72 hr salt spray test

Push Rod

Thick steel plate exceeds all OEM standards
Rolled edge creates smooth working surface
Orange stroke alert indicator OEM
CNC welding for push rod/plate attachment (very strong)

Aluminum Adapter

Die cast 360 spec. aluminum
Double O-Ring seal
Ground/plated push rod for smoothest friction surface

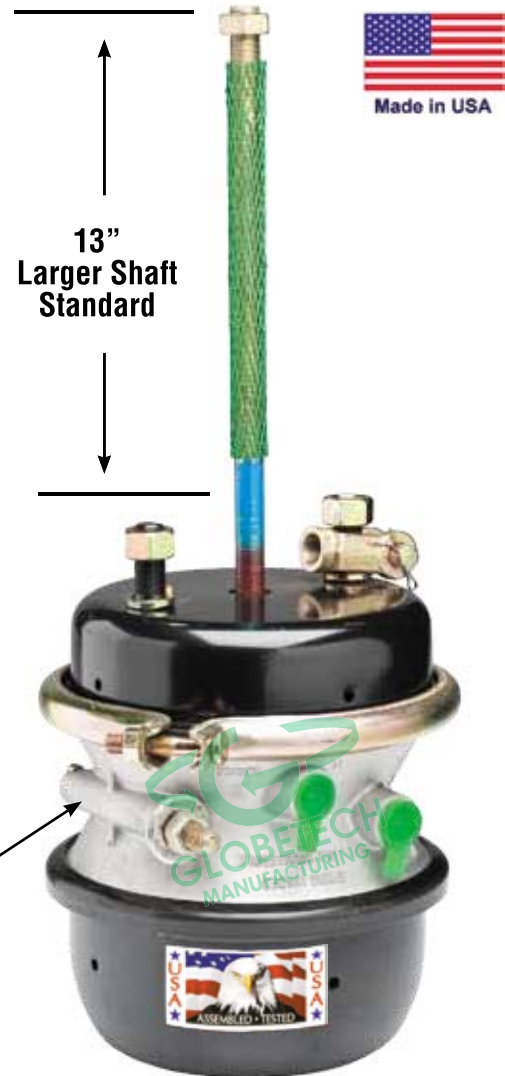

13"
Larger Shaft
Standard

Date
Code

Diaphragm

Natural/synthetic rubber blend
Meets SAE 1 million cycle test

Return Springs

.177 Spring wire SAE tested to 1 million cycles

Fasteners

All Fasteners are tensile strength and adhere to SAE standards





Brake Chambers



Part Number	Description	OEM	Replaces Ranger
GTA-BC2024	Type 2024 OEM sealed spring brake (Renaissance)		BTS-2024
GTA-BC2424	Type 2424 OEM sealed spring brake (Renaissance)		BTS-2424
GTA-BC2424LS	Type 2424 OEM sealed long sroke spring brake (Renaissance)		BTS-2424LS
GTA-BC2430	Type 2430 OEM sealed spring brake (Renaissance)		BTS-2430
GTA-BC2430LS	Type 2430 OEM sealed long stroke spring brake (Renaissance)		BTS-2430LS
GTA-BC3030	Type 3030 OEM sealed spring brake (Renaissance) USA MADE		BTS-3030
GTA-BC3030LS	Type 3030 OEM sealed long stroke spring brake (Renaissance)		BTS-3030LS
GTA-BC3036	Type 3036 OEM sealed spring brake (Renaissance)		BTS-3036
GTA-BC3636	Type 3636 OEM sealed spring Brake (Renaissance)		BTS-3636
GTA-BC3030-4.5DB	3030 sealed w/ 4.5 rod/dust boot/clevis (Mack)		BTS-3030-4.5 BC
GTA-3030-WCR	Type 3030 welded clevis replacement		3030-WCR
GTA-3030LS-WCR	Type 3030 longstroke welded clevis replacement		3030LS-WCR

Value Chamber 100% Tested

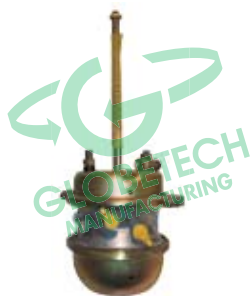

Part Number	Description	Aftermarket Series	Replaces Ranger
GTA-BC3030V	Type 3030 valve chamber gold zinc 14" shaft (Economy)		n/a

Piggybacks



Part Number	Description	OEM	Replaces Ranger
GTA-BC3030P	Type 3030 piggyback		BPS-3030
GTA-BC3030PK	Type 3030 piggyback kit w/ 1 diaphragm, 2 clamps, and installation hardware		BPS-3030K
GTA-BC3030PLSK	Type 3030 piggyback long stroke kit		BPS-3030KLS
GTA-BC2024P	Type 2024 Piggyback		BPS-2024
GTA-BC3036P	Type 3036 Piggyback		BPS-3036

Service Chambers



Part Number	Description	OEM	Replaces Ranger
GTA-BC36	Type 36 service chamber		BSC-36
GTA-BC30LS	Type 30 service chamber long stroke		BSC-30LS
GTA-BC30SC-WCR	Type 30 service chamber (welded clevis assembly)		30SC-WCR
GTA-BC30	Type 30 service chamber		BSC-30
GTA-BC24	Type 24 service chamber		BSC-24
GTA-BC20	Type 20 service chamber		BSC-20
GTA-BC16	Type 16 service chamber		BSC-16
GTA-BC12	Type 12 service chamber		BSC-12
GTA-BC09	Type 9 service chamber		BSC-09



Air Brakes

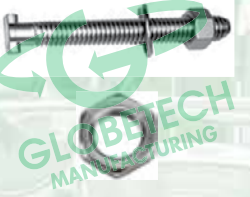

Part Number	Description	Replaces Ranger
GTA-30DB	Dust boot	RB-30DB
GTA-006	Type 30 return spring	RB006
GTA-30PS	Type 30 power spring	RB30PS
GTA-009	Carriage bolt&nut 3/8"-16 (Attaches clamps to chamber)	RB009
GTA-010	Jam nut 5/8"-18 (Attaches end of push rod for clevis mount)	RB010
GTA-30DC	Dust caps (Black cap that attaches to bottom of chamber)	RB-30DC
GTA-008	T-Bolt Assembly set (1-Washer, T-bolt, T-bolt nut)	RB008
GTA-9PR	T-9 push rod	RB-9PR
GTA-12PR	T-12 push rod	RB-12PR
GTA-16PR	T-16 push rod	RB-16PR
GTA-20PR	T-20 push rod	RB-20PR
GTA-24PR	T-24 push rod	RB033
GTA-30PR	T-30 push rod	RB034
GTA-36PR	T-36 push rod	RB-36PR
GTA-9NPH	T-09 non pressure "stud" housing	RB-9NPH
GTA-12NPH	T-12 non pressure "stud" housing	RB-12NPH
GTA-16NPH	T-16 non pressure "stud" housing	RB-16NPH
GTA-20NPH	T-20 non pressure "stud" housing	RB-20NPH
GTA-24NPH	T-24 non pressure "stud" housing	RB-24NPH
GTA-30NPH	T-30 non pressure "stud" housing	RB020
GTA-36NPH	T-36 non pressure "stud" housing	RB-36NPH



Diaphragms Clamps, Clevis Assemblies



- Heavy Duty
- Reinforced molded sides meets OEM standards
- Style: clamp ring
- Other styles available by special order

Part Number	Type	Description	Replaces Midland#	Replaces Bendix#	Replaces Ranger
GT-5205	9	Air Brake Diaphragm 5"	KN18090	234433	RB-D-9
GT-5206	16	Air Brake Diaphragm 6"	KN18160	234189	RB-D-16
GT-5208	24	Air Brake Diaphragm 7"	KN18240	234100	RB-D-24
GT-5209	30	Air Brake Diaphragm 8"	KN18300	234101	RB-D-30
GT-5210	30	Air Brake Diaphragm 7-27/32" Long Stroke			RB-D-303
GT-5211	12	Air Brake Diaphragm 5-1/2"	KN18120	234226	RB-D-12
GT-5212	20	Air Brake Diaphragm 6-1/2"	KN18200	234099	RB-D-20
GT-5213	24	Air Brake Diaphragm Long Stroke			RB-D-243
GT-5214	36	Air Brake Diaphragm		234362	RB-D-36

Chamber Clamps



- Black powder coat
- Individual poly bagged
- Type 30 (GT-5280)



Part Number	Type	Description	Replaces Ranger
GTA-5280	30	Steel Chamber Clamp Kit (carriage bolts, nuts, clamps)	RB053
GTA-5281	9	Steel Chamber Clamp Kit (carriage bolts, nuts, clamps)	RB9CK
GTA-5282	12	Steel Chamber Clamp Kit (carriage bolts, nuts, clamps)	RB12CK
GTA-5283	16	Steel Chamber Clamp Kit (carriage bolts, nuts, clamps)	RB16CK
GTA-5284	20	Steel Chamber Clamp Kit (carriage bolts, nuts, clamps)	RB20CK
GTA-5285	24	Steel Chamber Clamp Kit (carriage bolts, nuts, clamps)	RB016
GTA-5286	36	Steel Chamber Clamp Kit (carriage bolts, nuts, clamps)	RB36CK



Air Coils



AIR-COILS
FIRE & ICE

Withstands temperatures from 212°F (100°C) to -40°

- Coiled, 1/2" O.D. reinforced nylon tubing
- Excellent coil memory and durability
- Color-coded (red - emergency / blue - service) Meets SAE J844 and DOT FMVSS 106 - (49 CFR 571.106 & 49CFR 393.45)
- Designed for 150 psi operating systems
- Resistant to attack by gasoline, diesel fuel, methyl-alcohol and zinc chloride
- Male pipe - brass fittings
- Heavy duty plated spring guards
- D.O.T. fittings



Standard Air Coils

DOT FMVSS 106

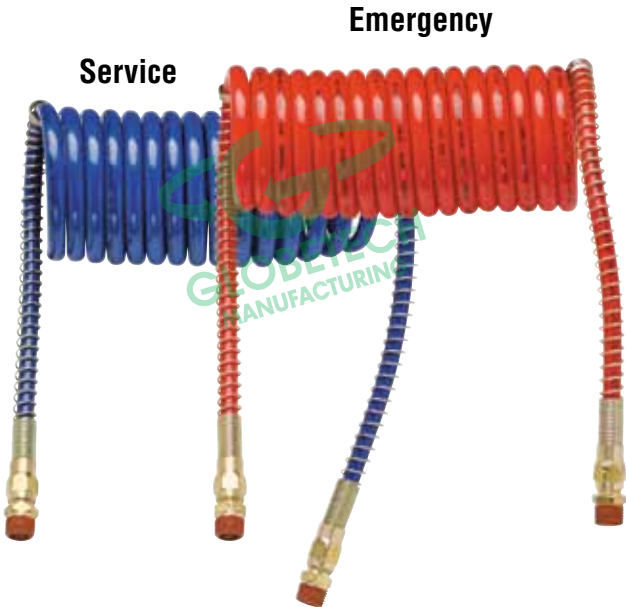

Globetech's Air Coils have excellent coil memory

Manufacturer Marking

Hose Type

SAE Tested

Hose Size

D.O.T. Approved

Date Code

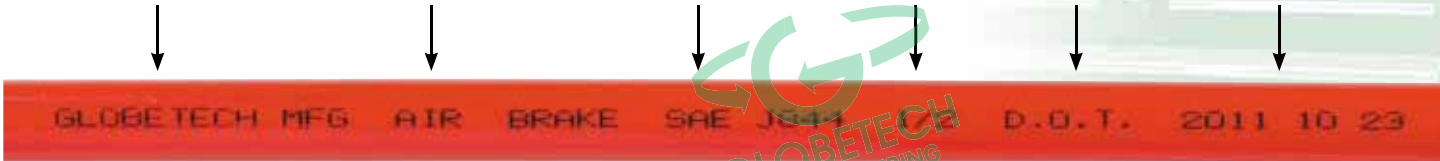

Heavy Duty Air Coils

Part No.	Description	Replaces Tectran	Replaces Phillips
GTA120606	12" 2 x 06" lead	17212	11-312
GTA-151212	15" 2 x 12" lead	17215	11-315
GTA-151213	15" 1 - 12" lead 1 - 40" lead		11-340
GTA-151214	15" 1 - 12" lead 1 - 48" lead	17215-040	
GTA-201212	20" 2 x 12" lead	17220	11-320

all references to competitors' part numbers are for cross reference purposes only



Xtreme Cold Weather Air Coils

GT-151212, GT-151213, GT-151214

Meets DOT FMVSS 106



- Large, 5” coil diameter to improve flexibility
- Pre-applied thread sealant provides air tight seal
- Jacketing provides superior recoil memory. Chemical and abrasion resistance
- Remains flexible to **-85°F** for extreme cold weather protection
- Brass POWER GRIP long brass handle for easy coupling/uncoupling

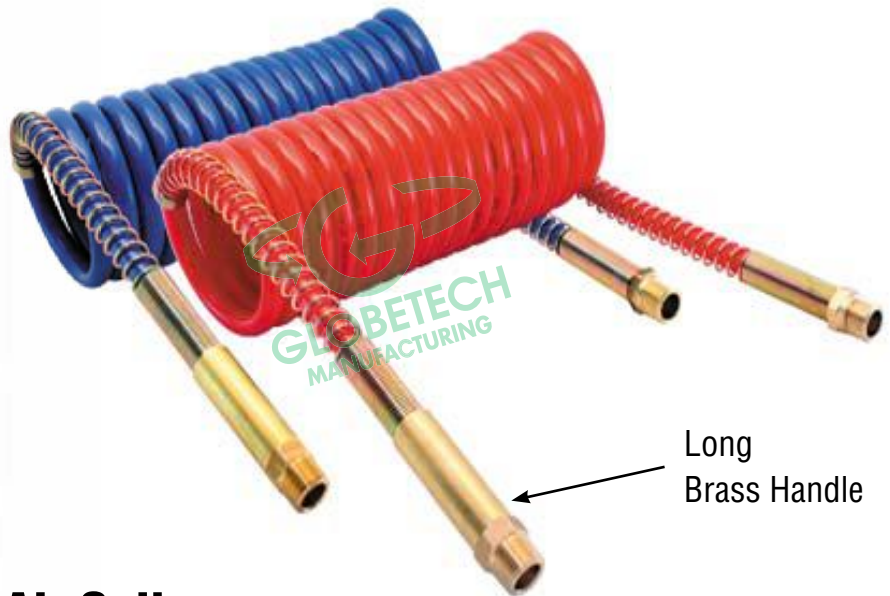

Long Brass Handle

Xtreme Cold Weather Air Coils

Part No.	Description	Replaces Tectran	Replaces Phillips
GTA120606X	12” 2 x 06” lead	17B12H	11-5120
GTA-151212X	15” 2 x 12” lead	17B15H	11-5150
GTA-151213X	15” 1 - 12” lead	17B15-40H	11-5400
	1 - 40” lead		
GTA-151214X	15” 1 - 12” lead	17A15-40H	
	1 - 48” lead		
GTA-201212X	20” 2 x 12” lead	17B20H	11-5200



3 Layer Xtreme Weather Air Coils

- Nylon inner layer reinforced with nylon webbing (1)
- Nylon inner layer (2)
- Urethane outer layer (3)



Air-Electric 3 to 1 Combo GT-3320

GT-3007 - 7/way OEM Plug
GT-3320 - 15/Ft. 3 to 1 Combo
GT-3321 - 12/Ft. 3 to 1 Combo
GT-3322 - 20 Ft. 3 to 1 combo
GT-3600 - 15/Ft. Sprial Wrap
GT-5341 - Red/Blue Aluminum Hex Grips

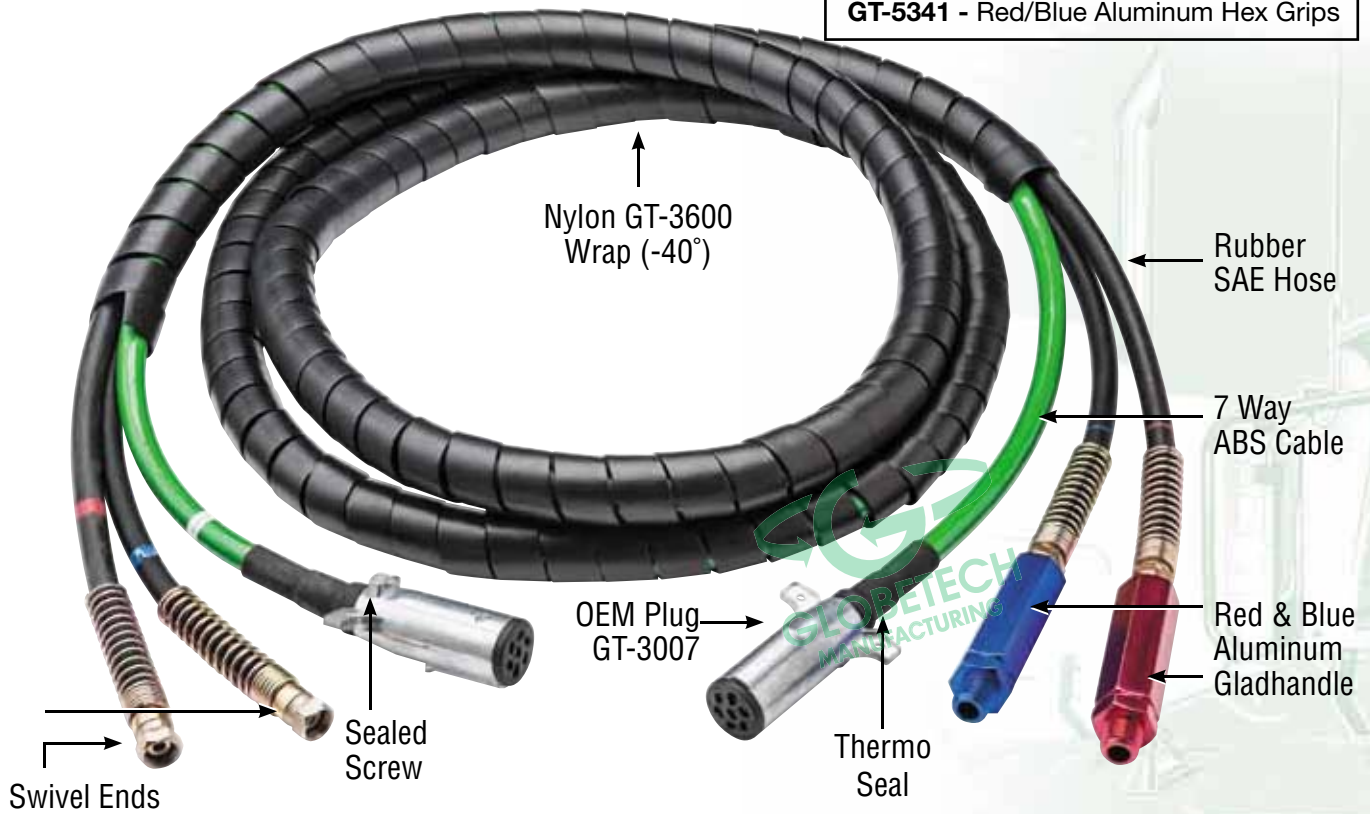

GT-3600 - Spiral Wrap

- 15/ft. long
- Make your own air power assemblies
- Flexible nylon material flexable to -40° F
- U.V. resistant



Air Line Hanger Clamp
Part No. GT-5379



Large Carabiner
Part No. GT-5376

Replaces
TECTRAN - 832SPR



Rubber Air Brake Hose (Bulk)



Manufactured to OEM Specs



Destructive Tests

Destructive tests are conducted on short specimens of hose, normally 18 inches to 36 inches in length and, as the name implies, the hose is destroyed in the performance of the test.

- A. Burst pressure is recorded as the pressure at which actual rupture of a hose occurs.
- B. A hold test, when required, is a means of determining whether weakness will develop under a given pressure for a specified period of time.

Non-Destructive Tests

- a. Proof pressure test
- b. Change in length test (elongation or contraction)
- c. Change in outside diameter or circumference test
- d. Warp test
- e. Rise test
- f. Twist test
- g. Kink test
- h. Volumetric expansion test



Minimum Bend Radius

Minimum Hose Bend Radius Data (MBR)

The Bend Radius is the radius of the bent section of a hose measure to the innermost surface of the curved portion. It is important because the minimum bend radius is the maximum amount a hose can be bent without being kinked or damaged.

AIR BRAKE, TYPE A - SAE J1402 & DOT FMVSS 106

Air Brake hose is designed for conveying air in truck and trailer brake systems. Truck and trailer manufacturers, aftermarket packagers and wholesalers use this hose. It is certified to meet D.O.T. FMVSS 106 and SAE J1402A requirements. The EPDM tube and cover with the 4-spiral reinforcement make this hose virtually kink proof. This hose is durable enough to handle this safety related application.



- Cover Color:** Black
- Oil Resistance:** Medium
- Construction:**
 - Tube:** EPDM, RMA Class C
 - Cover:** EPDM, RMA Class C
 - Reinforcement:** Spiral polyester yarn
- Temperature Range:** -40°F to +200°F
-40°C to +93°C
- Packaging:** † Maximum 2 pc. 250 ft. reel, **50 ft. length – 1 per carton

Part No.	Nominal I.D. (in)	Nominal O.D. (in)	Working Pressure	Min. Bend Radius (in)	Weight (lb/ft)	Length
GTA-38000	3/8	.75	Min. Burst 900	2.25	0.17	250 ft
GTA-12000	1/2	.88	Min. Burst 900	3.00	0.20	250 ft



Air Brake Hose Assemblies



Engineered Products

- Factory tested to ensure quality
- Meets or exceeds SAE J1402 – Type A
- Meets or exceeds DOT FMVSS No. 106 – Brake Hoses, 49 CFR 571.106
- Available from stock in a wide selection of lengths and end configurations



3/8" Hose, 3/8" Ends			1/2 Hose, 3/8" Ends	
Length	Fixed/Swivel	Swivel/Swivel	Fixed/Swivel	Swivel/Swivel
8	GTA-3838F08	GTA-3838S08	GTA-1238F08	GTA-1238S08
12	GTA-3838F12	GTA-3838S12	GTA-1238F12	GTA-1238S12
14	GTA-3838F14	GTA-3838S14	GTA-1238F14	GTA-1238S14
16	GTA-3838F16	GTA-3838S16	GTA-1238F16	GTA-1238S16
18	GTA-3838F18	GTA-3838S18	GTA-1238F18	GTA-1238S18
20	GTA-3838F20	GTA-3838S20	GTA-1238F20	GTA-1238S20
22	GTA-3838F22	GTA-3838S22	GTA-1238F22	GTA-1238S22
24	GTA-3838F24	GTA-3838S24	GTA-1238F24	GTA-1238S24
26	GTA-3838F26	GTA-3838S26	GTA-1238F26	GTA-1238S26
28	GTA-3838F28	GTA-3838S28	GTA-1238F28	GTA-1238S28
30	GTA-3838F30	GTA-3838S30	GTA-1238F30	GTA-1238S30
32	GTA-3838F32	GTA-3838S32	GTA-1238F32	GTA-1238S32
34	GTA-3838F34	GTA-3838S34	GTA-1238F34	GTA-1238S34
36	GTA-3838F36	GTA-3838S36	GTA-1238F36	GTA-1238S36
38	GTA-3838F38	GTA-3838S38	GTA-1238F38	GTA-1238S38
40	GTA-3838F40	GTA-3838S40	GTA-1238F40	GTA-1238S40
42	GTA-3838F42	GTA-3838S42	GTA-1238F42	GTA-1238S42
44	GTA-3838F44	GTA-3838S44	GTA-1238F44	GTA-1238S44
46	GTA-3838F46	GTA-3838S46	GTA-1238F46	GTA-1238S46
48	GTA-3838F48	GTA-3838S48	GTA-1238F48	GTA-1238S48
50	GTA-3838F50	GTA-3838S50	GTA-1238F50	GTA-1238S50
52	GTA-3838F52	GTA-3838S52	GTA-1238F52	GTA-1238S52
54	GTA-3838F54	GTA-3838S54	GTA-1238F54	GTA-1238S54
56	GTA-3838F56	GTA-3838S56	GTA-1238F56	GTA-1238S56
60	GTA-3838F60	GTA-3838S60	GTA-1238F60	GTA-1238S60
66	GTA-3838F66	GTA-3838S66	GTA-1238F66	GTA-1238S66
72	GTA-3838F72	GTA-3838S72	GTA-1238F72	GTA-1238S72
84	GTA-3838F84	GTA-3838S84	GTA-1238F84	GTA-1238S84



D.O.T. Reusable Hose Fittings

Male Connector

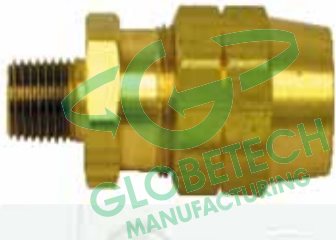

Part Number	Replaces Tectran	Hose I.D.	Pipe Thread
GTA-105	105	3/8"	1/4"
GTA-106	106	3/8"	3/8"
GTA-107	107	3/8"	1/2"
GTA-106-8	106-8	1/2"	3/8"
GTA-107-8	107-8	1/2"	1/2"

Male Connector Body



Part Number	Replaces Tectran	Hose I.D.	Pipe Thread
GTA-1021	1021	3/8"	1/4"
GTA-1031	1031	3/8"	3/8"
GTA-1041	1041	3/8"	1/2"
GTA-1031-8	1031-8	1/2"	3/8"
GTA-1041-8	1041-8	1/2"	1/2"

Male Connector With Spring Guard



Part Number	Replaces Tectran	Hose I.D.	Pipe Thread
GTA-102	102	3/8"	1/4"
GTA-103	103	3/8"	3/8"
GTA-104	104	3/8"	1/2"
GTA-103-8	103-8	1/2"	3/8"
GTA-104-8	104-8	1/2"	1/2"

Adapter (Swivel Type & Crimped-On Fittings)



Part Number	Replaces Tectran	Pipe Thread	Use On Fitting No.
GTA-161201	161201	1/4"	1105
GTA-161201-6	161201-6	3/8"	1106
GTA-161201-8	161201-8	1/2"	1107
GTA-181201-6	181201-6	3/8"	1106-6
GTA-181201-8	181201-8	1/2"	1107-8

Female Swivel Connector With Adapter



Part Number	Replaces Tectran	Hose I.D.	Pipe Thread
GTA-1105	1105	3/8"	1/4"
GTA-1106	1106	3/8"	3/8"
GTA-1107	1107	3/8"	1/2"
GTA-1106-8	1106-8	1/2"	3/8"
GTA-1107-8	1107-8	1/2"	1/2"

Air Brakes



D.O.T. Reusable Hose Fittings Brass

Ferrule



Part Number	Replaces Tectran	Hose I.D.
GTA-1022	1022	3/8"
GTA-1022-8	1022-8	1/2"

Union



Part Number	Replaces Tectran	Hose I.D.
GTA-105501	105501	3/8"
GTA-107701	107701	1/2"

Union Body



Part Number	Replaces Tectran	Hose I.D.
GTA-1055011	1055011	3/8"
GTA-1077011	1077011	1/2"

Spring Guard



Part Number	Replaces Tectran	Hose I.D.
GTA-1024	1024	3/8"
GTA-1024-8	1024-8	1/2"

Nut With Spring Guard



Part Number	Replaces Tectran	Hose I.D.
GTA-10234	10234	3/8"
GTA-10234-8	10234-8	1/2"

Nut - For use with spring guard



Part Number	Replaces Tectran	Hose I.D.
GTA-1023	1023	3/8"
GTA-1023-8	1023-8	1/2"

Hose Nut



Part Number	Replaces Tectran	Hose I.D.
GTA-1025	1025	3/8"
GTA-1025-8	1025-8	1/2"



Air Brake Nylon Tubing (OEM USE)

- For air brake systems only- NOT for fuel line applications
- SAE Type A tubing is single wall extruded nonreinforced nylon
- SAE Type B tubing has seamless extruded nylon core with fiber reinforced protective nylon cover
- Can be used with either air brake or nylon tube fittings
150 psi maximum working pressure
- UV and ozone resistant nylon material
- Withstands temperatures of -40 to +200 F

Quality Testing Requirements

- Meets or Exceeds SAE J844 type "A" & "B" specifications
- Meets or Exceeds FMVSS 106
- Meets or Exceeds DOT requirements

Part No.	Color	Length	Nominal O.D.	SAE Type
GTA-1922-01	Black	1000' Bulk	1/8"	A
GTA-1922-01-1	Black	100' Coil	1/8"	A
GTA-19225-01	Black	1000' Bulk	5/32"	A
GTA-19225-01-1	Black	100' Coil	5/32"	A
GTA-1923-01	Black	1000' Bulk	3/16"	A
GTA-1923-01-1	Black	100' Coil	3/16"	A
GTA-1924-01	Black	1000' Bulk	1/4"	A
GTA-1924-01-1	Black	100' Coil	1/4"	A
GTA-1924-02	Blue	1000' Bulk	1/4"	A
GTA-1924-02-1	Blue	100' Coil	1/4"	A
GTA-1924-04	Green	1000' Bulk	1/4"	A
GTA-1924-04-1	Green	100' Coil	1/4"	A
GTA-1924-05	Red	1000' Bulk	1/4"	A
GTA-1924-05-1	Red	100' Coil	1/4"	A
GTA-1924-07	Yellow	1000' Bulk	1/4"	A
GTA-1924-07-1	Yellow	100' Coil	1/4"	A
GTA-1926-01	Black	500' Bulk	3/8"	B
GTA-1926-01-1	Black	100' Coil	3/8"	B
GTA-1926-02	Blue	500' Bulk	3/8"	B
GTA-1926-02-1	Blue	100' Coil	3/8"	B
GTA-1926-04	Green	500' Bulk	3/8"	B
GTA-1926-04-2	Green	100' Coil	3/8"	B
GTA-1926-05	Red	500' Bulk	3/8"	B
GTA-1926-05-1	Red	100' Coil	3/8"	B
GTA-1926-07	Yellow	500' Bulk	3/8"	B
GTA-1926-07-1	Yellow	100' Coil	3/8"	B
GTA-1928-01	Black	500' Bulk	1/2"	B
GTA-1928-01-1	Black	100' Coil	1/2"	B
GTA-1928-02	Blue	500' Bulk	1/2"	B
GTA-1928-02-1	Blue	100' Coil	1/2"	B
GTA-1928-05	Red	500' Bulk	1/2"	B
GTA-1928-05-1	Red	100' Coil	1/2"	B
GTA-1928-07	Yellow	500' Bulk	1/2"	B
GTA-1928-07-1	Yellow	100' Coil	1/2"	B
GTA-1930-01	Black	250' Bulk	5/8"	B
GTA-1930-01-1	Black	100' Coil	5/8"	B
GTA-1930-04-1	Green	100' Coil	5/8"	B
GTA-1932-01	Black	250' Bulk	3/4"	B
GTA-1932-01-1	Black	100' Coil	3/4"	B

Type "A"
Single Wall Tubing
1-Layer of Nylon



Type "B"
Reinforced Fiber Wall Tubing
2-Layers of Nylon





Male Elbow

Part Number	Description	Qty.
GTA-12-8404	Fits 1/4" tubing, 1/8" pipe thread	10
GTA-12-8405	Fits 1/4" tubing, 1/4" pipe thread	10
GTA-12-8406	Fits 3/8" tubing, 1/4" pipe thread	10
GTA-12-8407	Fits 3/8" tubing, 3/8" pipe thread	10
GTA-12-8408	Fits 1/2" tubing, 1/4" pipe thread	10
GTA-12-8409	Fits 1/2" tubing, 3/8" pipe thread	10
GTA-12-8410	Fits 1/2" tubing, 1/2" pipe thread	10
GTA-12-8411	Fits 5/8" tubing, 1/2" pipe thread	10



**D.O.T. Nylon Air Hose
Tube Fittings**

Male Connector

Part Number	Description	Qty.
GTA-12-8304	Fits 1/4" tubing, 1/8" pipe thread	10
GTA-12-8305	Fits 1/4" tubing, 1/4" pipe thread	10
GTA-12-8306	Fits 1/4" tubing, 3/8" pipe thread	10
GTA-12-8307	Fits 3/8" tubing, 1/4" pipe thread	10
GTA-12-8308	Fits 3/8" tubing, 3/8" pipe thread	10
GTA-12-8309	Fits 3/8" tubing, 1/2" pipe thread	10
GTA-12-8310	Fits 1/2" tubing, 1/4" pipe thread	10
GTA-12-8311	Fits 1/2" tubing, 3/8" pipe thread	10
GTA-12-8312	Fits 1/2" tubing, 1/2" pipe thread	10



Sleeve

Part Number	Description	Qty.
GTA-12-8804	Fits 1/4" tubing	100
GTA-12-8806	Fits 3/8" tubing	100
GTA-12-8808	Fits 1/2" tubing	100
GTA-12-8810	Fits 5/8" tubing	100



Full Union

Part Number	Description	Qty.
GTA-12-8504	Fits 1/4" tubing	10
GTA-12-8506	Fits 3/8" tubing	10
GTA-12-8508	Fits 1/2" tubing	10
GTA-12-8510	Fits 5/8" tubing	10



Tee-Ends

Part Number	Description	Qty.
GTA-12-8604	Fits 1/4" tubing	10
GTA-12-8606	Fits 3/8" tubing	10
GTA-12-8608	Fits 1/2" tubing	10



Nut

Part Number	Description	Qty.
GTA-12-8704	Fits 1/4" tubing	10
GTA-12-8706	Fits 3/8" tubing	10
GTA-12-8708	Fits 1/2" tubing	10
GTA-12-8710	Fits 5/8" tubing	10



Nylon Tubing Inserts

Part Number	Description	Qty.
GTA-12-8904	Fits 1/4" tubing	100
GTA-12-8906	Fits 3/8" tubing	100
GTA-12-8908	Fits 1/2" tubing	100
GTA-12-8910	Fits 5/8" tubing	100





D.O.T. Quick Connect Push-In

Male Connector

Part Number	Description	Qty.
GTA-12-9304	Fits 1/4" tubing, 1/8" pipe thread	10
GTA-12-9305	Fits 1/4" tubing, 1/4" pipe thread	10
GTA-12-9306	Fits 1/4" tubing, 3/8" pipe thread	10
GTA-12-9307	Fits 3/8" tubing, 1/4" pipe thread	10
GTA-12-9308	Fits 3/8" tubing, 3/8" pipe thread	10
GTA-12-9309	Fits 3/8" tubing, 1/2" pipe thread	10
GTA-12-9310	Fits 1/2" tubing, 1/4" pipe thread	10
GTA-12-9311	Fits 1/2" tubing, 3/8" pipe thread	10
GTA-12-9312	Fits 1/2" tubing, 1/2" pipe thread	10
GTA-12-9313	Fits 5/8" tubing, 3/8" pipe thread	10



Male Elbow

Part Number	Description	Qty.
GTA-12-9404	Fits 1/4" tubing, 1/8" pipe thread	10
GTA-12-9405	Fits 1/4" tubing, 1/4" pipe thread	10
GTA-12-9406	Fits 3/8" tubing, 1/4" pipe thread	10
GTA-12-9407	Fits 3/8" tubing, 3/8" pipe thread	10
GTA-12-9408	Fits 1/2" tubing, 1/4" pipe thread	10
GTA-12-9409	Fits 1/2" tubing, 3/8" pipe thread	10
GTA-12-9410	Fits 1/2" tubing, 1/2" pipe thread	10



Full Union

Part Number	Description	Qty.
GTA-12-9504	Fits 1/4" tubing	10
GTA-12-9506	Fits 3/8" tubing	10
GTA-12-9508	Fits 1/2" tubing	10



Tee-Ends

Part Number	Description	Qty.
GTA-12-9604	Fits 1/4" tubing	10
GTA-12-9606	Fits 3/8" tubing	10
GTA-12-9608	Fits 1/2" tubing	10





Quick Fix Repair Kit













Swivel Hose End Kits

Part Number	Replaces Tectran No.	Thread
GTA-5342	70-31402	3/8" NPTF
GTA-5343	70-31403	1/2" NPTF

Part No.	Hose ID	Pipe Thread	Thread Seal
GT-5342	3/8	3/8	No
GT-5343	3/8	1/2	No

A New Solution for Repairing Damaged Rubber Air Lines



Including	Two nylon shells provide corrosion resistant to improve air system life 	One brass fitting with NPTF thread and coating provides tight connection 	One assembly ring offers a tight crimping. 	One wrench offers a easy installation and reduce residual torque. 	One nylon hose barb takes a strong grasp to the rubber hose. 
Assembly	Step 1. Cut off the damaged end of the hose. Position hose end on the inside groove of the shell. 	Step 2. Insert the brass fitting into the lock shell. 	Step 3. Assemble the other side of the shell onto the brass fitting and the hose. 	Step 4. Slide the assembly ring over the shell to its final position on the shell. 	Step 5. Insert nylon barb into the fitting, turn and push it with the wrench until flush inside the fitting. 

Notice:

1. Greasing the nylon barb before inserting it into the fitting.
2. Check final assembly visually to insure that hose has not shifted position during assembly.

Heavy Duty Drain Valve

GT-5300

- 60" cable with 1/4" pipe thread (includes brass valve and cable)
Replaces Phillips Part No. 12-820

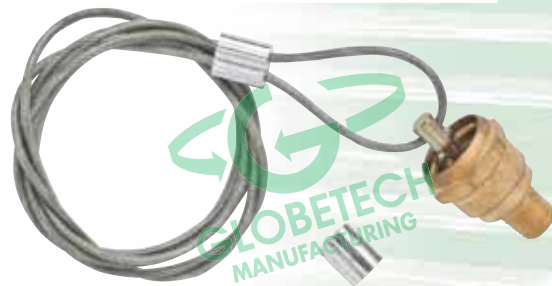

NYLON TUBE CUTTER





GTA-SC1



Part Number	Description	Replaces Tectran
GT-5256	Nylon Tube Cutter	SC-1



Clamping Stud

Clamping Studs	Part No.	A	B	C	Length	Replaces Sloan	Replaces Tectran	Replaces Tramec
	GT-5251	1/2-14 NPTF	1-14 UNS	1/4-18 NPTF	2-7/8	S600	115-88	50010
	GT-5252	1/2-14 NPTF	1-14 UNS	1/2-14 NPTF	2-3/8	S629		50012
	GT-5253	1/2-14 NPTF	1-14 UNS	3/8-18 NPTF	1-11/16	S620	115-86	50001
	GT-5254	3/8-18 NPTF	1-14 UNS		1-5/16	S607	114-66	50006
	GT-5255	1/4-18 NPTF	3/4-16 UNS		1-1/2	S661	114B-44	50005
	GT-5256	1/2 O.D. Tube	7/8-20 UNF	3/8-18 NPTF	1-5/16	S608	113-8AB	50008
	GT-5257	3/8 O.D. Tube	7/8-20 UNF	3/8-18 NPTF	1-3/8	S609	113-6AB	50009

Crimping Hose Ends

Crimping Hose Adapter



Part Number	Hose I.D.	Pipe Thread
GTA-1076-6-6	3/8	3/8
GTA-1076-6-8	3/8	1/2
GTA-1076-8-6	1/2	3/8
GTA-1076-8-8	1/2	1/2

Crimping Swivel Hose Adapter



Part Number	Hose I.D.	Pipe Thread
GTA-1176-6-6	3/8	3/8
GTA-1176-6-8	3/8	1/2
GTA-1176-8-6	1/2	3/8
GTA-1176-8-8	1/2	1/2

Application



used with air brake rubber hose (SAE J1042 hose) as hose assemblies in air brake system.

Note:

Add pre-applied thread sealant to male threads by adding suffix "V" to part numbers.



Slider Bars & Tracker Bar Replacement Parts

- Type 304 stainless steel 3/4" diameter
- Elongated mounting holes cover a range of mounting hole locations

Part No.	A	B	L	Description
GT-5421	20"	10.5"	21.5"	Material: 0.750 Inch O.D. X18GA. 304s.s.Tube
GT-5422	31.5"	22.9"	33.9"	
GT-5423	37.5"	28"	39"	
GT-5424	42.5"	33"	44"	
GT-5425	49.5"	40"	51"	

Stainless Steel Tracker Bar

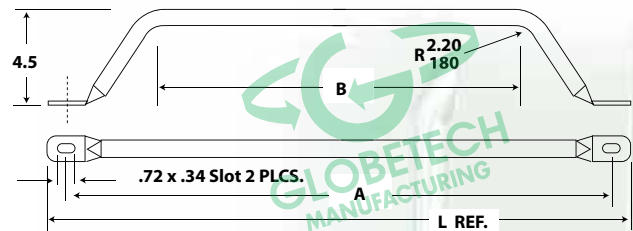

Part Number	Description	Replaces Phillips
GT- 5426	Kit with 39" bar & 20" spring	17-249



- Back of cab cable support
- Kits include bar, snap-on clip, sleeve, 3-hose holder and spring
- Stainless steel bar

Part Number	Description	Replaces Phillips
GT- 5375	Kit with single heavy-duty spring, 20"holder	17-148
GT- 5427	Kit with dual 16" springs	7-420

Tender kit 16" Double



- Replacement spring and hardware for tracker bars
- Kits include snap-on clip, sleeve, 3-hose holder and spring (s)
- Ideal for ABS cable use

Part Number	Description	Replaces Phillips
GT- 5007	3" spring with tandem frame clip, 3/4" O.D.	17-103
GT- 5008	6" spring, 1" O.D.	17-106

- For use on trailers with sliding axles
- Supports air lines to rear axle

Part Number	Description	Replaces Phillips
GT- 5001	11" tandem cable and air line support	17-111
GT- 5002	13" tandem cable and air line support	
GT- 5003	16" recommended for straight cable assemblies	17-116
GT- 5004	20" extra heavy-duty, for use with ABS coiled assemblies	17-120
GT- 5006	25", extra heavy-duty, for use with ABS coiled assemblies	17-125

- Pre-galvanized hard drawn wire per SAE-ASTM-A227-77
- All springs are 1" O.D.

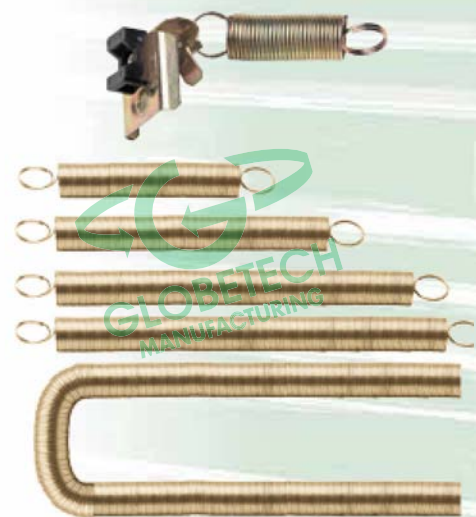

all references to competitors' part numbers are for cross reference purposes only



Hose Separators



GT-5500-12

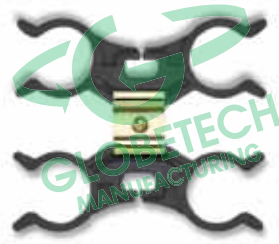

GT-5501-12

- Keeps nylon air hose secure and out of the way
- For 3/8" hose size
- For tractor coiled air, trailer slider hose applications

Part Number	Description	Replaces
GT-5500-12	2 Hose 1/2" separator	17-150
GT-5500-38	2 Hose 3/8" separator	17-150
GT-5501-12	4 Hose 1/2" separator	17-151
GT-5501-38	4 Hose 3/8" separator	17-151

Hose Holders



GT-5001-4



GT-5001-3

Part Number	Description	Replaces
GT-5001-2	2-Hose holder, .75" hole size	17-156
GT-5001-3	3-Hose holder, .75" hole size	17-157
GT-5001-4	4-Hose holder, .75" hole size	17-158



GT-5001-2

Beam Clip



GT-5012

Slider Hose Undercarriage Tender Kits

Complete with:

- Beam clip GT-5012
- Heavy Duty spring
- 2 or 3-Hole clamp hanger (5001-2, 5001-3)

Part Number	Description
GT-5010	13" Heavy Duty spring with 2-hole clamp
GT-5011	13" Heavy Duty spring with 3-hole clamp

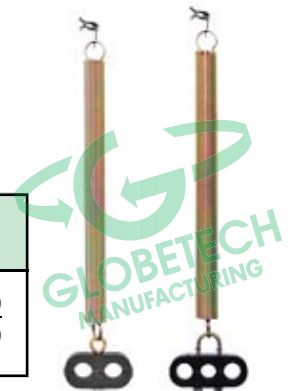

GT-5010 GT-5011



Pogo Sticks

A complete line of Pogo Sticks to fit all needs, no matter what the height requirement is or material.

- Zinc Dichromate
- Chrome
- Stainless Steel (Type 304SS)
- Black Powder-Coated

Zinc Dichromate Pogo Sticks

Part No.	Length	Description	Replaces Tectran
GT-5380	24"	Yellow Zinc	9400D-2
GT-5370	40"	Yellow Zinc	9400E-2
GT-5381	50"	Yellow Zinc	9400L-2

Chrome Pogo Sticks

Part No.	Length	Description	Replaces Tectran
GT-5382	24"	Chrome	9400F-2
GT-5371	40"	Chrome	9400G-2
GT-5383	50"	Chrome	9400M-2

Stainless Steel (Type 304SS) Pogo Sticks Pogo Sticks

Part No.	Length	Description	Replaces Tectran
GT-5384	24"	Stainless Steel	9400J-2
GT-5385	40"	Stainless Steel	9400H-2

Black Pogo Sticks

Part No.	Length	Description
GT-5372	40"	Black Powder-Coated





ABS Sensor Service Kit

Meritor Style ABS Sensors

Part No.	Description	Harness Length	Replaces Meritor Wabco
GTA-R955349	Straight	2 ft	R955349
GTA-R955329	Straight	5.6 ft	R955329
GTA-R955337	Straight	5.8 ft	R955337
GTA-R955335	90 degree	1 ft	R955335
GTA-R955336	90 degree	3 ft	R955336
GTA-R955365	90 degree	4.6 ft	R955365
GTA-R955341	90 degree	5.8 ft	R955341
GTA-R955342	90 degree	6.6 ft	R955342



Bendix Style ABS Sensors

Part No.	Description	Connector Type	Harness Length	Replaces Bendix
GTA-801544	90 degree	DIN	1 ft	801544
GTA-801545	90 degree	Deutsch	8.6 ft	801545
GTA-801546	90 degree	Deutsch	5 ft	801546



ABS Sensor Clip

Part No.	Length	I.D.	O.D.	Replaces Tectran
GTA-8997598154	1.18"	.63"	.71"	S899-759-815-4



Selecting a Slack Adjuster

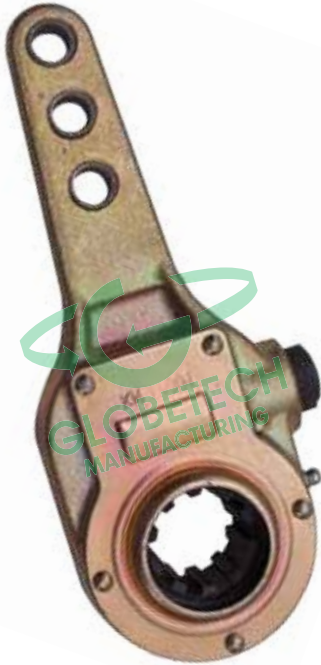

1. Determine if straight or offset arm If offset determine if RH or LH needed.
2. Identify spline size (diameter and number of teeth).
3. Select model needed.
4. Determine the arm hole used (if slack contains more than one).
5. Identify bushing diameter.
6. Measure from center of arm hole used to center of splined hole to determine arm length (A).

All Globetech slacks meet the following criteria:

TS16949 Certified
 Meet SAE J1461-91 & SAE Ji512-90 Standards
 Torque Rating:
 20,000 - 26,000 inch lbs.
 or 2,300 - 3,000 Newton Meter
 Life time: More than 200,000 cycles

Manual Straight Arm Slack Adjusters Without Clevis

	Part Number	Spline	A	B	C	Replaces
	GTA-KN44051	1-1/2" - 28	5"	6"		Batco 05-328 Bendex BWP M-638 Euclid Leland Meritor Midland Norforge Spicer Sirco S2011A
	GTA-KN44071	1-1/2" - 28	5"	6"	7"	Batco Bendex 286965 BWP M-3373 Euclid E-2458S Leland L-1308EC Meritor R824003 Midland KN44071 Norforge A-7085 Spicer 10-355 Sirco S2022A



Manual Straight Arm Slack Adjusters Without Clevis

	Part Number	Spline	A	B	C	Replaces	
	GTA-KN44061	1-1/2" - 28	5-1/2"	6-1/2"		Batco 05-237 Bendex 288753 BWP M-2577 Euclid E-2459S Leland L-1648EC Meritor R824004 Midland KN44051 Norforge A-7094 Spicer 10-368 Sirco S2019A	
	GTA-KN51010	1-1/2" - 28	6"			Batco 05-251 Bendex BWP M-3374 Euclid E-5498 Leland L-2349 Meritor A3275J686 Midland KN51010 Norforge A-7228 Spicer Sirco S2023	
				Curved Arm For 12-1/4" "Q" Brakes			
	GTA-KN44041	1-1/2" - 37	6"				Batco 05-240 Bendex 283411 BWP M-474 Euclid E-1574S Leland L-841EC Meritor R824007 Midland KN44041 Norforge A-7100 Spicer 10-367 Sirco S2012A
	GTA-KN48031	1-1/4" - 10	4-1/2"	5-1/2"		Batco 05-214 Bendex 278302 BWP M-3375 Euclid E-4904 Leland L-2494 Meritor R822009 Midland KN8031 Norforge A-7134 Spicer 10-399 Sirco S2026	
			For all 1-1/4" - 10 Spline Camshafts				

Air Brakes



Manual Slack Adjusters

- Zinc-Dichromate Finish
- Positive Locking Adjustment
- Heat Treated Alloy Gears
- Threaded Grease Fitting
- Bi-Directional Body Design

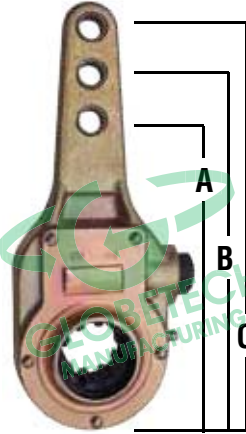
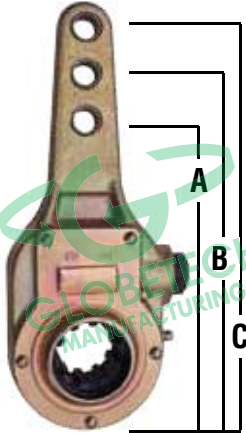

Part Number	Spline	A	B	C	Replaces
GTA-KN55001	1-1/4" - 24	5-1/2"			Batco 05-254
					Bendex M-3984
		For Meritor 15" x 4" "Q" Brakes			Euclid E-9102
					Leland L-3225
					Meritor R825020
					Midland KN55001
					Norforge
					Spicer
					Sirco S2024
GTA-KN47081	1-1/2" - 10	5"	6"		Batco 278010
					Bendex M-452
					BWP E-1063HD
					Euclid L-562
					Leland R823000
					Meritor KN47081
					Midland A-7022
					Norforge M16WR105
					Spicer S2021A
					Sirco
GTA-KN47001	1-1/2" - 10	5"	6"		Batco 278010
					Bendex M-452
					BWP E-1063HD
					Euclid L-562
					Leland R823000
					Meritor KN47081
					Midland A-7022
					Norforge M16WR105
					Spicer S2010A
					Sirco
GTA-KN47011	1-1/2" - 10	5-1/2"	6-1/2"		Batco 05-201
					Bendex 278321
					BWP M-457
					Euclid E-940BK
					Leland L-845EC
					Meritor R824001
					Midland KN47011
					Norforge A-7044
					Spicer 10-354
					Sirco S2020A
GTA-KN51000	1-1/2" - 10	6"			Batco 05-250
					Bendex 278084
					BWP M-475
					Euclid E-2091
					Leland L-1275
					Meritor
					Midland KN51000
					Norforge A7225
					Spicer M12WR101
					Sirco S2025
		Curved Arm For 12-1/4" Brakes			

all references to competitors' part numbers are for cross reference purposes only





Automatic Slack Adjusters



Part Number	Spline	Arm Length	Replaces
GTA-065164	1-1/4" - 10	5-1/2"	Bendex 065164 Gunitite AS1136/AS1152 Midland CS56036 Sirco SA2164
GTA-065167	1-1/4" - 24	5-1/2"	Bendex 065167 Gunitite AS1138/AS1154 Midland CS56038 Sirco SA2167
GTA-065170	1-1/2" - 10	5-1/2"	Bendex 065170 Gunitite AS1132/AS1147 Midland CS56032 Sirco SA2170
GTA-065172	1-1/2" - 10	6"	Bendex 065172 Gunitite AS1133/AS1146 Midland CS56033 Sirco SA2172
GTA-065174	1-1/2" - 28	6"	Bendex 065174 Gunitite AS1140/AS1149 Midland CS56040 Sirco SA2174
GTA-065175	1-1/2" - 28	6"	Bendex 065175 Gunitite AS1141/AS1151 Midland CS56041 Sirco SA2175
GTA-065178	1-5/8" - 37	5-1/2"	Bendex 065178 Gunitite CS56043 Midland SA2178 Sirco
GTA-065179	1-5/8" - 37	6"	Bendex 065179 Gunitite AS1144 Midland CS56044 Sirco SA2179
GTA-R801073	28 DIA. 1-1/2"	Drillings 5.5"	Meritor R801073
GTA-R801074	28 DIA. 1-1/2"	Drillings 6"	Meritor R801074



Automatic Slack Adjusters

	Part Number	Spline	A	B	C	Replaces
	GTA-40010144	1-1/2" - 28	6"			Batco Bendex BWP Euclid Leland Meritor Midland Norforge Spicer Sirco E-6918A R806016 40010144 SA10144
	GTA-40010142	1-1/2" - 10	For Standard Drive Axle Brakes		5" - 6"	Batco Bendex BWP Euclid Leland Meritor Midland Norforge Spicer Sirco E-6923B R806023 40019142 SA10102
	GTA-40010143	1-1/2" - 10	5-1/2" - 6-1/2"	For Standard Drive Axle Brakes		Batco Bendex BWP Euclid Leland Meritor Midland Norforge Spicer Sirco E-6924B R806022 SA10103
	GTA-40010140	1-1/2" - 28	5" - 6"	For Standard Drive Axle Brakes		Batco Bendex BWP Euclid Leland Meritor Midland Norforge Spicer Sirco E-6925B R806024 SA10100

all references to competitors' part numbers are for cross reference purposes only



Automatic Brake Adjusters

	Part Number	Spline	Arm Length	Replaces
	GTA-40010141	1-1/2" - 28	5-1/2" - 6-1/2"	Batco Bendex BWP Euclid E-6927B Leland Meritor R806004/26 Midland 40010141 Norforge Spicer Sirco SA10101
		For Standard Drive Axle Brakes		
	GTA-40010306	1-1/2" - 10	6"	Batco Bendex BWP Euclid E-6928 Leland Meritor R806007 Midland 40010306 Norforge Spicer Sirco SA10306
		For 12-1/4" Trailer Axle Brakes		
	GTA-40010305	1-1/2" - 28	6"	Batco Bendex BWP Euclid E-6933 Leland Meritor R806006 Midland 40010305 Norforge Spicer Sirco SA10305
For 12-1/4" Trailer Axle Brakes				
GTA-40010215	1-1/2" - 10	5-1/2"	Batco Bendex BWP Euclid E-6940 Leland Meritor R806021 Midland 40010215 Norforge Spicer Sirco SA10215	
	For 16-1/2" Trailer Axle Brakes			
GTA-40010216	1-1/2" - 10	6"	Batco Bendex BWP Euclid E-6936 Leland Meritor R806015 Midland 40010216 Norforge Spicer Sirco SA10216	
		For 16-1/2" Trailer Axle Brakes		

Air Brakes



Automatic Brake Adjusters

	Part Number	Spline	Arm Length	Replaces
	GTA-40010211	1-1/2" - 28 For 16-1/2" Trailer Axle Brakes	5-1/2"	Batco Bendex BWP Euclid Leland Meritor Midland Norforge Spicer Sirco E-6944 R806019 40010211 SA10211
	GTA-40010212	1-1/2" - 28 For 16-1/2" Trailer Axle Brakes	6"	Batco Bendex BWP Euclid Leland Meritor Midland Norforge Spicer Sirco E-6942 R806013 40010212 SA10212
	GTA-40010214	1-5/8" - 37 For 16-1/2" Fruehauf Trailer Axle Brakes	6"	Batco Bendex BWP Euclid Leland Meritor Midland Norforge Spicer Sirco E-6946 R806014 40010214 SA10214

Globetech Slack Adjusters are manufactured to OEM standards
Automatic Slack Adjusters available to replace: Crewson, Bendix, Haldex and Meritor



Crewson Style Standard Automatic Slack Adjusters

Part No.	Replaces Crewson	Chamber Size	Spline Size	Clevis	Arm Length
GTA-21102	21102	ALL	1-1/2"-10	5/8"-18 STR	5.5, 6.5
GTA-21103	21103	ALL	1-1/2"-10	5/8"-18 STR	5.0, 6.0
GTA-22102	22102	ALL	1-1/2"-28	5/8"-18 STR	5.5, 6.5
GTA-22103	22103	ALL	1-1/2"-28	5/8"-18 STR	5.0, 6.0
GTA-23102	23102	ALL	1-5/8"-37	5/8"-18 STR	5.5, 6.5
GTA-24100	24100	ALL	1-1/4"-10	5/8"-18 STR	5.5, 6.5
GTA-24102	24102	ALL	1-1/4"-10	5/8"-18 STR	5.5, 6.5
GTA-24103	24103	ALL	1-1/4"-10	5/8"-18 STR	5.0
GTA-25100	25100	ALL	1-1/4"-10	5/8"-18 STR	5.5
GTA-25102	25102	ALL	1-1/4"-24	5/8"-18 STR	5.5, 6.5
GTA-25103	25103	ALL	1-1/4"-24	5/8"-18 STR	5.0, 6.0

Crewson Style Auto-Check Slack Adjusters

Part No.	Replaces Crewson	Chamber Size	Spline Size	Clevis	Arm Length
GTA-34100	34100	20/24	1-1/4"-10	5/8"-18 STR	5.5
GTA-34200	34200	16	1-1/4"-10	1/2"-20 STR	5.5
GTA-35100	35100	20/24	1-1/4"-24	5/8"-18 STR	5.5
GTA-35200	35200	16	1-1/4"-24	1/2"-20 STR	5.5
GTA-41100	41100	30	1-1/2"-10	5/8"-18 STR	5.5
GTA-41106	41106	30	1-1/2"-10	5/8"-18 STR	6.0
GTA-42100	42100	30	1-1/2"-28	5/8"-18 STR	5.5
GTA-42106	42106	30	1-1/2"-28	5/8"-18 STR	6.0
GTA-43100	43100	30	1-5/8"-37	5/8"-18 STR	5.5
GTA-43106	43106	30	1-5/8"-37	5/8"-18 STR	6.0



The auto-check stroke indicator attaches to the automatic brake adjuster; which eliminates the need to crawl under vehicles to determine air chamber stroke. Not interchangeable with other slack adjusters.



Slack Adjuster Cross Reference

Haldex/Midland	Manual Globetech	Page No.	Automatic Bendix	Globetech	Page No.
KN44041	GTA-44041	106	065164	GTA-065164	111
KN44051	GTA-44051	105	065167	GTA-065167	111
KN44061	GTA-44061	106	065170	GTA-065170	111
KN44071	GTA-44071	105	065172	GTA-065172	111
KN47001	GTA-47001	107	065174	GTA-065174	111
KN47011	GTA-47011	107	065175	GTA-065175	111
KN47081	GTA-47081	107	065178	GTA-065178	111
KN48031	GTA-48031	106	065179	GTA-065179	111
KN51000	GTA-51000	108	Meritor	Globetech	Page No.
KN51010	GTA-51010	106	R801073	GTA-R801073	111
KN55001	GTA-55001	107	R801074	GTA-R801074	111
Haldex/Midland	Automatic Globetech	Page No.	Crewson	Globetech	Page No.
40010140	GTA-40010140	108	21102	GTA-21102	112
40010141	GTA-40010141	109	21103	GTA-21103	112
40010142	GTA-40010142	108	22102	GTA-22102	112
40010143	GTA-40010143	108	22103	GTA-22103	112
40010144	GTA-40010144	108	23102	GTA-23102	112
40010144	GTA-40010144	108	24100	GTA-24100	112
40010211	GTA-40010211	110	24102	GTA-24102	112
40010212	GTA-40010212	110	24103	GTA-24103	112
40010214	GTA-40010214	110	25100	GTA-25100	112
40010215	GTA-40010215	109	25102	GTA-25102	112
40010216	GTA-40010216	109	25103	GTA-25103	112
40010305	GTA-40010305	109	34100	GTA-34100	112
40010306	GTA-40010306	109	34200	GTA-34200	112
			35100	GTA-35100	112
			35200	GTA-35200	112
			41100	GTA-41100	112
			43106	GTA-41106	112

Parts listed in this catalog are not necessarily manufactured by the original equipment manufacturer and any reference to the trademarks or part numbers of others are for cross reference informational purposes only. The photos provided herein are provided only for illustrative purposes. The actual products supplied may differ. The trademarks of others referred to herein are owned by their respective companies and are not affiliated in any way with Globetech Manufacturing Inc. No representation is made with respect to the source of manufacturer of any particular part. While every efforts is made to provide accurate information, no guarantee is provided as to the accuracy of the information contained herein. We are not responsible for typographical errors.

Valve Index

Bendix	Globetech	Haldex	Globetech
284412 (DV-2)	GTA-284412	KN16743	GTA-16743
277863 (E-3)	GTA-277863	KN23000	GTA-23000
286171 (E-6)	GTA-286171	KN20030	GTA-20030
286773 (E-7)	GTA-283773	KN20031	GTA-20031
280479 (DC-1)	GTA-280479	KN28600 (FF-2)	GTA-28600
278414 (DC-4)	GTA-278414	KN28601 (FF-2)	GTA-28601
278415 (DC-4)	GTA-278415	KN20541	GTA-20541
276566 (PP-1)	GTA-276566	KN26000	GTA-26000
276567 (PP-1)	GTA-276567	KN27000	GTA-27000
280479 (DC-1)	GTA-280479	KN3546	GTA-3546
229635	GTA-229635	KN28500	GTA-28500
275491 (D-2)	GTA-G8602	KN28510	GTA-28510
279472 (LP-3)	GTA-279472	KN28520	GTA-28520
228750 (LP-3)	GTA-228750	KN30300	GTA-30300
288239 (PP-7)	GTA-288239	KN30400	GTA-30400
065066 (QR-N)	GTA-065066	KN4688	GTA-4688
065067 (QR-N)	GTA-065067		
		Neway	Globetech
229859 (QR-1A)	GTA-229859	K910058	GTA-910058
229860 (QR-1B)	GTA-229860	90054007	GTA-90054007
289714 (QR-1C)	GTA-289714	90554241	GTA-90554241
289182 (QR-1C)	GTA-289182	90554243	GTA-90554243
065104 (R-12)	GTA-065104	90054079	GTA-90054079
102626 (R-12)	GTA--102626	90054088	GTA-90054088
103009 (R-12)	GTA-103009	90054107	GTA-90054107
103028 (R-14)	GTA-103028	90054074	GTA-90054074
103010 (R-14)	GTA-103010	90054075	GTA-90054075
281865 (RE-6)	GTA-281865	90054076	GTA-90054076
		Sealco	Globetech
065145 (BP-R1)	GTA-065145	110500	X-5
065146 (BP-R1)	GTA-065146	110700	GTA-110700
286370 (R-8)	GTA-286370	110800	GTA-110800
131081 (ST-4)	GTA-131081	17600B	GTA-17600
284143 (ST-3)	GTA-284143	110170	GTA-110170
205105 (ST-1)	GTA-205105	110171	GTA-110171
065437 (SR-5)	GTA-065437	140280	GTA-140280
065439 (SR-5)	GTA-065439	140270	GTA-140270
102761 (SR-2)	GTA-102761	996555	GTA-996555
228600 (SL-4)	GTA-228600	110415	GTA-110415
101112 (SR-4)	GTA-101112	110380	GTA-110380
101622 (SR-4)	GTA-101622	110197	GTA-110197
279000 (TP-3)	GTA-279000	110139	GTA-110139
Fuller	Globetech	110410	GTA-110410
A-470	GTA-A-470	21600	GTA-21600
A-5000	GTA-A-5000	110515	GTA-110515
Midland	Globetech	616	GTA-616
12353	GTA-12352	110191	GTA-110191
		17600B-1	GTA-17600B-1
		110376	GTA-110376
		110205	GTA-110205
		2550	GTA-2550



Air Regulator Valves



All ports: 1/8" NPT
 Non-adjustable preset
 at 57-65 PSI
 Replaces: Haldex KN16743

Part Number	Description
GTA-16743	Oil regulator valve

Automatic Reservoir Drain Valves



Overall height: 2-3/8"
 Overall width: 3-3/4"
 Port A: 3/8" PT
 Port B: 3/8" PT
 Adapter: 1/4" PT
 Replaces: Bendix 284412 (DV-2)

Part Number	Description
GTA-284412	Automatic reservoir drain valve

Brake Valves

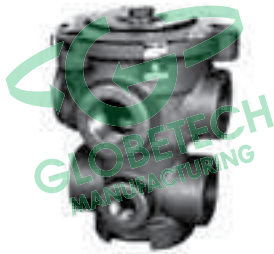

Overall height: 4-5/16"
 Delivery Ports: (4) 1/2" PT
 Auxiliary Ports: none
 Replaces: Bendix 277863 (E-3)

Part Number	Description
GTA-277863	Brake valve (basic)



Overall height: 5-5/8"
 Supply Ports: (2) 3/8" PT
 Delivery Ports: (2) 3/8" PT
 Exhaust at bottom
 Replaces: Bendix 286171 (E-6)

Part Number	Description
GTA-286171	Dual brake valve with pedal

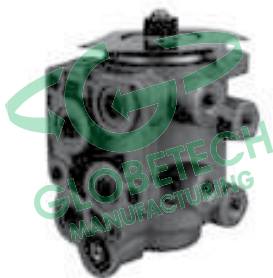

*Overall height: 5-1/16"
 Rear ports: (4) 1/2"
 Side Ports: (8) 1/4"
 Mounting Studs: (3) 1-1/2" L
 Replaces: Bendix 286773 (E-7)

Part Number	Description
GTA-286773*	Dual brake valve (basic) 3 mounting bolts installed
GTA-286771	Dual brake valve (basic)

CAB Control Valves

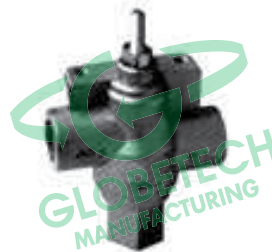

Delivery Port: 1/4" NPT
 Supply Port: 1/4" NPT
 Exhaust Port: 1/4" non-threaded
 Push/pull, hand control
 Knob/name plate not included
 Replaces: Sealco 17600

Part Number	Description
GTA-17600	CAB control valve



Check Valves & Control Valves



Length: 2.47"
 Inlet/Outlet: 1/2"
 Style: Heavy Duty
 Replaces: Haldex KN23000



3 ports: Pipe thread dimension 3/8" (all ports)
 Replaces: Bendix 280479 (DC-1)

Part Number	Description
GTA-23000	Single check valve, 1/2"
GTA-23800	Single check valve, 3/8"

Part Number	Description
GTA-280479	Double check valve



GTA-278614: 3 ports, pipe thread dimension 3/8"
 Replaces: Bendix 278614 (DC-4)
 GTA-278615: 3 ports, pipe thread dimension 1/4"
 Replaces: Bendix 278615 (DC-4)



Body height: 2-1/2"
 Delivery ports: (2) 1/8" PT
 Supply ports: (1) 1/8" PT
 Lever: Steel with Chrome Finish
 Replaces: Bendix 229635

Part Number	Description
GTA-278614	Double check valve
GTA-278615	Double check valve

Part Number	Description
GTA-229635	Control valve

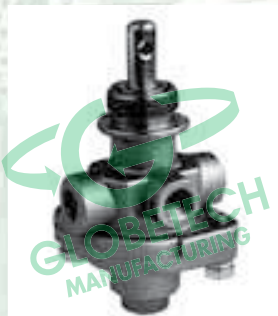

Overall height: 3-19/32"
 Delivery ports: (2) 1/8" PT
 Supply ports: (1) 1/8" PT
 Automatic Release Pressure:
 GTA-276566 20 PSI
 GTA-276567 40 PSI
 Replaces: Bendix 276566 (PP-1)
 Bendix 276567 (PP-1)



Control ports: 3/8" NPT
 Reservoir ports: 1/2" NPT
 Delivery ports: 3/8" NPT
 Includes bracket
 Replaces: Sealco 110570

Part Number	Description
GTA-276566	Control valve
GTA-276567	Control valve

Part Number	Description
GTA-110570	Control valve



Check Valves & Control Valves



Push/pull, hand operated
 Delivery port: 1/4"
 Supply port: 1/4"
 Exhaust port: 1/4" non threaded
 Replaces: Haldex KN20030
 KN20031

Part Number	Description
GTA-20030	Dash control valve
GTA-20031	Dash control valve



Part Number	Description
GTA-M7102	Dash control valve
GTA-M7102-K	Knobs only

Filter Assemblies

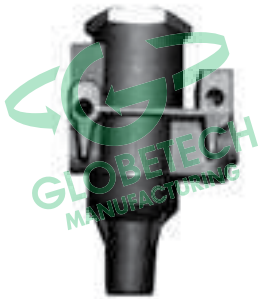

All ports: 1/8" NPT
 Non-adjustable
 Preset at 57-65 PSI
 Replaces: Fuller A-4740

Part Number	Description
GTA-A4740	Filter assembly

Full Function Valves



Spring brake ports: (2) 3/8"
 Service brake ports: (4) 3/8"
 Supply ports: (1) 3/8"
 Control ports: (1) 1/4"
 Reservoir ports: (1) GTA-28600 3/4"
 GTA-28601 1/2"
 Crack Pressure: 3 PSI
 Replaces: Haldex KN28600 (FF-2)
 KN28601 (FF-2)

Part Number	Description
GTA-28600	Full function valve
GTA-28601	Full function valve

Governors

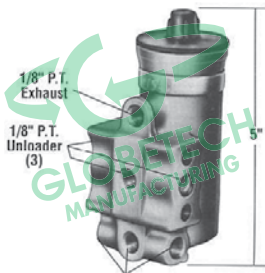

Pressure: 100-120 PSI,
 non-adjustable
 Replaces: Bendix 275491 (D-2)

Part Number	Description
GTA-G8602	Governor

Hand Control Valves



Delivery Port: 1/4"
 Supply Port: 1/4"
 Control Port: 1/4"
 Replaces: Haldex KN20541

Part Number	Description
GTA-20541	Hand control valve



Hand Control Valves

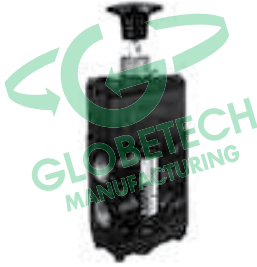

Auxiliary lift axle valve
2 positions, manual
Replaces: Neway K910058

Part Number	Description
GTA-910058	Hand control valve

Height Control Valves

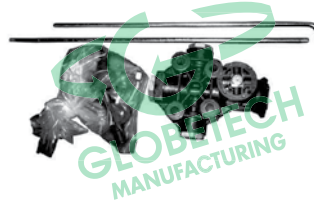

Body constructed in Engineering Grape plastic
Horizontal arm length: 12" max
Vertical arm length: 14"
Axle bracket linkage: vertical
Replaces: Haldex KN27000

Part Number	Description
GTA-27000	Height control valve



Controlled response
Fittings provided: 1/4"
Exhaust port: 1/8"
Air Spring port: 1/8"
Supply port: 1/8"
Replaces: Neway 90054007

Part Number	Description
GTA-90054007	Height control valve



Max length: 14"
Replaces: Haldex 48100367
Tectran 80-1006AL

Part Number	Description
GT-Q500	Leveling link, 6 per box

Leveling Valves

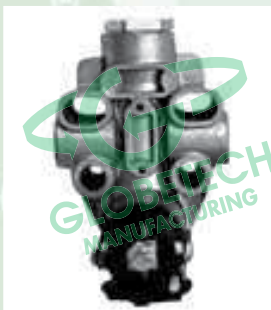

Immediate Response
All ports: GTA-90554241 1/4" NPT
GTA-90554243 12mm x 1.5
Replaces: Neway 90554241
90554243

Part Number	Description
GTA-90554241	Leveling valve, (IR)
GTA-90554243	Leveling valve, (IR)

Low Pressure Indicators



Body height: 1-15/16"
Pipe Thread: 1/4"
Cut-out Pressure: GTA-279472 75 - 6
GTA-228750 60 - PSI
Single Terminal - GTA-279472
Double Terminal - GTA-228750
Replaces: Bendix 279472 (LP-3)
228750 (LP-3)

Part Number	Description
GTA-279472	Low pressure indicator
GTA-228750	Low pressure indicator



Multifunction Valves

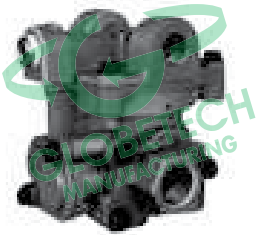

Trailer spring brake valve
 Delivery ports: (4) 3/8" PT
 Supply ports: (1) 3/8" PT
 Reservoir (A): 1/2" PT
 Reservoir (B): 3/8" PT
 Control ports: (1) 3/8" PT
 Closing Pressure: 55 PSI
 Replaces: Haldex KN 26000 (RT-4)

Part Number	Description
GTA-26000	Multifunction valve

Pilot Valves



3 Way
 Replaces: Neway 90054079
 and 90054088

GTA-90054079 GTA-90054088

Part Number	Description
GTA-90054079	Pilot valve
GTA-90054088	Air suspension valve

Pressure Protection Valves



Williams style with filter
 Replaces: Neway 90054107
 Replaces: Williams WM778A1

Part Number	Description
GTA-90054107	Pressure protection valve

Push/Pull Valves

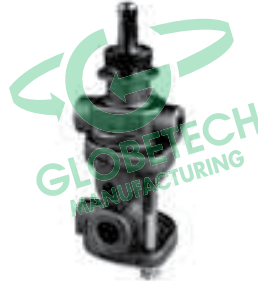

Overall height: 4-25/32"
 Delivery ports: (1) 1/4" PT
 Supply ports: (1) 1/8" PT
 Control ports: (1) 1/8" PT
 Automatic Release Pressure: 40 PSI
 Replaces: Bendix 288239 (PP-7)

Part Number	Description
GTA-288239	Push/Pull valve



All ports: 1/8" NPT
 Replaces: Haldex KN3546

Part Number	Description
GTA-3546	Push/pull type valve transmission range

Quick Release Valves



Overall height: 2-1/4"
 Delivery ports: (2) 3/8" PT
 Supply ports: GTA-065066 (1) 1/2"
 GTA-065067 (1) 3/8"
 Crack Pressure: 1 PSI
 Mounting holes: 11/32" dia., 1-1/2" C-C
 Replaces: Bendix 065066 (QRN)
 Bendix 065067 (QRN)

Part Number	Description
GTA-065066	Quick release valve
GTA-065067	Quick release valve



Quick Release Valves

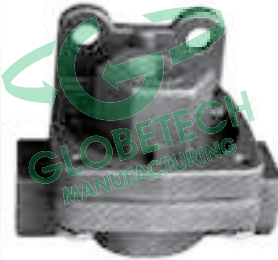

Overall height: 2-1/2"
 Overall width: 3-1/4"
 Delivery ports: (2) 3/8" PT
 Supply ports: GTA-229859 (1) 3/8"
 GTA-229860 (1) 1/2"
 Crack Pressure: 1 PSI
 Mounting holes: 11/32" dia., 1-1/2" C-C
 Replaces: Bendix 229859 (QR-1A)
 Bendix 229860 (QR-1B)

Part Number	Description
GTA-229859	Quick release valve
GTA-229860	Quick release valve



Overall height: 2-11/16"
 Delivery ports: GTA-289714 (2) 3/8" PT
 GTA-289182 (2) 1/4" PT
 Supply ports: (1) 1/4" PT
 Balance: (1) 1/4" PT
 Mounting holes: 11/32" dia., 1-1/2" C-C
 Replaces: Bendix 289714 (QR-1C)
 Bendix 289182 (QR-1C)

Part Number	Description
GTA-289714	Quick release valve
GTA-289182	Quick release valve

Relay Valves



Body height: 3-7/8"
 Delivery ports: (4) GTA-065104 = 3/8" PT
 GTA-102626 = 1/2" PT
 Supply ports: (1) 1/2" PT
 Service ports: (1) 1/4" PT
 Crack Pressure: 4 PSI
 Replaces: Bendix 065104 (R-12)
 102626 (R-12)

Part Number	Description
GTA-065104	Relay valve, vertical ports
GTA-102626	Relay valve, vertical ports

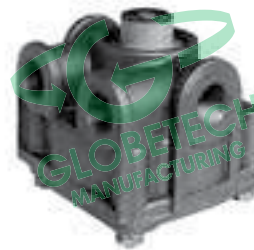

Body height: 3-7/8"
 Delivery ports: (2) 1/2" PT
 Supply ports: (2) 3/4" PT
 Service ports: (1) 1/4" PT
 Crack Pressure: 4 PSI
 Replaces: Bendix 103009 (R-12)

Part Number	Description
GTA-103009	Relay valve, horizontal ports 3/4" G port

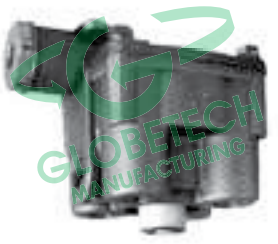

Body height: 4-7/16"
 Delivery ports: (4) 1/2" PT
 Supply ports: (1) 1/2" PT
 Service ports: (1) 1/4" PT
 Balance ports: (1) 1/8" PT - located
 beneath
 exhaust plate
 Crack Pressure: 4 PSI
 Replaces: Bendix 103028 (R-14)

Part Number	Description
GTA-103028	Relay valve, vertical ports



Body height: 4-7/16"
 Delivery ports: (2) 1/2" PT
 Supply ports: (2) 3/4" PT
 Service ports: (1) 1/4" PT
 Balance ports: (1) 1/8" PT - located
 beneath
 exhaust plate
 Crack Pressure: 4 PSI
 Replaces: Bendix 103010 (R-14)

Part Number	Description
GTA-103010	Relay valve

Air Brakes



Relay Valves

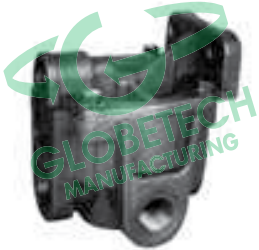

Part Number	Delivery Ports (2)	Service/Control Ports (1)	Supply/Reservoir Port (A)	Supply/Reservoir (Port (B))	Control Position	Includes Plug	Replaces Haldex#
GTA-28500	3/8"	1/4" NPT	3/8"	3/8"	90°	(1) 3/8"	KN28500
GTA-28510	3/8"		3/8"	1/2"		(1) 1/2", (1) 3/8"	KN28510
GTA-28520	1/2"		1/2"	1/2"		(1) 1/2"	KN28520

RG-2 relay valve

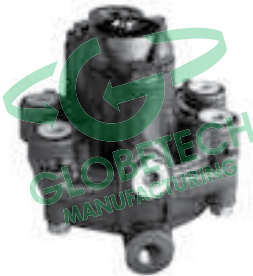

Body height: 5-5/64"
 Delivery ports: (2) 1/4" PT
 APT Delivery: (2) 3/8" PT
 Supply ports: (A) 3/4" PT
 (B) 3/8" PT
 Service ports: (1) 1/4" PT
 Emergency ports: (1) 1/4" PT
 Replaces: Bendix 281865 (RE-6)

Part Number	Description
GTA-281865	Relay valve, emergency



Service emergency relay valve (serv)
 For use on pre-121 trailers (before 1974)
 Crack Pressure: 4.5 PSI
 Replaces: Midland 12352

Part Number	Description
GTA-12352	Relay valve

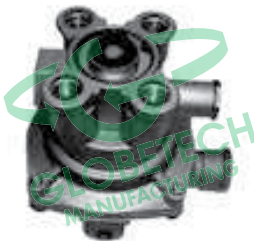

Delivery ports: (4) 3/8" NPT
 Supply ports: (1) 1/4" NPT
 Control ports: (1) GTA-110200 1/4" NPT
 GTA-110205 3/8" NPT
 Reservoir ports: (1) 3/4" NPT
 Ratio feature: yes
 Normal crack pressure: 4.5 PSI
 Replaces: Sealco 110200
 Sealco 110205

Part Number	Description
GTA-110200	Relay valve, emergency
GTA-110205	Relay valve, emergency

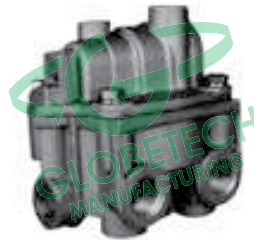

Overall height: 5-13/32"
 Delivery ports: (4) 3/8" PT
 Supply ports: (1) 1/2" PT
 Control ports: (1) 1/8" PT
 Service ports: (1) 1/4" PT
 Crack Pressure: GTA-065145 4 PSI
 GTA-065146 5.5 PSI
 Replaces: Bendix 065145 (BP-R1)
 Bendix 065146 (BP-R1)

Part Number	Description
GTA-065145	Relay valve, bobtail brake proportioning
GTA-065146	Relay valve, bobtail brake proportioning



Relay Valves

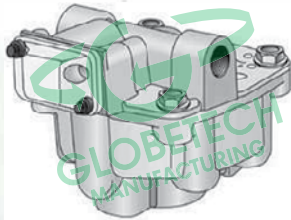

Delivery ports: (4) GTA-30300 1/4"
GTA-30400 3/4"
Reservoir ports: (1) 3/4"
Service inlet: (1) 1/4"
Emergency inlet: (1) 1/4"
Includes nipple
Crack Pressure: 3 PSI
Replaces: Haldex KN30300
KN30400

Part Number	Description
GTA-30300	Relay valve, emergency
GTA-30400	Relay valve, emergency

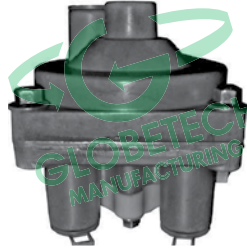

Delivery ports: (4) 3/8" NPT
Control ports: (1) 3/8" NPT
Reservoir ports: (1) 3/4" NPT
Normal crack pressure: 4 PSI
Replaces: Sealco 110415

Part Number	Description
GTA-110415	Relay valve. 4 port service



Supply port: 3/8" PT
Control port: 3/8" PT
Reservoir port A: 1/2" PT
Reservoir port B: 1/2" PT
Delivery port: 3/8"
Replaces: Sealco 110197

Part Number	Description
GTA-110197	Relay valve. 2 port service

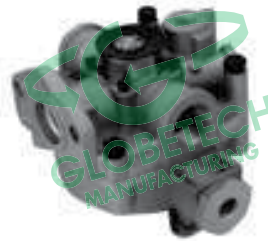

Body height: 3-19/32"
Body width: 5-13/16"
Delivery ports: (2) 1/2" PT
Delivery ports: (1) 1/4" PT
Supply ports: (2) 3/4" PT
Service port: (1) 1/4" PT - located at 90°
Balance ports: (1) 1/8" PT - located under exhaust cover
Replaces: Bendix 286370 (R-8)

Part Number	Description
GTA-286370	Relay valve

Safety Valves Assemblies

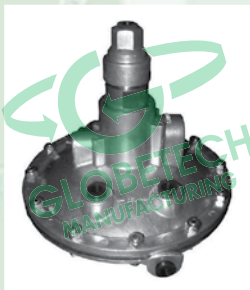

Delivery Ports: (4) 1/4" NPT
Supply Ports: (1) 1/4" NPT
Control Ports: (1) 1/4" NPT
Reservoir Ports: (1) 1/2" NPT
Normal Crack Pressure: 1.5 PSI
Replaces: Sealco A1000S

Part Number	Description
GTA-A10005	Relay valve with brass, emergency



Pressure: 250 PSI
Thread: 1/2" NPT
Holes: 1
Used with Tu-Flo 550 and 750 compressor
Replaces: Bendix 131081 (ST-4)

Part Number	Description
GTA-131081	Safety valve assembly



Safety Valves Assemblies

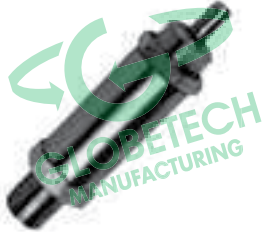

GTA-205105
 All ports: 1/4" NPT
 Replaces: Bendix 205105 (ST-1)
 GTA-284143
 PT: 3/8"
 Pressure setting: 150 PSI
 Replaces: Bendix 284143 (ST-3)

Part Number	Description
GTA-205105	Safety valve assembly
GTA-284143	Safety valve assembly

Solenoid Valves

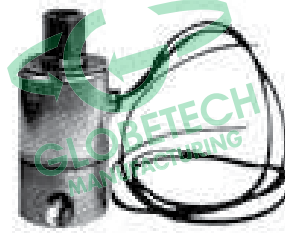

GTA-90054074
 All ports: 1/4" NPT
 Replaces: Neway 90054074
 90054075

Part Number	Description
GTA-90054074	Solenoid valve (closed) directional control
GTA-90054075	Solenoid valve (open) directional control

Spring Brake Valves



12 volt direct current
 Manual override
 Universal - normally opened or closed
 Replaces: Neway 90054076

Part Number	Description
GTA-90054076	Solenoid valve directional control

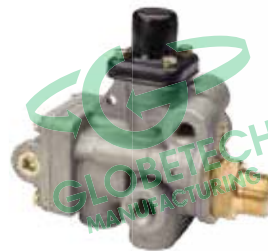

Delivery ports: (4) 3/8" PT
 Service ports: (1) 1/4" PT
 Service/Spring brake reservoir: (1) 1/4" PT
 Trailer Supply: (1) 1/4" PT
 Trailer Service: (1) 1/4" PT
 Reservoir mounting: (1) GTA-065437 male 3/4" PT
 GTA-065439 male 1/2" PT
 Replaces: Bendix 065437 (SR-5)
 065439 (SR-5)

Part Number	Description
GTA-065437	Spring brake valve
GTA-065439	Spring brake valve



Delivery ports: (4) 3/8" NPT
 Supply ports: (1) 3/8" NPT
 Control ports: (1) 3/8" NPT
 Reservoir (A): 1/2" NPT
 Reservoir (B): GTA-110170 1/2" NPT
 GTA-110171 3/8" NPT
 Cover Rotate: GTA-110170 none
 GTA-110171 90 degrees
 Replaces: Sealco 110170
 110171

Part Number	Description
GTA-110170	Spring brake valve
GTA-110171	Spring brake valve



Body height: 4-3/16"
 Body width: 4-5/8"
 Delivery ports: (1) 1/4" PT
 Supply ports: (1) 1/4" PT
 Control ports: (1) 1/4" PT
 Reservoir ports: (1) 1/4" PT
 Reservoir Trip Pressure: 55 PSI
 Replaces: Bendix 286364 (SR-1)

Part Number	Description
GTA-286364	Spring brake valve



Spring Brake Valves

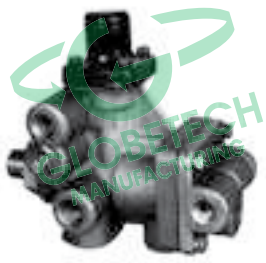

Body height: 5-17/32"
 Delivery ports: (4) 3/8" PT
 Trailer supply ports: (1) 1/4" PT
 Trailer service ports: (1) 1/4" PT
 Service reservoir ports: (2) 1/4" PT
 Reservoir connection: (1) 3/4" male PT
 Replaces: Bendix 102761 (SR-2)

Part Number	Description
GTA-102761	Spring brake valve



Body height: 5-3/4"
 Delivery ports: (4) 3/8" PT
 Reservoir charging ports: (2) 1/4" PT
 Trailer supply ports: (1) 1/4" PT
 Trailer service ports: (1) 1/4" PT
 Reservoir connection: (1) GTA-101112
 3/4" male PT
 GTA-101622 1/2" male PT
 Replaces: Bendix 101112 (SR-4)
 101622 (SR-4)

Part Number	Description
GTA-101112	Trailer spring brake valve
GTA-101622	Trailer spring brake valve

Stop Light Switches



Body height: 2-1/4"
 Body width: 1-5/8"
 Pipe thread: 1/4"
 Terminal thread: 8-32
 Replaces: Bendix 228600 (SL-4)

Part Number	Description
GTA-228600	Stop light switch

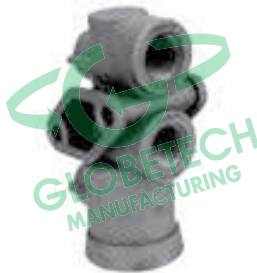

Body height: 4-3/4"
 Tractor service ports: 3/8" PT
 Tractor emergency ports: 1/4" PT
 Trailer service ports: 1/2" PT
 Trailer emergency ports: 1/2" PT
 Replaces: Bendix 279000 (TP-3)

Part Number	Description
GTA-279000	Tractor protection valve

Transmission Slave Valves

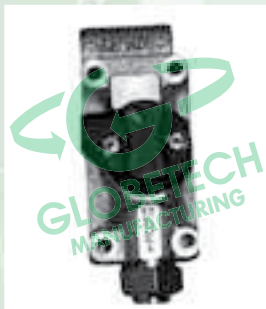

All ports: 1/8" NPT
 Replaces: Haldex KN4688

Part Number	Description
GTA-A4688	Transmission slave valve



All ports: 1/8" NPT
 Replaces: Fuller A-5000

Part Number	Description
GTA-A5000	Transmission slave valve



Air Dryers



AD-IP

GTA-065612

Part Number	Description	Replaces
GTA-065225	AD-9 Air Dryer (B) 12V	R955205
GTA-065612	AD-IP Air Dryer 12V	



GTA-5001247

AD-IP Components

Part Number	Description
GTA-109493	AD-IP Air Dryer Cartridge
GTA-800404	AD-IP Purge Valve
GTA-5001247	AD-IP BracketKit



GTA-109493



GTA-5001247

AD-9 Components

Part Number	Description
GTA-107794	AD-9 Air Dryer Cartridge
GTA-5004341	AD-9 Purge Valve
GTA-107695	AD-9 Bracket Kit
GTA-107798	AD-9 Purge Valve Kit
GTA-107800	AD-9 Single Check Valve
GTA-107799	AD-9 Single Check Valve



GTA-107794



GTA-5004341



Aluminum Gladhands



- Industry standard
- Aluminum cast body
- Steel clasp plate, rubber seal
- SAE J318 approved

Part Number	Description	Replaces Tramec#
GT-5330	universal	36301
GT-5331	emergency (red)	36201
GT-5332	service (blue)	36101

Ten to a box



Aluminum Swivel Gladhands



- Stainless steel spring & wear pad
- Steel mounting bracket zinc plated with yellow dichromate
- Includes brass airline fittings
- **"P" Powder Coated Swivel Iron Gladhand**

Part Number	Description	Replaces Tramec#
GT-5350-45	Gladhand - swivel only 45°	-
GT-5350-90	Gladhand - swivel only 90°	36390
GT-5351-45	Gladhand - swivel, emergency, 45°(red)	36281
GT-5351-90	Gladhand - swivel, emergency, 90°	36201
GT-5351P-45	Gladhand, swing-away, emergency, w/iron GH powder coated 45 degree	
GT-5351P-90	Gladhand, swing-away, emergency, w/iron GH powder coated 90 degree	
GT-5352-45	Gladhand service , 45 degree swing-away swivel assembly	36181
GT-5352-90	Gladhand service , 90 degree swing-away swivel assembly	36191
GT-5352P-45	Gladhand, swing-away, service, w/iron GH powder coated 45 degree	
GT-5352P-90	Gladhand, swing-away, service, w/iron GH powder coated 90 degree	
GT-5353	Iron swivel Gladhand red 'emergency' 1 piece cast	36233
GT-5354	Iron swivel Gladhand yellow 'service' 1 piece cast	36133

Iron Swivel Gladhands



GT-5354



Shut-off Gladhands



Knob Style

Lever Style

Part Number	Description	Replaces Tramec#	Replaces Phillips
GT-5338	emergency, shut-off Phillips	9212	12-310
GT-5338S	emergency, Sloan style, shut-off	9203	441014
GT-5339	service, shut-off Phillips	9211	12-306
GT-5339S	service, Sloan style, shut-off	9202	441004

37° Bracket Mount Gladhands



GT-5317

GT-5327

3/8" – 18 NPTF ports with pipe plug

Part Number	Description	Replaces Phillips
GT-5317	service, 37° mounting	12-136
GT-5327	emergency, 37° mounting	12-138

Xtreme Gladhands



**GT-5333X
universal**

**GT-5334X
1 red 1 blue set**

Part Number	Description	Replaces Tramec
GT-5333X	Xtreme, aluminum, Universal	36301P
GT-5334X	Xtreme, red/blue SET	36201P & 36101P

- Powder-coated body - red/blue & black
- Stainless steel wear plate & clasp
- Urethane seal
- Stainless screen & screws
- Clamshell packaged



Cast Iron Gladhands



“V” Series

- Zinc plated, dichromated one piece
- Supplied with (GT-2600) rubber seal

“Quick-E” Style Replacement



GT-5383

Poly Seal Kits

- Red & blue poly seal kits
- 2 seals per kit



Part Number	Description	Replaces Tramec#
GT-5335	Universal	56321
GT-5336	emergency	56221
GT-5337	service	56121

Quick Release

Part Number	Description	Replaces Phillips#
GT-5373	1/2" female pipe thread bottom port	12-206
GT-5374	3/8" female pipe thread bottom port with filter screen 37° Degree Trailer Mount	12-236

Part Number	Description
GT-2609	Seal kit, double lip, large face combines GT-2606 & GT-2607
GT-2605GLO	Seal kit, small face combines GT-2601 & GT-2602
GT-2605WS	Gladhand seal kit with built-in filters small face, red/blue



Rubber Seals

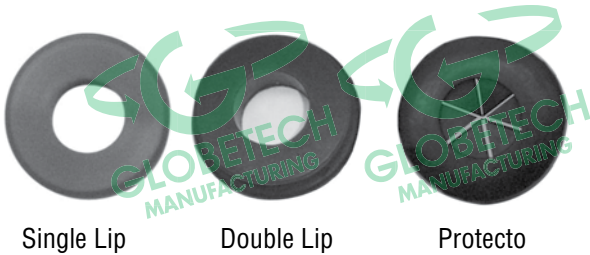

Single Lip

Double Lip

Protecto

Part Number	Description	Replaces Tramec No.	Replaces Tectran No.
GT-2599	Single lip	36003	101112
GT-2600	Double lip	36001	10111
GT-2604	Protecto	–	101113

100 each per Poly Bag

Filters

GT-2601WS (red)

GT-2602WS (blue)

GT-2603WS (black)

- Urethane small face
- Stainless steel screen

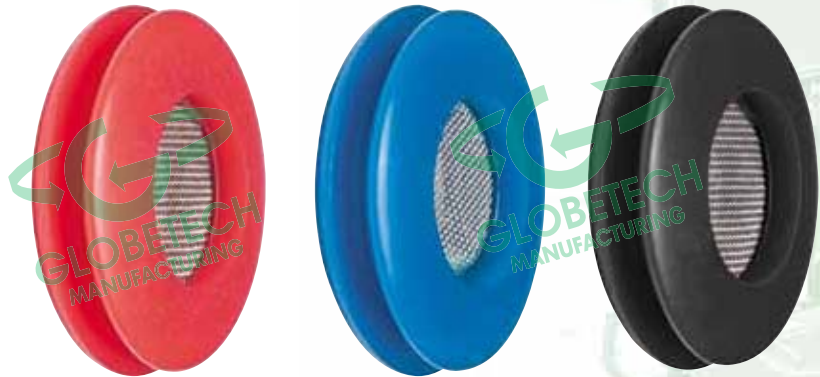

(Bags 25 each to a bag)

Polyurethane Seals



Small Face

Large Face

Part Number	Description	Color	Replaces Tectran No.
GT-2601	Small face	Red	101115R
GT-2602	Small face	Blue	101115B
GT-2603	Small face	Black/Gray	101114
GT-2601WS	Small face with built in filter	Red	
GT-2602WS	Small face with built in filter	Blue	
GT-2603WS	Small face with built in filter	Black/Gray	
GT-2606	Large Face	Red	101119R
GT-2607	Large Face	Blue	101119B
GT-2608	Large Face	Black/Gray	101118

100 each per Poly Bag



Gladhand Locks



- Indestructible plastic body
- Stainless steel & zinc plated hardware
- Multiple key patterns available

Part Number	Description	Key	Replaces
GT-7200	Gladhand Lock and Key	GT-611K	1011LK
GT-7200-E100	Gladhand Lock and Key	GT-E100K	
GT-7200-E101	Gladhand Lock and Key	GT-E101K	

**ONE KEY FITS YOUR KING
PIN LOCK AND
GLANDHAND LOCK!
SECURE YOUR TRAILER
WITH TWO LOCKS ONE KEY!**



Part Number	Description
GT-611K	Keys only-set
GT-E100K	Keys only-set
GT-E101K	Keys only-set

Dummy Shutoff Gladhands



Die cast aluminum

Part Number	Description	Replaces Tramec#
GT-5345	w/stainless steel cable	1010-F18
GT-5345FX	red cable 21" long HD-eyelet	

Dummy Coupling Mounts



Part Number	Description	Replaces Sloan#
GT-5347	Glaghand clear chromate Packaged 2 per bag	44731



Stamped

Part Number	Description	Replaces Tectran#
GT-5346V	Stamped steel vented	9412
GT-5346NV	Stamped steel non-vented	9411



Stainless Steel Screens



- Replacement screens for Xtreme Gladhands
- Prevents dirt from entering airline
- 20 each per bag

Part Number	Description	Replaces Phillips
GT-12-038	stainless steel dome style	12-038
GT-12-039	Stainless steel, flat style	12-039

In-Line Quick Release Valve



- Exhaust valves mount in-line between the gladhand and the tractor protection valve to speed up release of the trailer's service brakes
- Helps reduce wear on trailer brake components
- Helps improve brake timing

Part Number	Description	Ports	Replaces Tectran
GTA-80-1094	Mounts between tractor protection valve and trailer hose	1/2" NPTF	80-1094
GTA-80-1095	Mounts at gladhand end of trailer hose	1/2" NPTF	80-1095

GT-2610 Gladhand Pacifier

- Gladhand pacifiers are easily attached in any convenient location
- Simply plug into the gladhand when disconnected
- Prevents dirt and contaminants from entering the air system

Replaces Tectran 1011P





Rubber Grip GT-5343 Gladhand Grips

- Unique rubberized gladhand grips
- May be used on rubber hose assemblies or aircoils
- Protect hose/tubing during gladhand connection
- Allow gladhand bend restriction during tight turns

Part Number	Description	Replaces Tectran
GT-5343	Flexible grip gladhand grip 1 red and 1 blue	1011FG

GT-5341 - Anodized Gladhand Grips

- Helps prevent air line kinking at the fittings
- One piece design
- No screws or plastic parts
- Easy to install aluminum hex construction
- Class II anodized coating provides greater corrosion-resistance

The unique all hex design allows positive wrench leverage at both ends of handle.



PLASTIC GRIP GT-5340 Gladhandles

Standard
1 each red & blue in clamshell package

Part Number	Description	Replaces Tectran#
GT-5340	Gladhand set, standard	1011G



Brake Shoe Hardware Kits

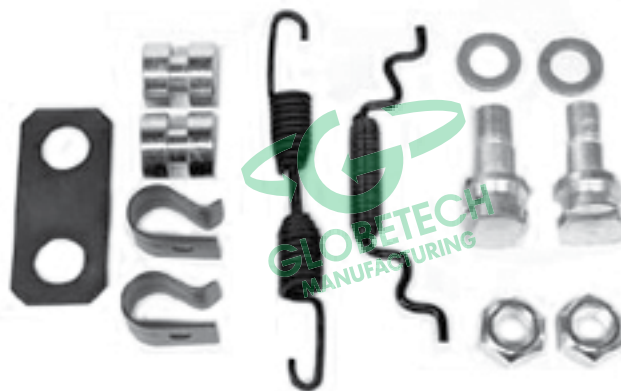

Part Number	Replaces BWP	Replaces Euclid#	Contains	Use With
GTA-MK79	BWP MK79	E3869	2M-2724 Roller, 2 M-3355 Anchor Pin 1 M-3356 Return Spring 1 M-3357 Spring, 1 M-3358 Plate 2 M-3359 Washer, 2 M-2459 Lock Nut	Meritor (Rockwell) 15" Front Brake Shoes
GTA-MK39	BWP MK39	E2769S	2 M-1422 Anchor Pin, 2 M-596 Roller Pin 1M-2732 H.D. Spring, 2 M-747 Bushing	16 1/2" Shoes
GTA-MK72	BWP MK72	E2769HD	2 M-1422 Anchor Pin, 2 M-2204 Roller Pin 1 M-2732 H.D. Spring, 2 M-747 Bushing 2 M-1433 Retainer, 2 M-1500 Spring Pin	16 1/2" Shoes
GTA-MK7	BWP MK7	E1816HD	2 M-771 Anchor Pin, 2 M-596 Roller Pin 1 M-792 H.D. Spring, 1 M-747 Bushing 2 M-644 Retainer, 4 M-748 Washer 2 M-1500 Spring Pin, 4 M-1523 Lock Pin	Meritor/Dana 16 1/2" Universal Kit
GTA-MK10	BWP MK10		2 M-592 Roller, 2 M-612 Roller Pin 1 M-1014 H.D. Spring, 2 M-844 Spring	Eaton 4311 Shoes
GTA-MK42	BWP MK42	E3710S	2 M-2748 Anchor Pin, 2 M-596 Roller Pin 2 M-747 Bushing, 1 M-2732 H.D. Spring 2 M-1423 Spring, 2 M-1428 Retainer 1 M-1430 Cotter Pin, 2 M-1500 Spring Pin	Fruehauf/Propar XEM3 Shoes

BETTER PARTS BETTER PRICES!

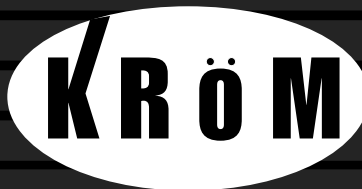

INTERNATIONAL

WORLD CLASS AIR SPRINGS

For OEM and Aftermarket

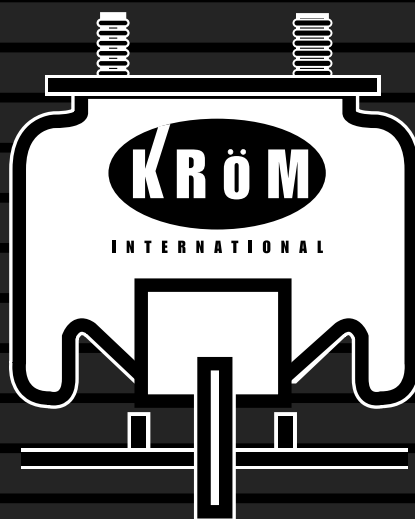

- 2.5 Million Cycles
- 144/Hrs. Salt Spray
- 100% Pressure Tested
- Standard 4mm Thick Plates
- Dupont Nylon Made in USA
- ISO Certified
- All Components Made IN HOUSE
- Level III PPAP Available

KRÖM Branded Air Springs are the highest Quality Springs on the Market. Other manufacturers are for reference only in this catalog. **KRÖM** International warranties all products to be manufactured of the highest quality standards and free of any defects.



Popular Stock Air Springs Index

Globetch	Firestone	Part Description
GTK-358-6231	W01-358-6231	AIR SPRING
GTK-358-6897	W01-358-6897	AIR SPRING
GTK-358-6935	W01-358-6935	AIR SPRING
GTK-358-7136	W01-358-7136	AIR SPRING
GTK-358-7206	W01-358-7206	AIR SPRING
GTK-358-7207	W01-358-7207	AIR SPRING
GTK-358-7400	W01-358-7400	AIR SPRING
GTK-358-7555	W01-358-7555	AIR SPRING
GTK-358-7897	W01-358-7897	AIR SPRING
GTK-358-8050	W01-358-8050	AIR SPRING
GTK-358-8091	W01-358-8091	AIR SPRING
GTK-358-8204	W01-358-8204	AIR SPRING
GTK-358-8708	W01-358-8708	AIR SPRING
GTK-358-8709	W01-358-8709	AIR SPRING
GTK-358-8710	W01-358-8710	AIR SPRING
GTK-358-8713	W01-358-8713	AIR SPRING
GTK-358-8729	W01-358-8729	AIR SPRING
GTK-358-8744	W01-358-8744	AIR SPRING
GTK-358-8755	W01-358-8755	AIR SPRING
GTK-358-8774	W01-358-8774	AIR SPRING
GTK-358-8944	W01-358-8944	AIR SPRING
GTK-358-9039	W01-358-9039	AIR SPRING
GTK-358-9069	W01-358-9069	AIR SPRING
GTK-358-9082	W01-358-9082	AIR SPRING
GTK-358-9101	W01-358-9101	AIR SPRING
GTK-358-9121	W01-358-9121	AIR SPRING
GTK-358-9122	W01-358-9122	AIR SPRING
GTK-358-9265	W01-358-9265	AIR SPRING
GTK-358-9270	W01-358-9270	AIR SPRING
GTK-358-9291	W01-358-9291	AIR SPRING
GTK-358-9293	W01-358-9293	AIR SPRING
GTK-358-9307	W01-358-9307	AIR SPRING
GTK-358-9321	W01-358-9321	AIR SPRING
GTK-358-9366	W01-358-9366	AIR SPRING
GTK-358-9367	W01-358-9367	AIR SPRING
GTK-358-9371	W01-358-9371	AIR SPRING
GTK-358-9373	W01-358-9373	AIR SPRING
GTK-358-9394	W01-358-9394	AIR SPRING
GTK-358-9422	W01-358-9422	AIR SPRING
GTK-358-9580	W01-358-9580	AIR SPRING
GTK-358-9626	W01-358-9626	AIR SPRING
GTK-358-9634	W01-358-9634	AIR SPRING
GTK-358-9640	W01-358-9640	AIR SPRING
GTK-358-9646	W01-358-9646	AIR SPRING
GTK-358-9648	W01-358-9648	AIR SPRING
GTK-358-9780	W01-358-9780	AIR SPRING
GTK-358-9781	W01-358-9781	AIR SPRING
GTK-358-9807	W01-358-9807	AIR SPRING
GTK-358-9921	W01-358-9921	AIR SPRING
GTK-358-9978	W01-358-9978	AIR SPRING

all references to competitors' part numbers are for cross reference purposes only



Suspension

ITEM NO.	GTK-358-6897		OE NO.		CROSS REF.	
CROSS SECTION VIEW	TOP VIEW/BOTTOM VIEW					
			Watson&Chalin	AS-0058	Firestone	W01-358-6897
					Contitech	FD 200-19 505
					Goodyear	2B9-229

ITEM NO.	GTK-358-7400		OE NO.		CROSS REF.	
CROSS SECTION VIEW	TOP VIEW/BOTTOM VIEW					
			Fab Tek	04-0080	Firestone	W01-358-7400
			Freightliner	16-10769-000	Contitech	FD 330-22 313
			GMC	693230	Goodyear	2B12-309
			Hendrickson	S1013		578923309
			R&S Truck&Body	1027519		
			Watson&Chalin	As0003		
			Ridewell	1003587400C		
			Neway	90557016		

ITEM NO.	GTK-358-8050		OE NO.		CROSS REF.	
CROSS SECTION VIEW	TOP VIEW/BOTTOM VIEW					
			Dayton	352-8050	Firestone	W01-358-8050
			Navistar	1685174C1	Goodyear	1R14-039
			Neway	570 08 050	Contitech	11 10.5E-16A320
			Reyco Granning	23631-01		
			Taiangle	8320		
			Hendrickson	S4771 B12514 B125013		
			Watson&Chalin	AS-0039		

ITEM NO.	GTK-358-8091		OE NO.		CROSS REF.	
CROSS SECTION VIEW	TOP VIEW/BOTTOM VIEW					
			Triangle	8523/6398	Firestone	W01-358-8091
			SAP	503513081		1T19FC-6
			Hendrickson	S-21784/HKA250	Goodyear	1R14-171
				S-20901/AA250T		566283015
					Contitech	AS 8091



ITEM NO.	GTK-358-8204		OE NO.		CROSS REF.	
CROSS SECTION VIEW	TOP VIEW/BOTTOM VIEW					
	Neway	90557210	Firestone	W01-358-8204		
	Binkley	XB-SPN-053-37		1T15M-2		
		XB-SPN-053-60	Contitech	910-12P484		
	Triangle	8484/6361	Goodyear	1R12-508		
				1R12-522		
				566243067		

ITEM NO.	GTK-358-8709		OE NO.		CROSS REF.	
CROSS SECTION VIEW	TOP VIEW/BOTTOM VIEW					
	Triangle	8460/6390	Firestone	W01-358-8709		
	Hendrickson	AA230T		1T17CA-5		
		C20900	Contitech	10 10.16 S460		
		HKA-180	Goodyear	1R13-159		
		S21800		566-26-3-073		
			Airtech	137072		
				38709CPP		

ITEM NO.	GTK-358-9039		OE NO.		CROSS REF.	
CROSS SECTION VIEW	TOP VIEW/BOTTOM VIEW					
	Hutchens	H-9424-01	Firestone	W01-358-9039		
	Sauer	P50-734	Contitech	91010 P 311		
	Fab Tek	101827	Goodyear	1R12-095		
	Watson & Chalin	AS-0012				
	Neway	90557001 90557023 90557085 90044199				

ITEM NO.	GTK-358-9069		OE NO.		CROSS REF.	
CROSS SECTION VIEW	TOP VIEW/BOTTOM VIEW					
	Dayton	352-9069	Contitech	9 10-14 P 312		
	Hendrickson	13031	Firestone	W01-358-9069		
	Peterbilt	307112/301645/30 2038/302456/3047 59/2310042/30674 6	Goodyear	1R12-069/669		
	Triangle	8312				
	Volvo	85 101 145				
	Foden	1300248000				
	Loadguard	Sc2034	Navistar	554764C1		

all references to competitors' part numbers are for cross reference purposes only



Suspension

ITEM NO.	GTK-358-9082	OE NO.		CROSS REF.	
CROSS SECTION VIEW	TOP VIEW/BOTTOM VIEW				
		Neway	905 570 06	Firestone	W01-358-9082
			905 570 27/37/54/75	Contitech	910-16 P 310
		HAD	PMABG9082B	Goodyear	1R12-092
		R&S Truck	1090217		
		Hutchens	H-9630-01		
		Watson&Chalin	AS-0011		
Hendrickson	B 2066				

ITEM NO.	GTK-358-9101	OE NO.		CROSS REF.	
CROSS SECTION VIEW	TOP VIEW/BOTTOM VIEW				
		Neway	905 570 82	Firestone	W01-358-9101
		ERF	139275-4	Contitech	4159NP04
		Toyo	TRL-250	Goodyear	1R12-717
		Truckstell	63.647	Taurus	AS-504-9101
		Triangle	8315		
		Hendrickson	B3842		
		Watson&Chalin	AS-0040		

ITEM NO.	GTK-358-9122	OE NO.		CROSS REF.	
CROSS SECTION VIEW	TOP VIEW/BOTTOM VIEW				
		Neway	90557020 90557071 90557076 90557077	Firestone	W01-358-9122
		Watson&Chalin	B3830 S3467 B-12514-008 B-12514-010	Goodyear	4811N03 1R13-038
		Reyco	12883-02		
		Sauer	P50-732		
		Ridewell	1003589122C		
		Tec	5006003		
		Watson&Chalin	AS-0023		

ITEM NO.	GTK-358-9265	OE NO.		CROSS REF.	
CROSS SECTION VIEW	TOP VIEW/BOTTOM VIEW				
		Dayton	352-9265	Firestone	W01-358-9265
		Loadguard	SC2134/SC2759		W01-358-9573
		Triangle	8435		W01-358-9574
		Volvo	85 101 155	Goodyear	1R12-375
		Ridewell	1003589245C	Contitech	910-19 P 435
		Hendrickson	S20124/HT-250T C20413/HT-250U C20413/HT-250UY		



ITEM NO.	GTK-358-9270		OE NO.		CROSS REF.	
CROSS SECTION VIEW	TOP VIEW/BOTTOM VIEW					
	Hendrickson	S-20010	Firestone	W01-358-9270		
		HT230T	Goodyear	1R13-119		

ITEM NO.	GTK-358-9293		OE NO.		CROSS REF.	
CROSS SECTION VIEW	TOP VIEW/BOTTOM VIEW					
	Airtech	122442/39293K	Firestone	W01-358-9293		
	Dayton	352-9293		1T15LP-5		
	Granning	8896	Goodyear	1R10-120/1R12-501		
	Loadguard	Sc2048		566203021		
	Neway	90557127	Contitech	9 9K-15 P 424		
		90557120				
	Triangle	8424/6378				
	Reyco granning	8896				

ITEM NO.	GTK-358-9321		OE NO.		CROSS REF.	
CROSS SECTION VIEW	TOP VIEW/BOTTOM VIEW					
	Dayton	352-9321	Firestone	W01-358-9321		
	Neway:	57009321	Goodyear	1R12-335/256		
	Leland	SC 2120	Contitech	9 10-21 A 361		
	Hendrickson	NS501304		9 10-21 P 361		
	Volvo	85 101 160				
	Watson&Chalin	AS-0036				
	Ridewell	1003589321C				
	Brake&Wheel	M3545				

ITEM NO.	GTK-358-9371		OE NO.		CROSS REF.	
CROSS SECTION VIEW	TOP VIEW/BOTTOM VIEW					
	Dayton	352-9371	Firestone	W01-358-9371		
	Navistar	1670073C-1	Contitech	9 10-17.5 P 521		
		1686386C-1	Goodyear	1R12-401		
		2027911C-1		1S12-244		
	Triangle	8521				

all references to competitors' part numbers are for cross reference purposes only



Suspension

ITEM NO.	GTK-358-9422		OE NO.		CROSS REF.	
CROSS SECTION VIEW	TOP VIEW/BOTTOM VIEW					
	Dayton	253-9422	Firestone	W01-358-9422		
	Toyo	TRL230H/8510114 8	Goodyear	1R11-028		
	Kenworth	K303-6/14/15	Contitech	9 9-12 P 314		
	Loadguard:Sc2 050	SAF:57009422		4151 NP 03		
	Navistar	501559C-2 554762C1 1660581C-1				
	Neway	905 571 20				
	Watson&Chalin	AS-0017				
	Volvo	3 130 496				
	Hendrickson	S13032/K3036				

ITEM NO.	GTK-358-9580		OE NO.		CROSS REF.	
CROSS SECTION VIEW	TOP VIEW/BOTTOM VIEW					
	Dayton	352-9580	Firestone	W01-358-9580		
	E.R.F	139855-0	Goodyear	1R13-118		
	Loadguard	Sc2761				
	Triangle	8434				
	Hendrickson	C20127/S20127				

ITEM NO.	GTK-358-9648		OE NO.		CROSS REF.	
CROSS SECTION VIEW	TOP VIEW/BOTTOM VIEW					
	Navistar	2027911C1	Firestone	W01-358-9648		
		2027911C2	Goodyear	1R 12-538		
	Triangle	8456/6363	Contitech	9 10-17.5 P 456		

ITEM NO.	GTK-358-9780		OE NO.		CROSS REF.	
CROSS SECTION VIEW	TOP VIEW/BOTTOM VIEW					
	Freightliner	16-13810-000	Firestone	W01-358-9780		
			Goodyear	1R12-303		
			Contitech	910S-16A382		
				Plastic Piston		



ITEM NO.	GTK-358-9781		OE NO.		CROSS REF.	
CROSS SECTION VIEW	TOP VIEW/BOTTOM VIEW					
	Freightliner	681-320-0017	Firestone	W01-358-9781		
		A16-14004-000	Goodyear	1R12-603		
			Contitech	910S-16A382		
					Aluminum Piston	

ITEM NO.	GTK-358-8729		OE NO.		CROSS REF.	
CROSS SECTION VIEW	TOP VIEW/BOTTOM VIEW					
	Airtech	131212	Firestone	W01-358-8729		
		38729CPP	Contitech	10 10B-13 S513		
	Triangle	8513/6396	Goodyear	1R13-130		
	Arvin Meritor	202796		566263055		
	R.O.R/Meritor	202796				

ITEM NO.	GTK-358-7206		OE NO.		CROSS REF.	
CROSS SECTION VIEW	TOP VIEW/BOTTOM VIEW					
	Freightliner	W023777206	Firestone	W01-358-7206		
		18-29919-000				

ITEM NO.	GTK-358-7207		OE NO.		CROSS REF.	
CROSS SECTION VIEW	TOP VIEW/BOTTOM VIEW					
	Freightliner	18-40977-000	Firestone	W01-358-7207		



Suspension

ITEM NO.	GTK-358-8713		OE NO.		CROSS REF.	
CROSS SECTION VIEW	TOP VIEW/BOTTOM VIEW					
	Airtech	137082	Firestone	W01-358-8713		
		38713K	Contitech	10 10-17.5 S533		
	Triangle	8533/6382	Goodyear	1R13-140		
	Hendrickson	HKA-180		1R13-176		
		S22948				

ITEM NO.	GTK-358-9373		OE NO.		CROSS REF.	
CROSS SECTION VIEW	TOP VIEW/BOTTOM VIEW					
	Airtech	39373P/39373K	Firestone	W01-358-9373		
	Triangle	8440/6364	Goodyear	1R 12-403		
		8519/6391		566243097		
	Watson&Chalin	AS0127G/AS0141		1S 12-030		
	Hendrickson	57122-2(Ford Class8)		566241001		
		HAS-360/400/402/460	Contitech	9 10-17.5 P 440		
			9 10-17.5 P 519			

ITEM NO.	GTK-358-9807		OEM NO.		CROSS REF.	
CROSS SECTION VIEW	TOP VIEW/BOTTOM VIEW				Firestone	W01358-9807



Manufacturer	OEM No.	Part No.	Manufacturer	OEM No.	Part No.
FIRESTONE	W01-095-0453	GTK-095-0453	FIRESTONE	W01-358-8829	GTK-358-8829
FIRESTONE	W01-095-0472	GTK-095-0472	FIRESTONE	W01-358-9039	GTK-358-9039
FIRESTONE	W01-095-0429	GTK-095-0429	FIRESTONE	W01-M58-8612	GTK-M58-8612
FIRESTONE	W01-095-0382	GTK-095-0382	FIRESTONE	W01-M58-8786	GTK-M58-8786
FIRESTONE	W01-095-0118	GTK-095-0118	FIRESTONE	W01-M58-6237	GTK-M58-6237
FIRESTONE	W01-095-0021	GTK-095-0021	FIRESTONE	W01-M58-6238	GTK-M58-6238
FIRESTONE	W01-095-0207	GTK-095-0207	FIRESTONE	W01-M58-6251	GTK-M58-6251
FIRESTONE	W01-095-0198	GTK-095-0198	FIRESTONE	W01-M58-6252	GTK-M58-6252
FIRESTONE	W01-095-0205	GTK-095-0205	FIRESTONE	W01-M58-6254	GTK-M58-6254
FIRESTONE	W01-095-0087	GTK-095-0087	FIRESTONE	W01-M58-6260	GTK-M58-6260
FIRESTONE	W01-095-0195	GTK-095-0195	FIRESTONE	W01-358-6262	GTK-358-6262
FIRESTONE	W01-095-0191	GTK-095-0191	FIRESTONE	W01-M58-6267	GTK-M58-6267
FIRESTONE	W01-095-0211	GTK-095-0211	FIRESTONE	W01-455-6269	GTK-455-6269
FIRESTONE	W01-095-0212	GTK-095-0212	FIRESTONE	W01-M58-6286	GTK-M58-6286
FIRESTONE	W01-095-0190	GTK-095-0190	FIRESTONE	W01-M58-6287	GTK-M58-6287
FIRESTONE	W01-095-0204	GTK-095-0204	FIRESTONE	W01-455-6288	GTK-455-6288
FIRESTONE	W01-095-0197	GTK-095-0197	FIRESTONE	W01-M58-6289	GTK-M58-6289
FIRESTONE	W01-095-0436	GTK-095-0436	FIRESTONE	W01-M58-6296	GTK-M58-6296
FIRESTONE	W01-095-0435	GTK-095-0435	FIRESTONE	W01-M58-6297	GTK-M58-6297
FIRESTONE	W01-095-0295	GTK-095-0295	FIRESTONE	W01-M58-6315	GTK-M58-6315
FIRESTONE	W01-095-0245	GTK-095-0245	FIRESTONE	W01-M58-6317	GTK-M58-6317
FIRESTONE	W01-095-0229	GTK-095-0229	FIRESTONE	W01-M58-6318	GTK-M58-6318
FIRESTONE	W01-095-0226	GTK-095-0226	FIRESTONE	W01-M58-6333	GTK-M58-6333
FIRESTONE	W01-095-0244	GTK-095-0244	FIRESTONE	W01-M58-6334	GTK-M58-6334
FIRESTONE	W01-095-0228	GTK-095-0228	FIRESTONE	W01-M58-6338	GTK-M58-6338
FIRESTONE	W01-095-0189	GTK-095-0189	FIRESTONE	W01-M58-6344	GTK-M58-6344
FIRESTONE	W01-095-0198	GTK-095-0198	FIRESTONE	W01-M58-6345	GTK-M58-6345
FIRESTONE	W01-095-0063	GTK-095-0063	FIRESTONE	W01-M58-6348	GTK-M58-6348
FIRESTONE	W01-095-0437	GTK-095-0437	FIRESTONE	W01-M58-6359	GTK-M58-6359
FIRESTONE	W01-M58-0919	GTK-M58-0919	FIRESTONE	W01-M58-6360	GTK-M58-6360
FIRESTONE	W01-095-0294	GTK-095-0294	FIRESTONE	W01-M58-6364	GTK-M58-6364
FIRESTONE	W01-095-0500	GTK-095-0500	FIRESTONE	W01-M58-6366	GTK-M58-6366
FIRESTONE	W01-M58-0736	GTK-M58-0736	FIRESTONE	W01-M58-6367	GTK-M58-6367
FIRESTONE	W01-M58-0749	GTK-M58-0749	FIRESTONE	W01-M58-7074	GTK-M58-7074
FIRESTONE	W01-M58-0756	GTK-M58-0756	FIRESTONE	W01-M58-6317	GTK-M58-6317
FIRESTONE	W01-M58-0775	GTK-M58-0775	FIRESTONE	W01-M58-7238	GTK-M58-7238
FIRESTONE	W01-M58-0776	GTK-M58-0776	FIRESTONE	W01-M58-7295	GTK-M58-7295
FIRESTONE	W01-M58-0780	GTK-M58-0780	FIRESTONE	W01-M58-7308	GTK-M58-7308
FIRESTONE	W01-M58-0781	GTK-M58-0781	FIRESTONE	W01-681-7329	GTK-681-7329
FIRESTONE	W01-M58-0918	GTK-M58-0918	FIRESTONE	W01-M58-7335	GTK-M58-7335
FIRESTONE	W01-M58-0919	GTK-M58-0919	FIRESTONE	W01-M58-7348	GTK-M58-7348
FIRESTONE	W01-358-5298	GTK-358-5298	FIRESTONE	W01-F79-7349	GTK-F79-7349
FIRESTONE	W01-358-5311	GTK-358-5311	FIRESTONE	W01-M58-7358	GTK-M58-7358
FIRESTONE	W01-358-5770	GTK-358-5770	FIRESTONE	W01-681-7359	GTK-681-7359
FIRESTONE	W01-358-5771	GTK-358-5771	FIRESTONE	W01-681-7368	GTK-681-7368
FIRESTONE	W01-358-5772	GTK-358-5772	FIRESTONE	W01-M58-7370	GTK-M58-7370
FIRESTONE	W01-358-5773	GTK-358-5773	FIRESTONE	W01-M58-7582	GTK-M58-7582
FIRESTONE	W01-358-5775	GTK-358-5775	FIRESTONE	W01-M58-7385	GTK-M58-7385
FIRESTONE	W01-358-5776	GTK-358-5776	FIRESTONE	W01-M58-8786	GTK-M58-8786
FIRESTONE	W01-358-5777	GTK-358-5777	FIRESTONE	W01-M58-7529	GTK-M58-7529
FIRESTONE	W01-358-5789	GTK-358-5789	FIRESTONE	W01-M58-7548	GTK-M58-7548
FIRESTONE	W01-M58-8512	GTK-M58-8512	FIRESTONE	W01-M58-7582	GTK-M58-7582
FIRESTONE	W01-M58-8521	GTK-M58-8521	FIRESTONE	W01-455-7666	GTK-455-7666
FIRESTONE	W01-N94-3955	GTK-N94-3955	FIRESTONE	W01-358-7667	GTK-358-7667
FIRESTONE	W01-M58-8522	GTK-M58-8522	FIRESTONE	W01-M58-8473	GTK-M58-8473
FIRESTONE	W01-M58-8966	GTK-M58-8966	FIRESTONE	W01-358-8050	GTK-358-8050
FIRESTONE	W01-M58-8683	GTK-M58-8683	FIRESTONE	W01-358-8052	GTK-358-8052
FIRESTONE	W01-M58-8620	GTK-M58-8620	FIRESTONE	W01-358-8053	GTK-358-8053
FIRESTONE	W01-M58-9760	GTK-M58-9760	FIRESTONE	W01-358-8058	GTK-358-8058
FIRESTONE	W01-M58-8474	GTK-M58-8474	FIRESTONE	W01-353-8088	GTK-353-8088
FIRESTONE	W01-M58-7548	GTK-M58-7548	FIRESTONE	W01-350-8091	GTK-350-8091
FIRESTONE	W01-M58-8502	GTK-M58-8502	FIRESTONE	W01-358-8093	GTK-358-8093
FIRESTONE	W01-M58-8472	GTK-M58-8472	FIRESTONE	W01-359-8184	GTK-359-8184
FIRESTONE	W01-M58-8477	GTK-M58-8477	FIRESTONE	W01-M58-8185	GTK-M58-8185

all references to competitors' part numbers are for cross reference purposes only



Suspension

Manufacturer	OEM No.	Part No.	Manufacturer	OEM No.	Part No.
FIRESTONE	W01-M58-8186	GTK-M58-8186	FIRESTONE	W01-358-8853	GTK-358-8853
FIRESTONE	W01-S15-8192	GTK-S15-8192	FIRESTONE	W01-358-8644	GTK-358-8644
FIRESTONE	W01-M58-8193	GTK-M58-8193	FIRESTONE	W01-358-8878	GTK-358-8878
FIRESTONE	W01-358-8197	GTK-358-8197	FIRESTONE	W01-358-8903	GTK-358-8903
FIRESTONE	W01-358-8198	GTK-358-8198	FIRESTONE	W01-358-8924	GTK-358-8924
FIRESTONE	W01-358-8201	GTK-358-8201	FIRESTONE	W01-358-8927	GTK-358-8927
FIRESTONE	W01-358-8203	GTK-358-8203	FIRESTONE	W01-358-8929	GTK-358-8929
FIRESTONE	W01-358-8204	GTK-358-8204	FIRESTONE	W01-358-8930	GTK-358-8930
FIRESTONE	W01-358-8207	GTK-358-8207	FIRESTONE	W01-359-8931	GTK-359-8931
FIRESTONE	W01-M58-8477	GTK-M58-8477	FIRESTONE	W01-358-8932	GTK-358-8932
FIRESTONE	W01-358-8500	GTK-358-8500	FIRESTONE	W01-358-8934	GTK-358-8934
FIRESTONE	W01-358-9156	GTK-358-9156	FIRESTONE	W01-358-8935	GTK-358-8935
FIRESTONE	W01-M58-8601	GTK-M58-8601	FIRESTONE	W01-M58-8966	GTK-M58-8966
FIRESTONE	W01-M58-8608	GTK-M58-8608	FIRESTONE	W01-M58-8969	GTK-M58-8969
FIRESTONE	W01-M58-8609	GTK-M58-8609	FIRESTONE	W01-M58-8610	GTK-M58-8610
FIRESTONE	W01-M58-8610	GTK-M58-8610	FIRESTONE	W01-M58-8978	GTK-M58-8978
FIRESTONE	W01-M58-8611	GTK-M58-8611	FIRESTONE	W01-358-8984	GTK-358-8984
FIRESTONE	W01-M58-8612	GTK-M58-8612	FIRESTONE	W01-358-8991	GTK-358-8991
FIRESTONE	W01-M58-8613	GTK-M58-8613	FIRESTONE	W01-358-9004	GTK-358-9004
FIRESTONE	W01-M58-8619	GTK-M58-8619	FIRESTONE	W01-358-9008	GTK-358-9008
FIRESTONE	W01-M58-8620	GTK-M58-8620	FIRESTONE	W01-358-9010	GTK-358-9010
FIRESTONE	W01-M58-8629	GTK-M58-8629	FIRESTONE	W01-358-9011	GTK-358-9011
FIRESTONE	W01-377-8632	GTK-377-8632	FIRESTONE	W01-358-9026	GTK-358-9026
FIRESTONE	W01-M58-8635	GTK-M58-8635	FIRESTONE	W01-358-9033	GTK-358-9033
FIRESTONE	W01-358-8637	GTK-358-8637	FIRESTONE	W01-358-9039	GTK-358-9039
FIRESTONE	W01-455-8644	GTK-455-8644	FIRESTONE	W01-358-9053	GTK-358-9053
FIRESTONE	W01-358-8646	GTK-358-8646	FIRESTONE	W01-358-9059	GTK-358-9059
FIRESTONE	W01-358-8650	GTK-358-8650	FIRESTONE	W01-358-9063	GTK-358-9063
FIRESTONE	W01-M58-8701	GTK-M58-8701	FIRESTONE	W01-358-9068	GTK-358-9068
FIRESTONE	W01-M58-8705	GTK-M58-8705	FIRESTONE	W01-358-9069	GTK-358-9069
FIRESTONE	W01-358-8709	GTK-358-8709	FIRESTONE	W01-358-9070	GTK-358-9070
FIRESTONE	W01-358-8710	GTK-358-8710	FIRESTONE	W01-358-9071	GTK-358-9071
FIRESTONE	W01-358-8713	GTK-358-8713	FIRESTONE	W01-358-9078	GTK-358-9078
FIRESTONE	W01-M58-8721	GTK-M58-8721	FIRESTONE	W01-358-9079	GTK-358-9079
FIRESTONE	W01-M58-8722	GTK-M58-8722	FIRESTONE	W01-358-9082	GTK-358-9082
FIRESTONE	W01-358-8729	GTK-358-8729	FIRESTONE	W01-358-9083	GTK-358-9083
FIRESTONE	W01-M58-8747	GTK-M58-8747	FIRESTONE	W01-681-9084	GTK-681-9084
FIRESTONE	W01-358-8748	GTK-358-8748	FIRESTONE	W01-358-9211	GTK-358-9211
FIRESTONE	W01-358-8764	GTK-358-8764	FIRESTONE	W01-358-9089	GTK-358-9089
FIRESTONE	W01-M58-8766	GTK-M58-8766	FIRESTONE	W01-681-9091	GTK-681-9091
FIRESTONE	W01-M58-8772	GTK-M58-8772	FIRESTONE	W01-358-9092	GTK-358-9092
FIRESTONE	W01-M58-8773	GTK-M58-8773	FIRESTONE	W01-358-9093	GTK-358-9093
FIRESTONE	W01-358-8776	GTK-358-8776	FIRESTONE	W01-358-9096	GTK-358-9096
FIRESTONE	W01-M58-8778	GTK-M58-8778	FIRESTONE	W01-M58-9098	GTK-M58-9098
FIRESTONE	W01-M58-8786	GTK-M58-8786	FIRESTONE	W01-358-9101	GTK-358-9101
FIRESTONE	W01-358-8792	GTK-358-8792	FIRESTONE	W01-358-9104	GTK-358-9104
FIRESTONE	W01-358-8796	GTK-358-8796	FIRESTONE	W01-358-9105	GTK-358-9105
FIRESTONE	W01-358-8802	GTK-358-8802	FIRESTONE	W01-358-9106	GTK-358-9106
FIRESTONE	W01-358-8806	GTK-358-8806	FIRESTONE	W01-358-9113	GTK-358-9113
FIRESTONE	W01-358-8810	GTK-358-8810	FIRESTONE	W01-358-9116	GTK-358-9116
FIRESTONE	W01-358-8813	GTK-358-8813	FIRESTONE	W01-358-9118	GTK-358-9118
FIRESTONE	W01-358-8816	GTK-358-8816	FIRESTONE	W01-358-9121	GTK-358-9121
FIRESTONE	W01-358-8817	GTK-358-8817	FIRESTONE	W01-358-9122	GTK-358-9122
FIRESTONE	W01-358-8823	GTK-358-8823	FIRESTONE	W01-M58-9131	GTK-M58-9131
FIRESTONE	W01-358-8824	GTK-358-8824	FIRESTONE	W01-358-9135	GTK-358-9135
FIRESTONE	W01-358-8829	GTK-358-8829	FIRESTONE	W01-358-9141	GTK-358-9141
FIRESTONE	W01-M58-8840	GTK-M58-8840	FIRESTONE	W01-358-9121	GTK-358-9121
FIRESTONE	W01-358-8842	GTK-358-8842	FIRESTONE	W01-358-9144	GTK-358-9144
FIRESTONE	W01-358-8845	GTK-358-8845	FIRESTONE	W01-358-9148	GTK-358-9148
FIRESTONE	W01-358-8852	GTK-358-8852	FIRESTONE	W01-358-9149	GTK-358-9149
FIRESTONE	W01-358-8853	GTK-358-8853	FIRESTONE	W01-358-9152	GTK-358-9152
FIRESTONE	W01-358-8855	GTK-358-8855	FIRESTONE	W01-358-9156	GTK-358-9156
FIRESTONE	W01-358-8856	GTK-358-8856	FIRESTONE	W01-358-9158	GTK-358-9158
FIRESTONE	W01-M58-8859	GTK-M58-8859	FIRESTONE	W01-358-9164	GTK-358-9164



Manufacturer	OEM No.	Part No.	Manufacturer	OEM No.	Part No.
FIRESTONE	W01-358-9177	GTK-358-9177	FIRESTONE	W01-358-9401	GTK-358-9401
FIRESTONE	W01-M58-8747	GTK-M58-8747	FIRESTONE	W01-358-9422	GTK-358-9422
FIRESTONE	W01-358-9179	GTK-358-9179	FIRESTONE	W01-358-9455	GTK-358-9455
FIRESTONE	W01-358-9364	GTK-358-9364	FIRESTONE	W01-358-9556	GTK-358-9556
FIRESTONE	W01-358-9192	GTK-358-9192	FIRESTONE	W01-358-9463	GTK-358-9463
FIRESTONE	W01-358-9193	GTK-358-9193	FIRESTONE	W01-358-9466	GTK-358-9466
FIRESTONE	W01-358-9194	GTK-358-9194	FIRESTONE	W01-358-9467	GTK-358-9467
FIRESTONE	W01-358-9199	GTK-358-9199	FIRESTONE	W01-358-9474	GTK-358-9474
FIRESTONE	W01-358-9200	GTK-358-9200	FIRESTONE	W01-358-9482	GTK-358-9482
FIRESTONE	W01-358-9201	GTK-358-9201	FIRESTONE	W01-358-9483	GTK-358-9483
FIRESTONE	W01-358-9203	GTK-358-9203	FIRESTONE	W01-358-9484	GTK-358-9484
FIRESTONE	W01-358-9204	GTK-358-9204	FIRESTONE	W01-358-9496	GTK-358-9496
FIRESTONE	W01-358-9210	GTK-358-9210	FIRESTONE	W01-358-9507	GTK-358-9507
FIRESTONE	W01-358-9211	GTK-358-9211	FIRESTONE	W01-358-9508	GTK-358-9508
FIRESTONE	W01-358-9213	GTK-358-9213	FIRESTONE	W01-358-9541	GTK-358-9541
FIRESTONE	W01-358-9204	GTK-358-9204	FIRESTONE	W01-358-9554	GTK-358-9554
FIRESTONE	W01-358-9215	GTK-358-9215	FIRESTONE	W01-358-9579	GTK-358-9579
FIRESTONE	W01-358-9216	GTK-358-9216	FIRESTONE	W01-358-9580	GTK-358-9580
FIRESTONE	W01-358-9218	GTK-358-9218	FIRESTONE	W01-358-9585	GTK-358-9585
FIRESTONE	W01-358-9219	GTK-358-9219	FIRESTONE	W01-544-9614	GTK-544-9614
FIRESTONE	W01-358-9221	GTK-358-9221	FIRESTONE	W01-358-9616	GTK-358-9616
FIRESTONE	W01-358-9223	GTK-358-9223	FIRESTONE	W01-358-9622	GTK-358-9622
FIRESTONE	W01-358-9227	GTK-358-9227	FIRESTONE	W01-M58-9642	GTK-M58-9642
FIRESTONE	W01-358-9228	GTK-358-9228	FIRESTONE	W01-358-9647	GTK-358-9647
FIRESTONE	W01-358-9238	GTK-358-9238	FIRESTONE	W01-358-9648	GTK-358-9648
FIRESTONE	W01-358-9240	GTK-358-9240	FIRESTONE	W01-358-9649	GTK-358-9649
FIRESTONE	W01-681-9242	GTK-681-9242	FIRESTONE	W01-M58-9654	GTK-M58-9654
FIRESTONE	W01-358-9243	GTK-358-9243	FIRESTONE	W01-M58-9656	GTK-M58-9656
FIRESTONE	W01-358-9245	GTK-358-9245	FIRESTONE	W01-358-9663	GTK-358-9663
FIRESTONE	W01-358-9249	GTK-358-9249	FIRESTONE	W01-358-9690	GTK-358-9690
FIRESTONE	W01-358-9251	GTK-358-9251	FIRESTONE	W01-358-9697	GTK-358-9697
FIRESTONE	W01-358-9256	GTK-358-9256	FIRESTONE	W01-358-9780	GTK-358-9780
FIRESTONE	W01-358-9264	GTK-358-9264	FIRESTONE	W01-358-9781	GTK-358-9781
FIRESTONE	W01-358-9265	GTK-358-9265	FIRESTONE	W01-377-9784	GTK-377-9784
FIRESTONE	W01-358-9270	GTK-358-9270	FIRESTONE	W01-358-9797	GTK-358-9797
FIRESTONE	W01-358-9277	GTK-358-9277	FIRESTONE	W01-358-9798	GTK-358-9798
FIRESTONE	W01-358-9287	GTK-358-9287	FIRESTONE	W01-358-9811	GTK-358-9811
FIRESTONE	W01-358-9293	GTK-358-9293	FIRESTONE	W01-358-9875	GTK-358-9875
FIRESTONE	W01-358-9296	GTK-358-9296	FIRESTONE	W01-358-9876	GTK-358-9876
FIRESTONE	W01-358-9297	GTK-358-9297	FIRESTONE	W01-358-9915	GTK-358-9915
FIRESTONE	W01-358-9302	GTK-358-9302	FIRESTONE	W01-358-9923	GTK-358-9923
FIRESTONE	W01-358-9304	GTK-358-9304	FIRESTONE	W01-358-9929	GTK-358-9929
FIRESTONE	W01-358-9321	GTK-358-9321	FIRESTONE	W01-358-9944	GTK-358-9944
FIRESTONE	W01-358-9113	GTK-358-9113	FIRESTONE	W01-358-9961	GTK-358-9961
FIRESTONE	W01-358-9335	GTK-358-9335	FIRESTONE	W01-358-9966	GTK-358-9966
FIRESTONE	W01-358-9336	GTK-358-9336	FIRESTONE	W01-358-9985	GTK-358-9985
FIRESTONE	W01-358-9339	GTK-358-9339	FIRESTONE	W01-358-7731	GTK-358-7731
FIRESTONE	W01-358-9346	GTK-358-9346	FIRESTONE	W01-M58-6165	GTK-M58-6165
FIRESTONE	W01-358-9348	GTK-358-9348	FIRESTONE	W01-358-7451	GTK-358-7451
FIRESTONE	W01-358-9349	GTK-358-9349	FIRESTONE	W01-358-7564	GTK-358-7564
FIRESTONE	W01-358-9350	GTK-358-9350	FIRESTONE	W01-358-7598	GTK-358-7598
FIRESTONE	W01-358-9361	GTK-358-9361	FIRESTONE	W01-M58-6374	GTK-M58-6374
FIRESTONE	W01-358-9362	GTK-358-9362	FIRESTONE	W01-358-6994	GTK-358-6994
FIRESTONE	W01-358-9365	GTK-358-9365	FIRESTONE	W01-358-7008	GTK-358-7008
FIRESTONE	W01-358-9366	GTK-358-9366	FIRESTONE	W01-358-7009	GTK-358-7009
FIRESTONE	W01-358-9367	GTK-358-9367	FIRESTONE	W01-358-7725	GTK-358-7725
FIRESTONE	W01-358-9371	GTK-358-9371	FIRESTONE	W01-358-7095	GTK-358-7095
FIRESTONE	W01-358-9372	GTK-358-9372	FIRESTONE	W01-358-7551	GTK-358-7551
FIRESTONE	W01-358-9373	GTK-358-9373	FIRESTONE	W01-358-6905	GTK-358-6905
FIRESTONE	W01-358-9375	GTK-358-9375	FIRESTONE	W01-M58-6353	GTK-M58-6353
FIRESTONE	W01-358-9388	GTK-358-9388	FIRESTONE	W01-358-0048	GTK-358-0048
FIRESTONE	W01-358-8513	GTK-358-8513	FIRESTONE	W01-358-6955	GTK-358-6955
FIRESTONE	W01-358-9392	GTK-358-9392	FIRESTONE	W01-760-6957	GTK-760-6957
FIRESTONE	W01-358-9394	GTK-358-9394	FIRESTONE	W01-Bellow224	GTK-Bellow224



Suspension

Manufacturer	OEM No.	Part No.
FIRESTONE	W01-358-3400	GTK-358-3400
FIRESTONE	A01-760-0335	GTK-760-0335
FIRESTONE	W01-358-7325	GTK-358-7325
FIRESTONE	W01-358-6926	GTK-358-6926
FIRESTONE	W01-358-6884	GTK-358-6884
FIRESTONE	W01-358-6890	GTK-358-6890
FIRESTONE	W01-358-6897	GTK-358-6897
FIRESTONE	W01-358-6900	GTK-358-6900
FIRESTONE	W01-358-6902	GTK-358-6902
FIRESTONE	W01-358-6905	GTK-358-6905
FIRESTONE	W01-358-6908	GTK-358-6908
FIRESTONE	W01-358-6910	GTK-358-6910
FIRESTONE	W01-358-6926	GTK-358-6926
FIRESTONE	W01-358-6932	GTK-358-6932
FIRESTONE	W01-358-6935	GTK-358-6935
FIRESTONE	W01-358-6940	GTK-358-6940
FIRESTONE	W01-358-6941	GTK-358-6941
FIRESTONE	W01-358-6949	GTK-358-6949
FIRESTONE	W01-358-7788	GTK-358-7788
FIRESTONE	W01-358-7795	GTK-358-7795
FIRESTONE	W01-358-7892	GTK-358-7892
FIRESTONE	W01-358-6883	GTK-358-6883
FIRESTONE	W01-358-6886	GTK-358-6886
FIRESTONE	W01-358-7897	GTK-358-7897
FIRESTONE	W01-358-6927	GTK-358-6927
FIRESTONE	W01-358-6943	GTK-358-6943
FIRESTONE	W01-358-6944	GTK-358-6944
FIRESTONE	W01-358-6945	GTK-358-6945
FIRESTONE	W01-358-6946	GTK-358-6946
FIRESTONE	W01-358-6947	GTK-358-6947
FIRESTONE	W01-358-6948	GTK-358-6948
FIRESTONE	W01-358-6960	GTK-358-6960
FIRESTONE	W01-358-6962	GTK-358-6962
FIRESTONE	W01-M58-7894	GTK-M58-7894
FIRESTONE	W01-358-5900	GTK-358-5900
FIRESTONE	W01-358-6951	GTK-358-6951
FIRESTONE	W01-358-6946	GTK-358-6946
FIRESTONE	W01-M58-6944	GTK-M58-6944
FIRESTONE	W01-358-7325	GTK-358-7325
FIRESTONE	W01-358-7180	GTK-358-7180
FIRESTONE	W01-358-7181	GTK-358-7181
FIRESTONE	W01-358-7183	GTK-358-7183
FIRESTONE	W01-358-7344	GTK-358-7344
FIRESTONE	W01-358-7400	GTK-358-7400
FIRESTONE	W01-358-7401	GTK-358-7401
FIRESTONE	W01-358-7403	GTK-358-7403
FIRESTONE	W01-358-7404	GTK-358-7404
FIRESTONE	W01-358-7405	GTK-358-7405
FIRESTONE	W01-358-7406	GTK-358-7406
FIRESTONE	W01-358-7408	GTK-358-7408
FIRESTONE	W01-358-7409	GTK-358-7409
FIRESTONE	W01-358-7410	GTK-358-7410
FIRESTONE	W01-358-7423	GTK-358-7423
FIRESTONE	W01-358-7424	GTK-358-7424
FIRESTONE	W01-358-7429	GTK-358-7429
FIRESTONE	W01-358-7437	GTK-358-7437
FIRESTONE	W01-358-7472	GTK-358-7472
FIRESTONE	W01-358-7545	GTK-358-7545
FIRESTONE	W01-358-7550	GTK-358-7550
FIRESTONE	W01-358-7555	GTK-358-7555
FIRESTONE	W01-358-7781	GTK-358-7781
FIRESTONE	W01-358-6799	GTK-358-6799
FIRESTONE	W01-358-7557	GTK-358-7557
FIRESTONE	W01-M58-6891	GTK-M58-6891

Manufacturer	OEM No.	Part No.
FIRESTONE	W01-358-7136	GTK-358-7136
FIRESTONE	W01-358-7994	GTK-358-7994
FIRESTONE	W01-358-7995	GTK-358-7995
FIRESTONE	W01-358-7996	GTK-358-7996
FIRESTONE	W01-358-8006	GTK-358-8006
FIRESTONE	W01-358-8008	GTK-358-8008
FIRESTONE	W01-358-8010	GTK-358-8010
FIRESTONE	W01-358-8016	GTK-358-8016
FIRESTONE	W01-358-8025	GTK-358-8025
FIRESTONE	W01-358-8027	GTK-358-8027
FIRESTONE	W01-358-8030	GTK-358-8030
FIRESTONE	W01-358-8029	GTK-358-8029
FIRESTONE	W01-358-7808	GTK-358-7808
FIRESTONE	W01-358-9807	GTK-358-9807

OEM PART NUMBERS ARE FOR REFERENCE ONLY AND FOR CROSS REFERENCES ONLY. ALL PARTS ARE MANUFACTURED BY KROM INTERNATIONAL NOT FIRESTONE.



GLOBETECH-TOUGH

Shock Absorbers

GLOBETECH keeps working long after the job is done

Quality components, precision engineering and a durable, robust design ensure top performance throughout the life of Globetech heavy-duty shock absorbers, and reduce wear and tear on other costly suspension parts.

Drawn over Mandrel (D.O.M.) Inner Cylinder Tube

- Provides smooth surface on inner cylinder for piston seal and piston bearing face
- Less chance of scoring and better durability
- Higher tolerance on the I.D.

Super-Finished Chromed Piston Rods

- Provides superior corrosion resistance, performance and product life

Bulged Design

- Increased fluid capacity
- Lower operating temperatures
- Less internal wear due to heat dissipation

Pressurized, Floating Piston Seal Design

- Self compensates for wear over shock life
- Rugged and durable design
- Less fade, more consistent performance over the full range
- Reduces force-velocity variabilities, increases control capabilities at low velocities



Forged Solid Steel Eye Rings and 360° Arc-Welded End Mounts

- Greater tensile strength
- Reduces end mount failures

Triple Lip, Nitrile Rod Seal

- Extra seal protection improves fluid retention
- Leads to longer product life

Hydraulic Extension Stop

- Unique and robust design
- Prevents shocks from topping out and suspensions from over-extending
- Significantly reduces fatigue in mounts, lights and other vibration sensitive components

10 Stage All Coil Spring Valving

- For comfort and control
- Enhanced durability
- Self-cleaning



Globetech Heavy-Duty Truck Shocks for Class 3-8 Trucks, Buses and Trailers

83000 Series Globetech Shock Absorbers

- Globetech's smallest heavy duty product, for light trucks or heavy truck front suspensions.

85000 Series Globetech Shock Absorbers

- The standard heavy duty product for today's low friction suspensions.
- 1-5/8" bore provides improved durability.
- 360° arc welded end mounts protect against end mount breakage.
- Hydraulic rebound stop prevents impact damage to the shock and vehicle mounting components.
- Multi-lip piston seal provides backup seal protection.
- Welded closure improves pull-apart strength.

89000 Series Globetech Shock Absorbers

- Premium three position adjustable heavy truck gas shock.
- Position adjustable offers personal ride selection.
- 1-5/8" bore, 360° arc welded end mounts provide improved durability.
- Specially formulated H.T. fluid reduces friction and wear in extreme operating conditions
- Many more premium component upgrades combine to provide the ultimate in performance and durability.



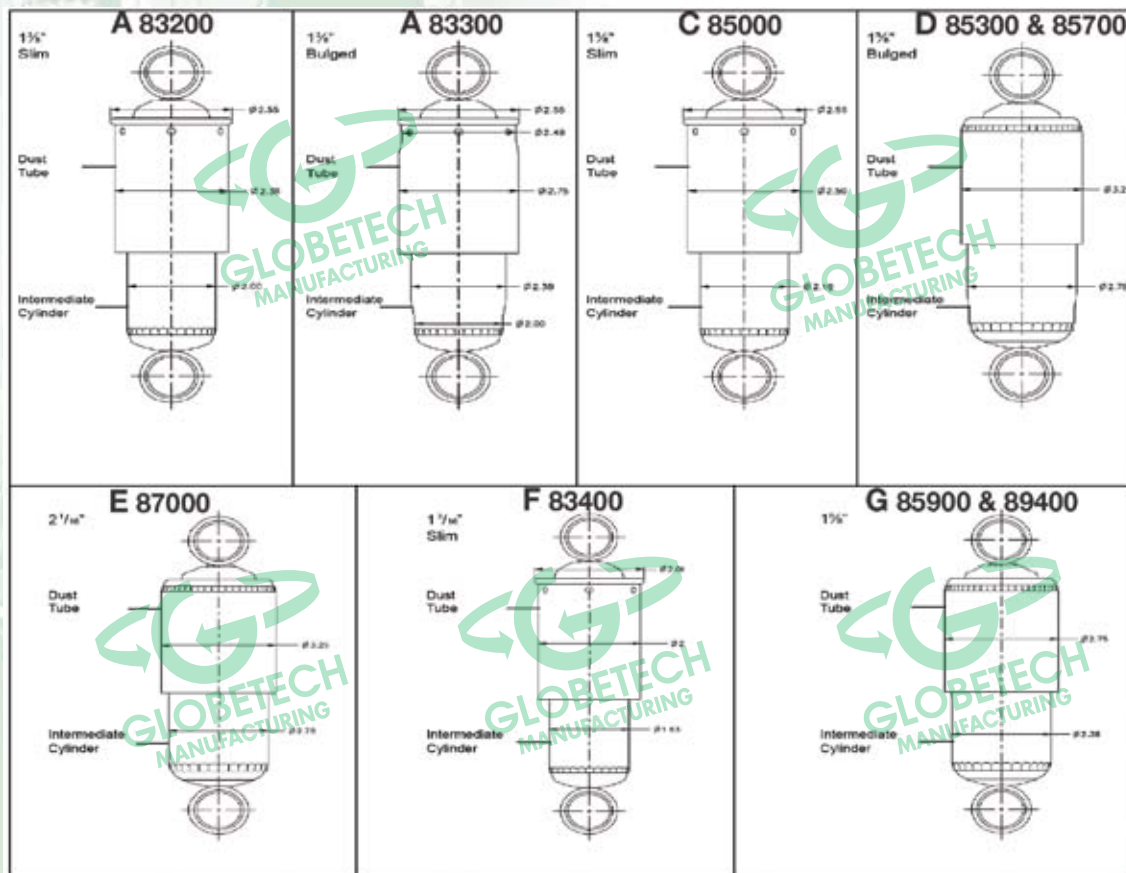





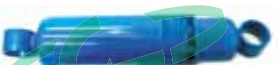





Illustration Diagram



Suspension

Part No.	PICTURE	Illustration Code	Description	OE Replacement	Replaces Gabriel No.
GTK-83009		A	83000 Series	Freightliner	83009
GTK-83125		A	83000 Series	Hendrickson	83125
GTK-83128		A	83000 Series	Neway	83128
GTK-83203		A	83000 Series	Volvo, Hutch	83203
GTK-83207		A	83000 Series	Vovlo, Hutch	83207
GTK-83215		A	83000 Series	Kenworth, International, Mack, Volvo	83215
GTK-83312		B	83000 Series	Meritor	83312
GTK-83317		B	83000 Series	Meritor	83317
GTK-83318		B	83000 Series	Meritor	83318
GTK-83456		B	83000 Series	Volvo, International	83456
GTK-85000		C	85000 Series	Hendrickson	85000
GTK-85001		C	85000 Series	Kenworth	85001
GTK-85003		C	85000 Series	International, Reyco, Volvo	85003
GTK-85006		C	85000 Series	Meritor	85006
GTK-85012		C	85000 Series	Meritor	85012
GTK-85031		C	85000 Series	Meritor	85031
GTK-85043		C	85000 Series	Meritor	85043
GTK-85052		C	85000 Series	Meritor	85052

Suspension

Part No.	PICTURE	Illustration Code	Description	OE Replacement	Replaces Gabriel No.
GTK-85061		C	85000 Series	Volvo	85061
GTK-85066		C	85000 Series	Meritor	85066
GTK-85069		C	85000 Series	Meritor	85069
GTK-85310		D	85000 Series	Kenworth	85310
GTK-85320		D	85000 Series	Freightliner	85320
GTK-85724		D	85000 Series	Freightliner	85724
GTK-85900		G	85000 Series	Freightliner	85900
GTK-85902		G	85000 Series	Meritor	85902
GTK-85909		G	85000 Series	Meritor	85909
GTK-85918		G	85000 Series	Meritor	85918
GTK-85931		G	85000 Series	Meritor	85931
GTK-89408		G	89000 Series	Freightliner	89408
GTK-89410		G	89000 Series	Kenworth, Mack	89410
GTK-89423		G	89000 Series	Kenworth	89423
GTK-89429		G	89000 Series	Freightliner	89429
GTK-89451		G	89000 Series	Meritor	89451



King Pin Locks



- Steel fabricated body
- Yellow powder coated

Part Number	Discription
GT-7201	Standard king pin lock, yellow
GT-611K	Keys only 2 each

King Pin Locks



Part Number	Discription
GT-7201-E100	E-100 King pin lock orange
GT-E100K	Keys only 2 each
GT-7201-E101	E-101 King pin lock, orange
GT-E101K	Keys only 2 each

Heavy Duty King Pin Locks



Part Number	Discription
GT-7202-01	Heavy duty king pin lock (key#01)
GT-7202-01K	Key #01 only - for king pin lock
GT-7202-02	Heavy duty king pin lock (key#02)
GT-7202-02K	Key #02 only - for king pin lock
GT-7202-05	Heavy duty king pin lock (key #05)
GT-7202-05K	Key #05 only - for king pin lock
GT-7202-611K	Keys only for GT-7200 glandhand lock & GT-7201 king pin lock

GT-7208-Flag for king pin lock can be ordered seperate or by adding "F" at end of part #

EXAMPLE: GT-7201F standard king-pin with flag





Gladhand Locks



- Indestructible plastic body
- Stainless steel & zinc plated hardware
- Multiple key patterns available

Part Number	Description
GT-7200	Gladhand lock 611K-Key
GT-7200-E100	Gladhand lock E100K-Key
GT-7200-E101	Gladhand lock and E101K-Key

Part Number	Description
GT-E100K	Keys only for GT-7200
GT-E101K	Keys only for GT-7200-E100
GT-611K	Keys only for GT-7200-E101

**ONE KEY FITS YOUR KING PIN LOCK AND GLANDHAND LOCK!
SECURE YOUR TRAILER WITH TWO LOCKS ONE KEY!**



King Pin Locks

- GT-7201
- GT-7201-E100
- GT-7201-E101

Keys

- GT-611K
- GT-E100K
- GT-E101K

Gladhand Locks

- GT-7200
- GT-7200-E100
- GT-7200-E101



GT-7001- Coil Rack

- Heavy duty coil rack
- Powder coated



GT-1330 - Fifth Wheel Puller

- Fifth wheel hook
- Powder coated



Slick Discs

- Polyethylene with plated snap ring
- Easy installation



GT-7100

Part Number	Description
GT-7100	32" fifth wheel slick disc
GT-7100R	Snap ring for slick disc
GT-7100WR	32" slick disc w/snap ring
GT-7101	36" fifth wheel
GT-7101WR	36" with snap ring



GT-7100R
Spring Steel Retaining Ring
Heat Tested

Note: Silver rings are low quality copies of Globetech rings



Safety Flags and Banners

	Part No.	Replaces Deflect-o	Description	Carton Qty
	GT-8B1818R	DEFB1818R	18" X 18" Jersey Knit Polyester Red Safety Flag With Heavy Duty Bungee Hooks	48
	GT-8W1818R	DEFW1818R	18" X 18" Jersey Knit Polyester Red Safety Flag With Heavy Duty 10 Gauge Wire	48
	GT-8G1818R	DEFG1818R	18" X 18" Jersey Knit Polyester Red Safety Flag With Reinforced Grommets	48
	GT-81854R	DEF1854R	18" X 18" Jersey Knit Polyester Red Safety Flag With 5/8" X 24" Wood Dowel	48
	GT-81002	DEF1002	18" X 84" Mesh With Vinyl Coated Polyester Oversize Load / Wide Load Banner With Rope And 6 Grommets	24
	GT-81002B	DEF1002B	18" X 84" Mesh With Vinyl Coated Polyester Oversize Load / Wide Load Banner With Bungee And 6 Grommets	24
	GT-81009	DEF1009	18" X 84" Vinyl Oversize Load / Wide Load Banner With Rope And 6 Grommets	24
	GT-81009R	DEF1009R	18" X 84" Reflective Vinyl Oversize Load / Wide Load Banner And 6 Grommets	24

Miscellaneous



Safety Flags and Banners

	Part No.	Replaces Deflect-o	Description	Carton Qty
	GT-81009D	DEF1009D	18" X 84" DOUBLE SIDE WIDE LOAD/ OSL BANNER WITH 6 GROMMETS	24
	GT-81010	DEF1010	12" X 60" MESH WITH VINYL COATED POLYESTER OVERSIZE LOAD BANNER WITH 6 GROMMETS	24
	GT-81010R	DEF1010R	12" X 60" REFLECTIVE VINYL OVERSIZE LOAD BANNER WITH 6 GROMMETS	24
	GT-81581	DEF1581	18" X 84" SATIN POLYESTER OVERSIZE LOAD BANNER WITH 18" WEBBING AND 6 GROMMETS	24
	GT-81009RC	DWF1009RC	18" X 84" REFLECTIVE WHITE VINYL OVERSIZE LOAD BANNER WITH 6 GROMMETS - CANADA	24
	GT-81002M	DEF1002M	18" X 84" VINYL MESH OVERSIZE LOAD BANNER WITH 6 GROMMETS AND ROPE - MEXICO	24

GT-81800 Flag Magnet

Great for attaching flags to machinery & flat steel surfaces.
 Chrome steel
 Size 2.63" dia.
 Has 80 lb pull strength.
 Functional, durable and rust resistant.
 Includes 1/4" wing nut to hold flag securely





Emergency Flare Kits



Part Number	Description
GT-8500	Triangle warning kit, 3 triangles per kit with plastic container

Emergency Triangle Kit

- Each kit contains three HD triangles packaged in a red storage box
- Durable fluorescent orange plastic with red reflectors are visible day or night.
- Snaps together for fast and easy set up
- Heavy weighted sand filled base provides stability even in windy conditions
- Friction pads on base keeps triangle in place on highway
- Meets all applicable FMVS 12 and SAE/DOT specifications
- Instructions for proper use molded in the cover and on all triangles

Make sure your vehicle meets FMVSS 125

- FMVSS 125 establishes shape, size and performance requirements for non-powered day and night warning devices that can be erected on or near the roadway to warn approaching traffic of the presence of a stopped vehicle. The purpose of this Standard is to reduce deaths and injuries due to rear-end collisions between moving traffic and disabled vehicles
- Required Application: buses and trucks with GVWR greater than 4,536 kg (10,000 lbs.)



OEM Quality Replacement Mirrors

	Part No.	Description	
	GT-73705S	5" Convex Mirror Stainless Steel L-bracket and center stud	 <p data-bbox="1136 504 1429 798">OEM QUALITY!</p>
	GT-73706S	6" Convex Mirror Stainless Steel L-bracket and center stud	
	GT-73707S	7-1/2" Convex Mirror Stainless Steel L-bracket and center stud	
	GT-73709S	8" Convex Mirror Stainless Steel L-bracket and center stud	
	GT-7727A	West Coast Truck Mirror Head Durable mirror frame and universal application 6 x 16 Aluminum	

GT-7852S
Stainless Steel Tripod Mount



Globetech - Chrome Stacks 6" O.D. Mitre Cut-Style Chrome Stacks

Part No.	A (Length)	B (Length)	End Type	Power Products
GTK-16036	36"	5" O.D. / 6" O.D.	Mitre	G53601

GTK-16036

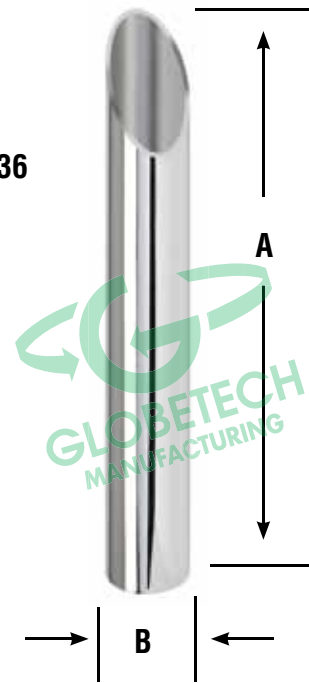

5" O.D. Curve-Style Chrome Stacks

Part No.	A (Length)	B (Length)	End Type	Power Products
GTK-15018	18"	5" I.D.	Curve	51817
GTK-15024	24"	5" O.D.	Curve	52407
GTK-15036	36"	5" O.D.	Curve	53607
GTK-15048	48"	5" O.D.	Curve	54807
GTK-15060	60"	5" O.D.	Curve	56007

GTK-15018



Note: These items are in stock.
Ships Triple packed box, styrofoam and bubble packed



Clamps

Flat U-Bolt Saddle Clamps

Part No.	Size
GTK-80001-40	4" Zinc Plated
GTK-80001-45	4.5" Zinc Plated
GTK-80001-50	5" Zinc Plated



Flat Band Clamps

Part No.	Size
GTK-8010-30	3" Stainless Steel
GTK-8010-35	3.5" Stainless Steel
GTK-8010-40	4" Stainless Steel
GTK-8010-45	4.5" Stainless Steel
GTK-8010-50	5" Stainless Steel
GTK-8010-60	6" Stainless Steel



Preformed Clamps

Part No.	Size
GTK-8020-30	3" Lap Joint - Aluminized
GTK-8020-35	3.5" Lap Joint - Aluminized
GTK-8020-40	4" Lap Joint - Aluminized
GTK-8020-45	4.5" Lap Joint - Aluminized
GTK-8020-50	5" Lap Joint - Aluminized
GTK-8020-50SS	5" Lap Joint - Stainless Steel
GTK-8020-60	6" Lap Joint - Aluminized



Loaded Hose Clamps

Globetech-Bolt spring load clamps have a stainless band, trunnion and liner Heavy duty large spring on spring-loaded T-Bolt clamp Special application sizes for charge-air-after cooled engine systems



Part No.	Clamping Range	Replaces Tectran
GTK-225	2-1/4 2-9/16	HTS225
GTK-275	2-3/4 3-1/16	HTS275
GTK-306	3-1/16 3-3/8	HTS306
GTK-344	3-7/16 3-3/4	HTS344
GTK-356	3-9/16 3-7/8	HTS356
GTK-388	3-7/8 4-3/16	HTS388
GTK-406	4-1/16 4-3/8	HTS406
GTK-419	4-3/16 4-1/2	HTS419
GTK-456	4-9/16 4-7/8	HTS456

all references to competitors' part numbers are for cross reference purposes only



GTK-20015 - Universal Lock Rod Assembly

Replaces: Power Brace
P50015 DL-DL Kit 165408

Lockrod Assembly Kit



KIT - 50015

- Guide plates - 2**
- Guide plate**
- half bushings - 4**
- Rod guide - 1**
- Rod guide half bushings - 2**
- Seal plate - 1**
- Seal pin - 1**

Cross Reference

3M	Globetech	065178	GTA-065178	022-01078	GT-1323	W01-358-9321	GTK-358-9321
75-0301-6340-8	GT-27004	065179	GTA-065179	022-01087	GT-1002	W01-358-9366	GTK-358-9366
75-0301-6343-2	GT-27003	065437 (SR-5)	GTA-065437	022-01190158	GT-1003	W01-358-9367	GTK-358-9367
75-0301-6345-7	GT-27005	065439 (SR-5)	GTA-065439	024-03000	GT-1105	W01-358-9394	GTK-358-9394
Betts	Globetech	101112 (SR-4)	GTA-101112	031-00011	GT-2406	W01-358-9580	GTK-358-9580
A25	GT-2725A	101622 (SR-4)	GTA-101622	031-00414	GT-39414	W01-358-9626	GTK-358-9626
A25RLB90	GT-2725B70	102626 (R-12)	GTA--102626	031-00415	GT-39415	W01-358-9634	GTK-358-9634
A35	GT-2735A	102761 (SR-2)	GTA-102761	031-01200	GT-27516	W01-358-9640	GTK-358-9640
A35RLB40	GT-2735B40	103009 (R-12)	GTA-103009	031-01269	GT-27069	W01-358-9646	GTK-358-9646
A81	GT-2781A	103010 (R-14)	GTA-103010	031-01298	GT-27517	W01-358-9780	GTK-358-9780
A82	GT-2782A	103028 (R-14)	GTA-103028	033-00051	GT-27051	W01-358-9807	GTK-358-9807
B21	GT-2721B	131081 (ST-4)	GTA-131081	033-00053	GT-27053	W01-358-9921	GTK-358-9921
B23	GT-2723B	205105 (ST-1)	GTA-205105	033-00075	GT-2702C	W01-358-9978	GTK-358-9978
B25	GT-2725B	228600 (SL-4)	GTA-228600	033-00076	GT-2702SS	Fuller	Globetech
B29	GT-2729B	228750 (LP-3)	GTA-228750	033-00270	GT-27270	A-470	GTA-A-470
B33	GT-2733B	229859 (QR-1A)	GTA-229859	033-00277	GT-27277	A-5000	GTA-A-5000
B35	GT-2735B	229860 (QR-1B)	GTA-229860	033-00405	2406PSW	Gabriel	Globetech
B572825WTBK	GT-27B5728	275491 (D-2)	GTA-G8602	033-00864	GT-27864	83009	GTK-83009
B572825WTSK	GT-27B5728SS	276566 (PP-1)	GTA-276566	033-00865	GT-27865	83125	GTK-83125
B573025WTBK	GT-27B57	276567 (PP-1)	GTA-276567	033-00868	GT-27868	83128	GTK-83128
B573025WTSK	GT-27B57SS	277863 (E-3)	GTA-277863	033-00870	GT-27870	83203	GTK-83203
B672825WTBK	GT-27B6728	278414 (DC-4)	GTA-278414	033-03404	GT-27404	83207	GTK-83207
B672825WTSK	GT-27B6728SS	278415 (DC-4)	GTA-278415	033-04150	GT-27150	83215	GTK-83215
B673025WTBK	GT-27B67	279000 (TP-3)	GTA-279000	033-05125	GT-2701C	83312	GTK-83312
B673025WTSK	GT-27B67SS	279472 (LP-3)	GTA-279472	033-05126	GT-2701SS	83317	GTK-83317
B683025WTBK	GT-27B68	280479 (DC-1)	GTA-280479	158-A	GT-1005	83318	GTK-83318
B683025WTSK	GT-27B68SS	280479 (DC-1)	GTA-280479	Euclid	Globetech	83456	GTK-83456
B700	GT-27B700	281865 (RE-6)	GTA-281865	E-45040A	GT-45040A	85000	GTK-85000
B703000NTBK	GT-27B7	284143 (ST-3)	GTA-284143	E-4962	GT-4962	85001	GTK-85001
B703000NTCK	GT-27B7C	284412 (DV-2)	GTA-284412	E-4963	GT-4963	85003	GTK-85003
B703000NTSK	GT-27B7SS	286171 (E-6)	GTA-286171	E5568L	GT-4E5568L	85006	GTK-85006
B711	GT-27B711	286370 (R-8)	GTA-286370	E5568R	GT-4E5568R	85012	GTK-85012
B713000NTBK	GT-27B71	286773 (E-7)	GTA-283773	E-5571A	GT-45571A	85031	GTK-85031
B713000NTCK	GT-27B71C	288239 (PP-7)	GTA-288239	E-5572A	GT-45572A	85043	GTK-85043
B713000NTSK	GT-27B71SS	289182 (QR-1C)	GTA-289182	E5977L	GT-4E5977L	85052	GTK-85052
B81	GT-2781B	289714 (QR-1C)	GTA-289714	E5977R	GT-4E5977R	Gabriel	Globetech
B82	GT-2782B	Boomerang	Globetech	E5988L	GT-4E5988L	85061	GTK-85061
B83	GT-2783B	WC1086	GT-2055	E5988R	GT-4E5988R	85066	GTK-85066
B84	GT-2784B	WC1086	GT-2055D	E-6000A	GT-46000A	85069	GTK-85069
BTL-71P5	GT-1004	BWP	Globetech	E7895L	GT-4E7895L	85310	GTK-85310
BTL-820012	GT-1001S	MK10	GTA-MK10	E7895R	GT-4E7895R	85320	GTK-85320
K700	GT-27K700	MK39	GTA-MK39	E7896L	GT-4E7896L	85724	GTK-85724
K711	GT-27K711	MK42	GTA-MK42	E7896R	GT-4E7896R	85900	GTK-85900
PS-1	GT-1001	MK7	GTA-MK7	Firestone	Globetech	85902	GTK-85902
RT25	GT-27RT25	MK72	GTA-MK72	W01-358-6231	GTK-358-6231	85909	GTK-85909
RT35	GT-27RT35	MK79	GTA-MK79	W01-358-6935	GTK-358-6935	85918	GTK-85918
Bendix	Globetech	Fleetline	Globetech	W01-358-7136	GTK-358-7136	85931	GTK-85931
229635	GTA-229635	1300-3A	GT-391300	W01-358-7555	GTK-358-7555	89408	GTK-89408
234099	GT-5212	1585-8WHA	GT-391585	W01-358-7897	GTK-358-7897	89410	GTK-89410
234100	GT-5208	1585FB-kit	GT-39585FB	W01-358-8050	GTK-358-8050	89423	GTK-89423
234101	GT-5209	1585HB-kit	GT-39585HB	W01-358-8091	GTK-358-8091	89429	GTK-89429
234189	GT-5206	1585LM-kit	GT-39585LM	W01-358-8204	GTK-358-8204	89451	GTK-89451
234226	GT-5211	1590-12	GT-395001	W01-358-8708	GTK-358-8708	Grote	Globetech
234362	GT-5214	1590-2BPPA	2406PSB	W01-358-8709	GTK-358-8709	82-0850	GT-3017-20K
234433	GT-5205	1590-8WHA	GT-391590	W01-358-8713	GTK-358-8713	82-0853	GT-3017
801544	GTA-801544	1600-11M	GT-391601	W01-358-8729	GTK-358-8729	82-0854	GT-3017-15
801545	GTA-801545	1600-15M	GT-391600	W01-358-8755	GTK-358-8755	82-0855	GT-3017-20
801546	GTA-801546	1625-16	GT-391625	W01-358-8774	GTK-358-8774	82-0856	GT-3017-30
065066 (QR-N)	GTA-065066	Fleet Engineer	Globetech	W01-358-8944	GTK-358-8944	82-0857	GT-3017-20P
065067 (QR-N)	GTA-065067	021-00043	GT-1300	W01-358-9069	GTK-358-9069	82-0857	GT-3017-30P
065104 (R-12)	GTA-065104	021-00050	GT-1328	W01-358-9082	GTK-358-9082	Haldex-Midland	Globetech
065145 (BP-R1)	GTA-065145	021-00051	GT-1331	W01-358-9082	GTK-358-9082	12352	GTA-12352
065146 (BP-R1)	GTA-065146	021-00053	GT-1304	W01-358-9121	GTK-358-9121	40010140	GTA-40010140
065164	GTA-065164	021-00373	GT-1332	W01-358-9122	GTK-358-9122	40010141	GTA-40010141
065167	GTA-065167	021-00374	GT-1333	W01-358-9265	GTK-358-9265	40010142	GTA-40010142
065170	GTA-065170	022-00487	GT-1327	W01-358-9270	GTK-358-9270	40010143	GTA-40010143
065172	GTA-065172	022-00628	GT-1324	W01-358-9291	GTK-358-9291	40010144	GTA-40010144
065174	GTA-065174	022-01022	GT-1302	W01-358-9293	GTK-358-9293	40010211	GTA-40010211
065175	GTA-065175	022-01024	GT-1326	W01-358-9307	GTK-358-9307	40010212	GTA-40010212

Cross Reference

Haldex-Midland 40010214 40010215 40010216 40010305 40010306 102434T KN16743 KN20030 KN20031 KN20541 KN23000 KN26000 KN27000 KN28500 KN28510 KN28520 KN28600 (FF-2) KN28601 (FF-2) KN30300 KN30400 KN3546 KN44041 KN44051 KN44061 KN44071 KN4688 KN47001 KN47011 KN47081 KN48031 KN51000 KN54101 KN55001 Haltec 382 6A135 A100-VC-1 A100-VC-1 A100-VC-3 A-100-VC-8 DS-1 TV-501 TV-509 TV-510 TV-544D TV-545D TV-572 TV-573 James King 350 500 550 Koneta 430030 430040 041220 0422440 042424 042430 042436 062424 062430 062436 082424 082430 082436 203000 302424	Globetech GTA-40010214 GTA-40010215 GTA-40010216 GTA-40010305 GTA-40010306 GT-6202 GTA-16743 GTA-20030 GTA-20031 GTA-20541 GTA-23000 GTA-26000 GTA-27000 GTA-28500 GTA-28510 GTA-28520 GTA-28600 GTA-28601 GTA-30300 GTA-30400 GTA-3546 GTA-44041 GTA-44051 GTA-44061 GTA-44071 GTA-4688 GTA-47001 GTA-47011 GTA-47081 GTA-48031 GTA-51000 GTA-54101 GTA-55001 Globetech GT-TE-382 GT-45135 GT-VC1 GT-TL610 GT-VC-3 GT-VC-8 GT-DS-1 GT-TR501 GT-TR-509 GT-TR-510 GT-TR-544D GT-TR-545D GT-TR572 GT-573 Globetech GT-1035 GT-1050 GT-1055 Globetech GT-2047D GT-2049 GT-1220RSM GT-2440X GT-2424RM GT-2430RM GT-2436RM GT-2424C GT-2430C GT-2436C GT-2424HDD GT-2430HDD GT-2436HDD GT-3900 2424PSB	302430 302436 312424 312430 312436 372424 372430 372436 430030 523000 55000 Labelmaster 4-TPH 80SM-4CC 80SM-P 81-10FO 81-8FO Meritor 31363-00 31373-00 31426-00 31427-00 R801073 R801074 R955205 R955329 R955335 R955336 R955337 R955341 R955342 R955349 R955365 Neway 90054007 90054074 90054075 90054076 90054079 90054088 90054107 90554241 90554243 K910058 PDC 51817 52407 53607 54807 56007 G53601 Phillips 4-45124 5-45044 5-45064 5-45084 5-45104 5-45164 5-46044 5-46064 5-46084 5-46104 5-46124 5-46164 5-46241 5-46271 5-46281 5-46291 5-46301	2430PSB 2436PSB 2424PSW 2430PSW 2436PSW 2424PPSW 2430PPSW 2436PPSW GT-2047 GT-39585B GT-395000 Globetech GT-1103 GT-1100 GT-1100A GT-1150 GT1151 Globetech GT-4121 GT-4120 GT-4370 GT-4370S GTA-R801073 GTA-R801074 GTA-065225 GTA-R955329 GTA-R955335 GTA-R955336 GTA-R955337 GTA-R955341 GTA-R955342 GTA-R955349 GTA-R955365 Globetech GTA-90054007 GTA-90054074 GTA-90054075 GTA-90054076 GTA-90054079 GTA-90054088 GTA-90054107 GTA-90554241 GTA-90554243 GTA-910058 Globetech GTK-15018 GTK-15024 GTK-15036 GTK-15048 GTK-15060 GTK-16036 Globetech GT-35124 GT-35044 GT-35064 GT-35084 GT-35104 GT-35154 GT-36044 GT-36064 GT-36084 GT-3604 GT-36124 GT-3664 GT-36241 GT-36271 GT-36281 GT-36291 GT-36301	8-2101 8-2102 8-2111 8-2112 8-2121 8-2122 8-2123 8-2131 8-2132 8-2133 8-2135 8-2141 8-2142 8-2143 8-2145 8-2152 8-2153 8-2155 8-2163 8-2165 8-2172 8-2173 8-2175 8-2183 8-2185 11-312 11-315 11-320 11-340 11-5120 11-5150 11-5200 11-5400 12-038 12-039 12-206 12-236 12-306 12-310 12-820 12-8304 12-8305 12-8306 12-8307 12-8308 12-8309 12-8310 12-8311 12-8312 12-8404 12-8405 12-8406 12-8407 12-8408 12-8409 12-8410 12-8411 12-8504 12-8506 12-8508 12-8510 12-8604 12-8606 12-8608 12-8704 12-8706 12-8708 12-8710 12-8804	GT-3500 GT-3501 GT-3502 GT-3503 GT-3504 GT-3505 GT-3506 GT-3507 GT-3508 GT-3509 GT-3510 GT-3511 GT-3512 GT-3513 GT-3514 GT-3522 GT-3523 GT-3524 GT-3520 GT-3521 GT-3517 GT-3518 GT-3519 GT-3515 GT-3516 GTA-120606 GTA-151212 GTA-201212 GTA-151213 GTA-120606X GTA-151212X GTA-201212X GTA-151213X GTA-12-038 GTA-12-039 GT-5380 GT-5383 GT-5339 GT-5338 GT-5300 GTA-12-8304 GTA-12-8305 GTA-12-8306 GTA-12-8307 GTA-12-8308 GTA-12-8309 GTA-12-8310 GTA-12-8311 GTA-12-8312 GTA-12-8404 GTA-12-8405 GTA-12-8406 GTA-12-8407 GTA-12-8408 GTA-12-8409 GTA-12-8410 GTA-12-8411 GTA-12-8504 GTA-12-8506 GTA-12-8508 GTA-12-8510 GTA-12-8604 GTA-12-8606 GTA-12-8608 GTA-12-8704 GTA-12-8706 GTA-12-8708 GTA-12-8710 GTA-12-8804	12-8806 12-8808 12-8810 12-8904 12-8906 Phillips 12-8908 12-8910 12-9304 12-9305 12-9306 12-9307 12-9308 12-9308 12-9309 12-9310 12-9311 12-9312 12-9313 12-9404 12-9405 12-9406 12-9407 12-9408 12-9409 12-9410 12-9504 12-9506 12-9508 12-9604 12-9606 12-9608 15-320 15-320 15-326 15-335 15-335 15-336 15-400 15-430 15-600 15-610 15-630 15-710 15-720 15-720 15-721 15-730 15-730 15-740 15-765 15-766 15-767 15-769 15-775 15-788 15-788 16-713 16-713 16-714 16-714 17-103 17-106 17-111 17-116 17-120 17-125 17-148 17-150	GTA-12-8806 GTA-12-8808 GTA-12-8810 GTA-12-8904 GTA-12-8906 GTA-12-8908 GTA-12-8910 GTA-12-9304 GTA-12-9305 GTA-12-9306 GTA-12-9307 GTA-12-9308 GTA-12-9309 GTA-12-9310 GTA-12-9311 GTA-12-9312 GTA-12-9313 GTA-12-9404 GTA-12-9405 GTA-12-9406 GTA-12-9407 GTA-12-9408 GTA-12-9409 GTA-12-9410 GTA-12-9504 GTA-12-9506 GTA-12-9508 GTA-12-9604 GTA-12-9606 GTA-12-9608 GT-3010 GT-3010G GT-3012 GT-3001 GT-3001G GT-3002 GT-3014 GT-3004 GT-3016 GT-3006A GT-3006B GT-3007A GT-3227 GT-3227E GT-3227SP GT-3007B GT-3007E GT-3200 GT-3203-D GT-3017-G GT-3203-G GT-3203 GT-3204 GT-3227MB GT-3227MZ GT-3007D GT-3227YD GT-3007YD GT-3227D GT-5007 GT-5008 GT-5003 GT-5004 GT-5005 GT-5006 GT-5375 GT-5500-38
-----------------------------------------------------------------------------------------------------------------------------------------------------------------------------------------------------------------------------------------------------------------------------------------------------------------------------------------------------------------------------------------------------------------------------------------------------------------------------------------------------------------------------------------------------------------------------------------------------------------------------------------------------------------------------------------------------------------------------------------------------------------------------------------------------------	-------------------------------------------------------------------------------------------------------------------------------------------------------------------------------------------------------------------------------------------------------------------------------------------------------------------------------------------------------------------------------------------------------------------------------------------------------------------------------------------------------------------------------------------------------------------------------------------------------------------------------------------------------------------------------------------------------------------------------------------------------------------------------------------------------------------------------------------------------------------------------------------------------------------------------------------	----------------------------------------------------------------------------------------------------------------------------------------------------------------------------------------------------------------------------------------------------------------------------------------------------------------------------------------------------------------------------------------------------------------------------------------------------------------------------------------------------------------------------------------------------------------------------------------------------------------------------------------------------------------------------------------------------------------------------------------------------------------------------------------------------------	----------------------------------------------------------------------------------------------------------------------------------------------------------------------------------------------------------------------------------------------------------------------------------------------------------------------------------------------------------------------------------------------------------------------------------------------------------------------------------------------------------------------------------------------------------------------------------------------------------------------------------------------------------------------------------------------------------------------------------------------------------------------------------------------------------------------------------------------------------------------------------------------------------------------------------------------------------------	-------------------------------------------------------------------------------------------------------------------------------------------------------------------------------------------------------------------------------------------------------------------------------------------------------------------------------------------------------------------------------------------------------------------------------------------------------------------------------------------------------------------------------------------------------------------------------------------------------------------------------------------------------------------------------------------------------------------------------------------------	-------------------------------------------------------------------------------------------------------------------------------------------------------------------------------------------------------------------------------------------------------------------------------------------------------------------------------------------------------------------------------------------------------------------------------------------------------------------------------------------------------------------------------------------------------------------------------------------------------------------------------------------------------------------------------------------------------------------------------------------------------------------------------------------------------------------------------------------------------------------------------------------------------------------------------------------	------------------------------------------------------------------------------------------------------------------------------------------------------------------------------------------------------------------------------------------------------------------------------------------------------------------------------------------------------------------------------------------------------------------------------------------------------------------------------------------------------------------------------------------------------------------------------------------------------------------------------------------------------------------------------------------------------------------------------------------------------------	------------------------------------------------------------------------------------------------------------------------------------------------------------------------------------------------------------------------------------------------------------------------------------------------------------------------------------------------------------------------------------------------------------------------------------------------------------------------------------------------------------------------------------------------------------------------------------------------------------------------------------------------------------------------------------------------------------------------------------------------------------------------------------------------------------------------------------------------------------------------------------------------------------------------

Cross Reference

Cross Reference

Phillips	Globetech	RB016	GTA-5285	340-4372	GT-4372	161201	GTA-161201
17-151	GT-5501-38	RB36CK	GTA-5286	340-4975	GT-4020	441004	GT-5339S
17-156	GT-5001-2	Reflexite	Globetech	340-5096	GT-4007F	441014	GT-5338S
17-157	GT-5001-3	V92	GT-27006	340-5097	GT-4007	1055011	GTA-1055011
17-158	GT-5001-4	V92	GT-27007	342-4009	GT-4009G	1077011	GTA-1077011
17-249	GT-5426	V92-5649	GT-27000	342-4013	GT-4013G	101115B	GT-2602
17-420	GT-5427	Sealco	Globetech	342-4024	GT-4024G	101115R	GT-2601
Ranger	Globetech	616	GTA-616	342-4195	GT-4195G	101119B	GT-2607
BTS-2024	GTA-BC2024	2550	GTA-2550	343-4009	GT-4009S	101119R	GT-2606
BTS-2424	GTA-BC2424	21600	GTA-21600	343-4024	GT-4024S	1011FG	GT-5343
BTS-2424LS	GTA-BC2424LS	110139	GTA-110139	343-4095	GT-4095S	1011G	GT-5340
BTS-2430	GTA-BC2430	110170	GTA-110170	343-4195	GT-4195S	1011P	GT-2610
BTS-2430LS	GTA-BC2430LS	110171	GTA-110171	343-4249	GT-4249S	1022-8	GTA-12-027
BTS-3030	GTA-BC3030	110191	GTA-110191	343-4370	GT-4370S	1022-8	GTA-1022-8
BTS-3030LS	GTA-BC3030LS	110197	GTA-110197	343-4372	GT-4372S	10234-8	GTA-10234-8
BTS-3036	GTA-BC3036	110205	GTA-110205	347-4009	GT-4009H	1023-8	GTA-1023-8
BTS-3636	GTA-BC3636	110376	GTA-110376	347-4195	GT-4195H	1024-8	GTA-1024-8
BTS-3030-4.5 BC	GTA-BC3030-4.5DB	110380	GTA-110380	610-0065	GT-4065	1025-8	GTA-1025-8
3030-WCR	GTA-3030-WCR	110410	GTA-110410	610-0084	GT-4084	1031-8	GTA-1031-8
3030LS-WCR	GTA-3030LS-WCR	110415	GTA-110415	640-0001	GT-4640H	103-8	GTA-103-8
BPS-3030	GTA-BC3030P	110500	X-5	640-0003	GT-4020H	1041-8	GTA-1041-8
BPS-3030K	GTA-BC3030PK	110515	GTA-110515	Sirco	Globetech	104-8	GTA-104-8
BPS-3030KLS	GTA-BC3030PLS	110700	GTA-110700	9013	GT-4020	106-8	GTA-106-8
BPS-2024	GTA-BC2024P	110800	GTA-110800	9015	GT-4020H	107-8	GTA-107-8
BPS-3036	GTA-BC3036P	140270	GTA-140270	9018	GT-4640	1106-8	GTA-1106-8
BSC-36	GTA-BC36	140280	GTA-140280	9020	GT-4640H	1107-8	GTA-1107-8
BSC-30LS	GTA-BC30LS	996555	GTA-996555	333B	GT-46000A	113-6AB	GT-5257
30SC-WCR	GTA-BC30SC-WCR	17600B	GTA-17600	B-9015	GT-4014	113-8AB	GT-5256
BSC-30	GTA-BC30	17600B-1	GTA-17600B-1	B-9015V	GT-4014B	114-66	GT-5254
BSC-24	GTA-BC24	Sloan	Globetech	Sirco	Globetech	114B-44	GT-5255
BSC-20	GTA-BC20	42113	GT-3310	9013	GT-4020	115-86	GT-5253
BSC-16	GTA-BC16	44731	GT-5347	9015	GT-4020H	115-88	GT-5251
BSC-12	GTA-BC12	421010	GT-3309	9018	GT-4640	161201-6	GTA-161201-6
BSC-09	GTA-BC09	421145	GT-3324	9020	GT-4640H	161201-8	GTA-161201-8
RB-30DB	GTA-30DB	421146	GT-3325	333B	GT-46000A	17215-040	GTA-151214
RB006	GTA-006	421164	GT-3315	B-9015	GT-4014	17A15-40H	GTA-151214X
RB30PS	GTA-30PS	421165	GT-3316	B-9015V	GT-4014B	17B12H	GTA-120606X
RB009	GTA-009	421166	GT-3306	Tectran	Globetech	17B15H	GTA-151212X
RB010	GTA-010	421167	GT-3307	102	GTA-102	17B20H	GTA-201212X
RB-30DC	GTA-30DC	421172	GT-3326	103	GTA-103	181201-6	GTA-181201-6
RB008	GTA-008	421173	GT-3327	104	GTA-104	181201-8	GTA-181201-8
RB-9PR	GTA-9PR	421180	GT-3311	105	GTA-105	660-15	GT-3550
RB-12PR	GTA-12PR	421247	GT-3308	106	GTA-106	660-20	GT-3551
RB-16PR	GTA-16PR	590080	GT-3303	Tectran	Globetech	660-25	GT-3552
RB-20PR	GTA-20PR	590081	GT-3304	107	GTA-107	660-30	GT-3553
RB033	GTA-24PR	590160	GT-3300	1021	GTA-1021	661-15	GT-3550P
RB034	GTA-30PR	590161	GT-3301	1022	GTA-1022	661-20	GT-3551P
RB-36PR	GTA-36PR	590163	GT-3302	1023	GTA-1023	661-25	GT-3552P
RB-9NPH	GTA-9NPH	7R6122M	GT-3317	1024	GTA-1024	661-30	GT-3553P
RB-12NPH	GTA-12NPH	S600	GT-5251	1025	GTA-1025	667-7040	GT-3100
RB-16NPH	GTA-16NPH	S607	GT-5254	1031	GTA-1031	667-7050	GT-3101
RB-20NPH	GTA-20NPH	S608	GT-5256	1041	GTA-1041	670-11SG	GT-3001
RB-24NPH	GTA-24NPH	S609	GT-5257	1105	GTA-1105	670-12	GT-3010
RB020	GTA-30NPH	S620	GT-5253	1106	GTA-1106	670-21SG	GT-3002
RB-36NPH	GTA-36NPH	S629	GT-5252	1107	GTA-1107	670-22	GT-3012
RB-D-9	GT-5205	S661	GT-5255	5031	GT-3201	70-31402	GTA-5342
RB-D-16	GT-5206	Stemco	Globetech	9411	GT-5346NV	70-31403	GTA-5343
RB-D-24	GT-5208	330-3009	GT-4006	9412	GT-5346V	791-67	GT-3706
RB-D-30	GT-5209	330-3024	GT-4025	10111	GT-2600	7AAB122MG	GT-3306
RB-D-303	GT-5210	330-3067	GT-4004	10234	GTA-10234	7AAB152MG	GT-3307
RB-D-12	GT-5211	330-3077	GT-4021	17212	GTA-120606	7AAB202MG	GT-3308
RB-D-20	GT-5212	330-3118	GT-4008	17215	GTA-151212	7ATG222MG	GT-3300
RB-D-243	GT-5213	340-4009	GT-4009	17220	GTA-201212	7ATG522MG	GT-3301
RB-D-36	GT-5214	340-4013	GT-4013	101112	GT-2599	7ATG542MG	GT-3302
RB053	GTA-5280	340-4024	GT-4024	101113	GT-2604	7ATG622MW	GT-3303
RB9CK	GTA-5281	340-4075	GT-4075	101114	GT-2603	7ATG642MW	GT-3304
RB12CK	GTA-5282	340-4095	GT-4095	101118	GT-2608	7BTG222MG	GT-3324
RB16CK	GTA-5283	340-4195	GT-4195	105501	GTA-105501	7BTG522MG	GT-3325
RB20CK	GTA-5284	340-4370	GT-4370	107701	GTA-107701	7DTB222MW	GT-3326

Cross Reference

Tectran	Globetech	36301	GT-5330
7DTB522MW	GT-3327	36390	GT-5350-90
7ETB222MG	GT-3309	30004	GT-2312
7ETB522MG	GT-3310	36101P	GT-5334X
7ETB542MG	GT-3311	36201P	GT-5334X
7R6122M	GT-3317	36301P	GT-5333X
7SAB122MG	GT-3315	38502W	GT-3338
7SAB152MG	GT-3316	50001	GT-5253
80-1094	GTA-80-1094	50005	GT-5255
80-1095	GTA-80-1095	50006	GT-5254
832SPR	GT-3600	50008	GT-5256
900R-32	GT-36281	50009	GT-5257
9400D-2	GT-5380	50010	GT-5251
9400D-2	GT-5380	50012	GT-5252
9400E-2	GT-5370	56121	GT-5337
9400E-2	GT-5370	56221	GT-5336
9400F-2	GT-5382	56321	GT-5335
9400F-2	GT-5382	9202	GT-5339S
9400G-2	GT-5371	9203	GT-5338S
9400G-2	GT-5371	9211	GT-5339
9400H-2	GT-5385	9212	GT-5338
9400H-2	GT-5385	1010-F18	GT-5345
9400J-2	GT-5384	Trailmobile	Globetech
9400J-2	GT-5384	700-7-14	GT-41226
9400L-2	GT-5381	700-7-15	GT-43068
9400L-2	GT-5381	Trux	Globetech
9400M-2	GT-5383	LT77S	GT-27LT77S
9400M-2	GT-5383	Trucklite	Globetech
9420-1	GT-5379	26330	GT-7460
A148	GT-451065	80360	GT-7450
A824	GT-45130	97960	GT-1007
HTS225	GTK-225	97962	GT-1008
HTS225	GTA-225	Utility	Globetech
HTS275	GTK-275	03-1250-006	GT-UTM006
HTS275	GTA-275	03-1250-025	GT-025
HTS306	GTK-306	03-1250-053	GT-UTM053
HTS306	GTA-306	03-1250-172	GT-UTM172
HTS344	GTK-344	03-1250-214	GT-UTM214
HTS344	GTA-344	03-1250-259	GT-UTM259
HTS356	GTK-356	Wabash	Globetech
HTS356	GTA-356	004400035	GT-04400035
HTS388	GTK-388	06300015	GT-1301
HTS388	GTA-388	06300028	GT-1302
HTS406	GTK-406	06300058	GT-1314
HTS406	GTA-406	06300094	GT-1303
HTS419	GTK-419	06300117	GT-1304
HTS419	GTA-419	06300118	GT-1305
HTS456	GTK-456	06300119	GT-1306
HTS456	GTA-456	063002201	GT-1334
SC-1	GT-5256	06300250	GT-1329
Todco	Globetech	06300693	GT-1307
61196	GT-1401	06300805	GT-1308
69035	GT-1400	06300844	GT-1315
Tramec	Globetech	06300985	GT-1316
30026	GT-2006	06301166	GT-1309
30027	GT-2027	06301167	GT-1310
30037	GT-2044	06301217	GT-1318
30039	GT-2042	06301964	GT-1312
30045	GT-2345	06302523	GT-1313
36001	GT-2600	06302613	GT-1317
36003	GT-2599	10600526	GT-6200
36101	GT-5332	21300053	GT-2108
36133	GT-5354	21400170	GT-2100
36181	GT-5352-45	21400177	GT-2105
36191	GT-5352-90	525461	GT-1328
36201	GT-5331	61174	GT-1402
36201	GT-5351-90	70225	GT-1403
36233	GT-5353	A1300017	GT-1300
36281	GT-5351-45		

INDEX

Part No.	Page No.	Part No.	Page No.	Part No.	Page No.
2406PSB	51	GT-1050L	3	GT-1324	11
2406PSW	51	GT-1055	3	GT-1326	8
2424PHDB	32	GT-1055L	3	GT-1326	11
2424PHDW	32	GT-1100	5	GT-1327	11
2424PPSB	32	GT-1100A	5	GT-1328	11
2424PPSW	32	GT-1101	5	GT-1329	13
2424PSB	32	GT-1101A	5	GT-1330	153
2424PSW	32	GT-1102	5	GT-1331	12
2430PHDB	32	GT-1103	5	GT-1332	12
2430PHDW	32	GT-1105	4	GT-1333	12
2430PPSB	32	GT-1105B	4	GT-1334	13
2430PPSW	32	GT-1106	16	GT-1336	13
2430PSB	32	GT-1107	16	GT-1400	11
2430PSW	32	GT-1108	6	GT-1401	11
2436PHDB	32	GT-1111	5,16	GT-1402	12
2436PHDW	32	GT-1114	17	GT-1403	12
2436PPSB	32	GT-1114C	17	GT-1410	18
2436PPSW	32	GT-1124	17	GT-1411	18
2436PSB	32	GT-1150	5	GT-1422	18
2436PSW	32	GT-1150W	5	GT-1924S	23
A52475	36	GT-1151	5	GT-2000	37
D-312	38	GT-1151W	5	GT-2006	37
D-324	38	GT-1201	14	GT-2027	37
D-372	38	GT-1202	14	GT-2036	39
D-412D	38	GT-12-038	131	GT-2041	39
D-424	38	GT-12-039	131	GT-2042	37
D-424A	38	GT-1210	15	GT-2043	39
D-472	38	GT-1217S	23	GT-2044	37
D-612	38	GT-1220RSM	26	GT-2045	39
D-624	38	GT-1270	14	GT-2046	39
D-672	38	GT-1300	9	GT-2047	36
GT-025	40	GT-1301	8	GT-2047D	36
GT-04400035	4	GT-1302	8	GT-2048	36
GT-1001	2	GT-1303	8	GT-2049	36
GT-1001S	2	GT-1304	10	GT-2050	36
GT-1002	4	GT-1305	9	GT-2055	36
GT-1002WHT	4	GT-1306	8	GT-2055D	36
GT-1003	2	GT-1307	8	GT-2057	36
GT-1004	2	GT-1308	10	GT-2099	38
GT-1005	2	GT-1309	10	GT-2100	40
GT-1006	2	GT-1310	10	GT-2101	40
GT-1007	2	GT-1311	13	GT-2102	40
GT-1008	2	GT-1312	8	GT-2103	40
GT-1009	2	GT-1313	9	GT-2104	40
GT-1011	16	GT-1314	9	GT-2105	40
GT-1035	3	GT-1315	10	GT-2106	40
GT-1035B	3	GT-1316	9	GT-2107	40
GT-1035L	3	GT-1317	9	GT-2108	40
GT-1050	3	GT-1318	10	GT-2108	40

INDEX

Part No.	Page No.	Part No.	Page No.	Part No.	Page No.
GT-2109	40	GT-2601WS	129	GT-27864	46
GT-2312	37	GT-2602	129	GT-27865	46
GT-2345	37	GT-2602WS	129	GT-27868	46
GT-2406	51	GT-2603	129	GT-27870	46
GT-2418S	23	GT-2603WS	129	GT-27B57	47
GT-2424AS	25	GT-2604	129	GT-27B5728	47
GT-2424C	22	GT-2605GLO	128	GT-27B5728SS	47
GT-2424CD	21	GT-2605WS	128	GT-27B57SS	47
GT-2424HD	25	GT-2606	129	GT-27B67	47
GT-2424HDD	25	GT-2607	129	GT-27B6728	47
GT-2424RGM	27	GT-2608	129	GT-27B6728C	47
GT-2424RSM	27	GT-2609	128	GT-27B6728SS	47
GT-2424S	23	GT-2610	131	GT-27B67C	47
GT-2424TPHD	28	GT-2613	40	GT-27B67SS	47
GT-2424TPPSB	28	GT-27000	45	GT-27B68	47
GT-2424XD	24	GT-27003	7, 45	GT-27B68C	47
GT-2430C	22	GT-27004	7, 45	GT-27B68SS	47
GT-2430CD	21	GT-27005	7, 45	GT-27B7	48
GT-2430HD	25	GT-27006	7, 45	GT-27B700	43
GT-2430HDD	25	GT-27007	7, 45	GT-27B71	48
GT-2430M	26	GT-2701C	43	GT-27B711	43
GT-2430PSBL	29	GT-2701SS	43	GT-27B71C	48
GT-2430PSR	29	GT-2702C	43	GT-27B71SS	48
GT-2430PSS	29	GT-2702SS	43	GT-27B7C	48
GT-2430PST	29	GT-27051	44	GT-27B7SS	48
GT-2430PSY	29	GT-27053	44	GT-27K700	43
GT-2430RGM	27	GT-27069	45	GT-27K711	43
GT-2430RSM	27	GT-27150	46	GT-27LT77S	48
GT-2430RT	26	GT-2721B	42	GT-27RT25	45
GT-2430S	23	GT-2723B	41	GT-27RT35	45
GT-2430TPHD	28	GT-2725A	41	GT-3001	58
GT-2430TPPSB	28	GT-2725B	41	GT-3001G	58
GT-2430XD	24	GT-2725B70	41, 44	GT-3002	58
GT-2436C	22	GT-27270	46	GT-3004	58
GT-2436CD	21	GT-27277	46	GT-3005	58
GT-2436HD	25	GT-2729B	41	GT-3006A	58
GT-2436HDD	25	GT-2733B	41	GT-3006B	58
GT-2436M	26	GT-2735A	41	GT-3007	91
GT-2436RGM	27	GT-2735B	41	GT-3007A	58
GT-2436RSM	27	GT-2735B40	41, 44	GT-3007B	58
GT-2436S	23	GT-27404	46	GT-3007D	58
GT-2436TPHD	28	GT-27516	44	GT-3007E	58
GT-2436TPPSB	28	GT-27517	44	GT-3007Y	58
GT-2436XD	24	GT-2781A	42	GT-3007YD	58
GT-2440X	24	GT-2781B	42	GT-3010	59
GT-2442X	24	GT-2782A	42	GT-3010G	59
GT-2599	129	GT-2782B	42	GT-3012	59
GT-2600	129	GT-2783B	42	GT-3014	59
GT-2601	129	GT-2784B	42	GT-3015	59

INDEX

Part No.	Page No.	Part No.	Page No.	Part No.	Page No.
GT-3016	59	GT-3337	59	GT-3604YD	61
GT-3017	63	GT-3338	59	GT-36064	62
GT-3017-15	63	GT-3338G	59	GT-3607	61
GT-3017-15P	63	GT-3338K	59	GT-36084	62
GT-3017-20	63	GT-3400	64	GT-36104	62
GT-3017-20K	63	GT-3401	64	GT-3612	60
GT-3017-20P	63	GT-3402	62	GT-36124	62
GT-3017-30	63	GT-3403	62	GT-3613	60
GT-3017-30P	63	GT-3500	65	GT-3614	60
GT-3017-G	63	GT-3501	65	GT-3614-2	60
GT-3100	60	GT-3502	65	GT-3615	60
GT-3101	60	GT-3503	65	GT-3616	60
GT-3200	61	GT-3504	65	GT-36164	62
GT-3201	64	GT-35044	62	GT-3624	60
GT-3202	61	GT-3505	65	GT-36241	62
GT-3203	63	GT-3506	65	GT-36271	62
GT-3203-D	63	GT-35064	62	GT-36281	62
GT-3203-G	63	GT-3507	65	GT-36291	62
GT-3204	63	GT-3508	65	GT-36301	62
GT-3204-D	63	GT-35084	62	GT-36302	62
GT-3204-G	63	GT-3509	65	GT-36304	62
GT-3227	59	GT-3510	65	GT-3704YD	61
GT-3227D	59	GT-35104	62	GT-3706	61
GT-3227E	59	GT-3511	65	GT-3707YD	61
GT-3227MB	59	GT-3512	65	GT-3714	61
GT-3227MZ	59	GT-35124	62	GT-3715	61
GT-3227SP	59	GT-3513	65	GT-3715W	61
GT-3227YD	59	GT-3514	65	GT-3801	65
GT-3300	55	GT-3515	65	GT-3802	65
GT-3301	55	GT-35154	62	GT-3803	65
GT-3302	55	GT-3516	65	GT-3803-G	65
GT-3303	55	GT-3517	65	GT-3803-R	65
GT-3304	55	GT-3518	65	GT-3804	65
GT-3306	55	GT-3519	65	GT-3805	65
GT-3307	55	GT-3520	65	GT-3806	65
GT-3308	55	GT-3521	65	GT-3807	65
GT-3309	56	GT-3522	65	GT-3808	65
GT-3310	56	GT-3523	65	GT-3809	65
GT-3311	56	GT-3524	65	GT-3810	65
GT-3315	56	GT-3550	64	GT-3900	50
GT-3316	56	GT-3550P	64	GT-391300	52
GT-3317	57	GT-3551	64	GT-391301	52
GT-3320	91	GT-3551P	64	GT-391585	52
GT-3321	91	GT-3552	64	GT-391590	52
GT-3322	91	GT-3552P	64	GT-391600	53
GT-3324	57	GT-3553	64	GT-391601	53
GT-3325	57	GT-3553P	64	GT-391625	52
GT-3326	57	GT-3600	91	GT-391626	52
GT-3327	57	GT-36044	62	GT-39414	51

INDEX

Part No.	Page No.	Part No.	Page No.	Part No.	Page No.
GT-39415	51	GT-4249S	69	GT-5209	87
GT-39416	51	GT-4300	78	GT-5210	87
GT-395000	53	GT-4301	78	GT-5211	87
GT-395001	53	GT-4302	78	GT-5212	87
GT-39585B	49	GT-43068	75	GT-5213	87
GT-39585FB	49	GT-4370	76	GT-5214	87
GT-39585HB	50	GT-4370S	76	GT-5251	100
GT-39585LM	50	GT-4372	76	GT-5252	100
GT-4000	71	GT-4372S	76	GT-5253	100
GT-4001	71	GT-443638	29	GT-5254	100
GT-4001B	71	GT-45000	75	GT-5255	100
GT-4002	71	GT-45040A	75	GT-5256	100
GT-4003	71	GT-451065	79	GT-5257	100
GT-4004	72	GT-451070	79	GT-5300	99
GT-4005	71	GT-45130	79	GT-5317	127
GT-4006	72	GT-45135	79	GT-5327	127
GT-4007	68	GT-45571A	75	GT-5330	126
GT-4007F	68	GT-45572A	75	GT-5331	126
GT-4008	72	GT-46000A	75	GT-5332	126
GT-4009	67	GT-4640	69	GT-5333X	127
GT-4009G	67	GT-4640H	69	GT-5334X	127
GT-4009H	67	GT-4962	75	GT-5335	128
GT-4009K	67	GT-4963	75	GT-5336	128
GT-4009S	67	GT-4E5568L	74	GT-5337	128
GT-4009SK	67	GT-4E5568R	74	GT-5338	127
GT-4013	68	GT-4E5977L	74	GT-5338S	127
GT-4014	71	GT-4E5977R	74	GT-5339	127
GT-4014B	71	GT-4E5988L	74	GT-5339S	127
GT-4020	70	GT-4E5988R	74	GT-5340	132
GT-4020B	70	GT-4E7895L	74	GT-5341	91
GT-4020H	70	GT-4E7895R	74	GT-5341	132
GT-4021	71	GT-4E7896L	74	GT-5343	132
GT-4024	68	GT-4E7896R	74	GT-5345	130
GT-4024S	68	GT-5001	101	GT-5345FX	130
GT-4025	72	GT-5001-2	102	GT-5346NV	130
GT-4040	78	GT-5001-3	102	GT-5346V	130
GT-4065	69	GT-5001-4	102	GT-5347	130
GT-4075	69	GT-5002	101	GT-5350-90	126
GT-4084	69	GT-5003	101	GT-5351-45	126
GT-4095	69	GT-5004	101	GT-5351-90	126
GT-4095S	69	GT-5006	101	GT-5351P-45	126
GT-4101	78	GT-5007	101	GT-5351P-90	126
GT-4120	77	GT-5008	101	GT-5352-45	126
GT-4121	77	GT-5010	102	GT-5352-90	126
GT-41226	75	GT-5011	102	GT-5352P-45	126
GT-4195	68	GT-5012	102	GT-5352P-90	126
GT-4195G	68	GT-5205	87	GT-5353	126
GT-4195H	68	GT-5206	87	GT-5354	126
GT-4195S	68	GT-5208	87	GT-53550-45	126

INDEX

Part No.	Page No.	Part No.	Page No.	Part No.	Page No.
GT-5370	103	GT-73705S	157	GT-TL610	81
GT-5371	103	GT-73706S	157	GT-TR501	80
GT-5372	103	GT-73707S	157	GT-TR509	80
GT-5375	101	GT-73709S	157	GT-TR510	80
GT-5376	91	GT-7450	66	GT-TR544D	80
GT-5377	17	GT-7460	66	GT-TR545D	80
GT-5378	17	GT-7461	66	GT-TR572	80
GT-5379	91	GT-7600	73	GT-TR573	80
GT-5380	103	GT-7600B	73	GT-UTM006	37
GT-5380	128	GT-7600BLK	73	GT-UTM053	37
GT-5381	103	GT-7710	62	GT-UTM172	37
GT-5382	103	GT-7711	62	GT-UTM214	37
GT-5383	103	GT-7712	62	GT-UTM259	37
GT-5383	128	GT-7713	62	GT-VC-1	81
GT-5384	103	GT-7727A	157	GT-VC-3	81
GT-5385	103	GT-7852S	157	GT-VC-8	81
GT-5421	101	GT-81002	154	GTA-006	86
GT-5422	101	GT-81002B	154	GTA-008	86
GT-5423	101	GT-81002M	155	GTA-009	86
GT-5424	101	GT-81009	154	GTA-010	86
GT-5425	101	GT-81009D	155	GTA-065066	119
GT-5426	101	GT-81009R	154	GTA-065067	119
GT-5427	101	GT-81009RC	155	GTA-065104	120
GT-5500-12	102	GT-81010	155	GTA-065145	121
GT-5500-38	102	GT-81010R	155	GTA-065146	121
GT-5501-12	102	GT-81581	155	GTA-065164	108
GT-5501-38	102	GT-81854R	154	GTA-065167	108
GT-611K	130, 150, 153	GT-848S	29	GTA-065170	108
GT-6200	82	GT-8500	156	GTA-065172	108
GT-6202	82	GT-8B1818R	154	GTA-065174	108
GT-7001	153	GT-8G1818R	154	GTA-065175	108
GT-7100	153	GT-8W1818R	154	GTA-065178	108
GT-7100R	153	GT-9014	33	GTA-065179	108
GT-7100WR	153	GT-9015	33	GTA-065225	125
GT-7101	153	GT-9016	33	GTA-065437	123
GT-7101WR	153	GT-9017	33	GTA-065439	123
GT-7200	130, 152	GT-9019	33	GTA-101112	124
GT-7200-E100	130, 152	GT-9020	33	GTA-101622	124
GT-7200-E101	130, 152	GT-9021	33	GTA-102	94
GT-7201	151, 152	GT-9023	33	GTA-1021	94
GT-7201-E100	151, 152	GT-9024	33	GTA-1022	95
GT-7201-E101	151, 152	GT-9025	33	GTA-1022-8	95
GT-7202-01	151	GT-9032	33	GTA-1023	95
GT-7202-01K	151	GT-DS-1	81	GTA-10234	95
GT-7202-02	151	GT-E100K	130, 150, 153	GTA-10234-8	95
GT-7202-02K	151	GT-E101K	130, 150, 153	GTA-1023-8	95
GT-7202-05	151	GT-Q500	118	GTA-1024	95
GT-7202-05K	151	GT-SC-1	99	GTA-1024-8	95
GT-7202-611K	151	GT-TE382	80	GTA-1025	95

INDEX

Part No.	Page No.	Part No.	Page No.	Part No.	Page No.
GTA-1025-8	95	GTA-12000	92	GTA-1238S44	93
GTA-102626	120	GTA-120606	89	GTA-1238S46	93
GTA-102761	124	GTA-120606X	90	GTA-1238S48	93
GTA-103	94	GTA-12352	121	GTA-1238S50	93
GTA-103009	120	GTA-1238F08	93	GTA-1238S52	93
GTA-103010	120	GTA-1238F12	93	GTA-1238S54	93
GTA-103028	120	GTA-1238F14	93	GTA-1238S56	93
GTA-1031	94	GTA-1238F16	93	GTA-1238S60	93
GTA-1031-8	94	GTA-1238F18	93	GTA-1238S66	93
GTA-103-8	94	GTA-1238F20	93	GTA-1238S72	93
GTA-104	94	GTA-1238F22	93	GTA-1238S84	93
GTA-1041	94	GTA-1238F24	93	GTA-12-8304	97
GTA-1041-8	94	GTA-1238F26	93	GTA-12-8305	97
GTA-104-8	94	GTA-1238F28	93	GTA-12-8306	97
GTA-105	94	GTA-1238F30	93	GTA-12-8307	97
GTA-105501	95	GTA-1238F32	93	GTA-12-8308	97
GTA-1055011	95	GTA-1238F34	93	GTA-12-8309	97
GTA-106	94	GTA-1238F36	93	GTA-12-8310	97
GTA-106-8	94	GTA-1238F38	93	GTA-12-8311	97
GTA-107	94	GTA-1238F40	93	GTA-12-8312	97
GTA-1076-6-6	100	GTA-1238F42	93	GTA-12-8404	97
GTA-1076-6-8	100	GTA-1238F44	93	GTA-12-8405	97
GTA-1076-8-6	100	GTA-1238F46	93	GTA-12-8406	97
GTA-1076-8-8	100	GTA-1238F48	93	GTA-12-8407	97
GTA-107695	125	GTA-1238F50	93	GTA-12-8408	97
GTA-107701	95	GTA-1238F52	93	GTA-12-8409	97
GTA-1077011	95	GTA-1238F54	93	GTA-12-8410	97
GTA-107794	125	GTA-1238F56	93	GTA-12-8411	97
GTA-107798	125	GTA-1238F60	93	GTA-12-8504	97
GTA-107799	125	GTA-1238F66	93	GTA-12-8506	97
GTA-107-8	94	GTA-1238F72	93	GTA-12-8508	97
GTA-107800	125	GTA-1238F84	93	GTA-12-8510	97
GTA-109493	125	GTA-1238S08	93	GTA-12-8604	97
GTA-110170	123	GTA-1238S12	93	GTA-12-8606	97
GTA-110171	123	GTA-1238S14	93	GTA-12-8608	97
GTA-110197	122	GTA-1238S16	93	GTA-12-8704	97
GTA-110200	121	GTA-1238S18	93	GTA-12-8706	97
GTA-110205	121	GTA-1238S20	93	GTA-12-8708	97
GTA-110415	122	GTA-1238S22	93	GTA-12-8710	97
GTA-1105	94	GTA-1238S24	93	GTA-12-8804	97
GTA-110570	116	GTA-1238S26	93	GTA-12-8806	97
GTA-1106	94	GTA-1238S28	93	GTA-12-8808	97
GTA-1106-8	94	GTA-1238S30	93	GTA-12-8810	97
GTA-1107	94	GTA-1238S32	93	GTA-12-8904	97
GTA-1107-8	94	GTA-1238S34	93	GTA-12-8906	97
GTA-1176-6-6	100	GTA-1238S36	93	GTA-12-8908	97
GTA-1176-6-8	100	GTA-1238S38	93	GTA-12-8910	97
GTA-1176-8-6	100	GTA-1238S40	93	GTA-12-9304	98
GTA-1176-8-8	100	GTA-1238S42	93	GTA-12-9305	98

INDEX

Part No.	Page No.	Part No.	Page No.	Part No.	Page No.
GTA-12-9306	98	GTA-1924-04	96	GTA-24100	112
GTA-12-9307	98	GTA-1924-04-1	96	GTA-24102	112
GTA-12-9308	98	GTA-1924-05	96	GTA-24103	112
GTA-12-9309	98	GTA-1924-05-1	96	GTA-24NPH	86
GTA-12-9310	98	GTA-1924-07	96	GTA-24PR	86
GTA-12-9311	98	GTA-1924-07-1	96	GTA-25100	112
GTA-12-9312	98	GTA-1926-01	96	GTA-25102	112
GTA-12-9313	98	GTA-1926-01-1	96	GTA-25103	112
GTA-12-9404	98	GTA-1926-02	96	GTA-26000	119
GTA-12-9405	98	GTA-1926-02-1	96	GTA-27000	118
GTA-12-9406	98	GTA-1926-04	96	GTA-276566	116
GTA-12-9407	98	GTA-1926-04-2	96	GTA-276567	116
GTA-12-9408	98	GTA-1926-05	96	GTA-277863	115
GTA-12-9409	98	GTA-1926-05-1	96	GTA-278614	116
GTA-12-9410	98	GTA-1926-07	96	GTA-278615	116
GTA-12-9504	98	GTA-1926-07-1	96	GTA-279000	124
GTA-12-9506	98	GTA-1928-01	96	GTA-279472	118
GTA-12-9508	98	GTA-1928-01-1	96	GTA-280479	116
GTA-12-9604	98	GTA-1928-02	96	GTA-281865	121
GTA-12-9606	98	GTA-1928-02-1	96	GTA-284143	123
GTA-12-9608	98	GTA-1928-05	96	GTA-284412	115
GTA-12NPH	86	GTA-1928-05-1	96	GTA-28500	121
GTA-12PR	86	GTA-1928-07	96	GTA-28510	121
GTA-131081	122	GTA-1928-07-1	96	GTA-28520	121
GTA-151212	89	GTA-1930-01	96	GTA-28600	117
GTA-151212X	90	GTA-1930-01-1	96	GTA-28601	117
GTA-151213	89	GTA-1930-04-1	96	GTA-286171	115
GTA-151213X	90	GTA-1932-01	96	GTA-286364	123
GTA-151214	89	GTA-1932-01-1	96	GTA-286370	122
GTA-151214X	90	GTA-20030	117	GTA-286771	115
GTA-161201	94	GTA-20031	117	GTA-286773	115
GTA-161201-6	94	GTA-201212	89	GTA-288239	119
GTA-161201-8	94	GTA-201212X	90	GTA-289182	120
GTA-16743	115	GTA-205105	123	GTA-289714	120
GTA-16NPH	86	GTA-20541	117	GTA-30300	122
GTA-16PR	86	GTA-20NPH	86	GTA-3030LS-WCR	85
GTA-17600	115	GTA-20PR	86	GTA-3030-WCR	85
GTA-181201-6	94	GTA-21102	112	GTA-30400	122
GTA-181201-8	94	GTA-21103	112	GTA-30DB	86
GTA-1922-01	96	GTA-22102	112	GTA-30DC	86
GTA-1922-01-1	96	GTA-22103	112	GTA-30NPH	86
GTA-19225-01	96	GTA-228600	124	GTA-30PR	86
GTA-19225-01-1	96	GTA-228750	118	GTA-30PS	86
GTA-1923-01	96	GTA-229635	116	GTA-34100	112
GTA-1923-01-1	96	GTA-229859	120	GTA-34200	112
GTA-1924-01	96	GTA-229860	120	GTA-35100	112
GTA-1924-01-1	96	GTA-23000	116	GTA-35200	112
GTA-1924-02	96	GTA-23102	112	GTA-3546	119
GTA-1924-02-1	96	GTA-23800	116	GTA-36NPH	86

INDEX

Part No.	Page No.	Part No.	Page No.	Part No.	Page No.
GTA-36PR	86	GTA-3838S48	93	GTA-90054076	123
GTA-38000	92	GTA-3838S50	93	GTA-90054079	119
GTA-3838F08	93	GTA-3838S52	93	GTA-90054088	119
GTA-3838F12	93	GTA-3838S54	93	GTA-90054107	119
GTA-3838F14	93	GTA-3838S56	93	GTA-90554241	118
GTA-3838F16	93	GTA-3838S60	93	GTA-90554243	118
GTA-3838F18	93	GTA-3838S66	93	GTA-910058	118
GTA-3838F20	93	GTA-3838S72	93	GTA-9NPH	86
GTA-3838F22	93	GTA-3838S84	93	GTA-9PR	86
GTA-3838F24	93	GTA-40010140	109	GTA-A10005	122
GTA-3838F26	93	GTA-40010141	110	GTA-A4688	124
GTA-3838F28	93	GTA-40010142	109	GTA-A4740	117
GTA-3838F30	93	GTA-40010143	109	GTA-A5000	124
GTA-3838F32	93	GTA-40010144	109	GTA-BC09	85
GTA-3838F34	93	GTA-40010211	111	GTA-BC12	85
GTA-3838F36	93	GTA-40010212	111	GTA-BC16	85
GTA-3838F38	93	GTA-40010214	111	GTA-BC20	85
GTA-3838F40	93	GTA-40010215	110	GTA-BC2024	85
GTA-3838F42	93	GTA-40010216	110	GTA-BC2024P	85
GTA-3838F44	93	GTA-40010305	110	GTA-BC24	85
GTA-3838F46	93	GTA-40010306	110	GTA-BC2424	85
GTA-3838F48	93	GTA-41100	112	GTA-BC2424LS	85
GTA-3838F50	93	GTA-41106	112	GTA-BC2430	85
GTA-3838F52	93	GTA-42100	112	GTA-BC2430LS	85
GTA-3838F54	93	GTA-42106	112	GTA-BC30	85
GTA-3838F56	93	GTA-43100	112	GTA-BC3030	85
GTA-3838F60	93	GTA-43106	112	GTA-BC3030-4.5DB	85
GTA-3838F66	93	GTA-5001247	125	GTA-BC3030LS	85
GTA-3838F72	93	GTA-5004341	125	GTA-BC3030P	85
GTA-3838F84	93	GTA-5280	87	GTA-BC3030PK	85
GTA-3838S08	93	GTA-5281	87	GTA-BC3030PLS	85
GTA-3838S12	93	GTA-5282	87	GTA-BC3030V	85
GTA-3838S14	93	GTA-5283	87	GTA-BC3036	85
GTA-3838S16	93	GTA-5284	87	GTA-BC3036P	85
GTA-3838S18	93	GTA-5285	87	GTA-BC30LS	85
GTA-3838S20	93	GTA-5286	87	GTA-BC30SC-WCR	85
GTA-3838S22	93	GTA-5342	99	GTA-BC36	85
GTA-3838S24	93	GTA-5343	99	GTA-BC3636	85
GTA-3838S26	93	GTA-65612	125	GTA-G8602	117
GTA-3838S28	93	GTA-800404	125	GTA-KN44041	106
GTA-3838S30	93	GTA-80-1094	131	GTA-KN44051	105
GTA-3838S32	93	GTA-80-1095	131	GTA-KN44061	106
GTA-3838S34	93	GTA-801544	104	GTA-KN44071	105
GTA-3838S36	93	GTA-801545	104	GTA-KN47001	107
GTA-3838S38	93	GTA-801546	104	GTA-KN47011	107
GTA-3838S40	93	GTA-8997598154	104	GTA-KN47081	107
GTA-3838S42	93	GTA-90054007	118	GTA-KN48031	106
GTA-3838S44	93	GTA-90054074	123	GTA-KN51000	107
GTA-3838S46	93	GTA-90054075	123	GTA-KN51010	106

Index

INDEX

Part No.	Page No.	Part No.	Page No.	Part No.	Page No.
GTA-KN55001	107	GTK-358-8709	137	GTK-83456	149
GTA-M7102	117	GTK-358-8713	142	GTK-85000	149
GTA-M7102-K	117	GTK-358-8729	141	GTK-85001	149
GTA-MK10	133	GTK-358-9039	137	GTK-85003	149
GTA-MK39	133	GTK-358-9069	137	GTK-85006	149
GTA-MK42	133	GTK-358-9082	138	GTK-85012	149
GTA-MK7	133	GTK-358-9101	138	GTK-85031	149
GTA-MK72	133	GTK-358-9122	138	GTK-85043	149
GTA-MK79	133	GTK-358-9265	138	GTK-85052	149
GTA-R801073	108	GTK-358-9270	139	GTK-85061	150
GTA-R801074	108	GTK-358-9293	139	GTK-85066	150
GTA-R955329	104	GTK-358-9321	139	GTK-85069	150
GTA-R955335	104	GTK-358-9371	139	GTK-85310	150
GTA-R955336	104	GTK-358-9373	142	GTK-85320	150
GTA-R955337	104	GTK-358-9422	140	GTK-85724	150
GTA-R955341	104	GTK-358-9580	140	GTK-85900	150
GTA-R955342	104	GTK-358-9648	140	GTK-85902	150
GTA-R955349	104	GTK-358-9780	140	GTK-85909	150
GTA-R955365	104	GTK-358-9781	141	GTK-85918	150
GTE-IMX1156	66	GTK-358-9807	142	GTK-85931	150
GTE-IMX1157	66	GTK-388	159	GTK-89408	150
GTE-IMX1889	66	GTK-406	159	GTK-89410	150
GTE-IMX1893	66	GTK-419	159	GTK-89423	150
GTE-IMX1895	66	GTK-456	159	GTK-89429	150
GTE-IMX194	66	GTK-80001-40	159	GTK-89451	150
GTE-IMX53	66	GTK-80001-45	159		
GTE-IMX57	66	GTK-80001-50	159		
GTE-IMX67	66	GTK-8010-30	159		
GTE-IMX89	66	GTK-8010-35	159		
GTE-IMX97	66	GTK-8010-40	159		
GTK-15018	158	GTK-8010-45	159		
GTK-15024	158	GTK-8010-50	159		
GTK-15036	158	GTK-8010-60	159		
GTK-15048	158	GTK-8020-30	159		
GTK-15060	158	GTK-8020-35	159		
GTK-16036	158	GTK-8020-40	159		
GTK-20015	160	GTK-8020-45	159		
GTK-225	159	GTK-8020-50	159		
GTK-275	159	GTK-8020-50SS	159		
GTK-306	159	GTK-8020-60	159		
GTK-344	159	GTK-83009	149		
GTK-356	159	GTK-83125	149		
GTK-358-6897	136	GTK-83128	149		
GTK-358-7206	141	GTK-83203	149		
GTK-358-7207	141	GTK-83207	149		
GTK-358-7400	136	GTK-83215	149		
GTK-358-8050	136	GTK-83312	149		
GTK-358-8091	136	GTK-83317	149		
GTK-358-8204	137	GTK-83318	149		

WARRANTY POLICY

GLOBETECH Manufacturing warrants its products to be free from manufacturing defects for a period of one year from date of shipment. Buyer's exclusive remedy and seller's sole liability hereunder shall be limited to refund of the purchase price or replacement of the product shown to be other than as warranted. Conditions resulting from misuse, negligence, alteration, accident, or improper installation, maintenance, or application shall absolve seller of all liability. The foregoing constitutes the sole warranty of GLOBETECH Manufacturing with respect to its products and in lieu of all other warranties, expressed or implied, including any implied warranties of merchantability or of the fitness for a particular purpose. In no event and under no circumstances, shall GLOBETECH Manufacturing be liable for consequential or special damages.

RETURN POLICY

GLOBETECH Manufacturing will allow one return per year, not to exceed 5% of the previous year's purchases. Custom-made products may not be returned. Each return is subject to a 15-20% restocking fee, AND requires an RGA number issued by GLOBETECH Manufacturing. Customers must pay freight on all returns, and package items in such a way that makes our RGA number clear and obvious. All products must be in excellent condition, suitable for resale. We reserve the right to refuse any and all requests for product returns, based on poor condition of product, or on obsolescence of a particular item or product line. Credit for returns shall be in the form of a credit to customers account for use against further purchase.





★
U
S
A
★



★
U
S
A
★



★
U
S
A
★

