

GO RHINO®

INSTALLATION INSTRUCTIONS

PART NO.

- 6844355

PRODUCT DESCRIPTION:

- OE Xtreme Bracket Kit

APPLICATION:

- TOYOTA TUNDRA
CREW MAX
- TOYOTA TUNDRA
DOUBLE CAB

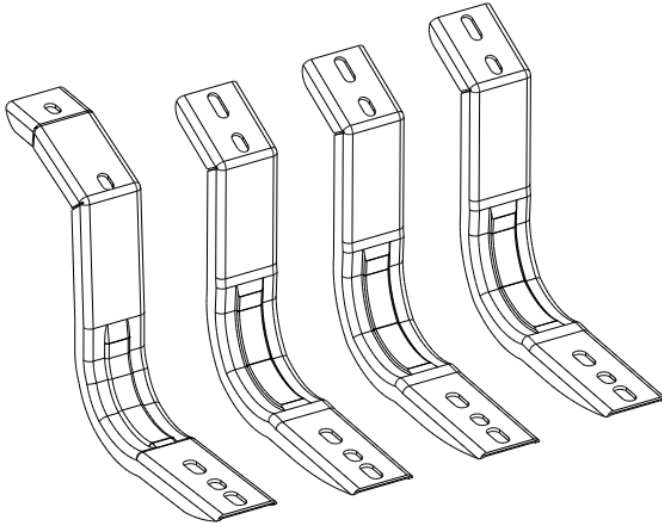

PRODUCT SAFETY & LEGAL DISCLAIMER

- **IMPORTANT READ ALL INSTRUCTIONS CAREFULLY BEFORE INSTALLING, FAILURE TO DO SO MAY CAUSE PERSONAL INJURY OR DAMAGE TO PRODUCT AND/OR PROPERTY.**
- **Review the product package and contents prior to beginning the installation.** Take care when opening the packaging and removing items. If a return is needed you will want to return the product in its original packaging if possible.
- This instruction guide is provided as a GENERAL installation guide, some vehicles vary dimensionally and may require additional steps.
- Test fit the product on the vehicle prior to any third party modifications and or finishing. The manufacturer and/or distributors do not accept responsibility for third party charges, labor and or third part replacement modifications. Some modifications may void the factory warranty.
- Exercise due-diligence when installing this product. The manufacturer and distributors of this product do not accept any responsibility for vehicle damage or personal injury resulting from the installation of this product. Careless installation and operation can result in serious injury or equipment damage.
- This product is for general off-road use. All liability for installation and use rests with the owner/operator.
- **INSTALLER:** Once installation is complete, please return this guide along with other documentation included in this product back to the consumer for future reference. The manufacturer/distributors of this product do not guarantee this particular version will be available at a later date.



INSTALLATION INSTRUCTIONS

INJURY HAZARD

Please complete a shop and tool inspection prior to beginning the installation.

- Always make sure you have a clean, dry and well lit work area.
- Always remove jewelry, loose fitting clothing and wear protective gloves and eye protection.
- Always use extreme caution when jacking or raising a vehicle for work. Set the emergency brake and use tire/wheel blocks and jack stands. Refer to the vehicle manufacturer hand book. Utilize the vehicle manufacturers designated lifting points.
- Always use appropriate and adequate care in lifting parts during disassembly and installation. Seek help in lifting heavy or large items into place. Utilize jacks and or lifting devices when available.
- Always insure products are secure during disassembly and installation.
- Always wear eye protection and take steps to protect any exposed skin during the installations. Drilling, cutting and grinding plastic and metal may create flying particles that can cause injury.
- Always use extreme caution when drilling, cutting and or grinding on a vehicle. Thoroughly inspect the area to be drilled, on both sides of material, prior to modification and relocate any objects that may become damaged.
- Always assemble and tighten all fasteners per the installation instructions.
- Always route electrical cables carefully. Avoid moving parts, parts that may become hot and rough or sharp edges.
- Always insulate and protect all exposed wiring and electrical connections.

MAINTENANCE AND CARE

- Always perform regular inspections and maintenance on mounts and related fasteners.
- Periodically check and tighten all fasteners.
- Stripped, fractured, or bent fasteners must be replaced.
- After washing the vehicle make sure to fully dry all surfaces.
- In areas with cold temperatures make sure to wash the product often to remove harmful materials used on road ways.
- Never use abrasive cleaners or polish compounds. Clean with a gentle soap and water. If you use wax use a non-abrasive automotive wax such as pure carnauba wax.

WARNING

Some products have been designed to work together with factory rear sensor systems, factory forward facing sensor systems and factory air bags.

- Installation of some of these products may alter the factory sensor system performance.
- Factory sensors may read shackles or hooks protruding from the fairlead and or tow hooks.
- All sensor testing is completed by Go Rhino Products and or third party testing labs on modified vehicles.
- Sensor sensitivity, factory sensor housing, orientation, and operating conditions are all variables that will influence functionality of the sensors.
- Installation of some product may effect the factory air bag systems.
- Some products allow the use of third party products such as winches, shackles, hooks, etc. Follow the respective manufacturers operating instructions for use with our products.
- Make sure to fully understand the product, it's intended use and operation prior to use.
- Above all... be safe!

GO RHINO®

INSTALLATION INSTRUCTIONS

PARTS INCLUDED IN THIS LIST:

ITEM	QTY.	DESCRIPTION	ITEM	QTY.	DESCRIPTION
A	16	M8 x 30 SEMS Bolts	D	1 pr	OE Xtreme U-Channel
B	1 pr	Front Bracket (driver shown)	E	1 pr	OE Xtreme II U-Channel
C	3 pr	Center/Rear Bracket (driver shown)	F	1 pr	OE Xtreme 5" U-Channel

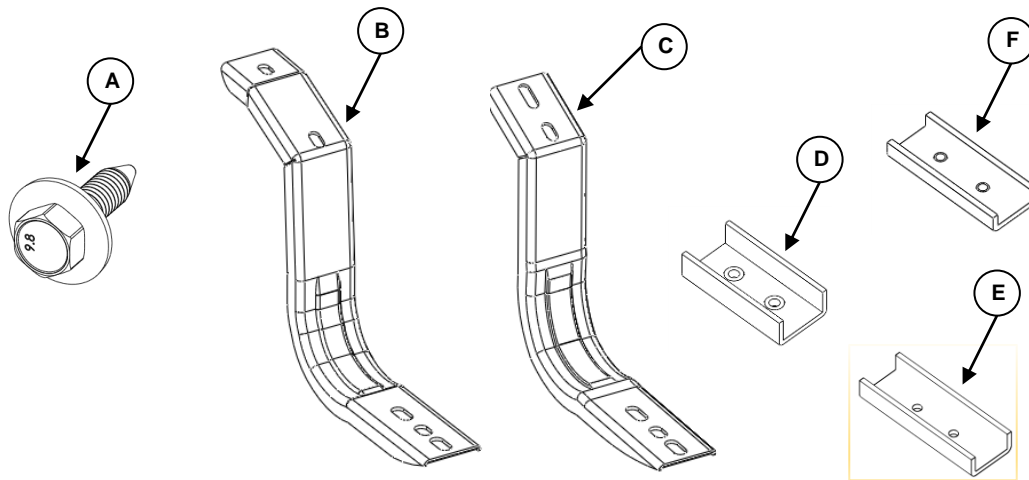

Go Rhino recommends you, the installer, read this installation instruction manual from front to back before installing the product.

TOOLS NEEDED FOR INSTALLATION:

- 13 mm Socket & Wrench
- 12mm Socket or Wrench
- Ratchet & Extension

ESTIMATED TIME FOR INSTALLATION:

1 Hour

GO RHINO®

INSTALLATION INSTRUCTIONS

Step-1 Begin the installation on the driver side, this installation uses (4) brackets per side. Starting at the front of the vehicle, locate and remove the (2) M8 factory bolts in the underside of the body panel, (FIGURE 1).

Step-2 Attach the driver side Front bracket to the underside of the body using (2) M8 x 30mm SEMS bolt, (1), (FIGURE 2). Leave the bolts loose for final adjustment.

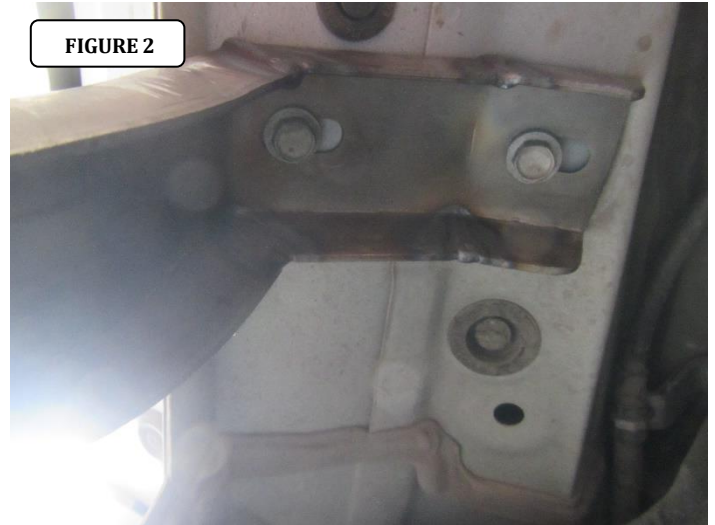
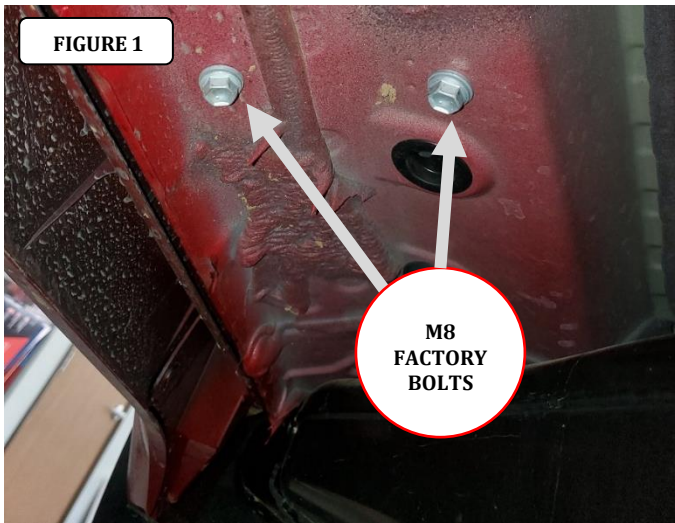

Step-3 Locate and remove the others (2) M8 factory bolts in the underside of the body panel, at the center and rear of the cab (FIGURE 3).

Step-4 Attach the remaining brackets to the underside of the body using (2) M8 x 30mm SEMS bolts by bracket, (1), (FIGURE 4). Leave the bolts loose for final adjustment.

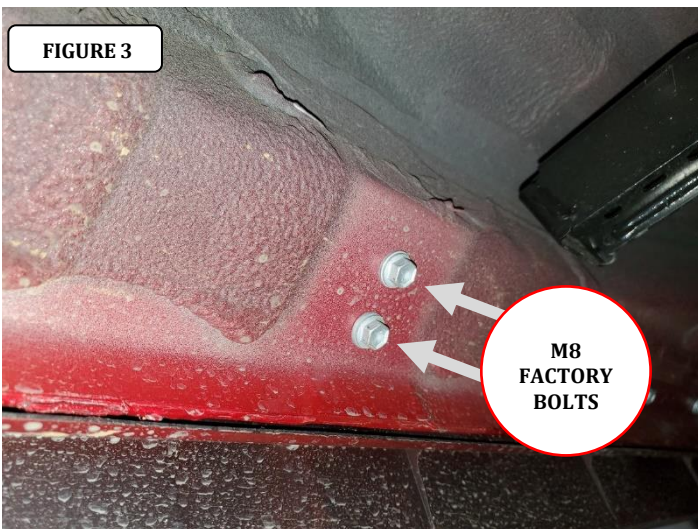

GO RHINO®

INSTALLATION INSTRUCTIONS

Step-5 Place the running board on the brackets. Follow the running board install instructions to attach the side step to the mounting brackets.

Step-6 Align the running board with the vehicle and tighten all bolts securing the running board to the front, center and rear brackets. Repeat the above steps to install the passenger side brackets and running board. Remember to check and retighten the nuts and bolts every six months.

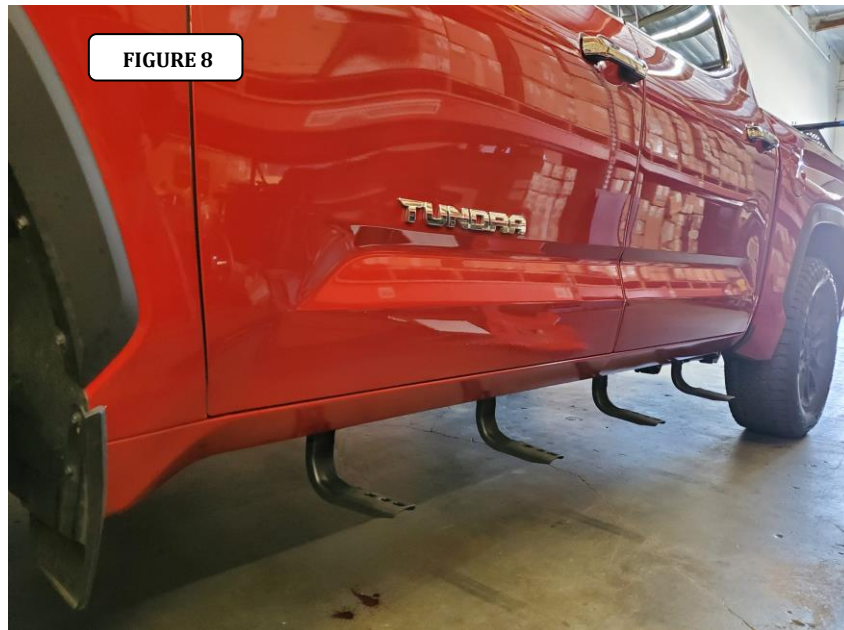

INSTALLATION INSTRUCTIONS

UNIVERSAL RUNNING BOARD

Parts List					
Item	Qty.	Code	Description	Max. Torque	
1	1 Set	-	Running Board	-	
2	6 Pc.	396804AA	U (Clamp) Bracket *	-	

* Wheel to Wheel Running Boards have the U (Clamp) Brackets included on the Bracket Kit (Sold Separately)

Required Tools (Not included)	
Qty.	Description
1	15mm Wrench
1	17mm Socket
1	Ratchet

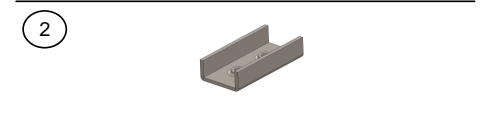
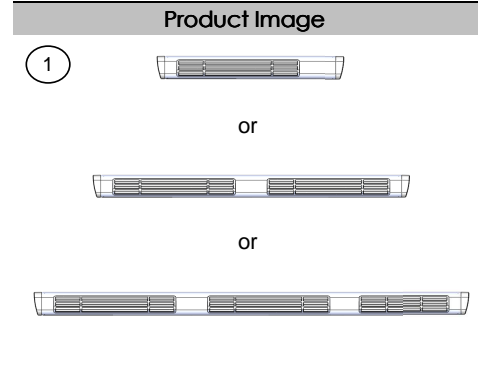

Instructions

1. Before beginning the installation, please read all directions carefully and verify that all necessary hardware is accounted for. If any parts are missing, stop the installation and contact your distributor immediately.
2. To maintain and care this product keep it clean and do not use abrasive cleaners or polish waxes. We recommend to use only non-abrasive automotive wax such as pure carnauba to avoid scratches and rust.
3. Once the main brackets are installed **(sold separately)**, the approximate installation time is **15 min.**
4. Place the U brackets inside the Running Board. Move them to align to the main brackets. **See illustration 1.**
5. Place the flat and lock washers with the square head bolts. This hardware kit is included on the main brackets that are **(sold separately)**. **See illustration 1.**
6. Align the Running board and tighten the bolts using a 1/2" wrench.
7. **NOTE: For some regular cabs only two U brackets are needed per side.**

ILLUSTRATION 1.

