

INSTALLATION INSTRUCTIONS

BRACKET	OVAL SIDE BAR WIDESIDER 4"	WHEEL TO WHEEL WIDESIDER 4"	RUNNING BOARD WIDESIDER 5" & 6"	APPLICATION	MODEL
684429	64429 67429	-	39087	TOYOTA TACOMA DOUBLE CAB.	05 - 12

Parts List:

Item	Qty	Description	Max Torque
1	2	391884AB Front driver and passenger Bracket.	
2	4	391884BB Mid and Rear, driver and passenger bracket.	
1 KTE-392895 Hardware Kit:			
3	12	5/16x15/16" Black Square head bolt	-
4	12	5/16" Black Nut	11 Lb/Ft
5	12	5/16" Black Flat Washer	-
6	12	5/16" Black Lock Washer	-
7	12	M8x25 Zinc Plate hex head bolt	11 Lb/Ft
8	12	5/16" Zinc plate flat washer	-
9	12	5/16" Zinc plate Lock washer	-
NOTE: 64429-67429 (B-PS) INCLUDES:			
10	1	Oval 4" Widesider bar set	-

Tools required not including:

Description	Qty
Ratchet	1
12mm Socket	1
13mm Socket	1
5" Extension ratchet	1
15mm. Wrench	1

Img. 1

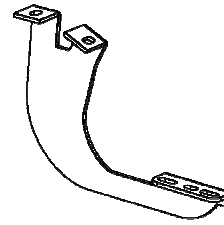

Front driver and passenger bracket

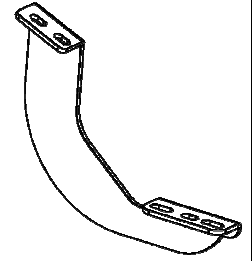

Mid and Rear, driver and passenger Bracket

Instructions:

Approximated installation time: 30 min.

Img. 2

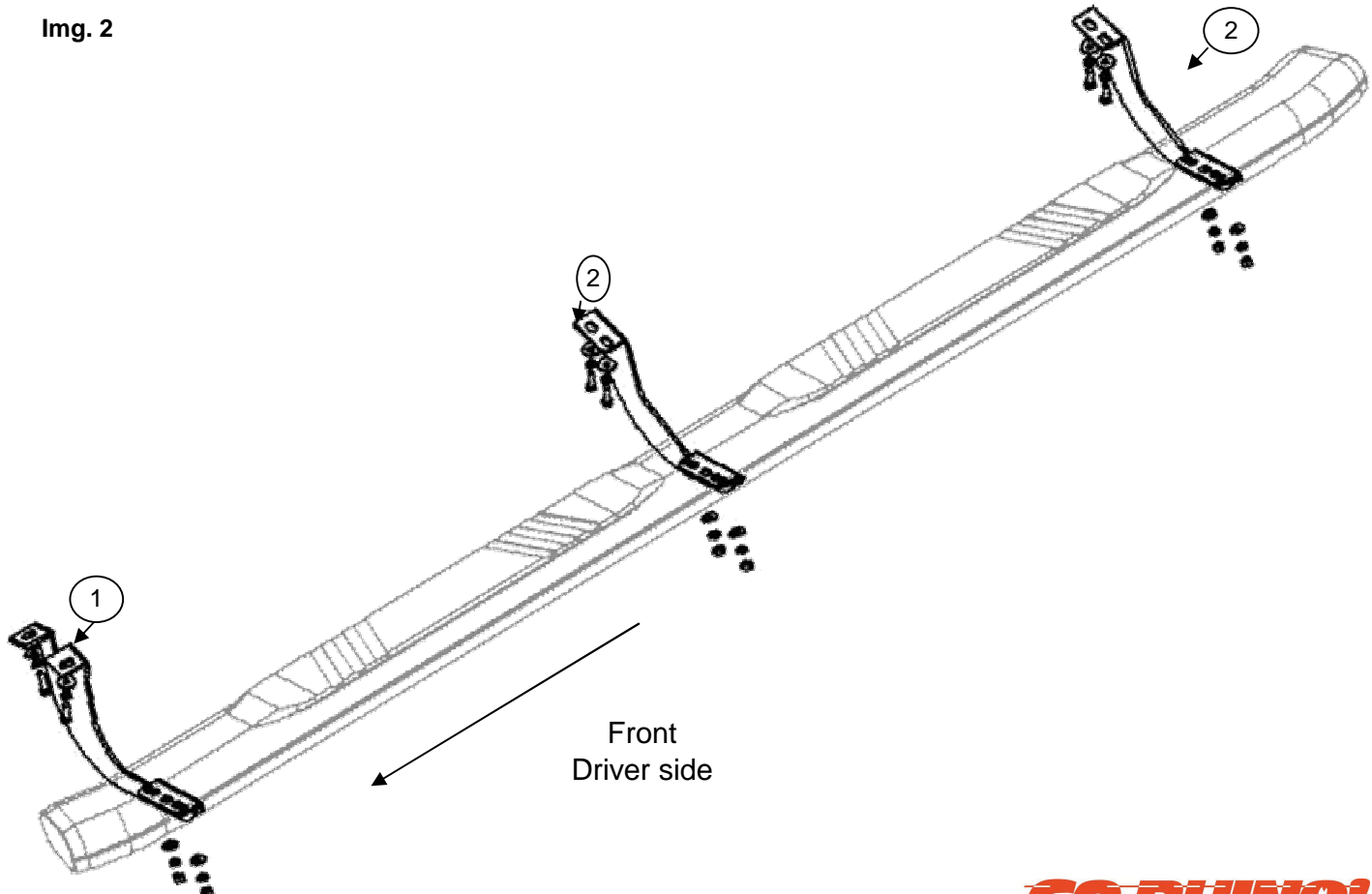

INSTALLATION INSTRUCTIONS

1. Before beginning the installation read all instructions carefully and verify that all hardware is accounted for. if there are any listed parts missing, please notify your distributor immediately.
2. See pictures 3, 3a y 3b and locate the holes where the brackets are going to be installed.

Pict. 3

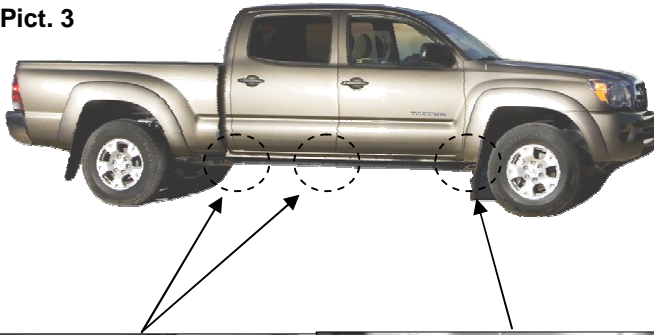

Pict. 3a

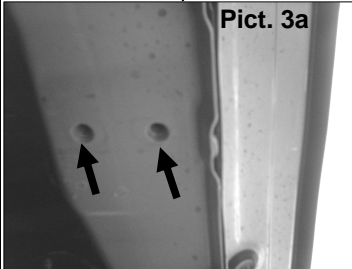

Pict. 3b

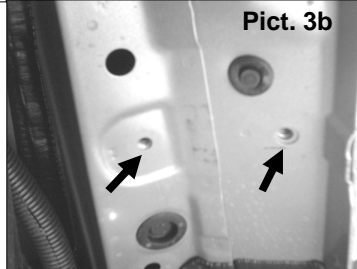

3. For the **Front bracket** install two M8x25 hex head galvanized bolts, two flat washers and two lock washers. See **Picture 4** and repeat it in the opposite side of the vehicle. Leave loose.

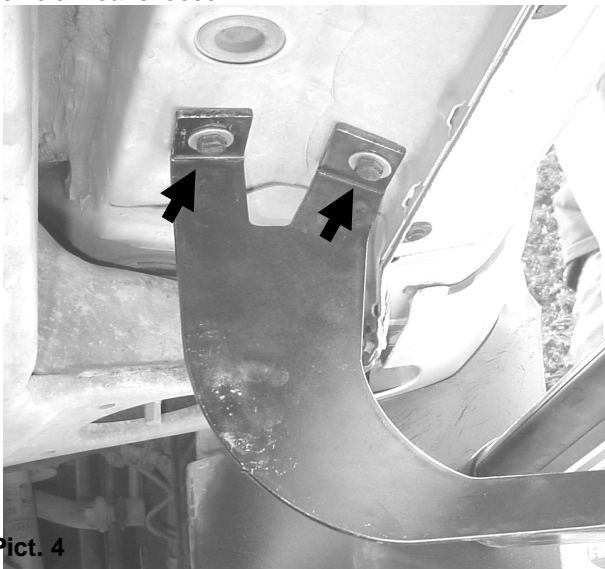

Pict. 4

4. To install **middle and rear brackets** use two M8x30 hex head galvanized bolts, two flat washers and two lock washer for each bracket. See **Picture 5** and repeat it in the opposite side. Leave loose.



Pict. 5

5. Now Proceed to install the running board / sidebar (Sold separately)
6. To install the Running Board, place three square head per each channel that it's located on the bottom (discard middle channel) Refer to **Picture 7**.

Pict. 7

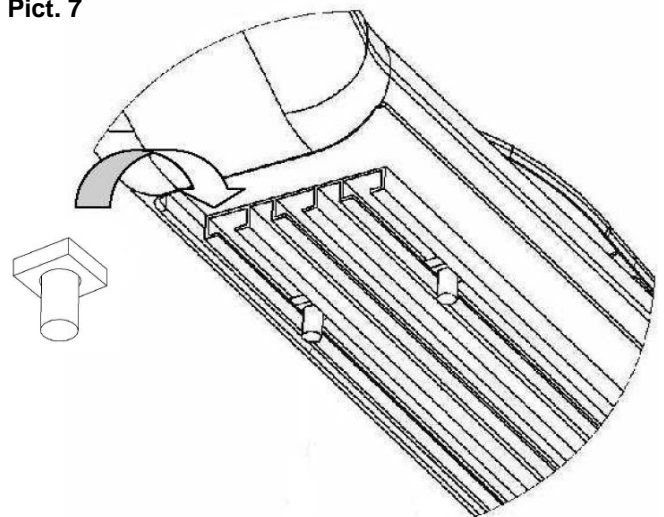

INSTALLATION INSTRUCTIONS

7. Place the Running Board above the brackets attach it with six 5/16" nuts, six flat washers and six lock washers, per side all in black color. See **Picture 8** and repeat in the opposite side. Leave loose.



8. If you are going to Install an oval sidebar use two flat washers, two lock washers and two 5/16" nuts per bracket (all hardware in black). See **Picture 9** and repeat in the opposite side. **Leave loose.**

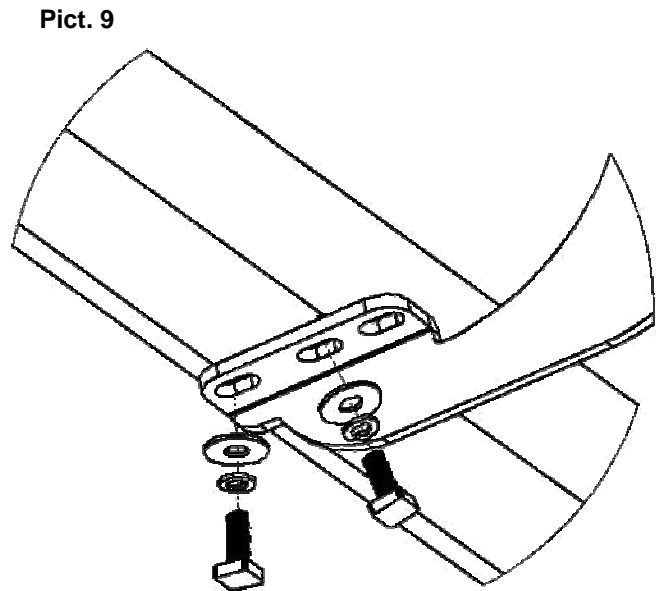

9. Align Side bar, and then get tighten all bolts.

10. Do not use abrasive substances to clean your product.

11. Periodically check your product because it may need a re-tighten of bolts.

12. **Fill the warranty card and place it inside your vehicle's glove box.**

INSTALLATION INSTRUCTIONS

UNIVERSAL RUNNING BOARD

Parts List				
Item	Qty.	Code	Description	Max. Torque
1	1 Set	-	Running Board	-
2	6 Pc.	396804AA	U (Clamp) Bracket *	-

* Wheel to Wheel Running Boards have the U (Clamp) Brackets included on the Bracket Kit (Sold Separately)

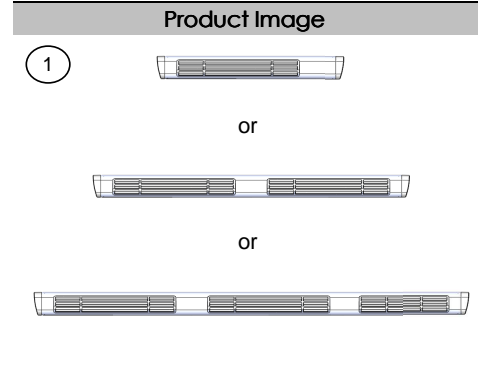

Required Tools (Not included)	
Qty.	Description
1	15mm Wrench
1	17mm Socket
1	Ratchet

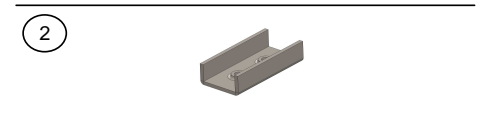

Instructions

1. Before beginning the installation, please read all directions carefully and verify that all necessary hardware is accounted for. If any parts are missing, stop the installation and contact your distributor immediately.
2. To maintain and care this product keep it clean and do not use abrasive cleaners or polish waxes. We recommend to use only non-abrasive automotive wax such as pure carnauba to avoid scratches and rust.
3. Once the main brackets are installed **(sold separately)**, the approximate installation time is **15 min.**
4. Place the U brackets inside the Running Board. Move them to align to the main brackets. **See illustration 1.**
5. Place the flat and lock washers with the square head bolts. This hardware kit is included on the main brackets that are **(sold separately)**. **See illustration 1.**
6. Align the Running board and tighten the bolts using a 1/2" wrench.
7. **NOTE: For some regular cabs only two U brackets are needed per side.**

ILLUSTRATION 1.

