

Installation Guide

L31195

06/07

Automatic Brake Adjuster Installation Instructions AA1 Model and S-ABA Model

ABA - IDENTIFICATION

Two versions of brake adjusters are available from Haldex. The easiest way to identify each is by the shape of the cover plate assembly, as shown below in Figures 1 and 2.

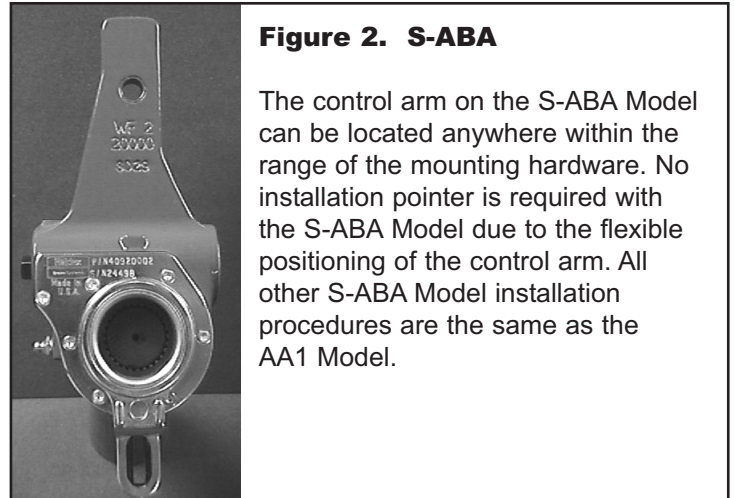
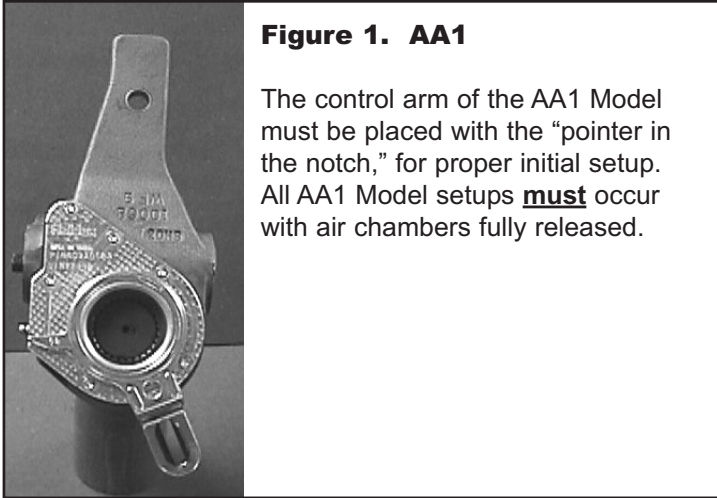

ABA - TYPICAL APPLICATIONS

Figures 3 and 4 show typical brackets for automatic brake adjuster applications on trailer axle brake assemblies.

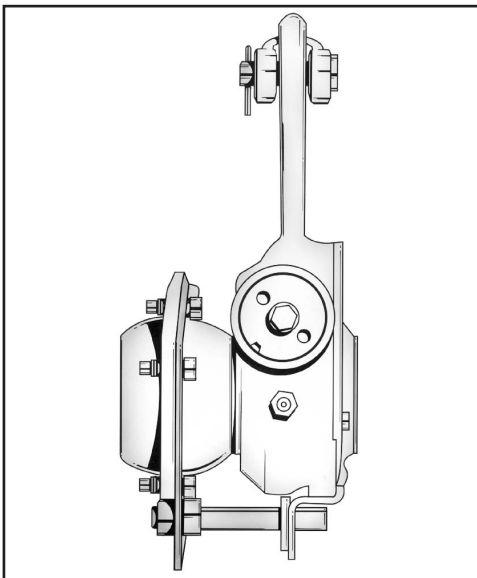

Figure 3.

Integral cam support anchor bracket for 12 1/4" and 16 1/2" brakes.

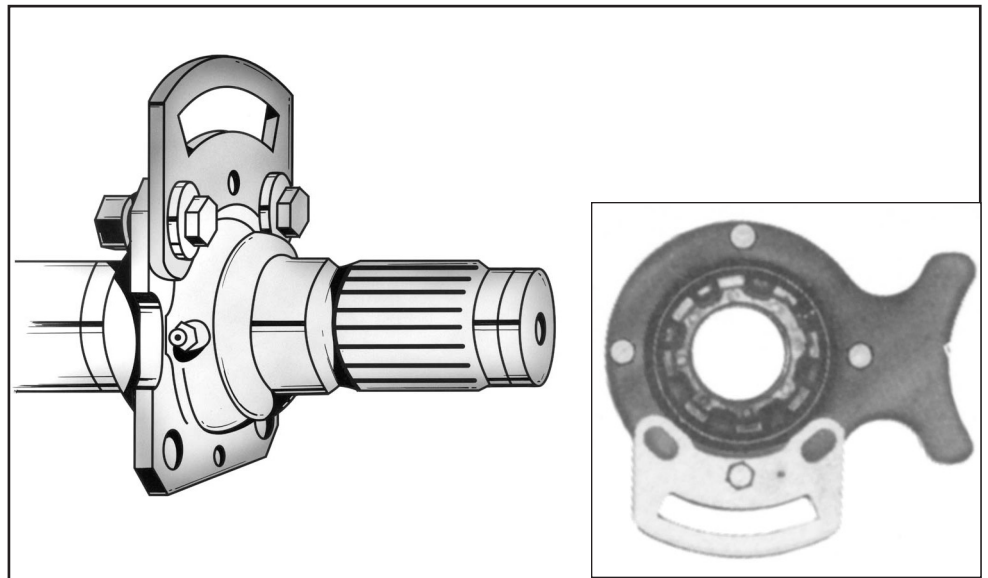

Figure 4.

Bolt-on cam support anchor bracket for 12 1/4" and 16 1/2" brakes. Slotted adjustment plate is mounted to the “S” cam bushing. Plate for Rockwell/Meritor, Dana and Fruehauf axle requires two bolts. Eaton requires one bolt (see inset). Position plate on adjuster side of the “S” cam support. Added plate thickness may require the use of longer mounting bolts. (Refer to torque chart included in these instructions.)

ABA - INSTALLATION INSTRUCTIONS

STEP 1.

Assure brake chamber push rods are fully retracted. Mount slotted adjustment plate, if needed, to cam support. Apply anti-seize type lubricant to camshaft splines. Torque anchor plate fasteners per torque chart included in these instructions.

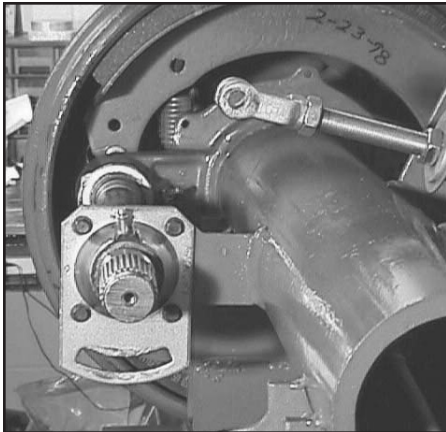

STEP 2.

Place at least one inner cam washer on shaft then install adjuster with the 7/16" adjusting hex pointing **away from** the air chamber.

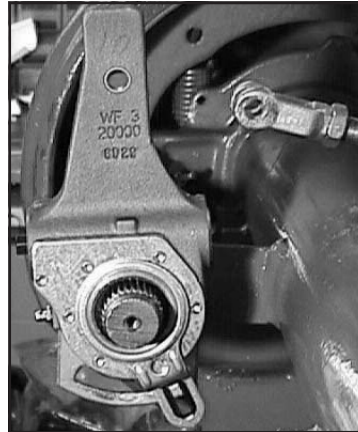

STEP 3. Secure adjuster to shaft with snap ring. Install enough washers (per TMC recommended practice) to reduce end play to less than .060".

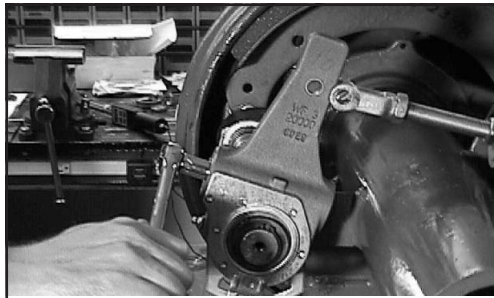

STEP 4. Rotate the 7/16" hex clockwise to move adjuster into clevis. (Do not pull push rod out to meet clevis).

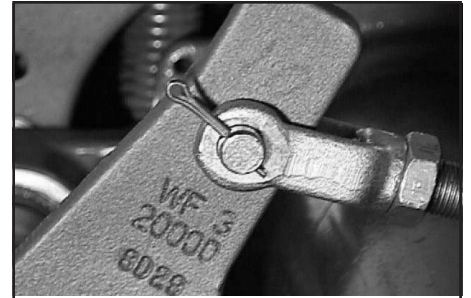

STEP 5. Coat clevis pin with anti-seize type lubricant and install. Secure clevis pin with cotter pin.

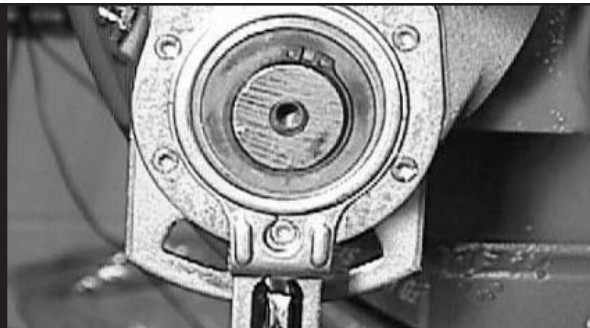
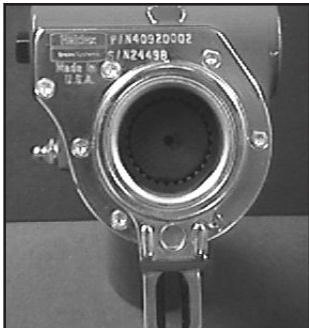

STEP 6A. With the S-ABA Model Brake Adjuster (shown in Figure 2), the control arm position can be set anywhere within the slotted area of the bracket and the adjuster will function properly. Haldex recommends a "common position" for all installations – all the way towards the axle, until the control arm comes to the end of the slotted bracket. This "common position" should help to avoid confusion for the end user.

STEP 6B. With the AA1 Model Brake Adjuster (Figure 1), rotate the control arm away from adjustment hex, toward the air chamber until it comes to an internal stop. The "Installation Indicator" must fall within the slotted area with the brake fully released. The view of the indicator varies from side to side. Haldex AA1 Trailer Adjusters are unhandled and are used on both axle sides.

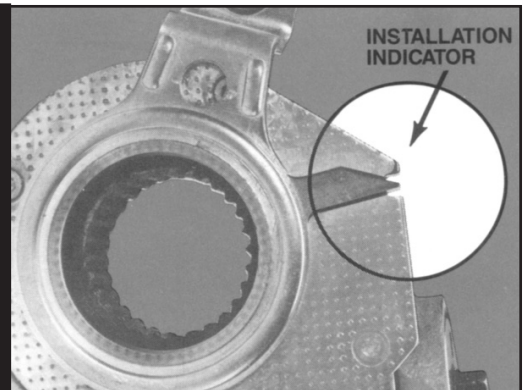
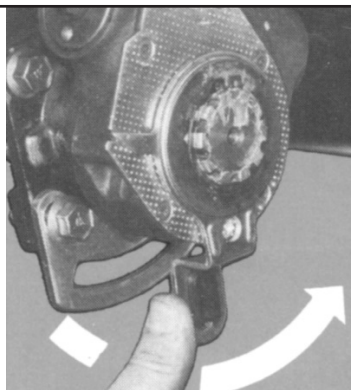

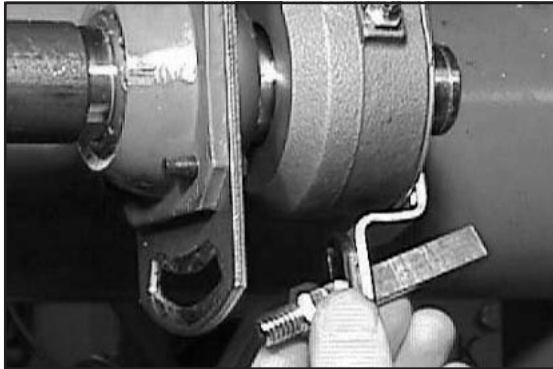

STEP 7.

Insert the flat end of the anchor stud through the control arm bushing. Push the threaded end into the anchor plate slot and loosely install flange nut.

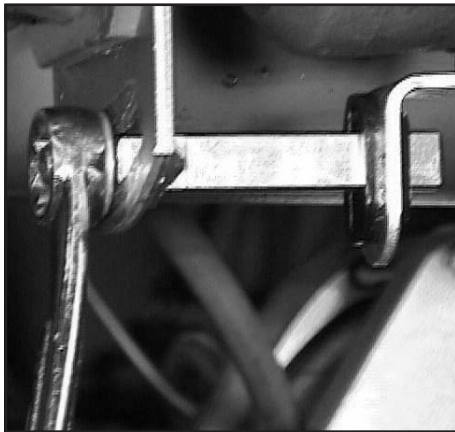
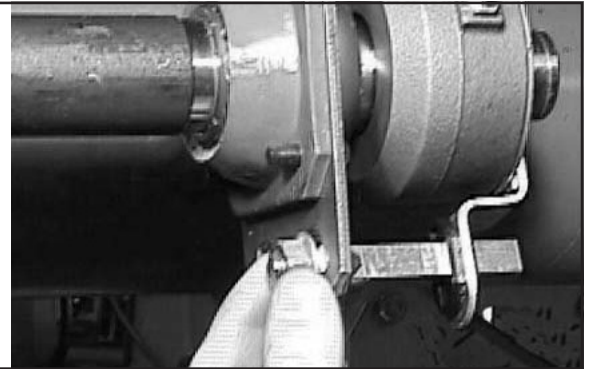

STEP 8. After positioning control arm and anchor pin to desired location, tighten the flange nut to 40-50 ft. lbs.

Note: S-ABA control arm position is all the way toward the axle. AA1 control arm position is such that the installation indicator falls within the control cover slot. These common positions work well for most applications.

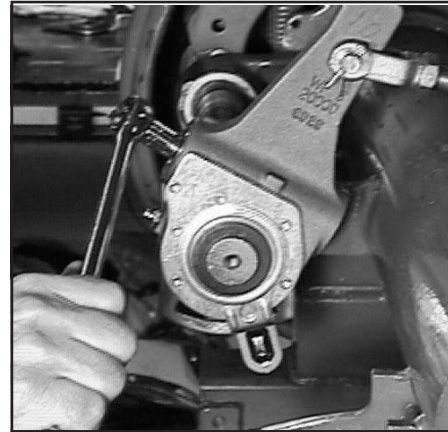

STEP 9. Adjust brakes by rotating the 7/16" adjustment hex clockwise until the lining just contacts the drum.

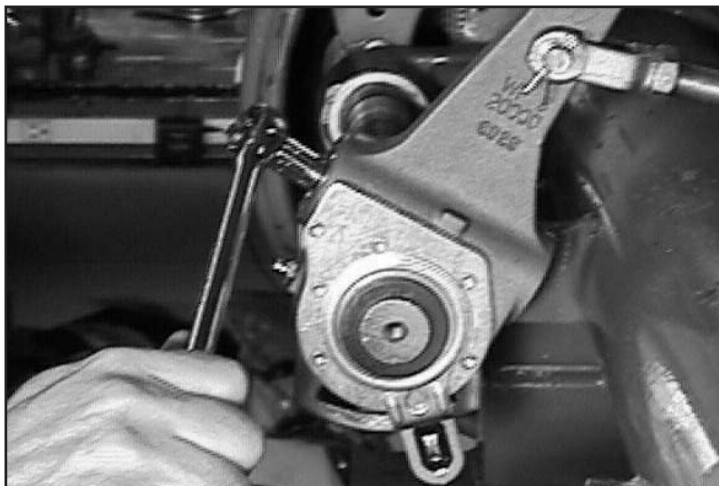

Parts List

- 23/8" x 1-1/4" Long Bolt (Meritor)
- 15/16" x 1" Long Bolt (Fruehauf)
- 13/8" x 1-1/4" Long Bolt (Fruehauf)
- 21/4" x 1-1/4" Long Bolt (Dana)
- 21/4" Flat Washer (Dana)
- 11/4" x 1-1/4" Long Bolt (Eaton)

Torque Chart

- 3/8" - 1620-25 ft. lbs.
- 5/16" - 1810-15 ft. lbs.
- 1/4" - 205-7 ft. lbs.

STEP 10. Rotate adjustment hex counter clockwise 1/2 turn. A ratcheting sound will occur on backoff. This is normal. Recheck all fasteners for proper installation. Note: Final push rod stroke may not be reached until trailer is put into service and the brakes are burnished.

Warning: Haldex strongly recommends routine visual checks be performed at EACH maintenance service interval. Foundation brake operational checks utilizing CVSA level 1 applied stroke criteria should always be utilized. Manual adjustment of automatic adjusters can disguise hidden problems within the foundation brake. Brake components such as s-cams, bushings, return springs, actuators, drums and adjuster installation MUST be within manufacturer's specifications. Adjuster control arms, wear bushings or attaching hardware that demonstrate visual damage, or which fail the operational checks, MUST be replaced immediately. Automatic Adjusters should NEVER be operated as manual adjusters except as may be necessary to get the vehicle off the road for service.

