

Hella auxiliary headlights:

Vehicle installation



**Ideas today for
the cars of tomorrow**

Installation of auxiliary headlights

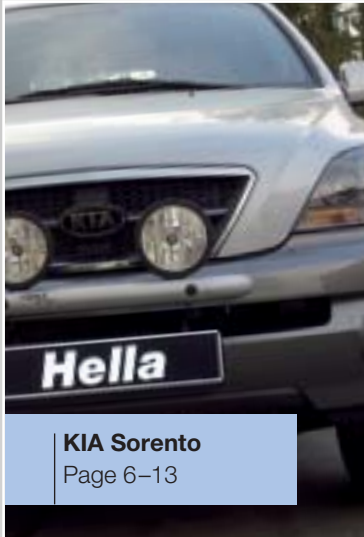

KIA Sorento
Page 6–13

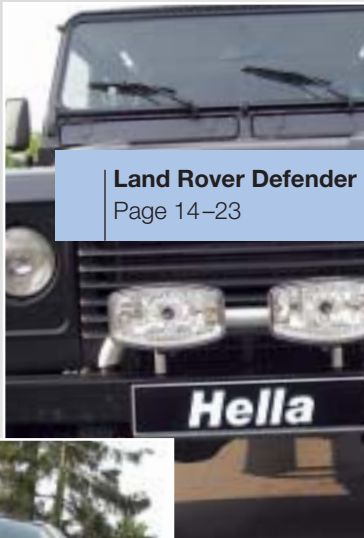

Land Rover Defender
Page 14–23



Nissan Qashqai
Page 24–31



VW Tiguan
Page 32–41

Auxiliary headlights for driving and fog applications are a meaningful supplement to the existing lighting equipment. The styled frontal areas and bumpers of modern SUVs and off-road vehicles make the attachment of auxiliary headlights a real challenge. In some cases, professional installation without additional brackets is almost impossible, which often puts potential customers off. A few important points must be heeded during the electrical connection of headlight systems too, to guarantee their perfect function for years to come.

This brochure provides a host of information, via step-by-step texts and photos, about installing auxiliary headlights with the aid of vehicle-specific and universal attachment systems. Valuable practical tips and advice will help you with the installation of auxiliary headlights.

The illustrations and step-by-step details are a demonstration of mounting possibilities. Please observe national legislation when mounting and using the brackets and headlights.

How can the headlights be attached to the vehicle?

On today's vehicles, the visible frontal area is usually made of lightweight plastic composite parts. Their main tasks range from optical design through pedestrian protection to aerodynamics. The installation of auxiliary headlights is certainly not one of them. The days when wide, chrome-plated bumpers „decorated“ vehicle front-ends are long gone. And with them the straightforward possibility of installing auxiliary headlights. This is a problem that concerns interested off-road drivers in particular. For this reason, garages often face the challenge of how best to attach the auxiliary headlights to the vehicle. The answer is: using professional light brackets. These are available in different shapes, surface finishes and made of various materials. They are available both as universal and vehicle-specific types. Customers interested in purchasing such light brackets should always make sure they have been approved by the legislator, however, since requirements have been significantly tightened, particularly in terms of pedestrian protection.



Light bracket sets

For the attachment examples shown in this brochure we used the „Q-light“ light bracket series made by the Swedish company QPAX. The brackets are made of aluminium and have an anodised finish. In addition, this bracket series complies with European guidelines and is supplied in two different versions:

Universal light bracket

This attachment set is made up of one light bracket, two spacer sleeves and various mounting parts such as screws, washers etc.. A general installation manual is also supplied as part of the set.

Vehicle-specific light brackets

These bracket sets have been adapted in form and attachment position to suit specific vehicles. This includes the spacer sleeves and the other mounting parts, plus the installation manual. This is particularly advantageous when determining the attachment position and position of the drill holes. All the necessary dimensions and drill hole diameters are available. Various working steps are also explained. However, the installation instructions do not claim to be complete!

General note

Careful preparation is required before commencing the installation of additional headlights or lights. The following details must be checked first:

Can the headlight be attached without additional installation material (light bracket etc.)?

- If not, what else do I need?
- What is behind the front apron?
- Are there any solid metal parts the headlights could be mounted to?
- Are there any hoses, pipes, radiators or other components installed that could make installation more difficult or even impossible?
- What is attachment and installation situation for Xenon headlights like? Is there a suitable space available for the ballast units?
- What is required for electrical connection (relays etc.) of the headlights?
- Do any special points have to be remembered when connecting up to the vehicle electronics?

If a garage has had no experience with any particular vehicle, it makes good sense to have a closer look at the vehicle and remove the front apron if necessary. This allows possible problems to be anticipated in advance. It also allows the work required to be estimated much more accurately, so that realistic quotes can be made to customers. Because if experience has shown us one thing it's that a day can pass in no time!

Practical tip

With some vehicles, installing the ballasts near the headlight may present a problem e.g. excessive exposure to water/splashing. With 4th generation ballasts (see photo), the supply cable from the ballast to the headlight is a metre long and thus covers the majority of attachment situations. If this should not be sufficient, however, there is also a three metre supply cable available, this can be ordered under the part number 8KB 990 299-251. This should be long enough to install the ballast units in the interior or in a splashwater-proof area – if required.



Additional installation material

In the case of light bracket mounting, it must be assumed that further material in the form of cable ties, washers etc. is required. Below is a short list of some of the materials that were used during installation:

Ring groove nut



Due to the shapes of some vehicle profiles it is not possible to set up a screw-type connection, since the nut cannot be screwed onto the screw thread in the profile. The screw thread is quite simply out of reach. Ring rivet nuts are a very good alternative solution in such cases (see photo).

First, a hole of the required size is drilled in the profile. Then the ring groove nut is inserted and pressed in place. These nuts are available in different sizes and in a set with the appropriate installation tool. They are easy to use and quickly installed.



Threaded rods

If a screw connection has to be set up over a longer distance, these threaded rods can be used. They simply have to be cut to the correct length, are already being supplied as a set and are easy to purchase.



Rubber seal

Due to the shape of some cross members behind the front aprons, the spacer sleeves face outwards after tightening, rather than being parallel to the vehicle axis. Mounting the light bracket would be impossible in this position. The use of thicker rubber seals from the sanitary market allows the „slant“ of the spacer sleeves to be compensated for.

Crimp-shrink connectors

When electrical connections are to be made by means of a crimp connector, we always recommend the use of shrink connectors on the outside.

They are absolutely vital in the splashwater area. The nylon sheathing shrinks, producing a watertight connection and thus guaranteeing perfect contact.

Attachment of auxiliary spotlights to a Kia Sorento



Before



After



A universal attachment set is used for this installation. For this reason, the set includes different attachment and mounting parts that have to be adapted to the respective vehicle involved. The installation manual contains basic working steps, dimensions and drilling diameters.

Due to the situation with the Sorento, the following additional materials must be procured:

1. Since „normal“ mounting with stop nuts is not possible, the 8 mm screws are replaced by two 6 mm threaded rods which are at least 250 mm long.
2. An aluminium tube, 600 mm long, with an interior diameter of min. 6.5 mm and an outer diameter of max. 8 mm. The matching small tubes can be see in the photos. These are pushed into the spacer sleeves to compensate the smaller diameter of the threaded rods compared to the 8 mm screws in the set. This prevents the spacer sleeves slipping during mounting of the light bracket.
3. As already mentioned in the section „Additional installation material“, it is not possible to attach the threaded rods using stop nuts on account of the cross member profile. For this reason, two 6 mm ring groove nuts and two body washers are used.



Attachment is explained step-by-step below:

1 Unscrew and remove the expanding rivets (x 16) on the lock plate trim.



2 Remove the headlights. To do this, remove the three attachment screws and pull the headlights to the front and out of the body. Disconnect the plug-type connection for the low beam, high beam and position light.



3 Particularly when using a universal light bracket, it is important to establish in advance exactly where this can be mounted to the body front. Quite often, a potentially suitable space on the front apron cannot be used because there is no solid metal part available behind the apron for attachment of the light bracket in this position. With many vehicles, the cross member (see photo) provides the best solution. This means the front apron has to be removed to determine where the drill holes have to be made.



Kia Sorento

4 Loosen the expanding rivets (x 2) and take the trim off.

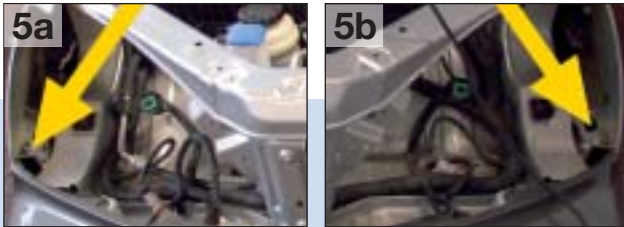

5 Loosen and remove the expanding rivets (x 14) on the front apron. Remove the attachment nuts in the wings (arrows).



6 Remove the screws (x 2) above the licence plate.



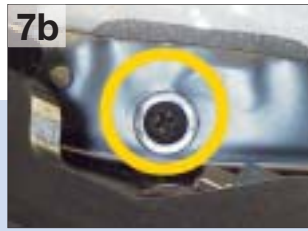

7 Loosen the expanding rivets on the front of the wheel housing trims so that these can be pulled away sufficiently to reach the screws on the underside of the wing. Remove the screws.

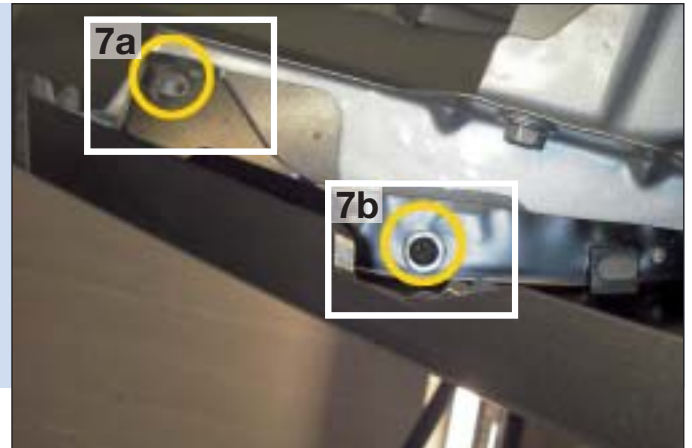

8 Remove the covers from the nozzles of the headlight cleaning system. To do this, pull the nozzles upwards by hand and use a screwdriver to release the cover cap.



9 Take the front apron off and loosen the plug-type connection for the fog lights.

10 Measure and mark the drill holes on the cross member. Then „insert“ the front apron loosely on the vehicle again. Transfer the drilling positions to the front apron. First, pre-drill the holes using a 5 mm drill and then expand them using a bore cutter so that spacer sleeves fit through.



Kia Sorento

11 Remove the front apron again. Use a 4 mm drill to pre-drill holes for the ring groove nuts, expand the holes to a suitable size for the diameter of the nuts and seal them with rust protection.



12 Use both body washers to make sure the contact surface of the ring groove nuts is flat (see Fig. 12a). Insert the nuts in the drill holes and mount according to instructions.



13 „Insert“ the front apron on the vehicle again.



14 The spacer sleeves and aluminium tubes must be adapted in length in such a way that a space of about 10 mm remains between the light bracket and the front apron after mounting.

Note! During fitting, take the thickness of the plastic washers into account. Then remove burr from the „intersection“ and sand it flat (using a file or a belt sander).



15 Now cut the threaded rods to the right length, too. To do this, screw the rods about 15 mm into the ring groove nuts. Push the prepared spacer sleeves, aluminium tubes and light bracket onto the threaded rods. Use nuts to tighten the light bracket slightly. Shorten the threaded rods as shown in the photo. We recommend removing the rods again for this working step. Remove the front apron again.



16 Due to the space situation in the engine compartment, the Xenon ballast units are attached to the underbody protection. To do this proceed as follows:

- Remove the underbody protection
- Mark drill holes, drill them using a 4 mm drill and seal with rust protection (see Fig. 16a).
- Fasten the underbody protection back into place.
- Attach the ballast units using Parker screws (see Fig. 16b).



17 Re-fit all the parts that have been removed back on the vehicle. Fasten light brackets with stop nuts as the final mounting step.

Kia Sorento

18 Mount the auxiliary headlights onto the brackets according to the Hella instructions.

19 Route the headlight cable through the front apron to the ballast units and use cable ties to fix it in place at suitable points on the body.

20 In this case, Luminator Compact Xenon are installed. There is a pre-assembled harness included with every headlight. Determine a suitable spot on each side of the engine compartment to mount the relays (depending on the engine type). Mount the relays in a position protected from splashwater and with the contacts facing downwards. Route the cable according to the circuit diagram, fix in place using cable ties and connect up. Take the switching current (terminal 56a, high beam) for the relay from the central plugs on the headlights using incision connectors or butt joints. Then wind insulating tape around the connection points.



Driver side: Yellow cable
Passenger side: Yellow cable

21 Test headlight function.

22 Adjust the headlights using a beamsetter and tighten the screws. Tighten the nuts on the light brackets again and use the black caps to seal the openings.



Attachment of auxiliary spotlights to a Land Rover Defender 110



Before



After



A universal attachment set is used for this installation. For this reason, the set includes different attachment and mounting parts that have to be adapted to the specific vehicle involved. The installation manual contains basic working steps, dimensions and drilling diameters.

In the case of the Land Rover Defender, the light bracket can be attached directly to the solid bumper, which makes the mechanical installation much easier.

Since two headlights with a reference number of 37.5 each are used here, they have to be switched on using a separate switch, since the vehicle's own high beam is to remain active. For this reason, the electrical connection for this vehicle is described in more detail. A switch (6EG 001 567-112), installation material (shrink connectors, ring connectors etc.) and additional cable material are required for the electrical connection.

Attachment is explained step-by-step below:

1 With this vehicle, the light bracket is not attached in front of the front apron, but to the top of the bumper instead. Mark the drill holes for the light bracket on the bumper – according to the specification in the installation manual. The holes already present will help with alignment to the centre. Then pre-drill the holes using a 3 mm drill and widen them using an 8.5 mm drill. Seal the drill holes using rust protection.



2 Fix the attachment height of the light bracket. In this case, the spacer sleeves are shortened to 40 mm. Then remove burr from the „intersection“ and sand it flat (using a file or a belt sander).

3 Attach the light bracket to the bumper according to the instructions (see Fig. 3a). Make sure the individual components are aligned optimally to one another (see Fig. 3b).



Land Rover Defender

4 Assemble the headlight according to the instructions, attach it to the light bracket and carry out rough alignment.
Jumbo 320 Xenon are being installed on this vehicle. There is a pre-assembled harness included with every headlight.

5 Find a suitable spot for the ballast units. In this case, the bumper is ideal due to its dimensions.

6 To mark the drill holes, simply hold the ballast unit on the bumper from below.



7 Drill holes (4.5 mm) and seal them with rust protection.

8 Fix the two ballast units using the screws (M4) included as part of the kit.



9 Route the headlight cables to the ballast units and connect up.

10 As already explained, there is a pre-assembled harness included with every headlight. Find a suitable spot to mount the relay. In the case of the Defender, the existing screw attachment points on the right and left of the engine compartment can be used. Mount the relays protected from splashwater and with the contacts facing downwards.



11 Carry out electrical connection as follows:
The driver seat has to be removed for access to the battery. To do this, unscrew the screws (x 4) on the seat rails. Loosen and remove the covers on the battery compartment.

Land Rover Defender



12 Pull the red cables (load current, terminal 30) off the relays. Then push the cables through the rubber seal into the propeller shaft tunnel (see Fig. 12a). Fig. 12b shows the feed through in the propeller shaft tunnel.



13 Route the cables forwards to the relays and use cable ties to fix them to existing lines on the underbody. The cables have to be extended due to the distance. This can be done quickly using shrink connectors, however. Shrink tubes or Bouchier tubes should be used to better protect the cables from outer influences. Connect the cables to the relays again.

14 Route the voltage supply cables for the ballast units to the relays. The cables can be pushed up easily when fixed to welding wire. The radiator grille can also be removed to make mounting easier. Use cable ties to fix the cable at suitable points.



15 Collect the cables and lines in loops together on the ballast units and fix them in place using cable ties.



16 The voltage supply for the LED position light in the headlights is taken from the vehicle's position lights. To do this, unscrew the headlight trims as well as the indicator and position light. Please note: European guideline no. 48 specifies that in the attachment position for the auxiliary headlight shown, the position light must not be operated. This must always be heeded.



17 Connect the LED position light using incision connectors or butt joints.

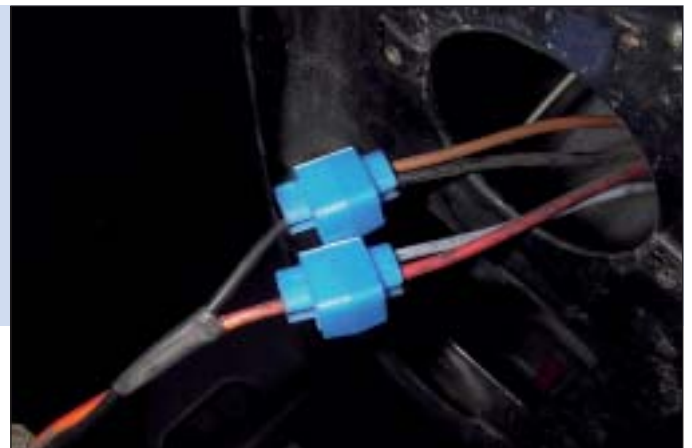

Land Rover Defender

18 With this vehicle, the circuitry has been chosen in such a way that the auxiliary spotlights can only be activated with the low beam light switched on. For the separate switch in the cockpit, the switching current is tapped from the triple plug for the H4 bulb.

19 The lower steering column trim has to be removed for installation of the switch. Loosen the cross-slot screws (x 7) and remove the trim. A suitable hole for the switch is already available in the steering column trim.

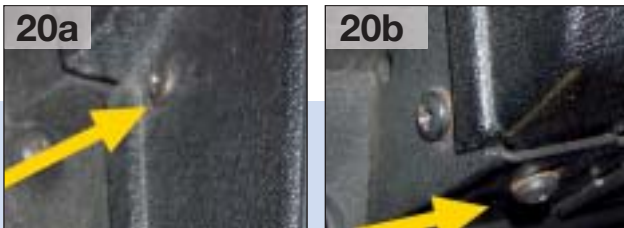

20 To feed the cable through, the dashboard must be pulled off slightly. To do this, unscrew the attachment screws (x 4) on the left and right of the dashboard.

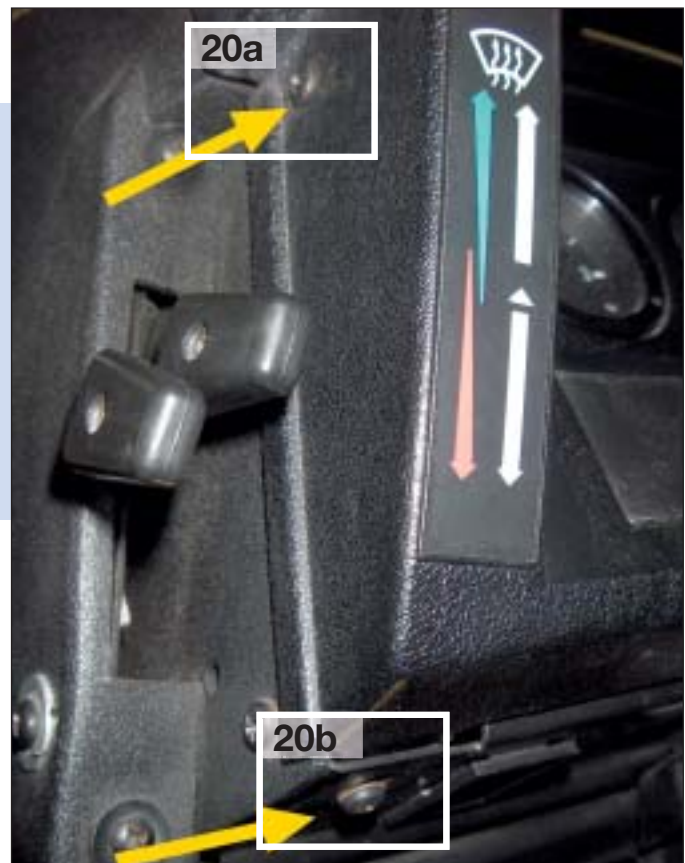

21 Route all the relevant cables for the separate switch (terminals: 56b, 31 and two x 86) to the interior with the aid of welding wire. Penetrate the rubber seal to do this. Since there is no suitable ground point within the dashboard, a ground cable also has to be laid.

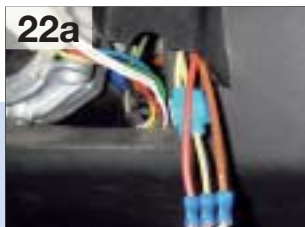

22 Fit 6.3 mm crimp connectors to the cable ends (except for the white/yellow cable) and then connect up correctly to the switch. Connect the two white/yellow cables (terminal 86) together (see Fig. 22a).



23 Mount the steering column trim again and then fix the switch in place.

24 Attach the ground cables of the relays and switch to suitable ground points in the engine compartment.

Land Rover Defender

25 Connect the two red cables (terminal 30) to the battery.

26 Re-fit all the parts that have been removed. Route all cables cleanly and use cable ties to fix them at suitable points.



27 Check the headlights for perfect function.

28 Adjust the headlights using a beamsetter and tighten the screws. Tighten the attachment screws on the light brackets again and use the black caps to seal the openings.



Attachment of auxiliary spotlights to a Nissan Qashqai



Before



After



A vehicle-specific attachment set is used for this installation. In contrast to a universal light bracket, the attachment elements included as part of the set in this case have been matched to the vehicle (see photo).

This makes the mounting procedure easier and reduces the amount of time required.



Although this is a vehicle-specific set, various other installation parts have to be made yourself (see photo).

The following additional material is required for mounting on the Nissan Qashqai:

1. 2 thick washers (per side)
2. Rubber seals 5 mm thick from the sanitary market.



Attachment is explained step-by-step below:

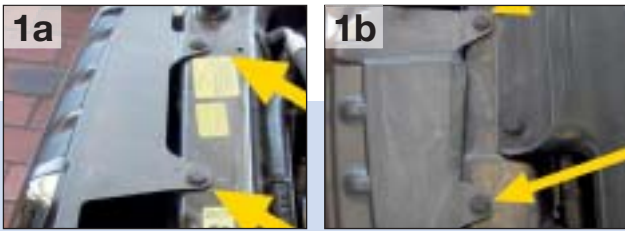

1 Loosen and remove the expanding rivets (x 4) on the radiator grille.

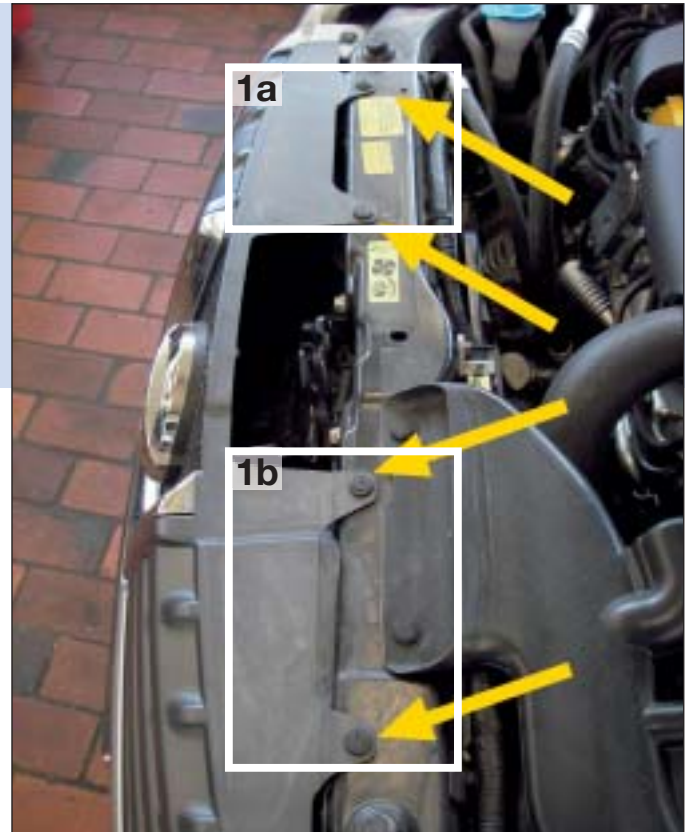

2 Pull the radiator grille forwards out of the front apron. **Note!** The retaining shackles are made of thin plastic
► Danger of breaking off.



3 Remove the licence plate.

Nissan Qashqai

4 Loosen the expanding rivets (x 7) from the covers (see arrows) and remove. Take covers out.



5 Mark the drill holes for the light bracket on the front apron according to the instructions in the installation manual. Make sure that the horizontal dimension of 622 mm is kept exactly. Otherwise, in the case of a slight deviation to the right, the cover cap on the towing hook will be damaged when the hole is expanded to 20 mm.



6 Use a 5 mm drill for pre-drilling and then expand to 20 mm using a bore cutter.

7 Remove the foam behind the holes to such an extent that the drilling points can be marked on the metal carrier.



8 Mount spacers onto the light bracket with the aid of the attachment screws. Now hold the light bracket (parallel to the floor) against the front apron and push carefully through the holes until the spacers meet the metal carrier. Mark these points. This procedure is best carried out by two people together. Then remove the light bracket from the front apron again.



9 In contrast to the instructions in the manual, the front apron has to be removed. There are two reasons for this. Two 9 mm holes have to be drilled in the metal carrier for attachment of the light bracket. A 9 mm standard drill is not long enough, however, to bridge the gap between the front apron and the metal carrier. In addition, the metal carrier is not parallel to the front apron, which means that the drill would „run off“ to the outer edge every time drilling was started.

Remove the front apron as follows:

- Unscrew the lower attachment screws (hex screws in the centre and two cross-slot screws each on the outside) (see Fig. 9a).
- Loosen the expanding rivets on the front of the wheel housing trims so that these can be pulled away sufficiently to reach the screws on the underside of the wing. One expanding rivet per wheelhouse (see Fig. 9b).



- Pull the decorative strips off the wings by means of the 4 clips.

Note! The clips can break off if too much force is used (see Fig. 9c).

- Pull the ends of the front apron outwards out of the catches. If fog lights are installed, disconnect the plug connection.



- Unscrew the cross-slot screws (see Fig. 9d).



10 Remove the foam moulded part. To do this push the attachment clips off forwards.



11 Drill holes in the metal carrier. Pre-drill with a 3 mm drill first and then expand with a 9 mm drill. Seal the drill holes using rust protection.

12 Re-attach the foam moulded part.

13 Refit all the removed parts (except for the radiator grille and covers from section 4).

Nissan Qashqai

14 When the drill holes were fixed, it was found that the spacers are about 8 mm too short. There is another challenge, too. Due to the shape of the metal carrier, the spacers face outwards after tightening rather than being parallel to the vehicle axis.



As mentioned at the beginning, these two problems were solved by a combination comprising two x 5 mm rubber seals from the sanitary market and two thick washers (per side).



15 Proceed as follows to finish mounting the light brackets:

- Guide the light brackets through the holes in the front apron.
- Push the rubber seals and washers onto the threaded bridge of the spacer sleeves.
- Push the brackets through the drill holes as far as they will go onto the metal carrier.
- Then fix the light brackets in place using suitable „stop nuts“.
- Mount the covers and the radiator grille again.

16 Assemble the headlight (in this case the Luminator Compact) according to the Hella instructions and attach loosely to the light bracket.

17 Route the auxiliary headlight cables according to the circuit diagram and use cable ties to fix them in place at suitable points.

18 A relay is required for operation of the auxiliary headlights. The working current relay 4RA 003 510-081 can be used for this purpose. Look for a suitable spot for the relay (depending on the engine version) and fix it in place. With the test vehicle, we decided in favour of a point on the upper cross member behind the left headlight.

Connect headlights and relays in accordance with the circuit diagram. The switching current for the relay (terminal 56a, high beam) is taken from the green cable (central plug) of the left headlight with the aid of an incision connector or butt joint.



19 Test the headlights for perfect function.

20 Adjust the headlights using a beamsetter and tighten the screws. Tighten the attachment screws on the light brackets again and use the black caps to seal the openings.



Attachment of auxiliary spotlights to a VW Tiguan



Before



After



A vehicle-specific attachment set is used for this installation. In contrast to a universal light bracket, the mounting instructions and attachment components have been matched to the vehicle in this case (see photo). This makes the mounting procedure easier and reduces the amount of time required.



Although this is a vehicle-specific set, additional attachment parts have to be made yourself.

The following additional material is required for attachment to the VW Tiguan:

1. 2 x M8 bolts 135 mm long
2. 2 spacer sleeves 20 mm long



Attachment is explained step-by-step below:

1 Remove the licence plate.

2 Remove the radiator grille. To do this, remove the screws (1 x T 25 and 2 x T 30) (see photo).



3 Then pull the radiator grille forwards and out of the fixing lugs.
Note! Pull the grille off carefully, since the locating lugs can easily break off.



4 Transfer the measurements for the drill holes to the front apron in accordance with the installation manual. Use a 6 mm drill to drill the holes and expand these to 25 mm using a bore cutter.



VW Tiguan

5 Use a Stanley knife to cut the two pieces of moulded foam that project over the cross member (see photo). This is the only way the base plates can be attached properly.

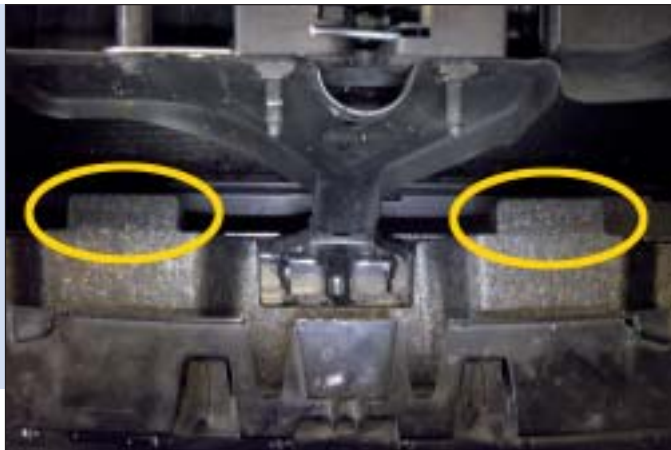

6 Loosen the hexagon socket screws (2 mm) on the base plates.

Note! In contrast to the specification in the installation manual, the clamp brackets have to be set to a dimension of 44 mm. Tighten the hexagon socket screws slightly.

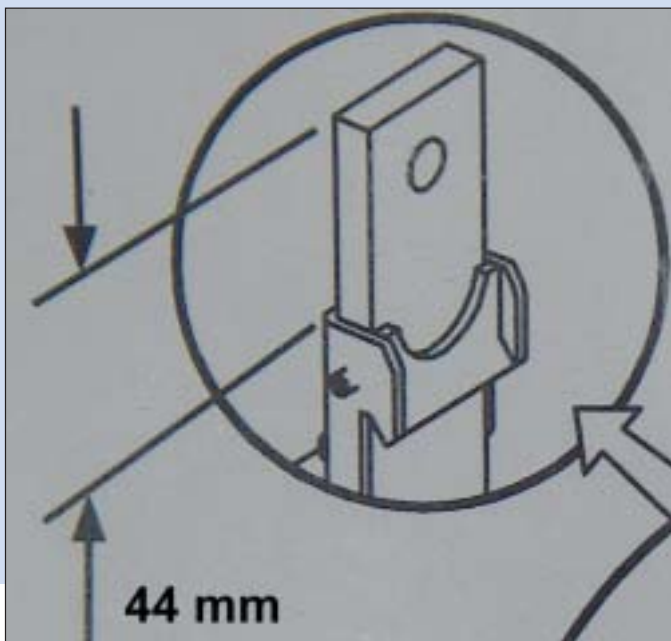

7 Use the enclosed screws to fasten the black spacers to the base plates.



8 „Insert“ the upper clamp bracket of the base plates onto the edge of the cross member according to the instructions.

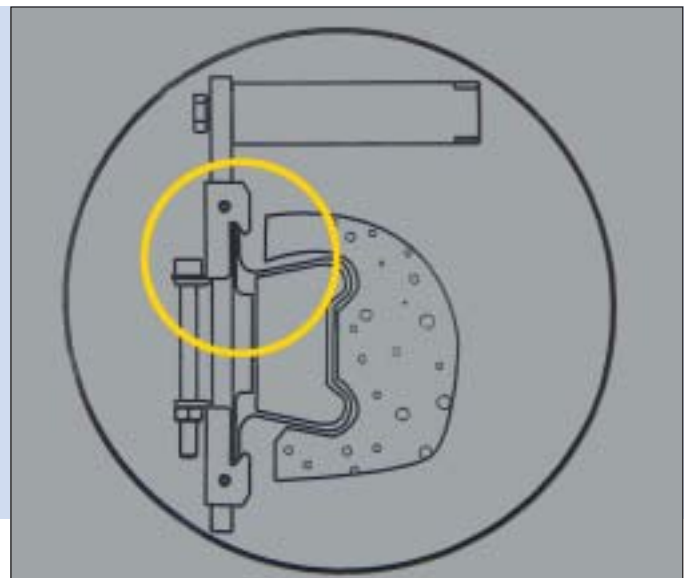

9 The spacer sleeves have to be aligned centrally to the holes in the front apron. If this is not the case, loosen the clamp bracket again and carry out „fine adjustment“.



10 Then tighten the hexagon socket screws (6 mm) in such a way that the carrier plates can no longer be moved. Then fasten the hexagon socket screws of the base plates.



11 There are two aluminium spacer sleeves included in the set for completing the mounting of the light brackets. These are too short, however. For this reason, two 20 mm spacer sleeves with the same inner and outer diameter have to be made as mentioned above.



(Left: a new sleeve, right: a sleeve from the set).

12 Equally, two new M8 bolts of a suitable length are required. A new screw on the top, one from the set on the bottom.



13 Hold the light bracket with screws and spacer sleeves in front of the drill holes. Screw the screws into the spacers and tighten equally on both sides.



14 Mount the radiator grille again. Attach the auxiliary headlight, in this case Luminator Compact Xenon, on the bracket in accordance with the installation manual and roughly align it. Only tighten the screws by hand at first.

15 With the aid of welding wire, route the cables of both auxiliary headlights into the engine compartment. The welding wire is routed at an angle down from the top between the headlights and the radiator. Then attach the cables to the welding wire and pull this upwards.



16 To prevent some cables having to be extended – the harness with relay and fuse is included as part of every headlight – both relays are attached to the air intake channel near the battery. The relay installation location can vary depending on the engine version, however (in the case of this example, the engine was a 2.0 TDI version). Before attaching the relay, connect the two blue cables to PIN 87 of the respective relay.



17 Use an M8 bolt to attach the four ring lugs of the ground cable to the ground point next to the battery.



18 Connect the two ring lugs for the load current (terminal 30) to the free connection in the fuse box. To do this, push the two catches forwards and remove the cover.



19 The original ring lugs cannot be attached because of their size. For this reason, crimp smaller lugs to the ends of the cables. Then attach the two ring lugs using a stop nut.



20 Push the fuse holders together into one unit.

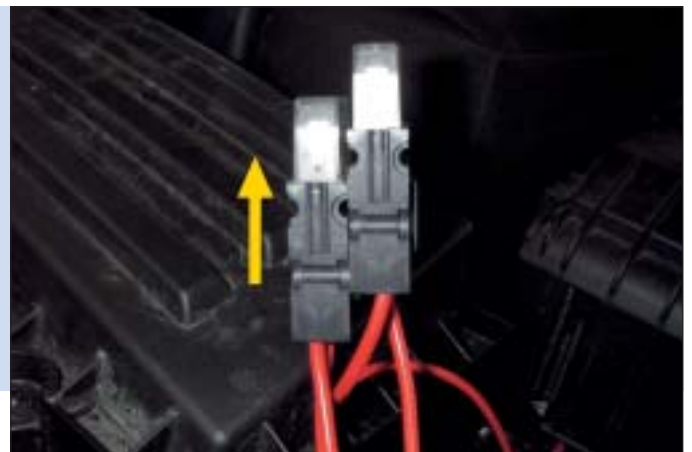

21 Then drill a 3 mm hole in the cover of the air filter box and fix the fuses in place using a suitable Parker screw.



VW Tiguan

22 In order to connect the high beam (signal current), the two white/yellow cables must be routed from the relays to the central plugs of the headlights and be shortened accordingly.

Tip: Releasing the central plugs from the headlights and pulling them off makes the mounting procedure easier. Subsequently use an incision connector or butt joint to connect the white/yellow cables with the grey/white cables (high beam, PIN 11 to the central plugs). Then fix the plugs to the headlights again.



23 Route all cables correctly and use cable ties to fix them at suitable points.

24 Test the headlights for perfect function.

25 Adjust the headlights using a beamsetter and tighten the screws. Tighten the attachment screws on the light brackets again and use the black caps to seal the openings. Attach the licence plate to the light bracket.

