

# Holley®

## 4-1/2" Tachometer Instructions

- 26-616** – Black 4-1/2" Tachometer 0-8K Standalone w/shift light-Holley logo
- 26-618** – Black 4-1/2" Tachometer 0-10K Standalone w/shift light-Holley logo
- 26-616W** – White 4-1/2" Tachometer 0-8K Standalone w/shift light-Holley logo
- 26-618W** – White 4-1/2" Tachometer 0-10K Standalone w/shift light-Holley logo

### IMPORTANT! Disconnect the battery prior to installation!

1. Connect tachometer power requirements as shown below.
2. Mount tachometer for easy viewing. Use included spin lock ring for mounting to gauge panel.
3. Hook up the red, black and white wires. (Refer to the schematic below).

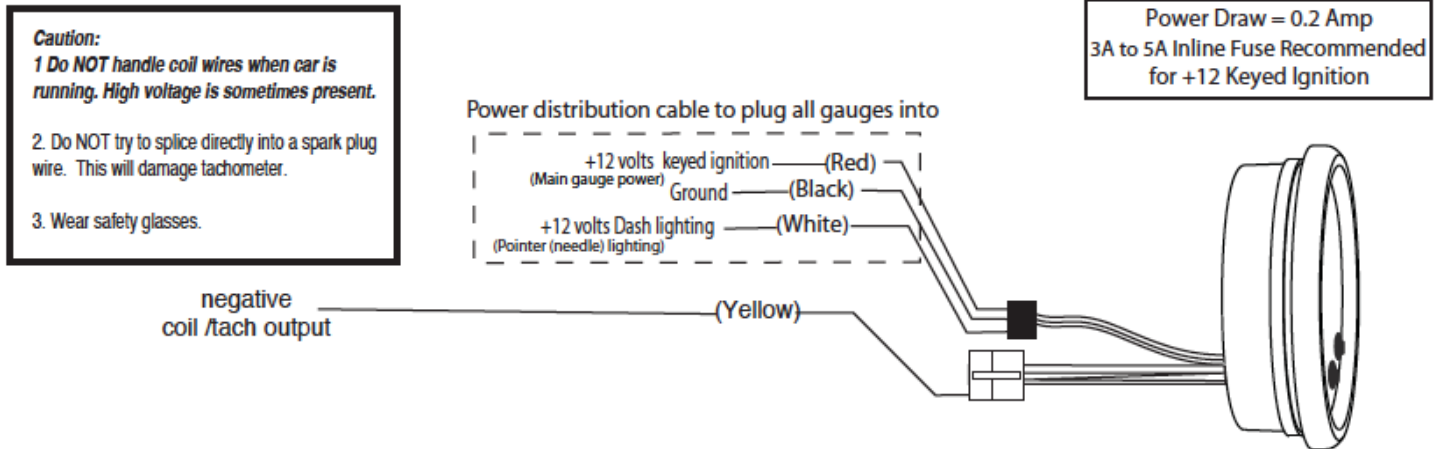

### NOTES ON TACH SIGNALS:

Your vehicle ignition system will fall under one of these 4 ignition types. The type of ignition system will determine where the yellow wire is connected and what the number of pulses per revolution the tachometer should be set to.

**Type #1** (single coil) – (fig. 1) Up until the 1990's tachometers picked up the signal from the (-) side on a single ignition coil, reading every pulse sent to all the cylinders. For example, an 8 cylinder (4 stroke) engine fires 4 spark plugs per revolution or all 8 spark plugs in 2 revolutions. Connecting the tachometer yellow signal wire to the negative side of the single coil on an 8 cylinder results in picking up 4 sparks in 1 revolution (see fig. 1). This type of ignition was used pre-dominantly until the 1990's and distributes sparks to each spark plug. In some vehicles during the 90's the coil and distributor merged into one unit, but it is the same ignition system - one coil that distributes sparks to all cylinders. When connecting the yellow wire to this style of ignition you will be picking up all cylinder sparks (see fig. 5).

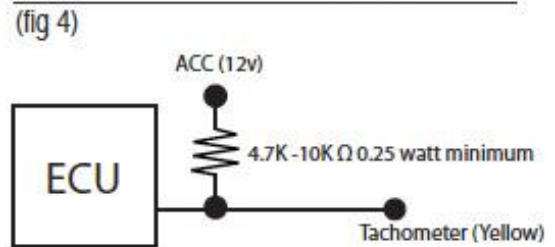
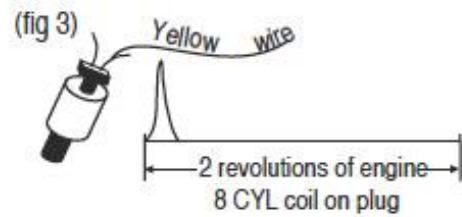
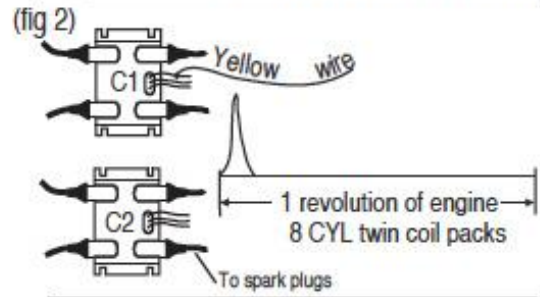
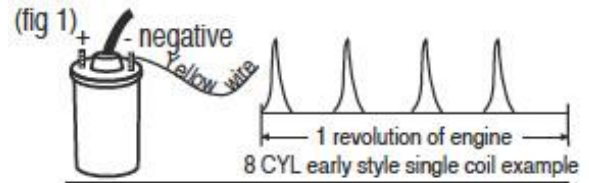

Setup the Tachometer to run 2 pulses per rev when connecting it to the engines' ECU.

**Type #2** (coil pack) - (fig. 2) is a 96 Mustang V8 with twin coil packs. Coil pack #1 (C1) controls the firing of 4 spark plugs and coil pack #2 (C2) controls the remaining 4 spark plugs. 2 or more separate coils are within each coil pack assembly. In this example each of the 2 coils within each coil pack sends sparks to 2 cylinders at the same time. When one cylinder is firing in the compression stroke, its paired cylinder is "waste" firing in the exhaust stroke. Each separate coil within the pack is controlled by its own trigger wire. In other words, if you hooked up the yellow wire to one coil trigger wire within one coil pack, it will see only a fraction of the total engine sparks (see fig. 5).

**Type #3** (coil on plug) – (fig. 3) An individual coil is placed directly on top of each spark plug eliminating the spark plug wires. The yellow wire, when hooked up to any coil, will pick up only 1 pulse per 2 revolutions or 1/2 pulse per 1 revolution (see fig. 3). For this type of ignition the yellow wire from the tachometer will connect to the trigger wire on one of the coils. Typically there will be 3 or 4 colored wires coming off of each coil. The trigger wire will be the wire that changes color from one coil to the next. For example, all coils may have red, gray and black wires coming off of them, but the fourth wire will be blue on one coil and green on the next coil.

**Type #4** (tach output from ECU) – (fig. 4) Some vehicles will have a tachometer output wire coming from the ECU. The yellow wire from our tachometer can receive signal from the ECU by following the diagram in fig. 4. 4.7k  $\Omega$  resistor and shrink tubing are included with gauge.

In summary, figure out how many cylinders you are picking up with the yellow wire and set the respective number of pulses per revolution (see step 4). The tachometer can be configured to work on .5 pulse (coil on plug) up to 6 pulses per revolution. Use fig. 5 as a starting point when hooking up the yellow wire.

#### 4. Hook up Yellow Wire

**Caution- High voltage sometimes present on ignition coil wires. Engine must be off when connecting yellow wire. Important note: connecting the tachometer to the wrong wire will NOT damage the tachometer or your ignition. It just won't work!**

**Fig 5: Tachometer yellow wire connection**

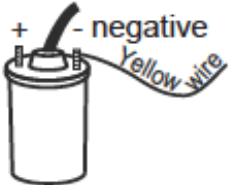
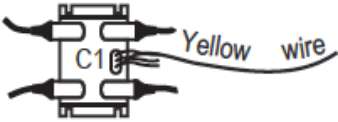
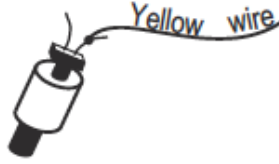
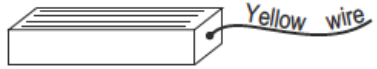
Type #1 ignitions	Type #2- Coil Packs	Type #3- Coil on Plug	Aftermarket ignitions / tach output
			
Yellow wire connects to: negative side of coil. 12 cyl = 6 Pulses / rev 10 cyl = 5 Pulses / rev 8 cyl = 4 Pulses / rev 6 cyl = 3 Pulses / rev 4 cyl = 2 Pulses / rev (see <b>step #4</b> )	Yellow wire connects to: • negative side of coil (some cars) or • coil control wire (some cars) or • coil trigger wire (some cars).  1 Pulses / rev. (as a good starting point) (see <b>step #4</b> )	Yellow wire connects to: • negative side of coil (some cars) or • coil control wire (some cars) or • coil trigger wire (some cars).  1/2 Pulses / rev. (as a good starting point) (see <b>step #4</b> )	Yellow wire connects to: tachometer output terminal 12 cyl = 6 Pulses / rev 10 cyl = 5 Pulses / rev 8 cyl = 4 Pulses / rev 6 cyl = 3 Pulses / rev 4 cyl = 2 Pulses / rev (see <b>step #4</b> )

#### 5. Set the Number of Pulses Per Revolution

**A.** Turn off power to the tachometer

**B.** Press and hold the menu button while powering on the tachometer. The pointer will move to the factory default position of 4 pulses per revolution (4000RPM). (See **fig. 6**)

**C.** Press and release the menu button to change the pulse per revolution setting. Once the pointer is on the desired pulse per revolution setting, press and hold the button for 5 seconds to save the setting. The pointer will return to zero indicating the setting has been saved.

**NOTE:** If nothing is selected after 5 seconds, the gauge will save the setting the pointer is on and return to zero. Tachometer will exit menu and return to normal operation.

#### 6. Set Your Shift Point and RPM Span

One of the most exciting features of the Revolution tachometer is the integrated shift LED's in the dial. This new technology lets you anticipate the next shift point by displaying 3 yellow warning LED's before reaching the set shift point Red #1 LED. The span between the LED's can also be set. Red #2 is an over-shift light that blinks if you exceed the set shift point by the set span value. If, for any reason you miss a shift and over- shoot your shift point this light will blink.

The following procedures can be done at any time during operation of the tachometer while the tachometer has power.

##### Shift point Set

Red #1 is set shift point. The 3 Yellow LEDs will turn on before the set shift point by the amount of span selected.

- Press and release menu button until 'shift' LED is lit.
- Press and release the 'Select' button. LED will

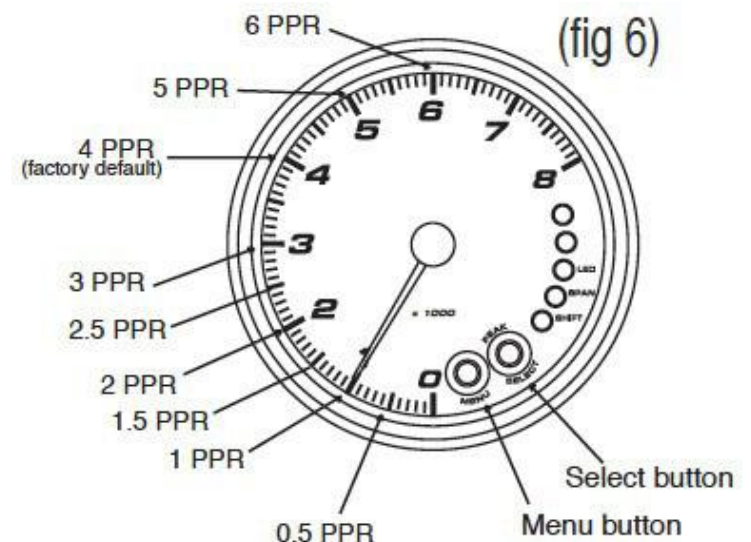

blink once to indicate you have selected the RPM shift point.

**C. Set shift point.**

- Press & hold 'Select' button to increase RPM shift point.
- Press & hold 'Menu' button to decrease RPM shift point.

After desired shift point is reached release buttons for 2 seconds. LED will blink 2 times to confirm new shift point has been saved.

**Shift RPM Span Set**

The shift span is the RPM range between the lighting of the LEDs. (See **fig. 7a**). Setting a span of '0' RPM will turn on all 5 LEDs at the set shift point.

Example: shift point set at 6500 RPM, span set at 200 RPM. yellow #1 will light at 5900 RPM, yellow #2 at 6100 RPM, yellow #3 at 6300 RPM, red #1 (shift point) at 6500 RPM, finally red #2 will blink at 6700 RPM.

- A.** Press and release menu button until 'span' LED is lit.
- B.** Press and release 'select button. LED will blink once to indicate you have selected the RPM span point.
- C.** Set RPM span.
  - Press and hold 'Select' button to increase RPM span.
  - Press and hold 'Menu' button to decrease RPM span.

After desired span is reached release buttons for 2 seconds. LED will blink 2 times to confirm new RPM span has been saved.

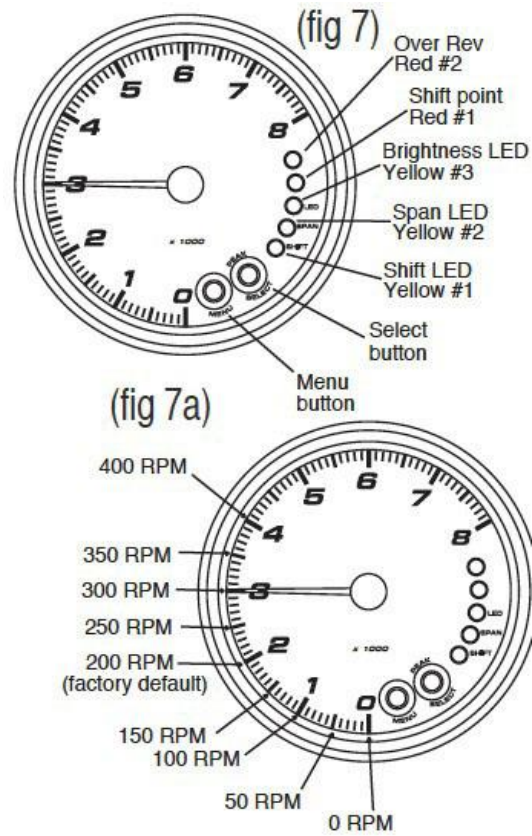

**7. Set Your LED Brightness**

A unique day and night LED brightness setting can be set on the Revolution tachometer. Each setting has 4 possible brightness positions including 'off'. The tachometer automatically knows which day or night value to set by sensing the voltage on the white wire connected to your dash lighting. Setting the LED brightness value with your lights 'on' will result in setting the 'night' brightness value. And likewise, setting the LED brightness value with your lights 'off' will result in setting the 'day' brightness value.

To set LED brightness, press and release menu button until Brightness LED is lit (see **fig. 7**). Press and release select button.

- Press & release select button to increase brightness.
- Press & release menu button to decrease brightness. After 2 second delay LED will blink to indicate setting has been saved.

**8. Peak Memory Recall Feature**

- A.** To show peak recall press and release peak (select) button.
  - Peak RPM will be displayed for a couple seconds.
  - After couple second delay tachometer will go back to normal operation.
- B.** To clear peak RPM press and release peak (select) button. During the peak RPM display press and release peak button again. This clears the RPM. LED will blink to indicate memory cleared.

