

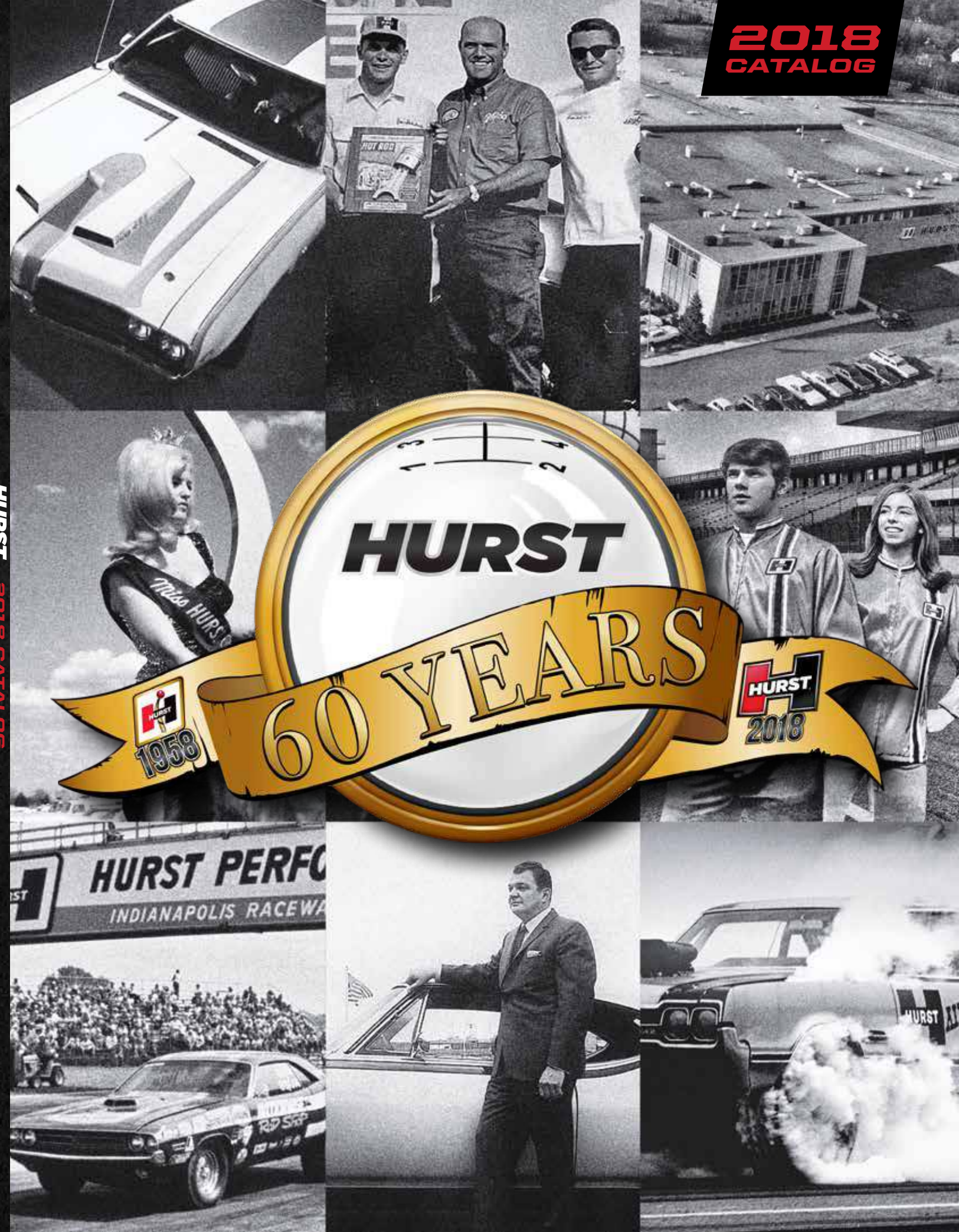

HURST 2018 CATALOG



HURST

60 YEARS

1958

2018

HURST PERFORMANCE INDIANAPOLIS RACEWAY



03 Hurst Elite Series Products

- 04 Build Your Own Hurst Car
- 05 Embroidered Floor Mats
- 06 Exhaust Systems
- 10 Suspension
- 12 Billet Center Caps
- 13 Graphics Packs

14 Line/Loc

16 Manual Shifters

- 18 Billet/Plus Shifters
- 28 Competition/Plus Shifters
- 33 Application Chart
- 38 Street Super Shifter
- 39 Mastershift
- 40 Indy Shifters
- 42 Nitro Shifter Sticks
- 44 Flat & Round Bar Shifter Sticks
- 47 Pistol-Grip Shifter Sticks
- 48 Universal Pistol-Grip
- 49 Universal T-Handle
- 50 Classic Shifter Knobs
- 51 Shifter Boots

52 Automatic Shifters

- 54 Billet/Plus Pistol-Grip
- 55 Comp Stick Kit
- 56 Pro-Matic 2
- 57 V-Matic 3
- 58 Quarter Stick
- 59 Pistol-Grip Quarter Stick
- 60 Quarter Stick Accessories

62 Driveline Conversions

- 64 BlackJack Shifters
- 66 Crossmembers
- 67 Tunnel Patches

68 Accessories & Service Parts

- 70 Accessories
- 71 Service Parts
- 72 Transmission ID Chart
- 74 Hurst Gear & Apparel



ELITE SERIES PRODUCTS

- 04 Build Your Own Hurst Car
- 05 Embroidered Floor Mats
- 06 Exhaust Systems
- 10 Suspension
- 12 Billet Center Caps
- 13 Graphics Packs

ELITE SERIES™ PACKAGES

Build Your Own Modern Day Hurst Car

Back in 1958, when innovator George Hurst founded the company that bears his legendary name, he and his team were pioneering and designing a wide variety of performance products for the blossoming hot rod community, such as shifters, motor mounts, disc brakes, wheels, Line/Loc, the Jaws of Life, and much more. Today, while Hurst continues to develop industry leading shifters, we've re-focused our goals to carry out George's original vision. Our mission: to design and produce the highest quality performance products available for modern muscle cars and their demanding enthusiasts. The Hurst Elite Series Program, available for Camaros, Challengers, Chargers and Mustangs, is the result of this mission.

How the Program Works

In order for your car to qualify for the program, it must be fitted with the following Hurst Elite Series items: shifter, floor mats, center caps, graphics, springs and exhaust.



FLOOR MATS

Embroidered & Vehicle Specific

The Hurst Elite Series Floor Mat Kit includes a 4-piece set of durable black carpet mats that feature an embroidered Hurst logo on the front pair. These high quality mats are cut for a perfect fit, are equipped with OEM-style attachment points and feature a non-slide backing. Rear mats not shown. Available in either red or gold.

CHEVROLET	YEAR	PART# (RED)	PART# (GOLD)
Camaro (Front Mats Only)	2016-2018	6370003	6371003
Camaro	2010-2015	6370000	6371000
DODGE			
Challenger	2008-2018	6370010	6371010
Charger	2015-2018	6370011	6371011
FORD			
Mustang	2015-2018	6370021	6371021
Mustang	2010-2014	6370020	6371020
GM			
A-Body	1964-1967	6370001	--
A-Body	1968-1972	6370002	--

EXHAUST SYSTEMS

Chevrolet Camaro

Hurst's sister company, Flowmaster, is a leader in the design, manufacturing and distribution of completely engineered exhaust systems for both today's and yesterday's muscle cars. Founded 35 years ago, Flowmaster mufflers were originally conceived as a solution to a growing problem with sound issues at race tracks in California and beyond. This led to many firsts in automotive exhaust science, as well as many patents protecting the various technologies used in Flowmaster products. With these developments, Flowmaster ushered in a revolution in automotive performance exhaust.

Flowmaster's exhaust systems deliver a deep and powerful exhaust note that is instantly recognized all over the world. All systems feature 100% 409S stainless steel construction, fully mandrel bent tubing and OEM mounting locations for a perfect fit every time.

FEATURES & BENEFITS

- » Iconic Flowmaster Exhaust Note
- » Outlaw: Aggressive Sound Level
- American Thunder: Moderate Sound Level
- Force II: Mild Sound Level
- 100% 409S Stainless Steel Construction
- Mandrel Bent Tubing for Optimal Exhaust Flow



MODEL	ENGINE	EXHAUST SYSTEM	TIPS	PART#
2016-2018 Camaro SS	6.2L	American Thunder Axle-Back (No Performance Exhaust Option)	Dual, Polished	817744
2016-2018 Camaro SS	6.2L	Outlaw Axle-Back (No Performance Exhaust Option)	Dual, Black	817745
2016-2018 Camaro SS	6.2L	American Thunder Axle-Back (Dual Mode-NPP)	Quad, Polished	817746
2016-2018 Camaro SS	6.2L	Scavenger Series X-Pipe (Manual Trans, No Convertible)	--	81083
2016-2018 Camaro SS	6.2L	Scavenger Series X-Pipe (Auto Trans, No Convertible)	--	81084
2016-2018 Camaro LT 3.6L	3.6L	American Thunder Axle-Back (No Performance Exhaust Option)	Dual, Polished	817743
2016-2018 Camaro LT 2.0L	2.0L	American Thunder Axle-Back (No Performance Exhaust Option)	Dual, Polished	817751



EXHAUST SYSTEMS

Ford Mustang

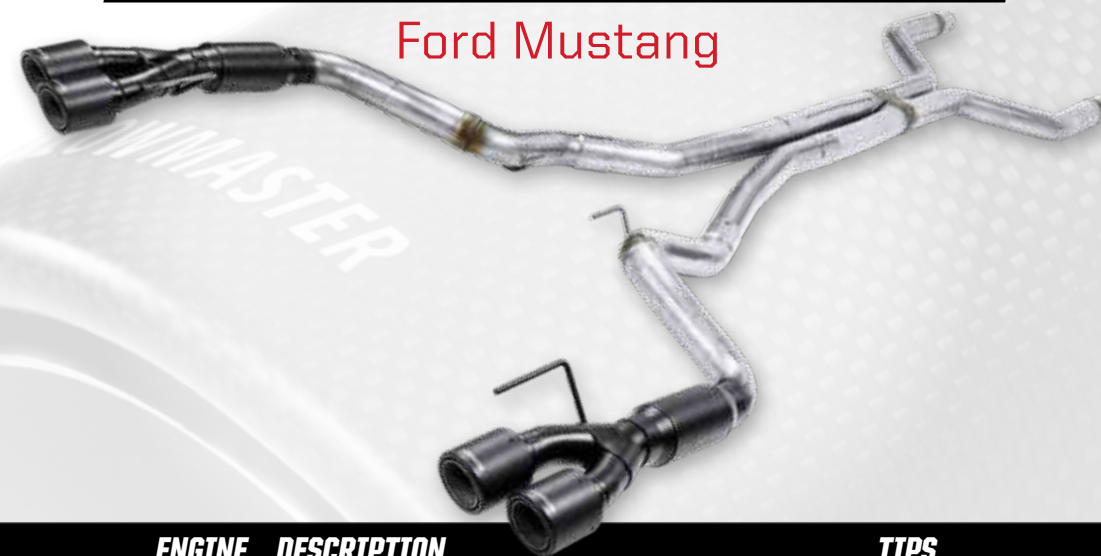

MODEL	ENGINE	DESCRIPTION	TIPS	PART#
2018 Mustang GT	5.0L	Outlaw Cat-Back (With Valves)	Quad, Carbon Fiber	817800
2018 Mustang GT	5.0L	Outlaw Cat-Back (No Valves)	Quad, Carbon Fiber	817808
2018 Mustang GT	5.0L	Outlaw Axle-Back (With Valves)	Quad, Polished	817799
2018 Mustang GT	5.0L	Outlaw Axle-Back (No Valves)	Quad, Black	817806
2018 Mustang GT	5.0L	Outlaw Axle-Back (No Valves)	Quad, Polished	817821
2018 Mustang GT	5.0L	American Thunder Axle-Back (No Valves)	Quad, Polished	817807
2018 Mustang GT	5.0L	Outlaw Axle-Back (With Valves)	Quad, Black	817824
2018 Mustang GT	5.0L	Outlaw Axle-Back (With Valves)	Quad, Polished	817825
2018 Mustang GT	5.0L	Scavenger X-Pipe Kit	--	817817
2015-2017 Mustang GT	5.0L	Hurst Elite Series Cat-Back (No Valves)	Dual, Polished	6350024
2015-2017 Mustang GT	5.0L	Outlaw Cat-Back (No Valves, No Convertible)	Dual, Polished	817734
2015-2017 Mustang GT	5.0L	American Thunder Cat-Back (No Valves, No Convertible)	Dual, Polished	817730
2015-2017 Mustang GT	5.0L	Outlaw Axle-Back (No Valves)	Dual, Polished	817732
2015-2017 Mustang GT	5.0L	Outlaw Axle-Back (No Valves)	Dual, Black	817826
2015-2017 Mustang GT	5.0L	American Thunder Axle-Back (No Valves)	Dual, Polished	817749
2015-2017 Mustang GT	5.0L	Scavenger X-Pipe	--	81109
2015-2018 Mustang	2.3L/3.7L	Hurst Elite Series Cat-Back (No Valves)	Dual, Polished	6350027
2015-2018 Mustang	2.3L	American Thunder Cat-Back (No Valves)	Dual, Polished	817750
2015-2018 Mustang	2.3L/3.7L	American Thunder Axle-Back (No Valves)	Dual, Polished	817748
2015-2018 Mustang	2.3L	Outlaw Axle-Back (No Valves)	Dual, Black	817823
2015-2018 Mustang	2.3L	Outlaw Axle-Back (No Valves)	Dual, Polished	817713
2015-2017 Mustang	3.7L	Scavenger X-Pipe	--	81107
2018-2018 Mustang	2.3L	Scavenger X-Pipe	--	81108



EXHAUST SYSTEMS

Dodge Challenger



MODEL	ENGINE	DESCRIPTION	TIPS	PART#
2015-2018 Challenger SRT 392, R/T Scat Pack, Hellcat	6.2L/6.4L	American Thunder Cat-Back (No Valves)	Quad, Polished	817739
2015-2018 Challenger SRT 392, R/T Scat Pack, Hellcat	6.2L/6.4L	Outlaw Cat-Back (No Valves)	Quad, Polished	817740
2015-2018 Challenger SRT 392, R/T Scat Pack, Hellcat	6.2L/6.4L	American Thunder Cat-Back (With Valves)	Quad, Polished	817759
2015-2018 Challenger SRT 392, R/T Scat Pack, Hellcat	6.2L/6.4L	Outlaw Cat-Back (With Valves)	Quad, Polished	817760
2017-2018 Challenger R/T, T/A	5.7L	Outlaw Cat-Back (With Valves)	Quad, Polished	817773
2015-2016 Challenger R/T	5.7L	Outlaw Cat-Back (No Valves)	Quad, Polished	817717
2015-2016 Challenger R/T	5.7L	Outlaw Axle-Back	Quad, Polished	817718
2015-2016 Challenger R/T	5.7L	American Thunder Cat-Back (No Valves)	OEM Tips	817716
2015-2016 Challenger R/T	5.7L	Force II Cat-Back (No Valves)	OEM Tips	817715
2015-2018 Challenger SXT	3.6L	American Thunder Cat-Back (No Valves)	OEM Tips	817737



EXHAUST SYSTEMS

Dodge Charger



MODEL	ENGINE	DESCRIPTION	TIPS	PART#
2015-2018 Charger SRT 392, R/T Scat Pack, Hellcat	6.2L/6.4L	American Thunder Cat-Back (No Valves)	Dual, Polished	817684
2015-2018 Charger SRT 392, R/T Scat Pack, Hellcat	6.2L/6.4L	American Thunder Cat-Back (With Valves)	Dual, Polished	817758
2015-2018 Charger SRT 392, R/T Scat Pack, Hellcat	6.2L/6.4L	Outlaw Cat-Back (With Valves)	Dual, Polished	817775
2015-2018 Charger SE/SXT	3.6L	American Thunder Cat-Back (No Valves)	OEM Tips	817741
2017 Charger R/T	5.7L	Outlaw Cat-Back (With Valves)	OEM Tips	817779
2017 Charger R/T	5.7L	American Thunder Cat-Back (OEM Valves)	OEM Tips	817778
2017 Charger R/T	5.7L	American Thunder Axle-Back	OEM Tips	817780
2015-2016 Charger R/T	5.7L	Outlaw Cat-Back (No Valves)	OEM Tips	817774
2015-2016 Charger R/T	5.7L	American Thunder Cat-Back (No Valves)	OEM Tips	817658



HP SPRINGS

High Performance Lowering Springs

The Hurst HP Spring Kit is an excellent choice for firming up the handling of your muscle car and giving it that “Just Right” stance. These springs will lower your vehicle approximately one inch, closing up the fender gap and lowering the center of gravity for improved handling, braking and overall driving feel. Through careful design and rate tailoring, the Hurst HP Spring Kit accomplishes all of the above while still being street-friendly.

CHEVROLET	YEAR	PART#
Camaro SS	2016-2018	6130001
DODGE		
Challenger R/T & SRT	2011-2016	6130010
Charger R/T	2011-2017	6130012
FORD		
Mustang GT	2015-2018	6130022
Mustang (All Models)	2011-2014	6130020



SUSPENSION

High Performance Suspension Kits

The Hurst HP Suspension Kit will lower your vehicle approximately one inch, and also increase roll stiffness. These two small changes close up the fender gap, lower the center of gravity for improved handling and braking, and keep body roll to a minimum. From the very first drive you will notice a more neutral balance to the vehicle, more precise turn-in capability, and increased cornering grip.

CHEVROLET	YEAR	PART#
Camaro SS	2013-2014	6320001
Camaro ZL1	2012-2015	6320001
Camaro SS	2010-2012	6320000
DODGE		
Challenger R/T & SRT	2011-2014	6320010
FORD		
Mustang (All Models)	2011-2014	6320020



BILLET CENTER CAPS

For OEM Wheels

These new Hurst center caps are a quick and easy way to add some style to your stock factory wheels. Made entirely of CNC machined billet aluminum with a MIL-spec black anodized finish, these super high quality pieces look great on any wheel they fit. The backing plate design ensures that the center caps will never fall off and safeguards against theft. The center caps are finished off with a clear UV powdercoat finish, protecting them from fade for years to come.

FEATURES & BENEFITS

- » CNC Machined Billet Aluminum Construction
- » Durable MIL-Spec Black Anodized Finish
- » Precision Engraved Hurst Logo
- » Clear Powdercoat for UV Protection
- » Reliable Backing Plate Design
- » Fits OEM Wheels

YEAR	VEHICLE	PART#
2016-2018	Chevrolet Camaro (All Alloy Wheels, All Engines/Submodels)	6360004
2015-2018	Ford Mustang (All Alloy Wheels, All Engines/Submodels)	6360005
2016-2018	Dodge Challenger & Charger (All Alloy Wheels, All Engines/Submodels)	6360006

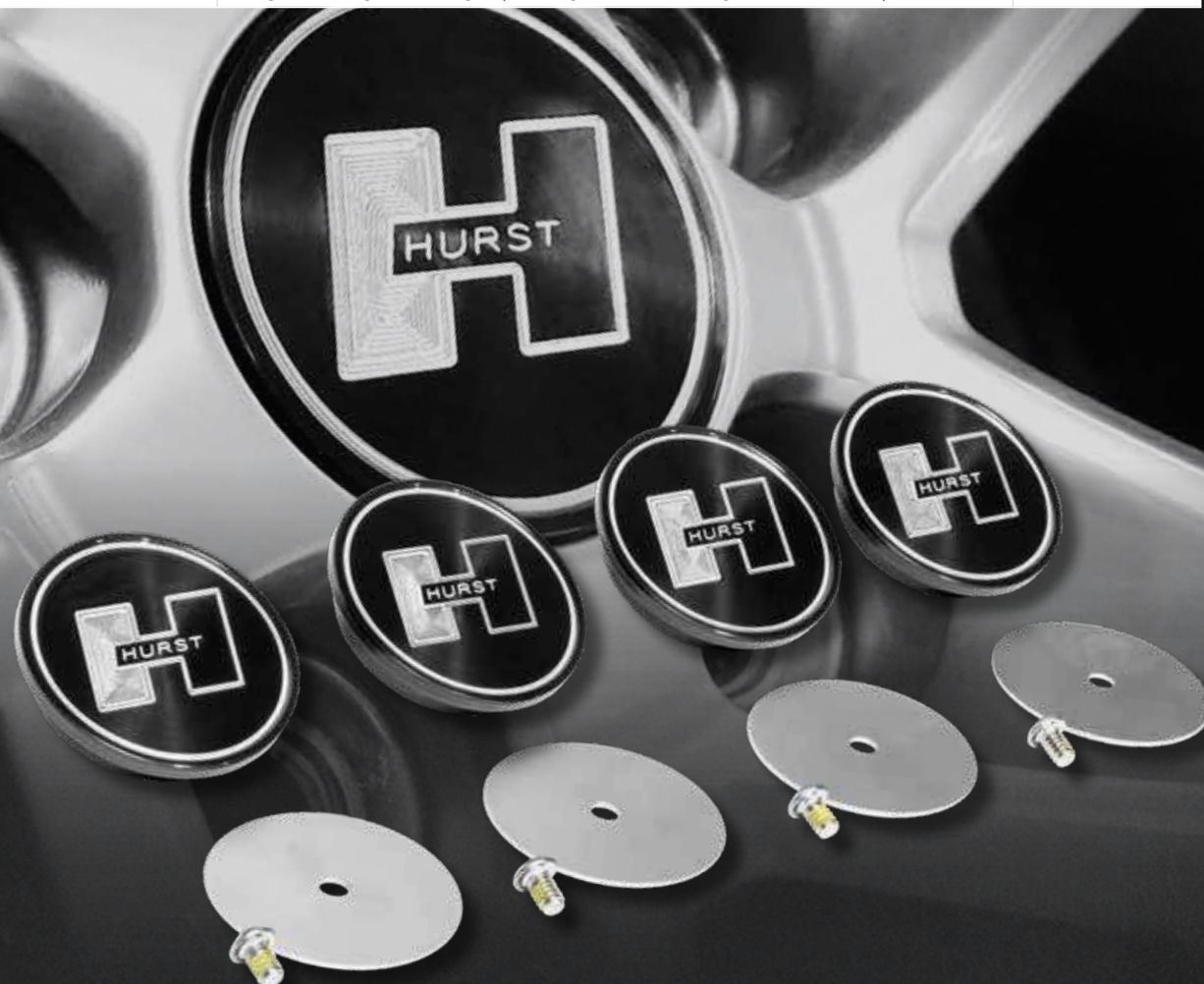

GRAPHICS PACKS

Show Your Hurst Pride

Let everyone know that you're part of an elite group of automotive enthusiasts by equipping your car with a set of these Hurst graphics! Printed, laminated and trimmed by licensed specialists, these decals are made from the highest quality automotive grade vinyl for extended durability against fade and easy application. Available in either red or gold, each Graphics Pack includes ten separate decals: two large Hurst logos (4.0 in x 7.0 in), two large Performance decals (0.8 in x 5.7 in), two small Hurst logos (2.0 in x 3.6 in), two small Performance decals (0.4 in x 3.8 in) and two Hurst block letter logos (1.0 in x 5.7 in). Includes applicator tool.

RED GRAPHICS PACK (1320000)



GOLD GRAPHICS PACK (1321000)



Complete Roll Control System

Designed with simplicity and ease-of-install in mind, Hurst's complete Line/Loc kits use the absolute best-quality, pre-bent, double-walled stainless steel brake lines. In many cases, these hard-lines are superior to OEM quality. Hurst engineers realized when developing these kits that less really is more. Fewer connection points means fewer places where the system can leak and shorter lines mean less time bleeding the system. These kits are direct bolt-in meaning no measuring, no cutting, and no pre-bending; just simple, clean, factory-looking installs right out of the box.

This is used primarily in drag racing to provide positive locking action to the front wheels of race cars, reducing the chance of "Rolling the Lights" and producing more effective burnouts for heating up the tires. Rigorous testing has proved a 1/100,000 of a second release time and vibration tests have seen up to 30 Gs applied without mechanical failure. Adaptable to most domestic and import hydraulic brake systems. CAUTION: Hurst Line/Loc Should not be used as an emergency brake, or any application requiring the solenoid to be activated for a long period of time.

FEATURES & BENEFITS

- >> Advanced Stainless Steel Valve Assembly for Ultimate Corrosion Resistance
- >> Fully-Enclosed Epoxy-Molded Electrical Coil for Reliability
- >> Attractive, Finned-Aluminum Housing Helps Dissipate Heat
- >> Wider, Lightweight Base Provides Better Mounting Stability
- >> 150-Micron Screen Filtered Ports to Prevent Contamination
- >> Extra Threaded Port for Separate Bleeder or Brake Line Pressure Gauge



COMPLETE LINE/LOC KITS	YEAR	PART#
Chevrolet Camaro	2010-2015	5671518
Dodge Challenger	2011-2014	5671520
Dodge Challenger	2008-2010	5671517
Ford Mustang	2011-2014	5671519
Ford Mustang GT	2005-2009	5671521
Universal Kit	--	1745000
LINE/LOC SOLENOID ONLY		
Line/Loc Solenoid	--	5667550
Line/Loc Rebuild Kit	--	5671500
LINE/LOC ADAPTER FITTINGS KIT		
Chevrolet Camaro/Pontiac Firebird	1993-2002	5671515
Chevrolet Corvette	1985-1996	5671515
Ford Mustang (w/o Bosch ABS)	1983-2011	5671516

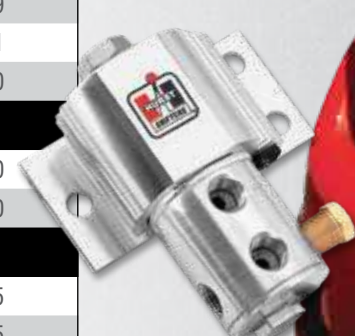

Accessories



LINE/LOC INSTALLATION KIT
Part #5671510



SNAP-ACTION SPIRAL CORD SWITCH
Part #483880



LINE/LOC ADAPTER FITTINGS KIT
Part #5671515



COMPETITION KNOB W/ SWITCH
7/16"-20 • Part #1630050



REPLACEMENT SWITCH
Part #2483875



MODERN SWITCH KIT
Part #2483876

Elite Series

Line/Loc

Manual Shifters

Automatic Shifters

Driveline Conversions

Accessories & Service Parts

Elite Series

Line/Loc

Manual Shifters

Automatic Shifters

Driveline Conversions

Accessories & Service Parts

MANUAL SHIFTERS

- 18 Billet/Plus Shifters
- 28 Competition/Plus Shifters
- 33 Application Chart
- 38 Street Super Shifter
- 39 Mastershift
- 40 Indy Shifters
- 42 Nitro Shifter Sticks
- 44 Flat & Round Bar Shifter Sticks
- 47 Pistol-Grip Shifter Sticks
- 48 Universal Pistol-Grip
- 49 Universal T-Handle
- 50 Classic Shifter Knobs
- 51 Shifter Boots

BILLET/PLUS®

The Highest Quality Manual Shifters Available

Carved out of solid pieces of strong, high-quality steel and aluminum, Hurst Billet/Plus shifters are designed by engineers with the best equipment and technology available. Billet/Plus shifters incorporate a high ratio pivot mechanism for reduced shifter throw and are sturdily constructed for a more positive and precise feel when shifting. Self centering alignment improves 2nd to 3rd up-shift gear changes to reduce the chance of "missed shifts", while patented adjustable bias spring loads on many models allow stick tension to be tailored to drivers preference. Dedicated applications assure a custom fit and eliminate any vehicle modifications for ease of installation. This is all backed by the history, heritage, and knowledge that Hurst has acquired over half of a century of shifter design.

BILLET/PLUS®

Chevrolet Camaro

3916031 • 2016-2018 CAMARO SS

REDUCED SHIFT THROW BY 40%

The heritage of Hurst is now available for the new breed of Chevy's Camaro SS with this new Billet/Plus 6-speed performance shifter. Designed to put the feel of performance back into shifting, this quality crafted precision shifter is a must for the serious Camaro performance enthusiast. This shifter features Hurst's classic and iconic white shift knob for that old-school muscle car look while maintaining modern performance.



3916131 • 2016-2018 CAMARO SS

BLACK PISTOL-GRIP FOR MODERN LOOK

Hurst introduces a new version of their popular Billet/Plus shifter for the 6th generation Chevy Camaro SS with the 6-speed manual transmission. This shifter has all of the same performance benefits of the classic version, but now adds a black pistol-grip style handle.



3916034 • 2016-2017 CAMARO LT

REDUCED SHIFT THROW BY 40%

Hurst introduces a new version of their popular Billet/Plus shifter for the 2016-2017 Camaro LT with the TR3160 6-speed manual transmission. Features a 40% reduction in shifter throw and adds a black pistol-grip style handle.



1531003 • 2016-2018 CAMARO

PISTOL-GRIP REPLACEMENT HANDLE FOR FACTORY SHIFTER

The new Hurst Billet/Plus Pistol-Grip shift handle is made specifically to replace the factory shift handle in the 2016-2018 Chevrolet Camaro with 6-Speed manual transmissions. Constructed from CNC machined 6061-T6 aluminum and real Blackwood side grip plates with a stippled finish.





BILLET/PLUS®

Chevrolet Camaro / Pontiac G8

3916030 • 2010-2015 CAMARO SS / 2009 G8 GXP

REDUCED SHIFT THROW BY OVER 44%

From concept through production of the 5th generation Camaro, GM engineers in both Australia and Detroit were in almost daily contact with Hurst engineers for guidance and design support. Stout Tremec TR-6060 and little brother, Aisin Warner AY6, transmissions were sent thousands of miles across the Pacific for testing and evaluation in conjunction with prototype shifters. Secretive track and laboratory testing, including GM's brutal GMN2893 endurance tests, were run to ensure that this Hurst Shifter was the best. That's why you had the option to get Hurst Shifter in a Camaro installed at the factory. If you didn't – don't worry. Hurst engineers used all of that knowledge and made the aftermarket version even better.

3916029 • 2010-2015 CAMARO V6

REDUCED SHIFT THROW BY 38% • V6 6-SPEED SHIFT PATTERN KNOB

FEATURES & BENEFITS

- » CNC-Machined, 6061-T6 Billet Aluminum Pivot Housing
- » Heat-Treated, Billet Steel Gear Selector Shaft and Bushing Housing for Ultimate Strength
- » High-Strength, Chrome-Plated Steel Upper Stick - Not a Casting
- » Teflon Lined Spherical Bearing Main Pivot Ensures Smooth Shifting and Reduced Wear
- » Direct-Link, Full-Race, Isolation-Eliminating Design for a No-Compromise Positive Shift
- » Optional Isolation System Included Reduces Stick Vibration and Noise Transfer
- » Improved, Glass-Filled, Teflon Lower Bushing with Greater Stability and Strength
- » Includes White, Hurst 6-Speed Knob



BILLET/PLUS®

Chevrolet Camaro / Pontiac Firebird

3915061 • 1993-2002 CAMARO & FIREBIRD

REDUCED SHIFT THROW BY OVER 30%

When the designers and engineers at GM need help with improved performance shifting in their newest concepts they turn to Hurst. From the GTO and Camaro models in the 1960s through today's modern Camaros, GM works directly with Hurst engineers to help improve shifting in their vehicles. That's something only a company with almost 6 decades of shifter design experience can provide. The shifters in the 4th generation Camaro & Firebird were no different. Hurst was tasked with creating a performance shifter that could be an option and installed in the factory. Of course the OEMs have to design for every possible driver – this shifter is that factory shifter with no compromises and with the added classic Hurst style. Includes a black Hurst 6-speed knob.

3915060 • 1993-2002 CAMARO & FIREBIRD

RETAINS FACTORY KNOB & INTERIOR STYLING

FEATURES & BENEFITS

- » Self-Centering Alignment for Improved 2nd to 3rd Upshift Gear Changes
- » Stainless Steel Rotating Pivot Ensures Smooth Shifting and Reduced Wear
- » Two Piece, Bolt-On Upper Stick Allows the Install of any Hurst Upper Stick
- » Adjustable Positive Gear Stops to Help Prevent Internal Transmission Damage
- » Exclusive Oil Control Seal Eliminates Transmission Fluid Loss and Contamination
- » CNC-Machined, 6061-T6 Billet Aluminum Base and Stop Collar
- » Polyamide Pivot Cup Reduces Stick Vibration and Noise Transfer



BILLET/PLUS®

Chevrolet Corvette

3916042 • 2014-2018 C7 CORVETTE

REDUCED SHIFT THROW BY 16%

This shifter has all of the performance benefits and quality you expect when buying a Hurst shifter, plus a 16% reduction in shifter throw. The pistol-grip features real Blackwood side grip plates with a stippled finish for both a firm grip and fighter jet looks to match the cockpit and attitude of the Stingray. The side grip plates are replaceable with our optional checkered finished Rosewood side plates part #1539000, along with other finishes coming soon.

FEATURES & BENEFITS

- » Modern Pistol-grip with Replaceable Real Wood Side Plates
- » CNC Machined from 6061-T6 Aluminum Construction
- » Firm and Precise Shifting with 16% Reduced Throw
- » Mil-Spec Black Anodized Finish

3915086 • 2005-2013 C6 CORVETTE

REDUCED SHIFT THROW BY OVER 25%

3915085 • 1997-2004 C5 CORVETTE

REDUCED SHIFT THROW BY OVER 25%

FEATURES & BENEFITS

- » Adjustable Positive Gear Stops to Help Prevent Internal Transmission Damage
- » Self-Centering Alignment for Improved 2nd to 3rd Upshift Gear Changes
- » Threaded Handle Designed to Fit Original Knob for a Stock Factory Look
- » CNC-Machined, 6061-T6 Billet Aluminum Base and Top Plate
- » Reduced Shift Throw by Over 25%



BILLET/PLUS®

Dodge Challenger

3916020 • 2009-2018 CHALLENGER

CLASSIC CHROME STICK W/ WHITE SHIFT KNOB

Prior to Dodge releasing the manual version of the Challenger, the executives and engineers in the SRT division turned to Hurst for a suitable performance shifter option. They knew that Hurst designed the original pistol grip shifter that was in the Challengers of the 1970s and who better to offer guidance on these new vehicles than Hurst? Months of field and durability testing resulted in the shifter offered today: a masterpiece of over 20 design iterations and improvements.

3916120 • 2009-2018 CHALLENGER

BLACK PISTOL-GRIP HANDLE FOR MODERN LOOK

FEATURES & BENEFITS

- » CNC-Machined, 6061-T6 Billet Aluminum Carrier
- » Billet Stainless Steel Adapter Block Allows Stock Handle/Stick or any Hurst Upper Stick
- » Teflon Lined Spherical Bearing Main Pivot Ensures Smooth Shifting and Reduced Wear
- » Heat-Treated Billet Chrome-Moly Gear Selector for Ultimate Strength
- » Full Isolation Design and Urethane Mounting Bushings
- » Reduced Shift Throw by Over 30%

1531001 • 2015-2018 CHALLENGER

BLACK PISTOL GRIP HANDLE FOR STOCK SHIFTER

Swap out the stock shift knob on your modern Challenger for this black anodized pistol-grip. Made from CNC-machined billet aluminum, this shifter handle is a bolt-on replacement specifically designed for the 2015-2017 Dodge Challenger.



BILLET/PLUS®

Ford Mustang

3915201 • 2005-2010 MUSTANG

REDUCED SHIFT THROW BY OVER 30%

With the success of other Hurst Billet/Plus Shifters in other modern muscle car applications, the Hurst engineers went back to the drawing board to update, advance, and apply what they had learned. The pony car that started it all in the sixties and once again re-started the retro-muscle-car movement in 2004 & 2005. The very retro and very cool Mustang GT needed to have the very best Hurst had to offer: the Billet/Plus Shifter. Like nothing else, the Hurst Billet/Plus Shifter harkens back to the Mustangs that started it all. With adjustable shift stops and a high-strength steel stick, this shifter will get you through the gears and down the track in short order with all the style, class, and heritage only Hurst can supply.

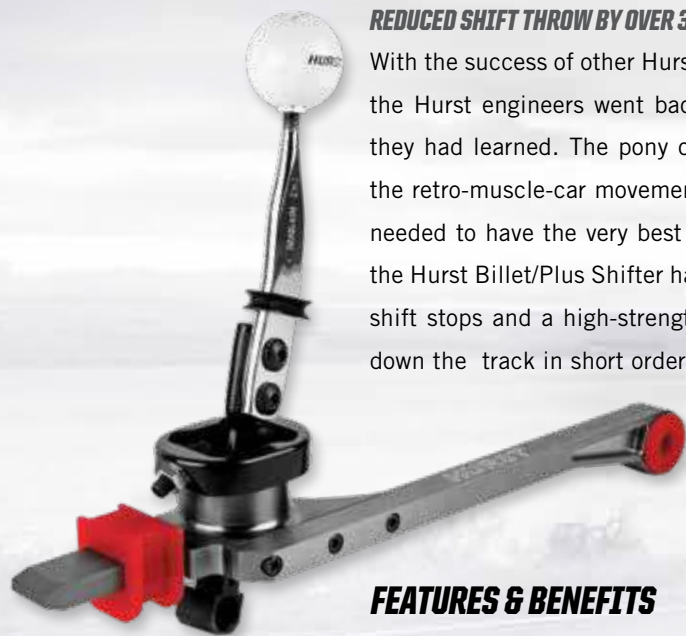

FEATURES & BENEFITS

- » CNC-Machined Mil-Spec Anodized 6061-T6 Aluminum Carrier and Pivot Housing
- » Smooth, Precise Teflon® Lined Steel Spherical Bearing
- » Solid, Positive, and Quick Shift Throws that are Reduced by Over 30%
- » High Durometer Polyurethane Bushings Front/Rear for a Solid and Sturdy Shifting Platform
- » Classic Interchangeable Hurst Chrome Stick and White Knob

3915035 • 2001-2004 MUSTANG

REDUCED SHIFT THROW BY OVER 35%

This Hurst Billet/Plus Shifter incorporates a high ratio pivot mechanism for reduced shifter throw and is sturdily constructed for a more positive precise feel when shifting. Self centering alignment improves 2nd to 3rd up-shift gear changes to reduce the chance of "missed shifts". Patented, adjustable bias spring loads allow stick tension to be tailored to the driver's preference. Direct bolt-in replacement ensures a custom fit and eliminates any vehicle modifications for ease of installation and accepts factory knobs.

FEATURES & BENEFITS

- » CNC-Machined, 6061-T6 Billet Aluminum Base and Stop Collar
- » Heat-Treated, Billet Steel Gear Selector for Ultimate Strength
- » Adjustable Positive Gear Stops to Help Prevent Internal Transmission Damage
- » Stainless Steel Rotating Pivot Ensures Smooth Shifting and Reduced Wear

**BILLET/PLUS®**

Mustang / T-Bird / Cougar / Ranger

3915033 • 1983-2004 MUSTANG V8/V6

REDUCED SHIFT THROW BY OVER 30%

Get all the benefits of Hurst's modern Billet/Plus Shifter for your SN-95 Mustang and get the classic Hurst look. The flat, chrome Hurst stick and white Hurst 5-speed knob command the T-45 or T-5 through the gears with a crisp, clean "snap" that only a Hurst shifter can provide. Solid shift feel, positive gear engagement, and quick smooth shifting... That's what a Hurst shifter is all about!



3915031 • 1983-2001 MUSTANG, 1983-1991 THUNDERBIRD/COUGAR

REDUCED SHIFT THROW BY OVER 30%

This shifter provides top race teams and racers with a no-compromise direct link to the transmission. Smooth, slick shifting with complete and positive gear engagement makes driving not only more enjoyable but will improve lap/track times. For all of those hot rod and custom builders out there who are using a T-45 or T-5 out of a donor Mustang – this shifter is the perfect choice. This shifter will work beautifully with any of the Hurst bolt-on upper sticks listed on pages 49-53 – all thanks to the standard Hurst "stub-stick" bolt-on design.



3915020 • 1988-2011 RANGER

REDUCED SHIFT THROW BY OVER 25%

Let's face it: the Ford Ranger is a whole lot of truck for the money – but the shifter could use some help. The Hurst engineers didn't cut any corners on this one. It has all the same materials, construction, and features that go into a high-dollar supercar shifter, along with the classic Hurst look of the flat chrome stick, floor mounted boot, and black Hurst 5-speed knob.

FEATURES & BENEFITS

- » CNC-Machined, 6061-T6 Billet Aluminum Base and Stop Collar (3915033 & 3915031) or Top Plate (3915020)
- » Heat-Treated, Billet Steel Gear Selector for Ultimate Strength
- » High-Strength, Chrome-Plated Steel Upper Stick - Not a Casting
- » Stainless Steel Rotating Pivot Ensures Smooth Shifting and Reduced Wear
- » Polyamide Pivot Cup Retains Centering Spring Assembly for Increased Centering Force
- » Self-Centering Alignment for Improved 2nd to 3rd Upshift Gear Changes
- » Exclusive Oil Control Seal Eliminates Transmission Fluid Loss and Protects from Contamination



COMPETITION/PLUS®

Ford Mustang

3916037 • 2015-2018 MUSTANG

REDUCED SHIFT THROW BY 38%

The latest Mustang not only looks great, but now handles even better. It is just as appropriate that the Hurst Competition/Plus Short Shifter for the 2015-2018 Mustang GT functions even better as well.

This Hurst Competition/Plus shifter utilizes a multi-link-type mechanism that allows 38% throw reduction while maintaining factory geometry, alignment, and side-to-side resolution. Positioned in-line with the classic Hurst chrome plated flat blade stick is a chrome plated trigger rod. This trigger rod not only functions as part of the reverse lockout feature, but truly adds style points to the interior.

FEATURES & BENEFITS

- >> 38% Throw Reduction
- >> New Multi-Link Shifter Design
- >> Trigger Operated Reverse Lockout
- >> Classic Hurst Styling

CLASSIC WHITE SHIFT KNOB

FLAT-BLADE BOLT-ON STICK

Chrome-Plated Steel

PULL-UP CHROME-PLATED TRIGGER ROD

REVERSE LOCK-OUT COLLAR

Prevents the Chance of
Accidentally Going into Reverse

LOWER STICK

4140 Alloy with Black E-Coat

IGUS BEARINGS

Prevents Wear Between
Moving Parts, Lubrication Free



COMPETITION/PLUS®

Iconic Manual Shifters

The industry standard for over 50 years. Most popularly known as the go-to shifter for classic 4-speed models, the Competition/Plus lineup has expanded to cover modern Mustangs as well. Just like the classic versions, these modern Competition/Plus shifters are vehicle specific, requiring no modification for installation. Through careful engineering and high quality components, these shifters can reduce a Mustang's shift throw by over 30%, allowing for faster and more precise gear changes. These modern shifters still feature all the cool, classic styling that Hurst is known for, with their chrome flat-blade sticks and white ball shift knobs.

COMPETITION/PLUS®

Ford Mustang



3916039 • 2011-2014 MUSTANG

REDUCED SHIFT THROW BY 18%

Hurst's new Competition/Plus shifter for the 2011-2014 Mustang GT, Boss 302 and Base V6 reduces throw reduction by 18% over the stock shifter. Features include a new billet aluminum base housing, a spherical pivot bearing with Delrin support ring to reduce vibration and noise transmitted through the shifter from the transmission, and also a trick looking mini T-handle that actuates the reverse lock-out to ensure you don't accidentally shift into reverse when you want first gear. Simple to install and includes a chrome flat blade Hurst stick and classic white 6-speed knob to give your Pony's interior that racing look and feel it deserves.

FEATURES & BENEFITS

- » CNC-Machined, 6061-T6 Billet Aluminum Shifter Housing
- » High-Strength, Chrome-Plated Steel Upper Stick
- » Solid Plate Steel Base Construction
- » E-Coated, Billet Steel Gear Selector for Ultimate Strength

3910201 • 2005-2010 MUSTANG

REDUCED SHIFT THROW BY OVER 30%

The Hurst Competition/Plus shifter for your 2005-2010 Mustang reduces shift throw by 30%. Features include a spherical pivot bearing, urethane bushings front and rear, chrome stick and white knob.

FEATURES & BENEFITS

- » High Ratio Pivot Mechanism
- » Chrome Plated Steel Bolt On Stick
- » No Modifications Necessary
- » Easy Installation



COMPETITION/PLUS®

4-Speed Manual Shifters

CLASSIC WHITE SHIFT KNOB
Instantly Recognizable Iconic Style

HIGH STRENGTH CHROME PLATED STEEL
Forged, Not a Casting

STAMPED HURST LOGO

2 BOLT CONNECTION SYSTEM
Accepts any Hurst Shifter Stick

HIGH RATIO PIVOT MECHANISM

ADJUSTABLE STOPS
For Hard Shifts

ADJUSTABLE BIAS SPRING LOADS

THE INDUSTRY STANDARD FOR OVER 50 YEARS

Competition/Plus – The benchmark of transmission control since 1965. Such a solid design from its inception, the Competition/PLUS shifter you can buy today is built from the same drawings, tooling design, and material specifications as it was over 50 years ago. With a wide array of custom applications, these shifters will bolt into OEM consoles with no modifications required.

Designed for short, precise throws between gears, the Competition/Plus provides unparalleled shift quality and feel. Every Competition/Plus shifter can be paired with Hurst's heat-treated linkage rods and arms (Linkage Kit) for track-worthy durability. Adjustable shift stops help prevent overshifts and possible transmission damage.

Features such as the chrome-plated stick and classic white Hurst shift knob assure the fit and finish are up to the standards of any car in which this shifter might be installed.



COMPETITION/PLUS®

4-Speed Manual Shifters



3910002 3913180 3918014 3913780 3918794



3914339 3916790 3916848 3917307 3917308



3917960 3917992 3917535 3918791 3917438

COMPETITION/PLUS® + BILLET/PLUS®

Application Chart

BUICK	YEAR	DESCRIPTION	TRANSMISSION	BILLET/PLUS	COMP/PLUS	LINKAGE	NOTES	
Grand Sport	1966-1967	With/without console	Saginaw (441)		3917307	3734297		
	1965	With/without console	Muncie (451)		3917308	3733163		
	1965	With/without console	Muncie (451)		3917308	3733163		
Skylark	1965	With/without console	Muncie (451)		3917308	3733163		
Special	1966-1967	With/without console	Saginaw (441)		3197307	3734297		
CHEVROLET								
Full Size	1963-1964	With/without console	Muncie (451)		3917308	3733163		
	1960-1963	With/without console	BW T-10 (410)		3917308	3734734		
	1958-1959	All	BW T-10 (410)		3917307	3733157		
	1955-1957	All	BW T-10 (410)		3913780	3734734		
			Richmond/BW T-10 (454)		3913780	3738609		
			Muncie (452/453)		3913780	3737834		
			Saginaw (441)		3913780	3737919		
			Muncie (451)		3913780	3733163		
	Camaro	2016-2018	V8 Engine		3916031			Chrome Stick w/White Hurst Knob
		2016-2018	V8 Engine		3916131			Black Pistol Grip
2016-2017		I4/V6 Engine Type LT		3916034			Black Pistol Grip	
2010-2015		V6/V8 Engine		3916030			Chrome Stick w/White Hurst Knob	
1993-2002		V8 Engine		3915060			Fits Stock Knob Only	
1993-2002		V8 Engine		3915061			Chrome Stick & Black Knob Only	
1974-1981		Without console	Richmond/BW T-10 (454)		3918794	3738609		
		With console	Richmond/BW T-10 (454)		3918791	3738609		
1973-1977		With console	Saginaw (441)		3917438	3738607		
1973-1974		With console	Muncie (453)		3918791	3738605		
1970-1972	With/without console	Muncie (453)		3916848	3737897			
1969	With/without console	Muncie (452)		3917438	3737437			
1967-1968	With/without console	Saginaw (441)		3914339	3734531			
		Muncie (451)		3914339	3734529			
Chevelle & Malibu	1973-1974	With/without console	Muncie (453)		3916848	3737897		
	1969-1972	With/without console	Muncie (452/453)		3918014	3737834		
	1968	With/without console	Muncie (451)		3918014	3733163		
	1966-1967	With/without console	Saginaw (441)		3917307	3734297		
	1964-1967	With/without console	Muncie (451)		3917308	3733163		
Chevy II & Nova	1971-1973	Without console	Muncie (453)		3916848	3737834		
	1969-1970	Without console	Muncie (452)		3916848	3737131		
	1968	With console	Muncie (451)		3914339	3734529		
	1968	Without console	Muncie (451)		3916848	3734529		
Chevy II & Nova	1965-1967	With/without console	Muncie (451)		3917308			
	1964	With/without console	Muncie (451)		3917308	3733163		
Corvette	2014-2018	V8 Engine		3916042			Black Pistol Grip	
	2005-2013	V8 Engine		3915086				
	1997-2004	V8 Engine		3915085				
	1969-1979	All	Muncie (452/453) & BW (454)		3917992	3738611		

Application Chart

CHEVROLET	YEAR	DESCRIPTION	TRANSMISSION	BILLET/PLUS	COMP/PLUS	LINKAGE	NOTES
Corvette	1968	All	Muncie (451)		3917992	3734648	
	1963-1967	All	Muncie (451)		3917960	3733162	
	1957-1962	All	BW T-10 (410)		3917535	3733157	
El Camino	1969-1972	With/without console	Muncie (452/453)		3918014	3737834	
	1968-1972	With/without console	Saginaw (441)			3737919	
	1968	With/without console	Muncie (451)		3918014	3733163	
	1966-1967	With/without console	Saginaw (441)		3917307	3734297	
	1964-1967	With/without console	Muncie (451)		3917308	3733163	
	1959	All	BW T-10 (410)		3917307	3733157	
	1978-1980	With/without console	Saginaw (441)		3918794		
Monte Carlo	1974	With console	Muncie (453)		3916848	3737897	
	1970-1972	With/without console	Muncie (452/453)		3918014	3737834	
		Custom install on pass car trans.	Muncie (451)		3910002	3733163*	
1/2 Ton Chevy / GMC Pickups			Muncie (452/453)		3910002	3737834*	
			Richmond/BW T-10 (454)		3910002	3738609*	
			BW T-10 (410)		3910002	3734734*	
			Saginaw (441)		3910001	3737919*	
CHRYSLER							
Full Size	1966-1967	With console	New Process (422)		3916790	3734089	
	1964-1967	Without console	New Process (422)			3734089	
Dodge Challenger	2009-2018	V8 Engines		3916020			Chrome Stick w/ White Knob
	2009-2018	V8 Engines		3916120			Black Pistol Grip
Charger	1966-1972	Without console	New Process (422)		3916789	3734089	
	1966-1969	With console	New Process (422)		3916790	3734089	
Coronet & Super Bee	1965-1972	With console	New Process (422)		3916789	3734089	
	1965-1969	With console	New Process (422)		3916790	3734089	
Full Size	1965-1969	With console	New Process (422)		3916790	3734089	
FORD							
Fairlane & Torino	1972-1973	With/without console	Ford T & C (433)		3913180	3735587	
	1970-1971	With/without console	Ford T & C (433)		3913180	3737638	
	1966-1969	With/without console	Ford T & C (433)		3913180	3737638	
Falcon	1966-1967	8 Cyl. With/without console	Ford T & C (433)		3913180	3737638	
Mustang	2015-2018	V8, V6, 4 cyl. Ecoboost w/ console	Getrag MT82		3916037		See pg. 44 for New Indy Shifter
	2011-2014	V6/V8 Engines			3916039		
	2005-2010	V8 Engines	Tremec		3910201		
		V8 Engines			3915201		
	2001-2004	V8 Engines			3915035		Fits Stock Knob Only, Fits T-5/T-45 Trans
	1983-2004	V6 Engines			3915033		Chrome Stick & White Knob Only
	1983-2004	V6 Engines			3915031		Fits Stock Knob Only

Application Chart

FORD	YEAR	DESCRIPTION	TRANSMISSION	BILLET/PLUS	COMP/PLUS	LINKAGE	NOTES
Mustang	1983-2001	V8 Engines		3915033			Chrome Stick & White Knob Only
		V8 Engines		3915031			Fits Stock Knob Only
	1987-1992	With/without console	BW T-5 (465)		5380036		
	1970-1973	302, 351 V-8 Engines					
		With/without console	Ford T & C (432)		3913180	3737637	
	1967-1969	390, 428, 429 V-8 Engines					
	With/without console	Ford T & C (433)		3913180	3735587		
	1965-1969	289, 302, 351 V-8 Engines					
	With/without console	Ford T & C (432)		3913180	3737637		
Shelby Mustang GT-500	1967-1969	With/without console	FORD T & C (433)		3913180	3735587	
Shelby Mustang GT-350	1965-1969	With/without console	BW T-10 (413)		3913180		
Ranchero	1972-1973	6 & 8 Cylinder Engines					
		With/without console	Ford T & C (433)		3913180	3735587	
	1970-1971	With/without console	Ford T & C (433)		3913180	3737638	
	1966-1969	8 Cyl. Engines With/without console	Ford T & C (433)		3913180	3737638	
Ranger	1988-2011	V6/4 cyl Engines		3915020			Fits M5od Transmission
Thunderbird	1983-1991	V6/V8		3915031			Fits Stock Knob Only
MERCURY							
Comet & Cyclone	1966-1969	With/without console	Ford T & C (433)		3913180	3737638	
Cougar	1983-1991	V6/V8 Engines		3915031			Fits Stock Knob Only
	1967-1969	289, 302, 351 V-8 With/without console	Ford T & C (432)		3913180	3737637	
	1967-1969	390, 428, 429 V-8 With/without console	Ford T & C (433)		3913180	3735587	
OLDSMOBILE							
F-85	1966	Without console	Muncie (451)		3917308	3733163	
	1964-1965	With/without console	Muncie (451)		3917308	3733163	
442	1978-1979	With/without console	Saginaw (441)		3918794		
	1966	Without console	Muncie (451)		3917308	3733163	
	1964-1965	With/without console	Muncie (451)		3917308	3733163	
Cutlass	1978-1979	With/without console	Saginaw (441)		3918794		
PLYMOUTH							
Belvedere & GTX	1965-1972	Without console	New Process (422)		3916789	3734089	
Roadrunner	1968-1972	Without console	New Process (422)		3916789	3734089	
PONTIAC							
Full Size	1960-1964	Without console	BW T-10 (410)		3917308	3734734	
Firebird	1993-2002	V8 Engines		3915060			Fits Stock Knob Only
Firebird	1993-2002	V8 Engines		3915061			Chrome Stick & Black Knob Only

Elite Series

Line/Loc

Manual Shifters

Automatic Shifters

Driveline Conversions

Accessories & Service Parts

Elite Series

Line/Loc

Manual Shifters

Automatic Shifters

Driveline Conversions

Accessories & Service Parts

COMPETITION/PLUS® + BILLET/PLUS®

Application Chart



PONTIAC	YEAR	DESCRIPTION	TRANSMISSION	BILLET/PLUS	COMP/PLUS	LINKAGE	NOTES
Firebird	1983-1992	V8 Engines		3915032			
Firebird	1983-2002	V6 Engines		3915032			
	1974-1981	With console	BW T-10 (454)		3918791	3738609	
	1974-1981	Without console	BW T-10 (454)		3918794	3738609	
	1970-1972	With/without console	Muncie (452/453)		3916848	3737897	
	1969	With/without console	Muncie (452)		3917438	3737437	
	1967-1968	With/without console	Saginaw (441)		3914339	3734531	
	1967-1968	With/without console	Muncie (451)		3914339	3734529	
G8	2009	V8 Engines		3916030			
Grand Prix	1978-1979	With/without console	Saginaw (441)		3918794		
G.T.O	2004-2006	V8 Engines		3915065			
	1964-1966	Without console	Muncie (451)		3917308	3733163	
Tempest & Le Mans	1978-1979	With/without console	Saginaw (441)		3918794		
	1966	Without console	Saginaw (441)		3914339	3734531	
	1964-1966	Without console	Muncie (451)		3917308	3733163	
Ventura II	1971-1973	Without console	Muncie (453)		3916848	3737834	
STUDEBAKER							
Hawk	1959-1964	With Bucket Seats	BW T-10 (410)		3917308	3734734	

COMPETITION/PLUS®

Linkage Kit Examples

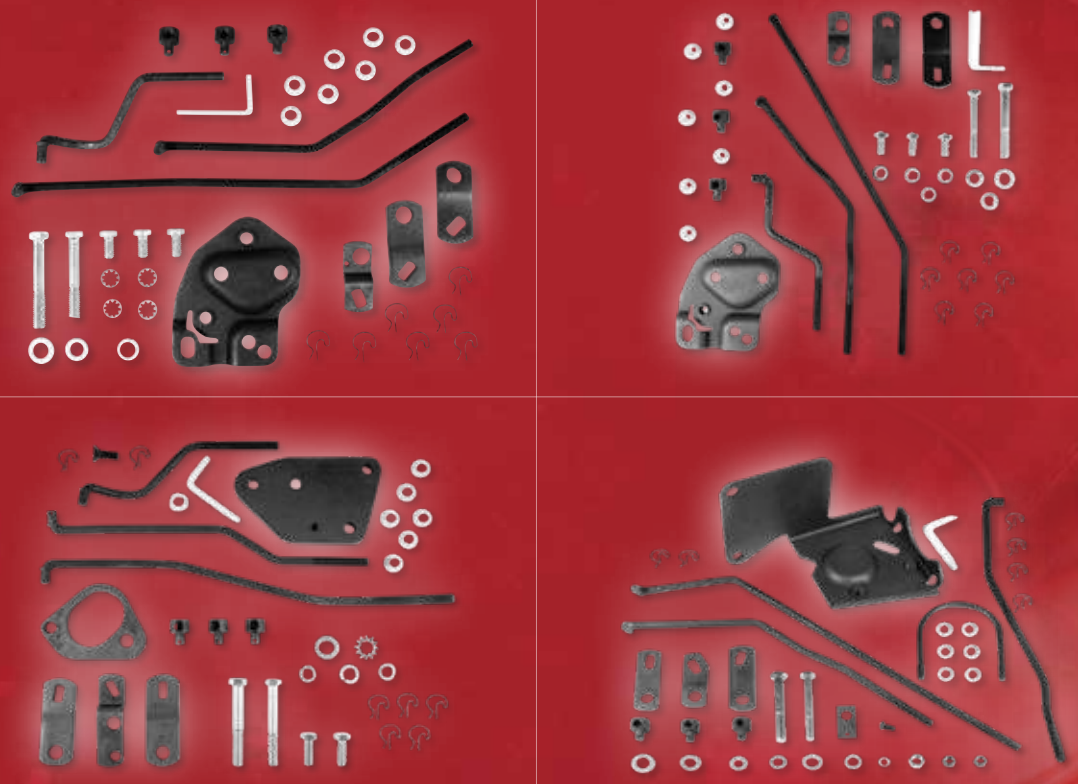

Elite Series

Line/Loc

Manual Shifters

Automatic Shifters

Driveline Conversions

Accessories & Service Parts

Elite Series

Line/Loc

Manual Shifters

Automatic Shifters

Driveline Conversions

Accessories & Service Parts

STREET SUPER SHIFTER™

4-Speed Manual Shifters

ABOUT THE STREET SUPER SHIFTER

Based on the racing version of the legendary Super Shifter 3, using the straightforward, logical engineering for which Hurst is famous for. The result is the ultimate in performance, feel, dependability, and value. The Street Super Shifter comes complete with all necessary hardware and an easy-to-follow installation guide. PLEASE NOTE: These shifters are not vehicle specific, therefore stock consoles cannot be used, and minor floor pan modifications are generally required.

MORE POSITIVE SHIFTS >> High-Mounting Design Allows Linkage to Run Level & Straight, Making the Assembly Stronger

FOR A SHORT THROW >> 7-1/2" Tall Chrome-Plated Stick & (3/8-16 Thread) 4-3/4" Knob Travel Between Gears

RACE-LEVEL SPECIFICATIONS >> On Materials & Heat-Treatment Ensure Highest-Quality Assembly

PREVENT OVERSHIFTS >> With Adjustable Gear Stops

TRANSMISSION	SHIFTER	LINKAGE
Muncie (451,452,453)	3917535	3738616
BWT-10 (410)	3917535	3738616
Richmond / BW Super T-10 (454)	3917535	3738616
Ford T&C (432,433)	3917535	3738615

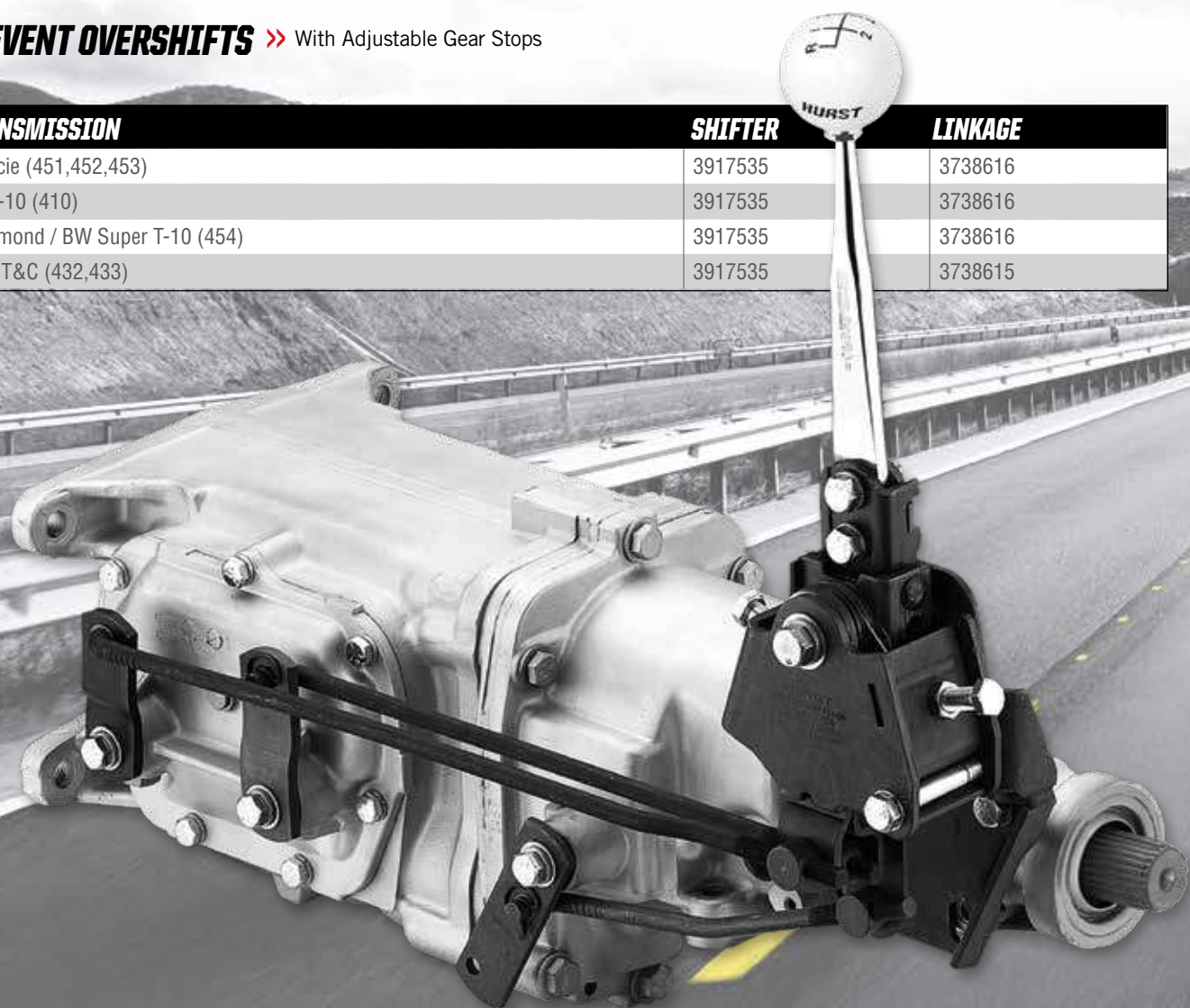

MASTERSHIFT™

3-Speed Manual Shifters

ABOUT MASTERSHIFT SHIFTERS

Hurst Mastershift – Timeless innovation and quality. Production of the original Hurst 3-speed shifter started in Glenside, Pennsylvania in late July of 1960. The Mastershift is built to the same strict quality standards of the Hurst 4-speed line. These shifters are still popular as both replacement floor shifters and column shift conversions.

BUICK	YEAR	DESCRIPTION	TRANSMISSION	SHIFTER	LINKAGE
Gran Sport/Special	1966-1967	6 & 8 Cylinder w/out console	Saginaw (343)	3667271	3670010
CHEVROLET					
Chevelle	1966-1974	6 & 8 Cylinder w/out console	Saginaw (343)	3667271	3670010
Truck	1969-1987	All 1/2 & 3/4 ton 2WD, Blazer, Suburban	Saginaw (343)/ Muncie (351)	3666809	3670006
FORD					
Bronco	1966-1977	8 Cylinder Only	Ford T & C (333)	3666901	-----
Pick-Up 1/2 Ton	1963-1987	All 2 Wheel Drive*	Ford (333)	3666809	3670027
Mustang	1965-1973	289, 302,351, V8 w/ console	Ford T & C (336)	3663179	3677640
Mustang	1965-1973	6 Cyl. w/ or w/out console	Ford (336/337)	3663179	3677640
MERCURY					
Cougar	1967-1969	289, 302,351 & V8 w/ or w/out console	Ford T & C (336)	3663179	3677640
Meteor	1963	8 Cyl. w/out console	Ford T & C (333)	3663179	3677640
OLDSMOBILE					
Cutlass F-85 & 442	1966-1972	6 & 8 Cyl. w/out console	Saginaw (343)	3667271	3670010

*Modification to catalytic converter bracket may be necessary if vehicle is so equipped

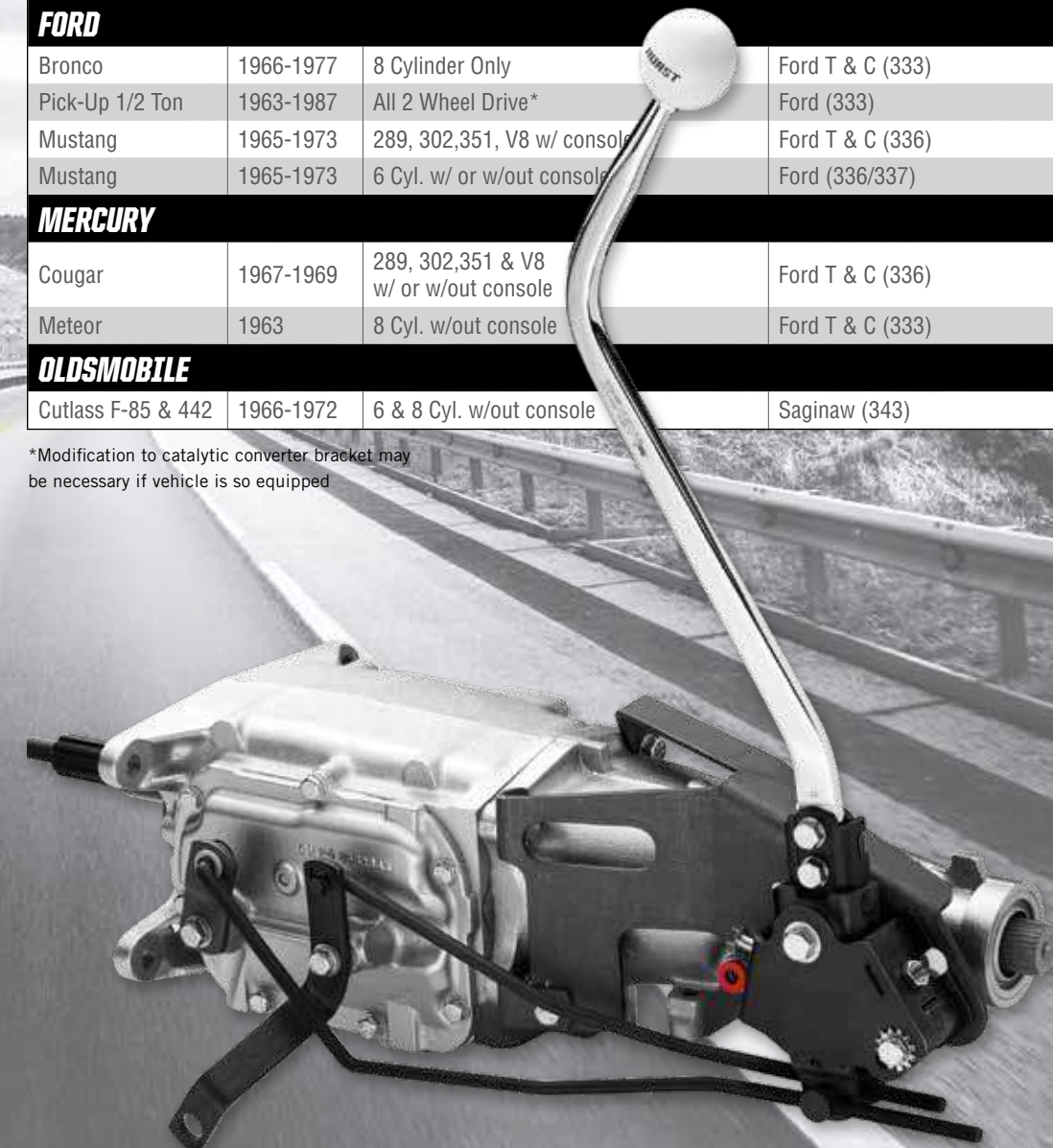

INDY SHIFTER®

Ford Mustang

INDY SHIFTER®

3 & 4-Speed Manual Shifters

Elite Series

Line/Loc

Manual Shifters

Automatic Shifters

Driveline Conversions

Accessories & Service Parts

Elite Series

Line/Loc

Manual Shifters

Automatic Shifters

Driveline Conversions

Accessories & Service Parts



3916036 • 2015-2018 MUSTANG

REDUCED SHIFT THROW BY 18%

Hurst introduces their new manual Indy shifter for 2015-2017 Ford Mustang models with MT-82 6-Speed transmission. This includes models with the 5.0L, 2.3L and 3.7L engines. As an Indy model, this shifter provides a noticeable amount of throw reduction and a firmer, crisper feel, all while retaining the factory reverse lockout collar and function. This shifter includes a replacement stick, reverse lockout slider, urethane rear mount and a classic black Hurst round ball knob.

FEATURES & BENEFITS

- >> CNC-Machined Billet Steel Parts
- >> 18% Shift Throw Reduction
- >> Classic Hurst Black Shift Knob
- >> Accommodates Factory Reverse Lockout

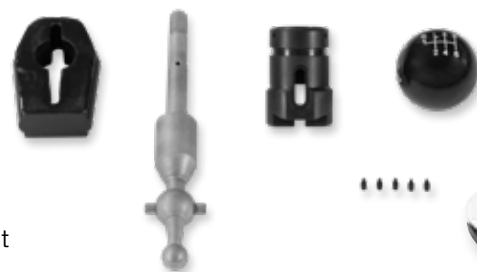

INDY 6-SPEED SHIFTER	YEAR	PART #
Ford Mustang (I4, V6 & V8 Models)	2015-2018	3916036

ABOUT HURST INDY UNIVERSAL SHIFTERS

Indy 3 and 4-speed shifters deliver quality components and accurate shifting at an incredible value. Do you have an older 3-speed pickup or car that could use some help when it comes to selecting gears? Or perhaps a 4-speed Muncie or Borg Warner T-10 and the shifting is feeling a little tired? These kits are for you. All kits come complete with required hardware, linkage, and easy-to-follow instructions. An Indy shifter kit will have you smoothly shifting and back to enjoying the ride in no time. The Indy 3-speed kits, used for both replacement shifters and column conversions, are engineered to fit specific transmissions, and can be adapted to many floor pans. Indy 4-speed kits: fitment for most popular vintage 4-speed transmissions: Muncie M-20, M-21, M-22, Borg Warner T-10, and Super T-10.

INDY UNIVERSAL 3-SPEED APPLICATIONS	YEAR	PART #
Buick*	1964 & Later	5010002
Chevrolet-Standard & H.D. 6 & 8 cylinder	1955 & Later	5010002
Chevelle, Camaro, Chevy II	1962 & Later	5010002
Oldsmobile-Standard & Intermediates*	1949 & Later	5010002
Pontiac-Standard & H.D.*	1958 & Later	5010002
Pontiac Firebird, Tempest & LeMans	1964 & Later	5010002
Chrysler, Plymouth, Dodge Standard & Intermediate (except Duster, Demon, & Challenger - not for trucks)	1957 & Later	5010002
Ford & Mercury Standard	1949 & Later	5010002
Fairlane, Montego, Torino, Meteor, Falcon, & Comet	1962 & Later	5010002
INDY PICKUP 3-SPEED APPLICATIONS (TALL)		
All GM two-wheel drives with Saginaw, Muncie & Tremec Transmissions	1969 & Later	5010016
All Ford two-wheel drives with Ford & Tremec Transmissions	1963 & Later	5010016
INDY PICKUP 4-SPEED APPLICATIONS (SHORT)		
Muncie (451, 452 & 453), BW T-10 (410, 454), Super T-10 AS3 & AS9		5030030

*Will fit all 6 cyl., HD and standard 3-speed transmissions except selector type gear boxes (single shaft). Certain applications require a great deal of modification to make shifter fit.

NITRO STICKS™

For Hurst Manual Shifters



ILLUMINATING RED LED PRECISION SWITCH » For Convenient Control of any Auxiliary Unit Including a Hurst Line/Loc, Transmission-Brake, or Nitrous

MILITARY SPEC. » Clear or Black Anodized Finish with Engraved Hurst Logo

FIRM, NATURAL, COMFORTABLE » Engineered to Provide a Firm, Natural, Comfortable Grip When Shifting

AEROSPACE QUALITY » CNC-Machined 6061-T6 Aluminum Construction

Don't be afraid to push the **RED BUTTON!**

ABOUT HURST NITRO STICKS

After development of the Hurst Pistol-Grip Quarter Stick for automatic transmissions, the engineers at Hurst believed that the same style handle and durable switch should be available for those with manual transmissions. This time the switch was specified to be made completely out of aluminum for added strength, with an illuminating ring surrounding the button for added visibility, and a flip-cap design on the stick to avoid accidental activation of the auxiliary unit. The handle is CNC-machined from billet 6061-T6 aluminum for exceptional strength and is contoured just like the Quarter Stick Pistol-Grip for ergonomics. The precision switch has been chosen for its strength and durability, and is simply integrated at the top of the handle for convenient control of any auxiliary unit. Fits on any Hurst Competition/Plus or Billet/Plus Shifter with the standard 2-bolt connection.

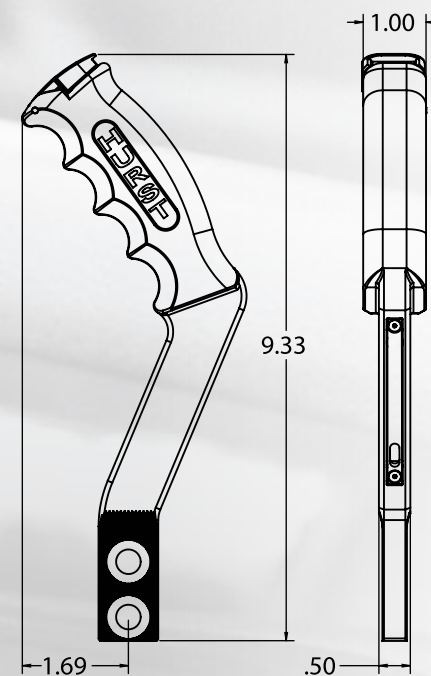

FINISH	PART #
Black Anodized	5381001
Clear Aluminum Anodized	5381000



SHIFTER STICKS

Flat & Round Bar

ABOUT HURST SHIFTER STICKS

Available in both round and flat bar styles, Hurst bolt-on shifter sticks are ideal for use in custom applications where a particular height or offset is required. These shifter sticks are constructed from high strength, chrome plated steel and are stamped with the Hurst name and feature 3/8 - 16 threads. Can be used on any Hurst two bolt style shifter assembly. Please refer to drawing/diagram for ideal application.



FLAT BAR STYLE

Shifter Sticks

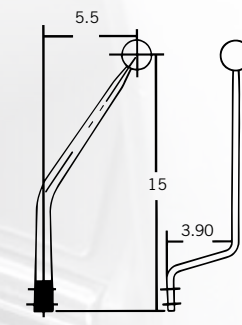

5384084
Used on shifter
3916790

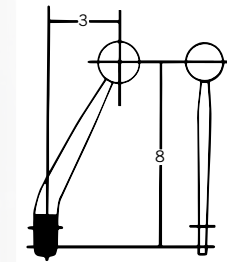

5380015
Used on shifters
3918790, 3660005

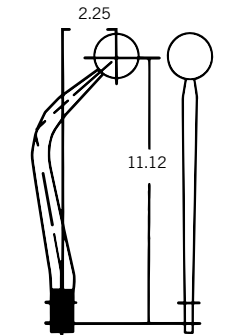

5387236
Used on shifters
3917308, 3917307,
3917930, 3667271

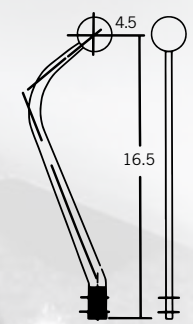

5384331
Used on shifters
3910002, 3666809

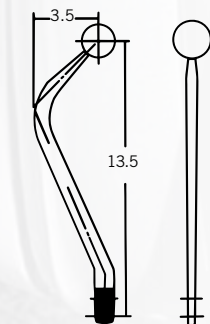

5386900
Used on shifters
3666901, 3918403,
3918404, 3915045

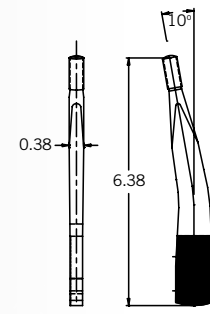

5387201
Used on shifters
3916030, 3915201,
3910204, 3910205

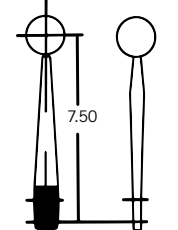

5387238
Used on shifters 3917535,
3915061, 3917960,
3916020

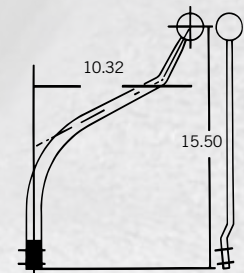

5384078
Used on shifter
3916789

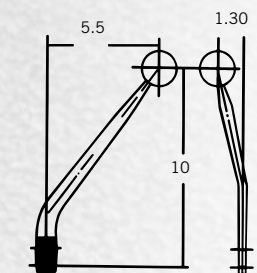

5384106
Used on shifters 3914339,
3917879, 3664550

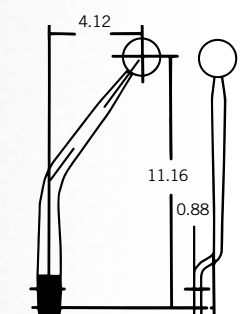

5386836
Used on shifters 3916822,
3917072, 3916848

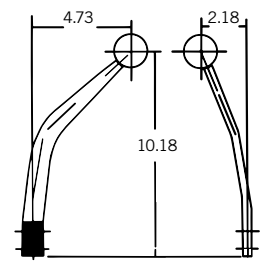

5387436
Used on shifters
3917438, 3667954

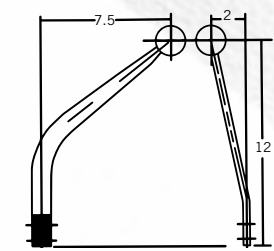

5388022
Used on shifter
3668034

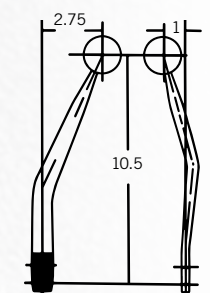

5388009
Used on shifters 3918014,
3918791, 3918794

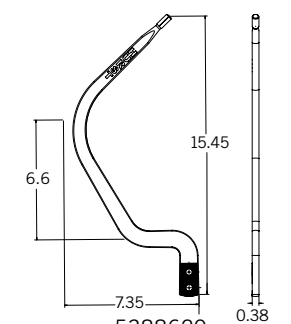

5388620
Bench seat stick for
custom installation

Elite Series

Line/Loc

Manual Shifters

Automatic Shifters

Driveline Conversions

Accessories & Service Parts

Elite Series

Line/Loc

Manual Shifters

Automatic Shifters

Driveline Conversions

Accessories & Service Parts

ROUND BAR STYLE

Shifter Sticks

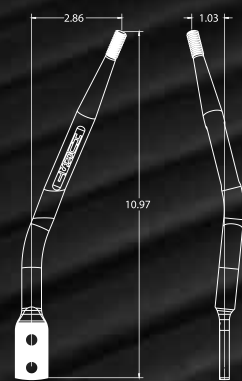
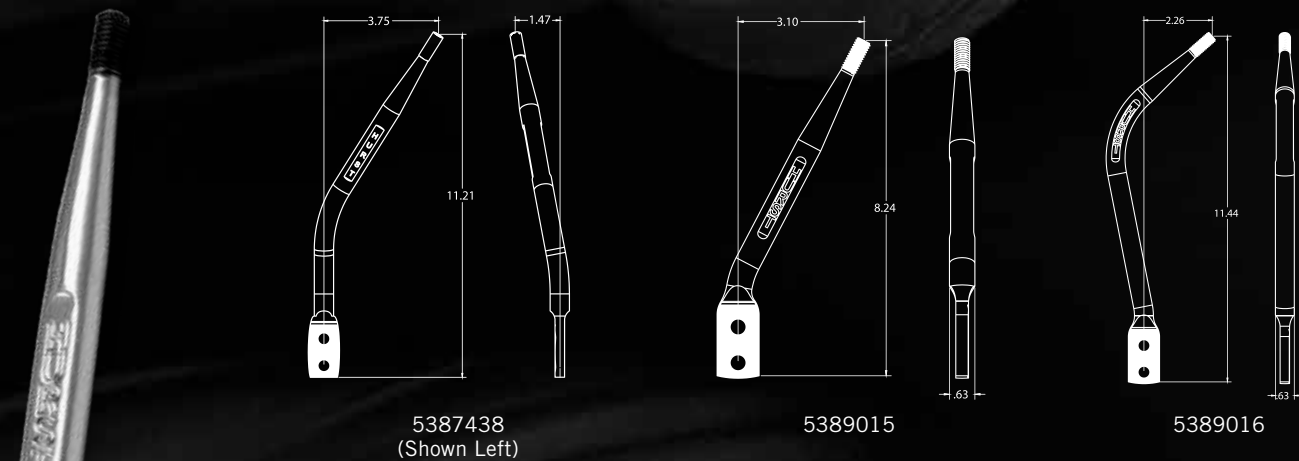

5389017



COMP STICK KIT • PART #5380036

1987-1993 FORD MUSTANG WITH T-5 MANUAL TRANSMISSION

The Comp Stick Kit fits the stock OEM shifter mechanism and the aftermarket Hurst Competition/Plus shifter mechanism. Kit consists of a white shift knob with gear shift pattern, chrome-plated flat shifter stick, rubber vibration isolator, shifter boot, and console top plate with the famous Hurst shifter logo.



PISTOL-GRIP™

Shifter Sticks

AN ICON IS REBORN

From an original Challenger or Barracuda equipped with a Hurst Competition/Plus to a modern, brand-new Challenger equipped with a Hurst Billet/Plus, these handles just bolt on! In 1970, Chrysler introduced the Dodge Challenger and Plymouth Barracuda models with a must-have option: The Hurst Pistol-Grip Shifter. It became an iconic feature of the Challenger and Barracuda, from the past all the way through today's new Challengers. Much of the same design and tooling that was used on the 1970 Challenger T/A & Plymouth 'Cuda AAR is used today to manufacture these reproduction Hurst Pistol-Grip handles and sticks. The same materials and construction methods are used but with one main difference – these reproduction handles incorporate Hurst's standard 2-bolt connection. These handles will fit on any Hurst aftermarket shifter that has a Hurst standard 2-bolt connection lower stick. Top of the handle features the Mopar 4-Speed pattern.

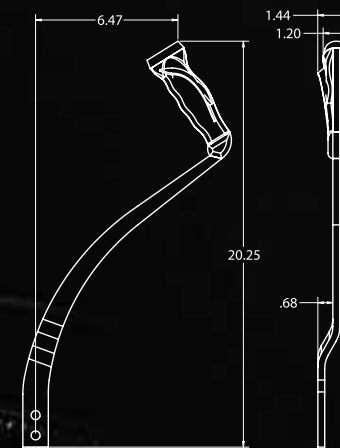

PART# 5388585

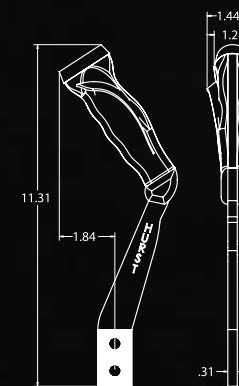

PART# 5388575



UNIVERSAL PISTOL-GRIP™

With Optional 12V Auxiliary Switch

ABOUT HURST UNIVERSAL PISTOL-GRIP HANDLES

The Hurst Pistol-Grip shifter handle is designed to provide a firm, comfortable, and natural grip when shifting. With such a good grip on the control of your transmission, the chances of missing a shift are greatly reduced. Military-specified, anodized surface treatment ensures a great-looking, durable, and long-lasting finish.



HANDLE W/ 12V SWITCH	PART#
Aluminum	1536200
Black Anodized	1536210
HANDLE ONLY	
Aluminum	1531000
Black Anodized	1536010

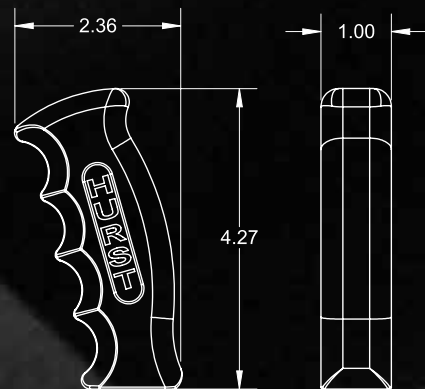

UNIVERSAL-FIT >> Multiple Thread Adaptors Included Complete with Adapters and Jam Nut: 3/8-16, 1/2-20, M10-1.25, M10-1.50, M12-1.25, M12-1.75, M16-1.50

MILITARY-SPECIFIED >> Military-Specified, Anodizing Surface Treatment

6061-T6 BILLET ALUMINUM >> CNC-Machined from Solid Billet 6061-T6 Aluminum

AUXILIARY SYSTEM CONTROL >> Switched Models Feature a Heavy-Duty 12V, 10A, Normally Open, Momentary Switch, Allowing for Control of Systems such as Line/Loc®, Nitrous, or a Transmission Brake.

UNIVERSAL T-HANDLE®

With Optional 12V Auxiliary Switch

ABOUT HURST T-HANDLES

The Hurst T-Handle is not only pleasing to the eye, but incredibly ergonomic. The length and contours of the handle allow for a firm grasp and confident shifts from gear to gear. For strength and durability, the Hurst T-handle is made of solid, die-cast aluminum. Optional button for use with nitrous oxide, Line/Loc®, trans brake or other 12V accessories.

- >> Die-Cast Aluminum Alloy
- >> Perfect, Ergonomic Grip
- >> Chrome, Brushed, or Polished Finish
- >> Complete with Adapters and Jam Nut
- >> Optional Button for 12V Accessories

THREAD SIZE

UNIVERSAL T-HANDLES	FINISH	PART #
SAE 3/8-16	Brushed	1535000
SAE 1/4-28, 5/16-18, 3/8-16, and 1/2-20	Chrome	1530032
SAE (including 3/8-24) and Metric*	Chrome	1530060
SAE and Metric*	Polished	1530040
SAE and Metric*	Brushed	1530020
T-HANDLE W/ BUTTON		
SAE and Metric*	Polished	1530011
SAE and Metric*	Brushed	1530010

* Includes SAE 3/8"-16, 7/16"-20, 1/2"-20, and Metric M10-1.25, M10-1.50, M12-1.25, M12-1.75, M16-1.50

4-SPEED HURST LOGO T-HANDLE PART# 1535000



Fits Hurst Comp Plus chrome-plated shifter sticks with 3/8-16 threads

SHIFT HANDLE THREAD SIZE CHART

HURST SHIFTER	THREAD	HURST SHIFTER	THREAD	OEM SHIFTER	THREAD
Aluminum sticks	7/16"-20	Indy Pick Up Truck	3/8"-24	Camaro 5/6-speed internal rail	16mm x 1.50
Auto/Stick 1	3/8"-16	Indy Qualifier	3/8"-16	With OEM stick	
Auto/Stick 3	3/8"-16	Indy SSA	3/8"-24	Firebird 5/6-speed internal rail	16mm x 1.50
Billet/Plus w/chrome stick	3/8"-16	Pro-Matic, before 1987	1/2"-13	With OEM stick	
Billet/Plus w/black stick	OEM	Pro-Matic 2, since 1987	3/8"-16	Mustang 5/6-speed internal rail	12mm x 1.75
Chrome replacement sticks	3/8"-16	Quarter/Stick and Q/S 2	7/16"-20	With OEM stick ('79-'04)	
Comp/Plus (early)	3/8"-24	Quick/Stick	OEM	Mustang '05-'10	12mm x 1.25
Comp/Plus (late), and OEM	3/8"-16	Super Shifter 3	3/8"-16	Corvette 6-speed 89-04	9/16"-18
Dual/Gate 2	3/8"-16	Vertical Gate, before 1987	1/2"-13	Viper	1/2"-20
Indy 3-speed	3/8"-24	V-Gate 2, since 1987	3/8"-16	B&M Shifters/Most automatic shifters	1/2"-20
Indy Matic 1	3/8"-24	V-Matic, before 1987	1/2"-13	Most automatic shifters	

CLASSIC HURST®

Shifter Knobs

ABOUT CLASSIC HURST SHIFTER KNOBS

The classic look and feel of the Hurst shift knob is still at the top of its game. Available in a wide variety of patterns and thread sizes, these knobs are sure to work with your application. They are incredibly tough and feel great in the palm of your hand because they are built from the same material generally used by billiard ball manufacturers. Whether you are rowing through the gears at the track or short shifting through town, a Hurst shift knob will enhance your driving experience, one gear at a time.



» **COMPLETE WITH JAM NUT**

» **MOULDED-IN-BRASS THREADED INSERT**

» **SOLID, HIGH-GLOSS, HIGH-STRENGTH POLYMER**

CLASSIC SHIFTER KNOBS WITH HURST LOGO

THREAD SIZE	DESCRIPTION	PART #	DIAM.
3/8-16 Threads	3-Speed, White	1637624	1.75"
3/8-16 Threads	4-Speed, White	1637626	1.75"
3/8-16 Threads	4-Speed, Black	1637627	1.75"
3/8-16 Threads	5-Speed, White	1630025	1.75"
3/8-16 Threads	5-Speed, Black	1630125	1.75"
3/8-16 Threads	6-Speed, White	1630185	1.75"
3/8-16 Threads	6-Speed, Black	1631040	1.75"
7/16-20 Threads	Quarter Stick, White	1631036	1.75"
7/16-20 Threads	Quarter Stick, Black, 12V Switch	1630050	1.75"
9/16-18 Threads, 1997-2004 Corvette C5	6-Speed, White	1630056	2.25"
9/16-18 Threads, 1997-2004 Corvette C5	6-Speed, Black	1630156	2.25"
12mmx1.25 Threads, 15-18 Mustang, 13-17 Focus ST, 16-17 Focus RS, 14-17 Fiesta ST	6-Speed, White	1630225	2.25"
12mmx1.25 Threads, 15-18 Mustang, 13-17 Focus ST, 16-17 Focus RS, 14-17 Fiesta ST	6-Speed, Black	1631225	2.25"
3/8-16, 1/2-20, M10x1.25, M10x1.50, M12x1.25, M12x1.75, M16x1.50	Hurst "H", White	1631401	1.75"

CLASSIC SHIFTER KNOBS WITHOUT HURST LOGO

THREAD SIZE	DESCRIPTION	PART #	DIAM.
3/8-16 Threads	4-Speed, White	1630003	1.75"
3/8-16 Threads	4-Speed, Black	1630103	1.75"
3/8-16 Threads	5-Speed, White	1630008	1.75"
3/8-16 Threads	5-Speed, Black	1630108	1.75"
3/8-16 Threads	6-Speed, White	1630040	1.75"
3/8-16 Threads	6-Speed, Black	1630140	1.75"
3/8-24 Threads	4-Speed, White	1630002	1.75"
7/16-20 Threads	5-Speed, White	1630004	1.75"
12mm x 1.75 Threads, 1979-2004 Mustang	5-Speed, White	1630014	2.25"
12mm x 1.75 Threads, 1979-2004 Mustang	5-Speed, Black	1630114	2.25"
16mmx1.50 Threads, 1993-2002 Camaro/Firebird	6-Speed, White	1630016	2.25"

SHIFTER BOOTS

For Hurst Shifters

INDY BOOT & PLATE • PART #1148429

A popular economy boot. Complete with chrome trim plate & mounting hardware. Measures 5-1/4" x 6-1/2" - 4 pleats



B-4 BOOT & PLATE • PART #1144580

Our most popular boot is adaptable to most shifter installations. Complete with chrome trim plate & mounting hardware. Measures 5-1/4" x 6-1/2" - 4 pleats

SUPER BOOT & PLATE • PART #1147494

Designed for large-hole shifter installations. Complete with chrome ID plate & mounting hardware. Measures 7-3/4" x 8-3/4" - 6 pleats

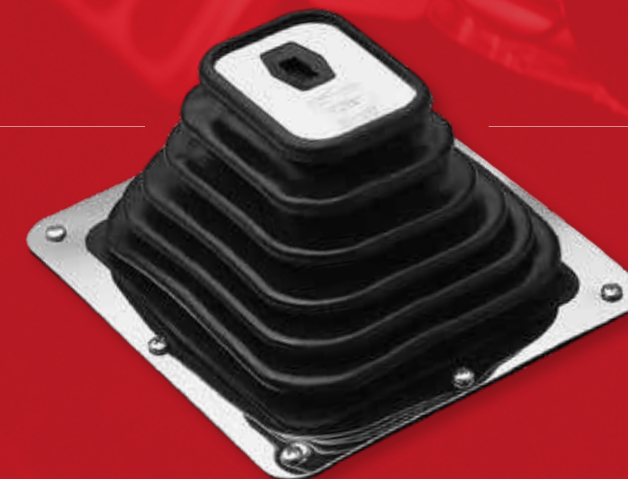

SUPER/SHIFTER 3 BOOT & PLATE • PART #1140010

Specially designed for use with Super/Shifter 3 utilizing separate reverse Loc/Out lever. Complete with chrome trim plate & mounting hardware. Measures 7-3/4" x 8-3/4" - 6 pleats

B-1 BOOT & PLATE • PART #1147336

Designed for use with round stick shifters. Complete with chrome ID plate & mounting hardware. Measures 4-3/8" x 5-3/8" - 3 pleats



AUTOMATIC SHIFTERS

- 54 Billet/Plus Pistol-Grip
- 55 Comp Stick Kit
- 56 Pro-Matic 2
- 57 V-Matic 3
- 58 Quarter Stick
- 59 Pistol-Grip Quarter Stick
- 60 Quarter Stick Accessories



BILLET/PLUS® PISTOL-GRIP

Automatic Shifter Handles

ABOUT BILLET/PLUS PISTOL-GRIP SHIFTER HANDLES

Hurst introduces their all new pistol-grip handle for automatic cars. This is a great way to add a classic performance look to your modern day muscle car. Billet Aluminum construction is precision CNC machined for a modern look and feel. The body features a polished finish, while the replaceable grip plates have a black anodized finish and display the iconic Hurst name. The grip features a comfortable shape that just feels "right" in your hand, along with a finger operated trigger mechanism for the lockout function.

FEATURES & BENEFITS

- » CNC-Machined 6061-T6 Billet Aluminum
- » Trigger Operated Lockout Function
- » Replaceable Black Anodized Grip Plates
- » Easy Bolt-On Installation

MAKE/MODEL	YEAR	PART#
Chevrolet Camaro	2016-2018	5380436
Chrysler 300C	2005-2014	5380439
Dodge Challenger	2015-2018	5380437
Dodge Challenger	2008-2014	5380439
Dodge Charger	2015-2018	5380437
Dodge Charger	2008-2014	5380439
Dodge Durango	2018	5380437
Dodge Magnum	2005-2008	5380439
Ford Mustang	2015-2018	5380435

WOOD REPLACEMENT GRIP PLATES

These real wood replacement grip plates are a great way to add some custom style to the popular Billet/Plus Pistol-Grip shifter handles for modern muscle cars. Choose between Rosewood with a knurled texture or Blackwood with a stippled texture. Installs in seconds while on the vehicle using the 4 included screws.



ROSEWOOD: #1539000

BLACKWOOD: #1539001

COMP STICK KIT™

Dodge Challenger w/ Auto Stick



FITS 3RD GENERATION CHALLENGER

Add a unique touch to this instant classic with a brand synonymous with classic American muscle, Hurst. The Comp Stick Kit comes with a polished stainless steel Hurst engraved stick, classic Hurst ball knob, and the "Challenger" script engraved into the plate. If you have an automatic Challenger, this is a must accessory to the car! Choose between a black anodized or polished finish.



CNC MACHINED » Aluminum Base Plate with "Challenger" Script

STAINLESS STEEL » Hurst Engraved Handle

CHOICE OF FINISH » Polished Aluminum with White Knob or Black Anodized with Black Knob

FINISH	MAKE	MODEL	YEAR	PART #
Black Anodized Aluminum	Dodge	Challenger w/ AutoStick Feature	2008-2012	5380402
Polished Aluminum	Dodge	Challenger w/ AutoStick Feature	2008-2012	5380403



PRO-MATIC 2™

Automatic Ratchet Shifter

ABOUT THE HURST PRO-MATIC 2

The Hurst Pro-Matic 2 ratchet-action shifter, with its chrome-plated stick and black knob, is quality engineered for years of precise, trouble-free operation. Once the shifter is installed, the brilliant top cover and textured console, which can be trimmed to fit any floor contour, integrates the shifter into the interior. While easy on the eyes, this shifter is not all about looks. On the street, you will enjoy the ride as you freely tap the stick from gear to gear. If you decide to transfer your beauty of a machine to the track, give it all you've got because this shifter is built to handle the most powerful shifts, and the special positive reverse "Loc/Out" meets NHRA and IHRA technical requirements. This shifter comes complete with all the hardware required to make installation a breeze including a 5' long heavy-duty shifter cable and instructions. It also includes a neutral safety and back-up light switch assembly.

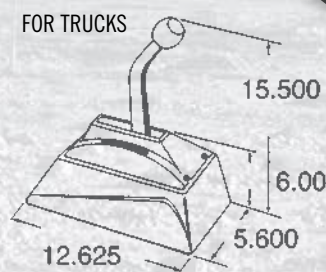
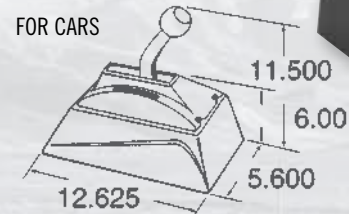

ADDITIONAL FEATURES

- >> Progressively-Illuminated Gear Position Indicator
- >> Cable-Operated to Provide Your Choice of Mounting Locations
- >> Full-Forward and Reverse Ratchet Action
- >> Compatible with Standard or Reverse Pattern Valve Bodies

MAKE	TRANSMISSION	CAR	TRUCK
GM	TH 250, 350, 375, 400	3838500	3838510
Ford	C-4, C-6 and AOD	3838500*	3838510*
Mopar	Torqueflite TF727-A904	3838500	3838510
AMC	Torque Command TF727-A904	3838500	3838510

* Will fit AOD with B&M #40496 lever and bracket kit.

V-MATIC 3™

Automatic Ratchet Shifter

ABOUT THE HURST V-MATIC 3

The Hurst V-Matic 3 is the pinnacle of performance shifters. At the end of 2012, the V-Matic 2 was replaced by the V-Matic 3. The engineers at Hurst shifters decided to go with a new mechanical design that would eliminate hang-ups between shifts and achieve a quicker, smoother, and more positive shift than its predecessor. If you are looking for a high-performance ratchet shifter that is robust and stout, the Hurst V-Matic is the perfect choice. This shifter comes complete with all hardware required to make installation a trouble-free task.

TRANSMISSION	PART #
GM TH 250,350, 400, 700R4	3838530*
Ford C-4, C-6 and AOD	3838530**
Mopar Torqueflite TF727 and A904	3838530
AMC Torqueflite TF727 and A904	3838530

* Will fit GM 4L60E, 4L65E, 4L80E and 4L85E with Hurst #1175498 lever/bracket kit.

**Will fit AOD with B&M #40496 lever/bracket kit.

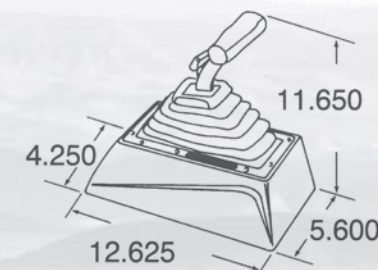

ADDITIONAL FEATURES

- >> Attractive, Black-Textured Console with Chrome-Plated Top Cover can be Trimmed to Fit any Floor Contour
- >> Back-Lit Gear Position Indicator
- >> Complete with Hardware, 5' Long Heavy-Duty Shifter Cable, and Instructions
- >> Chrome-Plated Stick and Brushed-Aluminum T-Handle
- >> Can be Used with Standard or Reverse Pattern Valve Body
- >> Cable-Operated for Quick Installation and Accurate Shifting
- >> Incorporates a Neutral Safety and Back-Up Light Switch Assembly
- >> Special Positive Reverse "Loc/Out" for NHRA and IHRA Technical Requirements

QUARTER STICK®

Automatic Gated Shifters

ABOUT HURST QUARTER STICKS

The Hurst Quarter Stick is considered the purest form of a race shifter. This shifter was designed for the people that wanted a no-compromise, lightweight, and compact shifter for 2 and 3-speed automatic transmissions in forward and reverse valve body shift patterns. The one-hand-operated, spring loaded, reverse "Loc/Out" mechanism meets NHRA and IHRA technical requirements and enables drivers to clear the reverse lockout while remaining strapped into their shoulder harness belts. These features, along with the fact that it is extremely compact and lightweight for tight-fit cockpit installation, have made the Quarter Stick immensely popular with race car drivers.

If you have a rear-engine dragster, the Quarter Stick 2 would be your best shifter choice. It has the same mechanisms as the Quarter Stick but with a rear cable exit. This allows for easier installation, positive shifts, and a lower probability of cable binding.

ADDITIONAL FEATURES

- >> Forged-Aluminum Stick for Added Strength (7/16"-20 top thread)
- >> Controlled Gate Stop Provides Fast Gear Changes while Eliminating Overshifts
- >> Includes Hardware, 5' Shifter Cable, Factory-Installed Neutral Safety Switch, and Install Guide
- >> Does Not Include Optional Covers or Back-Up Light Switch

QUARTER STICK	VALVE BODY	PART#
Powerglide (Alum. case only)	Forward & Reverse	3160001
TH 250, 350, 375 & 400	Forward	3160006
TH 250, 350, 375 & 400	Reverse	3160001
Chrysler/AMC TF727, A904	Forward	3160009
Ford C-4, C-6	Forward	3160009
Chrysler/AMC TF727, A904	Reverse	3160014
Ford C-4, C-6	Reverse	3160014

QUARTER STICK 2 (REAR CABLE EXIT)	VALVE BODY	PART#
Powerglide	Forward & Reverse	3160020
TH 250, 350, 375 & 400	Reverse	3160020



QUARTER STICK SHIFT GATE PATTERNS

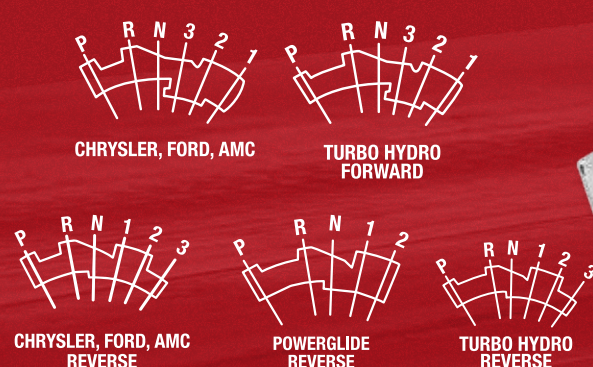

Aluminum Cover Sold Separately

QUARTER STICK®

Pistol-Grip Automatic Gated Shifters

ABOUT HURST PISTOL-GRIP QUARTER STICKS

The Hurst Pistol-Grip Quarter Stick Shifter is designed for a firm, comfortable, natural grip, providing a positive feel when shifting. Wouldn't it be great if there was a shifter that had the same great features of the Quarter Stick but with an ergonomic handle? Then integrate a precision snap-action momentary (normally-open) switch ideal for operating a Hurst Line/Loc, nitrous system, or transmission brake. That's how the Pistol-Grip Quarter Stick was born! The handle is CNC-machined from billet aluminum for exceptional strength and is contoured like a pistol-grip for ergonomics. The Pistol-Grip Quarter Stick 2 features a rear-exit cable design for rear-engine applications.

PISTOL-GRIP QUARTER STICK	VALVE BODY	FINISH	PART#
Powerglide (Alum. case only)	Fwd & Rev	Aluminum	3162001
Powerglide (Alum. case only)	Fwd & Rev	Black Anodized	3162002
TH 250, 350, 375 & 400	Forward	Aluminum	3162006
TH 250, 350, 375 & 400	Forward	Black Anodized	3162007
TH 250, 350, 375 & 400	Reverse	Aluminum	3162001
TH 250, 350, 375 & 400	Reverse	Black Anodized	3162002
Chrysler/AMC TF727, A904	Forward	Aluminum	3162009
Ford C-4, C-6	Forward	Aluminum	3162009
Chrysler/AMC TF727, A904	Forward	Black Anodized	3162010
Ford C-4, C-6	Forward	Black Anodized	3162010
Chrysler/AMC TF727, A904	Reverse	Aluminum	3162014
Ford C-4, C-6	Reverse	Aluminum	3162014
Chrysler/AMC TF727, A904	Reverse	Black Anodized	3162015
Ford C-4, C-6	Reverse	Black Anodized	3162015

PISTOL-GRIP QUARTER STICK 2 (REAR CABLE EXIT)	VALVE BODY	FINISH	PART#
Powerglide	Fwd & Rev	Aluminum	3162020
TH 250, 350, 375 & 400	Reverse	Aluminum	3162020

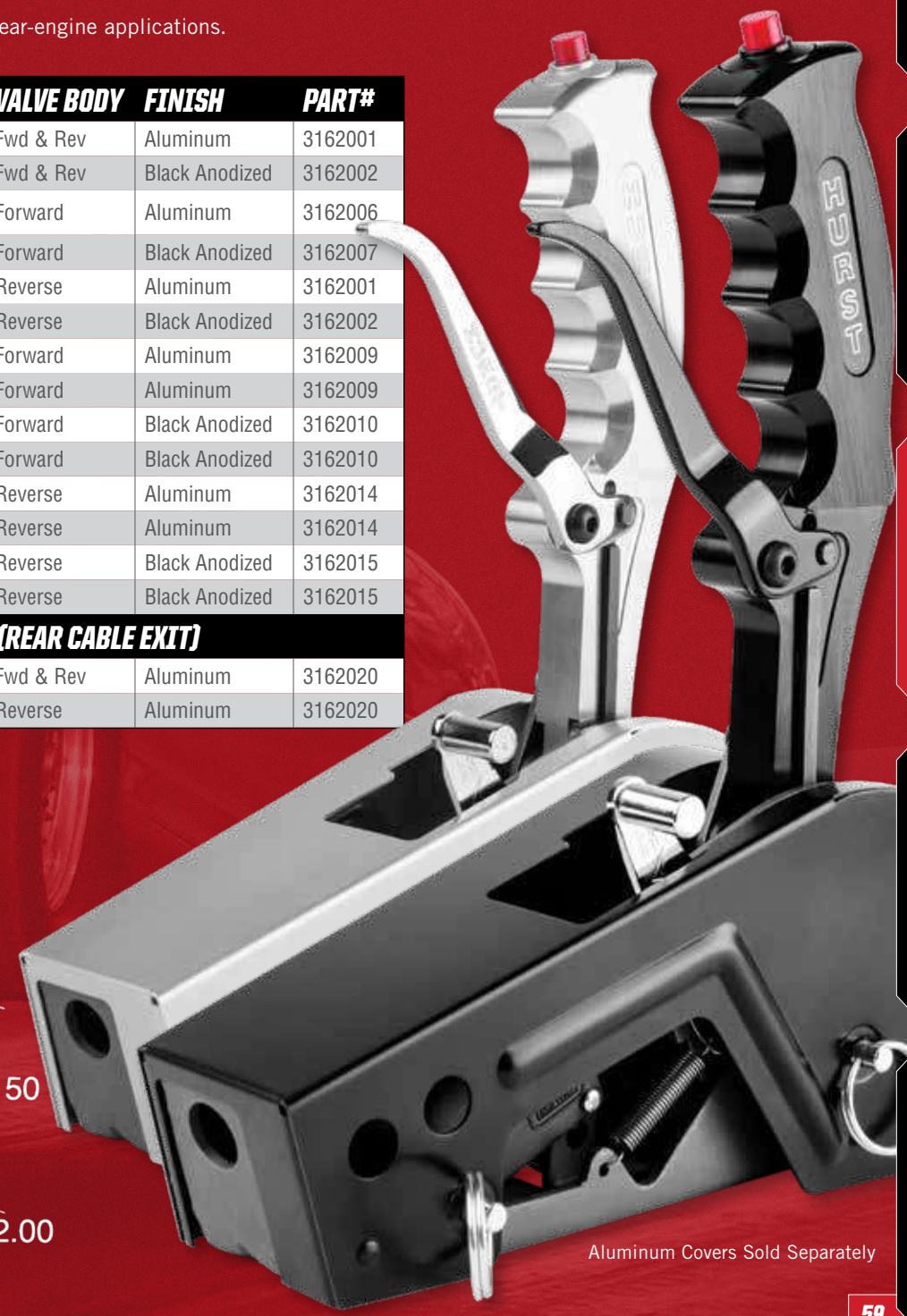

Aluminum Covers Sold Separately

Elite Series

Line/Loc

Manual Shifters

Automatic Shifters

Driveline Conversions

Accessories & Service Parts

Elite Series

Line/Loc

Manual Shifters

Automatic Shifters

Driveline Conversions

Accessories & Service Parts

QUARTER STICK®

Accessories

ALUMINUM COVER KIT

Brushed - Part #1300041
Black Anodized - Part #1300051



Adds a professional, finished look to your Quarter Stick installation. Attaches to the shifter with quick-release pins (included) and may be used in conjunction with the aluminum mounting plate kit. Does not fit Quarter Stick 2 or Pistol-Grip 2.

PLASTIC COVER KIT

Quarter Stick & Pistol Grip - Part #1300055
Quarter Stick 2 & Pistol Grip 2 - Part #1300056



Adds a distinctive, finished look to your Quarter Stick installation. Mounting plate and button head screws are included with the plastic cover kit.

ALUMINUM MOUNTING PLATE KIT

Mounting Plate - Part #1950225
Replacement Pin - Part #1890082



Clear, anodized aluminum mounting plate offers mounting flexibility and allows for quick shifter removal via quick-release pins (included).

BACK-UP LIGHT SWITCH KIT

Part #2488601



Kit includes back-up light switch and hardware. Easy installation for all Quarter Stick and Pistol-Grip shifters having front cable exit.

QUARTER STICK®

Accessories

SOLENOID SHIFTING KIT

Part #2260020

The Hurst Electric Solenoid Shifting Kit was designed to automatically complete the 1st to 2nd gear change, increasing shifting reliability and improving E.T. consistency.

- » Engineered for forward-pattern Hurst Quarter Sticks.
- » Shifting is controlled when used with an rpm-activated switch or manually-activated push button (normally open) switch.

The solenoid features a spring-activated plunger and is designed to quickly and firmly push the shifter stick into gear, not hit or slam it, which can cause damage to the stick itself.

Kit includes a heavy-duty 12-volt solenoid rated at maximum 3-amp draw to hold the plunger in position, aluminum mounting bracket, hardware, fuse, and electrical connectors.



COMPETITION SHIFTER KNOB W/ BUILT-IN 12V SWITCH

Part #1630050



Now with snap-action for instant activation, this black, molded ABS knob is ideal for use with Hurst Line/Loc®, or other nitrous oxide systems, or other 12-volt accessories. 7/16" x 20 thread size, application for Quarter Stick.

NEUTRAL/PARK START SAFETY SWITCH

Part #2488600



Kit includes switch and mounting hardware. Easy installation for all existing Quarter Sticks. (Newer Quarter Sticks and Pistol-Grip shifters feature the switch installed from the factory.) Fits front and rear-exit cable shifters.

DRIVELINE CONVERSIONS

- 64 BlackJack Shifters
- 66 Crossmembers
- 67 Tunnel Patches

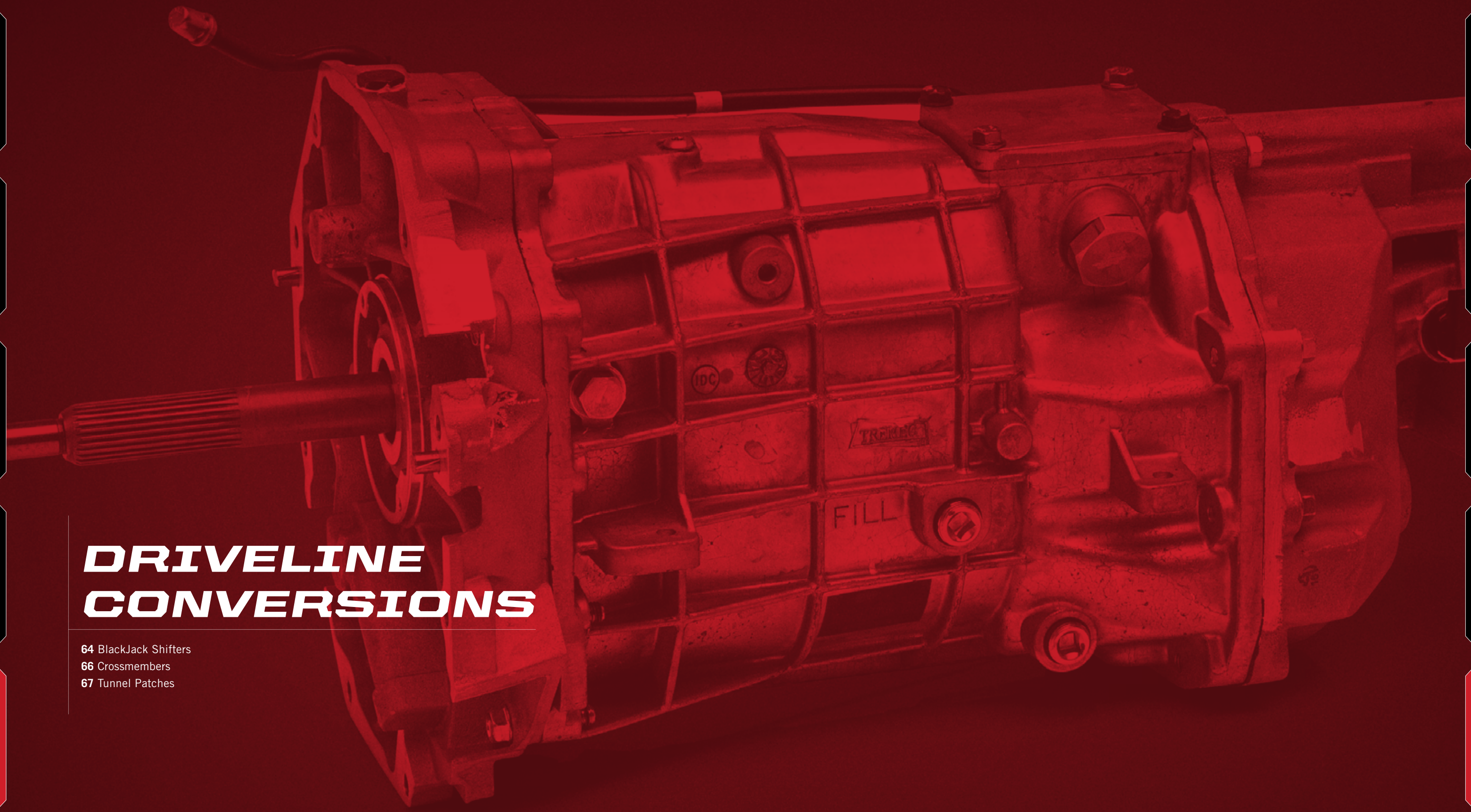

BLACKJACK™

Manual Shifters for Tremec Transmissions

ABOUT HURST BLACKJACK SHIFTERS

The Hurst Blackjack Shifter is specifically designed to locate the shifter handle in the proper location for vehicle specific applications when using an aftermarket Tremec TKO or Magnum transmission. Hurst Blackjack shifter housings are CNC machined from billet 6061 aluminum, feature a tough black MIL-Spec anodized finish with the Hurst logo CNC machined in the top plate, ensuring you're buying the highest quality shifter available today for your Tremec transmission.

Other features include zinc-plated hardened chromoly steel stick adapter, dual stick centering springs, hardened chromoly pivot pins and a durable delrin pivot ball for positive, quiet operation. Includes the classic Hurst chrome flat bar stick and white shift ball for the specified application.

FEATURES & BENEFITS

- >> CNC Machined Billet 6061 Aluminum Housing
- >> Durable Delrin Pivot Ball for Smooth Operation
- >> Hardened Chromoly Pivot Stick
- >> Vehicle Specific for Proper Shifter Locations



TREMEC TKO 5-SPEED APPLICATIONS

APPLICATION	PART #
1955-1957 Chevy w/ Tremec TKO Transmission	3912006
1967 Chevy Camaro w/ Tremec TKO Transmission	3912004
1968 Chevy Camaro w/ Tremec TKO Transmission	3912007
1969 Chevy Camaro w/ Tremec TKO Transmission	3912010
1970-1981 Chevy Camaro w/ Tremec TKO Transmission	3912003
1964-1967 Chevy Chevelle w/ Tremec TKO Transmission	3912005
1959-1964 Chevy Impala w/ Tremec TKO Transmission	3912001
1965-1969 Chevy Impala w/ Tremec TKO Transmission	3912002
1964-1966 Ford Mustang w/ Tremec TKO Transmission	3912009
1967-1973 Ford Mustang w/ Tremec TKO Transmission	3912008

TREMEC MAGNUM 6-SPEED APPLICATIONS

APPLICATION	PART #
1955-1957 Chevy w/ Tremec Magnum Transmission	3913007
1967 Chevy Camaro w/ Tremec Magnum Transmission	3913003
1968 Chevy Camaro w/ Tremec Magnum Transmission	3913004
1969 Chevy Camaro w/ Tremec Magnum Transmission	3913008
1970-1981 Chevy Camaro w/ Tremec Magnum Transmission	3913001
1964-1967 Chevy Chevelle w/ Tremec Magnum Transmission	3913002
1959-1964 Chevy Impala w/ Tremec Magnum Transmission	3913005
1965-1969 Chevy Impala w/ Tremec Magnum Transmission	3913006
1978-1988 GM G-Body w/ Tremec Magnum Transmission	3913101

BORG WARNER GM T5 (S-10/S-15)

APPLICATION	PART #
1982-1995 Chevy S-10/S-15w/ T5 Transmission	3916045



Photos are representative of installed shifter orientation.

CROSSMEMBERS

For Tremec Transmission Conversions

ABOUT HURST CROSSMEMBERS

These ultra-trick Hurst transmission cross-members have painstakingly been designed and fabricated from thick steel plate and heavy gauge steel tubing for a perfect fit and finish that has no equal. These bolt-in units are much stronger than the factory stock cross-members and help maintain the correct transmission and driveshaft angle. Precision cut and fully mig-welded, then given a durable black power coating finish to last a lifetime and give you peace of mind knowing you're buying the best parts available for your Tremec TKO 5-Speed or Magnum 6-Speed conversions. You can surely trust the company that originally started out making conversion mounts back in 1958, Hurst Performance.



DESCRIPTION	TRANSMISSION	APPLICATION	PART#
Crossmember	Magnum 6SPD	1975-1981 Camaro/Firebird	67510001
Crossmember	Magnum 6SPD	1967-1969 Camaro/Firebird w/ Big Block Motor Mounts	67510002
Crossmember	TKO 5SPD, Magnum 6SPD	1955-1957 Chevy (Includes 2 Frame Brackets)	67510003
Crossmember	TKO 5SPD	1960-1972 GM Trucks	67510004
Crossmember	TKO 5SPD	1962-1967 Chevy II/Nova	67510005
Crossmember	TKO 5SPD	1965-1969 Impala	67510007
Crossmember	TKO 5SPD	1967-1969 Camaro/Firebird w/ Small Block Motor Mounts	67510008
Crossmember	TKO 5SPD	1968-1974 Chevy II/Nova	67510009
Crossmember	TKO 5SPD	1970-1974 Camaro/Firebird	67510011
Crossmember	TKO 5SPD	1975-1981 Camaro/Firebird	67510012
Crossmember	TKO 5SPD	1967-1969 Camaro/Firebird w/ Big Block Motor Mounts	67510013
Crossmember	Magnum 6SPD	1967-1969 Camaro/Firebird w/ Small Block Motor Mounts	67510014
Crossmember	Magnum 6SPD	1970-1974 Camaro/Firebird	67510015
Crossmember	TKO 5SPD	1963-1967 Corvette	67510016
Crossmember	TKO 5SPD	1968-1979 Corvette	67510017
Crossmember	Magnum 6SPD	1978-1988 Cutlass, Monte Carlo, Regal G-Body	67510018
Frame Extender	Magnum 6SPD	1978-1983 Cutlass, Monte Carlo, Regal G-Body (To be used with 67510018)	67510019
Crossmember	TKO 5SPD, Magnum 6SPD, GM T350, T400, 700R4	1968-1972 Chevelle, Cutlass, GTO, Grand Prix A-Body	67510020
Crossmember	TKO 5SPD, GM T350, T400, 700R4	1964-1967 Pontiac GTO (Convertible Only)	67510021
Crossmember	TKO 5SPD	1971-1974 Mopar B-Body and 1970-1974 Mopar E-Body	67520000
Crossmember & Floor Brace	TKO 5SPD	1960-1981 Mopar A-Body (2 Parts)	67520001
Crossmember	TKO 5SPD	1966-1970 Mopar B-Body	67520002
Crossmember	TKO 5SPD	1967-1973 Mustang	67530000

TUNNEL PATCHES

For Tremec Transmission Conversions

ABOUT HURST TUNNEL PATCHES

When installing a Tremec transmission into your vehicle, you'll find that in most cases the larger transmission simply won't fit in the stock transmission tunnel. To fix this problem, Hurst makes a lineup of vehicle specific tunnel patches that make a Tremec driveline conversion that much easier.

Constructed entirely of stainless steel, these tunnel patches are precision made to fit around a Tremec transmission while properly positioning the shifter hole location. Each tunnel patch comes with a printed template that allows you to measure exactly where you need to cut for a clean installation.

FEATURES & BENEFITS

- » 18 Gauge Mild Steel
- » Vehicle Specific Applications
- » Custom Fit to Retain Use of Factory Carpet
- » For Use with or without Factory Consoles



TRANSMISSION	APPLICATION	PART#
Magnum 6SPD	Universal (Trimming Required)	69510000
Magnum 6SPD	1978-1988 GM G-Body	69510002
TKO 5SPD	GM Vehicles (Trimming Required)	69510003
TKO 5SPD	1984-1988 Chevrolet Corvette	69510004
TKO 5SPD	1968-1972 GM A-Body	69510005
TKO 5SPD	1967-1976 Mopar A-Body	69520001
TKO 5SPD	1966-1970 Mopar B-Body	69520002
TKO 5SPD	1971-1974 Mopar B-Body & 1970-1974 E-Body	69520004
TKO 5SPD	1967-1973 Ford Mustang	69530000
TKO 5SPD	1964-1966 Ford Mustang	69530001

ACCESSORIES & SERVICE PARTS

- 70 Accessories
- 71 Service Parts
- 72 Transmission ID Chart
- 74 Hurst Gear & Apparel



ACCESSORIES

HURST PIT PACKS

Available in either steel or nylon. Steel bushings are designed to take the punishment of racing applications and provide a more solid feel and longer service life. Nylon bushings are designed for street applications and eliminate most of the noise and stick vibrations. These pit packs can be used on the Master Shift 3-Speed, Competition/Plus 4-Speed, or the V-Gate 2. Kit includes either 6 or 7 steel or nylon bushings and spring clips. (Quantity and material are kit dependent.)

3320001	3327302	3321657	APPLICATION	BUSHING	PART #
			3, 4, and 5-speed manuals	Nylon Bushings	3320001
			3, 4, and 5-speed manuals	Steel Bushings	3327302
			V-Gate 2 only	Steel Bushings	3321657
			Billet/Plus 3916030 (10-15 Camaro)	Stainless Steel/ T-500 Polymer Bushings	3326030
			Billet/Plus 3915201 (05-10 Mustang)	Replacement Polyurethane Bushings	3325201
			Competition/Plus 3910201 (05-10 Mustang)	Replacement Polyurethane Bushings	3320201

HURST SHIFTER CABLES

Replacement shifter cables are available for all Hurst automatic shifters. Additionally, several lengths of cables are available for the Quarter Stick and Pistol Grip shifters. These premium quality cables feature a solid 303 stainless steel inner wire core encased within a nylon liner wrapped with helical lay wires and swaged ends for superior strength. The core is lubricated with Teflon prior to assembly and then sealed in a heavy plastic outer casing for durability and smooth operation. Make sure the cable is not kinked, bent in too tight of a radius, touching the exhaust manifold, or dragging. If this occurs, make adjustments to eliminate the problem.



STANDARD REPLACEMENT CABLES

CABLE LENGTH	PART #	VISUAL	NOTES
3 ft. Adjustable Single Eyelet	5000023		Auto Stick 3, Pistol-Grip, Q-Stick/Q-Stick 2, Lightning Rods Pick-up Truck Auto stick, Dual Gate 2, Van Auto
5 ft. Adjustable Single Eyelet	5000025*		Auto Stick 3, Pistol-Grip, Q-Stick/Q-Stick 2, Lightning Rods Pick-up Truck Auto stick, Dual Gate 2, Van Auto
8 ft. Adjustable Single Eyelet	5000028		Auto Stick 3, Pistol-Grip, Q-Stick/Q-Stick 2, Lightning Rods Pick-up Truck Auto stick, Dual Gate 2, Van Auto
5 ft. Adjustable Double Eyelet	5000029		Q-Stick (Late model Camaro, Monte Carlo)
5 ft. Adjustable Single Eyelet	5008555**		Pro-Matic 2, All V-Matic Shifters

* Standard cable for most Quarter Stick shifters. ** Standard cable for the Pro-Matic 2 and V-Matic 2.

2480003 • BACK-UP LIGHT SWITCH

This switch is designed to be used in conjunction with OEM back-up lights, the Competition/Plus 4-Speed, Super/Shifter 3, and MasterShift 3-Speed shifters.



NEED SERVICE PARTS?

- » SHIFTER SPRINGS
- » TRANS ARMS
- » HARDWARE
- » CABLES
- » CONSOLES
- » SHIFTER BOOTS
- » CABLE BRACKETS
- » MOUNTING PLATES
- » AND MUCH MORE!



3-SPEED TRANSMISSION I.D. CHART

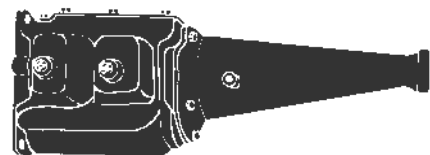

FORD (333)

9-bolt top cover; first-gear synchronized

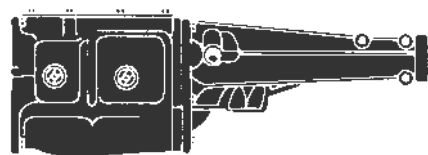

FORD (336)

9-bolt top cover; first-gear synchronized

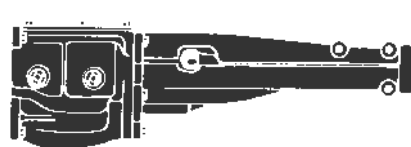

FORD (337)

4 or 6 bolt top cover; first-gear not synchronized

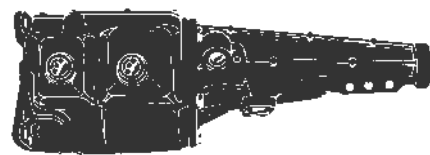

FORD (339)

9-bolt top cover; first-gear synchronized



CHEVROLET (341)

4-bolt side cover with round-gear selection shafts

Tapped holes on Corvette models only

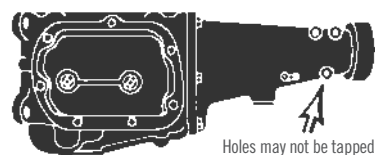

SAGINAW (343)

7-bolt side cover; first-gear synchronized
CAUTION: This transmission closely resembles 351 Muncie

Holes may not be tapped

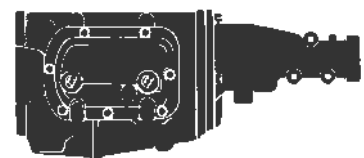

MUNCIE (351)

7-bolt side cover; first-gear synchronized
CAUTION: This transmission closely resembles 343 Saginaw



TREMEC (352)

9-bolt top cover; first-gear synchronized

4-SPEED TRANSMISSION I.D. CHART

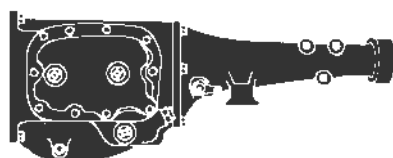

NEW PROCESS, MOPAR A-BODY (421)

10-bolt side cover



NEW PROCESS, MOPAR B-BODY (422)

10-bolt side cover

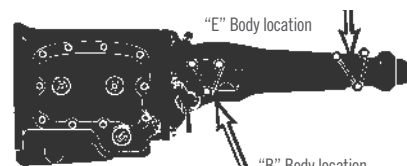

NEW PROCESS, MOPAR (423)

10-bolt side cover

"E" Body location

"B" Body location



BORG-WARNER T-10, SUPER T-10, FORD/ MERCURY (411)

9-bolt curved-bottom side cover



BORG-WARNER T-10, FORD/MERCURY (412)

9-bolt curved-bottom side cover



BORG-WARNER T-10 FORD/MERCURY (413)

9-bolt curved-bottom side cover

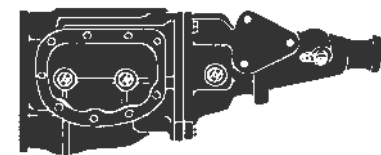

BORG-WARNER T-10, FORD/ MERCURY (414)

9-bolt curved-bottom side cover



BORG-WARNER T-10 (415)

4-bolt side cover with round-gear selection shafts

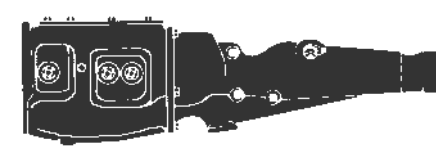

FORD T & C, FORD/MERCURY (431)

10-bolt top cover

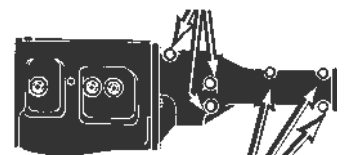

FORD 3+1 OVERDRIVE T & C, FORD/ MERCURY (432)

10-bolt top cover



FORD T & C, FORD/MERCURY (433)

10-bolt top cover

Tapped on Falcon/Comet

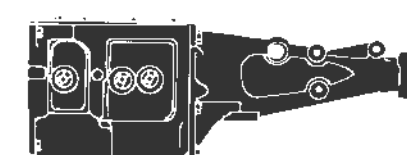

FORD T & C, FORD/MERCURY (434)

10-bolt top cover

4-SPEED TRANSMISSION I.D. CHART



FORD 3+1 OVERDRIVE FORD/ MERCURY (435)

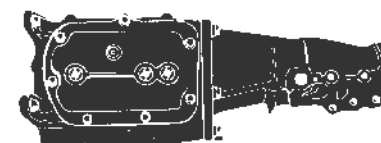

SAGINAW TORQUE TUBE TAILSHAFT, G.M. 81-82 CAMARO/FIREBIRD (456)

First-gear synchronized



BORG-WARNER TORQUE TUBE TAILSHAFT, G.M. (455)

81-82 CAMARO/FIREBIRD

9-bolt side cover



MUNCIE M-22 (453)

G.M. 7-bolt side cover 1970, 454 Chevelle

Transmission arms attach with bolt

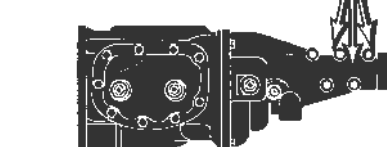

BORG-WARNER T-10, GM AS-3 (410)

9-bolt curved-bottom side cover

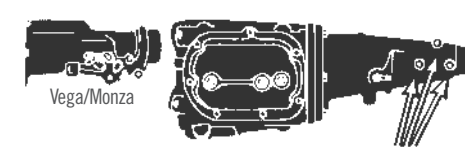

SAGINAW, G.M. (441)

7-bolt side cover

Holes may not be tapped

Vega/Monza



BORG-WARNER T-4 (464)

Internal Rail



MUNCIE M-20/M-21 EARLY, G.M. (451)

7-bolt side cover used from 63-68

Transmission arms attach with stud and nut*



MUNCIE M-20/M-21, G.M. (452)

7-bolt side cover 1969 and later

Transmission arms attach with bolt*

*MUNCIE Shaft Identification:

Muncie 4-speed transmissions can be distinguished from the style of the transmission arm attachment. Pre-1969 Muncies use a stud and nut at the indicated attachment point, while 1969 and later Muncies use a bolt as illustrated on the right.



PRE 69' MUNCIE & ALL BORG-WARNER SHAFTS TRANS ID 451



69' & LATER MUNCIE TRANS ID 452,453

5-SPEED TRANSMISSION I.D. CHART



BORG-WARNER T-5, GENERAL MOTORS (464)

Internal Rail



BORG-WARNER T-5, FORD (465)

Internal Rail



BORG-WARNER T-56, G.M. (468)



RICHMOND GEAR DOUG NASH/ G-FORCE 5-SPEED (467)



TREMEC 3550 (469)



NEW VENTURE MG-5 (466)

G.M. & Dodge Truck

HURST® GEAR

& Apparel



SIZE	PART #
Small	652201
Medium	652202
Large	652203
X-Large	652204
2X-Large	652205
3X-Large	652207

HURST NOSTALGIA T-SHIRT

Constructed from premium-quality, 100% pre-shrunk cotton and printed in vivid, fade-resistant colors, these quality-made tees have a classic Hurst Line/Loc logo on the front and an illustration of the mighty Hurst Hemi Under Glass on the back.



669986 • HURST LOGO HAT

Premium quality black snap-back, flat bill hat featuring an embroidered Hurst logo. One size fits most.



651416 • HURST LOGO BANNER

Show off your Hurst pride in a big way with this banner. Measuring 48"x34", this large banner is the perfect addition to any garage, shop or man cave. Made from heavy weight 8 mil poly vinyl, along with a sewn in perimeter and heavy duty grommets at all four corners.



SIZE	PART #
Small	653100
Medium	653101
Large	653102
X-Large	653103
2X-Large	653104
3X-Large	653105

HURST LOGO T-SHIRT

Show your Hurst pride with this premium-quality, 100% pre-shrunk cotton t-shirt. Celebrate Hurst's rich history and bright future with this modern-day re-imagining of the iconic logo.



1361000 • HURST-EQUIPPED EMBLEM

Based on original Hurst blueprints, this Hurst-Equipped emblem is an authentic reproduction of the one used on the late 1960s muscle cars equipped with a factory Hurst shifter. Made of durable ABS material with 3M adhesive tape backing for permanent mounting. Nominal size is 1-1/4" high by 5-1/4" long. Individually packaged.