



Instruction Manual P/N:PF8056



“The World’s First Tuned air Intake System!”
 Factory safe air/fuel ratio’s for Optimum performance
 Injens tuning process covered by three U.S. Patents

Vehicle Application:

Make: **RAM**
 Model: **1500/Rebel**
 Year: **2019-2020**
 Engine: **5.7L V8 HEMI**

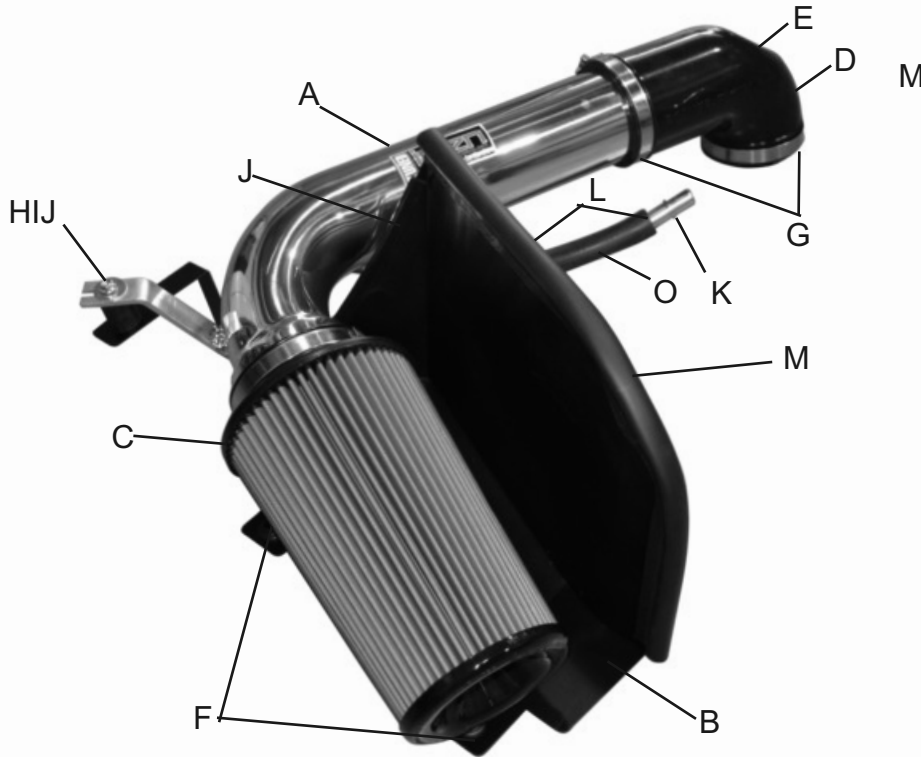

Item	QTY.	P/N	Discription
A	1	W-PF8056	Intake Tube
B	1	#11172	Heatshield
C	1	#1111BB	4" Dry Air filter
D	1	#3144	3.50" elbow hose w/grommet
E	1	#8026	Grommet
F	2	#6014	Grommets for heatshield
G	2	#4005	#56 clamps
H	1	#6020	M6 vibra-mount
I	2	#6002	M6 nuts
J	1	#6010	Fender washer
K	1	#14062	machined fitting
L	2	#4007	#10 clamps
M	1	#6023	Vinyl trim @ 9.5" L
N	1	#6058	Rubber trim @ 21" L
O	1	#3080	17mm hose @ 12" L

TOOLS REQUIRED

- 10mm Ratchet & Socket
- 8mm nut drive
- Flat Head Screwdriver

WARNING: FAILURE TO FOLLOW INSTALLATION INSTRUCTIONS AND NOT USING THE PROVIDED HARDWARE MAY DAMAGE THE INTAKE SYSTEM, ENGINE AND COMPONENTS!!!

***Do not attempt to install the intake system while the engine is hot.**

Severe burn could result from touching hot engine components!

Report any defective or missing parts to the authorized Injen dealer you purchased this product from. Before installing any parts of this system, please read the instructions thoroughly. If you have any questions regarding installation, please contact your Injen Technology dealer. Installation DOES require some mechanical skills. A qualified mechanic is always recommended.

A Limited Lifetime Warranty to the original purchaser against defects in material and workmanship on all Injen intake systems excluding the filter element. Any and all warranty coverage is limited to the repair or replacement of the defective part only, at Injen Technology's discretion. The warranty does not cover incidental or consequential damages, nor does it cover the cost of installation or removal of the defective part or its replacement. Proof of purchase is required.

Injen intake systems are street legal in most states unless the state is adopting to California Emissions standards. States that have adopted California emission standards include: Arizona, California, Connecticut, District of Columbia, Maine, Maryland, Massachusetts, New Jersey, New Mexico, New York, Oregon, Pennsylvania, Rhode Island, Vermont, and Washington. These states will require an California Air Resource Board Executive Order Number (CARB E.O.) for the legal use of an Injen intake system in your vehicle for use on public roads or highways. These vehicle will be considered "Legal in California only for racing vehicles competition use only, which may never be used upon a public street or highway. **Please keep your factory air box assembly for any future use.**

NOTE: Verify your filter before any cleaning maintenance!

Blue media filter: Dry Air Filter, no oil required.

(SuperNano Web Dry filters require no oil, these can be cleaned using a vacuum or light compressed air. Please do not clean using water or injen restore kit.)

Red media filter: Factory Oiled Air Filter.

(Oiled cotton gauze filters require oil, please use injen restore kit. This filter can use water or cleaning solution for maintenance.)

Please visit injen.com for filter cleaning instructions.



NOTE: DISCONNECT BATTERY BEFORE INSTALLATION!!!

Instruction Manual P/N:PF8056



1. Stock intake system shown.

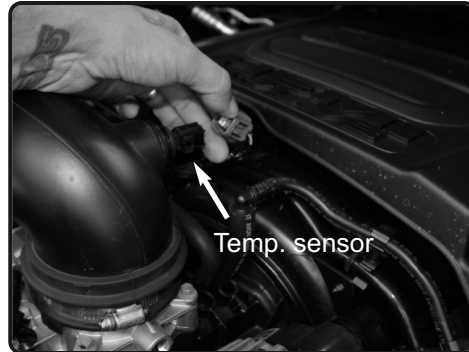

2. Disconnect the Temperature sensor harness.



7. Pull back crank case line from air box fitting.



3. Loosen the clamp on the throttle body using 8mm nut driver.

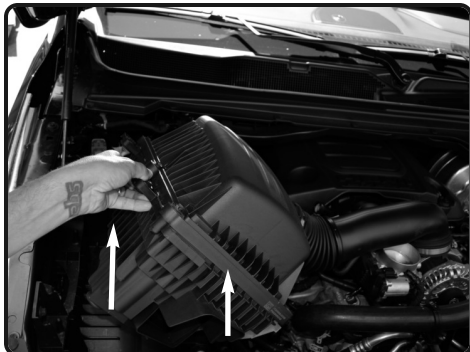

4. Lift up and remove the air box assembly out of the vehicle.



5. Pull back the intake tube from the throttle body.



6. Carefully lift up and remove the front plastic scoop

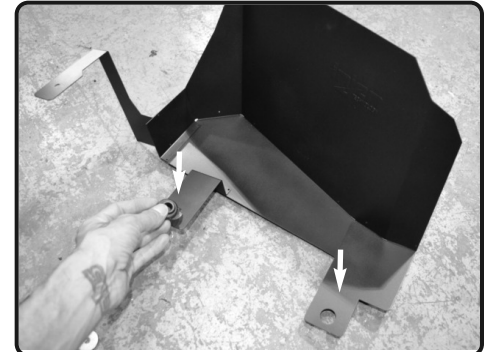

7. Install the provided 2 6014 grommets to the holes on the heatshield.



8. Install the provided Vinyl trim to the side of the heatshield.



9. Install the Rubber trim to the top of the heatshield.



10. Install the heatshield assembly into the vehicle. position the tabs with grommets to the factory plastic studs.

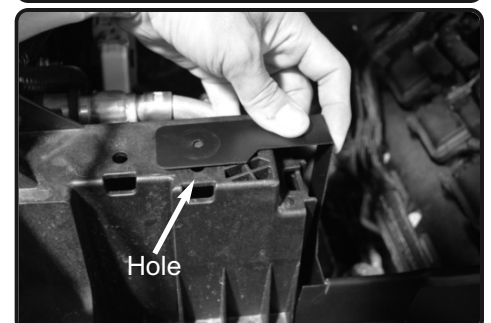

11. Secure the bracket to the hole on plastic wheel cover.

Instruction Manual P/N:PF8056

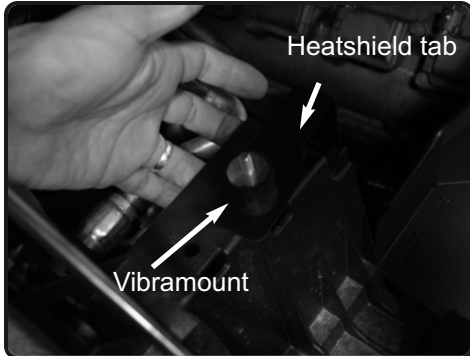

12. Secure the bracket using provided M6 vibramount and M6 nut under plastic. This will be used for the intake tube.

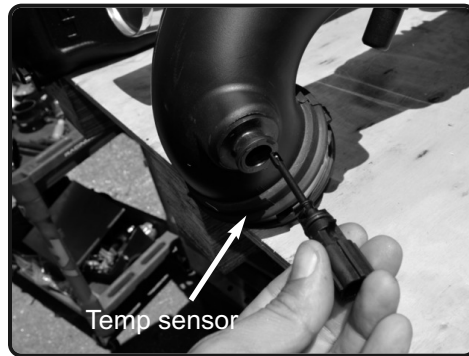

13. With flat head screwdriver, carefully turn and remove the temperature sensor out of the OEM intake tube.

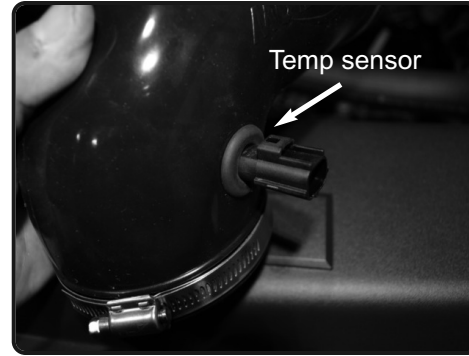

14. Install the temperature sensor grommet into the hole on the elbow hose. attach the clamps to the elbow hose.



15. Install the elbow hose assembly to the throttle body. Do not tighten.

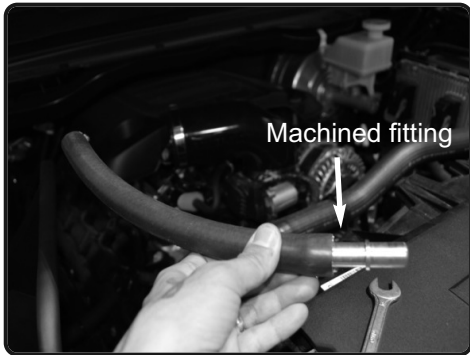

16. Attach the 17mm hose to the machined fitting with clamps provided.



17. Now install the crankcase line to OEM plastic crank case line from step 7. Make sure you hear a click.

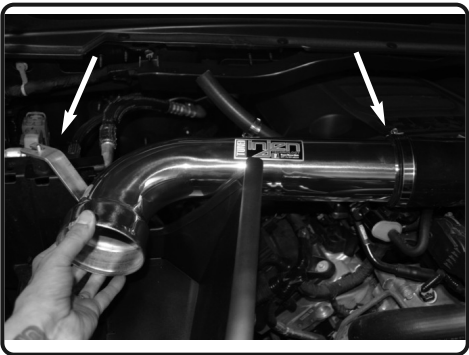

18. Install the intake tube and position the bracket to the vibramount and to the elbow hose. Do not tighten.



19. Position for best fit, Secure and tighten backet using provided M6 nut and fender washer.

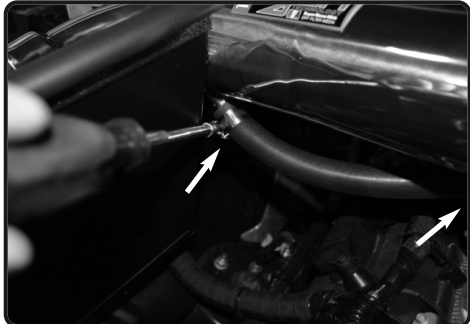

20. Secure the crankcase line to the fitting on the intake tube. Tighten both clamps using 8mm nut driver.

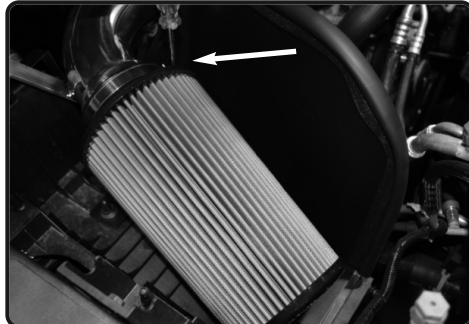

21. Install the filter to the intake tube.

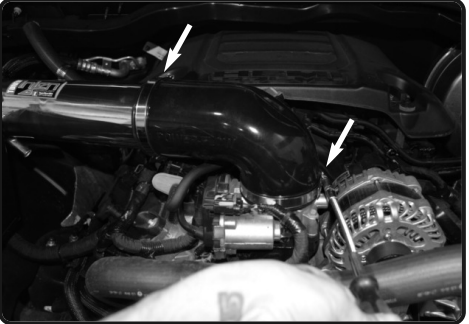

22. Adjust for fitment. Tighten all clamps. RE-adjust in necessary and make sure there is proper clearance.



23. Re-connect the temperature sensor harness.



Congratulations! You have just completed the installation of this intake system. Periodically, check the alignment of the intake, normal wear and tear can cause nuts and bolts to come loose. **Note: Check clearance and adjust if needed! Failure to check the alignment and adjust the intake can cause damage that will void the warranty. Injen Technology is not responsible for any damages caused by/from improper installation.**

Test Drive:

1. With the transmission in neutral or park and the parking brake engaged, start the engine. Listen for air leaks or odd noises. If air leaks are detected, secure hoses and connections. For any odd noises, inspect entire system for cause and adjust intake as needed. The Injen intake will function identically to the factory system but will be louder and more powerful.
2. Perform a road test. Listen for odd noises or rattles and fix as necessary.
3. If there are no issues, continue to enjoy your added performance from the Injen performance Intake kit.
4. Injen Technology recommends you periodically check clearance and adjust if needed! Failure to check the alignment and adjust the intake can cause damage that will void the warranty. Injen Technology is not responsible for any damages caused by/from improper installation.

1. Upon completion of the installation, reconnect the negative battery terminal before you start the engine.
2. Align the entire intake system for the best possible fit. Once the intake has been properly fitted continue to tighten all nuts, bolts and clamps.
3. Periodically, recheck the alignment of the intake system and make sure there is proper clearance around and along the length of the intake. Failure to follow proper maintenance procedures may cause damage to the intake and will void the warranty.
4. Start the engine and listen carefully for any odd noises, rattles and/or air leaks prior to taking it for a test drive. If any problems arise go back and check the vacuum lines, hoses and clamps that maybe causing leaks or rattles and correct the problem.
5. Check the filter for excessive dirt build up. Clean or replace the filter with an original Injen filter. Congratulations! You have just completed the installation of the best intake system sold on the market. Enjoy the added power and performance of your new intake system.