



#9008-SE **SUPER MUTT® STANDARD**  
Mobile Universal Trailer Tester

---

# OPERATOR'S MANUAL

---



**Tests Trailers Using 7 Round Pin Type Connections.**  
**Uses Internal 12/24 Volt Battery or External Power Source.**  
(Battery Not Included)

---

## **LETTER FROM THE PRESIDENT OF IPA®**

My name is Peter Vinci and I am the president of IPA. I would like to thank you for your interest in IPA's product line and share my commitment to you, our products and our policies. In today's world, we have all experienced the lack of service and consideration demonstrated by many companies after you buy their products. They say whatever they can to make the sale, and then it's like pulling teeth to get any service response out of them. I know this myself firsthand and because of this, I want to be sure that your experience with IPA meets your expectations and that IPA never disappoints you with our service or customer response.

With that said, please take a look at our product line. You will see innovative first time products that were created to help you do your job faster and better than before. I would also like to invite you to critique our products. If you can think of a better way to make them or changes that will make them work better, please contact me directly and I will be sure to look into it. If you have an innovation and would like some feedback, give me a call.

From all of us at IPA, we thank you for taking the time to review our product line and wish you and your family the very best of everything.

**Peter Vinci**  
**President**  
**Innovative Products of America®, Inc.**

# TABLE OF CONTENTS

---

<b>PART 1: IMPORTANT SAFETY INSTRUCTIONS</b>	4
<b>PART 2: WHAT'S INCLUDED</b>	7
<b>PART 3: CONTROLS AND PANELS</b>	8
3.1 Left and Right Side Panels	8
3.2 Electrical Control Panel	9
3.3 Air Brake Control Panel	10
<b>PART 4: SETUP</b>	11
4.1 Choosing a Battery	11
4.2 Axle and Wheel Installation	12
<b>PART 5: PRETESTING CHECKLIST</b>	13
Cable Testing Procedure	13
<b>PART 6: GENERAL OPERATION</b>	14
6.1 Initial Startup and Shutdown	14
6.2 Auto Shutdown Feature	15
6.3 Using the Remote Control	15
<b>PART 7: ELECTRICAL/LIGHTING TESTING</b>	16
7.1 Selecting a Circuit	16
Auto-Cycle Mode	16
7.2 Ground Integrity Test	17
Establishing a chassis Ground	17
7.3 Fault Indication	18
Open Circuit	18
Crossed Circuits	18
Short/Overloaded Circuit	19
7.4 Activating Hazard Lights	20
7.5 All Circuits On (Override) Mode	21
<b>PART 8: AIR BRAKE TESTING</b>	22
8.1 Testing Setup	22
8.2 Setting Desired Working Pressure	23
8.3 Leak Down Testing	24
8.4 Actuating Air Brakes	25
8.5 Emergency Air Exhaust	26
<b>PART 9: ABS BLINK CODE DIAGNOSTICS</b>	27
9.1 Meritor/WABCO Blink Codes	28
9.2 Haldex Blink Codes	29
9.3 Bendix Blink Codes	34
<b>PART 10: TYPICAL TRAILER WIRING</b>	37
<b>PART 11: MAINTENANCE AND STORAGE</b>	38
<b>PART 12: ADDITIONAL TESTING PROCEDURES</b>	38
<b>PART 13: OPTIONAL ACCESSORIES AND RELATED PRODUCTS</b>	39

# PART 1: IMPORTANT SAFETY INSTRUCTIONS

---

**IT IS IMPORTANT TO READ, UNDERSTAND AND FOLLOW ALL SAFETY MESSAGES AND INSTRUCTIONS PRINTED IN THIS MANUAL AND ON THE EQUIPMENT BEFORE OPERATING. IF SAFETY INFORMATION IS NOT HEEDDED, SERIOUS INJURY OR DEATH TO THE OPERATOR OR BYSTANDERS MAY OCCUR.**

## **DANGER**

Indicates a hazardous situation, if not avoided, will result in death or serious injury. The possible hazards are shown in the adjoining symbols or explained in the text.

## **WARNING**

Indicates a hazardous situation, if not avoided, could result in death or serious injury. The possible hazards are shown in the adjoining symbols or explained in the text.

## **CAUTION**

Indicates a hazardous situation, if not avoided, may result in minor or major injury. The possible hazards are shown in the adjoining symbols or explained in the text.

**THE FOLLOWING SAFETY ALERT SYMBOLS ARE USED IN THIS MANUAL.**



**SYMBOL 1: Potential burn hazard.** Sparks from electrical shorts can ignite flammable liquids such as fuel or oil. Heat from electrical overloads can cause fire hazards.

**SYMBOL 2: Potential electrical hazard.** Batteries have enough electrical energy potential to ignite flammable liquids such as fuel or oil. Wire overloads can cause electrical failures. Shock hazard exists.

**SYMBOL 3: Potential explosive air hazard.** Pneumatic pressures used with this equipment can cause explosive failures on damaged equipment.

**SYMBOL 4: Potential eye hazard.** Wear OSHA approved safety glasses. Battery acid and high air pressures create hazardous situations for eyes.

**SYMBOL 5: Potential chemical burn hazard.** Wear protective gloves. Battery acid is corrosive and can cause skin damage.

**SYMBOL 6: Potential electrical hazard.** Electrical energy can cause heat and burn hazards.

**SYMBOL 7: Potential fire hazard.** Use caution with flammable liquids such as fuel and oil. Electrical shorts can ignite flammable liquids and wiring.

**SYMBOL 8: Important information** is stated.

# BATTERY GASES, TESTER PREPARATION AND TESTER/CHARGER LOCATION

## RISK OF EXPLOSION



- Gases produced by a battery are highly explosive.
- Wear safety goggles and protective clothing, both users and bystanders.
- Use in an area having at least four air changes per hour.
- Read, understand and follow all instructions for charger, battery, vehicle and any equipment used near battery and charger.
- Do not smoke, strike a match, place metal tools on battery or cause a spark in the vicinity of the battery. When removing battery cables, remove the ground cable first.
- Clean terminals before charging battery. During cleaning, keep corrosive particles from eyes, nose and mouth. Use baking soda and water to neutralize acid and help eliminate airborne corrosion.
- Never allow clamps on charger cables to touch each other.
- Do not expose tester or charger to rain, snow, or wet conditions.
- Do not allow battery gases or acid to contact MUTT® cabinet. Do not place charger directly above or below battery.
- Fill battery to level specified by battery manufacturer using distilled water.
- Do not remove cell caps while charging per manufacturer's instructions.
- Make sure tester cable clamps make tight connections.
- Battery explosion can cause injury.

## GENERAL CHARGER USE

### RISK OF ELECTRIC SHOCK AND FIRE

- Before connecting charger to unit, make sure controls are set to OFF.
- Do not remove or bypass the grounding pin.
- Do not operate charger with damaged cord or plug. Replace cord or plug immediately if damage occurs.
- Position power cord and charger cables away from the hood, doors and hot or moving engine parts where they could be damaged.
- Unplug power cord by grasping and pulling on the plug, rather than the cord when disconnecting charger from outlet.
- Charger power cord uses equipment-grounding conductor and a grounding plug. Plug only into a 120V AC outlet that is correctly installed and grounded in accordance with all ordinances and local codes.
- Unplug power cord from outlet before cleaning or maintaining tester and charger. Turning off controls does not reduce the risk of electric shock.
- Do not operate charger after a sharp impact, drop or any other damage. Do not disassemble charger.
- Use only recommended attachments.
- Do not charge a frozen battery.
- Do not overcharge a battery.
- Use charger only on lead-acid automotive batteries. Do not use charger for charging dry cell batteries.
- Electric shock or fire can cause injury.



### RISK OF ENTANGLEMENT

- Keep yourself, clothing and battery charger leads clear of moving parts such as fan blades, pulleys, hood and doors.
- Moving parts can cause injury.

### RISK OF BURNS

- Batteries can produce short circuit current high enough to weld jewelry such as rings, bracelets and watches. You must remove them before working near batteries.
- Short circuits can cause injury

## PART 2: WHAT'S INCLUDED

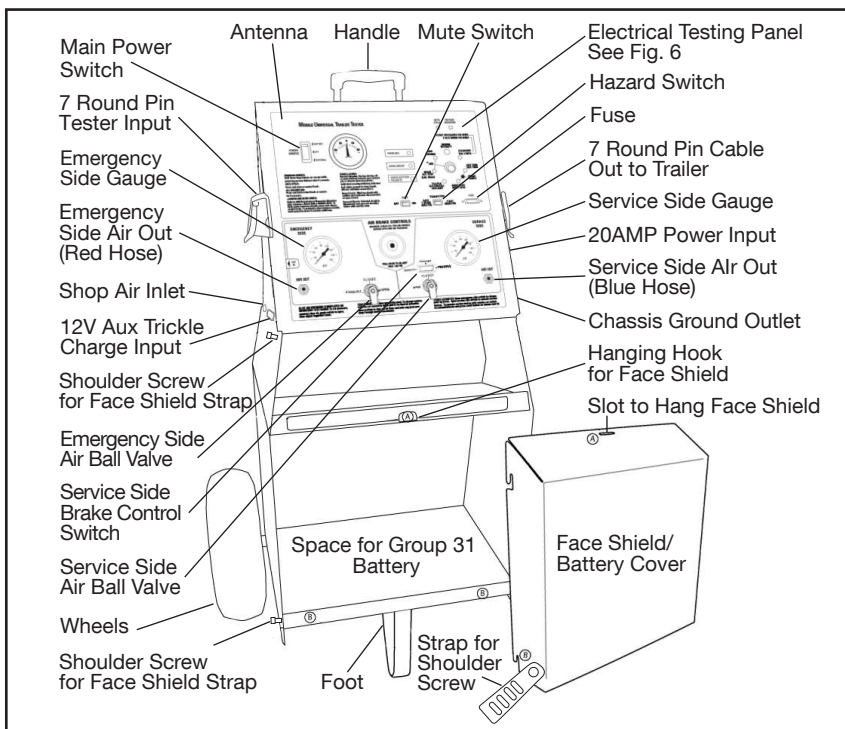

### INCLUDED PARTS AND ACCESSORIES:

#7900AP-8RD-AS  
8 FT. RED GLAD HAND



#7900AP-8BL-AS  
8 FT. BLUE GLAD HAND



#7900K-1  
5 FT. 7 ROUND PIN CABLE



#7900K-2BCHAS  
10 FT. CHASSIS  
GROUND CABLE



#7900K-34B  
CONTROL FOB BATTERY  
(12V Alkaline Energizer  
AE or A23)



#7900K-93  
FEMALE 2 PRONG  
PLUG POWER ADAPTER



#MUT-RM3  
REMOTE CONTROL FOB



## PART 3: CONTROLS AND PANELS

*An overview of the MUTT's controls, inputs, outputs and their functions.*

---

### 3.1 LEFT AND RIGHT SIDE PANELS

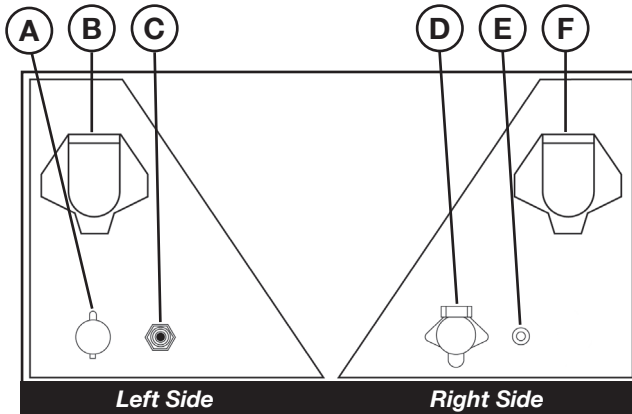

#### **A. 12V DC BATTERY TRICKLE CHARGE INPUT (CIGARETTE SOCKET)**

For connecting the trickle charger to the MUTT's internal battery (battery not included)

#### **B. 7 ROUND PIN CABLE TEST INPUT**

For testing the integrity of a 7 round pin trailer cable. Can also be used to verify that the MUTT is operating correctly.

#### **C. SHOP AIR INPUT**

A bulk head air input with external stone filter that is used to connect an air compressor to the MUTT for testing air brakes on a trailer.

#### **D. 20 AMP INDEPENDENT POWER INPUT**

For connecting external 12DC 20 amp max. power supply. (Power supply is an optional accessory, not for battery charging.)

#### **E. CHASSIS GROUND OUTLET**

Insert the supplied ground cable into this socket for trailers using the frame or body for ground connection instead of the ground pin in the harness.

#### **F. 7 ROUND PIN CABLE OUT TO TRAILER**

For connecting 7 round pin trailer to the MUTT to test electrical circuits.



## 3.2 ELECTRICAL CONTROL PANEL

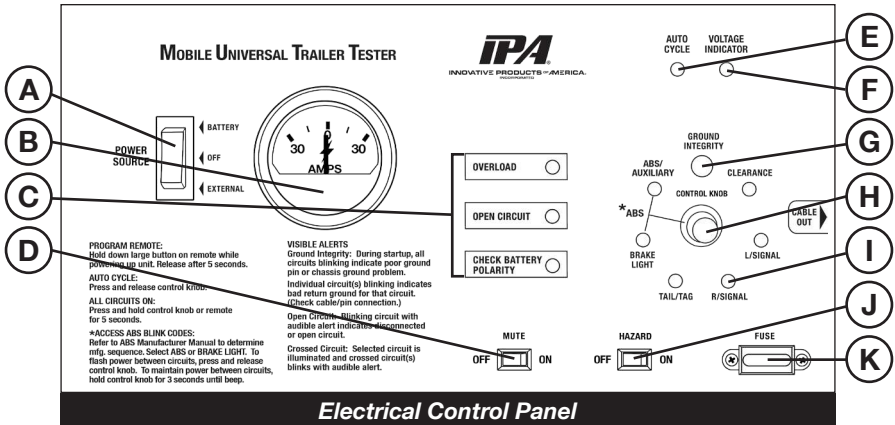

### A. POWER SOURCE SWITCH

Select between Internal Battery, External Power or Power Off.

**Center:** OFF (battery charge in this position only)

**Up:** Installed Battery ON

**Down:** External Power ON (power supply is an optional accessory)

### B. BACKLIT 30 AMP AMMETER

Meter shows current draw of a selected circuit up to 30 amps.

### C. TROUBLE WARNING INDICATORS

Flashing red LEDs indicate problems that may exist in a selected circuit. This includes the Overload Indicator, Open Circuit Indicator, and Reversed (Battery) Polarity Indicator.

### D. MUTE SWITCH

ON disables sound. OFF enables sound.

### E. AUTO CYCLE INDICATOR

Illuminates when Auto Cycle Mode is engaged.

### F. VOLTAGE INDICATOR

Shows supplied battery voltage integrity. Operating Voltage Range: 12/24 volt DC.

### G. GROUND INTEGRITY

A large green LED above the control knob indicates ground status. Ground integrity is automatically verified when power is turned on.

### H. CONTROL KNOB

Knob activates all electrical test modes and circuits to be diagnosed.

### I. CIRCUIT INDICATORS

The small green LEDs illuminate or blink in testing phase.

### J. HAZARD SWITCH

Activate the four-way flashers on trailer.

### K. 30 AMP FUSE SOCKET

Overload protection.

### 3.3 AIR BRAKE CONTROL PANEL

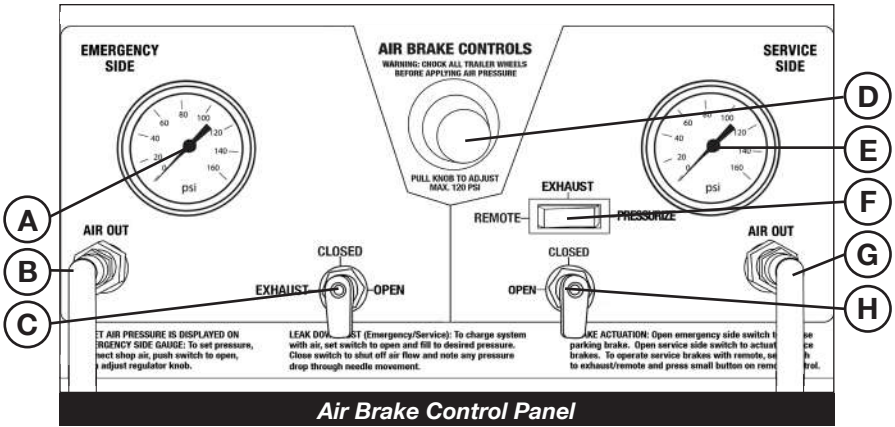

- A. Air Pressure Gauge - Emergency Side
- B. Air Out to Red Hose - Emergency Side
- C. Emergency Side Air Ball Valve
- D. Air Regulator Knob
- E. Air Pressure Gauge - Service Side
- F. Service Side Brake Control Switch
- G. Air Out to Blue Hose - Service Side
- H. Service Side Air Ball Valve

## PART 4: SETUP

### 4.1 CHOOSING A BATTERY

The MUTT® is a 12/24V DC device. Attempting to power your MUTT® with anything other than a 12 or 24 Volt DC power source will destroy the internal circuitry and void your warranty.

*(Manufacturer's Suggested Replacement: Group 31. MUTT® will auto detect 12 or 24 Volts. If 24 volts is required, two smaller 12 volt batteries can be used, but they must be wired in series.)*

- Battery Voltage: 12/24V DC
- Battery Type: Lead Acid
- Battery Compartment Dimensions:  
13.5" L x 11" H x 9.25" D
- Battery Protection: Inline 30 amp Fuse for Overcharge
- Battery must be clean and leak free.
- Identify battery polarity.
- Attach ring terminal (with red heat-shrink) to positive (+) side and ring terminal (with black heat-shrink) to negative (-) side. Also see warning indicators on page 4. Connections must only be made to clean terminal rings.
- Any loose or corroded connectors may cause misdiagnosis or result in erroneous readings.
- Use well-charged battery.

#### DC POWER

**Do not plug directly into AC wall outlet**

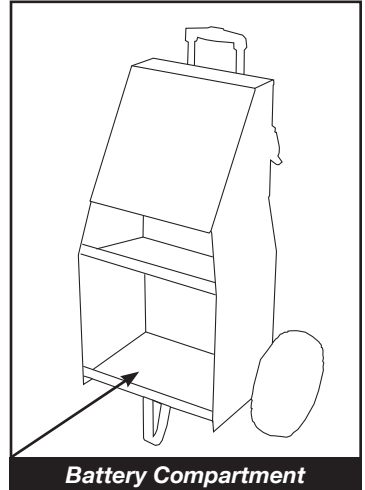

## 4.2 AXLE AND WHEEL INSTALLATION

- Insert axle (A) into left and right axle bores (B) at rear underside of the MUTT®.
- Slide one spacer (C) onto each side of the axle (A).
- Install one wheel (D) onto each side of the axle (A) with valve stem facing away from the MUTT®.
- Insert one E-Clip (E) into the groove (F) in the axle end in front of the wheel to each side.
- Check tire pressure. It must not exceed 8 PSI.

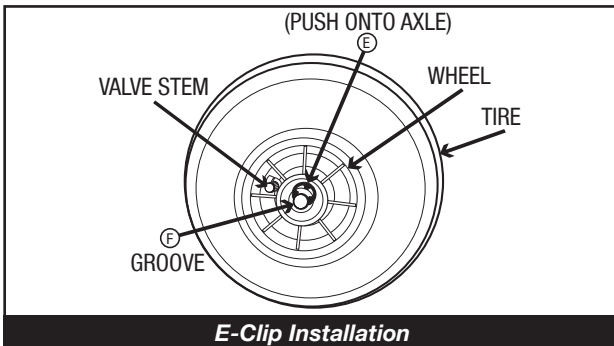
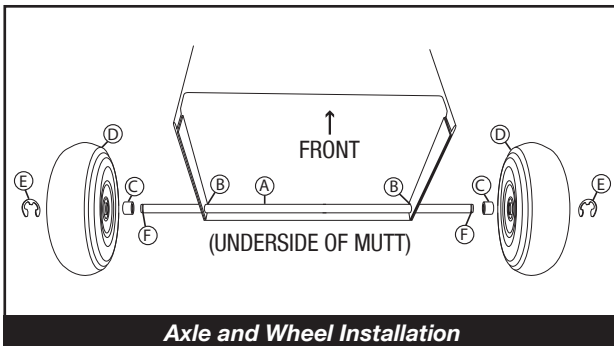

**NOTE:** Install the Foot at the bottom of the unit with 45° angle side towards the back of the unit.

# PART 5: PRETESTING CHECKLIST

*The pretesting checklist should always be completed prior to using the MUTT*

---

## UNIT PLACEMENT

- Place the tester on a flat, level surface.
- Chock trailer wheels to avoid rolling before testing brakes.

## MAINTAIN CONNECTORS

Dielectric grease should be used on all connections to avoid corrosion. If a bad connection exists at the terminal junction, you may get an erroneous reading and the MUTT will not work properly.

- Make sure you have a solid connection in the socket.
- Be certain the 7 pins in each plug are clean and spread to the proper size.
- Always check the MUTT connector pins at the side of the MUTT for proper expansion. Over time, the pins may bend in slightly resulting in a poor connection between the connector and the cable ends. A flat head screwdriver can be used to expand the pins until a tight connection is made.

## CABLE TESTING PROCEDURE

The MUTT has a special cable feature to test 7-way round pin cables for continuity. The cable testing feature can be used to test a tractor's cable, or the supplied MUTT cable. All cables should be tested prior to MUTT operation.

- Insert each end of the cable into both side connectors on the MUTT. Be sure to push the cable ends in firmly until they reach the bottom of the connector.
- Turn main power switch to a desired power supply.
- Once the power is selected, the green lights around the control knob will blink and disappear one at a time until only the Ground Integrity Indicator remains solid green. Once the initial check has been performed, poor cable conditions will be shown by a blinking light for the problem circuit.
- If the cable has an open circuit or continuity problem, the corresponding circuit will flash repeatedly.
- Further testing can be performed by selecting each circuit individually via the control knob or remote. When an open circuit is detected, the LED for the circuit will flash and an audible alert will be heard.

# PART 6: GENERAL CONTROLS AND OPERATIONS

## 6.1 INITIAL STARTUP AND SHUTDOWN

All functions of the MUTT, including air brake controls, require the Power Source Switch to be in BATTERY or EXTERNAL position.

### POWERING UP

1. Push the Power Source Switch to BATTERY or EXTERNAL.

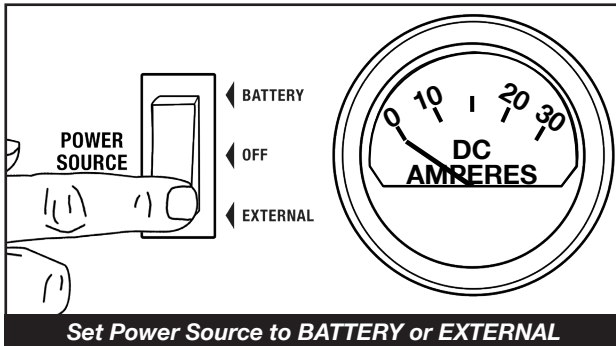

### POWERING DOWN

1. Prior to shutting down, exhaust all air from the brake lines, and return all air control switches to the CLOSED position.
2. Push the Power Source Switch to the OFF position.

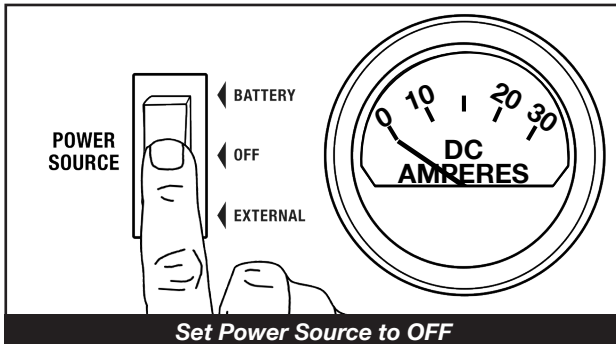

**NOTE:** Turning the power off will disengage the service brakes but NOT the emergency/parking brakes. Exhausting the Emergency Side air will engage the spring/parking brakes. See pg. 26 for exhausting/dumping air pressure.

## 6.2 AUTO SHUTDOWN FEATURE

If left inactive for a period of 20 minutes, the MUTT enters a Sleep Mode and powers down.

- A sound is emitted every 20 seconds during Sleep Mode.
- Activation of the control knob will cancel Sleep Mode.

## 6.3 USING THE REMOTE CONTROL

The included remote control(s) is preprogrammed to your MUTT and should never lose its programming.

### HOW TO USE THE WIRELESS REMOTE

#### 1. UP ARROW

Press and release to select the next circuit in clockwise rotation. Press and hold for 5 seconds to activate All Circuits On Mode.

#### 2. DOWN ARROW

Press and release to select the next circuit in a counterclockwise rotation. Press and hold for 5 seconds to turn on hazard lights.

#### 3. ON/OFF

Press and release to engage/disengage air brakes. Press and hold to maintain constant airflow on service brakes.

#### 4. REMOTE CONFIRMATION INDICATOR

Press any of the buttons (1,2,3) and the blue light (4) will illuminate to confirm the battery power of the remote.

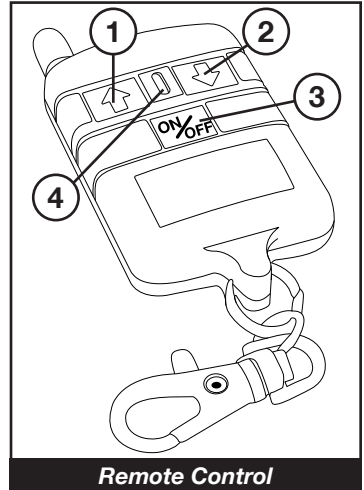

**NOTE:** Inclement weather, nearby power transformers and closely parked trailers may reduce the remote signal.

The supplied, key fob battery for the remote control is 12V, Alkaline Energizer type A23. A Gold Peak type 23A or Duracell MN21 battery can also be used.

# PART 7: ELECTRICAL/LIGHTING TESTING

*Complete the pretesting checklist prior to all testing procedures.*

The MUTT is microprocessor controlled and features a special diagnostic firmware, designed to seamlessly integrate with your preferred methods of testing. The MUTT will power the selected electrical circuits and instantly alert you to any signs of a faulty condition. **To properly utilize the diagnostic features, a complete scan of the trailer's electrical system should be performed at the front of the trailer using the MUTT prior to a walk-around inspection.** If any wiring faults are present, the MUTT will blink or sound, alerting you to the issue. Only a one-time, walk-around/visual inspection is needed to confirm that each individual light bulb is properly illuminating.

**NOTE:** Some advanced functions may not be listed on the face panel, so it's important to read the manual in its entirety to ensure that you are getting the full use of this diagnostic system.

## 7.1 SELECTING A CIRCUIT

Circuits can be selected for testing manually, via remote control or by initiating Auto Cycle Mode.

### OPERATING WITH MANUAL CONTROL

1. Turn the control knob to select a circuit. The control knob is automatically set to Ground Integrity when power is turned on.

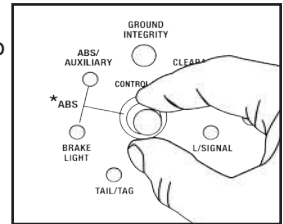

### OPERATING WITH THE REMOTE CONTROL

1. Press and release the UP ARROW to select the next circuit in clockwise rotation.
2. Press and release the DOWN ARROW to select the next circuit in a counterclockwise rotation.

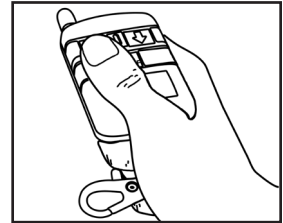

### AUTO CYCLE MODE

Auto Cycle Mode automatically tests one circuit at a time in a clockwise rotation.

1. Press and release the control knob. The Auto Cycle Indicator should illuminate.
2. A five second delay commences before power is automatically applied to the first circuit.
3. Circuits are automatically tested one at a time in a clockwise rotation, starting from the Ground Integrity Indicator.
4. To cancel Auto Cycle Mode, momentarily press and release or turn the control knob.

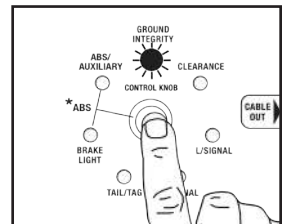

**NOTE:** Auto Cycle Mode does not work when ABS or Brake Light Circuits are selected.



## 7.2 GROUND INTEGRITY TEST

Each time the MUTT is powered on, it automatically runs a Ground Integrity Test. A good ground connection must be established for the MUTT to operate a trailer's electrical system.

1. Immediately after power up, the green lights around the control knob will illuminate.
2. A solid/healthy ground connection is indicated by a steadily illuminated Ground Integrity Indicator.
3. Bad/poor ground or bad cable condition is indicated by all of the LED's blinking simultaneously. See ESTABLISHING A CHASSIS GROUND below.
4. When one or more green circuit LEDs blink while the Ground Integrity Indicator is steadily illuminated indicates that a solid ground has been established, but an open circuit has been detected. Refer to OPEN CIRCUITS on pg. 18.

### CHASSIS AND PIN GROUNDS

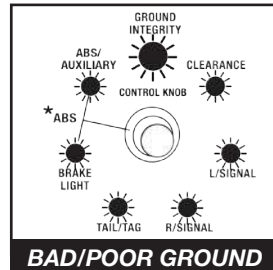
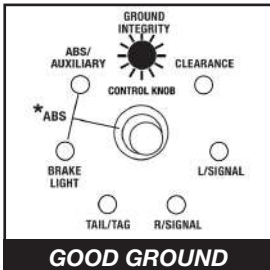

A poor ground warning may be an indication that the connected trailer is only wired for chassis ground. There are two ground types. 1) Pin Ground: The ground wire from each light assembly is wired through the main harness up into the trailer plug. 2) Chassis Ground: The ground wire from each light assembly is grounded directly to the trailer chassis. Ground with the truck is established at the king pin.

### ESTABLISHING A CHASSIS GROUND

1. To simulate the king pin on a chassis ground connection and bypass the ground integrity fault, plug the supplied 10 ft. chassis ground cable into the MUTT's Chassis Ground Outlet.
2. Using the alligator clip, attach the other end of the chassis ground cable to the chassis of the trailer.
3. Be sure that you are attaching to a clean, dry metal for an effective ground.

**DO NOT**  
**Assume that a Bad Ground Warning is a Result of a Faulty Trailer. Check Cable Connection.**

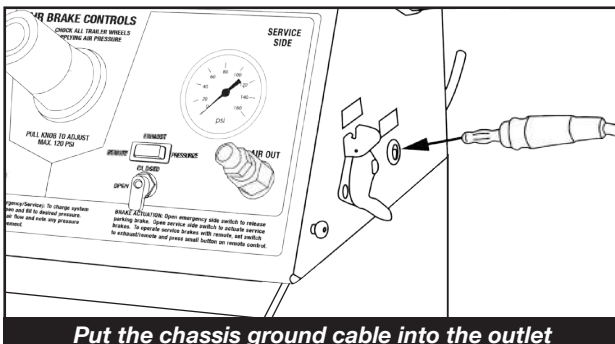

## 7.3 FAULT INDICATION

### OPEN CIRCUIT

The MUTT senses no load which is often the symptom of a disconnected wire, cut wire, poor pin connection or bad return ground. The MUTT can detect open circuits in two ways.

1. During Ground Integrity Test: An individual circuit will blink and no audible alerts will be present.
2. During circuit selection: The selected circuit's LED will blink, while simultaneously the Open Circuit Indicator will flash. The MUTT will also provide an audible alert (beep).

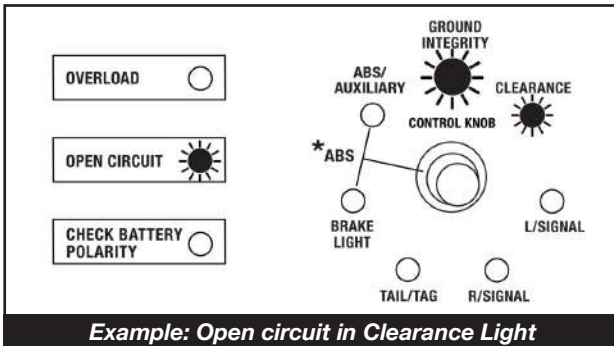

**Example:** The MUTT detects an open circuit in the Clearance Light Circuit. The Clearance LED will blink, the Open Circuit Indicator will flash and the MUTT will beep.

**NOTE:** Open Circuit Indicator will only illuminate during circuit selection.

### CROSSED CIRCUITS

The MUTT indicates that two or more circuits are back feeding or crossed. This can be a symptom of two wires in the same harness wearing through their insulated coating and connecting.

1. When a crossed circuit is identified, the selected circuit LED will illuminate steadily and the circuit it is crossed with will flash. The MUTT will also provide an audible alert (beep).

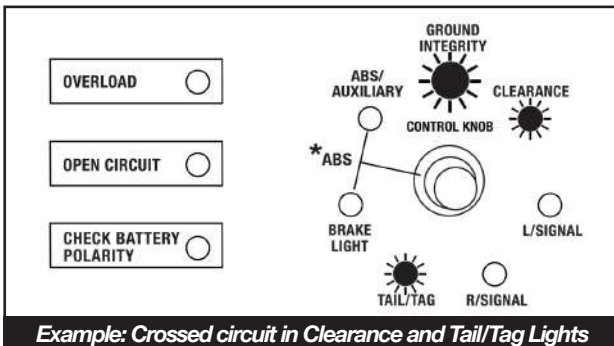

**Example:** The MUTT detects that the Clearance and Tail/Tag are crossed while the Clearance Circuit is selected. The Clearance LED will illuminate, the Tail/Tag LED will flash and the MUTT will beep.

**NOTE:** In some cases, a crossed circuit may be a normal function of advanced diagnostic testing, such as with certain ABS systems.

## SHORT/OVERLOADED CIRCUIT

Short circuits or overloads can occur when a positive, hot wire touches ground. They can also occur due to faulty lights or connectors.

1. If a short or overloaded circuit is suspected, the MUTT will instantly stop powering the circuit.
2. The Overload Warning Indicator will then flash, along with the selected circuit's LED. The ammeter needle will also max out and return to 0.
3. The MUTT will now automatically enter Pulsar Mode. During Pulsar Mode, the MUTT will attempt to reapply power to the faulty circuit every 3 seconds for an indefinite period of time. After power is applied, if a short is still present, steps 1-3 will automatically repeat.

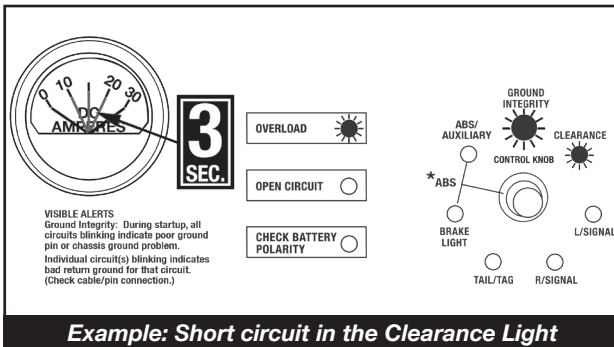

**Example:** The MUTT detects a short in the Clearance Light Circuit. The Clearance LED and Overload Warning Indicator will flash and a warning beep will sound. The MUTT will now enter Pulsar Mode.

**NOTE:** Pulsar Mode can be a useful troubleshooting tool for finding dead and intermittent shorts.

## 7.4 ACTIVATING HAZARD LIGHTS:

The four-way flashers on the vehicle can be activated manually or with the remote control.

### Manually

1. To activate, set the Hazard Switch to the ON position.

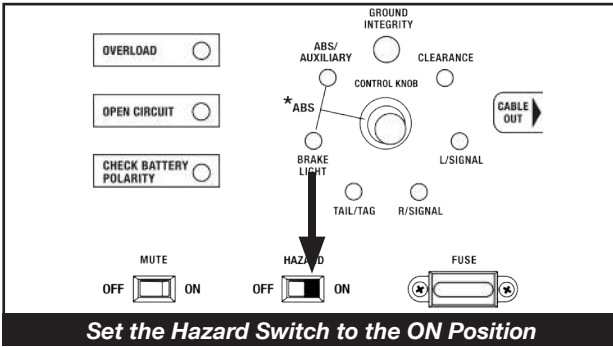

2. To deactivate, set the Hazard Switch to the OFF position.

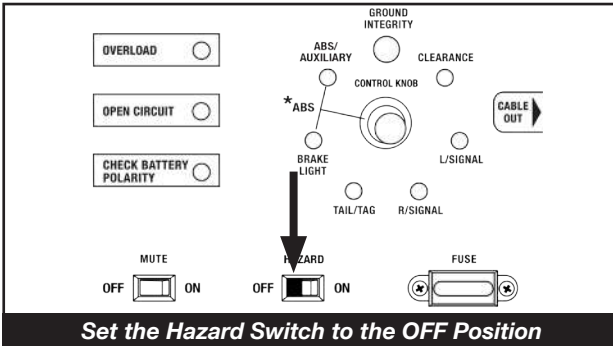

### Remote Control

1. To activate, press and hold the DOWN ARROW button for 5 seconds.

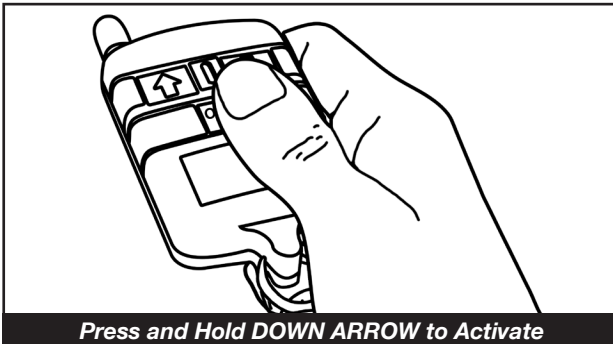

## 7.5 ALL CIRCUITS ON (OVERRIDE) MODE:

All Circuits On Mode will engage all electrical circuits at the same time. While short circuit sensing is operational in this mode, if a short circuit is found, the MUTT will not be able to identify which circuit is the cause of the short. Open and crossed circuits sensing is not operational in this mode.

On trailers using incandescent bulbs, All Circuits On Mode will typically result in an overload because the amperage draw will exceed the maximum of 20 amps.

All Circuits On Mode can be accessed manually or by remote control.

### MANUALLY

1. To activate, press and hold control knob for 10 seconds. Listen for beep, then release.
2. To cancel, press or turn the control knob.

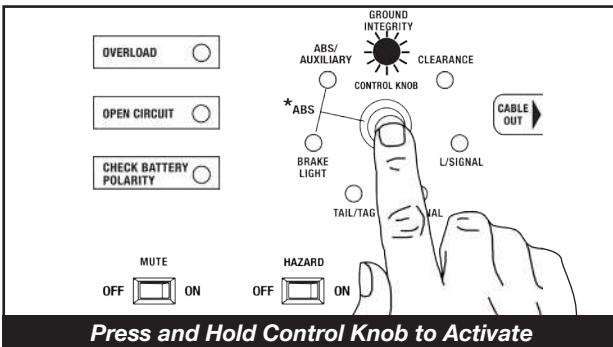

**NOTE:** Does not work when ABS or Brake Light Circuits are selected.

### REMOTE CONTROL

1. To activate All Circuits On Mode press and hold UP ARROW for 5 seconds and then release.
2. To cancel, press and release either arrow.

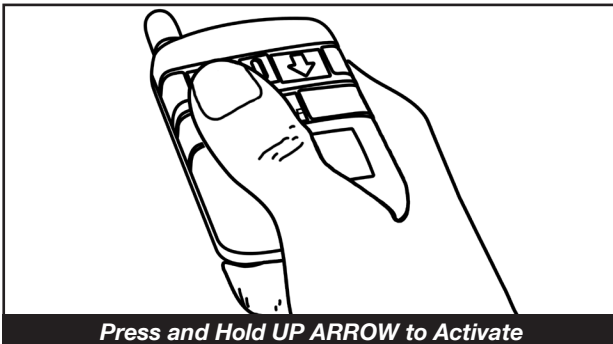

# PART 8: AIR BRAKE TESTING

Complete the pretesting checklist prior to all testing procedures.

**⚠ DANGER ⚠**

## CHOCK TRAILER WHEELS

**WARNING!!! DO NOT CONNECT SHOP AIR UNTIL COMPLETING THE TESTING SETUP PROCEDURE STEPS 1-5. FAILURE TO FULLY UNDERSTAND THESE WARNINGS CAN RESULT IN MINOR TO SERIOUS INJURY AND POSSIBLY DEATH.**

### 8.1 TESTING SETUP

1. Push the Power Source Switch to the OFF position.
2. Set both Emergency and Service Side Air Ball Valves to the CLOSED position.
3. Attach gladhand hoses from the MUTT directly to your trailer's air system, securing the red hose to the Emergency Side and the blue hose to the Service Side.
4. Connect your shop air to the Shop Air Inlet on the left hand side of the tester.
5. Listen for any air leaks where the shop air connects to the tester, to avoid erroneous results.

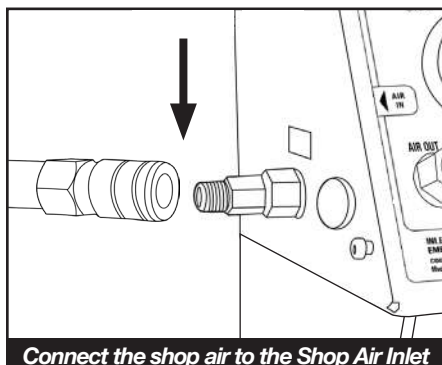
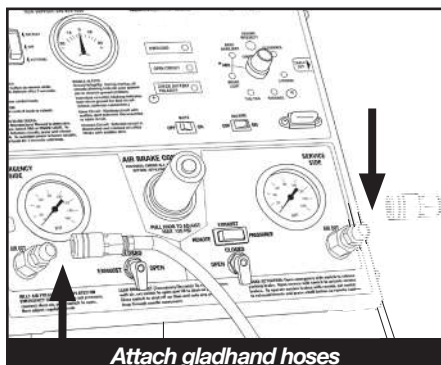
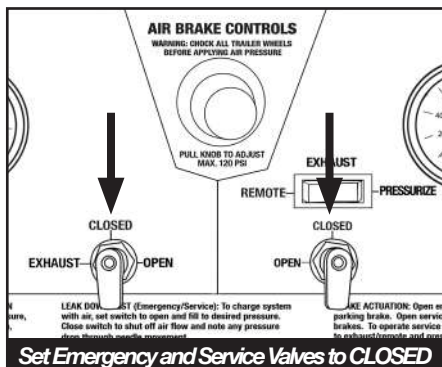
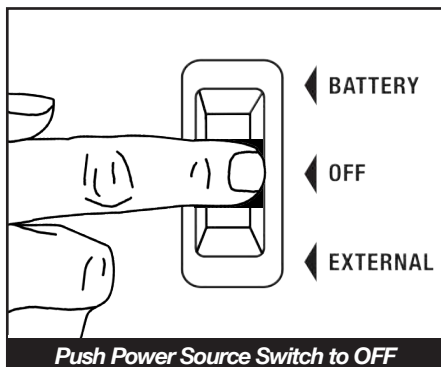

## 8.2 SETTING DESIRED WORKING PRESSURE

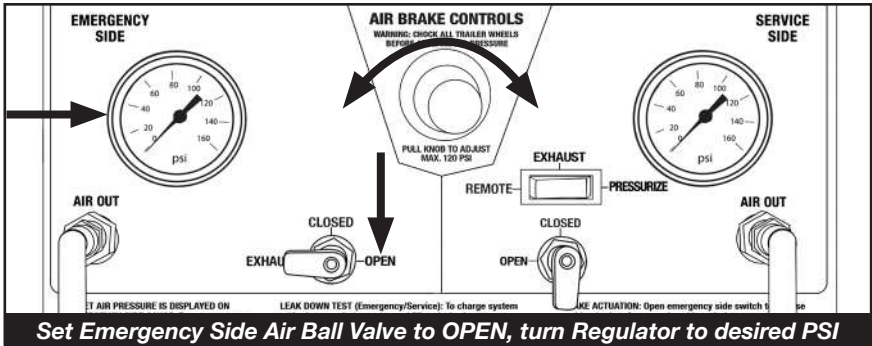

1. Turn the MUTT on, by selecting Battery or External power with the Power Source Switch.
2. Set Emergency Side Air Ball Valve to the OPEN position.
3. Turn Air Regulator Knob clockwise or counterclockwise until needle on the Emergency Side Air Gauge points to the desired operating pressure (Most shops prefer 80-100 PSI during testing).

## 8.3 LEAK DOWN TESTING

You must always test the Emergency Side before testing the Service Side. Trying to test the Service Side first will result in erroneous readings.

### EMERGENCY SIDE LEAK DOWN TESTING

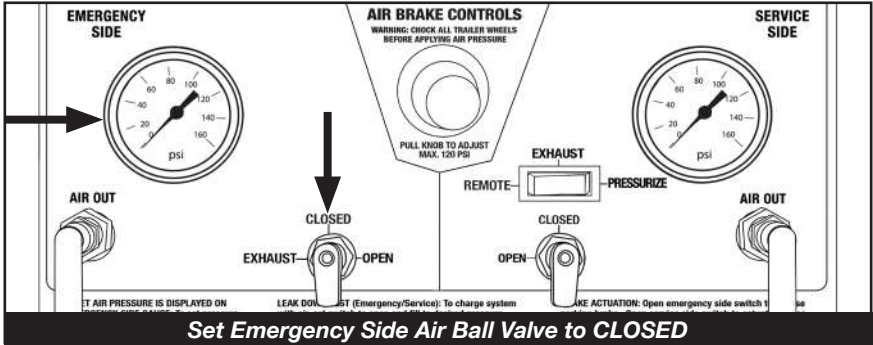

1. After setting the desired working pressure, set the Emergency Side Air Ball Valve to the CLOSED position. This will begin the leak down test.
2. Observe the needle on the air gauge and note any PSI drop after pressure stabilizes.
3. Look for air loss according to your local specifications by noting consistent air drop over time. If air pressure continues to drop at an unacceptable rate, you can turn your air supply back on by setting the Emergency Side Air Ball Valve to OPEN and attempt to find the source of the leak in the air system.

### SERVICE SIDE LEAK DOWN TESTING

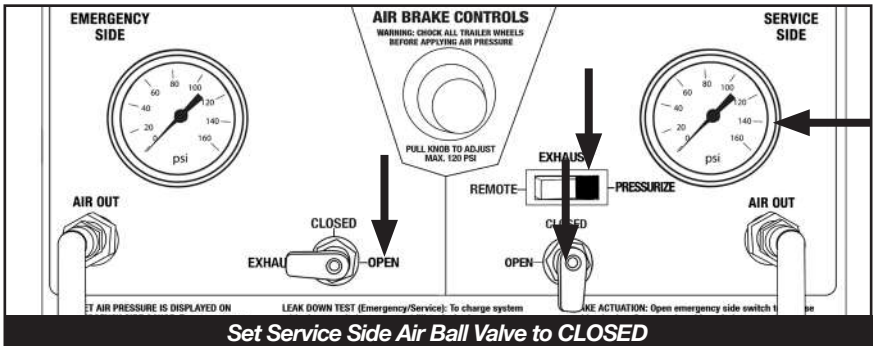

1. Set the Emergency Side and Service Side Air Ball Valves to the OPEN position. Set the Service Side Brake Control Switch to the PRESSURIZE position. (This fills the Service Side air lines.)
2. Once the Service Side is fully charged, set the Service Side Air Ball valve to the CLOSED position.
3. Observe the needle on the air gauge and note any PSI drop after pressure stabilizes.
4. Look for air loss according to your local specifications by noting consistent air drop over time. If air pressure continues to drop at an unacceptable rate, you can turn your air supply back on by setting the Service Side Air Ball Valve to OPEN and attempt to find the source of the leak in the air system.



## 8.4 ACTUATING BRAKES

This feature allows you to see the slacker adjustments and the pushrod travel in real time. Brakes can be activated manually or with the remote control.

### ACTUATE BRAKES MANUALLY

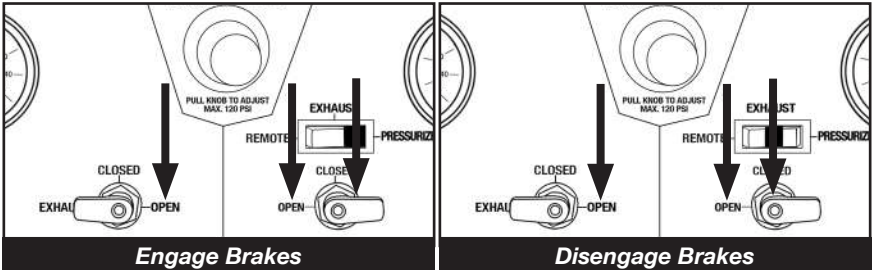

1. Charge the Emergency Side to the desired working pressure and leave both the Emergency and Service Side Air Ball Valves in the OPEN position.
2. To engage the brakes, push the Service Side Brake Control Switch to PRESSURIZE.
3. To disengage brakes, push Service Side Brake Control Switch to EXHAUST.
4. Repeat as necessary.

### ACTUATE BRAKES WITH REMOTE CONTROL

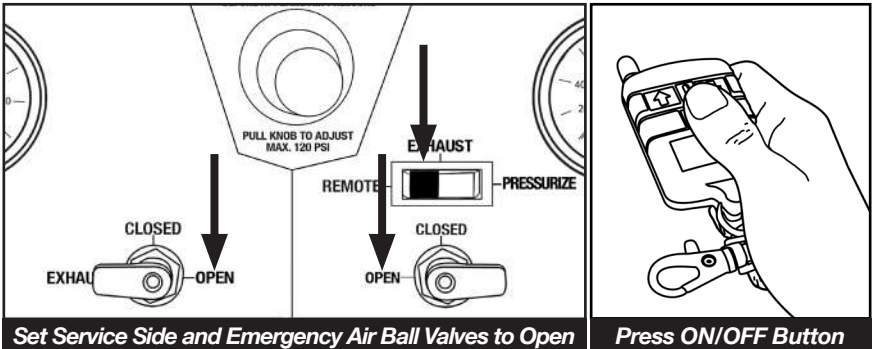

1. Charge the Emergency Side to the desired working pressure.
2. With both Air Ball Valves in OPEN position, set the Service Side Brake Control Switch to REMOTE.
3. Point the remote in the general direction of the MUTT.
4. Press the ON/OFF once to engage the service air brakes.
5. Press the ON/OFF again to disengage the brakes.
6. Repeat as necessary.

## 8.5 EMERGENCY AIR EXHAUST

To apply the parking brake at any time during testing, simply turn the Emergency Side Air Ball valve to the EXHAUST position.

1. Make sure the Power Source Switch on the Control Panel is on.
2. Set the Emergency Side Air Ball Valve to the EXHAUST position to exhaust air.

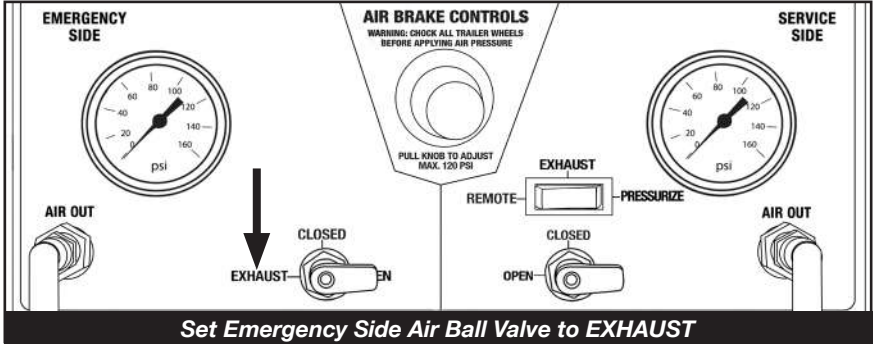

## PART 9: ABS BLINK CODE DIAGNOSTICS

---

The MUTT can be used to access ABS Blink Codes on trailers equipped with ABS systems. Trailers equipped with ABS feature an ABS Control Unit (ECU) which detects any electrical fault in the trailer ABS. Most trailers with ABS will also have a dedicated ABS lamp on the driver side. Each fault has a code. When a fault occurs, the ECU stores the code for that fault in its memory. This fault code will be displayed on the trailer ABS lamp when the proper access sequence is engaged.

### ACCESSING ABS BLINK/FAULT CODES

The MUTT provides a quick method to trigger ABS blink codes without a tractor present. Depending on the system, you will need to selectively power the Auxiliary and/or Brake Light Circuit in the correct order. Instructions on how to access several of the most common ABS systems can be found below.

Once the correct manufacturer's specific sequence is performed, you then must assess the trailer ABS lamp. The number of blinks displayed on the trailer ABS lamp will correspond to a specific ABS fault. As each manufacturer uses different access methods and each blink code has different meanings, the remainder of the ABS section will be broken down by the brand of ABS system installed on the trailer you wish to test.

**Note:** ABS Manufacturer Access Protocols/Blink Codes are subject to change. Please consult specific ABS manufacturer manuals for more detailed information and any discrepancies in their literature shall supersede the following directions.

## 9.1 MERITOR/WABCO BLINK CODES

To access Meritor/WABCO blink codes, you must select the Auxiliary Circuit to power ON/OFF/ON in one second intervals using the following directions:

1. Make sure trailer is stationary and wheels are properly chocked.
2. On the MUTT, turn the control knob to the Auxiliary Circuit. Pause one second.
4. Turn the control knob to the Ground Integrity Indicator (one position to the right). Pause one second.
5. Turn the control knob back to the Auxiliary Circuit (one position to the left).
6. Count number of blinks on the trailer ABS lamp. Use the chart below for specific fault information.

<b>Blink Code</b>	<b>Problem Area</b>	<b>Action</b>
3	Sensor BUI	Determine sensor location. Check sensor installation. Make necessary repairs.
4	Sensor YE1	Determine sensor location. Check sensor installation. Make necessary repairs.
5	Sensor BU2	Determine sensor location. Check sensor installation. Make necessary repairs.
6	Sensor YE2	Verify proper electrical modulator installation. Check power supply. Make necessary corrections.
7	External ABS Modulator Valve	Verify proper electrical modulator installation. Check power supply. Make necessary corrections.
9	Internal modulator failure inlet valve #2	Verify proper installation. If code continues, contact Meritor WABCO for assistance.
10	Internal modulator failure inlet valve #1	Verify proper installation. If code continues, contact Meritor WABCO for assistance.
11	Internal modulator failure inlet valve	Verify proper installation. If code continues, contact Meritor WABCO for assistance.
14	Power Supply	Verify proper electrical installation. Check power supply. Make necessary corrections.
15	ECU Failure	Verify proper installation. If code continues, contact Meritor WABCO for assistance.
16	SAE J1 708 Failure	Internal failure, contact Meritor WABCO
17	SAE J2497 (PLC) Failure	Internal failure, contact Meritor WABCO
18	Generic I/O Failure	Verify proper electrical installation. Check power supply. Make necessary corrections.

## 9.2 HALDEX BLINK CODES

To access Haldex Blink Codes, you must select the Brake Light Circuit and press the control knob to cycle the Auxiliary Circuit the appropriate number of times using the following directions:

See table below for modes and sequences:

Mode	Description	Ignition Cycles (Hold 1 Second ON/OFF)
1	Simple/Wheel Speed Mode	ON, off, ON
2	Active Faults Mode	ON, off, ON, off, ON
3	Stored Faults/Clear Mode	ON, off, ON, off, ON, off, ON
4	Configuration Mode	ON, off, ON, off, ON, off, ON, off, ON

1. Make sure trailer is stationary and wheels are properly chocked.
2. On the MUTT, turn the control knob to select Brake Light Circuit.
3. Push the control knob to cycle Auxiliary Circuit ON for each desired ignition cycle. Auxiliary Circuit will flash.
5. Each Ignition Cycle must end with both Brake Light and Auxiliary Circuits simultaneously powered. To do this, press and hold the control knob for five seconds during the last ON cycle.
6. Count number of blinks on trailer ABS lamp, see following charts (pg. 28-32) for specific fault info.

Item	Flash Count	Actual Fault
System OK	Light Stays On	07
Sensor 1A	1 Flash	01
Sensor 1B	2 Flashes	02
Sensor 2A	3 Flashes	03
Sensor 2B	4 Flashes	04
Sensor 3A	5 Flashes	05
Sensor 3B	6 Flashes	06
Red Valve	7 Flashes	61, 67, 71, 77, 81, & 87
Blue Valve	8 Flashes	62, 68, 72, 78, 82, & 88
Yellow Valve	9 Flashes	63, 69, 73, 79, 83, & 89
Low Voltage	10 Flashes	90
ECU Failure	11 Flashes	93, 99, & E-Codes

Fault Code	Explanation	Possible Causes	PLC Select 1M	PLC Select 2M
00	System OK (with vehicle traveling > 6 mph)	ABS is operational Displays "00" when traveling > 6 MPH	X	X
01	Red channel wheel speed sensor wiring S1A has an Open or Short circuit.	Indicates a wheel speed sensor or its wiring has short or open circuit. Disconnect the relevant sensor and measure the resistance between the two pins in the sensor connector housing.  If sensor extensions are used verify extension continuity and connections. Replace sensor and/or extension cable.  The Ohm meter reading for the sensor or sensor and extension cable should be between 980 and 2350 Ohm (.98K and 2.35K Ohm) If not, replace sensor and/or extension cable.	X	
02	Red channel wheel speed sensor wiring S1B has an Open or Short circuit.		X	
03	Blue channel wheel speed sensor wiring S2A has an Open or Short circuit.			X
04	Yellow channel wheel speed sensor wiring S2B has an Open or Short circuit.			X
05	Blue channel wheel speed sensor wiring S3A has an Open or Short circuit.			X
06	Yellow channel wheel speed sensor wiring S3B has an Open or Short circuit.			X
07	System OK (No Active Fault)	ABS ECU is fully operational. Displays "07" vehicle is stationary	X	X
11	Red channel speed sensor S1A has low sensor output	Sensor or spring clip is worn or not properly adjusted, wiring open or short circuit, wheel bearing not properly adjusted (these faults will only occur at speeds of greater than 6 mph). Measure the AC voltage at the sensor in question while rotating the wheel at a rate of about one revolution every two seconds. The output should be at least 200 millivolts (0.2 VAC). If this is not the case, push in the sensor until it touches the exciter and rotate the wheel again. If this doesn't correct the problem, then the sensor and the sensor block clip should be replaced.  If sensor extensions are used verify extension continuity and connections. Replace sensor and/or sensor cable.  Inspect exciter teeth for minor damage or teeth filled with debris. Verify all exciters have the same number of teeth.  Verify sensor and valve wiring/plumbing is correct.  See side by side axle by axle configurations.	X	
12	Red channel speed sensor S1B has low sensor output.		X	
13	Blue channel speed sensor S2A has low sensor output.			X
14	Yellow channel speed sensor S2B has low sensor output.			X
15	Blue channel speed sensor S3A has low sensor output.			X
16	Yellow channel speed sensor S3B gap too large. Gap should be kept to a minimum.			X

Fault Code	Explanation	Possible Causes	PLC Select 1M	PLC Select 2M
21	Red channel wheel speed sensor S1A has an erratic output voltage.	<p>Loose sensor, connection , bracket or exciter, damaged exciter, sensor is not properly adjusted or has worn cable insulation, or worn sensor block clip, wheel bearing failure, wheel bearing is not properly adjusted <b>(these faults will only occur at speeds greater than 6 mph)</b>.</p> <p>Measure the AC voltage at the sensor in question while rotating the wheel at a rate of about one rotation every two seconds. The output should be at least 200 millivolts (0.2 VAC).</p> <p>If this is not the case, push in the sensor until it touches the exciter and rotate the wheel again. If this doesn't correct the problem, then the sensor should be replaced.</p> <p>Verify the tire and wheel size is large enough for 100 tooth exciter ring. If these faults re-occur at the same speed, inspect the exciter ring for damage.</p> <p>Smaller wheels and tires require 80 tooth exciter rings. Reference Tire Scale Factor Chart.</p> <p>Verify sensor and valve wiring/plumbing is correct.</p> <p>See side by side and axle by axle configurations.</p>	X	
22	Red channel wheel speed sensor S1B has an erratic output voltage.		X	
23	Blue channel wheel speed sensor S2A has an erratic output voltage			X
24	Yellow channel wheel speed sensor S2B has an erratic output voltage.			X
25	Blue channel wheel speed sensor S3A has an erratic output voltage.			X
26	Yellow channel wheel speed sensor S3B has an erratic output voltage.			X

**Occurs Only When Vehicle is Stationary**

31	Auxiliary channel 1 fault (digital channel 1) output only	<p>PLC Select 2M Plus (ABS Auxiliary Codes)</p> <p>Note: These Codes are only used with PLC Select 2M Plus ABS that supports trailer Auxiliaries.</p> <p>Auxiliary Channel has an open circuit or the ECU (Electronic Control Unit) has an auxiliary device connected and is not programmed to be.</p> <p>Note: These codes do not affect ABS performance and do not illuminate the tractor trailer ABS warning lamps.</p>		
32	Auxiliary channel 2 fault (digital channel 2) output only			
33	Auxiliary channel 3 fault (digital channel 3) output only			
34	Auxiliary channel 4 fault (digital channel 4) output only			
35	Auxiliary channel 5 fault (digital channel 5) output only			

<b>Fault Code</b>	<b>Explanation</b>	<b>Possible Causes</b>	<b>PLC Select 1M</b>	<b>PLC Select 2M</b>
41	Slow wheel recovery on Red valve channel.	For a 2M System, verify sensor and valve wiring/plumbing is correct. (See Side-By-Side and Axle-By-Axle configurations). Slow brake release, foundation brake mechanical faults, dry bushings, broken ABS valve, restricted piping. Check for kinks and blockage etc., incorrect air-lines, wiring.	X	
42	Slow wheel recovery on Blue valve channel.			X
43	Slow wheel recovery on Yellow valve channel.			X
61	Hold solenoid Open circuit on Red valve channel.	Modulator valve solenoid failure, solenoid connection, or valve cable damage. The most likely causes include: a bad solenoid or a loose solenoid connection. Disconnect the indicated solenoid and check the resistance at the solenoid pins.  Check the female terminals on the connector for excessive pin spread or corrosion. Replace defective hardware as required and retest.	X	
62	Hold solenoid Open circuit on Blue valve channel.			X
63	Hold solenoid Open circuit on Yellow valve channel.			X
67	Dump solenoid Open circuit on Red valve channel.			X
68	Dump solenoid Open circuit on Blue valve channel.			X
69	Dump solenoid Open circuit on Yellow valve channel.			X
71	Hold solenoid Short circuit to ground on Red valve channel.	Modulator valve solenoid failure, or value cable damage. The most likely causes include: a damaged cable or solenoid. An example of this is a worn or chafed cable that has exposed wires contacting the trailer.  Disconnect the indicated solenoid and check the resistance at the solenoid pins.	X	
72	Hold solenoid Short circuit to ground on Blue valve channel.			X
73	Hold solenoid Short circuit to ground on Yellow valve channel.			X
77	Dump solenoid Short circuit to ground on Red valve channel.			X
78	Dump solenoid Short circuit to ground on Blue valve channel.			X
79	Dump solenoid Short circuit to ground on Yellow valve channel.			X



<b>Fault Code</b>	<b>Explanation</b>	<b>Possible Causes</b>	<b>PLC Select 1M</b>	<b>PLC Select 2M</b>
80	Output leakage or poor insulation on any of the valve channels.	Modulator valve solenoid failure or valve cable damage. Indicates that the solenoid or its cable has a short circuit to positive power (12 volts DC). The most likely cause is a damaged cable or solenoid. Disconnect the indicated solenoid and check the resistance at the solenoid pins.  If solenoid checks good and 80-89 code still exists, check ECU.	X	X
81	Hold solenoid short circuit to Permanent Power on Red valve channel.		X	
82	Hold solenoid short circuit to Permanent Power on Blue valve channel.			X
83	Hold solenoid short circuit to Permanent Power on Yellow valve channel.			X
87	Dump solenoid out shorted to Permanent Power on Red valve channel.		X	
88	Dump solenoid out shorted to Permanent Power on Blue valve Channel.			X
89	Dump solenoid out shorted to Permanent Power on Yellow valve channel.			X
90	Low supply voltage fault. This code is not stored in memory.	Verify 12 V DC power source. Do Not Use Battery Charger as Power Supply. ECU minimum operating voltage is 8.5 V DC.	X	X
91	No internal ABS ECU solenoid voltage available.	Verify permanent power is present.	X	X
92	Power input over voltage fault.	Verify 12 VDC power source. Do Not Use Battery Charger as Power Supply. ECU maximum operating voltage is 16.0 VDC.	X	X
93	Short circuit on ABS ECU internal relay.	Replace ECU	X	X
99	ABS Corrupt Memory		X	X
9A	ABS Corrupt Memory		X	

## 9.3 BENDIX BLINK CODES

To access Bendix Blink Codes you must select the Auxiliary Circuit and press the control knob to cycle the Brake Light Circuit the appropriate number of times using the following directions:

See table below for modes and sequences:

Mode	Cycle Brake Light Power
Display Active DTCs	3 times
Display Inactive DTCs	4 times
Clear Active DTCs	5 times
Display Configuration	6 times
Display Odometer Mileage	7 times
Reset Configuration	8 times

1. Make sure trailer is stationary and wheels are properly chocked.
2. On the MUTT, turn the control knob to select the Auxiliary Circuit
3. Push the control knob to cycle the Brake Light Circuit for each desired Cycle in one second intervals. The Brake Light Circuit will flash.
4. Count number of blinks on Trailer ABS Lamp; see chart below for specific fault info.

**NOTE:** Blink code “Digits” are seperated by a one second pause.

1st Digit	2nd Digit	Fault Description	Repair Information	J1587 (SID)	J1587 (FMI)
10	10	No Faults	ABS system fully operational - no faults detected	1	0

### WHEEL SPEED SENSORS (WSS)

2	1	SL Sensor signal valid -large gap	Dynamic Wheel Speed Sensor Fault. Go to Section G, on Page 29.	1	0	
3	1	SR Sensor signal valid - large air gap		2	0	
4	1	SAL Sensor signal valid - large air gap		3	0	
5	1	SAR Sensor signal valid - large air gap		4	0	
2	2	SL Sensor signal valid - loss of signal		1	1	
3	2	SR Sensor signal valid - loss of signal		2	1	
4	2	SAL Sensor signal valid - loss of signal		3	1	
5	2	SAR Sensor signal valid - loss of signal		4	1	
2	3	SL Sensor signal valid – noisy		1	2	
3	3	SR Sensor signal valid – noisy		2	2	
4	3	SAL Sensor signal valid – noisy		3	2	
5	3	SAR Sensor signal valid – noisy		4	2	
2	4	SL Sensor shorted or open		Static Wheel Speed Sensor Fault. Go to Section G, on Page 29.	1	4 or 5
3	4	SR Sensor shorted or open			2	4 or 5
4	4	SAL Sensor shorted or open			3	4 or 5
5	4	SAR Sensor shorted or open	4		4 or 5	
2	5	SL Tire diameter out of range	Verify correct tire size as desired.	1	13	
3	5	SR Tire diameter out of range	Verify proper tire inflation.	2	13	
4	5	SAL Tire diameter out of range	Verify correct number of exciting teeth.	3	13	
5	5	SAR Tire diameter out of range	Verify that the ECU has the proper tire size settings.	4	13	

4	6	SAL Sensor configuration error	Verify correct ABS configuration using blink codes or other diagnostic tools.	3	13
5	6	SAR Sensor configuration error	If needed, reset to the default ABS configuration and power-up to initiate auto-configuration.	4	13

### POWER

6	1	Over-voltage	Power supply diagnostic trouble code. Go to Section F, page 28.	251	3
6	2	Low-voltage	Power supply diagnostic trouble code. Go to Section F, page 28.	251	4
6	3	Excessive power line resistance	Power supply diagnostic trouble code. Go to Section F, page 28.	251	13

### MODULATOR (MOD)

7	1	MOD1 Hold solenoid shorted or open	Clear faults. If faults return, replace the TABS-6 Module.	42	3,4,5 6 or 12
7	2	MOD1 Release solenoid shorted or open		48	3,4,5 6 or 12
8	1	MOD2 Hold solenoid shorted or open	Static ABS Modulator Fault. Go to Section H, on Page 30.	43	3,4,5 6 or 12
9	1	MOD3 Hold solenoid shorted or open		44	3,4,5 6 or 12
8	2	MOD2 Release solenoid shorted or open		49	3,4,5 6 or 12
9	2	MOD3 Release solenoid shorted or open		50	3,4,5 6 or 12
7	3	MOD1 ABS modulator dynamic error	Dynamic ABS Modulator Fault. Go to Section H, on Page 30.	7	7
8	3	MOD2 ABS modulator dynamic error		8	7
9	3	MOD3 ABS modulator dynamic error		9	7
8	4	MOD2 Valve configuration error	Verify correct ABS configuration using blink codes or other diagnostic tools. If needed, reset to the default ABS configuration and power-up to initiate auto-configuration.	8	13
9	4	MOD3 Valve configuration error		9	13

### COMMON

10	1	Valve MOD1/2 low-side switch shorted to ground	Check for corroded/damaged wiring or connectors between the ECU and MOD. At the MOD harness connector, verify: No continuity from modulator/AUX leads to ground. After repairs or if no issues found, then clear faults If faults return, replace the TABS-6 Module.	7	4
10	2	Valve MOD3 low-side switch shorted to ground		9	4
10	3	ABS modulator dynamic error - all valves	Dynamic ABS Modulator Fault. Go to Section H, on Page 30.	7	7
10	4	Excessive ABS activity	Dynamic Wheel Speed Sensor Fault. Go to Section G, on Page 29.	1	7

### ELECTRONIC CONTROL UNIT (ECU)

11	1	ECU internal error	<p>Check for damaged or corroded connectors.</p> <p>Check for damaged wiring</p> <p>After repairs or if no issues found, then clear faults.</p> <p>If faults return, replace the TABS-6 Module.</p>	254	12
11	2	ECU configuration error	<p>Verify correct ABS configuration using blink codes, PC-diagnostics or other off-board diagnostic tools.</p> <p>If needed, reset to the default ABS configuration and power-up to initiate auto-configuration.</p>	254	13

### J1587 DIAGNOSTIC

12	1	J1587	<p>Check for corroded/damaged wiring or connectors between the ECU and J1587 Diagnostic.</p> <p>Verify the following:</p> <p>-At the 18-pin ECU harness connector:</p> <p>(a) Continuity of the J1587 Diagnostic wiring to the lamp (auxiliary device).</p> <p>(b) +12V is not measured at J1587 Diagnostic lead.</p> <p>-At J1587 Diagnostic connector:</p> <p>(a) No continuity of the J1587 Diagnostic lead to ground.</p> <p>(b) No continuity from J1587 Diagnostic lead to any other ECU pin(s).</p> <p>(c) Replace/repair J1587 Diagnostic wiring or components as required.</p>	250	3,4,5 or 12
----	---	-------	---	-----	----------------

### TRAILER-MOUNTED ABS INDICATOR LAMP

13	1	ABS lamp shorted or open	<p>Check for corroded/damaged wiring or connectors between the ECU and ABS Indicator Lamp.</p> <p>Verify the following:</p> <p>-At the 5-pin or 18-pin ECU harness connector:</p> <p>(a) Continuity of the ABS Indicator Lamp wiring to the lamp auxiliary device).</p> <p>(b) +12V is not measured at ABS Indicator Lamp lead to any other ECU pin(s).</p> <p>-At ABS Indicator Lamp connector:</p> <p>(a) No continuity of the ABS Indicator Lamp lead to ground</p> <p>(b) No continuity from ABS Indicator Lamp lead to any other ECU pin(s).</p> <p>(c) Replace/repair ABS Indicator Lamp wiring or components as required.</p>	81	3,4,5 or 12
----	---	--------------------------	--	----	----------------

# PART 10: TYPICAL TRAILER WIRING

**Note:** Not all trailers/vehicles are wired to this standard. The use of an electrical circuit tester is necessary to ensure proper match of vehicle's wiring to trailer's wiring. On some trailers with 6-way round plugs, the 12V wire and electric brake wire may be reversed (particularly horse trailers).

## Trailer Wiring (View From Front Of Plug)

### 6-WAY ROUND PIN PLUG

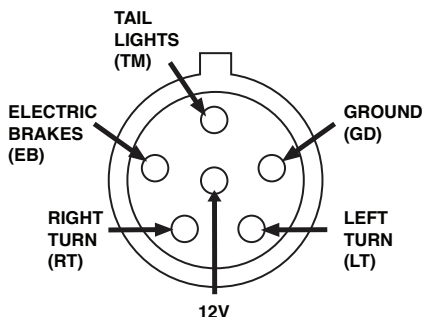

### TRAILER SIDE 7-WAY ROUND PIN SOCKET CONFIGURATION

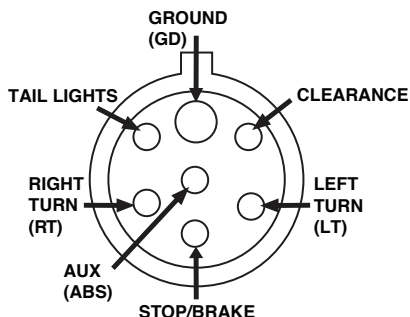

### 7-WAY FLAT PIN PLUG

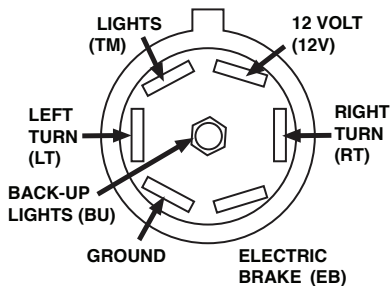

### 4/5 PIN PLUG

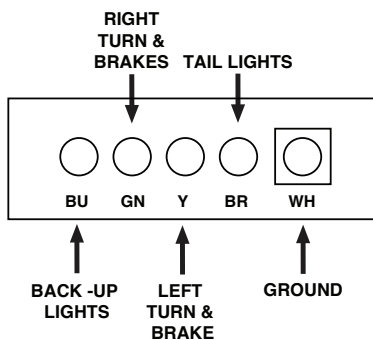

## **PART 11: MAINTENANCE AND STORAGE**

---

- Switch power to OFF, remove all power cables, and disconnect battery before storing and cleaning.
- Wipe surfaces down with a well-wrung, soft, damp cloth.
- Diluted dishwashing liquid or similar substance can be used in the dampened cloth if necessary.
- Dielectric grease can be used in 7-way round socket and cable, as well as battery clamps, to prevent corrosion.
- Disconnect and remove battery when placing the MUTT into long-term storage.
- Store in a cool, dry area.

## **PART 12: ADDITIONAL TESTING PROCEDURES**

---

There are many safety and operational functions to test on a trailer, but there are a few which are widely regarded as VERY important. With the MUTT, these tests can be performed without the truck or tractor, quickly, accurately, and in most cases, with only one person. Below are a few common system checks that can be performed using the MUTT.

- One-man leak and shake testing throughout the trailer.
- Push rod travel measurements.
- Slacker adjustment reading specific to manufacturer's specifications on brake chamber and proper operation notes.
- Even brake pressure activation.
- One-man, wheel, off-ground testing for brake strength and operation.

# PART 13: OPTIONAL ACCESSORIES AND RELATED PRODUCTS

**#9008-DL SUPER MUTT® DELUXE:** 3 Remotes, Face Shield, 10 ft. Chassis Ground Cable, 7-Way Cable, 8 ft. Glad Hands, Battery Charger, External Power Adapter, Rain Cover.

**#9049M FLEET TANK SWEEPER®:** Extra 10 Micron Filter, Intake and Output Hoses, Output and Input Wands.

**#9060C MOBILE TIRE PRESSURE EQUALIZER:** Five Color-Coded Air Hoses; Two Panel-Mounted, High-Flow Regulators; Two Panel-Mounted, Highly Accurate Air Gauges; Five Lock-On Air Chucks.



9008-DL



9049M



9060C

**#8026**  
**4/5 PIN TOWING**  
**MAINTENANCE KIT**



**#7866**  
**4/5 PIN TRAILER HARNESS**  
**CHECKER**



**#8027**  
**6 ROUND PIN TOWING**  
**MAINTENANCE KIT**



**#7897**  
**6 ROUND PIN TRACTOR**  
**TRAILER CIRCUIT TESTER**



**#8028**  
**7 FLAT (SPADE) PIN**  
**TOWING MAINTENANCE**  
**KIT**



**#7893**  
**7 FLAT (SPADE) PIN**  
**TRAILER CIRCUIT TESTER**



**#8029**  
**7 ROUND PIN TOWING**  
**MAINTENANCE KIT**



**#7865L**  
**7 ROUND PIN TRACTOR**  
**TRAILER CIRCUIT**  
**TESTER**



**#8000**  
**3-WAY TRAILER**  
**ADAPTER**



**#TSTPK1**  
**MULTI-TRAILER TESTER**  
**JOBBER PACK**

