



CAR710W

7" CAPACITIVE TOUCH SCREEN
2 DIN MULTIMEDIA MECHLESS RECEIVER

AM-FM
USB Media Player
Rear Camera Input

INSTALLATION & OWNER'S MANUAL

androidauto



JENSEN®

Safety Notes

Video playback will not operate while the vehicle is moving.

This is a safety feature to prevent driver distraction. In-dash video functions will only operate when vehicle is in Park and the parking brake is engaged. It is illegal in most jurisdictions for the driver to view video while the vehicle is in motion.

The SAFETY NOTICE is reminder to drive responsibly and safely while using your mobile phone device, or any APP's that are compatible with this unit.

It is highly recommended that your JENSEN CAR710W is installed by a professional installer or an authorized dealer.

This product is only for use in vehicles with 12VDC negative ground only.

To prevent damage or injury:

- Make sure to ground the unit securely to the vehicle chassis ground.
- Do not remove the top or bottom covers of the unit.
- Do not install the unit in a spot exposed to direct sunlight or excessive heat or th possibility of water splashing.
- Do not subject the unit to excessive shock.
- When replacing a fuse, only use a new one with the correct rating. Using a fuse wit the wrong rating may cause the unit to malfunction.
- To prevent short circuits when replacing a fuse, disconnect the wiring harness first.
- Use only the provided hardware and wire harness.
- If you experience problems during installation, consult your nearest JENSEN deale .
- If the unit malfunctions, reset the unit as described. If the problem still persists consult your nearest JENSEN dealer or call tech assistance @ 1-888-921-4088.
- To clean the monitor, wipe only with a dry silicone cloth or soft cloth. Do not usea stiff cloth, or solvents such as paint thinner and alcohol. They can scratch the surface of the panel and/or remove the printing.
- When the temperature of the unit falls (as in winter), the liquid crystal inside th screen will become darker than usual. Normal brightness will return after the unit is in use for a while.
- When extending the ignition, battery or ground wiring, make sure to us automotive-grade wiring with an a minimum AWG 16 or more to prevent voltage drops.
- Do not touch the liquid crystal fluid if the LCD is damaged or broken. The liqui crystal fluid may be hazardous to your health or fatal. If the liquid crystal fluid from the LCD contacts your body or clothing, wash it off with soap immediately.

Copyright Notes

This product incorporates copyright protection technology that is protected by method claims of certain U.S. patents and other intellectual property rights owned by Macrovision Corporation and other rights owners. Use of this copyright protection technology must be authorized by Macrovision Corporation, and is intended for home and other limited viewing uses only unless otherwise authorized by Macrovision Corporation. Reverse engineering or disassembly is prohibited.

SiriusXM and all related marks and logos are trademarks of Sirius XM Radio, Inc. All rights reserved.

The Bluetooth® word mark and logos are owned by the Bluetooth SIG, Inc.

Use of the Apple CarPlay logo means that a vehicle user interface meets Apple performance standards. Apple is not responsible for the operation of this vehicle or its compliance with safety and regulatory standards. Please note that use of this product with iPhone, iPod or iPad may affect wireless performance. Apple CarPlay is a trademark of Apple Inc. "Made for iPod" and "Made for iPhone" mean that an electronic accessory has been designed to connect specifically to iPod or iPhone, respectively, and has been certified by the developer to meet Apple performance standards. iPhone and iPod are trademarks of Apple, Inc., registered in the U.S. and other countries.

Availability of Android Auto™ may vary depending upon your country and phone model. Please visit android.com/auto for more information. Android, Android Auto, Google and other marks are trademarks of Google Inc.

Other trademarks and trade names are those of their respective owners.

Table of Contents

	Page
Warning Statement	3
FCC Compliance	4
Preparation/Mounting	5
Wiring Diagram	6
Control Locations	7
General Operation	8-9
Audio Operation	10
AM/FM Tuner Operation	11
USB Operation	12
Media Compatibility	13-14
Bluetooth Operation	17-16
SiriusXM® S satellite Radio Operation	16-20
SiriusXM® Radio Advisory Messages	21
Apple CarPlay	22-23
Android Auto	24-25
Auxiliary Inputs/Rear Camera Operation	26
SWC Input Operation	27
Troubleshooting	28
Specifications	29
Warranty	30

⚠ WARNING ⚠

Upon installation of this monitor/media player ("unit") into a vehicle, the driver of the vehicle must not operate this unit by watching videos or playing video games while driving. Failure to follow this instruction could lead to driver distraction which could result in serious injury or death to the vehicle's occupants or persons outside the vehicle and/or property damage.

Several states prohibit the installation of monitors/media players if the screen is visible from the driver's seat. If you reside in a jurisdiction which has enacted such a law, this unit must not be installed so that the screen is visible from the driver's seat. When installing this unit in the front console/dashboard, the unit must be positioned so that it is facing the front passenger seat only. Failure to follow this instruction could lead to driver distraction which could result in serious injury or death to the vehicle's occupants or persons outside the vehicle and/or property damage.

This unit is designed so that it may be operated only when the vehicle is in "Park" and the parking brake is fully engaged. To this end, this unit includes a parking brake lock-out feature which prohibits the unit from operating if the vehicle is not in "Park" and/or the parking brake is not fully engaged. When installing this unit, the installer must connect the parking brake detect wire to the parking brake mechanism in order to make the parking brake lock-out feature operable. **DO NOT** simply ground the parking brake detect wire to a metal portion of the vehicle. Failure to properly install the parking brake lock-out feature could lead to driver distraction which could result in serious injury or death to the driver's occupants or persons outside the vehicle and/or property damage.

Once the parking brake lock-out feature is installed, the owner/user must not attempt to disrupt/neutralize the parking brake lock-out feature by (a) partially engaging the parking brake and/or (b) purchasing/using any device or unit designed to send necessary brake signals to the unit. Failure to follow these instructions could lead to driver distraction which could result in serious injury or death to the driver's occupants or persons outside the vehicle and/or property damage.

When operating this unit, keep the unit's volume level low enough so that the vehicle's occupants can hear traffic-related sounds such as police and emergency vehicles. Failure to follow this instruction could lead to driver distraction which could result in serious injury or death to the vehicle's occupants or persons outside the vehicle and/or property damage.

FCC Compliance

This device complies with Part 15 of the FCC Rules. Operation is subject to the following two conditions:

- (1) this device may not cause harmful interference, and
- (2) this device must accept any interference received, including interference that may cause undesired operation.

Warning: Changes or modifications to this unit not expressly approved by the party responsible for compliance could void the user's authority to operate the equipment.

This equipment complies with FCC radiation exposure limits set forth for an uncontrolled environment. This equipment should be installed and operated with a minimum distance of 20cm between the radiator & your body.

This transmitter must not be co-located or operating in conjunction with any other antenna or transmitter.

Note: This equipment has been tested and found to comply with the limits for a Class B digital device, pursuant to Part 15 of the FCC Rules. These limits are designed to provide reasonable protection against harmful interference in a residential installation. This equipment generates, uses and can radiate radio frequency energy and, if not installed and used in accordance with the instructions, may cause harmful interference to radio communications. However, there is no guarantee that interference will not occur in a particular installation. If this equipment does cause harmful interference to radio or television reception, which can be determined by turning the equipment off and on, the user is encouraged to try to correct the interference by one or more of the following measures:

- Reorient or relocate the receiving antenna.
- Increase the separation between the equipment and receiver.
- Connect the equipment into an outlet on a circuit different from that to which the receiver is connected.
- Consult the dealer or an experienced radio/TV technician for help.

Preparation

Before You Start

- Disconnect negative battery terminal. Consult a qualified technician for instructions.
- Avoid installing the unit where it would be subject to high temperatures, such as from direct sunlight, or where it would be subject to dust, dirt or excessive vibration.

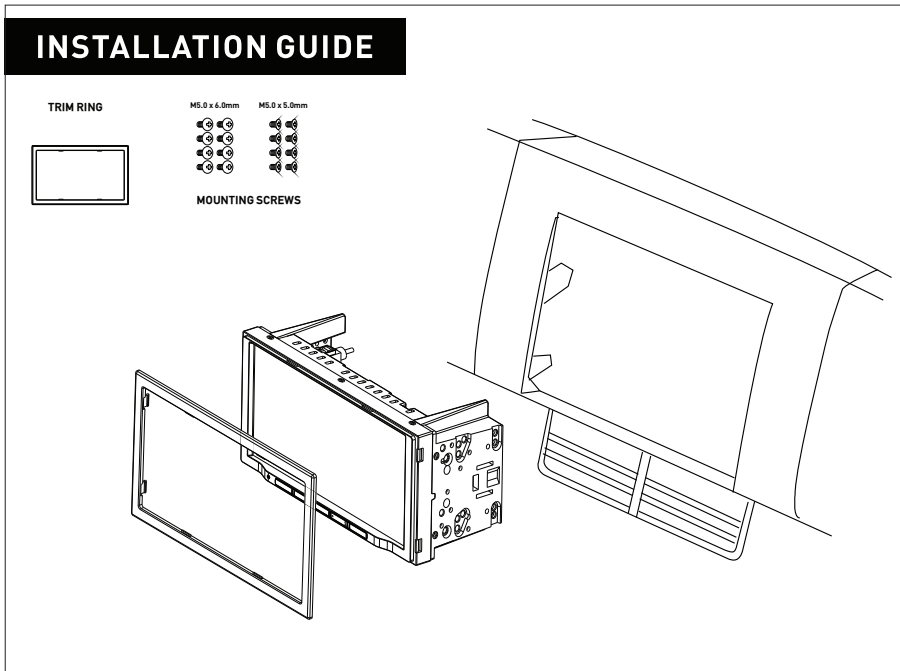

Wiring Diagram - Inputs/Outputs

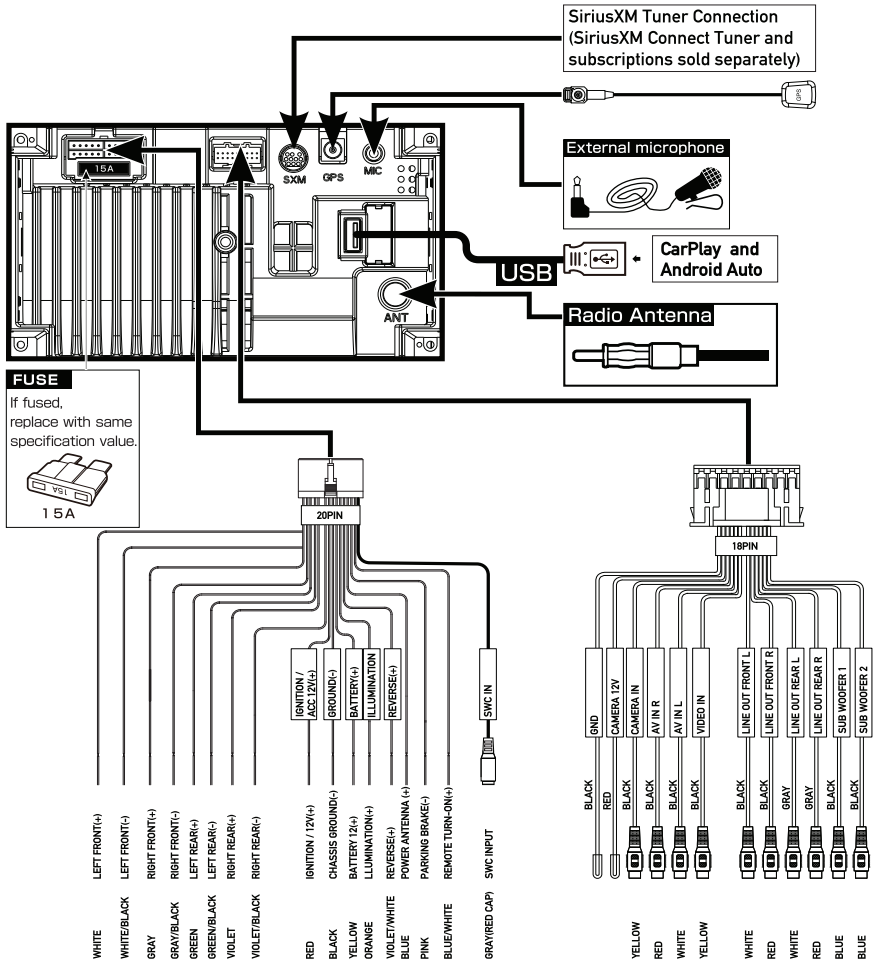

Note:

When replacing a fuse, make sure to use the correct type and amperage. Using an incorrect fuse could cause damage. The unit uses (1) 15 amp ATC mini style fuse located on the power connector.

Wiring Notes:

Subwoofer output

The Subwoofer preamp audio output (Blue jacket with Black RCA) is active in all audio modes.

Rear camera input

A rear view camera (not included) can be used with the Camera input.

SiriusXM

For more information on how to install the SiriusXM Connect Vehicle tuner, consult the installation guide included with the tuner (SiriusXM connect tuner and subscription sold separately).



Control Locations



The radio display features the following functions and displays:

- ① RESET
- ② VOL-
- ③ VOL+
- ④ POWER/MUTE
- ⑤ SOURCE
- ⑥ VOICE ACTIVATION BUTTON

General Operation

Power On/Off	Momentarily press  to turn the unit on. Press and hold to turn the unit off.
Volume	Press "VOL+" or "VOL-" to increase or decrease the volume level.
Mute	Momentarily press MUTE to silence the audio. Momentarily press MUTE again to return to the previously selected volume. Rotating the volume knob while the volume is muted will also cancel the mute function.
Mode	<p>Press MODE at the top left corner of the screen to display the main menu.</p> <p>Radio/USB/SXM/BT Phone/Android Auto/CarPlay/AV In/BT Audio/Equalizer/Settings</p> <p>Note: Modes of operation can also be accessed by selecting the corresponding icon from the main menu.</p>
Main Menu	<p>Operation Mode Selection: Press the  icon at the top left corner of the screen to display the OSD main menu. Press the Radio/USB/SXM/BT Phone/Android Auto/CarPlay/AV In/BT Audio/Equalizer/Settings in the Main menu pate to select the desired source.</p>

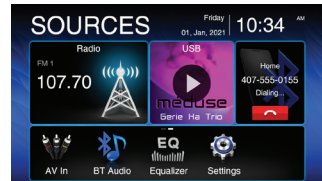

A/V In	Connect external audio/video devices to the rear RCA Type A/V Input
USB	Insert a USB flash drive to play MP3/FLAC/MP4 files.
Reset	<p>To resolve abnormal operation or if the unit is inoperable. Press the RESET button located on the front panel. The unit will reset the main processor to the default settings.</p> <p>Note: Use the tip of a pen to access the reset button. To restore the factory default software settings.</p>

General Operation

Setup Menu

From the Main Menu screen, select Setup to access the Settings menu and select from eight categories represented by the icons on the top of the screen: General, Audio, Display, Others. Select the category, and adjust any of the available options using the touch screen.

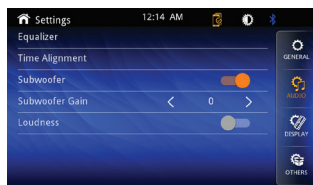
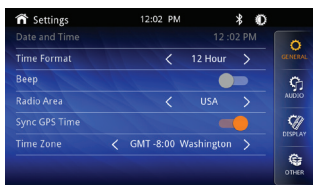

General:

- **Adjust the date and time**- Day, Month, Year, Hour, Minute and Format.
- **Time Format**- Select between 12-Hour and 24-Hour Time Format.
- **Beep Tone** - Turn the Beep Tone On or Off.
- **Radio Area** - Select Radio Region.
- **Sync GPS Time** - Synchronizes the clock time with the GPS antenna.
- **Set Time Manually** - Turn off Sync GPS Time to manually set the Time.
- **Time Zone** - Select the time zone.

Audio:

- **Equalizer**-Select between the following EQ presets: Default, User, Classic, Rock, Jazz, Electric, Pop, Soft (allows user to enter custom EQ settings).
- **Time Alignment**-To adjust time correction settings select "PRESET 1" "PRESET 2" or "PRESET 3".
- **Loudness** - Touch screen button to turn the Loudness function on/off.
- **Subwoofer Control** - Touch the button to turn the Subwoofer Control On/Off.
- **Subwoofer Gain** - Select subwoofer -15 to 0 (-6 is default).

Display:

- **Brightness**- Press > or < to adjust to desired level. (0 Minimum/20 maximum: Day: 20 is default, Night: 6 is default).
- **Dimmer Mode**- Press > or < to adjust to change the mode (Auto/Day/Night).

Others:

- **Factory Default**-Reset Bluetooth Settings or Reboot System (Including SiriusXM™ data reset) .
- **System Version**-Displays soft ware version of unit .

Audio Operation

Equalizer Menu

From the Main Menu screen. Press the Equalizer icon on the main menu screen to adjust Fader and Balance controls, Equalizer (8-Band Tone Control and 8 Presets EQ Settings).

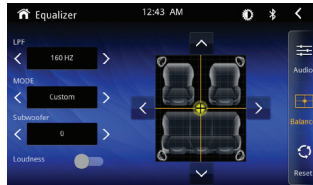

Time Alignment Menu

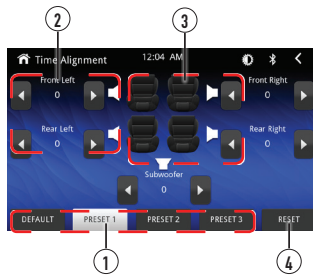

- ① Surround Presets
- ② Time Delay Setting
- ③ Speaker Positions
- ④ Reset to Default Settings

Adjustments:

To properly set the time alignment, you will need measure the distance from each speaker (in ft) to where you want the "center stage" to be. for example, if you want the position to be at the divers seat, then meaurs each speaker side (front & rear) to where your head is located and set the distance accordingly.
Each vehicle will vary in distance, so settings will be different in each case.

AM/FM Tuner Operation



Radio Operation

From the main menu, touch Radio icon on the screen to select AM/FM tuner mode.

Main Menu (1)

Press icon to return to Main Menu screen.

Current Mode Indicator (2)

Display status of various tuning functions including Auto.

Preset Stations (3)

To store a station as a preset in the current band, tune to the desired station, then press the desired preset number from the list. Press any preset in the list to recall and begin playback of that station. (Hold this button down for a few seconds and it will switch between AS and PS)

Dimmer (4)

Press the icon to adjust the brightness.

Local / Distance (5)

Press DX/LOC text to turn on the local or distance.

AS/PS (6)

Auto Store Presets: Press and hold AS/PS to automatically program the FM(18)/AM(12) available into the presets in the current Band. Preset Scan: Press AS/PS to scan through all tunable presets in the current band and play them for 3 seconds each.

Keypad (7)

Direct Search Keypad.

EQ (8)

Press the icon to adjust Equalizer setting.

Seek Tune Up (9)

Press to automatically tune to a higher frequency.

Seek Tune Down (10)

Press to automatically tune to a lower frequency.

AM (11)

Press to toggle between AM1 and AM2.

FM (12)

Press to toggle between FM1, FM2 and FM3.

USB Audio Operation

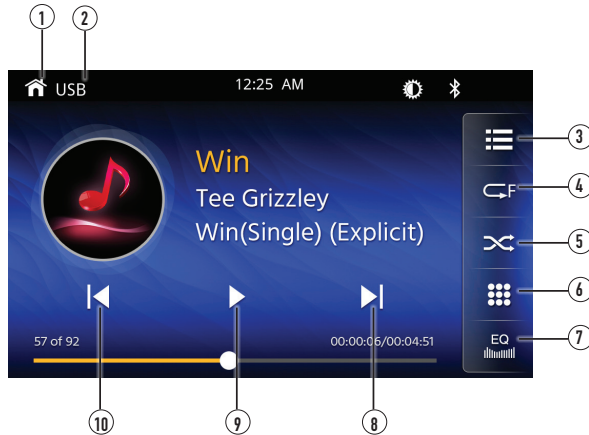

- USB** From the main menu, touch the USB icon on the main screen.
- Main Menu** (1) Press icon to return to Main Menu screen.
- Current Mode Indicator** (2) Displays source currently playing.
- List** (3) Press icon to access a list of all files and folders on the device.
 - Press to access the root directory
 - Press a folder name to access that folder, and press to return to the file list
 - Use the letter to retrieve the list of files
 - Press the "▶🎵" arrow to return to the previous screen.
- Repeat** (4) Press icon to repeat current track and adjust to repeat all tracks in the current folder. Touch RPT again to exit repeat mode.
- Random** (5) Press icon to shuffle all tacks in the current folder, and again to shuffle all tracks. Touch icon again to exit Repeat mode.
- Search** (6) Press icon to search a music file.
- EQ** (7) Press the icon to adjust Equalizer setting.
- Track Up** (8) Press icon to skip ahead to the next song
- Play / Pause** (9) Press icon to pause or resume playback.
- Track Down** (10) Press icon to return to the beginning of the current track.

Media Compatibility

File Type		MP3		
File System	FAT	FAT 12	X	
		FAT 16/FAT 32	✓	
File Extension	.mp3/.MP3/.Mp3/.mP3/.flac/ogg/.MP4/.Xvid		✓	
	.rmp/.m4a		X	
MPEG Format	MPEG 1		✓	
	MPEG 2		✓	
	MPEG 2.5		✓	
Sampling Frequency	MPEG 1		32/44.1/48kHz	
	MPEG 2		12/16/22.05/24kHz	
	MPEG 2.5		8/11.025/12kHz	
Bitrate	MPEG 1		32 ~ 320kbps	
	MPEG 2		8 ~ 160kbps	
	MPEG 2.5		8 ~ 160kbps	
Other Information	Directory Depth		Unlimited	
	File Name Length		32 bytes	
	Total File Number		2000 files	
	Total Folder Number		200 folders	
	File Number via Folder		2000 files	
	MP3 ID3 TAG	ver.1.x		✓
		ver.2.x		✓
Title, Artist, Album		✓		

Notes:

- Due to ongoing technological advancement, some USB flash drives may be incompatible with this unit.

Media Compatibility

Media Compatibility	<p>The following types of files are not compatible:</p> <ul style="list-style-type: none">• MP3 PRO format, MP3 playlists• RMP format• AAC, protected AAC, M4A format
Playback Order	<p>MP3 playback sequence begins in the root folder of the USB device. Any empty folders or folders that do not include MP3 files are skipped.</p>
Compatible Recording Formats	<p>ISO9660 standards:</p> <ul style="list-style-type: none">• Maximum nested folder depth is 8 (including the root folder).• Valid characters for folder/file names are letters A-Z (all caps), numbers 0-9, and “_” (underscore). Some characters may not be displayed correctly, depending on the character type.• This device can play back files in Joliet and other standards that conform to ISO9660. MP3 written in the formats other than the above may not play and/or their file names or folder names may not be displayed properly.
Notes	<p>Some files may not play or be displayed correctly, depending on sampling rates and bit rates.</p> <p>For best results, use the following settings when ripping MP3 files: 128kbps or higher constant bit rate 44.1kHz or higher sampling frequency</p>

Bluetooth Operation

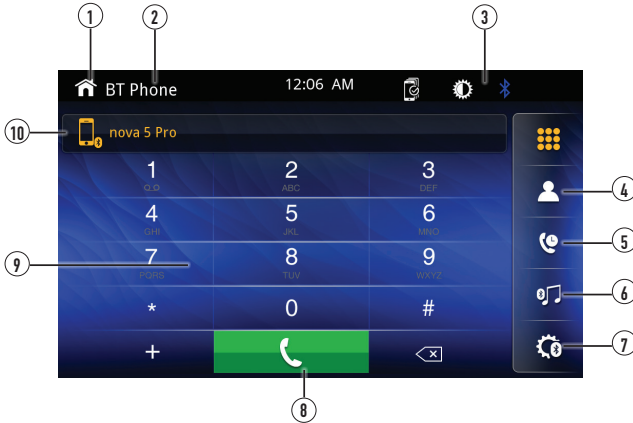

Before using Bluetooth

Before you can use a Bluetooth device to make hands-free calls or stream audio, it must be authenticated. This is also referred to as "pairing" a device.

Pairing a New Device

The unit broadcasts the pairing signal constantly when no devices are currently connected. Complete the pairing sequence from your Bluetooth device. Refer to the owner's manual for your device for more details. **The device name is "CAR710W".** The unit can be in any mode of operation when pairing is performed. On certain phones, pairing may need to be done more than once.

Connect

The head unit will automatically connect to the last connected device when the connect feature is set to Auto connect On. If the connect feature is set to Auto Connect Off, the head unit will not automatically connect to any device.

Bluetooth Phone

From the main menu, touch the **Bluetooth** on the screen. Bluetooth icon will appear anytime a Bluetooth device is connected.

Main Menu (1)

Press  icon to return to Main Menu screen.

Current Mode Indicator (2)

Displays current mode of operation.

Bluetooth Status indicator (3)

When Bluetooth is On and a Bluetooth device is being paired, the indicator will flash. When Bluetooth is On and a phone is connected to the unit, the indicator will illuminate steady.

Phone Book (4)

Press "CONTACTS" to access phone book menu.

Call Log (5)

Press the Call Log to show(Dialed, Missed and Received Calls).

Bluetooth Operation

- Bluetooth Music** (6) Press MUSIC to transfer audio between the unit and mobile phone.
- Setup** (7) Press "SETUP" to access Bluetooth settings.
- Call** (8) Dial a number and touch the Phone icon to call.
- Phone Keypad** (9) Use the keypad to dial a phone number.
- Devices** (10) Press the DEVICES to show the pairing device list. To connect to a previously connected device. press the current device name. Any previously connected devices that are in rang will be listed by their device name. Press the desired device name to disconnect from the current device and connect to the new device.

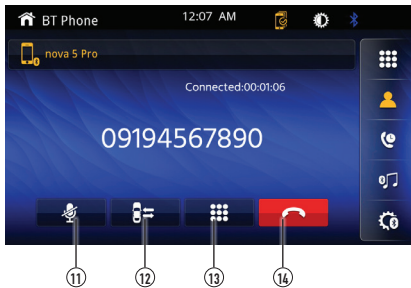

- Microphone** (11) Turn the Microphone voice On or Off.
- Audio Transfer Button** (12) Press to transfer audio between the unit and mobile phone.
- Keypad** (13) Press to return to the Keypad screen.
- End Call** (14) Press the End icon on screen or the End button on the front Panel to end a call in progress or o reject an incoming call.
- Track Down** (15) Press ◀ icon to return to the beginning of the current track.
- Play / Pause** (16) Press ▶/|| icon to pause or resume playback.
- Track Up** (17) Touch ▶ icon to skip ahead to the next song.
- EQ** (18) Press the EQ icon to adjust Equalizer setting.

SiriusXM® Satellite Radio Operation



SiriusXM® Radio

Only SiriusXM® Satellite Radio brings you more of what you love to listen to, all in one place. Get over 140 channels, including commercial-free music plus the best sports, news, talk, comedy and entertainment. Welcome to the world of satellite radio. A SiriusXM Vehicle Tuner and Subscription are required. For more information, visit www.siriusxm.com.

Activating SiriusXM® Radio

After installing your SiriusXM Connect Vehicle Tuner and antenna, power on your radio and select SiriusXM mode. You should be able to hear the SiriusXM preview channel on Channel 1. After you can hear the Preview channel, tune to Channel 0 to find the Radio ID of your tuner. The In addition, Radio ID is located on the bottom of the SiriusXM Connect Vehicle Tuner and its packaging.

Note: SiriusXM Radio ID does not include the letters I, O, S or F.

In the USA, activate online or by calling SiriusXM Listener care:

- Visit www.siriusxm.com/activatenow
- Call SiriusXM Listener Care at 1-866-635-2349

For Canadian Subscriptions, please contact:

- Visit www.siriusxm.ca/activatexm
- Call XM customer Care at 1-877-438-9677

Activation typically takes 10-15 minutes, but may take up to one hour. It is recommended to leave your vehicle on until the "Subscription Updated" message appears. Your radio will need to be powered on and receiving the SiriusXM signal to receive the activation message.

Once activated, you can tune to channels in your subscription plan.

Accessing SiriusXM® Radio

From the Main Menu, touch the SiriusXM icon to access SiriusXM mode and begin operation.

SiriusXM® Satellite Radio Operation

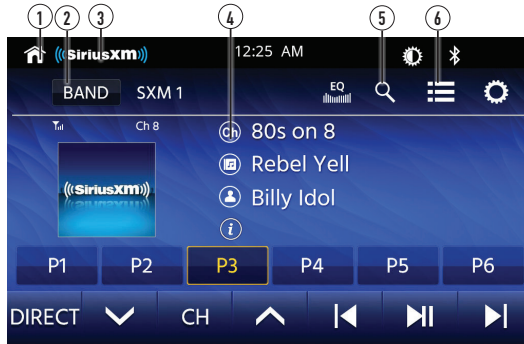

Main Menu ① Press icon to return to Main Menu screen.

Band ② Touch to select a band of preset channels. Three bands are available: SXM1, SXM2, and SXM3. Each band can store up to six preset channels. (Preset channels are accessed from the List icon.)

Current Mode Indicator ③ Displays current mode of operation.

Program Information ④ Displays program information such as channel name, artist name and song title.

Search ⑤ Press to enter search mode, then press Channel to choose between the following search options: Channel, Artist, Song Title or Info. Use the up/down arrows on the left side to navigate categories, and use the up/down arrows on the right side to navigate channels, artists, song titles or info.



Category & Channel

Preset Channel List ⑥ Press to display a list of preset channels in the current band.

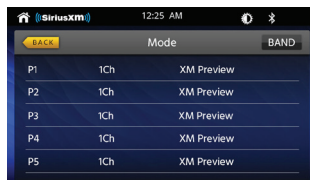

Preset Channel List

SiriusXM® Satellite Radio Operation

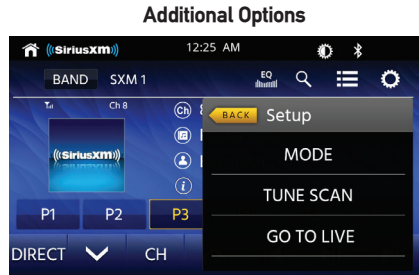
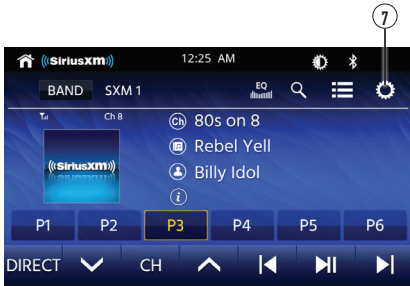

Additional Options ⑦

Press to display/adjust the options Mode, Tune Scan and Go to Live:

Mode - Press to access and adjust the following options:

- **Parental Code** - When enabled, the Parental Control feature requires you to enter a passcode to tune to the locked channels. Press "Change" to change the parental code. Follow the prompts to enter the current code, then enter and confirm the new code. The default code for the unit is "0000".
- **Parental Control** - The Parental Control feature allows you to limit access to any SiriusXM channels, including those with mature content. Select a Parental Control option: Off (turns Parental Control off) Mature (locks all mature channels) or User (allows the user to lock specific channels using the Parental Lock Channel feature). Enter the Parental Code when prompted to confirm the change.
- **Parental Lock Channel** - Press "SET" to select specific channels to lock. Press "All Clear" to clear all locked channels.
- **Channel Skipping** - Press "SET" to select channels to skip.
- **TuneStart™** - Press "ON" or "OFF" to enable or disable TuneStart. With the TuneStart feature turned ON, you will hear the beginning of the song when you tune to one of your Preset channels. It may take a minute or two for the feature to work after power up or after changing preset bands.

TuneScan™

Press TuneScan button to initiate the TuneScan function. The unit plays samples from the start of multiple buffered songs from each of the Preset Channels that predominantly play music selections. This gives the user easy access to a large sampling of music content, and they can enjoy hearing a full song when stopping the scan on a song of interest. Pressing TuneScan again will stop the TuneScan function and continue playing the song currently being scanned. Pressing and holding the TuneScan button cancels the TuneScan and returns the user to the original channel that was tuned when TuneScan was first initiated.

Go to Live- Press to resume play of live broadcast while in Replay mode.

SiriusXM® Satellite Radio Operation

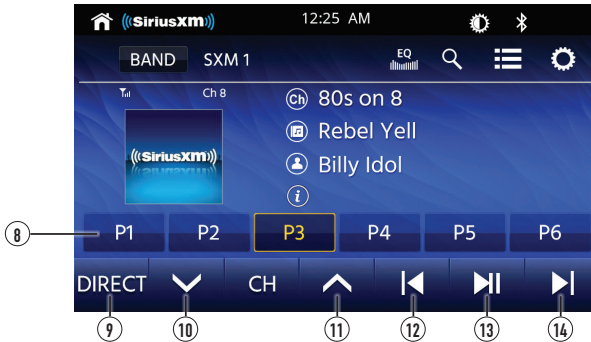

- Preset Buttons** (8) Press and hold any preset button (1-6) to save the current station as a preset. Press the desired preset button to begin playback of the corresponding preset channel.
- Direct** (9) Press to display screen for direct channel access. Press the desired channel number, then press Enter. Playback of desired channel will begin.
- Channel Down** (10) Press to go back to the previous channel.
- Channel Up** (11) Press to advance to the next channel.
- Tune / Track Down** (12) Press to enter Replay mode. Once in Replay mode, press to skip to the previous track or press and hold to fast reverse.
- Play / Pause** (13) Press to pause and replay content from the active channel.
- Tune / Track Up** (14) Press to skip to the next track. Press and hold to fast forward. Press repeatedly to "catch up" and resume live play. Selecting **Go to Live** under Additional Options will also resume live play.

SiriusXM® Radio Advisory Messages

SiriusXM® Advisory Message	Recommendation
Check Antenna	<ol style="list-style-type: none"> 1. The radio has detected a fault with the SiriusXM® antenna. The antenna cable may be either disconnected or damaged. 2. Verify that the antenna cable is connected to the SiriusXM® Connect Vehicle Tuner. 3. Inspect the antenna cable for damage and kinks. Replace the antenna if the cable is damaged. 4. SiriusXM® products are available at your local car audio retailer or online at www.shop.siriusxm.com.
Check Tuner	<ol style="list-style-type: none"> 1. The radio is having difficulty communicating with the SiriusXM® Connect Vehicle Tuner. The tuner may be disconnected or damaged. 2. Verify that the SiriusXM® Connect Vehicle Tuner cable is securely connected to the radio.
No Signal	<ol style="list-style-type: none"> 1. The SiriusXM® Connect Vehicle Tuner is having difficulty receiving the SiriusXM® satellite signal. 2. Verify that your vehicle is outdoors with a clear view of the sky. 3. Verify that the SiriusXM® magnetic mount antenna is mounted on a metal surface on the outside of the vehicle. 4. Move the SiriusXM® antenna away from any obstructions. 5. Inspect the antenna cable for damages and kinks. 6. Consult the SiriusXM® Connect Vehicle tuner installation manual for more information on antenna installation. Replace the antenna if the cable is damaged. SiriusXM® products are available at your local car audio retailer or online at www.shop.siriusxm.com.
Subscription Updated	<p>The radio has detected a change in your SiriusXM® subscription status. Press <<  >> to clear the message. In the USA, visit www.siriusxm.com or call 1-866-635-2349 if you have questions about your subscription. In Canada, visit www.siriusxm.ca or call 1-877-438-9677 if you have questions about your subscription.</p>
Channel Unavailable	<p>The channel that you have requested is not a valid SiriusXM® channel or the channel that you were listening to is no longer available. You may also see this message briefly when first connecting a new SiriusXM® Connect Vehicle tuner. Visit www.siriusxm.com for more information about the SiriusXM® channel lineup.</p>
Channel Unsubscribed	<p>The channel that you have requested is not included in your SiriusXM® subscription package or is no longer included in your SiriusXM® subscription package. In the USA, visit www.siriusxm.com or call 1-866-635-2349 if you have questions about your subscription. In Canada, visit www.siriusxm.ca or call 1-877-438-9677 if you have questions about your subscription.</p>
Channel Locked	<p>The channel that you have requested is locked by the radio's Parental Control feature. Refer to the SiriusXM® Satellite Radio Operation section for more information on the Parental Control feature and how to access locked channels.</p>
No Content	<p>TuneScan is not available. Please allow the tuner some time to buffer new songs to scan.</p>
Invalid Lock code	<p>If "Invalid Lock code" message displayed on the screen, it will disappear automatically after three seconds. And then user can insert the password again.</p>

Apple CarPlay Operation

Apple CarPlay™ is a smart interface for iPhone, allowing you to voice-control (via Siri) music, navigation, phone and messaging apps - significantly reducing driver distraction.



Phone - Use Siri to make calls, return missed calls, listen to voicemail messages, and view the caller ID on the receiver's screen.



Messages - Ask Siri to send, read, and reply to text messages. This hands free operation minimizes distraction and allows you to keep hands on the wheel and eyes on the road.



Music - Access music by artist, song, playlist, and more through the receiver's touchscreen or via Siri. The receiver will mirror the iPhone screen with artist and track information.



Maps - Use Siri to request turn-by-turn directions - search by address or points of interest. Apple Maps will be mirrored on the screen, including traffic information and estimated time to destination.



Made for iPhone models: iPhone12 mini, iPhone 12 , iPhone 12 Pro, iPhone 12 Pro Max, iPhone 11 Plus, iPhone 11, iPhone XS Max, iPhone XS, iPhone XR, iPhone X, iPhone 8, iPhone 8 Plus, iPhone 7, iPhone 7 Plus, iPhone 6, iPhone 6S

Wired connection

1. Connect an Apple CarPlay compatible device to this unit via USB.
2. Press the Apple CarPlay icon. The Apple CarPlay home screen appears.

Wireless connection

Before using Apple CarPlay wirelessly, turn on the Bluetooth/Wifi function on the Phone.

1. Press  icon on the main menu.
2. Press "✓" to confirm to use wireless CarPlay.
3. Press  icon to search phone device. The available devices appear on the list.
4. Find the desired device on the screen and press "Pair".
5. A pass key will be displayed on the screen.
6. The same key appears on the iPhone, press "Pair" and then press "Allow" for the popups.
7. Press "✓" on the screen to confirm to connect.
8. Press "Use CarPlay" on the iPhone. The unit configures the connection then starts the application.

Tip: Press  icon. Displays CarPlay device list. This icon appears Only When CarPlay is connected and two or more devices can be used as CarPlay Source.

Notes:

• For safety reasons, CarPlay features are limited while driving and will vary with each CarPlay-enabled app. Available functions are determined by each individual app provider. For more information, visit www.apple.com/ios/carplay.

- Certain iPhone functions may be illegal while driving in your location. Be sure to familiarize yourself with local and state laws regarding mobile devices. When in doubt, stop and park your vehicle before using any devices.
- For details on USB connection, refer to the Installation Manual.
- If an Apple CarPlay compatible device has been connected and another screen is displayed, touch [Apple CarPlay] on the top menu screen to display the Application menu screen.
- The Bluetooth connection with the Apple CarPlay compatible device will be terminated automatically if Apple CarPlay is turned on. While Apple CarPlay is turned on, only a Bluetooth audio connection will be possible for devices other than the device connected via Apple CarPlay.
- Hands-free phoning via Bluetooth wireless technology is not available while Apple CarPlay is on. If Apple CarPlay is turned on during a call on a cellular phone other than an Apple CarPlay compatible device, the Bluetooth connection will be terminated after the call ends.
- The route guidance using the internal navigation system will stop automatically if the route guidance function in Apple CarPlay is launched.

Apple CarPlay Operation

When the CarPlay menu is displayed, the home button in the lower left corner work just like the home button on your iPhone.

- ⓪ Press and hold it to summon Siri and begin your voice commands.
- ⓪ At any time during CarPlay operation, you can press this button momentarily to return to the main CarPlay menu screen.

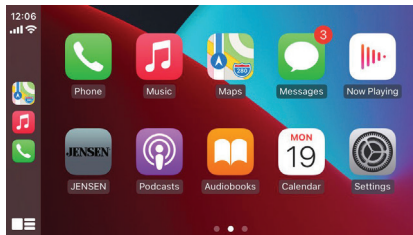

Press any Application button on the main CarPlay menu to access that operation directly. The toolbar on the left side of the screen displays the time, signal strength and shortcuts to the most popular applications - Phone, Music and Navigation - so they can be accessed quickly and easily without returning to the main menu.

Controlling Apple CarPlay™

The following basic controls will operate many standard CarPlay features.



Touch - Briefly press the desired option.



Swipe - Briefly swipe in the desired direction.



Drag - Press, hold and drag to the desired location.

Exiting Apple CarPlay™

Disconnecting your iPhone will automatically exit CarPlay mode. To exit CarPlay mode while your phone is still connected, press the Power/Volume knob momentarily, and the unit's main menu will be displayed.

Android Auto™ Operation

Android Auto™ brings the most useful apps to your phone screen or your compatible car display, in a format that makes it easy for you to keep your main focus on driving. You can control things like navigation and maps, calls and text messages, and music.

Google Assistant - With your Google Assistant on Android Auto, you can keep your eyes on the road and your hands on the wheel while using your voice to help you with your day. Simply say, "Ok Google," or in compatible cars, long press the voice control button on your steering wheel.

Navigation - Get real-time traffic alerts to avoid hazards, speed traps, and find the fastest route. Or take a break and find a bite along the way.

Calls & Messages - Your Google Assistant lets you stay connected while you're driving. Your Assistant can help you call phone numbers from your contacts, chat with your favorite apps, read your messages aloud and text back, keeping your hands on the wheel.

Compatible devices: Android Auto™ requires the Android Auto app from Google Play installed on an Android smartphone running Android Lollipop 5.0 or higher.

Warning: Certain uses of the smartphone may not be legal while driving in your jurisdiction, so you must be aware of and obey any such restrictions. If in doubt as to a particular function, only perform it while the car is parked. No feature should be used unless it is safe to do so under the driving conditions you are experiencing.

Wired connection

1. Connect an Android Auto™ compatible device to this unit via USB.
2. Press the Android Auto icon. The Android Auto home screen appears.

Wireless connection

Before using Android Auto wirelessly, turn on the Bluetooth/Wifi on the Android device.

1. Press  icon on the main menu;
2. Press "✓" to confirm to use wireless Android Auto;
3. Press "🔍" icon to search phone device. The available devices appear on the list;
4. Find the desired device on the screen and press "Pair";
5. A pass key will be displayed on the screen;
6. The same key appears on the Android device, press "Pair" and then "Allow" for popups;
7. Press "✓" on the screen to confirm to connect;

The unit configures the connection then starts the application.

Tip: Press "" icon. Displays Android Auto device list. This icon appears Only When Android Auto is connected and two or more devices can be used as Android Auto Source.

Note: When the device for Android Auto is connected to this unit, the device is also connected via Bluetooth at the same time. If five devices are already paired, the message confirming whether to delete the registered device is displayed. If you want to delete the device, touch [Agree]. If you want to delete other device, touch [BT Settings] and delete the devices manually.

Note: If Android Auto is turned on during a call on a cellular phone other than the Android Auto compatible device, the Bluetooth connection will switch to the Android Auto compatible device after the call.

Android Auto™ Operation

Using Android Auto™

The Android Auto™ home screen displays personalized information, like time to your destination, reminders, recent calls incoming messages, the song you're listening to, and Google Now cards.

When the Android Auto™ menu is displayed, you can say "OK Google" or select the microphone in the upper right corner to talk to Google.

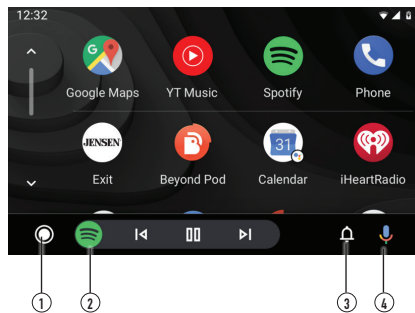

- ① Android Auto Home Button
- ② Recent Apps
- ③ Notification Button
- ④ Activate Google Assistant™

Exiting Android Auto™

To exit Android Auto™, press the Exit button. Disconnecting your Android phone will automatically exit Android Auto™ mode.

Rear RCA Input

A/V IN

Connect an optional audio/video source into the RCA (rear) input.

Adjust volume on the external audio source as needed (if connected to the headphone output of the device).

Rear Camera Operation - (Optional)

Using Rear Camera

Connect an optional rear camera to the Camera Input (Black RCA connector). Refer to the wiring diagram for details.

Auto Selection

The unit will automatically select camera mode when connected to the reverse lamp circuitry.

SWC Input Operation

The built-in SWC Interface is compatible with PAC steering wheel control modules. The PAC SWI-RC is recommended. A third-party adapter must be used in order for the CAR710W to be compatible with any steering wheel controls. The following controls are available for most vehicles.

1. Reset	4. Seek/Track Down (-)	7. Volume Down (-)	10. BT End
2. Mode	5. Mute	8. Band	
3. Seek/Track Up (+)	6. Volume Up (+)	9. BT Talk	

Note: Not all OE steering wheel functions may be supported by the CAR710W.

PAC SWI-RC Installation Hints

1. Set "Radio Select Switch". Set the SWI-RC to position 7 - "Pioneer/Other/Sony".
2. To program, use the Pioneer/Sony/Other radio function mapping order for JENSEN units.
3. When programming the SWI-RC, if a function is not supported (or not desired), then the function **MUST** be skipped as per the PAC SWI-RC instructions.
4. The SWC function **MUST** be programmed in the correct order per the PAC SWI-RC radio function mapping order instructions.

Function Order	Function Mapping	SWI-RC (3.3VDC Reference)	
		Center Pin (Ring) Voltage (Function Select)	Tip Pin Voltage
1	Reset		
2	Mode		
3	Seek + / Track +	H 3.3v	0.6
4	Seek - / Track -	H 3.3v	1.81
5	Mute	H 3.3v	1.01
6	Volume +	H 3.3v	2.07
7	Volume -	H 3.3v	2.32
8	Band	H 3.3v	2.73
9	BT Talk	L 0.0V	0.60
10	BT End	L 0.0V	1.01

Troubleshooting

General		
Problem	Cause	Action
Unit will not turn on (no power)	Yellow wire not connected or incorrect voltage Red wire not connected or incorrect voltage	Check connections for proper voltage (11-16VDC)
	Black wire not connected	Check connection to ground
	Fuse blown	Replace fuse(s)
Unit has power (but no sound)	Speaker wires not connected	Check connections at speakers
	One or more speaker wires touching each other or touching chassis ground	Insulate all bare speaker wires from each other and chassis ground
Unit blows fuse(s)	Yellow or red wire touching chassis ground	Check for pinched wire
	Speaker wires touching chassis ground	Check for pinched wire
	Incorrect fuse rating	Use fuses with correct rating
Unit has audio (but no video)	Parking brake safety circuit not connected	Check connections at parking brake
	Parking brake not applied	Apply parking brake as described on page 26

For Your Records

Please keep your original sales receipt and be prepared to provide this receipt in the event you require service, as your original receipt is considered the best proof of purchase and indicates the date you purchased your JENSEN product.

Dealer Name _____

Dealer Phone _____

Purchase Date _____

Register Your Product

Register your product online at www.jensenmobile.com.

Specifications

FM Tuner	Tuning range: 87.5MHz-107.9MHz Usable sensitivity: 10dBf 50dB quieting sensitivity: 20dBf Stereo separation @ 1kHz: 38dB Frequency response: 30Hz-13kHz
AM Tuner	Tuning range: 530kHz-1710kHz Usable sensitivity: 24uV Frequency response: 30Hz-2.3kHz
Front USB	Compatibility: High Speed USB 2.0 USB Class: Mass storage class
Monitor	Panel size: 7" diagonal measurement View angle (up/down/left/right): 50/70/70/70 Resolution: 1024 (H) x 600 (V) Brightness (cd/m ²): 500 Contrast ratio: 500:1 Pixels: 1,152,000
General	Speaker output impedance: 4 ohms Line output voltage: 2 volt RMS Line output impedance: 200 ohms Chassis dimensions: 7" x 5" x 4" (W x D x H) Design and specifications subject to change without notice.



CEA-2006 Power Standard Specifications
(reference: 14.4VDC +/- 0.2V, 20Hz~20kHz)

Power Output: 16 Watts RMS x 4 channels at 4 ohms and $\leq 1\%$ THD+N
Signal to Noise Ratio: 80dBA (reference: 1 watt into 4 ohms)

One-Year (or Two-Year*) Limited Warranty

This warranty gives you specific legal rights. You may also have other rights which vary from state to state.

Namsung America Inc warrants this product to the original purchaser to be free from defects in material and workmanship for a period of one year (or two years*) from the date of the original purchase.

Namsung America Inc agrees, at our option, during the warranty period, to repair any defect in material or workmanship or to furnish an equal new, renewed or comparable product (whichever is deemed necessary) in exchange without charges, subject to verification of the defect or malfunction and proof of the date of purchase. Subsequent replacement products are warranted for the balance of the original warranty period.

Who is covered? This warranty is extended to the original retail purchaser for products purchased from an authorized JENSEN dealer and used in the U.S.A.

What is covered? This warranty covers all defects in material and workmanship in this product. The following are not covered: software, installation/removal costs, damage resulting from accident, misuse, abuse, neglect, product modification, improper installation, incorrect line voltage, unauthorized repair or failure to follow instructions supplied with the product, or damage occurring during return shipment of the product. Specific license conditions and copyright notices for the software can be found via www.jensenmobile.com.

Warranty Coverage

Limited 1-year warranty when purchased from an authorized Jensen dealer.

or

*Limited 2-year warranty when purchased from and professionally installed by an authorized Jensen dealer. (Proof of purchase and Installation required)

What to do?

1. Before you call for service, check the troubleshooting guide in your owner's manual. A slight adjustment of any custom controls may save you a service call.
2. If you require service during the warranty period, you must carefully pack the product (preferably in the original package) and ship it by prepaid transportation with a copy of the original receipt from the retailer to an authorized service center.
3. Please describe your problem in writing and include your name, a return UPS shipping address (P.O. Box not acceptable), and a daytime phone number with your shipment.
4. For more information and for the location of the nearest authorized service center please contact us by one of the following methods:
 - Call us toll-free at (888) 921-4088
 - E-mail us at cs@jensenmobile.com

Exclusion of Certain Damages: This warranty is exclusive and in lieu of any and all other warranties, expressed or implied, including without limitation the implied warranties of merchantability and fitness for a particular purpose and any obligation, liability, right, claim or remedy in contract or tort, whether or not arising from the company's negligence, actual or imputed. No person or representative is authorized to assume for the company any other liability in connection with the sale of this product. In no event shall the company be liable for indirect, incidental or consequential damages.



Customer Support

1-888-921-4088

(Monday-Friday, 9AM-5PM EST)

Visit <https://www.jensenmobile.com>

Designed and Engineered in USA

JENSEN[®]

Namsung America Inc.
©2021 Namsung America Inc.
All rights reserved.

All rights reserved. No part of this publication may be reproduced, distributed, or transmitted in any form or by any means, including photocopying, recording, or other electronic or mechanical methods, without the prior written permission of NAMSUNG AMERICA INC.

NSC0521-V01